

JVC

DIGITAL VIDEO CAMERA

GR-D50

GR-D40

GR-D30

GR-D20

Please visit our Homepage on the World Wide Web for Digital Video Camera:

<http://www.jvc-victor.co.jp/english/cyber/>

For Accessories:

<http://www.jvc-victor.co.jp/english/accessory/>

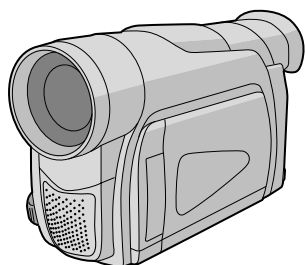

Mini **DV** PAL

INSTRUCTIONS

ENGLISH

CONTENTS

AUTOMATIC
DEMONSTRATION 6

GETTING STARTED 7 - 10

TAPE
RECORDING &
PLAYBACK 11 - 15

ADVANCED
FEATURES 16 - 33

REFERENCES 34 - 47

LYT1098-001A

EN

CONTENTS

SAFETY PRECAUTIONS	3
SOME DO'S AND DON'TS ON THE SAFE USE OF EQUIPMENT	4
PROVIDED ACCESSORIES	5
HOW TO ATTACH THE LENS CAP	5
HOW TO ATTACH THE CORE FILTER	6
AUTOMATIC DEMONSTRATION	6

GETTING STARTED

Power	7 – 8
Grip Adjustment	8
Viewfinder Adjustment	8
Shoulder Strap Attachment	9
Tripod Mounting	9
Loading/Unloading A Cassette	9 – 10
Date/Time Settings	10
Recording Mode Setting	10

TAPE RECORDING & PLAYBACK

TAPE RECORDING	11 – 13
Basic Recording	11 – 12
Zooming	12
Time Code	13
TAPE PLAYBACK	13 – 15
Normal Playback	13 – 14
Blank Search	14
Connections	15

ADVANCED FEATURES

FOR RECORDING	16 – 20
Night-Scope	16
Programme AE With Special Effects	16
Fade/Wipe Effects	17

Snapshot (For Tape Recording)	18
Auto Focus	18
Manual Focus	19
Exposure Control	19
Iris Lock	20
White Balance Adjustment	20
Manual White Balance Operation	20
USING MENUS FOR DETAILED ADJUSTMENT	21 – 25
For Recording Menu	21 – 24
For Playback Menu	24 – 25
DUBBING	26 – 27
Dubbing To Or From A VCR	26
Dubbing To Or From A Video Unit Equipped With A DV Connector (Digital Dubbing)	27
USING THE REMOTE CONTROL UNIT	28 – 32
Slow-Motion Playback	28
Frame-By-Frame Playback	28
Playback Special Effects	28
Playback Zoom	28
Audio Dubbing	29
Insert Editing	29
Random Assemble Editing [R.A.Edit]	30 – 32
For More Accurate Editing	32
SYSTEM CONNECTIONS	33
Connection To A Personal Computer	33

REFERENCES

TROUBLESHOOTING	34 – 36
CAUTIONS	37 – 38
SPECIFICATIONS	39
INDEX	40 – 45
Controls, Connectors And Indicators	40 – 41
Indications	42 – 44
Using The Optional RM-V717U Remote Control Unit	45
TERMS	46 – 47

Refer to the diagrams on page 40 and 42 while reading the instruction manual as all the controls, connectors, indicators and indications are numbered on the diagrams and those corresponding numbers are used throughout this manual unless specified.

Dear Customer,

Thank you for purchasing this digital video camera. Before use, please read the safety information and precautions (☞ pgs. 3 and 4) to ensure safe use of this product.

SAFETY PRECAUTIONS

WARNING:

TO PREVENT FIRE OR SHOCK HAZARD, DO NOT EXPOSE THIS UNIT TO RAIN OR MOISTURE.

CAUTIONS:

- To prevent shock, do not open the cabinet. No user serviceable parts inside. Refer servicing to qualified personnel.
- When you are not using the AC Adapter for a long period of time, it is recommended that you disconnect the power cord from AC outlet.

NOTES:

- The rating plate (serial number plate) and safety caution are on the bottom and/or the back of the main unit.
- The rating information and safety caution of the AC Adapter are on its upper and lower sides.

CAUTION:

To avoid electric shock or damage to the unit, first firmly insert the small end of the power cord into the AC Adapter until it is no longer wobbly, and then plug the larger end of the power cord into an AC outlet.

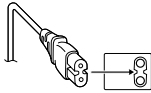

IMPORTANT

Connection to the mains supply in the United Kingdom.

DO NOT cut off the mains plug from this equipment.

If the plug fitted is not suitable for the power points in your home or the cable is too short to reach a power point, then obtain an appropriate safety approved extension lead or consult your dealer.

BE SURE to replace the fuse only with an identical approved type, as originally fitted, and to replace the fuse cover.

If nonetheless the mains plug is cut off be sure to remove the fuse and dispose of the plug immediately, to avoid possible shock hazard by inadvertent connection to the mains supply.

If this product is not supplied fitted with a mains plug then follow the instructions given below:

DO NOT make any connection to the Larger Terminal coded E or Green.

The wires in the mains lead are coloured in accordance with the following code:



If these colours do not correspond with the terminal identifications of your plug, connect as follows:
Blue wire to terminal coded N (Neutral) or coloured black.
Brown wire to terminal coded L (Live) or coloured Red.
If in doubt — consult a competent electrician.

Caution on Replaceable lithium battery

The battery used in this device may present a fire or chemical burn hazard if mistreated.

Do not recharge, disassemble, heat above 100°C or incinerate.

Replace battery with Panasonic (Matsushita Electric), Sanyo, Sony or Maxell CR2025.

Danger of explosion or Risk of fire if the battery is incorrectly replaced.

- Dispose of used battery promptly.
- Keep away from children.
- Do not disassemble and do not dispose of in fire.

CAUTIONS:

- This camcorder is designed to be used with PAL-type colour television signals. It cannot be used for playback with a television of a different standard. However, live recording and LCD monitor/viewfinder playback are possible anywhere.
- Use the JVC BN-V408U/V416U/V428U battery packs and, to recharge them or to supply power to the camcorder from an AC outlet, use the provided multi-voltage AC Adapter and Power Cord. (An appropriate conversion adapter may be necessary to accommodate different designs of AC outlets in different countries.)

When the equipment is installed in a cabinet or on a shelf, make sure that it has sufficient space on all sides to allow for ventilation (10 cm or more on both sides, on top and at the rear).

Do not block the ventilation holes.

(If the ventilation holes are blocked by a newspaper, or cloth etc. the heat may not be able to get out.)

No naked flame sources, such as lighted candles, should be placed on the apparatus.

When discarding batteries, environmental problems must be considered and the local rules or laws governing the disposal of these batteries must be followed strictly.

The apparatus shall not be exposed to dripping or splashing.

Do not use this equipment in a bathroom or places with water.

Also do not place any containers filled with water or liquids (such as cosmetics or medicines, flower vases, potted plants, cups etc.) on top of this unit.

(If water or liquid is allowed to enter this equipment, fire or electric shock may be caused.)

Do not point the lens or the viewfinder directly into the sun. This can cause eye injuries, as well as lead to the malfunctioning of internal circuitry. There is also a risk of fire or electric shock.

CAUTION!

The following notes concern possible physical damage to the camcorder and to the user.

When carrying, be sure to always securely attach and use the provided shoulder strap. Carrying or holding the camcorder by the viewfinder and/or the LCD monitor can result in dropping the unit, or in a malfunction.

Take care not to get your finger caught in the cassette holder cover. Do not let children operate the camcorder, as they are particularly susceptible to this type of injury.

Do not use a tripod on unsteady or unlevel surfaces. It could tip over, causing serious damage to the camcorder.

CAUTION!

Connecting cables (Audio/Video, S-Video, etc.) to the camcorder and leaving the unit on top of the TV is not recommended, as tripping on the cables will cause the camcorder to fall, resulting in damage.

SOME DO'S AND DON'TS ON THE SAFE USE OF EQUIPMENT

This equipment has been designed and manufactured to meet international safety standards but, like any electrical equipment, care must be taken if you are to obtain the best results and safety is to be assured.

- DO** read the operating instructions before you attempt to use the equipment.
 - DO** ensure that all electrical connections (including the mains plug, extension leads and interconnections between pieces of equipment) are properly made and in accordance with the manufacturer's instructions. Switch off and withdraw the mains plug when making or changing connections.
 - DO** consult your dealer if you are ever in doubt about the installation, operation or safety of your equipment.
 - DO** be careful with glass panels or doors on equipment.
 - DON'T** continue to operate the equipment if you are in any doubt about it working normally, or if it is damaged in any way — switch off, withdraw the mains plug and consult your dealer.
 - DON'T** remove any fixed cover as this may expose dangerous voltages.
 - DON'T** leave equipment switched on when it is unattended unless it is specifically stated that it is designed for unattended operation or has a standby mode. Switch off using the switch on the equipment and make sure that your family knows how to do this. Special arrangements may need to be made for infirm or handicapped people.
 - DON'T** use equipment such as personal stereos or radios so that you are distracted from the requirements of road safety. It is illegal to watch television whilst driving.
 - DON'T** listen to headphones at high volume, as such use can permanently damage your hearing.
 - DON'T** obstruct the ventilation of the equipment, for example with curtains or soft furnishings. Overheating will cause damage and shorten the life of the equipment.
 - DON'T** use makeshift stands and NEVER fix legs with wood screws — to ensure complete safety always fit the manufacturer's approved stand or legs with the fixings provided according to the instructions.
 - DON'T** allow electrical equipment to be exposed to rain or moisture.
- ABOVE ALL**
- NEVER let anyone especially children push anything into holes, slots or any other opening in the case — this could result in a fatal electrical shock;
 - NEVER guess or take chances with electrical equipment of any kind — it is better to be safe than sorry!

Mini **DV** PAL

- This camcorder is designed exclusively for the Mini digital video cassette. Only cassettes marked "Mini **DV**" can be used with this unit.

Before recording an important scene . . .

- make sure you only use cassettes with the Mini DV mark **DV**.
- remember that this camcorder is not compatible with other digital video formats.
- remember that this camcorder is intended for private consumer use only. Any commercial use without proper permission is prohibited. (Even if you record an event such as a show, performance or exhibition for personal enjoyment, it is strongly recommended that you obtain permission beforehand.)

PROVIDED ACCESSORIES

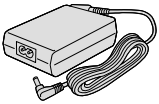

or

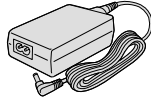

AC Adapter AP-V11E or AP-V13E

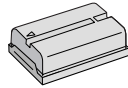

Battery Pack BN-V408U



Audio/Video Cable
(ø3.5 mini-plug to
RCA plug)

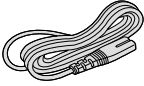

Power Cord

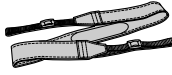

Shoulder Strap

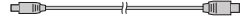

USB Cable
(GR-D50/D40 only)



Lithium Battery*
CR2025
(for remote
control unit)

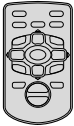

Remote
Control Unit*
RM-V718U

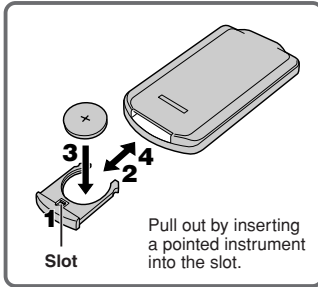

Lens Cap
(See below for
attachment)



Core Filter x 2 (for
optional S-Video Cable
and Editing Cable
provided with Remote
Control kit RM-V717KITU
pg. 6 for attachment)



CD-ROM
(GR-D50/D40 only)



Cable Adapter

* A battery is pre-installed in the Remote Control Unit a time of shipment (with insulation sheet). To use the Remote Control Unit, remove the insulation sheet.

NOTE:

In order to maintain optimum performance of the camcorder, provided cables may be equipped with one or more core filter. If a cable has only one core filter, the end that is closest to the filter should be connected to the camcorder.

HOW TO ATTACH THE LENS CAP

To protect the lens, attach the provided lens cap to the camcorder as shown in the illustration.

NOTE:

To confirm the lens cap is on correctly make sure the cap is flush to the camera.

- 1** Make sure the arrow (▲) is pointing upward.

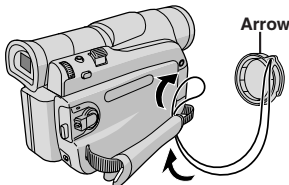

- 2**

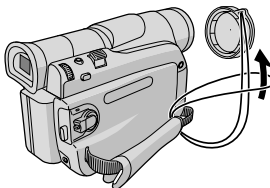

- 3**

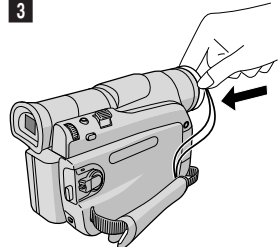

HOW TO ATTACH THE CORE FILTER

Attach the Core Filter(s) (if provided with your model  pg. 5) to an optional cable(s). The Core Filter reduces interference.



Release the stoppers on both ends of the Core Filter.

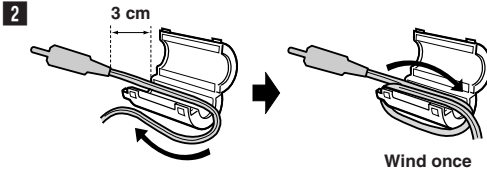

Run the cable through the Core Filter, leaving approx. 3 cm of cable between the cable plug and the Core Filter. Wind the cable once around the outside of the Core Filter as shown in the illustration.

- Wind the cable so that it is not slack.

NOTE:

Take care not to damage the cable.

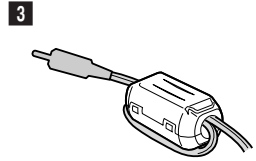













Close the Core Filter until it clicks shut.

- When connecting cables, attach the end with the Core Filter to the camcorder.
- Be sure to use a cable with a thickness that will allow it to be wound around the core filter.

AUTOMATIC DEMONSTRATION

Automatic Demonstration takes place when “DEMO MODE” is set to “ON” (factory-preset).

- Automatic Demonstration starts when there is no operation for about 3 minutes after the Power Switch  is set to “” or “” and no cassette is in the camcorder.
- Performing any operation during the demonstration stops the demonstration temporarily. If no operation is performed for more than 3 minutes after that, the demonstration will resume.
- “DEMO MODE” remains “ON” even if the camcorder power is turned off.
- To cancel Automatic Demonstration:
 1. Set the Power Switch  to “” while pressing down the Lock Button  located on the switch and press the **MENU/VOLUME** wheel  in. The Menu Screen appears.
 2. Rotate the **MENU/VOLUME** wheel  to select “ (SYSTEM)” and press it.
 3. Rotate the **MENU/VOLUME** wheel  to select “DEMO MODE” and press it. The Sub Menu appears.
 4. Rotate the **MENU/VOLUME** wheel  to select “OFF” and press it.
 5. Rotate the **MENU/VOLUME** wheel  to select “ RETURN”, and press it twice. The normal screen appears.

NOTE:

If you do not detach the Lens Cap, you cannot see the actual changes of the Automatic Demonstration activated on the LCD monitor or viewfinder.

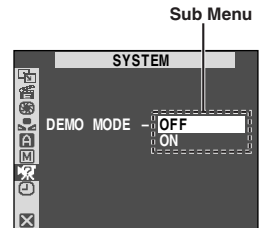
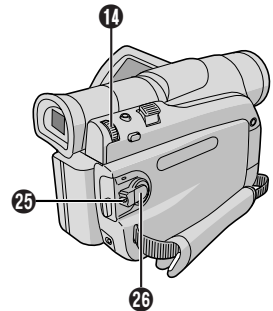

CHARGING THE BATTERY PACK

1 With the arrow on the battery pack pointing upward, push the battery pack slightly against the battery pack mount 12, then slide up the battery pack until it locks in place.

2 Set the Power Switch 26 to "OFF (CHARGE)". Connect the AC Adapter to the camcorder, then connect the Power Cord to the AC Adapter.

3 Plug the Power Cord into an AC outlet. The POWER/CHARGE lamp 24 on the camcorder blinks to indicate charging has started.

4 When the POWER/CHARGE lamp 24 goes off, charging is finished. Unplug the Power Cord from the AC outlet. Disconnect the AC Adapter from the camcorder.

To Detach The Battery Pack:

Slide the battery pack down slightly while sliding down BATT. RELEASE 30 to detach it.

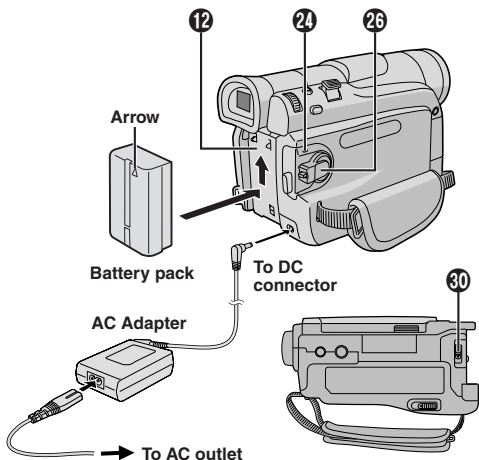

ATTENTION

Before detaching the power source, make sure that the camcorder's power is turned off. Failure to do so can result in a camcorder malfunction.

INFORMATION

The extended-use battery pack kit is a set composed of a battery pack and AC Power Adapter/Charger:

VU-V840 KIT : BN-V840U battery pack & AA-V15EK AC Power Adapter/Charger

VU-V856 KIT : BN-V856U battery pack & AA-V80EK AC Power Adapter/Charger

Read the kit's instruction manual before using. Also, by using the optional JVC VC-VBN856U DC Cord, it will be possible to connect BN-V840U or BN-V856U battery packs to the camcorder and supply power directly to the camcorder.

NOTES:

- If the protective cap is attached to the battery pack, remove it first.
- During charging, the camcorder cannot be operated.
- Charging is not possible if the wrong type of battery is used.
- When charging the battery pack for the first time or after a long storage period, the POWER/CHARGE lamp 24 may not light. Remove the battery pack from the camcorder, then try charging again.
- If a fully-charged battery's operation time remains extremely short, the battery is worn out. Please purchase a new one.
- Recording time is reduced significantly when Zoom or Record-Standby mode is engaged repeatedly or the LCD monitor is used repeatedly.
- Before extended use, it is recommended that you prepare enough battery packs to cover 3 times the planned shooting time.

Continued on next page.

Battery pack	Charging time
BN-V408U	approx. 1 hr. 30 min.
BN-V416U (optional)	approx. 3 hrs.
BN-V428U (optional)	approx. 5 hrs.

Charging times are for a fully discharged battery pack.

USING THE BATTERY PACK

Perform step 1 of "CHARGING THE BATTERY PACK".

Approximate recording time

Battery pack	LCD monitor on	Viewfinder on
BN-V408U	1 hr. 10 min.	1 hr. 40 min.
BN-V416U (optional)	2 hrs. 30 min.	3 hrs. 30 min.
BN-V428U (optional)	4 hrs. 20 min.	6 hrs. 20 min.
BN-V840U (optional)	5 hrs. 20 min.	7 hrs. 30 min.
BN-V856U (optional)	8 hrs. 10 min.	11 hrs. 10 min.

USING AC POWER

Connect the AC Adapter to the camcorder as shown in the following illustration.

- The provided AC Adapter features automatic voltage selection in the AC range from 110 V to 240 V.

- Since the AC Adapter processes electricity internally, it becomes warm during use. Be sure to use it only in well-ventilated areas.
- The following operation stops charging:
 - Set the Power Switch 26 to "PLAY", "A" or "M".
 - Disconnect the AC Adapter from the camcorder.
 - Unplug the AC Adapter from the AC outlet.
 - Detach the battery from the camcorder.
- This camcorder will be automatically turned off if its power is supplied from the AC adapter and about 5 minutes pass since it has entered into the recording standby mode with a cassette inserted. If, under those conditions, the battery is attached to the camcorder, its charging will start.
- Using the optional AA-V40EK AC Power Adapter/Charger, you can charge the BN-V408U/V416U/V428U battery pack without the camcorder. However, it cannot be used as an AC adapter.
- To avoid interference with reception, do not use the AC Adapter near a radio.
- Perform charging where the temperature is between 10°C and 35°C. 20°C to 25°C is the ideal temperature range for charging. If the environment is too cold, charging may be incomplete.
- Charging time varies according to the ambient temperature and the status of the battery pack.

About Batteries

DANGER! Do not attempt to take the batteries apart, or expose them to flame or excessive heat, as it may cause a fire or explosion.

WARNING! Do not allow the battery or its terminals to come in contact with metals, as this can result in a short circuit and possibly start a fire.

The Benefits Of Lithium-Ion Batteries

Lithium-ion battery packs are small but have a large power capacity. However, when one is exposed to cold temperatures (below 10°C), its usage time becomes shorter and it may cease to function. If this happens, place the battery pack in your pocket or other warm, protected place for a short time, then re-attach it to the camcorder. As long as the battery pack itself is not cold, it should not affect performance.

(If you're using a heating pad, make sure the battery pack does not come in direct contact with it.)

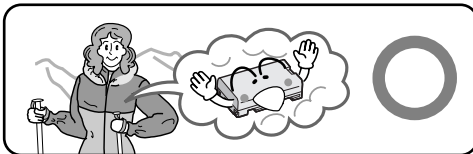

Lithium-ion is vulnerable in colder temperatures.

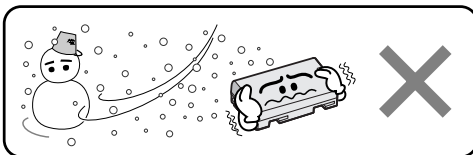

Grip Adjustment

- 1 Separate the Velcro strip.
- 2 Pass your right hand through the loop and grasp the grip.
- 3 Adjust your thumb and fingers through the grip, to easily operate the Recording Start/Stop button 22 and Power Switch 26 and Power Zoom Lever 16. Be sure to fasten the Velcro strip to your preference.

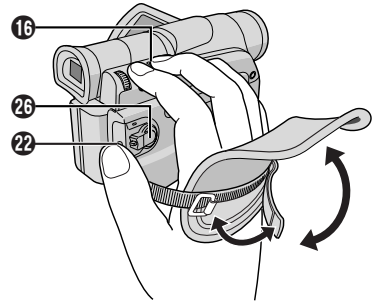

Viewfinder Adjustment

- 1 Set the Power Switch 26 to "A" or "M" while pressing down the Lock Button 25 located on the switch.
- 2 Pull out the viewfinder fully and adjust it manually for best viewability.
- 3 Turn the Dioptre Adjustment Control 21 until the indications in the viewfinder are clearly focused.

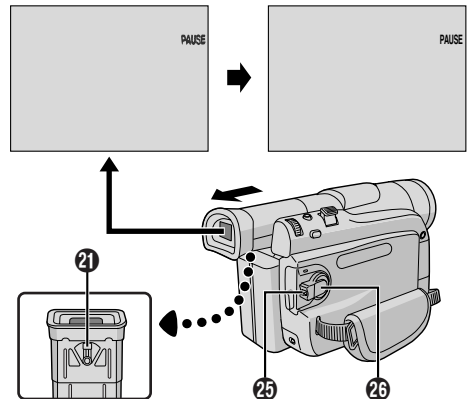

Shoulder Strap Attachment

1 Thread the strap through the eyelet **29**, then fold it back and thread it through the buckle. Repeat the procedure to attach the other end of the strap to the other eyelet **28** located under the Grip Strap. Confirm the strap is not twisted.

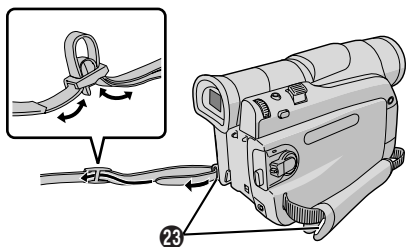

Tripod Mounting

CAUTION

When attaching the camcorder to a tripod, extend its legs to stabilise the camcorder. It is not advised to use small sized tripods. This may cause damage to the unit by falling over.

1 To attach the camcorder to a tripod, align the direction stud and screw to the stud hole **27** and mounting socket **28** on the camcorder. Then tighten the screw clockwise. Some tripods are not equipped with studs.

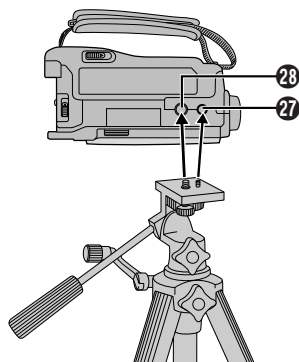

Loading/Unloading A Cassette

The camcorder needs to be powered up to load or eject a cassette.

1 Slide and hold **OPEN/EJECT** **31** in the direction of the arrow then pull the cassette holder cover open until it locks. The cassette holder opens automatically.

- Do not touch internal components.
- 2** Insert or remove a tape and press "PUSH HERE" to close the cassette holder.
- Once the cassette holder is closed, it recedes automatically. Wait until it recedes completely before closing the cassette holder cover.
- When the battery's charge is low, you may not be able to close the cassette holder cover. Do not apply force. Replace the battery with a fully charged one before continuing.

3 Close the cassette holder cover firmly until it locks into place.

To Protect Valuable Recordings:

Slide the erase protection tab on the back of the tape in the direction of "SAVE". This prevents the tape from being recorded over. To record on this tape, slide the tab back to "REC" before loading it.

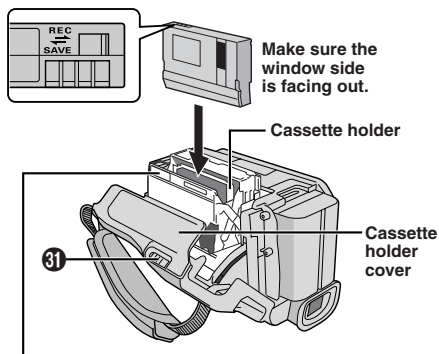

Be sure to press only the section labeled "PUSH HERE" to close the cassette holder; touching other parts may cause your finger to get caught in the cassette holder, resulting in injury or product damage.

Approximate recording time

Tape	Recording mode	
	SP	LP
30 min.	30 min.	45 min.
60 min.	60 min.	90 min.
80 min.	80 min.	120 min.

NOTES:

- The cassette holder cannot be opened unless a power supply is attached.

Continued on next page.

- It takes a few seconds for the cassette holder to open. Do not apply force.
- There may be a delay after you open the cassette holder cover until the cassette holder opens. Do not use force.
- If you wait a few seconds and the cassette holder does not open, close the cassette holder cover and try again. If the cassette holder still does not open, turn the camcorder off then on again.
- If the tape does not load properly, open the cassette holder cover fully and remove the cassette. A few minutes later, insert it again.
- When the camcorder is suddenly moved from a cold place to a warm environment, wait a short time before opening the cassette holder cover.
- Once the cassette holder is closed, it recedes automatically. Wait until it recedes completely before closing the cassette holder cover.
- Closing the cassette holder cover before the cassette holder comes out may cause damage to the camcorder.
- Even when the camcorder is switched off, a cassette can be loaded or unloaded. After the cassette holder is closed with the camcorder switched off, however, it may not recede. It is recommended to turn the power on before loading or unloading.
- When resuming recording, once you open the cassette holder cover a blank portion will be recorded on the tape or a previously recorded scene will be erased (recorded over) regardless of whether the cassette holder came out or not. See page 13 for information about recording from the middle of a tape.

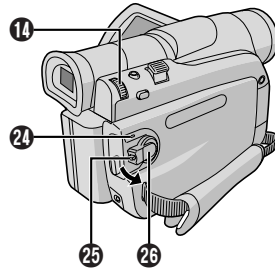
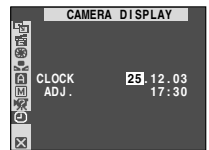
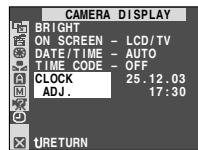

Date/Time Settings

The date/time is recorded onto the tape at all times, but its display can be turned on or off during playback (see pg. 24).

- 1 Set the Power Switch **26** to “**M**” while pressing down the Lock Button **25** located on the switch, and open the LCD monitor fully or pull out the viewfinder fully. The POWER/CHARGE lamp **24** lights and the camcorder is turned on.
- 2 Press the **MENU/VOLUME** wheel **14** in to access the Menu Screen.
- 3 Rotate the **MENU/VOLUME** wheel **14** to select “**C** (CAMERA DISPLAY)” and press it.
- 4 Rotate the **MENU/VOLUME** wheel **14** to select “**CLOCK ADJ.**”. Press it and “day” is highlighted. Rotate the **MENU/VOLUME** wheel **14** to input the day. Press it. Repeat to input the month, year, hour and minute. Rotate the **MENU/VOLUME** wheel **14** to select “**RETURN**”, and press it twice. The Menu Screen closes.

NOTE:

Even if you select “**CLOCK ADJ.**”, if the parameter is not highlighted the camcorder’s internal clock continues to operate. Once you move the highlight bar to the first date/time parameter (day), the clock stops. When you finish setting the minute and press the **MENU/VOLUME** wheel **14** in, the date and time begin operation from the date and time you just set.

Recording Mode Setting

Set the tape recording mode depending on your preference.

- 1 Set the Power Switch **26** to “**M**” while pressing down the Lock Button **25** located on the switch, and open the LCD monitor fully or pull out the viewfinder fully. The POWER/CHARGE lamp **24** lights and the camcorder is turned on.
 - 2 Press the **MENU/VOLUME** wheel **14** in. The Menu Screen appears.
 - 3 Rotate the **MENU/VOLUME** wheel **14** to select “**A** (CAMERA)” and press it.
 - 4 Rotate the **MENU/VOLUME** wheel **14** to select “**REC MODE**” and press it. The Sub Menu appears. Select “**SP**” or “**LP**” by rotating the **MENU/VOLUME** wheel **14** and press it. Rotate the **MENU/VOLUME** wheel **14** to select “**RETURN**”, and press it twice. The Menu Screen closes.
- Audio Dubbing and Insert Editing (see pg. 29) are possible on tapes recorded in the SP mode.
 - “**LP**” (Long Play) is more economical, providing 1.5 times the recording time.

NOTES:

- If the recording mode is switched during recording, the playback picture will be blurred at the switching point.
- It is recommended that tapes recorded in the LP mode on this camcorder be played back on this camcorder.
- During playback of a tape recorded on another camcorder, blocks of noise may appear or there may be momentary pauses in the sound.

Basic Recording

Perform the procedures listed below before continuing.

- Power (☞ pg. 7)
- Grip Adjustment (☞ pg. 8)
- Viewfinder Adjustment (☞ pg. 8)
- Load A Cassette (☞ pg. 9)
- Recording Mode Setting (☞ pg. 10)

1 Remove the lens cap.
Pull on bottom end 23 of LCD monitor to open.

2 Set the Power Switch 26 to "A" or "M" while pressing down the Lock Button 25 located on the switch.

Shooting while using the LCD monitor: Open the LCD monitor fully.

Shooting while using the viewfinder: Pull out the viewfinder fully.

- The POWER/CHARGE lamp 24 lights and the camcorder enters the Record-Standby mode. "PAUSE" 16 is displayed.
- The image will not appear simultaneously on the LCD monitor and the viewfinder. See "PRIORITY" in the SYSTEM Menu (☞ pg. 23).

3 Press the Recording Start/Stop Button 22. "REC" 15, 16 appears and the tally lamp 3 lights while recording is in progress.

- To Stop Recording, press the Recording Start/Stop Button 22. The camcorder re-enters the Record-Standby mode.

To Adjust The Brightness Of The Display

1. Make sure the Power Switch 26 is set to "M" and open the LCD monitor fully, then press the MENU/VOLUME wheel 11 in. The Menu Screen appears.
2. Rotate the MENU/VOLUME wheel 11 to select "CAMERA DISPLAY" and press it.
3. Rotate the MENU/VOLUME wheel 11 to select "BRIGHT" and press it. The Menu Screen closes and the bright level indicator 7 appears on the display.
 - To cancel, press the MENU/VOLUME wheel 11 again so that the bright level indicator 7 disappears.
4. Rotate the MENU/VOLUME wheel 11 until the bright level indicator 7 moves and the appropriate brightness is reached, then press it. The bright level indicator 7 disappears.
 - It is also possible to adjust the brightness of the viewfinder by closing the LCD monitor, pulling out the viewfinder and adjusting as described above.

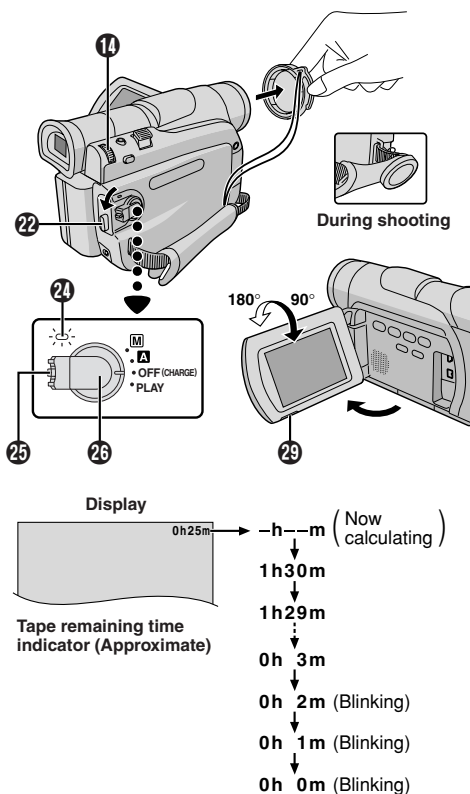

NOTES:

- If the Record-Standby mode continues for 5 minutes, the camcorder's power shuts off automatically. To turn the camcorder on again, push back and pull out the viewfinder again or close and re-open the LCD monitor.
- When a blank portion is left between recorded scenes on the tape, the time code is interrupted and errors may occur when editing the tape. To avoid this, refer to "RECORDING FROM THE MIDDLE OF A TAPE" (☞ pg. 13).
- To turn the tally lamp 3 or beep sounds off, ☞ pg. 23.
- When you use the LCD monitor outdoors in direct sunlight, the LCD monitor may be difficult to see. If this happens, use the viewfinder instead.
- Black spots or bright spots of light (red, green or blue) may appear constantly on the LCD monitor or the viewfinder (☞ pg. 35).
- When the Recording Start/Stop button 22 is pressed, it may take a few seconds before actual recording starts. "REC" 15 starts rotating when the camcorder actually starts recording.
- The time required to calculate and display the remaining tape length, and the accuracy of the calculation, may vary according to the type of tape used.
- "TAPE END" appears when the tape reaches its end, and the power goes off automatically if left in this condition for 5 minutes. "TAPE END" also appears when a cassette at its end is loaded.

Journalistic Shooting

In some situations, different shooting angles may provide more dramatic results. Hold the camcorder in the desired position and tilt the LCD monitor in the most convenient direction. It can rotate 270° (90° downward, 180° upward).

Self-Recording

You can shoot yourself while viewing your own image in the LCD monitor. Open the LCD monitor and tilt it upward 180° so that it faces forward, then point the lens toward yourself and start recording.

Operation Mode

Choose the appropriate operation mode according to your preference using the Power Switch **26**.

Power Switch Position
M : Allows you to set various recording functions using the Menus. If you want more creative capabilities than Full Auto recording, try this mode.
A (Full Auto) : Allows you to record using NO special effects or manual adjustments. Suitable for standard recording.
OFF (CHARGE) : Allows you to switch off the camcorder.
PLAY : <ul style="list-style-type: none">• Allows you to play back a recording on the tape.• Allows you to transfer still/moving images recorded on the tape to a computer (GR-D50/D40 only).

Power-Linked Operation

When the Power Switch **26** is set to “**A**” or “**M**”, you can also turn on/off the camcorder by opening/closing the LCD monitor or pulling out/pushing in the viewfinder.

Zooming

To produce the zoom in/out effect, or an instantaneous change in image magnification.

Zoom In

Slide the Power Zoom Lever **16** towards “T”.

Zoom Out

Slide the Power Zoom Lever **16** towards “W”.

- The further you slide the Power Zoom Lever **16**, the quicker the zoom action.

NOTES:

- Focusing may become unstable during Zooming. In this case, set the zoom while in Record-Standby, lock the focus by using the manual focus (ⓘ pg. 19), then zoom in or out in Record mode.
- Zooming is possible to a maximum of 700X, or it can be switched to 16X magnification using the optical zoom (ⓘ pg. 21).
- Zoom magnification of over 16X is done through Digital image processing, and is therefore called Digital Zoom.
- During Digital zoom, the quality of image may suffer.
- Macro shooting (as close as approx. 5 cm to the subject) is possible when the Power Zoom Lever **16** is set all the way to “W”. Also see “TELE MACRO” in the Menu Screen on page 22.

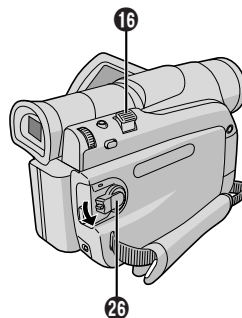

Time Code

During recording, a time code is recorded on the tape. This code is to confirm the location of the recorded scene on the tape during playback. If recording starts from a blank portion, the time code begins counting from "00:00:00" (minute:second:frame). If recording starts from the end of a previously recorded scene, the time code continues from the last time code number.

To perform Random Assemble Editing (☞ pg. 30 – 32), time code is necessary. If during recording a blank portion is left partway through the tape, the time code is interrupted. When recording is resumed, the time code starts counting up again from "00:00:00". This means the camcorder may record the same time codes as those existing in a previously recorded scene. To prevent this, perform "RECORDING FROM THE MIDDLE OF A TAPE" in the following cases;

- When shooting again after playing back a recorded tape.
- When power shuts off during shooting.
- When a tape is removed and re-inserted during shooting.
- When shooting using a partially recorded tape.
- When shooting on a blank portion located partway through the tape.
- When shooting again after shooting a scene then opening/closing the cassette holder cover.

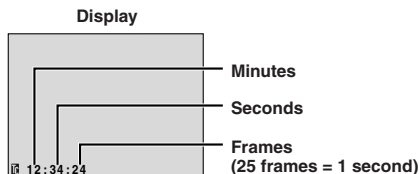

Frames are not displayed during recording.

RECORDING FROM THE MIDDLE OF A TAPE

1 Play back a tape or use Blank Search (☞ pg. 14) to find the spot at which you want to start recording, then engage the Still Playback mode (☞ pg. 13, "Normal Playback").

2 Set the Power Switch **26** to "A" or "M" while pressing down the Lock Button **25** located on the switch, then start recording.

NOTES:

- The time code cannot be reset.
- During fast-forwarding and rewinding, the time code indication does not move smoothly.
- The time code is displayed only when "TIME CODE" is set to "ON" (☞ pg. 24).

Normal Playback

1 Load a tape (☞ pg. 9).

2 Set the Power Switch **26** to "PLAY" while pressing down the Lock Button **25** located on the switch. To start playback, press **▶/II 6**.

- To stop playback temporarily (Still Playback), press **▶/II 6**.
- To stop playback, press **■ 4**.
- Press **◀ 5** to rewind, or **▶ 7** to fast-forward the tape during Stop mode.
- High-speed picture search (Shuttle Search) is possible by pressing **◀ 5** or **▶ 7** during playback (holding **◀ 5** or **▶ 7** down during playback continues search until released).
- Press the Zoom Button **T 49** on the remote control to zoom in (up to 44X), or **W 60** to zoom out. You can also magnify a particular part of an image (☞ pg. 28).
- At any time, pressing **▶/II 6** resumes normal playback.

Slow-Motion Playback/Playback Special Effects/ Playback Zoom:

Available only with the remote control (☞ pg. 28)

To Control The Speaker Volume:

Rotate the **MENU/VOLUME** wheel **14** so that the volume level indicator **29** on the display moves to obtain the appropriate volume.

ATTENTION

During Shuttle Search, parts of the picture may not be clearly visible, particularly on the left side of the screen.

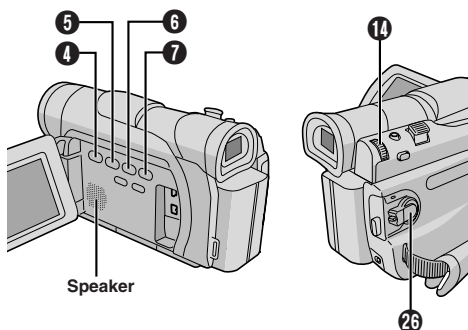

Continued on next page.

NOTES:

- If Stop mode continues for 5 minutes when power is supplied from a battery, the camcorder shuts off automatically. To turn on again, set the Power Switch 25 to "OFF (CHARGE)", then to "PLAY".
- The playback picture can be viewed in the LCD monitor, viewfinder or on a connected TV (pg. 15).
- You can also view the playback picture on the LCD monitor with it flipped over and pushed against the camera body.
- LCD monitor/viewfinder indications:
When power is supplied from a battery: the " " battery pack remaining power indicator is displayed.
When power is supplied from an AC outlet: " " does not appear.
- When a cable is connected to the AV connector, the sound is not heard from the speaker.
- If still playback continues for more than about 3 minutes, the camcorder's Stop mode is automatically engaged.
- When ►/II 6 is pressed to engage still playback, the image may not pause immediately while the camcorder stabilises the still image.

Blank Search

Helps you find where you should start recording in the middle of a tape to avoid time code interruption (pg. 13).

1 Load a tape (pg. 9).

2 Set the Power Switch 25 to "PLAY" while pressing down the Lock Button 26 located on the switch.

3 Press **BLANK SEARCH** 17.

- "BLANK SEARCH" 24 appears and the camcorder automatically starts reverse or forward shuttle search, then stops at the spot which is about 3 seconds of tape before the beginning of the detected blank portion.

To cancel Blank Search midway . . .

..... press ■ 1.

NOTES:

- In step 3, if the current position is at a blank portion the camcorder searches in the reverse direction, and if the current position is at a recorded portion the camcorder searches in the forward direction.
- Blank Search does not work if "HEAD CLEANING REQUIRED. USE CLEANING CASSETTE" has appeared with the tape.
- If the beginning or end of the tape is reached during Blank Search, the camcorder stops automatically.
- A blank portion which is shorter than 5 seconds of tape may not be detected.
- The detected blank portion may be located between recorded scenes. Before you start recording, make sure there is no recorded scene after the blank portion.

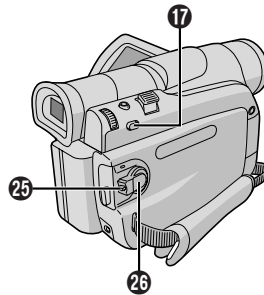

Connections

- 1** Make sure all units are turned off.
 - 2** Connect the camcorder to a TV or VCR as shown in the illustration.
- If using a VCR . . . go to step 3.**
If not . . . go to step 4.
- 3** Connect the VCR output to the TV input, referring to your VCR's instruction manual.
 - 4** Turn on the camcorder, the VCR and the TV.
 - 5** Set the VCR to its AUX input mode, and set the TV to its VIDEO mode.
- To choose whether or not the following displays appear on the connected TV . . .**
- Date/Time
 set "DATE/TIME" to "AUTO", "ON" or "OFF" in the Menu Screen (☞ pg. 23, 25).
 Or, press **DISPLAY** (Ⓛ) on the remote control to turn on/off the date indication.
 - Time Code
 set "TIME CODE" to "ON" or "OFF" in the Menu Screen (☞ pg. 24, 25).
 - Indications other than date/time and time code
 set "ON SCREEN" to "LCD", "LCD/TV" or "OFF" in the Menu Screen (☞ pg. 23, 25).

NOTES:

- It is recommended to use the AC Adapter as the power supply instead of the battery pack (☞ pg. 7).
- Set the video out select switch of the cable adapter as required:
 - Y/C : When connecting to a TV or VCR which accepts Y/C signals and uses an S-Video cable.
 - CVBS : When connecting to a TV or VCR which does not accept Y/C signals and uses an audio/video cable.
- To monitor the picture and sound from the camcorder without inserting a tape, set the camcorder's Power Switch (Ⓛ) to "A" or "M", then set your TV to the appropriate input mode.
- Make sure you adjust the TV sound volume to its minimum level to avoid a sudden burst of sound when the camcorder is turned on.
- If you have a TV or speakers that are not specially shielded, do not place the speakers adjacent to the TV as interference will occur in the camcorder playback picture.
- If no image is displayed or no sound is heard from the TV, set "S/AV INPUT" to "OFF" in the Menu Screen (GR-D50/D30 only, ☞ pg. 24).
- While the Audio/Video cable is connected to the AV connector, sound cannot be heard from the speaker.

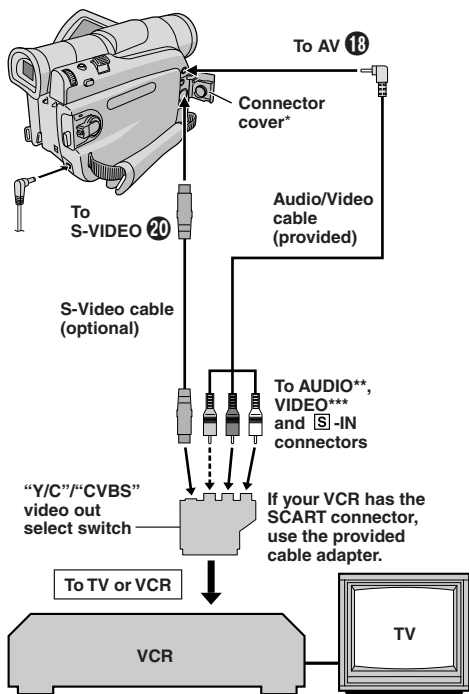

* When connecting the cables, open this cover.

** The Audio cable is not required for watching still images only.

*** Connect when an S-Video cable is not used.

Night-Scope

Makes dark subjects or areas even brighter than they would be under good natural lighting. Although the recorded image is not grainy, it may look as if it is strobing due to the slow shutter speed.

1 Set the Power Switch **Ⓟ** to “**M**” while pressing down the Lock Button **Ⓛ** located on the switch. Open the LCD monitor fully or pull out the viewfinder fully.

2 Press **NIGHT** **Ⓝ** so that the Night-Scope indicator “**Ⓝ**” **2** appears.

- The shutter speed is automatically adjusted to provide up to 30 times sensitivity.
- “**A**” appears beside “**Ⓝ**” **2** while the shutter speed is being automatically adjusted.

To Deactivate Night-Scope . . .

..... press **NIGHT** **Ⓝ** again so that the Night-Scope indicator disappears.

NOTES:

- During Night-Scope, the following functions or settings cannot be activated and its indicator blinks or goes out:
 - Some modes of “Programme AE With Special Effects” (Ⓛ pg. 16).
 - “GAIN UP” in the CAMERA Menu (Ⓛ pg. 22).
 - “DIS” in the MANUAL Menu (Ⓛ pg. 22).
- During Night-Scope, it may be difficult to bring the camcorder into focus. To prevent this, use of manual focus and/or a tripod is recommended.

Programme AE With Special Effects

1 Set the Power Switch **Ⓟ** to “**M**” while pressing down the Lock Button **Ⓛ** located on the switch. Open the LCD monitor fully or pull out the viewfinder fully.

2 Press the **MENU/VOLUME** wheel **Ⓛ** in. The Menu Screen appears.

3 Rotate the **MENU/VOLUME** wheel **Ⓛ** to select “**PROGRAM AE**”, then press it.

4 Rotate the **MENU/VOLUME** wheel **Ⓛ** to select the desired mode, then press it. Selection is complete. Press the **MENU/VOLUME** wheel **Ⓛ** in again. The Menu Screen closes.

- The PROGRAM AE Menu disappears and the selected mode is activated. The selected mode indicator appears.

To Deactivate The Selected Mode . . .

..... select “OFF” in step 4.

IMPORTANT

Some modes of Programme AE with special effects cannot be used with certain Fade/Wipe Effects (Ⓛ pg. 17). If an unusable mode is selected, its indicator blinks or goes out.

NOTES:

- Programme AE with special effects can be changed during recording or during Record-Standby.
- Some modes of Programme AE special effects cannot be used during Night-Scope.

SHUTTER

1/50: The shutter speed is fixed at 1/50th of a second. Black bands that usually appear when shooting a TV screen become narrower.

1/120: The shutter speed is fixed at 1/120th of a second. The flickering that occurs when shooting under a fluorescent light or mercury-vapour lamp is reduced.

SPORTS

(Variable Shutter Speed: 1/250 – 1/4000)

This setting allows fast-moving images to be captured one frame at a time, for vivid, stable slow-motion playback. The faster the shutter speed, the darker the picture becomes. Use the shutter function under good lighting conditions.



SNOW

Compensates for subjects that may otherwise appear too dark when shooting in extremely bright surroundings such as in the snow.

SPOTLIGHT

Compensates for subjects that may otherwise appear too bright when shooting under extremely strong direct lighting such as spotlights.

NOTE:

“SPOTLIGHT” has the same effect as -3 with the exposure control (Ⓛ pg. 19).

TWILIGHT

Makes evening scenes look more natural. White Balance (Ⓛ pg. 20) is initially set to , but can be changed to your desired setting. When Twilight is chosen, the camcorder automatically adjusts the focus from approx. 10 m to infinity. From less than 10 m, adjust the focus manually.

SEPIA

Recorded scenes have a brownish tint like old photos. Combine this with the Cinema mode for a classic look.

B/W MONOTONE

Like black and white films, your footage is shot in B/W. Used together with the Cinema mode, it enhances the “classic film” effect.

CLASSIC FILM

Gives recorded scenes a strobe effect.

STROBE

Your recording looks like a series of consecutive snapshots.

Fade/Wipe Effects

These effects let you make pro-style scene transitions. Use them to spice up the transition from one scene to the next.

Fade or Wipe works when tape recording is started or when you stop recording.

1 Set the Power Switch **26** to “**M**” while pressing down the Lock Button **25** located on the switch. Open the LCD monitor fully or pull out the viewfinder fully.

2 Press the **MENU/VOLUME** wheel **14** in. The Menu Screen appears.

3 Rotate the **MENU/VOLUME** wheel **14** to select “**WIPE/FADER**”, then press it.

4 Rotate the **MENU/VOLUME** wheel **14** to select the desired function, then press it. Selection is complete. Press the **MENU/VOLUME** wheel **14** in again.

• The WIPE/FADER Menu disappears and the effect is reserved. The indicator representing the selected effect appears.

5 Press the Recording Start/Stop Button **22** to activate the Fade-in/out or Wipe-in/out.

To Deactivate The Selected Effect . . .
..... select “OFF” in step 4.

IMPORTANT

Some Fade/Wipe Effects cannot be used with certain modes of Programme AE with special effects (pg. 16). If an unusable Fade/Wipe Effect is selected, its indicator blinks or goes out.

NOTE:

You can extend the length of a Fade or Wipe by pressing and holding the Recording Start/Stop Button **22**.

W FADER — WHITE

Fade in or out with a white screen.

B FADER — BLACK

Fade in or out with a black screen.

BW FADER — B.W

Fade in to a colour screen from a black and white screen, or fade out from colour to black and white.

◻ WIPE — CORNER

Wipe in on a black screen from the upper right to the lower left corner, or wipe out from lower left to upper right, leaving a black screen.

◻ WIPE — WINDOW

The scene starts in the centre of a black screen and wipes in toward the corners, or comes in from the corners, gradually wiping out to the centre.

◀ WIPE — SLIDE

Wipe in from right to left, or wipe out from left to right.

◀▶ WIPE — DOOR

Wipe in as the two halves of a black screen open to the left and right, revealing the scene, or wipe out and the black screen reappears from left and right to cover the scene.

▲ WIPE — SCROLL

The scene wipes in from the bottom to the top of a black screen, or wipes out from top to bottom, leaving a black screen.

◀ WIPE — SHUTTER

Wipe in from the centre of a black screen toward the top and bottom, or wipe out from the top and bottom toward the centre leaving a black screen.

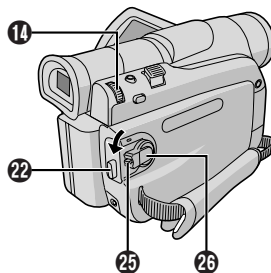

Snapshot (For Tape Recording)

This feature lets you record still images that look like photographs onto a tape.

SNAPSHOT MODE SELECTION

1 Set the Power Switch **26** to “**M**” while pressing down the Lock Button **25** located on the switch. Open the LCD monitor fully or pull out the viewfinder fully.

2 Press the **MENU/VOLUME** wheel **11** in. The Menu Screen appears.

3 Rotate the **MENU/VOLUME** wheel **11** to select “**A** (CAMERA)”, then press it.

4 Rotate the **MENU/VOLUME** wheel **11** to select “SNAP MODE”, then press it.

5 Rotate the **MENU/VOLUME** wheel **11** to select the desired Snapshot mode, then press it. Rotate the **MENU/VOLUME** wheel **11** to select “**U** RETURN” and press it twice. The Menu Screen closes.



FULL
Snapshot mode
with no frame



PIN-UP
Pin-Up mode



FRAME
Snapshot mode
with frame

There is the sound effect of a shutter closing.

SNAPSHOT RECORDING

1 Press **SNAPSHOT 15**. “PHOTO” **16** appears while the snapshot is being taken.

If you press during Record-Standby . . .

..... “PHOTO” **16** appears and a still image will be recorded for approx. 6 seconds, then the camcorder re-enters the Record-Standby mode.

If you press during Recording . . .

..... “PHOTO” **16** appears and a still image will be recorded for approx. 6 seconds, then the normal recording resumes.

• Regardless of the Power Switch **26** position (“**A**” or “**M**”), Snapshot recording takes place using the selected Snapshot mode.

Motor Drive Mode

Keeping **SNAPSHOT 15** pressed provides an effect similar to serial photography. (Interval between still images: approx. 1 second)

NOTES:

- To remove the shutter sound, (☞ “BEEP” on pg. 23.
- If Snapshot recording is not possible, “PHOTO” **16** blinks when **SNAPSHOT 15** is pressed.
- If Programme AE with special effects (☞ pg. 16) is engaged, certain modes of Programme AE with special effects are disabled during Snapshot recording. In such a case, the icon blinks.
- If **SNAPSHOT 15** is pressed when “DIS” is set to “ON” (☞ pg. 22), the Stabiliser will be disabled.
- During tape playback as well, all snapshot modes are available. However, the shutter sound is not heard.
- During Snapshot recording, the image displayed in the viewfinder may be partially missing. However, there is no effect in the recorded image.
- When a cable is connected to the AV connector, the shutter sound is not heard from the speaker, however it is recorded onto the tape.

Auto Focus

The camcorder’s Full Range AF system offers continuous shooting ability from close-up (as close as approx. 5 cm to the subject) to infinity.

However, correct focus may not be obtainable in the situations listed below (in these cases use manual focusing):

- When two subjects overlap in the same scene.
- When illumination is low.*
- When the subject has no contrast (difference in brightness and darkness), such as a flat, one-colour wall, or a clear, blue sky.*
- When a dark object is barely visible in the viewfinder.*
- When the scene contains minute patterns or identical patterns that are regularly repeated.
- When the scene is affected by sunbeams or light reflecting off the surface of a body of water.
- When shooting a scene with a high-contrast background.

* The following low-contrast warnings appear blinking:



NOTES:

- If the lens is smeared or blurred, accurate focusing is not possible. Keep the lens clean, wiping with a piece of soft cloth if it gets dirty. When condensation occurs, wipe with a soft cloth or wait for it to dry naturally.
- When shooting a subject close to the lens, zoom out first (☞ pg. 12). If zoomed-in in the auto focus mode, the camcorder may automatically zoom out depending on the distance between the camcorder and the subject. This will not occur when “TELE MACRO” (☞ pg. 22) is activated.

Manual Focus

To obtain correct focus.

1 If you are using the viewfinder, you should already have made the necessary viewfinder adjustments (☞ pg. 8).

2 Set the Power Switch **26** to “**M**” while pressing down the Lock Button **25** located on the switch, then press **FOCUS 17** (☞ pgs. 40 and 41). The manual focus indicator appears.

3 To focus on a farther subject, rotate the **MENU/VOLUME** wheel **14** towards “+”. “▶” **21** appears and blinks.

To focus on a nearer subject, rotate the **MENU/VOLUME** wheel **14** towards “-”. “◀” **21** appears and blinks.

4 Press the **MENU/VOLUME** wheel **14** in. Focus adjustment is complete.

To reset to Auto Focus, press **FOCUS 17** twice or set the Power Switch **26** to “**A**”.

If **FOCUS 17** is pressed once, the camcorder will enter the focus adjustment mode again.

NOTES:

- Be sure to focus the lens in the maximum telephoto position when you use the Manual Focus mode. If you focus in on a subject in the wide-angle position, sharply focused images cannot be obtained when zoomed up because the depth-of-field is reduced at longer focal lengths.
- When the focus level cannot be adjusted any further or closer, “▲” or “●” will blink.



Focus detection zone



While focusing on a further subject



While focusing on a nearer subject

Exposure Control

Manual exposure adjustment is recommended in the following situations:

- When shooting using reverse lighting or when the background is too bright.
- When shooting on a reflective natural background such as at the beach or when skiing.
- When the background is overly dark or the subject light.

1 Set the Power Switch **26** to “**M**” while pressing down the Lock Button **25** located on the switch. Open the LCD monitor fully or pull out the viewfinder fully.

2 Press the **MENU/VOLUME** wheel **14** in. The Menu Screen appears.

3 Rotate the **MENU/VOLUME** wheel **14** to select “**3** (EXPOSURE)”, then press it.

4 Rotate the **MENU/VOLUME** wheel **14** to select “**MANUAL**”, then press it. The Menu Screen disappears. The exposure control indicator appears.

5 Rotate the **MENU/VOLUME** wheel **14** towards “+” to brighten the image, or towards “-” to darken the image. (maximum ± 6)

6 Press the **MENU/VOLUME** wheel **14** in. Exposure adjustment is complete.

To Return To Automatic Exposure Control . . .

..... select “**AUTO**” in step 4. Or, set the Power Switch **26** to “**A**”.

To Brighten The Subject Quickly . . .

..... press **BACKLIGHT 10**. **24 4** is displayed and the subject is brightened. If pressed again, **24 4** disappears and the brightness returns to the previous level.

- +3 exposure has the same effect as the **BACKLIGHT Button 10**.
- Using **BACKLIGHT 10** may cause the light around the subject to become too bright and the subject to become white.
- Backlight compensations is also available when the Power Switch **26** is set to “**A**”.

NOTE:

You cannot use the manual exposure control at the same time with backlight, spotlight (☞ pg. 16) compensation and “**SNOW**” (☞ pg. 16).

Iris Lock

Use this function in the following situations:

- When shooting a moving subject.
- When the distance to the subject changes (so its size in the LCD monitor or the viewfinder changes), such as when the subject is backing away.
- When shooting on a reflective natural background such as at the beach or when skiing.
- When shooting objects under a spotlight.
- When zooming.

When the subject is close, keep the iris locked. Even when the subject moves away from you, the image will not darken or brighten.

Before the following steps, perform steps 1 through 4 of “Exposure Control” (pg. 19).

5 Adjust zoom so that the subject fills the LCD monitor or the viewfinder, then press and hold the **MENU/VOLUME** wheel **10** for over 2 seconds. The exposure control indicator **4** and “**L**” **6** appear. Press the **MENU/VOLUME** wheel **10** in. “**L**” **6** changes to “**L**” and the iris is locked.

To Return To Automatic Iris Control . . .

..... rotate the **MENU/VOLUME** wheel **10** to display “**AUTO**” then press it in step 4. The exposure control indicator **4** and “**L**” **6** disappear. Or, set the Power Switch **26** to “**A**”.

To Lock The Exposure Control And The Iris . . .

..... after step 4 of “Exposure Control” (pg. 19), adjust the exposure rotating the **MENU/VOLUME** wheel **10**. Then lock the iris in step 5 of “Iris Lock”. For automatic locking, rotate the **MENU/VOLUME** wheel **10** to select “**AUTO**”, then press it in step 4. The iris becomes automatic after about 2 seconds.

Iris

Like the pupil of the human eye, it contracts in well-lit environments to keep too much light from entering, and dilates in dim environments to allow in more light.

White Balance Adjustment

A term that refers to the correctness of colour reproduction under various lighting. If the white balance is correct, all other colours will be accurately reproduced.

The white balance is usually adjusted automatically. However, more advanced camcorder operators control this function manually to achieve a more professional colour/tint reproduction.

1 Set the Power Switch **26** to “**M**” while pressing down the Lock Button **25** located on the switch. Open the LCD monitor fully or pull out the viewfinder fully.

2 Press the **MENU/VOLUME** wheel **10** in. The Menu Screen appears.

3 Rotate the **MENU/VOLUME** wheel **10** to select “**W.BALANCE**”, then press it.

4 Rotate the **MENU/VOLUME** wheel **10** to select the desired mode.

“**AUTO**”: White balance is adjusted automatically (factory preset).

“**MWB**”: White balance is set manually.

“**FINE**”: Outdoors on a sunny day.

“**CLOUD**”: Outdoors on a cloudy day.

“**HALOGEN**”: A video light or similar type of lighting is used.

5 Press the **MENU/VOLUME** wheel **10** in. Selection is complete. Press the **MENU/VOLUME** wheel **10** in again. The Menu Screen closes and the selected mode indicator except “**AUTO**” appears.

To Return To Automatic White Balance . . .

..... select “**AUTO**” in step 4. Or, set the Power Switch **26** to “**A**”.

NOTE:

White balance cannot be used when Sepia or Monotone (pg. 16) is activated.

Manual White Balance Operation

Perform Manual White Balance when shooting under various types of lighting.

1 Follow steps 1 through 4 of the white balance adjustment, and select “**MWB**”.

2 Hold a sheet of plain white paper in front of the lens. Adjust zoom or position yourself so that the white paper fills the screen.

3 Press the **MENU/VOLUME** wheel **10** in until **3** begins blinking rapidly. When the setting is completed, **3** resumes normal blinking.

4 Press the **MENU/VOLUME** wheel **10** in twice. The Menu Screen closes and the Manual White Balance indicator **3** is displayed.

NOTES:

- In step 2, it may be difficult to focus on the white paper. In such a case, adjust focus manually (pg. 19).
- A subject can be shot under various types of lighting conditions indoors (natural, fluorescent, candlelight, etc.). Because the colour temperature is different depending on the light source, the subject tint will differ depending on the white balance settings. Use this function for a more natural result.
- Once you adjust white balance manually, the setting is retained even if the power is turned off or the battery removed.

For Recording Menu

This camcorder is equipped with an easy-to-use, on-screen menu system that simplifies many of the more detailed camcorder settings (☞ pg. 21 – 24).

1 Set the Power Switch **26** to “**M**” while pressing down the Lock Button **25** located on the switch. Open the LCD monitor fully or pull out the viewfinder fully.

2 Press the **MENU/VOLUME** wheel **11** in. The Menu Screen appears.

3 Rotate the **MENU/VOLUME** wheel **11** to select the desired function menu, and press it.

4 Function menu setting depends on the function.

If you have selected “**WIPE/FADER**”, “**PROGRAM AE**”, “**EXPOSURE**” or “**W. BALANCE**” . . .

..... see the column on the right.

If you have selected “**CAMERA**”, “**MANUAL**”, “**SYSTEM**” or “**CAMERA DISPLAY**” . . .

..... go to step 5.

5 Rotate the **MENU/VOLUME** wheel **11** to select the desired function and press it. The Sub Menu appears. Then, rotate the **MENU/VOLUME** wheel **11** to select the parameter, and press it. Selection is complete.

6 Rotate the **MENU/VOLUME** wheel **11** to select “**RETURN**” and press it twice. The Menu Screen closes.

• The **⊗** icon represents “END”.

NOTE:

When the Menu Screen is left on for a couple of minutes, a residual image may be left on the screen and it may take several seconds for the residual image to disappear. This is not due to any defect of the unit.

WIPE/FADER

Refer to “Fade/Wipe Effects” (☞ pg. 17).

PROGRAM AE

Refer to “Programme AE With Special Effects” (☞ pg. 16).

EXPOSURE

Refer to “Exposure Control” and “Iris Lock” (☞ pg. 19, 20).

W.BALANCE

Refer to “White Balance Adjustment” and “Manual White Balance Operation” (☞ pg. 20).

CAMERA

Settings made in the “**CAMERA**” Menu remain effective whether the Power Switch **26** is set to “**A**” or “**M**”. However, the menu settings can be changed only when the Power Switch **26** is set to “**M**”.

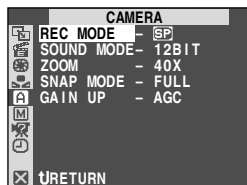

REC MODE

Allows you to set the tape recording mode ([SP] or LP) depending on your preference (☞ pg. 10).

SOUND MODE

[12BIT]: Enables tape recording of stereo sound on four separate channels, and is recommended for use when performing audio dubbing. (Equivalent to the 32 kHz mode of previous models)

16BIT: Enables tape recording of stereo sound on two separate channels. (Equivalent to the 48 kHz mode of previous models)

ZOOM

16X: When set to “16X” while using digital zoom, the zoom magnification will reset to 16X since digital zoom will be disengaged.

[40X]: Allows you to use the Digital Zoom. By digitally processing and magnifying images, zooming is possible from 16X (the optical zoom limit), to a maximum of 40X digital magnification.

700X: Allows you to use the Digital Zoom. By digitally processing and magnifying images, zooming is possible from 16X (the optical zoom limit), to a maximum of 700X digital magnification.

[] = Factory-preset

SNAP MODE

Refer to “Snapshot (For Tape Recording)” (▶ pg. 18).



GAIN UP

OFF: Allows you to shoot dark scenes with no picture brightness adjustment.

[AGC]: The overall appearance may be grainy, but the image is bright.

AUTO \rightarrow A: The shutter speed is automatically adjusted (1/25 — 1/200 sec.). Shooting a subject in low or poor lighting at 1/25 sec. shutter speed provides a brighter image than in the AGC mode, but the subject’s movements are not smooth or natural. The overall appearance may be grainy. While the shutter speed is being automatically adjusted, “ \rightarrow A” is displayed.

MANUAL

The “ MANUAL” settings are effective only when the Power Switch  is set to “”.





DIS

OFF: To turn off this function.

[ON ]: To compensate for unstable images caused by camera-shake, particularly at high magnification.

NOTES:

- Accurate stabilisation may not be possible if hand shake is excessive, or under the following conditions:
 - When shooting subjects with vertical or horizontal stripes.
 - When shooting dark or dim subjects.
 - When shooting subjects with excessive backlighting.
 - When shooting scenes with movement in various directions.
 - When shooting scenes with low-contrast backgrounds.
- Switch off this mode when recording with the camcorder on a tripod.
- The “” indicator  blinks or goes out if the Stabiliser cannot be used.

TELE MACRO



[OFF]: To turn off this function.



ON: Usually the distance to a subject where the lens is in focus depends on the zoom magnification. Unless there is a distance more than 1m to the subject, the lens is out of focus at the maximum telephoto setting. When set to “ON”, you can shoot a subject as large as possible at a distance of approx. 60 cm.

- Depending on the zoom position, the lens may go out of focus.

WIDE MODE



[OFF]: Records with no change in the screen ratio. For playback on a TV with a normal screen ratio.

CINEMA : Inserts black bands at the top and bottom of the screen. During playback on wide-screen TVs, the black bands at the top and bottom of the screen are cut and the screen ratio becomes 16:9.  12 appears. When using this mode, refer to your wide-screen TV’s instruction manual. During playback/recording on 4:3 TVs/LCD monitor/viewfinder, black bands are inserted at the top and bottom of the screen and the image appears like a letterboxed 16:9 movie.

SQUEEZE : For playback on TVs with an aspect ratio of 16:9. Naturally expands the image to fit the screen without distortion.  12 appears. When using this mode, refer to your wide-screen TV’s instruction manual. During playback/recording on 4:3 TVs/LCD monitor/viewfinder, the image is elongated vertically.

WIND CUT

[OFF]: Disengages the function which cuts down on noise created by wind.

ON : Helps cut down on noise created by wind. “” 18 appears. The quality of the sound will change. This is normal.

[] = Factory-preset

SYSTEM

"SYSTEM" functions which are set when the Power Switch **26** is set to "M" are also applied when the Power Switch **26** is set to "PLAY" (pg. 24).

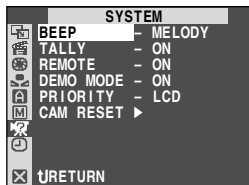

BEEP

OFF: Even though not heard while shooting, shutter sound is recorded on the tape.

BEEP: The beep sounds when the power is turned on or off, and at the beginning and end of recording. Also to activate the shutter sound effect (pg. 18).

[MELODY]: Instead of a beep, a melody sounds when any operation is performed. It also activates the shutter sound effect (pg. 18).

TALLY

OFF: The tally lamp remains off at all times.

[ON]: The tally lamp comes on to signal the start of recording.

REMOTE

OFF: Disables the camcorder from receiving the remote control's beam signals. The camcorder cannot be operated by the remote control.

[ON]: Enables the camcorder to receive the remote control's beam signals.

DEMO MODE

OFF: Automatic demonstration will not take place.

[ON]: Demonstrates certain functions such as Programme AE with special effects, etc., and can be used to confirm how these functions operate. Demonstration starts in the following cases:

- When the Menu Screen is closed after "DEMO MODE" is turned "ON".
- With "DEMO MODE" set to "ON", if there is no operation for about 3 minutes after the Power Switch **26** is set to "A" or "M".

Performing any operation during the demonstration stops the demonstration temporarily. If no operation is performed for more than 3 minutes after that, the demonstration will resume.

NOTES:

- If a tape is in the camcorder, the demonstration cannot be turned on.
- "DEMO MODE" remains "ON" even if the camcorder power is turned off.
- If "DEMO MODE" remains "ON", some functions will not be available. After viewing demo, set to "OFF".

PRIORITY

[LCD]: When the LCD monitor is fully open, even if the viewfinder is pulled out, the image is displayed only on the LCD monitor; it will not be displayed in the viewfinder.

FINDER: When the viewfinder is pulled out, even if the LCD monitor is fully open, the image is displayed only in the viewfinder; it will not be displayed on the LCD monitor.

CAM RESET

[CANCEL]: Does not reset all settings to the factory-preset.

EXECUTE: Resets all settings to the factory-preset.

CAMERA DISPLAY

- Settings made in the "CAMERA DISPLAY" Menu are effective only for video shooting.
- Settings made in the "CAMERA DISPLAY" Menu remain effective even when the Power Switch **26** is set to "A". However, the menu settings can be changed only when the Power Switch **26** is set to "M".

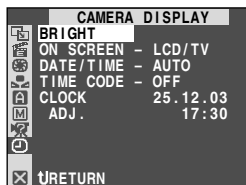

BRIGHT

pg. 11, "To Adjust The Brightness Of The Display"

ON SCREEN

LCD: Keeps the camcorder's display (except the date, time and time code) from appearing on the connected TV screen.

[LCD/TV]: Makes the camcorder's display appear on screen when the camcorder is connected to a TV.

DATE/TIME

OFF: The date/time does not appear.

[AUTO]: Displays the date/time for approx. 5 seconds in the following cases:

- When the Power Switch **26** is set from "OFF (CHARGE)" to "A" or "M".
- When tape playback starts. The camcorder displays the date/time when scenes are recorded.
- When the date is changed during tape playback.

ON: The date/time is always displayed.

- The date indication can also be turned on/off by pressing the **DISPLAY** Button **46** on the remote control.

[] = Factory-preset

TIME CODE

[OFF]: Time code is not displayed.

ON: Time code is displayed on the camcorder and on the connected TV. Frame numbers are not displayed during recording.

CLOCK ADJ.

Allows you to set the current date and time (📖 pg. 10).

For Playback Menu

The following procedure applies to all except Synchro Comp (📖 pg. 32).

- 1 Set the Power Switch **26** to "PLAY" while pressing down the Lock Button **25** located on the switch.
- 2 Press the **MENU/VOLUME** wheel **14** in. The Menu Screen appears.
- 3 Rotate the **MENU/VOLUME** wheel **14** to select the desired function menu, and press it.
- 4 Rotate the **MENU/VOLUME** wheel **14** to select the desired function, and press it to display the Sub Menu.
- 5 Rotate the **MENU/VOLUME** wheel **14** to select the desired parameter and press it. Selection is complete.
- 6 Rotate the **MENU/VOLUME** wheel **14** to select "RETURN" and press it twice to close the Menu Screen.

VIDEO

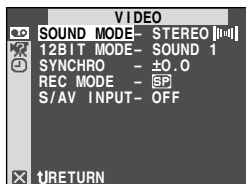

SOUND MODE 📖 pg. 25, "Playback Sound".

12BIT MODE 📖 pg. 25, "Display".

SYNCHRO 📖 pg. 32, "For More Accurate Editing".

REC MODE

Allows you to set the tape recording mode ([SP] or LP) depending on your preference (📖 pg. 10). It is recommended you use "REC MODE" in the "VIDEO" Menu when using this camcorder as a recorder during dubbing (GR-D50/D30 only, 📖 pg. 26, 27).

- "REC MODE" can be set when the Power Switch **26** is set to "PLAY" or "[M]" (📖 pg. 10, 21).

S/AV INPUT (GR-D50/D30 only)

ON: Enables audio/video signal input from the AV and S-VIDEO connectors (📖 pg. 26).

[OFF]: Enables audio/video signal output to a TV, VCR, etc. via the AV and S-VIDEO connectors (📖 pg. 15, 26).

- When "S/AV INPUT" is set to "ON", camcorder playback cannot be viewed on the AV output.

SYSTEM

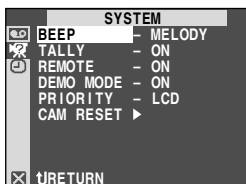

Each setting is linked with "SYSTEM", which appears when the Power Switch **26** is set to "[M]" (📖 pg. 23).

The parameters are the same as in the description on pg. 23.

[] = Factory-preset

VIDEO DISPLAY

- Settings made in the “VIDEO DISPLAY” Menu are effective only for tape playback.



NOTES:

- You can also use the provided remote control's **AUDIO** button to change the output sound (without having to access the Playback Menu). Make sure you point the remote control at the camcorder's remote sensor .
- The camcorder cannot detect the sound mode in which the recording was made during fast-forward or rewind. During playback the sound mode is displayed in the upper left corner.
- The “SOUND MODE” setting is available for both 12-bit and 16-bit sound. (In previous models' functions, “12-bit” is called “32 kHz” and “16-bit” is called “48 kHz”.)

BRIGHT , DATE/TIME , TIME CODE

Refer to “CAMERA DISPLAY” on page 23, 24. The factory-preset of “DATE/TIME” in the “VIDEO DISPLAY” Menu is “OFF”.

ON SCREEN

OFF: Camcorder's display (except the date, time and time code) is not shown on LCD or connected TV.

[LCD]: Camcorder's display is shown only on LCD and not on connected TV (except the date, time and time code).

LCD/TV: Camcorder's display is shown on both LCD and connected TV.

Playback Sound

During tape playback, the camcorder detects the sound mode in which the recording was made, and plays the sound back. Select the type of sound to accompany your playback picture. According to the menu access explanation on pg. 24, select “SOUND MODE” or “12BIT MODE” from the Menu Screen and set it to the desired parameter.

SOUND MODE

[STEREO]: Sound is output on both “L” and “R” channels in stereo.

SOUND L : Sound from the “L” channel is output.

SOUND R : Sound from the “R” channel is output.

12BIT MODE

MIX: Original and dubbed sounds are combined and output in stereo on both “L” and “R” channels.

[SOUND 1]: Original sound is output on both “L” and “R” channels in stereo.

SOUND 2: Dubbed sound is output on both “L” and “R” channels in stereo.

[] = Factory-preset

Display

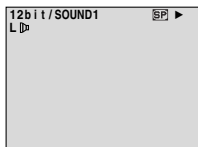

ON SCREEN setting:
For playback sound,
tape speed and tape
running.

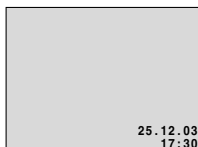

DATE/TIME setting:
For date/time.

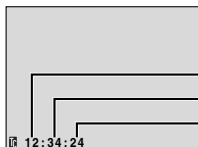

TIME CODE setting:
For time code.

Minutes
Seconds
Frames*

* 25 frames = 1 second

To Use This Camcorder As A Player

- 1 Following the illustration, connect the camcorder and the VCR. Also refer to pg. 15.
- 2 Set the camcorder's Power Switch **23** to "PLAY" while pressing down the Lock Button **25** located on the switch, turn on the VCR's power, and insert the appropriate cassettes in the camcorder and the VCR.
- 3 Engage the VCR's AUX and Record-Pause modes.
- 4 Engage the camcorder's Play mode to find a spot just before the edit-in point. Once it is reached, press **▶/II 6** on the camcorder.
- 5 Press **▶/II 6** on the camcorder and engage the VCR's Record mode.
- 6 Engage the VCR's Record-Pause mode and press **▶/II 6** on the camcorder.
- 7 Repeat steps 4 through 6 for additional editing, then stop the VCR and camcorder when finished.

NOTES:

- As the camcorder starts to play your footage it will appear on your TV. This will confirm the connections and the AUX channel for dubbing purposes.
- Before you start dubbing, make sure that the indications do not appear on the connected TV. If they do, they are being recorded onto the new tape.
- Set the video out select switch of the cable adapter as required:
 Y/C : When connecting to a TV or VCR which accepts Y/C signals and uses an S-Video cable.
 CVBS : When connecting to a TV or VCR which does not accept Y/C signals and uses an audio/video cable.

To choose whether or not the following displays appear on the connected TV . . .

- Date/Time
 set "DATE/TIME" to "AUTO", "ON" or "OFF" in the Menu Screen (☞ pg. 23, 25).
 Or, press **DISPLAY 13** on the remote control to turn on/off the date indication.
- Time Code
 set "TIME CODE" to "ON" or "OFF" in the Menu Screen (☞ pg. 24, 25).
- Indications other than date/time and time code
 set "ON SCREEN" to "LCD", "LCD/TV" or "OFF" in the Menu Screen (☞ pg. 23, 25).

To Use This Camcorder As A Recorder (GR-D50/D30 only)

1. Set the camcorder's Power Switch **23** to "PLAY" while pressing down the Lock Button **25** located on the switch.
2. Set "S/AV INPUT" to "ON" and set "REC MODE" to "SP" or "LP" (☞ pg. 24).

3. Connect the cables as shown in the illustration and load a cassette to record on.
4. Press the Recording Start/Stop button **22** to engage the Record-Pause mode. "A/V IN" appears on the screen.
5. Press the Recording Start/Stop button **22** to start recording. **15** rotates.
6. Press the Recording Start/Stop button **22** again to engage the Record-Pause mode. **15** stops rotating.

NOTES:

- To use an output cable adapter (commercially available), refer to its instructions.
- After dubbing, set "S/AV INPUT" back to "OFF".
- Analogue signals can be converted to digital signals with this procedure.
- It is also possible to dub from another camcorder.

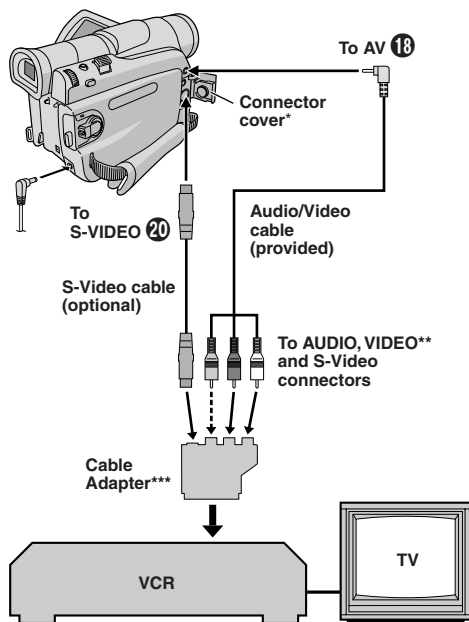

* When connecting the cables, open this cover.

** Connect when an S-Video cable is not used.

*** If your VCR has a SCART connector

To use this camcorder as a player → use the provided cable adapter.

To use this camcorder as a recorder (GR-D50/D30 only) → use a commercially available output cable adapter.

Dubbing To Or From A Video Unit Equipped With A DV Connector (Digital Dubbing)

It is also possible to copy recorded scenes from this camcorder onto another video unit equipped with a DV connector. Since a digital signal is sent, there is little if any image or sound deterioration.

To Use This Camcorder As A Player

- 1 Make sure all units are turned off. Connect this camcorder to a video unit equipped with a DV input connector using a DV cable as shown in the illustration.
- 2 Set this camcorder's Power Switch **26** to "PLAY" while pressing down the Lock Button **25** located on the switch, turn on the video unit's power, and insert the appropriate cassettes in this camcorder and the video unit.
- 3 Press **▶ 6** to play back the source tape.
- 4 While watching the playback on the monitor, engage the DV connector-equipped video unit's record mode from the spot on the source tape you want to begin recording.

NOTES:

- It is recommended to use the AC Adapter as the power supply instead of the battery pack (☞ pg. 7).
- If the remote control is used when both the player and recorder are JVC video units, both units will perform the same operation. To prevent this from happening, press the buttons on both units.
- If a blank portion or disturbed image is played back on the player during dubbing, the dubbing may stop so that an unusual image is not dubbed.
- Even though the DV cable is connected correctly, sometimes the image may not appear in step 4. If this occurs, turn off the power and make connections again.
- If "Playback Zoom" (☞ pg. 13, 28), "Playback Special Effects" (☞ pg. 28) or "Snapshot" is attempted during playback, only the original playback image recorded on the tape is output from the DV connector **11**.
- When using a DV cable, be sure to use the optional JVC VC-VDV204U DV cable.

To Use This Camcorder As A Recorder (GR-D50/D30 only)

1. Set this camcorder's Power Switch **26** to "PLAY" while pressing down the Lock Button **25** located on the switch.
2. Set "REC MODE" to "SP" or "LP" in the Menu Screen (☞ pg. 24).
3. Connect the DV cable as shown in the illustration and load a cassette to record on.
4. Press the Recording Start/Stop button **22** to engage the Record-Pause mode. "DV.IN" appears on the screen.

5. Press the Recording Start/Stop button **22** to start recording. **15** rotates.
6. Press the Recording Start/Stop button **22** again to engage the Record-Pause mode. **15** stops rotating.

NOTES:

- Digital Dubbing is performed in the sound mode recorded on the original tape, regardless of the current "SOUND MODE" setting (☞ pg. 21).
- During Digital Dubbing, incoming signals cannot be output through the video or audio connectors if they are copy-guarded.

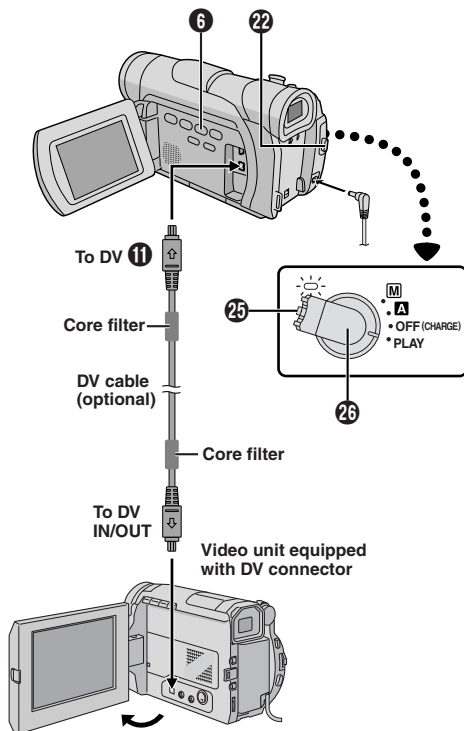

Make sure "REMOTE" in the SYSTEM Menu is set to "ON" (pg. 23) and the remote control is pointed at the remote sensor ❶. The transmitted beam's approximate effective distance for indoor use is 5m.

Slow-Motion Playback

To allow slow-speed search in either direction during tape playback.

1 To change from normal to Slow-Motion Playback, press **SLOW** (◀) ❸ or (▶) ❹ more than approx. 2 seconds. After approx. 5 minutes (approx. 20 seconds with an 80-minute cassette) in Slow Rewind or approx. 5 minutes in Slow Forward, normal playback resumes.

■ To stop Slow-Motion Playback, press **PLAY** (▶) ❺.

NOTES:

- You can also engage Slow-Motion Playback from Still Playback by pressing **SLOW** ❸ or ❹ more than approx. 2 seconds.
- During Slow-Motion Playback, due to digital image processing, the picture may take on a mosaic effect.
- After **SLOW** (◀) ❸ or (▶) ❹ is pressed and held, the still image may be displayed for a few seconds, followed by a blue screen for a few seconds. This is not a malfunction.
- There may be a small margin between the slow-motion playback start point you chose and the actual start point for Slow-Motion Playback.
- During Slow-Motion Playback, there will be disturbances in video and the picture may seem unstable, especially with steady images. This is not a malfunction.
- During Slow-Motion Playback, press **PAUSE** (||) ❻ to pause playback.

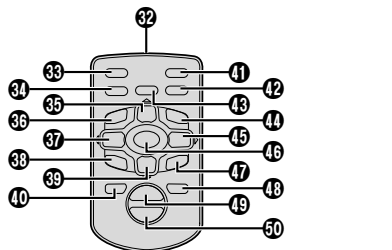

Frame-By-Frame Playback

To allow frame-by-frame search during tape playback.

1 To change from normal to Frame-By-Frame Playback, press **SLOW** (▶) ❹ repeatedly for forward or **SLOW** (◀) ❸ repeatedly for reverse. Each time it is pressed, the frame is played back.

NOTE:

You can also engage Frame-By-Frame Playback from Still Playback by pressing **SLOW** (◀) ❸ or (▶) ❹ repeatedly.

Playback Special Effects

To allow you to add creative effects to the playback image.

1 To start playback, press **PLAY** (▶) ❺.

2 Point the remote control at the camcorder's remote sensor and press **EFFECT** ❸. The **PLAYBACK EFFECT Select Menu** appears.

3 Move the highlight bar to the desired effect by pressing **EFFECT** ❸. The selected function is activated and after 2 seconds the menu disappears.

- To deactivate the selected effect, press **ON/OFF** ❷ on the remote control. Pressing it again re-activates the selected effect.
- To change the selected effect, repeat from step 2 above.

NOTE:

The effects that can be used during playback are Classic Film, Monotone, Sepia and Strobe. The effects work the same in playback as they did in recording. Refer to page 16 for more information.

Playback Zoom

To magnify the recorded image up to 44X at any time during playback.

1 Press **PLAY** (▶) ❺ to find the scene of interest.

2 Press the **Zoom Button T** ❹ or **W** ❺ on the remote control. Make sure the remote control is pointed at the camcorder's remote sensor. Pressing **T** ❹ zooms in.

3 You can move the image on screen around to find a particular portion of the picture. While holding down **SHIFT** ❶, press ◀ (Left) ❷, ▶ (Right) ❸, ▲ (Up) ❹ and ▼ (Down) ❺.

- To end zoom, press and hold **W** ❺ until magnification returns to normal. Or, press **STOP** (■) ❻ and then press **PLAY** (▶) ❺.

NOTES:

- Zoom can also be used during slow-motion and still playback.
- Due to digital image processing, the quality of the image may suffer.

Normal playback



Press T ❹



To move image, press ▶ (Right) ❸ while keeping **SHIFT** ❶ held down.

Audio Dubbing

The audio track can be customized only when recorded in the 12-bit mode (☞ pg. 21).

NOTES:

- Audio Dubbing is not possible on a tape recorded in 16-bit audio, on a tape recorded in the LP mode or on a blank portion of a tape.
- To perform Audio Dubbing while watching on the television, make connections (☞ pg. 15).

1 Play back the tape to locate the point where editing will start, then press **PAUSE (II) 35**.

2 While holding **A.DUB (⊖) 47** on the remote control, press **PAUSE (II) 35**, **"II" 28** and "MIC" (GR-D50/D30 only) appear.

3 Press **PLAY (▶) 46**, then begin "narrating".
Speak into the microphone.

- To pause dubbing, press **PAUSE (II) 35**.

4 To end Audio Dubbing, press **PAUSE (II) 35**, then **STOP (■) 49**.

To hear the dubbed sound during playback . . .

..... set "12BIT MODE" to "SOUND 2" or "MIX" in the Menu Screen (☞ pg. 25).

NOTES:

- Sound is not heard from the speaker during Audio Dubbing.
- When editing onto a tape that was recorded at 12-bit, the old and new soundtracks are recorded separately.
- If you dub onto a blank space on the tape, the sound may be disrupted. Make sure you only edit recorded areas.
- If feedback or howling occurs during TV playback, move the camcorder's microphone away from the TV, or turn down the TV's volume.
- If you change from 12-bit to 16-bit in mid-recording and then use the tape for Audio Dubbing, it is not effective from the point where 16-bit recording began.
- During Audio Dubbing, when the tape moves to scenes recorded in the LP mode, scenes recorded in 16-bit audio or a blank portion, Audio Dubbing stops (☞ pg. 44).
- To perform Audio Dubbing with a video unit connected to the camcorder's AV connector, first set "S/AV INPUT" to "ON" in the Menu Screen (GR-D50/D30 only, ☞ pg. 24). "AUX" appears instead of "MIC".

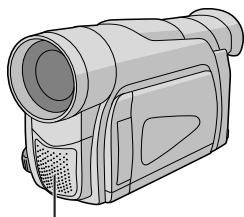

Stereo microphone

Insert Editing

You can record a new scene into a previously recorded tape, replacing a section of the original recording with minimal picture distortion at the in and outpoints. The original audio remains unchanged.

NOTES:

- Before performing the following steps, make sure that "TIME CODE" is set to "ON" in the Menu Screen (☞ pg. 24, 25).
- Insert Editing is not possible on a tape recorded in the LP mode or on a blank portion of a tape.
- To perform Insert Editing while watching in the television, make connections (☞ pg. 15).

1 Play back the tape, locate the Edit-Out point and press **PAUSE (II) 35**. Confirm the time code at this point (☞ pg. 24, 25).

2 Press **REW (◀) 37** until the Edit-In point is located, then press **PAUSE (II) 35**.

3 Press and hold **INSERT (⊂) 38** on the remote control, then press **PAUSE (II) 35**. "II" 17 and the Time Code (min.:sec.) appear and the camcorder enters Insert-Pause mode.

4 Press **START/STOP (I) 41** to begin editing.

- Confirm the insert at the time code you checked in step 1.
- To pause editing, press **START/STOP (I) 41**. Press it again to resume editing.

5 To end Insert Editing, press **START/STOP (I) 41**, then **STOP (■) 49**.

NOTES:

- Programme AE with special effects (☞ pg. 16) can be used to spice up the scenes being edited during Insert Editing.
- During Insert Editing, the date and time information changes.
- If you perform Insert Editing onto a blank space on the tape, the audio and video may be disrupted. Make sure you only edit recorded areas.
- During Insert Editing, when the tape moves to scenes recorded in the LP mode or a blank portion, Insert Editing stops (☞ pg. 44).

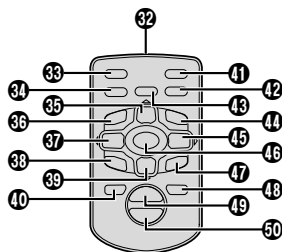

Although the MBR is compatible with JVC VCRs and those of many other makers, it may not work with yours or may offer limited functions.

NOTES:

- If the VCR's power does not come on in step 1, try another code from the VCR CODE LIST.
- Some brands of VCR do not come on automatically. In this case, turn the power on manually and try step 2.
- If the remote control is not able to control the VCR, use the controls on the VCR.
- When the remote control's batteries run out, the VCR brand you have set will be erased. In that case, replace the old battery with a new one to reset the VCR brand.

Create edited videos easily using your camcorder as the source player. You can select up to 8 "cuts" for automatic editing, in any order you like. R.A.Edit is more easily performed when the MBR (Multi-Brand Remote) is set to operate with your brand of VCR (see VCR CODE LIST), but can also be performed by operating the VCR manually.

Use the optional Remote Control kit RM-V717KITU. Before operation, make sure the batteries are installed in the remote control (Ⓛ pg. 45).

SET REMOTE/VCR CODE

1 Turn off the power to the VCR and point the remote towards the VCR's infrared sensor. Then, referring to the VCR CODE LIST, press and hold **MBR SET** (Ⓜ), and enter the brand code.

The code is automatically set once you release **MBR SET** (Ⓜ), and the VCR's power comes on.

2 Make sure the VCR's power is on. Then, while holding **SHIFT** (Ⓢ), press the button on the remote for the desired function. The functions the remote can control are PLAY, STOP, PAUSE, FF, REW and VCR REC STBY (you do not need to press **SHIFT** (Ⓢ) for this one).

You are now ready to try Random Assemble Editing.

MAKE CONNECTIONS

Also refer to pg. 15 and 31.

1 **A** A JVC VCR equipped with a remote pause connector . . .

....connect the editing cable to the Remote PAUSE connector.

B A JVC VCR not equipped with a remote pause connector but equipped with an R.A.EDIT connector . . .

....connect the editing cable to the R.A.EDIT connector.

C A VCR other than above . . .

....connect the editing cable to the remote control's PAUSE IN connector (Ⓛ).

2 Insert a recorded tape into the camcorder. Set the Power Switch (Ⓟ) to "PLAY" while pressing down the Lock Button (Ⓛ) located on the switch.

3 Turn the VCR power on, insert a recordable tape and engage the AUX mode (refer to the VCR's instructions).

NOTES:

- Before Random Assemble Editing, make sure the indications do not appear on the TV monitor. If they do, they will be recorded onto the new tape.

To choose whether or not the following displays appear on the connected TV . . .

- Date/Time
 - set "DATE/TIME" to "AUTO", "ON" or "OFF" in the Menu Screen (Ⓛ pg. 23, 25).
 - Or, press **DISPLAY** (Ⓛ) on the remote control to turn on/off the date indication.
- Time Code
 - set "TIME CODE" to "ON" or "OFF" in the Menu Screen (Ⓛ pg. 24, 25).
- Indications other than date/time and time code
 - set "ON SCREEN" to "LCD", "LCD/TV" or "OFF" in the Menu Screen (Ⓛ pg. 23, 25).

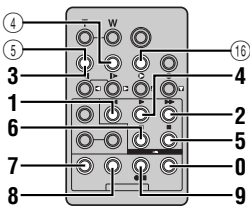
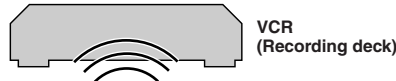

RM-V717U (optional)

VCR BRAND NAME	BRAND CODE	VCR BRAND NAME	BRAND CODE	VCR BRAND NAME	BRAND CODE
AKAI	6 2	MITSUBISHI	6 7	SAMSUNG	9 4
	6 4		6 8		SANYO
	7 7	3 7	3 5		
BLAUPUNKT	1 3	NEC	3 8	SELECO, REX	9 1
	1 8		1 7	9 6	
DAEWOO	1 8	PANASONIC	1 3	SHARP	1 5
FERGUSON	9 7		1 1	1 0	
GRUNDIG	1 4		9 4	SONY	6 5
	3 4		1 8		6 0
HITACHI	6 6	PHILIPS	1 9	3 9	
	6 3		9 5	3 1	
JVC A	9 1		1 1	THOMSON, TELEFUNKEN, SABA, NORDMENDE	9 1
	9 6		9 1		9 6
	9 3		9 6		9 7
LG/GOLDSTAR	1 1		3 3	TOSHIBA	6 9
		7 2	6 1		

- Make sure to set "S/AV INPUT" to "OFF" in the Menu Screen (GR-D50/D30 only,  pg. 24).
- Set the video out select switch of the cable adapter as required:
 Y/C : When connecting to a TV or VCR which accepts Y/C signals and uses an S-Video cable.
 CVBS : When connecting to a TV or VCR which does not accept Y/C signals and uses an audio/video cable.
- When editing on a VCR equipped with a DV input connector, an optional DV cable can be connected instead of an S-Video cable and audio/video cable.

SELECT SCENES

4 Point the remote control at the camcorder's remote sensor. Press **PLAY** (▶) (20) and then press **R.A.EDIT ON/OFF** (24) on the remote control. The Random Assemble Editing Menu appears.

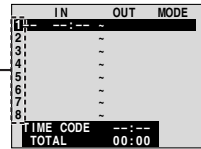

Random Assemble Editing Menu

Programme

5 If using a Fade/Wipe at the beginning of the scene, press **FADE/WIPE** (9) on the remote control.

- Cycle through the effects by pressing repeatedly, and stop when the one you want is displayed.

6 At the beginning of the scene, press **EDIT IN/OUT** (12) on the remote control. The Edit-In position appears in the Random Assemble Editing Menu.

7 At the end of the scene, press **EDIT IN/OUT** (12). The Edit-Out position appears in the Random Assemble Editing Menu.

8 If using a Fade/Wipe at the end of the scene, press **FADE/WIPE** (9).

- Cycle through the effects by pressing repeatedly, and stop when the one you want is displayed.
- If you select a Fade/Wipe effect for an Edit-Out point, the effect is automatically applied to the following Edit-In point.
- When you use Fade/Wipe effects, that time is included in the total time.

9 If using Playback Special Effects, press **EFFECT** (11) ( pg. 28).

10 Repeat steps 6 through 9 to register additional scenes.

- To change previously registered points, press **CANCEL** (13) on the remote control. The registered points disappear, one at a time, from the most recently registered point.
- If you are not using Fade/Wipe or Programme AE with special effects, repeat steps 6 and 7 only.

NOTES:

- When choosing a scene, set Edit-In and Edit-Out points so that there is a relatively large difference between them.
- If the search time for an in-point exceeds 5 minutes, the recording deck's Record-Standby mode will be cancelled and editing will not take place.
- If there are blank portions before or after the Edit-In and Edit-Out points, a blue screen may be included in the edited version.
- Since time codes register time only as accurately as seconds, the time code total time may not match the total programme time exactly.
- Turning off the camcorder's power erases all registered Edit-In and Edit-Out points.

Continued on next page.

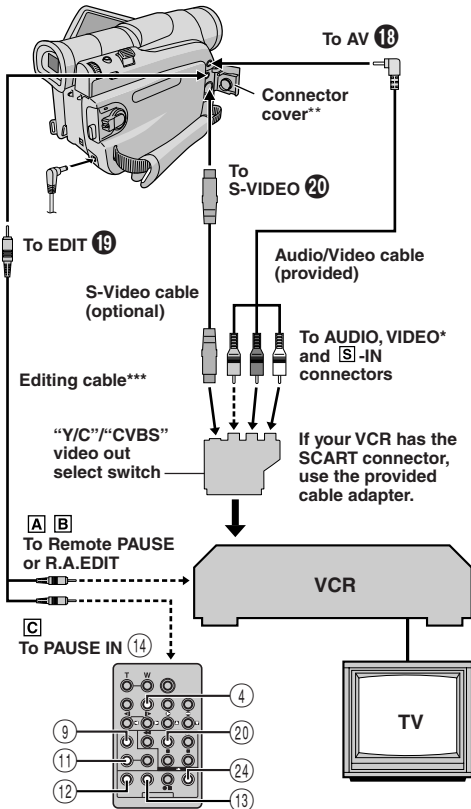

* Connect when an S-Video cable is not used.

** When connecting cables, open this cover.

*** Provided with the optional Remote Control kit RM-V717KITU.

- If you select Sepia or Monotone mode from Programme AE with special effects, you cannot use the Black & White Fader. In this case the Black & White indicator begins blinking. Once the next Edit-In point is registered, the effect is turned off. To combine these effects, use Sepia or Monotone during recording, then use the Black & White Fader during Random Assemble Editing.
- It is not possible to use Fade/Wipe effects and Programme AE with special effects during Random Assemble Editing using a DV cable.

AUTOMATIC EDITING TO VCR

11 Rewind the tape in the camcorder to the beginning of the scene you want to edit and press **PAUSE (II)** (23).

12 Point the remote control towards the VCR's remote sensor and press **VCR REC STBY (●II)** (25), or manually engage the VCR's Record-Pause mode.

13 Press the Recording Start/Stop Button (2) on the camcorder. Editing proceeds as programmed, right through to the end of the last registered scene.

- When dubbing is complete, the camcorder enters the Pause mode, and the VCR enters its Record-Pause mode.
- If you do not register an Edit-Out point, the tape will be dubbed all the way to the end automatically.
- If you operate the camcorder during automatic editing, the VCR will enter its Record-Pause mode and automatic editing will stop.

14 Engage the Stop modes for the camcorder and the VCR.

To make the R.A.Edit counter display disappear, press **R.A.EDIT ON/OFF** (24) on the remote control.

NOTES:

- Pressing **R.A.EDIT ON/OFF** (24) on the remote control clears all settings registered during Random Assemble Editing.
- When the editing cable is connected to the remote control's Pause In connector during dubbing, make sure the remote control is pointed at the VCR's sensor, and the path between the two is unobstructed.
- Random Assemble Editing may not function properly when using a tape including several duplicated time codes (see pg. 13).

For More Accurate Editing

Some VCRs make the transition from Record-Pause to Record mode faster than others. Even if you begin editing for the camcorder and the VCR at exactly the same time, you may lose scenes you wanted, or find that you have recorded scenes you did not want. For a cleanly edited tape, confirm and adjust the timing of the camcorder against your VCR.

DIAGNOSING VCR/CAMCORDER TIMING

1 Play back the tape in the camcorder, then point the remote control at the camcorder's remote sensor and press **R.A.EDIT ON/OFF** (24). The Random Assemble Editing Menu appears.

2 Perform Random Assemble Editing on Programme 1 only. In order to check VCR and camcorder timing, select the beginning of a scene transition as your Edit-In point.

3 Play back the dubbed scene.

- If any images from the scene prior to the transition you chose for your Edit-In point were recorded, that means your VCR moves too quickly from Record-Pause to Record mode.
- If the scene you tried to dub starts in progress, the VCR is slow to start recording.

ADJUSTMENT OF VCR/CAMCORDER TIMING

4 Point the remote control at the camcorder's remote sensor and press **R.A.EDIT ON/OFF** (24) to make the Random Assemble Editing menu disappear, then press the **MENU/VOLUME** wheel (1) in. The Menu Screen appears.

5 Rotate the **MENU/VOLUME** wheel (1) to select "VIDEO" and press it. Then, rotate it to "SYNCHRO" and press it. The value for "SYNCHRO" is highlighted.

6 Based on the diagnostics performed, you can now advance the VCR's record timing by rotating the **MENU/VOLUME** wheel (1) towards "+". You can also delay the VCR's record timing by rotating the **MENU/VOLUME** wheel (1) towards "-". The adjustment range is from -1.3 to +1.3 seconds, in 0.1-second increments. Press the **MENU/VOLUME** wheel (1) in to finish the setting.

7 Rotate the **MENU/VOLUME** wheel (1) to select "RETURN" and press it twice.

Now perform Random Assemble Editing beginning with step 4 on page 31.

NOTES:

- Before performing actual Random Assemble Editing, do a few Random Assemble Editing trial runs to check whether the value you have input is appropriate or not, and make adjustments accordingly.
- Depending on the recorder, there may be situations where the timing difference cannot be fully corrected.

Connection To A Personal Computer

[A] Using USB cable (GR-D50/D40 only)

It is possible to do the following things:

- Transfer still/moving images recorded on a tape to a PC.
- Capture still/moving images in real-time.
- Use this camcorder as a WebCam.

[B] Using DV cable

It is also possible to transfer still/moving images to a PC with a DV connector by using software equipped with the PC or commercially available software.

NOTES:

- Refer to "SOFTWARE INSTALLATION AND USB CONNECTION GUIDE" for the installation of the bundled software and drivers (GR-D50/D40 only).
- **It is recommended to use the AC Adapter as the power supply instead of the battery pack** (pg. 7).
- **Never connect the USB cable and the DV cable simultaneously to the camcorder. Connect only the cable you wish to use to the camcorder.**
- If the PC connected to the camcorder via the USB cable is not powered, the camcorder does not enter the USB mode (GR-D50/D40 only).
- The date/time information cannot be captured into the PC.
- Use the provided software PIXELA ImageMixer to capture video in real-time (GR-D50/D40 only).
- You can also use the camcorder for webconference by using Windows® Microsoft Netmeeting and signing up for Microsoft Hotmail (GR-D50/D40 only).
- Refer to the instruction manuals of the PC and Software.
- The still images can also be transferred to a PC with a DV connector-equipped capture board.
- **When using a DV cable, be sure to use the optional JVC VC-VDV206U or VC-VDV204U DV cable depending on the type of DV connector (4 or 6 pins) on the PC.**
- The system may not work properly depending on the PC or capture board you are using.
- When using the DV connection refer to manufacturer instructions of your capture board for driver's installation and operation instructions.

[A] Using USB cable (GR-D50/D40 only)

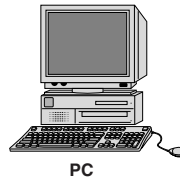
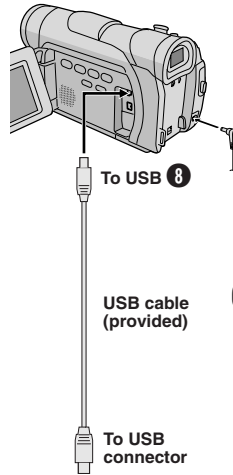

PC

[B] Using DV cable

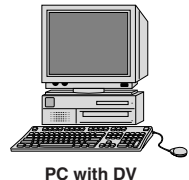
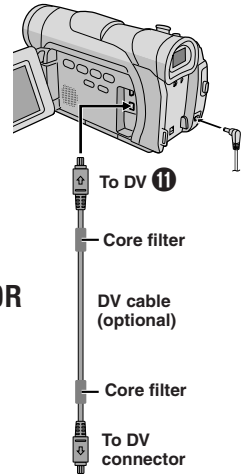

PC with DV connector

GR-D50/D40 only:

"ACCESSING FILES" appears on the LCD monitor while the PC is accessing data in the camcorder or the camcorder is transferring a file to the PC.

NEVER disconnect the USB cable while "ACCESSING FILES" is displayed on the LCD monitor since this can result in product damage.

Before consulting your JVC dealer, please check the following to see if you can correct the problem yourself.

The camcorder is a microcomputer-controlled device. External noise and interference (from a TV, a radio, etc.) might prevent it from functioning properly. In such cases, first disconnect its power supply unit (battery pack, AC Adapter, etc.) and wait a few minutes; and then re-connect it and proceed as usual from the beginning.

No power is supplied.

- The power is not connected properly.
 - Connect the AC Adapter securely (☞ pg. 7).
- The battery is dead.
 - Replace the dead battery with a fully charged one (☞ pg. 7, 8).

"SET DATE/TIME!" appears.

- The date/time is not set.
 - Set the date/time (☞ pg. 10).
- The built-in clock battery has run out and the previously set date/time has been erased.
 - Consult your nearest JVC dealer for replacement.

Recording cannot be performed.

- The tape's erase protection tab is set to "SAVE".
 - Set the tape's erase protection tab to "REC" (☞ pg. 9).
- The Power Switch **Ⓟ** is set to "PLAY" or "OFF (CHARGE)".
 - Set the Power Switch **Ⓟ** to "**A**" or "**M**" (☞ pg. 12).
- "TAPE END" appears.
 - Replace with new cassette (☞ pg. 9).
- The cassette holder cover is open.
 - Close the cassette holder cover.

There is no picture.

- The camcorder is not getting power, or some other malfunction exists.
 - Turn the camcorder's power off and on again (☞ pg. 12).

The focus does not adjust automatically.

- Focus is set to the Manual mode.
 - Set Focus to the Auto mode (☞ pg. 19).
- The recording was done in a dark place, or the contrast was low.
- The lens is dirty or covered with condensation.
 - Clean the lens and check the focus again (☞ pg. 38).

The cassette will not load properly.

- The cassette is in the wrong position.
 - Set it in the right position (☞ pg. 9).
- The battery's charge is low.
 - Install a fully charged battery (☞ pg. 7, 8).

Snapshot mode cannot be used.

- The Squeeze mode is selected.
 - Disengage the Squeeze mode (☞ pg. 22).

The colour of Snapshot looks strange.

- The light source or the subject does not include white. Or there are various different light sources behind the subject.
 - Find a white subject and compose your shot so that it also appears in the frame (☞ pg. 18).
- The Sepia or Monotone mode is activated.
 - Turn off Sepia and Monotone (☞ pg. 16).

The image taken using Snapshot is too dark.

- Shooting was performed under backlit conditions.
 - Press the **BACKLIGHT** Button **Ⓛ** (☞ pg. 19).

The image taken using Snapshot is too bright.

- The subject is too bright.
 - Set "PROGRAM AE" to "SPOTLIGHT" in the Menu Screen (☞ pg. 16).

Digital Zoom does not work.

- 16X optical zoom is selected.
 - Set "ZOOM" to "40X" or "700X" in the Menu Screen (☞ pg. 21).

The Black & White Fader does not work.

- The Sepia or Monotone mode is activated.
 - Turn off Sepia and Monotone (☞ pg. 16).

The image looks like the shutter speed is too slow.

- When shooting in the dark, the unit becomes highly sensitive to light when "GAIN UP" is set to "AUTO" in the Menu Screen.
- If you want the lighting to look more natural, set "GAIN UP" to "AGC" or "OFF" in the Menu Screen (📖 pg. 22).

White Balance cannot be activated.

- The Sepia or Monotone mode is activated.
- Turn off Sepia or Monotone before setting White Balance (📖 pg. 16, 20).

When shooting a subject illuminated by bright light, vertical lines appear.

- This is a result of exceedingly high contrast, and is not a malfunction.

When the screen is under direct sunlight during shooting, the screen becomes red or black for an instant.

- This is not a malfunction.

The date/time does not appear.

- "DATE/TIME" is set to "OFF" in the Menu Screen.
- Set "DATE/TIME" to "ON" in the Menu Screen (📖 pg. 23, 25).

Time code does not appear.

- "TIME CODE" is set to "OFF" in the Menu Screen.
- Set "TIME CODE" to "ON" in the Menu Screen (📖 pg. 24, 25).

Images on the LCD monitor appear dark or whitish.

- In places subject to low temperature, images become dark due to the characteristics of the LCD monitor. When this happens, the displayed colours differ from those that are actually recorded. This is not a defect of the camcorder.
- When the LCD monitor's fluorescent light reaches the end of its service life, images on the LCD monitor become dark. Consult your nearest JVC dealer.
- Adjust the brightness and angle of the LCD monitor (📖 pg. 11).

The rear of the LCD monitor is hot.

- The light used to illuminate the LCD monitor causes it to become hot.
- Close the LCD monitor to turn it off or set the Power Switch **(2)** to "OFF (CHARGE)", and let the unit cool down.

The indicators and the image colour on the LCD monitor are not clear.

- This may occur when the surface or the edge of the LCD monitor is pressed.

The LCD monitor or viewfinder indications blink.

- Certain Fade/Wipe effects, certain modes of Programme AE with special effects, "DIS" and other functions that cannot be used together are selected at the same time.
- Re-read the sections covering Fade/Wipe effects, Programme AE with special effects and "DIS" (📖 pg. 16, 17, 22).

Coloured bright spots appear all over the LCD monitor or the viewfinder.

- The LCD monitor and the viewfinder are made with high-precision technology. However, black spots or bright spots of light (red, green or blue) may appear constantly on the LCD monitor or the viewfinder. These spots are not recorded on the tape. This is not due to any defect of the unit. (Effective dots: more than 99.99 %)

During recording, sound cannot be heard.

- This is normal.

Play, Rewind and Fast-Forward functions do not work.

- The Power Switch **(2)** is set to "A" or "M".
- Set the Power Switch **(2)** to "PLAY" (📖 pg. 13).

The LCD monitor image is distorted.

- During playback of the unrecorded portion, High-speed Search and still playback, LCD monitor indications appear distorted. This is not a defect.

Images on the LCD monitor are jittery.

- The speaker volume is too great.
→ Turn the speaker volume down (🔧 pg. 13).

There is no playback picture on the connected TV.

- Since the analogue input mode is engaged, the camcorder is in the Record-Standby mode.
→ Set "S/AV INPUT" to "OFF" in the Menu Screen (🔧 pg. 24).

Blocks of noise appear during playback, or there is no playback picture and the screen becomes blue.

- Clean the video heads with an optional cleaning cassette (🔧 pg. 38).

The LCD monitor, the viewfinder and the lens have become dirty (ex. fingerprints).

- Wipe them gently with soft cloth. Wiping strongly can cause damage (🔧 pg. 38).

An unusual mark appears.

- Check the section of the manual that explains LCD monitor/viewfinder indications (🔧 pg. 42 – 44).

An error indication (E01, E02 or E06) appears.

- A malfunction of some kind has occurred. In this case the camcorder's functions become unusable.
→ Remove the power supply (battery pack, etc.) and wait a few minutes for the indication to clear. When it does, you can resume using the camcorder. If the indication remains even though you repeat the above two or three times, please consult your nearest JVC dealer. Do not eject the cassette. This will cause damage to the tape.

An error indication (E03 or E04) appears.

- A malfunction of some kind has occurred. In this case the camcorder's functions become unusable.
→ Eject the cassette once and re-insert it, then check if the indication clears. When it does, you can resume using the camcorder. If the indication remains even though you repeat the above two or three times, please consult your nearest JVC dealer.

The charger indicator on the camcorder does not light.

- The temperature of the battery is extremely high/low.
- Charging is difficult in places subject to extremely high/low temperatures.
→ To protect the battery, it is recommended to charge it in places with a temperature of 10°C to 35°C (🔧 pg. 37).

When the image is printed from the printer, a black bar appears at the bottom of the screen.

- This is not a malfunction.
→ By recording with "DIS" activated (🔧 pg. 22) this can be avoided.

When the camcorder is connected via the DV connector, the camcorder does not operate.

- The DV cable was plugged/unplugged with power turned on.
→ Turn the camcorder's power off and on again, then operate it.

Battery Packs

The supplied battery pack is a lithium-ion battery. Before using the supplied battery pack or an optional battery pack, be sure to read the following cautions:

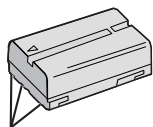

Terminals

1. To avoid hazards . . .

- ... do not burn.
- ... do not short-circuit the terminals. When transporting, make sure the provided battery cap is attached to the battery. If the battery cap is misplaced, carry the battery in a plastic bag.
- ... do not modify or disassemble.
- ... do not expose the battery to temperatures exceeding 60°C, as this may cause the battery to overheat, explode or catch fire.
- ... use only specified chargers.

2. To prevent damage and prolong service life . . .

- ... do not subject to unnecessary shock.
- ... charge in an environment where temperatures are within the tolerances shown in the chart below. This is a chemical reaction type battery—cooler temperatures impede chemical reaction, while warmer temperatures can prevent complete charging.
- ... store in a cool, dry place. Extended exposure to high temperatures will increase natural discharge and shorten service life.
- ... fully charge and then fully discharge the battery every 6 months when storing the battery pack over a long period time.
- ... remove from charger or powered unit when not in use, as some machines use current even when switched off.

NOTES:

- It is normal for the battery pack to be warm after charging, or after use.

Temperature Range Specifications

Charging 10°C to 35°C

Operation 0°C to 40°C

Storage -10°C to 30°C

- Recharging time is based on room temperature of 20°C.
- The lower the temperature, the longer recharging takes.

Cassettes

To properly use and store your cassettes, be sure to read the following cautions:

1. During use . . .

- ... make sure the cassette bears the Mini DV mark.
- ... be aware that recording onto prerecorded tapes automatically erases the previously recorded video and audio signals.
- ... make sure the cassette is positioned properly when inserting.
- ... do not load and unload the cassette repeatedly without allowing the tape to run at all. This slackens the tape and can result in damage.
- ... do not open the front tape cover. This exposes the tape to fingerprints and dust.

2. Store cassettes . . .

- ... away from heaters or other heat sources.
- ... out of direct sunlight.
- ... where they won't be subject to unnecessary shock or vibration.
- ... where they won't be exposed to strong magnetic fields (such as those generated by motors, transformers or magnets).
- ... vertically, in their original cases.

LCD Monitor

1. To prevent damage to the LCD monitor, DO NOT . . .

- ... push it strongly or apply any shocks.
- ... place the camcorder with the LCD monitor on the bottom.

2. To prolong service life . . .

- ... avoid rubbing it with coarse cloth.

3. Be aware of the following phenomena for LCD monitor use.

These are not malfunctions:

- While using the camcorder, the surface around the LCD monitor and/or the back of the LCD monitor may heat up.
- If you leave power on for a long time, the surface around the LCD monitor becomes hot.

Main Unit

1. For safety, DO NOT . . .

- ... open the camcorder's chassis.
- ... disassemble or modify the unit.
- ... short-circuit the terminals of the battery pack. Keep it away from metallic objects when not in use.
- ... allow inflammables, water or metallic objects to enter the unit.
- ... remove the battery pack or disconnect the power supply while the power is on.
- ... leave the battery pack attached when the camcorder is not in use.

2. Avoid using the unit . . .

- ... in places subject to excessive humidity or dust.
- ... in places subject to soot or steam such as near a cooking stove.
- ... in places subject to excessive shock or vibration.
- ... near a television set.
- ... near appliances generating strong magnetic or electric fields (speakers, broadcasting antennas, etc.).
- ... in places subject to extremely high (over 40°C) or extremely low (under 0°C) temperatures.

3. DO NOT leave the unit . . .

- ... in places of over 50°C.
- ... in places where humidity is extremely low (below 35%) or extremely high (above 80%).
- ... in direct sunlight.
- ... in a closed car in summer.
- ... near a heater.

4. To protect the unit, DO NOT . . .

- ... allow it to become wet.
- ... drop the unit or strike it against hard objects.
- ... subject it to shock or excessive vibration during transportation.
- ... keep the lens directed at extremely bright objects for long periods.
- ... expose the lens to direct sunlight.
- ... carry it by holding the LCD monitor or the viewfinder.
- ... swing it excessively when using the shoulder strap or the grip.

5. Dirty heads can cause the following problems:

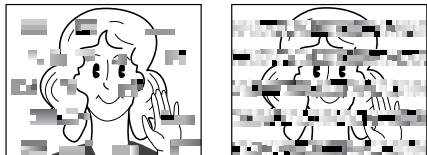

- No picture during playback.
- Blocks of noise appear during playback.
- During recording or playback, the Head Clog Warning indicator “⊗” appears.
- Recording cannot be performed properly.

In such cases, use an optional cleaning cassette. Insert it and play back. If the cassette is used more than once consecutively, damage to the video heads may result. After the camcorder plays back for about 20 seconds, it stops automatically. Also refer to the cleaning cassette's instructions. If, after using the cleaning cassette, the problems still exist, consult your nearest JVC dealer. Mechanical moving parts used to move the video heads and video tape tend to become dirty and worn out over time. In order to maintain a clear picture at all times, periodic check-ups are recommended after using the unit for about 1,000 hours. For periodic check-ups please consult your nearest JVC dealer.

How to handle a CD-ROM

- Take care not to soil or scratch the mirror surface (opposite to the printed surface). Do not write anything or put a sticker on either the front or back surface. If the CD-ROM gets dirty, gently wipe it with a soft cloth outward from the centre hole using a circular motion.
- Do not use conventional disc cleaners or cleaning spray.
- Do not bend the CD-ROM or touch its mirror surface.
- Do not store your CD-ROM in a dusty, hot or humid environment. Keep it away from direct sunlight.

About moisture condensation . . .

- You have observed that pouring a cold liquid into a glass will cause drops of water to form on the glass outer surface. This same phenomenon occurs on the head drum of a camcorder when it is moved from a cool place to a warm place, after heating a cold room, under extremely humid conditions or in a place directly subjected to the cool air from an air conditioner.
- Moisture on the head drum can cause severe damage to the video tape, and can lead to internal damage to the camcorder itself.



Serious malfunctioning

If malfunctioning occurs, stop using the unit immediately and consult your local JVC dealer.

The camcorder is a microcomputer-controlled device. External noise and interference (from a TV, a radio, etc.) might prevent it from functioning properly. In such cases, first disconnect its power supply unit (battery pack, AC Adapter, etc.) and wait a few minutes and then re-connect it and proceed as usual from the beginning.

For Your Maintenance

1) After Use

1. Turn off the camcorder.
2. Slide and hold **OPEN/EJECT**  in the direction of the arrow, then pull the cassette holder cover open until it locks. The cassette holder opens automatically. Remove the cassette.
3. Press “PUSH HERE” to close the cassette holder.
 - Once the cassette holder is closed, it recedes automatically. Wait until it recedes completely before closing the cassette holder cover.
4. Tilt the viewfinder upward. Press **BATT. RELEASE**  and remove the battery pack.

2) Cleaning The Camcorder

1. To clean the exterior, wipe gently with a soft cloth. Put the cloth in diluted mild soap and wring it well to wipe off heavy dirt. Then wipe again with a dry cloth.
2. Open the LCD monitor. Wipe gently with a soft cloth. Be careful not to damage the monitor. Close the LCD monitor.
3. To clean the lens, blow it with a blower brush, then wipe gently with lens cleaning paper.

NOTES:

- Avoid using strong cleaning agents such as benzine or alcohol.
- Cleaning should be done only after the battery pack has been removed or other power units have been disconnected.
- Mould may form if the lens is left dirty.
- When using a cleaner or chemically treated cloth refer to the cautions of each product.

Camcorder

General

Power supply : DC 11.0 V $\overline{\text{---}}$ (Using AC Adapter)
DC 7.2 V $\overline{\text{---}}$ (Using battery pack)

Power consumption

**LCD monitor off,
viewfinder on** : Approx. 3.4 W

**LCD monitor on,
viewfinder off** : Approx. 4.7 W

Dimensions

(W x H x D) : 69 mm x 94 mm x 143 mm
(with the LCD monitor closed and
the viewfinder pushed back in)

Weight : Approx. 525 g

**Operating
temperature** : 0°C to 40°C

**Operating
humidity** : 35% to 80%

**Storage
temperature** : -20°C to 50°C

Pickup : 1/6" CCD

Lens : F 1.6, f = 2.7 mm to 43.2 mm,
16:1 power zoom lens

Filter diameter : \varnothing 37 mm

LCD monitor : 2.5" diagonally measured, LCD
panel/TFT active matrix system

Viewfinder : Electronic viewfinder with 0.24"
black/white LCD

Speaker : Monaural

Digital Video Camera

Format : DV format (SD mode)

Signal format : PAL standard

Recording/

Playback format : Video: Digital component recording
: Audio: PCM digital recording,
32 kHz 4-channel (12-bit),
48 kHz 2-channel (16-bit)

Cassette : Mini DV cassette

Tape speed : SP : 18.8 mm/s
LP : 12.5 mm/s

Maximum

recording time : SP : 80 min.
**(using 80 min.
cassette)** LP : 120 min.

Connectors

S-Video

Output : Y : 1 V (p-p), 75 Ω , analogue
C : 0.29 V (p-p), 75 Ω , analogue

Input* : Y : 0.8 V (p-p) – 1.2 V (p-p), 75 Ω ,
analogue
C : 0.2 V (p-p) – 0.4 V (p-p), 75 Ω ,
analogue

AV

Video output : 1 V (p-p), 75 Ω , analogue

Video input* : 0.8 V (p-p) – 1.2 V (p-p), 75 Ω ,
analogue

Audio output : 300 mV (rms), 1 k Ω , analogue,
stereo

Audio input* : 300 mV (rms), 50 k Ω , analogue,
stereo

DV

Output : 4-pin, IEEE 1394 compliant

Input* : 4-pin, IEEE 1394 compliant

USB**

: 5-pin

EDIT

: \varnothing 3.5 mm, 2-pole

* GR-D50/D30 only

** GR-D50/D40 only

AC Adapter

Power requirement : AC 110 V to 240 V \sim , 50 Hz/60 Hz

Output : DC 11 V $\overline{\text{---}}$, 1 A

Specifications shown are for SP mode unless otherwise indicated. E & O.E. Design and specifications subject to change without notice.

Controls, Connectors And Indicators

Refer to this diagram while reading the instructions.

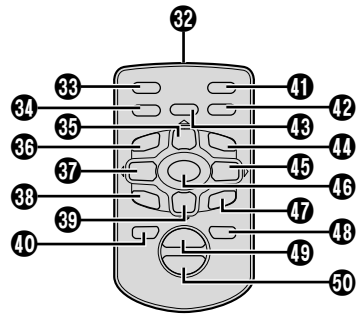
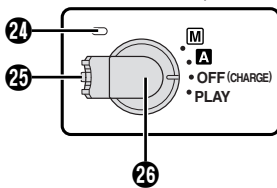
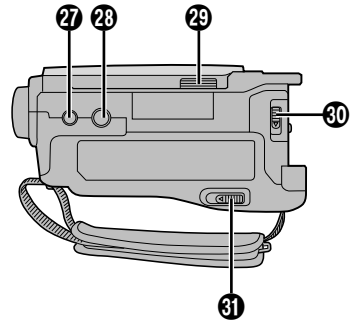
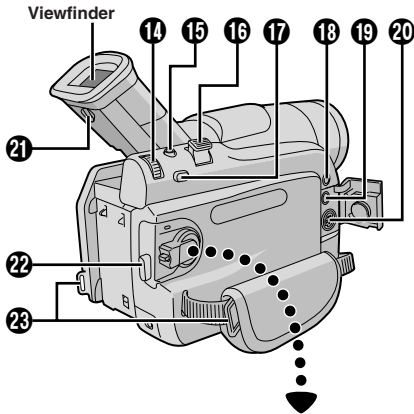
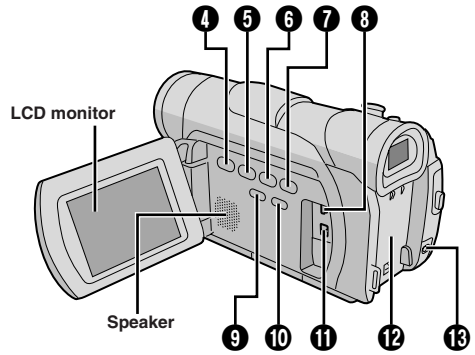
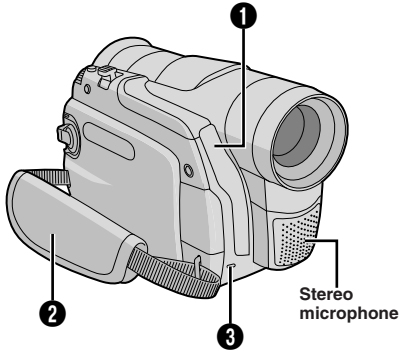

Remote Control

1 • Remote Sensor	
The transmitted beam's approximate effective distance for indoor use is 5m.	
The transmitted beam may not be effective or may cause incorrect operation outdoors or when the remote sensor is directly exposed to sunlight or powerful lighting.	
• Camera Sensor	
Be careful not to cover this area, a sensor necessary for shooting is built-in here.	
2 Grip Strap	pg. 8
3 Tally Lamp	pg. 11, 23
4 Stop Button [■]	pg. 13
5 Rewind Button [◀◀]	pg. 13
6 Play/Pause Button [▶/]	pg. 13
7 Fast-Forward Button [▶▶]	pg. 13
8 USB (Universal Serial Bus) Connector (GR-D50/D40 only)	pg. 33
9 NIGHT Button	pg. 16
10 BACKLIGHT Button	pg. 19
11 Digital Video Input (GR-D50/D30 only)/ Output Connector [DV] (i.Link*)	pg. 27, 33
* i.Link refers to the IEEE1394-1995 industry specification and extensions thereof. The  logo is used for products compliant with the i.Link standard.	
12 Battery Pack Mount	pg. 7
13 DC Input Connector	pg. 7
14 • MENU Wheel [+ , -]	pg. 21
• Speaker Volume Control [VOLUME]	pg. 13
15 Snapshot Button [SNAPSHOT]	pg. 18
16 Power Zoom Lever [T/W]	pg. 12
17 • FOCUS Button	pg. 19
• BLANK SEARCH Button	pg. 14
18 Audio/Video Input (GR-D50/D30 only)/ Output Connector [AV]	pg. 15, 26, 31
19 Edit Connector [EDIT]	pg. 31
20 S-Video Input (GR-D50/D30 only)/ Output Connector [S-VIDEO]	pg. 15, 26, 31
21 Dioptre Adjustment Control	pg. 8
22 Recording Start/Stop Button	pg. 11
23 Shoulder Strap Eyelets	pg. 9
24 POWER/CHARGE Lamp	pg. 7, 11, 12
25 Lock Button	pg. 12
26 Power Switch [A, M, PLAY, OFF (CHARGE)]	pg. 12
27 Stud Hole	pg. 9
28 Tripod Mounting Socket	pg. 9
29 Monitor Latch [OPEN]	pg. 11
30 Battery Release Button [BATT. RELEASE]	pg. 7
31 OPEN/EJECT Switch	pg. 9
32 Infrared Beam Transmitting Window	Transmits the beam signal.
33 Snapshot Button* [S. SHOT]	
34 Audio Monitor Button [AUDIO]	pg. 25
35 • PAUSE Button*	
• Up Button	pg. 28
36 SLOW Button [◀I]	pg. 28
37 • REW Button*	
• Left Button	pg. 28
38 INSERT Button	pg. 29
39 • STOP Button*	
• Down Button	pg. 28
40 SHIFT Button	pg. 28
41 START/STOP Button*	
42 ON/OFF Button	pg. 28
43 EFFECT Button	pg. 28
44 SLOW Button [I▶]	pg. 28
45 • FF Button*	
• Right Button	pg. 28
46 PLAY Button*	
47 A. DUB Button	pg. 29
48 DISPLAY Button	pg. 15, 26
49 Zoom (T) Button	pg. 12, 28
50 Zoom (W) Button	pg. 12, 28

* Functions the same as each corresponding button on the camcorder.

The connectors **19**, **20** are located beneath a cover.

During Tape Recording

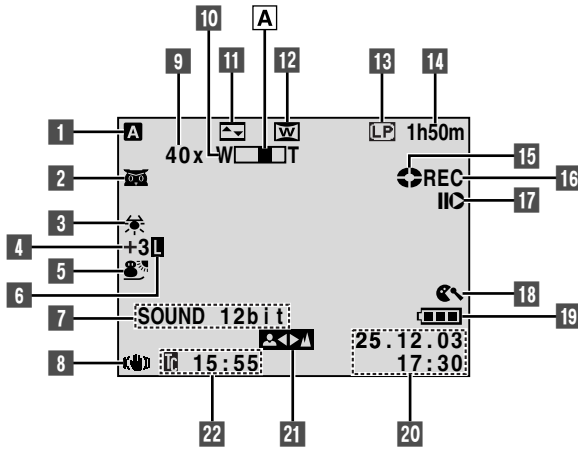

During Tape Playback

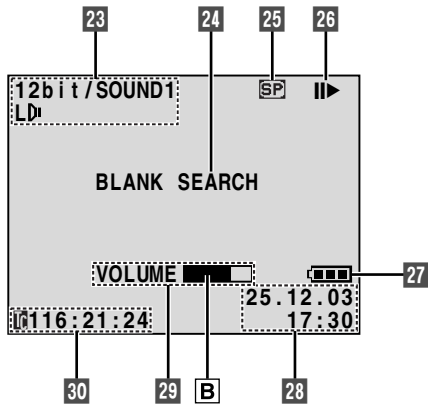

- 1** Appears when the Power Switch is set to “**A**” pg. 12
- 2** • : Appears when Night-Scope is engaged pg. 16
- **A** : Appears when “GAIN UP” is set to “AUTO” and the shutter speed is being automatically adjusted pg. 22
- 3** Appears when the white balance is adjusted pg. 20
- 4** • “±” : Appears when the exposure is adjusted pg. 19
- : Appears when backlight compensation is used pg. 19
- 5** Displays the selected Programme AE with special effects pg. 16
- 6** Appears when the iris is locked pg. 20
- 7** • **SOUND**: Displays the sound mode for approx. 5 seconds after turning on the camcorder.. pg. 21
- **BRIGHT**: Displays the brightness of the LCD monitor pg. 11
- 8** Appears when Digital Image Stabiliser (“DIS”) is engaged pg. 22
- 9** Approximate zoom ratio: Appears during zooming pg. 12
- 10** Appears during zooming
- Zoom level indicator pg. 12
- 11** Displays the selected Fade/Wipe effect pg. 17
- 12** Appears when in the Squeeze or Cinema mode pg. 22
- 13** Displays the recording mode (SP or LP) ... pg. 10
- 14** Displays the tape remaining time pg. 11
- 15** Rotates while the tape is running pg. 11
- 16** • “REC” appears during recording
- “PAUSE” appears during Record-Standby mode pg. 11
- **PHOTO**: Appears when taking a Snapshot pg. 18
- 17** Appears when the Insert Editing () or Insert Editing Pause () mode is engaged pg. 29
- 18** Appears when the wind cut mode is engaged to cut down on noise created by wind pg. 22
- 19** Displays the battery remaining power level. pg. 44
- 20** Displays the date/time pg. 10, 23, 25
- 21** Appears when the focus is adjusted manually pg. 18, 19
- 22** Displays the Time Code pg. 13, 24
- 23** Displays the sound mode pg. 24, 25
- 24** Displays the Blank Search mode pg. 14
- 25** Displays the tape speed pg. 10
- 26** Appears while a tape is running
- ▶ : Playback
- ▶▶ : Fast-Forward/Shuttle Search
- ◀◀ : Rewind/Shuttle Search
- ⏸ : Pause
- ▶▶▶ : Forward Frame-By-Frame Playback/Slow-Motion
- ◀◀◀ : Reverse Frame-By-Frame Playback/Slow-Motion
- 🎤 : Audio Dubbing
- ⏸🎤 : Audio Dubbing Pause
- 27** Displays the battery remaining power level. pg. 44
- 28** Displays the date/time pg. 23, 25
- 29** • **BRIGHT** : Displays the brightness of the LCD monitor pg. 11
- **VOLUME** : Displays the speaker volume pg. 13
- The level indicator moves.
- 30** Displays the time code pg. 24, 25

WARNING INDICATIONS

(high) → → → (exhausted)

Displays the battery remaining power level. As the battery power comes close to nil, the battery indicator  blinks (battery power warning). When the battery power is exhausted, power turns off automatically.



Appears when no tape is loaded. (📖 pg. 9)

CHECK TAPE'S ERASE PROTECTION TAB

Appears when the erase protection tab is set to "SAVE" while the Power Switch  is set to "A" or "M".

(📖 pg. 9)



HEAD CLEANING REQUIRED USE CLEANING CASSETTE

Appears if dirt is detected on the heads during recording or playback. Use an optional cleaning cassette. (📖 pg. 38)

CONDENSATION, OPERATION PAUSED PLEASE WAIT

Appears if condensation occurs. When this indication is displayed, wait more than 1 hour until condensation disappears.

TAPE!

Appears if a tape is not loaded when the Recording Start/Stop Button  or SNAPSHOT Button  is pressed while the Power Switch  is set to "A" or "M".

TAPE END

Appears when the tape ends during recording or playback.

SET DATE/TIME!

- Appears when the date/time is not set. (📖 pg. 10)
- Appears when the built-in clock battery runs out and the previously set date/time is erased. Consult your nearest JVC dealer for replacement.



LENS CAP

Appears for 5 seconds after power is turned on if the lens cap is attached.

A. DUB ERROR!

Appears if Audio Dubbing is attempted on a blank portion of a tape. (📖 pg. 29)

A. DUB ERROR! <CANNOT DUB ON A LP RECORDED TAPE> <CANNOT DUB ON A 16BIT RECORDING> <CHECK TAPE'S ERASE PROTECTION TAB>



- Appears if Audio Dubbing is attempted on a tape recorded in the LP mode.
- Appears if Audio Dubbing is attempted on a tape recorded in 16-bit audio.
- Appears if A. DUB   on the remote control is pressed when the erase protection tab is set to "SAVE". (📖 pg. 29)

INSERT ERROR!

Appears if Insert Editing is attempted on a blank portion of a tape. (📖 pg. 29)

INSERT ERROR!

<CANNOT EDIT ON A LP RECORDED TAPE> <CHECK TAPE'S ERASE PROTECTION TAB>

- Appears if Insert Editing is attempted on a tape recorded in the LP mode.
- Appears if INSERT   on the remote control is pressed when the erase protection tab is set to "SAVE". (📖 pg. 29)

E01, E02 or E06 UNIT IN SAFEGUARD MODE REMOVE AND REATTACH BATTERY

The error indications (E01, E02 or E06) show what type of malfunction has occurred. When an error indication appears, the camcorder turns off automatically. Remove the power supply (battery, etc.) and wait a few minutes for the indication to clear. When it does, you can resume using the camcorder. If the indication remains, consult your nearest JVC dealer.

E03 or E04 UNIT IN SAFEGUARD MODE EJECT AND REINSERT TAPE

The error indications (E03 or E04) show what type of malfunction has occurred. When an error indication appears, the camcorder turns off automatically. Eject the cassette once and re-insert it, then check if the indication clears. When it does, you can resume using the camcorder. If the indication remains, consult your nearest JVC dealer.

Using The Optional RM-V717U Remote Control Unit

The RM-V717U remote control unit is provided with the optional Remote Control kit RM-V717KITU, that also contains the Editing Cable required for Random Assemble Editing (☞ pg. 31).

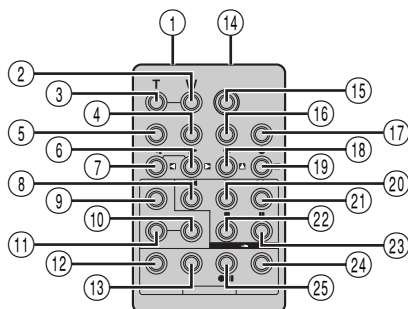
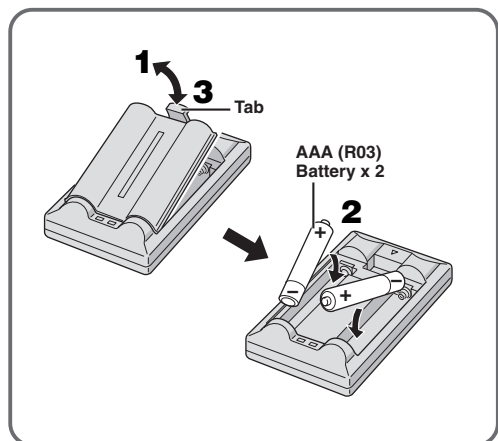

RM-V717U
(optional)

- ① Infrared Beam Transmitting Window
Transmits the beam signal.
- ② Zoom (W) Button*
- ③ Zoom (T) Button*
- ④ DISPLAY Button*
- ⑤ SHIFT Button ☞ pg. 28, 30
- ⑥ • SLOW Button* [▶]
- Right Button*
- ⑦ • SLOW Button* [◀]
- Left Button*
- ⑧ REW Button*
- ⑨ FADE/WIPE Button ☞ pg. 31
- ⑩ EFFECT ON/OFF Button*
- ⑪ EFFECT Button*
- ⑫ EDIT IN/OUT Button ☞ pg. 31
- ⑬ CANCEL Button ☞ pg. 31
- ⑭ PAUSE IN Connector ☞ pg. 31
- ⑮ START/STOP Button*
- ⑯ MBR SET Button ☞ pg. 30
- ⑰ Snapshot Button* [SNAPSHOT]
- ⑱ • Up Button*
- INSERT Button*
- ⑲ • Down Button*
- A. DUB Button*
- ⑳ PLAY Button*
- ㉑ FF Button*
- ㉒ STOP Button*
- ㉓ PAUSE Button*
- ㉔ R.A.EDIT ON/OFF Button ☞ pg. 31, 32
- ㉕ VCR REC STBY Button ☞ pg. 32

* Functions the same as each corresponding button on the provided remote control RM-V718U (☞ pg. 40, 41).

A	
AC Adapter	pg. 7, 8
Analogue Input	pg. 24, 26
Audio Dubbing	pg. 29
Auto Date	pg. 23
Auto Focus	pg. 18
Auto Shut off	pg. 11, 14
B	
Backlight Compensation	pg. 19
Battery Low	pg. 44
Battery Pack	pg. 7, 8, 37
Beep	pg. 23
Blank Search	pg. 14
Brighten The LCD Monitor	pg. 11
C	
Channels (Left/Right)	pg. 25
Charge The Battery Pack	pg. 7
Cinema	pg. 22
Classic Film	pg. 16
Clean The Camcorder	pg. 38
Connections	pg. 7, 15, 26, 27, 31, 33
D	
Darken The LCD Monitor	pg. 11
Date/Time Display	pg. 23 – 25
Date/Time Settings	pg. 10
Demonstration Mode	pg. 6, 23
Digital Zoom	pg. 12, 21
DIS (Digital Image Stabiliser)	pg. 22
Dioptr Adjustment	pg. 8
Dubbing	pg. 26, 27
E	
Erase Protection	pg. 9
Exposure Control	pg. 19
F	
Fade-In/Out	pg. 17
Fast-Forward The Tape	pg. 13
Frame-By-Frame Playback	pg. 28
G	
Gain Up	pg. 22
Grip Adjustment	pg. 8
I	
Icons	pg. 21 – 25
Insert Editing	pg. 29
Iris	pg. 20
Iris Lock	pg. 20
J	
Journalistic Shooting	pg. 12
L	
LCD monitor/Viewfinder Indications	pg. 42 – 44
Load A Tape	pg. 9
M	
Maintenance	pg. 38
Manual Focus	pg. 19
Menu Screen, CAMERA	pg. 21, 22
Menu Screen, CAMERA DISPLAY	pg. 23, 24
Menu Screen, MANUAL	pg. 22
Menu Screen, SYSTEM	pg. 23
Menu Screen, VIDEO	pg. 24
Menu Screen, VIDEO DISPLAY	pg. 25
Monotone	pg. 16
Motor Drive Mode	pg. 18
N	
Night-Scope	pg. 16
P	
Playback Special Effects	pg. 28
Playback Zoom	pg. 28
Power-Linked Operation	pg. 12
Power Switch Position	pg. 12
Programme AE With Special Effects	pg. 16
Provided Accessories	pg. 5
R	
Random Assemble Editing	pg. 30 – 32
Record-Standby	pg. 11
Recording Mode	pg. 10
Remote Control	pg. 5, 28
Reset	pg. 23
Rewind The Tape	pg. 13

S

Self-Recording	☞	pg. 12
Sepia	☞	pg. 16
Set Remote Control/VCR Code	☞	pg. 30
Shuttle Search	☞	pg. 13
Shutter Speed	☞	pg. 16
Slow-Motion Playback	☞	pg. 13, 28
Snapshot	☞	pg. 18
Snapshot Mode	☞	pg. 18
Snow	☞	pg. 16
Sound Mode	☞	pg. 21, 24, 25
Speaker Volume	☞	pg. 13
Specifications	☞	pg. 39
Sports	☞	pg. 16
Spotlight	☞	pg. 16
Squeeze	☞	pg. 22
Still Playback	☞	pg. 13
Strobe	☞	pg. 16

T

Tally	☞	pg. 23
Tele Macro	☞	pg. 22
Time Code	☞	pg. 13, 23 – 25
Tripod Mounting	☞	pg. 9
Twilight	☞	pg. 16

U

Unload A Tape	☞	pg. 9
---------------------	---	-------

W

White Balance	☞	pg. 20
Wide Mode	☞	pg. 22
Wind Cut	☞	pg. 22
Wipe In/Out	☞	pg. 17

Z

Zooming	☞	pg. 12
---------------	---	--------



Free Manuals Download Website

<http://myh66.com>

<http://usermanuals.us>

<http://www.somanuals.com>

<http://www.4manuals.cc>

<http://www.manual-lib.com>

<http://www.404manual.com>

<http://www.luxmanual.com>

<http://aubethermostatmanual.com>

Golf course search by state

<http://golfingnear.com>

Email search by domain

<http://emailbydomain.com>

Auto manuals search

<http://auto.somanuals.com>

TV manuals search

<http://tv.somanuals.com>