

JVC

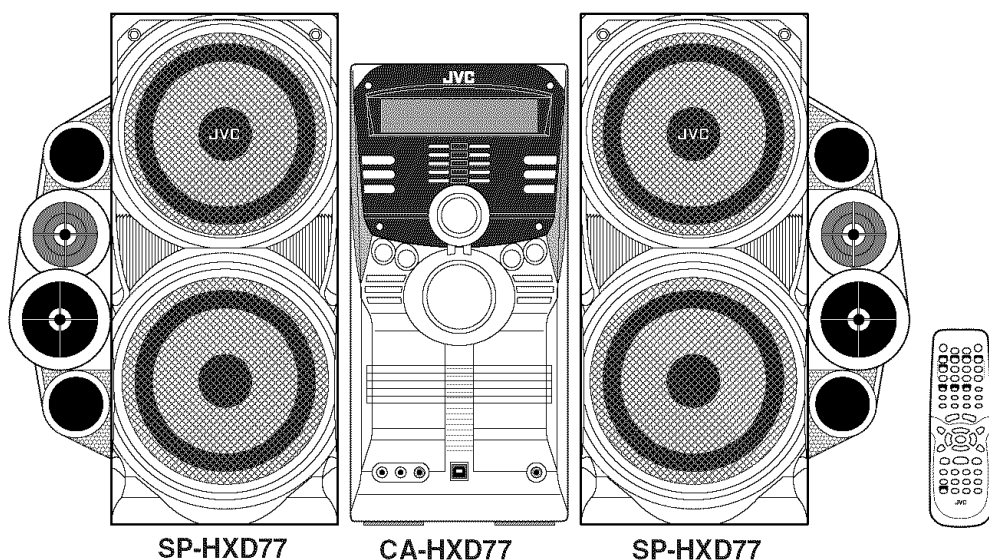

COMPACT COMPONENT SYSTEM

HX-D77

 —Consists of CA-HXD77 and SP-HXD77

INSTRUCTIONS

For Customer Use:

Enter below the Model No. and Serial No. which are located either on the rear, bottom or side of the cabinet. Retain this information for future reference.

Model No. _____

Serial No. _____

LVT1540-001A

[J]

Warnings, Cautions and Others

Mises en garde, précautions et indications diverses

	CAUTION RISK OF ELECTRIC SHOCK DO NOT OPEN	
CAUTION: TO REDUCE THE RISK OF ELECTRIC SHOCK, DO NOT REMOVE COVER (OR BACK). NO USER SERVICEABLE PARTS INSIDE. REFER SERVICING TO QUALIFIED SERVICE PERSONNEL.		

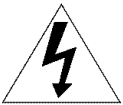

The lightning flash with arrowhead symbol, within an equilateral triangle is intended to alert the user to the presence of uninsulated "dangerous voltage" within the product's enclosure that may be of sufficient magnitude to constitute a risk of electric shock to persons.



The exclamation point within an equilateral triangle is intended to alert the user to the presence of important operating and maintenance (servicing) instructions in the literature accompanying the appliance.

WARNING: TO REDUCE THE RISK OF FIRE OR ELECTRIC SHOCK, DO NOT EXPOSE THIS APPLIANCE TO RAIN OR MOISTURE.

CAUTION

To reduce the risk of electrical shocks, fire, etc.:

- 1 Do not remove screws, covers or cabinet.
- 2 Do not expose this appliance to rain or moisture.

ATTENTION

Afin d'éviter tout risque d'électrocution, d'incendie, etc.:

- 1 Ne pas enlever les vis ni les panneaux et ne pas ouvrir le coffret de l'appareil.
- 2 Ne pas exposer l'appareil à la pluie ni à l'humidité.

Caution—STANDBY/ON button!

Disconnect the mains plug to shut the power off completely (the STANDBY lamp goes off). When installing the apparatus, ensure that the plug is easily accessible.

The STANDBY/ON  button in any position does not disconnect the mains line.

- When the unit is on standby, the STANDBY lamp lights red.
- When the unit is turned on, the STANDBY lamp goes off.

The power can be remote controlled.

Attention—Touch STANDBY/ON button!

Déconnectez la fiche d'alimentation secteur pour mettre l'appareil complètement hors tension (le témoin STANDBY est éteint). Lors de l'installation de l'appareil, assurez-vous que la fiche soit facilement accessible.

La touche STANDBY/ON  , dans n'importe quelle position, ne déconnecte pas l'appareil du secteur.

- Quand l'appareil est en mode d'attente, le témoin STANDBY est allumé en rouge.
- Quand l'appareil est sous tension, le témoin STANDBY est éteint.

L'alimentation peut être télécommandée.

For U.S.A.

This equipment has been tested and found to comply with the limits for a Class B digital device, pursuant to part 15 of the FCC Rules. These limits are designed to provide reasonable protection against harmful interference in a residential installation.

This equipment generates, uses and can radiate radio frequency energy and, if not installed and used in accordance with the instructions, may cause harmful interference to radio communications.

However, there is no guarantee that interference will not occur in a particular installation. If this equipment does cause harmful interference to radio or television reception, which can be determined by turning the equipment off and on, the user is encouraged to try to correct the interference by one of the following measures:

Reorient or relocate the receiving antenna.

Increase the separation between the equipment and receiver.

Connect the equipment into an outlet on a circuit different from that to which the receiver is connected.

Consult the dealer or an experienced radio/TV technician for help.

CAUTION

Changes or modifications not approved by JVC could void the user's authority to operate the equipment.

For U.S.A.

For the main unit:

Declaration of Conformity

Model Number: HX-D77

Trade Name: JVC

Responsible Party: JVC Americas Corp.

Address: 1700 Valley Road, Wayne
New Jersey 07470

Telephone Number: 973-317-5000

This device complies with Part 15 of FCC Rules.

Operation is subject to the following two conditions:

- (1) This device may not cause harmful interference, and
- (2) this device must accept any interference received, including interference that may cause undesired operation.

For Canada/pour le Canada

This class B digital apparatus complies with Canadian ICES-003.

Cet appareil numérique de la classe B est conforme à la norme NMB-003 du Canada.

Note to CATV system installer:

This reminder is provided to call the CATV system installer's attention to Section 820-40 of the NEC which provides guidelines for proper grounding and, in particular, specifies that the cable ground shall be connected to the grounding system of the building, as close to the point of cable entry as practical.



24 kg / 53 lbs.

CAUTION!

To avoid personal injury or accidentally dropping the unit, have two persons unpack, carry, and install the unit.

ATTENTION!

Pour éviter toute blessure personnelle ou chute accidentelle de l'appareil, faites déballer, transporter et installer l'appareil par deux personnes.

IMPORTANT FOR LASER PRODUCTS

- 1 CLASS 1 LASER PRODUCT
- 2 **CAUTION:** Do not open the top cover. There are no user serviceable parts inside the Unit; leave all servicing to qualified service personnel.
- 3 **CAUTION:** Visible and/or invisible class 1M laser radiation when open. Do not view directly with optical instruments.

IMPORTANT POUR PRODUITS LASER

- 1 PRODUIT LASER CLASSE 1
- 2 **ATTENTION:** N'ouvrez pas le couvercle supérieur. Il n'y a aucune pièce réparable par l'utilisateur à l'intérieur de l'appareil; confiez toute réparation à un personnel qualifié.
- 3 **ATTENTION:** Rayonnement laser visible et/ou invisible de classe 1M une fois ouvert. Ne pas regarder directement avec des instruments optiques.



[European Union only]
[Union européenne uniquement]

CAUTION: Proper Ventilation

To avoid risk of electric shock and fire, and to prevent damage, locate the apparatus as follows:

1. Front: No obstructions and open spacing.
2. Sides/Top/Back: No obstructions should be placed in the areas shown by the dimensions below.
3. Bottom: Place on a level surface. Maintain an adequate air path for ventilation by placing on a stand with a height of 10 cm or more.

Attention: Aération correcte

Pour prévenir tout risque de décharge électrique ou d'incendie et éviter toute détérioration, installez l'appareil de la manière suivante:

1. Avant: Bien dégagé de tout objet.
2. Côtés/dessus/dessous: Assurez-vous que rien ne bloque les espaces indiqués sur le schéma ci-dessous.
3. Dessous: Posez l'appareil sur une surface plane et horizontale. Veillez à ce que sa ventilation correcte puisse se faire en le plaçant sur un support d'au moins dix centimètres de hauteur.

**Front view
Face**

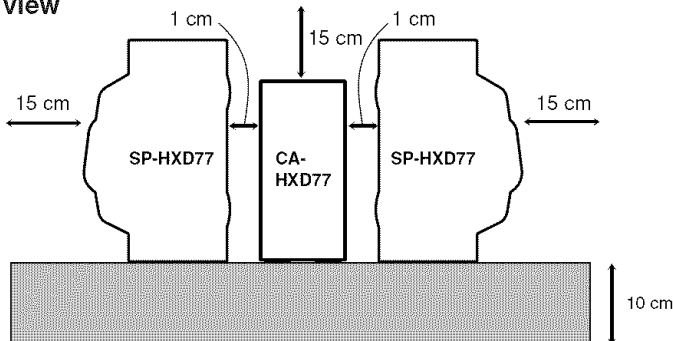

**Side view
Côté**

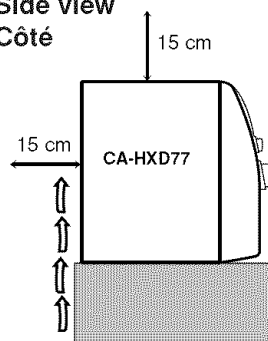

Introduction

Precautions

Installation

- Install in a place which is level, dry and neither too hot nor too cold—between 5°C (41°F) and 35°C (95°F).
- Install the System in a location with adequate ventilation to prevent internal heat buildup in the System.



DO NOT install the System in a location near heat sources, or in a place subject to direct sunlight, excessive dust or vibration.

- Leave sufficient distance between the System and the TV.
- Keep the speakers away from the TV to avoid interference with TV.

Power sources

- When unplugging the System from the wall outlet, always pull on the plug, not the AC power cord.



DO NOT handle the AC power cord with wet hands.

Moisture condensation

Moisture may condense on the lenses inside the System in the following cases:

- After starting to heat the room
- In a damp room
- If the System is brought directly from a cold to a warm place
Should this occur, the System may malfunction. In this case, leave the System turned on for a few hours until the moisture evaporates, unplug the AC power cord, then plug it in again.

Internal heat

- A cooling fan is mounted on the rear panel to prevent heat buildup inside the unit.



For safety, observe the following carefully:

- Make sure there is good ventilation around the unit. Poor ventilation could overheat and damage the unit.
- DO NOT block the cooling fan and the ventilation openings or holes. If they are blocked by a newspaper or cloth, etc., the heat may not be able to get out.

Others

- Should any metallic object or liquid fall into the System, unplug the AC power cord and consult your dealer before operating any further.



DO NOT disassemble the System since there are no user serviceable parts inside.





- If you are not going to operate the System for an extended period of time, unplug the AC power cord from the wall outlet.

If anything goes wrong, unplug the AC power cord and consult your dealer.

How to Read This Manual

To make the explanations in this manual as simple and easy-to-understand as possible, we have adapted the following methods:

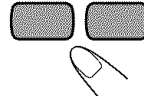
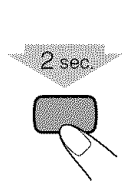
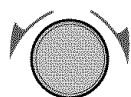
- Button and control operations are explained in the table below. In this manual, the operations using the remote control are mainly explained; however, you can use the buttons and controls on the main unit if they have the same (or similar) name and marks.
- **Some related tips and notes are explained later in the sections “Learning More about This System” and “Troubleshooting,” but not in the same section explaining the operations (INFO indicates that the content has some informations).** If you want to know more about the functions, or if you have a doubt about the function, go to these sections and you will find your answer there.

	Indicates that you press the button briefly .
	Indicates that you press the button briefly and repeatedly until an option you want is selected.
	Indicates that you press one of the buttons.
	Indicates that you press and hold the button for a specified period. <ul style="list-style-type: none"> • The number inside the arrow indicates the period of press (in this example, 2 seconds). • If no number is inside the arrow, press and hold until the entire procedure is complete or until you get a result you want.
	Indicates that you turn the control toward the specified direction(s).
	Indicates that this operation is only possible using the remote control.
	Indicates that this operation is only possible using the buttons and controls on the main unit.





Contents

Before Operating the System.....	3	Advanced Disc Operations	23
Playable Disc Types	3	Programming the Playing Order—Program Play.....	23
Getting Started.....	4	Playing at Random—Random Play.....	24
Step 1: Unpack	4	Playing Repeatedly—Repeat Play	25
Step 2: Prepare the Remote Control	4	Prohibiting Disc Ejection—Child Lock	25
Step 3: Hook Up.....	5	On-Screen Disc Operations	26
Display Indication.....	8	About the On-screen Bar.....	27
Daily Operations—Playback	10	Operations Using the On-screen Bar.....	27
Listening to the Radio	11	Operations on the control Screen	30
Playing Back a Disc.....	12	Timer Operations	33
Playing Back from the PC	14	Setting the Timer.....	33
Playing Back from Other External Equipment.....	15	Set up Menu Operations.....	35
Daily Operations—Sound and Other		Operating Procedure.....	35
Adjustments	16	Operating the TV	39
Adjusting the Volume.....	16	Operating TV.....	39
Reinforcing the Bass Sound	16	Additional Information.....	40
Making the Center Channel Sound Clear		Learning More about This System	40
—Clear Voice	17	Maintenance	42
Selecting the Sound Modes	17	Troubleshooting	42
Selecting 3D Phonic Mode.....	17	OPTICAL DIGITAL OUTPUT Signals	43
Presetting Automatic DVD VIDEO Sound		Language Code List	44
Increase Level.....	17	Parts Index.....	45
Changing the Picture Tone	18	Specifications	46
Turning On or Off the Key-Touch Tone	19		
Changing the Display Brightness	19		
Setting the Clock	19		
Turning Off the Power Automatically.....	19		
Unique DVD/VCD Operations	20		
Selecting the Sound Track.....	20		
Selecting the Subtitle Language	21		
Selecting a View Angle	21		
Special Picture Playback	22		

Before Operating the System

Playable Disc Types

This unit has been designed to play back the following discs:

Disc Type	Mark (Logo)
DVD Video	
Video CD (VCD)	 Video CD
Super Video CD (SVCD)	 
Audio CD	
CD-R	The System can play back CD-R or CD-RW recorded in the Audio CD, Video CD, SVCD, MP3, WMA and JPEG formats.
CD-RW	
DVD-R	The System can play back DVD-R or DVD-RW recorded in the DVD-Video and Video Recording (DVD-VR) format.
DVD-RW	

In addition to the above discs, this system can play back audio data recorded on CD Text, CD-G (CD Graphics), and CD-Extra.

- The following discs cannot be played back: DVD-RAM, CD-I (CD-I Ready), CD-ROM, Photo CD, SACD, etc.
Playing back these discs will generate noise and damage the speakers.
- This unit cannot play back DVD-VR disc with CPRM (Content Protection for Recordable Media).
- In this manual, “file” and “track” are interchangeably used for MP3/WMA/JPEG operations.
- It is possible to play back finalized +R/+RW (DVD format only) discs. “DVD” lights on the front display panel when a +R/+RW disc is loaded.
- The Non-DVD side of a “DualDisc” does not comply with the “Compact Disc Digital Audio” standard. Therefore, the use of Non-DVD side of a DualDisc on this product may not be recommended.

About color system

This System accommodates the NTSC and PAL system and can play back discs recorded in either the NTSC or the PAL system.

- To change the color system, see page 7.

Note on Region Code

DVD players and DVDs have their own Region Code numbers. This unit can play back only DVDs whose Region Code numbers include “1.”

EX.:



If a DVD with the improper Region Code numbers is loaded, “REGION ERR” appears on the display and playback will not start.

IMPORTANT: Before playing a disc, make sure of the following...

- Turn on the TV and select an appropriate input mode on the TV to view the pictures or on-screen displays on the TV screen.
- For disc playback, you can change the initial setting to your preference. See “Set up Menu Operations” on page 35.

If “” appears on the TV screen when you press a button, the disc cannot accept the operation you have tried to do, or data required for that operation is not recorded on the disc.

- Manufactured under license from Dolby Laboratories. “Dolby”, “Pro Logic”, “MLP Lossless”, and the double-D symbol are trademarks of Dolby Laboratories.
- “DTS” and “DTS 2.0+DIGITAL OUT” are trademarks of Digital Theater Systems, Inc.
- “DVD Logo” is a trademark of DVD Format/Logo Licensing Corporation registered in the US, Japan and other countries.

Getting Started

Step 1: Unpack the package and check the accessories.

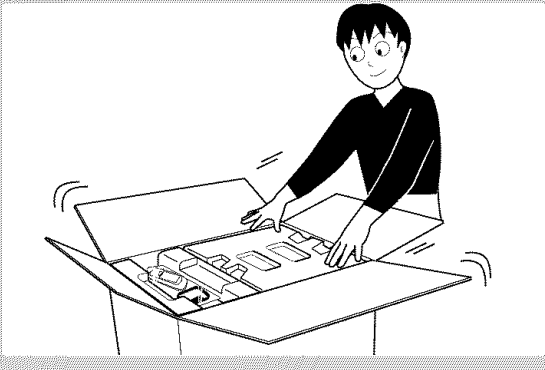

Step 1: Unpack

After unpacking, check to be sure that you have all the following items. The number in parentheses indicates the quantity of each piece supplied.

- FM antenna (1)
- AM loop antenna (1)
- Composite video cord (1)
- Remote control (1)
- Batteries (2)

If any item is missing, consult your dealer immediately.

Step 2: Prepare the Remote Control

Insert the batteries into the remote control by matching the polarity (+ and -) correctly.

1

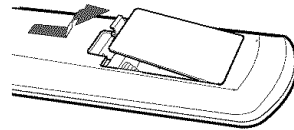

2

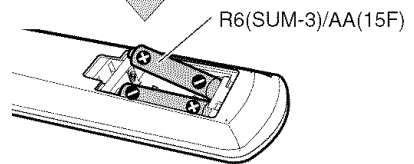

3

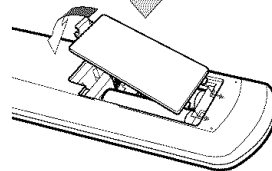

Step 2: Prepare the remote control.

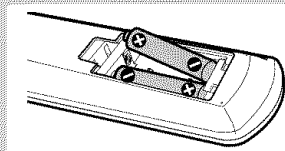

Step 3: Hook up the components such as AM/FM antennas, speakers, etc. (see pages 5 to 7).

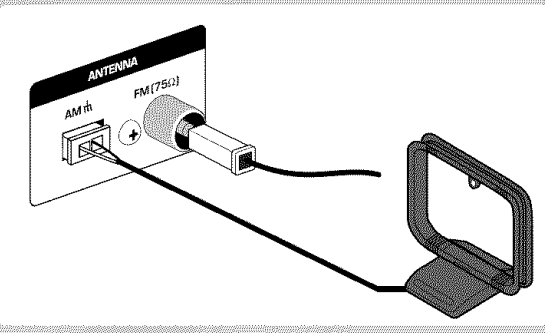

Finally plug the AC power cord.
Now you can operate this System.

- DO NOT use an old battery together with a new one.
- DO NOT use different types of batteries together.
- DO NOT expose batteries to heat or flame.
- DO NOT leave the batteries in the battery compartment when you are not going to use the remote control for an extended period of time. Otherwise, the remote control will be damaged from battery leakage.



Step 3: Hook Up

If you need more detailed information, see page 6 and 7.

Do not connect the AC power cord until all other connections have been made.

Illustrations of the input/output terminals below are typical examples. When you connect other components, refer also to their manuals since the terminal names actually printed on the rear may vary.

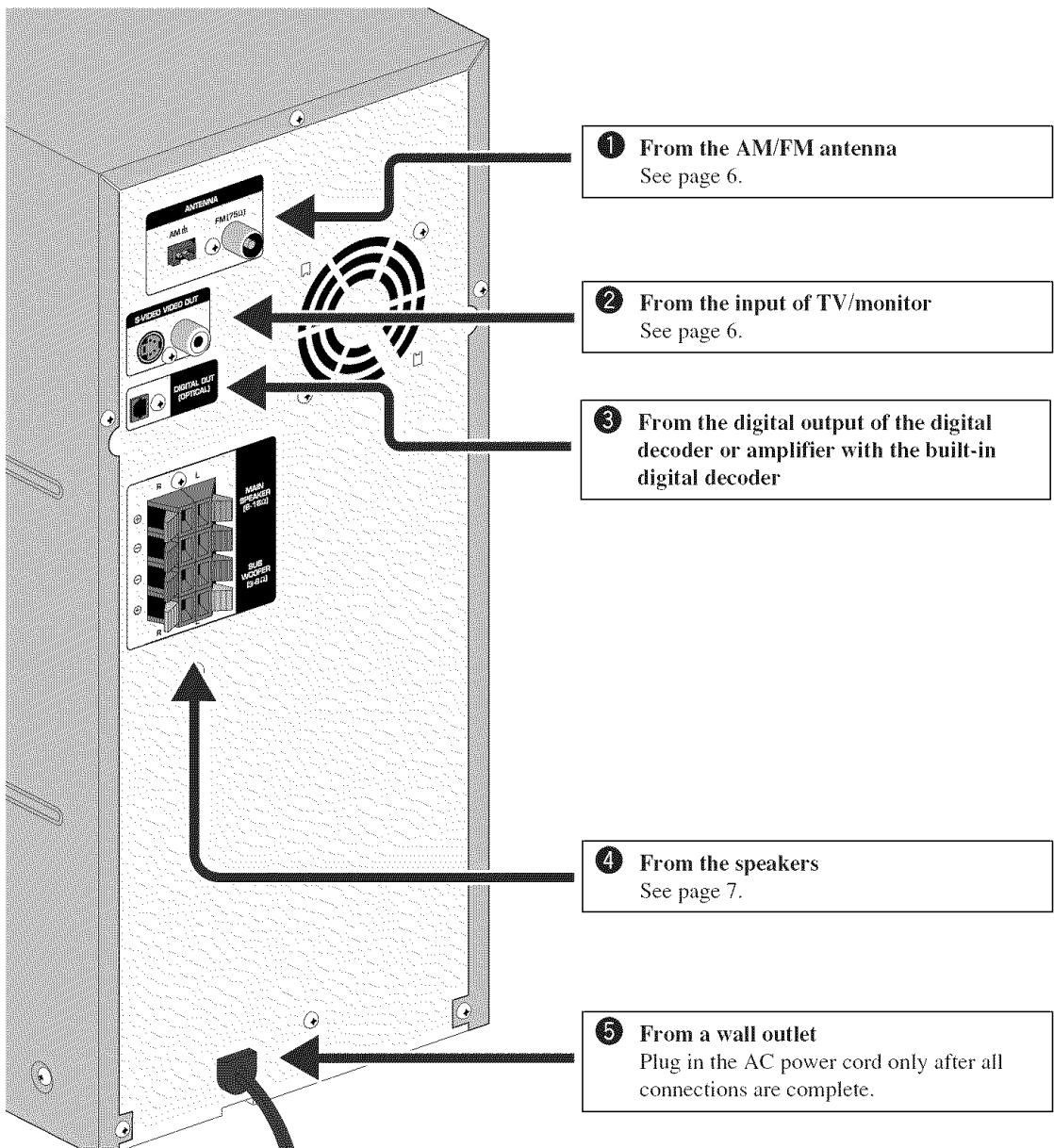

1 To assemble and connect the AM loop antenna

To assemble the AM loop antenna

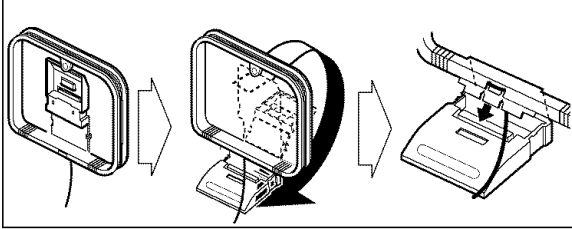

To connect the AM loop antenna cords

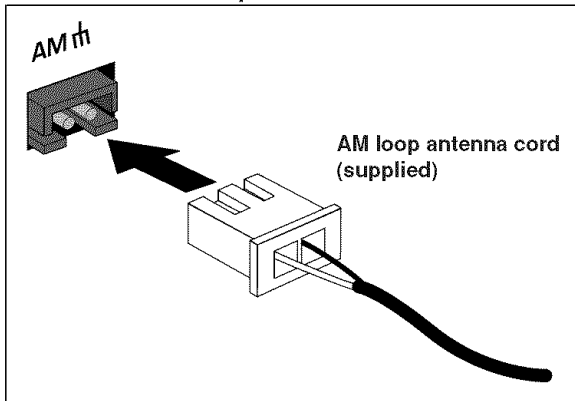

- Make sure the antenna conductors do not touch any other terminals, connecting cords and power cord. Also, keep the antennas away from metallic parts of the System, connecting cords, and the AC power cord. This could cause poor condition.

To connect the FM antenna

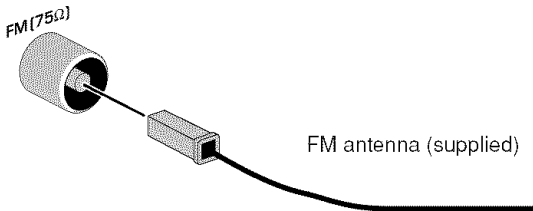

Extend the supplied FM antenna horizontally.

For better FM/AM reception

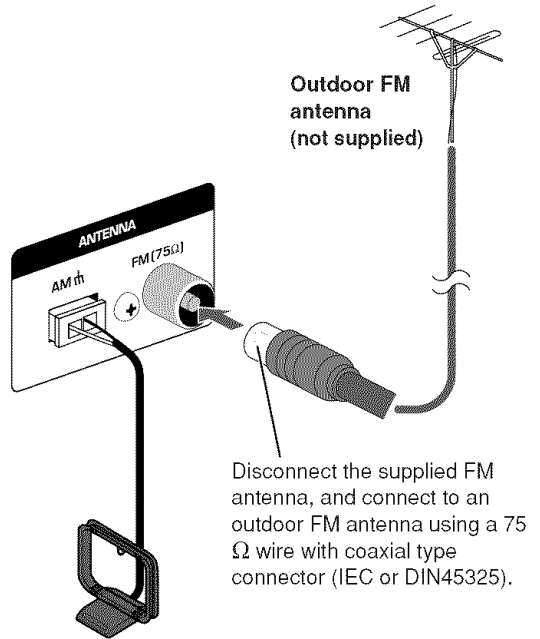

Disconnect the supplied FM antenna, and connect to an outdoor FM antenna using a 75 Ω wire with coaxial type connector (IEC or DIN45325).

AM loop antenna
Keep it connected.

2 TV/monitor

Connect the S-VIDEO or VIDEO jacks which you want to use.

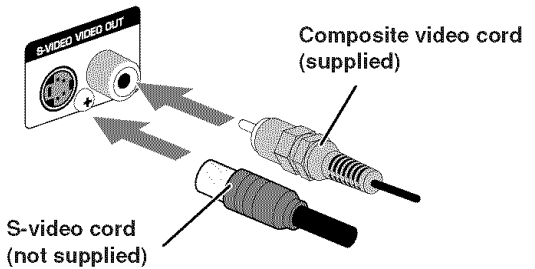

- The video signals from the external equipment connected to GAME/AUX jack are output as composite video signal. The system does not output S-video signals for these external equipment.

To select the color system



You can select the video output to match it to the color system of your TV.

- The color system can be changed only while DVD/CD is selected as the source and playback is stopped.

1 Press NTSC/PAL.



2 Select NTSC or PAL.

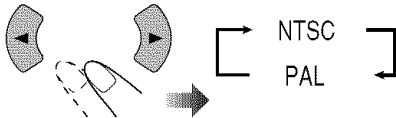

NTSC: For an NTSC TV.

PAL: For a PAL TV.

- When using a multi-color system TV, either position will work.

3 Press ENTER.



3 To connect digital audio

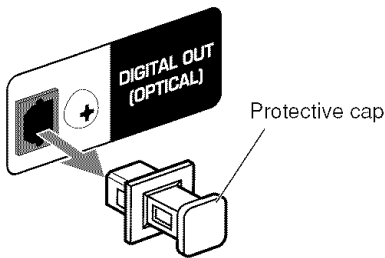

- Set "DIGITAL AUDIO OUTPUT" in the "AUDIO" menu correctly according to the connected digital audio equipment (see page 37). If the setting is incorrect, loud noise may be generated causing damage to the speakers. Digital audio signals are output from this System only when DVD/CD is selected as the source.

4 Speakers

- When connecting the speaker cords, match their polarity with that of the speaker terminals: red/blue to (+) and black to (-).
- Use only speakers with the same speaker impedance as indicated by the speaker terminals on the rear of the unit.
- The speakers are magnetically shielded to avoid color distortions on TVs. However, if not installed properly, it may cause color distortions. So, pay attention to the following when installing the speakers.
 - When placing the speakers near a TV set, turn off the TV's main power switch or unplug it before installing the speakers. Then wait at least 30 minutes before turning on the TV's main power switch again.
- Some TVs may still be affected even though you have followed the above instruction. If this happens, move the speakers away from the TV.



- DO NOT connect more than one speaker to each terminal.
- DO NOT push or pull the speakers as this will damage the foot spacers at the bottom of the speakers.

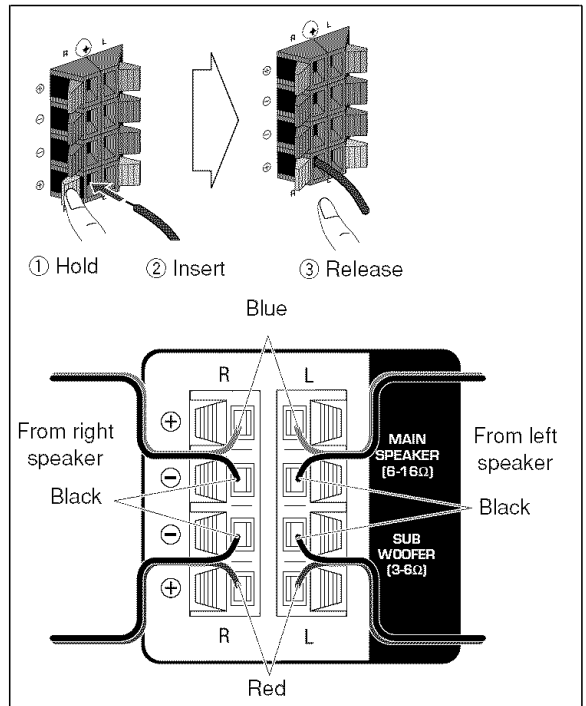

DO NOT plug in any equipment until all connections are complete.

Display Indication

The indications on the display tell you a lot of things while you are operating the System. Before operating the System, be familiar with when and how the indicator illuminates on the display.

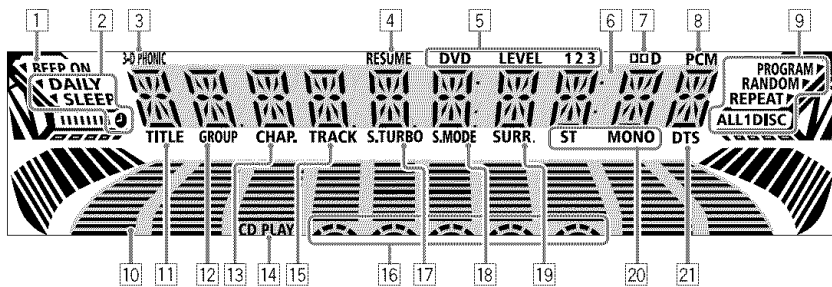

See also page 9.

- 1** BEEP ON indicator
 - Lights when key-touch tone is activated.
- 2** Timer indicators
 - DAILY: lights when the Daily Timer stands by or is working; flashes while Daily Timer is being set.
 - SLEEP: lights when the Sleep Timer is activated.
 - : lights when Daily Timer stands by or is being set; flashes while Daily Timer is working.
- 3** 3-D PHONIC indicator
 - Lights when 3D Phonic is activated (see page 17).
- 4** RESUME indicator
 - Lights when the Resume function is activated (see page 12).
- 5** DVD LEVEL 1, 2, 3 indicators
 - Lights when the DVD Video is detected (see page 17).
- 6** Main display
- 7** D: lights when a source signal is Dolby Digital.
- 8** PCM: lights when a source signal is linear PCM (only for DVD Video).
- 9** Disc operation indicators
 - PROGRAM: lights when Program Play mode is activated.
 - RANDOM: lights when Random Play is activated.
 - REPEAT: lights when Repeat Play mode is activated.
 - ALL, 1, DISC:
 - ALL: lights when All Disc Repeat is activated.
 - 1: lights when One Track/Chapter/Step Repeat is activated.
 - 1 DISC: lights when One Disc Repeat is activated.
- 10** Audio level indicator
- 11** TITLE indicator
 - Lights to indicate the title number when the source is DVD Video.
- 12** GROUP indicator
 - Lights to indicate the group number when the source is MP3, WMA or JPEG disc.
- 13** CHAP. (chapter) indicator
 - Lights to indicate the chapter number when the source is DVD Video.
- 14** CD PLAY indicator
 - Lights when the disc player is selected as the source.
- 15** TRACK indicator
 - Lights to indicate the track number when the source is a disc (except for DVD Video).
- 16** Disc indicators
 - Each indicator shows the status of a disc placed on each corresponding disc tray (DISC1 – DISC5).
 - Lights up when a disc is detected.
 - Flashes when the tray is currently selected.
 - Goes off when the unit detects there is no disc loaded on the disc tray.
- 17** S.TURBO (Sound Turbo) indicator
- 18** S.MODE (sound mode) indicator
 - Lights when the Sound mode is activated.
- 19** SURR. (surround) indicator
 - Lights when 3D Phonic is activated (see page 17).
- 20** FM reception indicators
 - ST (stereo): lights while an FM stereo station with sufficient signal strength is tuned in.
 - MONO: lights while receiving an FM stereo station in monaural.
- 21** DTS: lights when a source signal is DTS Surround.

Indications on the main display

- While listening to radio:

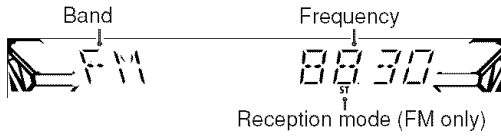

- While selecting "GAME/AUX" or "USB":

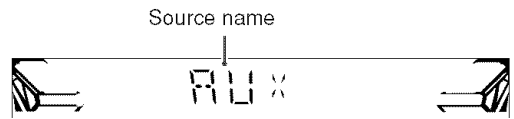

- While playing a disc:

DVD Video:

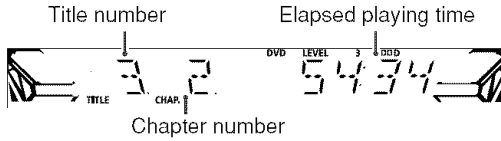

- While disc play is stopped:

DVD Video:

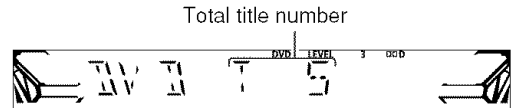

DVD VR:

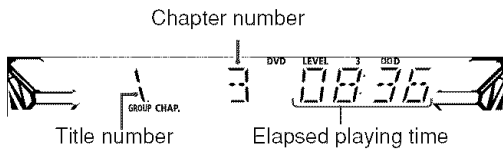

DVD VR:

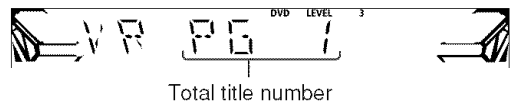

SVCD/VCD/CD:

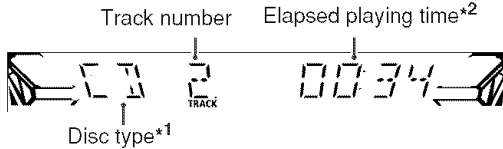

SVCD/VCD/CD:

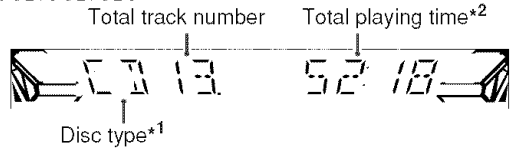

MP3/WMA^{*3}:

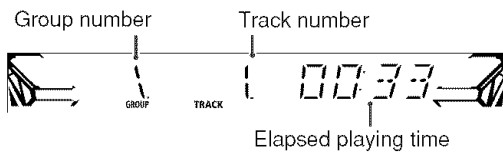

MP3/WMA:

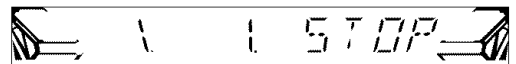

JPEG:

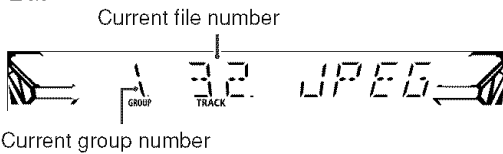

JPEG:

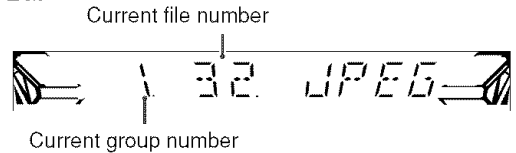

^{*1} Disc type is displayed with the following abbreviation: "SV (SVCD)", "VD (VCD)", and "CD (CD)".

^{*2} While activating PBC function, "PBC" appears on the display instead of the playing time.

^{*3} At the playback beginning, the file name and ID3 Tag (if any) are shown.

Daily Operations—Playback

In this manual, the operation using the remote control is mainly explained; however, you can use the buttons and controls on the main unit if they have the same (or similar) name and marks.

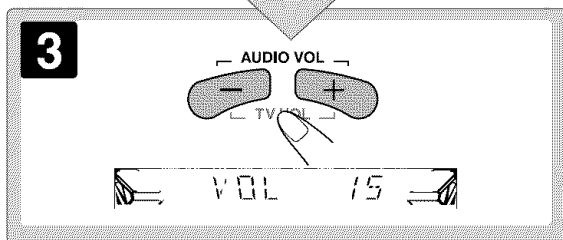
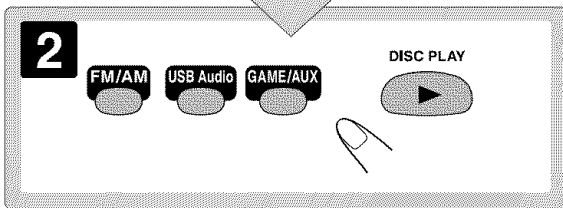
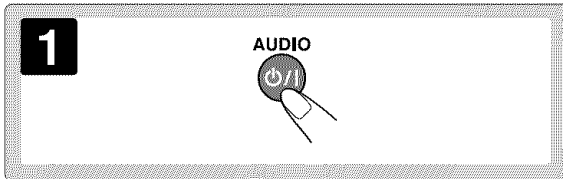
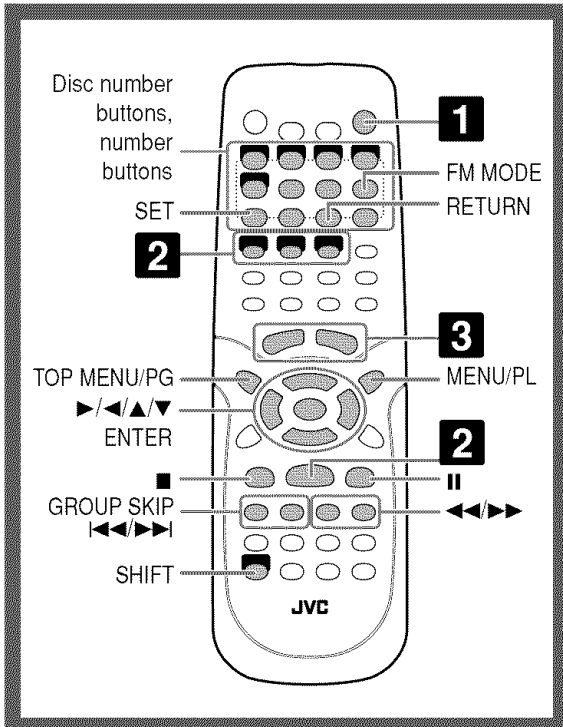

1 Turn on the power.

The standby lamp on the main unit turns off.

- Without pressing /I, the System also turns on by pressing one of the source select buttons in the next step.

2 Select the source.

Playback automatically starts if the selected source is ready to start playback.

- If you press GAME/AUX or USB Audio, start playback source on the external audio component, game or the PC.

3 Adjust the volume.

4 Operate the target source as explained later.

To turn off (stand by) the system



The standby lamp on the main unit lights in red.

- When you turn off (stand by) the system with volume level over VOL 15, the system automatically decreases the volume level to VOL 15 next time you turn on the system.
- A small amount of power is always consumed even while on standby.

For private listening

Connect a pair of headphones to the PHONES jack on the main unit. The sound will no longer come out of the speakers. Be sure to turn down the volume before connecting or putting the headphones.

- Disconnecting the headphones will activate the speakers again.



DO NOT turn off (stand by) the System with the volume set to an extremely high level; otherwise, the sudden blast of sound can damage your hearing, speakers and/or headphones when you turn on the System or start playback.

To cancel the demonstration

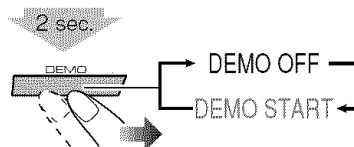

Press and hold until "DEMO OFF" appears on the display.

To save the power consumption while on standby—Eco mode



While on standby...

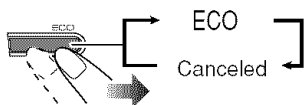

The display illumination (including the display demonstration) disappears.

Listening to the Radio



To select the band (FM/AM)

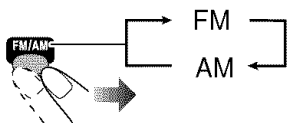

To tune in to a station

While FM or AM is selected...

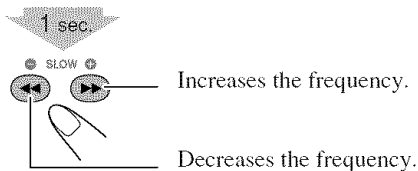

When a station (frequency) with sufficient signal strength is tuned in, the frequency search stops.

- When you repeatedly press the button, the frequency changes step by step.

To stop searching manually, press either button.

If the received FM station is hard to listen

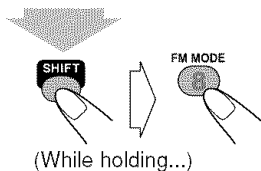

The MONO indicator lights on the display. Reception will improve though stereo effect is lost—monaural reception mode.

To restore the stereo effect, press the button again (the MONO indicator disappears).

To preset stations



You can preset 30 FM and 15 AM stations.

1 Tune in to a station you want to preset, then enter into the presetting mode.

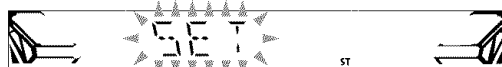
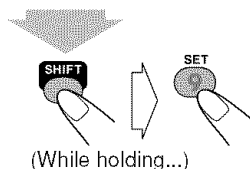

2 Select a preset number for the station you store.

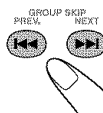

3 Store the station.

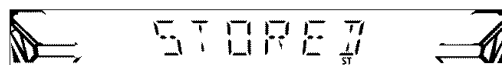
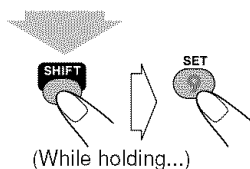

To tune in to a preset station

1 Select the band (FM or AM).

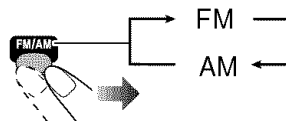

2 Select a preset number for the station you store.

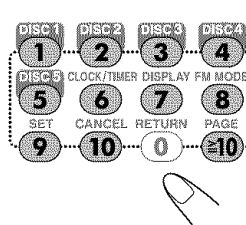

Examples:

- To select preset number 5, press 5.
- To select preset number 10, press 10.
- To select preset number 15, press ≥ 10 , 1, then 5.
- To select preset number 30, press ≥ 10 , 3, then 0.

- You can also use \gg/\ll on the remote control or the PRESET +/- control on the main unit.

Playing Back a Disc INFO

Before operating a disc, be familiar how a disc is recorded.

- DVD Video/DVD-VR comprises of “Titles” which includes “Chapters,” MP3/WMA comprise of “Groups” which includes “Tracks,” and CD/SVCD/VCD comprise of only “Tracks.”

For MP3/WMA/JPEG playback, see also page 30.

To insert discs

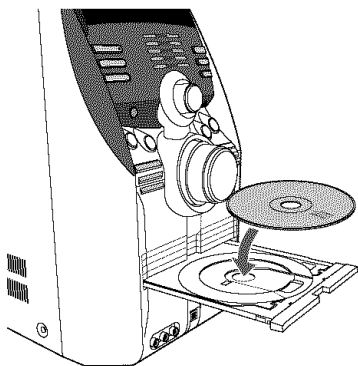
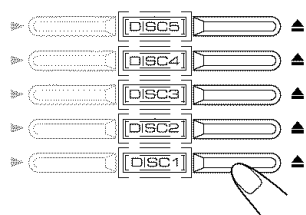

- When using an 8 cm disc, place it on the inner circle of the disc tray.

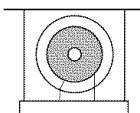

To close the disc tray, press the same button again.

- If you press the button, disc tray closes automatically and playback starts.
- When you press the button for the next tray you want to place another disc onto, the first disc tray automatically closes and then next tray comes out.

To start:	To pause:	To stop:
	 To release it, press DISC PLAY .	

While playing DVD/SVCD/VCD: This System can store the stop point, and when you start playback again by pressing DISC PLAY , it starts from the position where you have stopped—Resume Play. (RESUME indicator lights up when you stop playback.)

To stop completely while Resume is activated, press twice. (To cancel Resume, see “RESUME” on page 38.)

On-screen guide icons

- During disc playback, the following icons may appear for a while on the TV screen:

Appears at the beginning of a scene containing multi-angle views.

Appears at the beginning of a scene containing multi-audio languages.

Appears at the beginning of a scene containing multi-subtitle languages.

- The following icons will be also shown on the TV screen to indicate your current operation.



- To deactivate the on-screen guide icons, see “ON SCREEN GUIDE” on page 38.

To select a playback disc

Remote control:

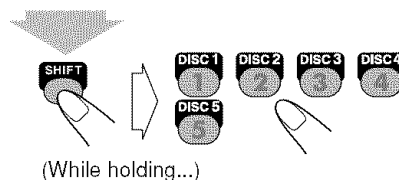

Main unit:

Ex.: To select DISC 1

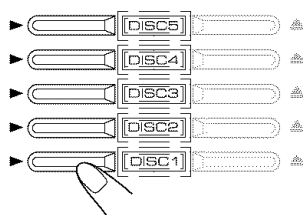

Playback of the selected disc starts.

To select a title/group



While playing a disc...

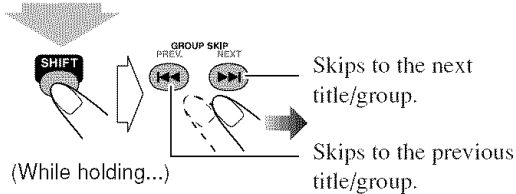

To select a chapter/track

While playing...

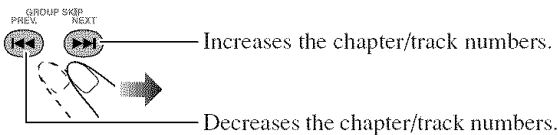

To locate a particular portion

While playing a disc except MP3/WMA...

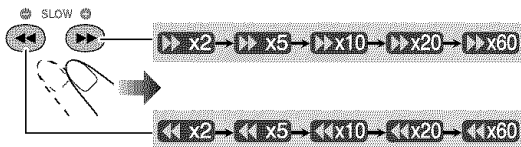

- No sound comes out while searching on DVD/SVCD/VCD.

To return to normal playback, press DISC PLAY ▶.

To select an item directly



You can select a title/chapter/track directly and start playback.

- For DVD Video: You can select a title before starting playback, while you can select a chapter after starting playback.
- For MP3/WMA: Select a track number in the current folder.

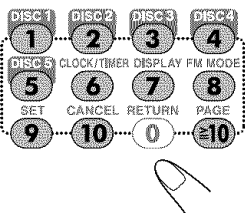

Examples:

- To select number 5, press 5.
- To select number 10, press 10.
- To select number 15, press ≥ 10 , 1, then 5.
- To select number 30, press ≥ 10 , 3, then 0.
- To select number 114, press ≥ 10 , ≥ 10 , 1, 1 then 4.

To play back by using the disc menu



You can operate the disc play—DVD and SVCD/VCD with Playback Control (PBC)—using the disc menu shown on the TV screen.

- When an SVCD or VCD with PBC is detected, “PBC” appears on the display instead of the playing time.

■ For DVD Video:

1 Show the disc menu.

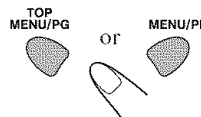

2 Select an item on the disc menu.

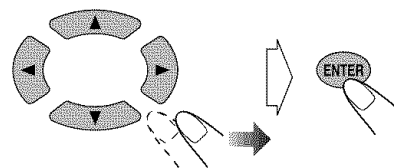

- With some discs, you can also select items by entering the number using the 10 keys.

■ For SVCD/VCD with PBC:

While playing a disc with PBC, “PBC” appears on the display.

When disc menu appears on the TV screen, select an item on the menu. Playback of the selected item starts.

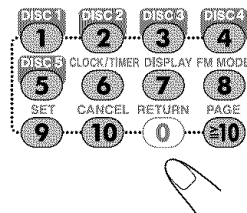

Examples:

- To select number 5, press 5.
- To select number 10, press 10.
- To select number 15, press ≥ 10 , 1, then 5.
- To select number 30, press ≥ 10 , 3, then 0.

To move to the next or previous page of the current menu:

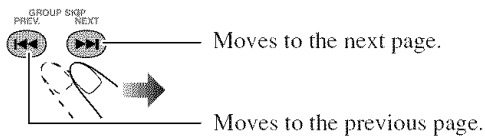

To return to the previous menu:

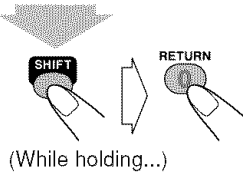

To cancel PBC

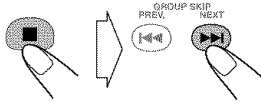

You can also cancel PBC function by pressing the number button to select a track.

To reactivate PBC, press **■**, then press **◀◀**.

Playing Back from the PC

This System is equipped with a USB terminal on the front panel. You can connect your PC to this terminal and enjoy sound reproduced through your PC. When you connect your PC for the first time, follow the procedure below.

- Remember you cannot send any signal or data to your PC from this System.

IMPORTANT

- Always set volume to VOL MIN when connecting or disconnecting the other equipment.



DO NOT turn off the System and disconnect the USB cable while installing drivers and playing back, and for several seconds after your PC recognizes the System.

How to install the USB drivers

The following procedure is described using the English version of Windows® XP. If your PC is running on a different version of Windows, the screens shown on your PC's monitor will differ from the ones used in the following procedure.

- 1 Turn on your PC and start running Windows® 98SE, Windows® Me, Windows® 2000 or Windows® XP.
 - If the PC has been turned on, quit all the applications now running.
- 2 Turn on the System.
- 3 Select USB for the source.

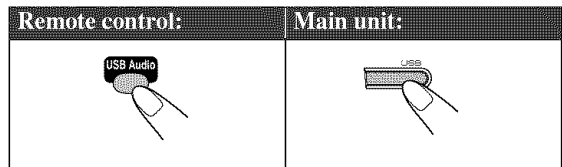

- 4 Connect the unit to the PC using a USB cable (not supplied).

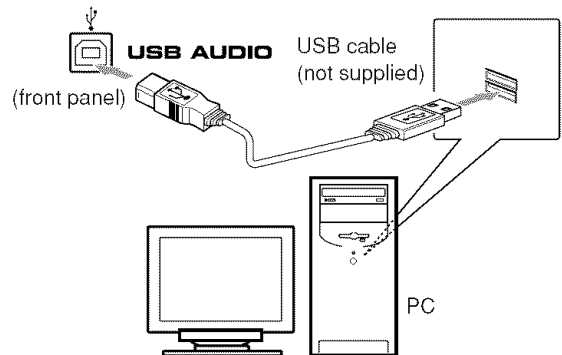

- Use "USB series A plug to B plug" cable when connecting.
- 5 The USB drivers are installed automatically.
 - If the USB drivers are not installed automatically, install the USB drivers following the instructions on the PC's monitor.

6 Check if the drivers are correctly installed.

- 1 Open the Control Panel on your PC: Select [Start] → [Settings] → [Control Panel]
 - 2 Click [System] → [Hardware] → [Device Manager] → [Sound, video and game controllers] and [Universal Serial Bus controllers]
- The following window appears, and you can check whether the drivers are installed.

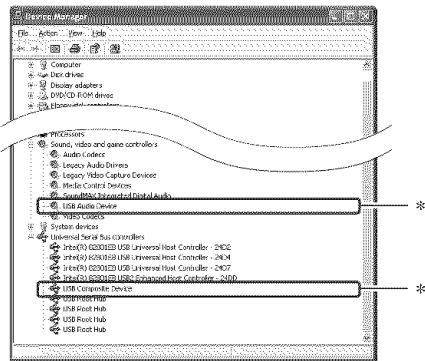

* The installed drivers can be shown only when the System is connected to the PC.

To play back sounds on the PC

Refer to the manuals supplied with the sound reproduction application installed in the PC.

- Microsoft®, Windows® 98SE, Windows® Me, Windows® 2000 and Windows® XP are registered trademarks of Microsoft corporation.

Playing Back from Other External Equipment

IMPORTANT

- Turn the power off to all components before connections.
- Always set volume to VOL MIN when connecting or disconnecting the other equipment.

By connecting an external audio equipment or game console, you can enjoy the dynamic sound with this system.

- When enjoying a video game with your game console connected to this System, connect this System and your TV/monitor with the composite video cable (see page 6).

To connect game console

(front panel)

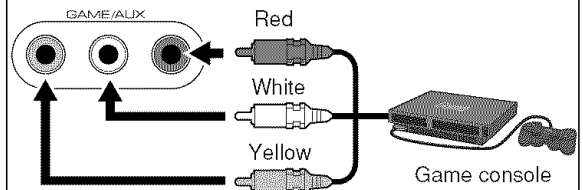

To connect audio equipment

(front panel)

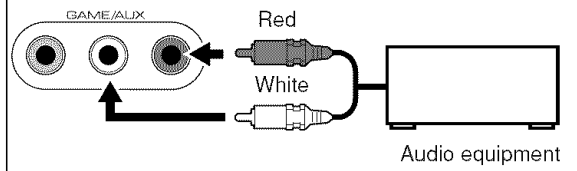

To select other external equipment for the source

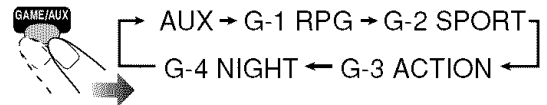

To select external audio equipment as the source, select “AUX”.

To select game console as the source, select “G-1 RPG”, “G-2 SPORT”, “G-3 ACTION” or “G-4 NIGHT”.

- While selecting GAME/AUX for the source, the sound mode and 3D Phonic do not take effect.

To enjoy powerful game sound

When you select “G-1 RPG”, “G-2 SPORT”, “G-3 ACTION” or “G-4 NIGHT”, you can enjoy the sound effect suitable for the genre or scene of the game.

G-1 RPG	For RPG.
G-2 SPORT	For sport game.
G-3 ACTION	For action game.
G-4 NIGHT	For enjoying powerful game sound with low sound level.

- The video signals from the external equipment connected to GAME/AUX jack are output as composite video signal. The system does not output S-video signals for these external equipment.

Daily Operations—Sound and Other Adjustments

Remote Control

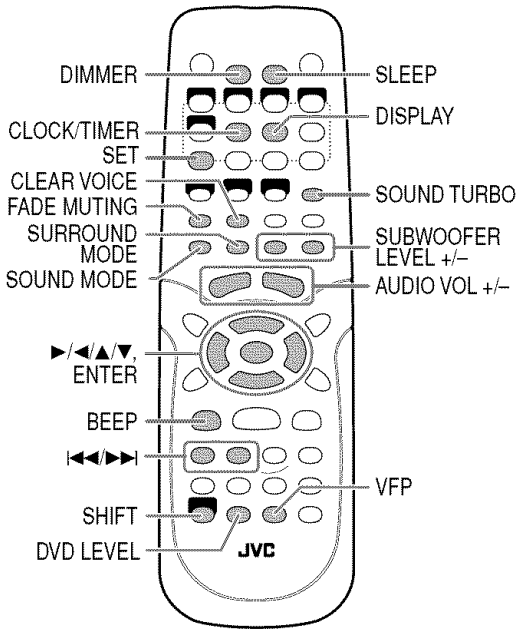

Main unit

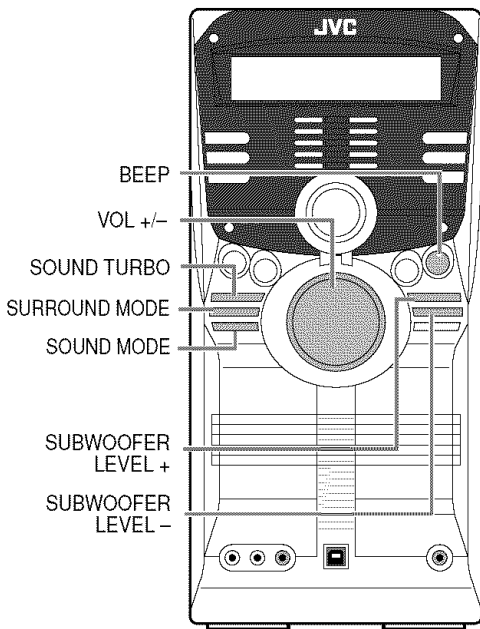

Adjusting the Volume INFO

The volume level can be adjusted in 32 steps (VOL MIN, VOL 1 – VOL 30, VOL MAX).

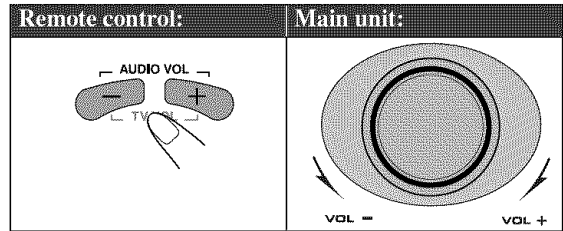

To drop the volume in a moment



To restore the volume, press the button again, or adjust the volume level.

Reinforcing the Bass Sound INFO

To adjust the subwoofer level gradually

You can select the subwoofer level from level 0 (minimum) to level 2 (maximum).

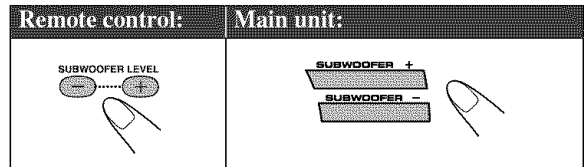

To enjoy powerful sound

You can enjoy powerful sound by using Sound Turbo. This function boosts the low and high frequency sound.

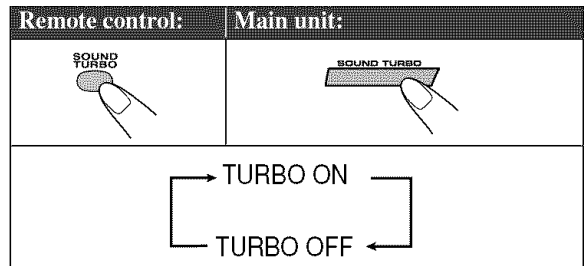

- When the Sound Turbo is set to TURBO ON, the S.TURBO indicator lights up and the subwoofer level automatically increases to the maximum level (level 2).
- You can adjust the subwoofer level even if the Sound Turbo is set to TURBO ON.

Making the Center Channel Sound Clear

Clear Voice

When a multi-channel disc with center-channel signal is loaded on the current tray, you can increase the output level for the center channel sound.

- This function allows you to easily understand the dialogue of DVD Video even with the low volume level.

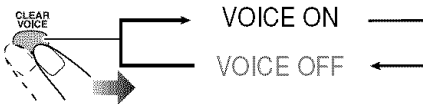

- This function may not take much effect on some discs.

To cancel Clear Voice, select “VOICE OFF.”

Selecting the Sound Modes

INFO

You can select one of the preset Sound Modes.

- Sound Modes do not take effect while GAME is selected as the source.

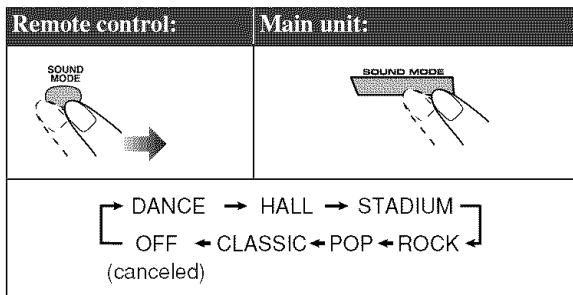

DANCE	Increases resonance and bass.
HALL	Adds depth and brilliance to the sound.
STADIUM	Adds clarity and spreads the sound, as in an outdoor stadium.
ROCK	Boosts low and high frequency. Good for acoustic music.
POP	Good for vocal music.
CLASSIC	Good for classical music.

Selecting 3D Phonic Mode

INFO

While playing a disc (except JPEG)...

- 3D Phonic does not take effect while GAME/AUX is selected as the source.

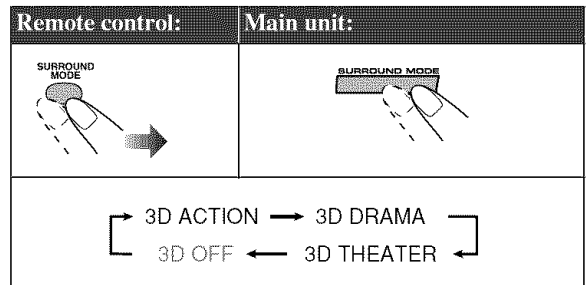

3D ACTION Suitable for action movies and sports programs.

3D DRAMA Creates natural and warm sound. Enjoy movies in a relaxed mood.

3D THEATER Enjoy sound effects like in a major theater.

To cancel 3D Phonic, select “3D OFF.”

Presetting Automatic DVD VIDEO Sound

Increase Level

The DVD Video sound is sometimes recorded at a lower level than for other discs and sources. You can set the increase level for DVD Video, so you do not have to adjust the volume every time you change the source.

When DVD Video is loaded on the current tray...

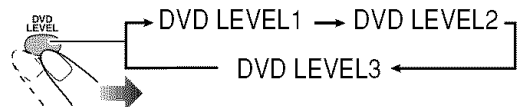

- As the number increases, sound level also increases.

Changing the Picture Tone



While showing a playback picture on the TV, you can select the preset picture tone, or adjust it and store your own preference.

To select a preset picture tone

1 Activate VFP.

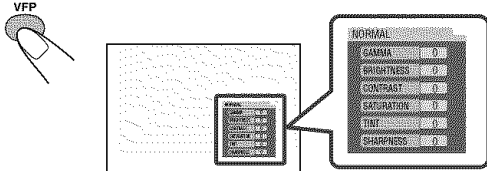

On the TV screen

2 Select a preset picture tone.

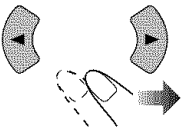

NORMAL	Normally select this.
CINEMA	Suitable for a movie source.
USER1/USER2	You can adjust parameters and can store the settings (see the next column).

3 Finish setting.



To adjust the picture tone

1 Select "USER1" or "USER2."

- Follow steps 1 and 2 explained above.

2 Select a parameter you want to adjust.



GAMMA	Adjust if the neutral color is bright or dark. The brightness of dark and bright portions is maintained (-3 to +3).
BRIGHTNESS	Adjust if the picture is bright or dark as a whole (-8 to +8).
CONTRAST	Adjust if the far and near position is unnatural (-7 to +7).
SATURATION	Adjust if the picture is whitish or blackish (-7 to +7).
TINT	Adjust if the human skin color is unnatural (-7 to +7).
SHARPNESS	Adjust if the picture is indistinct (-8 to +8).

3 Adjust the parameter.

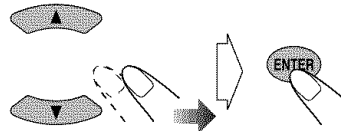

4 Repeat steps 2 to 3 to adjust other parameters.

5 Finish setting.



Turning On or Off the Key-Touch Tone

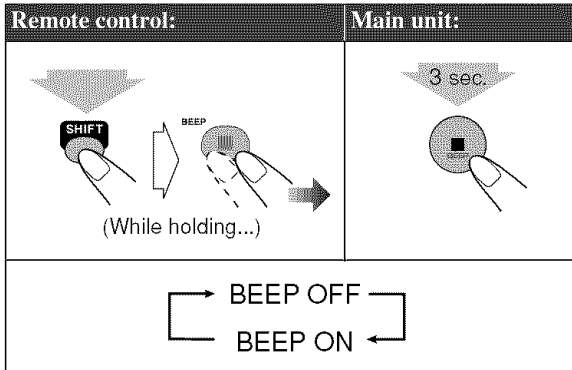

- When the key-touch tone is activated, the BEEP ON indicator lights up.

Changing the Display Brightness Remote ONLY

You can dim the display window.

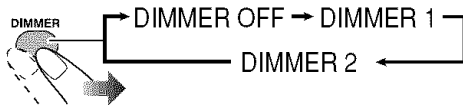

Setting the Clock Remote ONLY INFO

Without setting the built-in clock, you cannot use Daily Timer (see page 33).

- To exit from the clock setting, press CLOCK/TIMER (while holding SHIFT) as required.
- To go back to the previous step, press CANCEL (while holding SHIFT).
- If you have already adjusted the clock before, press the CLOCK/TIMER (while holding SHIFT) repeatedly in step 1, until the clock setting mode is selected.

1 Activate clock setting mode.

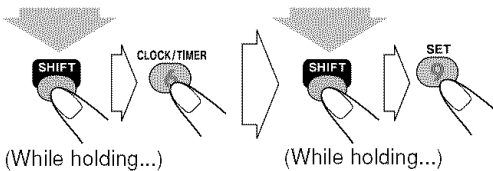

2 Adjust the hour.

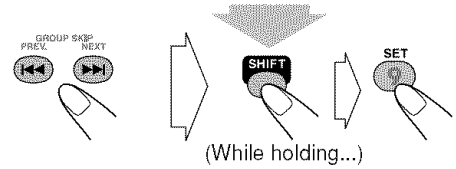

3 Adjust the minute.

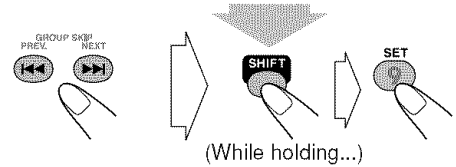

Now the built-in clock starts working.

To check the current time during play

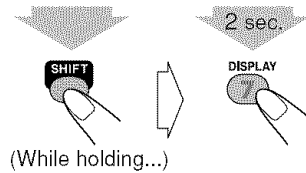

To display the source information, press any button.

Turning Off the Power Remote ONLY Automatically INFO

With Sleep Timer, you can fall asleep listening to music.

- You can set Sleep Timer only while the System is turned on.

1 Specify the time (in minutes).

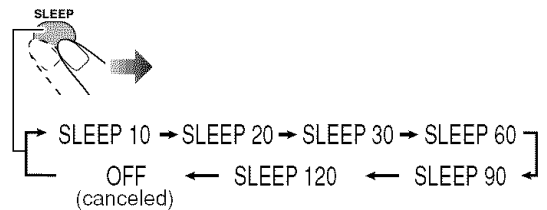

2 Wait until the set time disappears.

To check the time remaining until the shut-off time

- When you press SLEEP once, you can check the remaining time until the shut-off time.

Unique DVD/VCD Operations

Remote Control

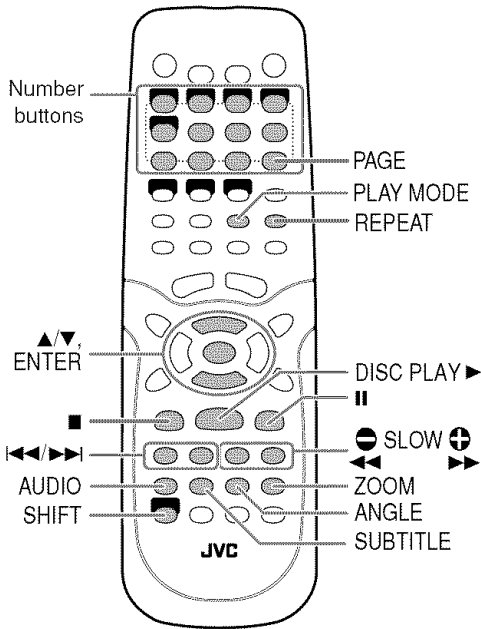

Selecting the Sound Track



For DVD Video: While playing back a chapter containing multiple audio tracks, you can select the one to listen to.
For DVD-VR/SVCD/VCD: When playing back a track, you can select the audio channel to play.

- You can also select the audio track using the on-screen bar (see pages 26 and 27).

While playing a DVD Video...

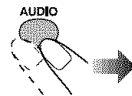

Ex.:

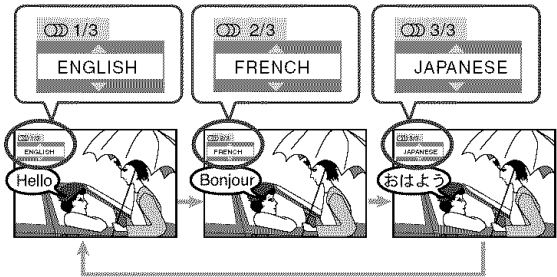

While playing a DVD-VR, SVCD or VCD...

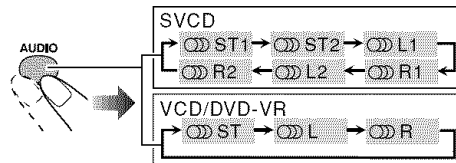

ST1/ST2/ST To listen to normal stereo (2 channel) playback.

L1/L2/L To listen to the left audio channel.

R1/R2/R To listen to the right audio channel.

- SVCD can have 4 audio channels. SVCD usually uses these 4 channels to record two 2-channel recordings (ST1/ST2).

Selecting the Subtitle Language

For DVD Video: While playing back a chapter (of DVD Video) containing subtitles in different languages, you can select the subtitle language to display on the TV screen.

For DVD-VR: While playing, you can turn the subtitle on or off.

For SVCD: While playing, you can select the subtitles even if no subtitles are recorded on the disc.

- You can also select the subtitle language using the on-screen bar (see page 27).

While playing a DVD Video...

1 Display the subtitle selection window.



2 Select the subtitle language.

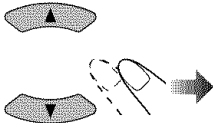

Ex.:

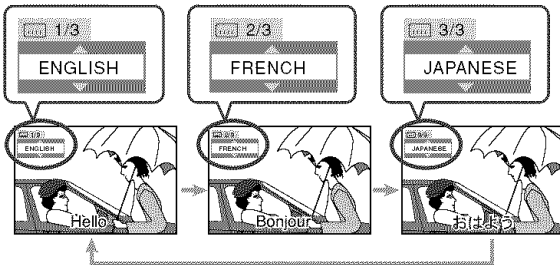

While playing DVD-VR...

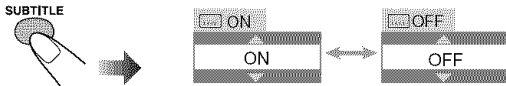

While playing an SVCD...

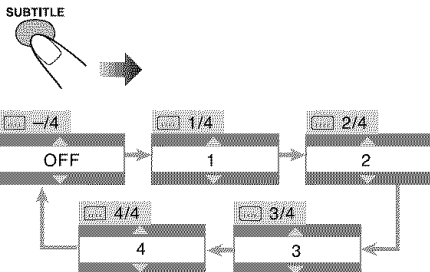

Selecting a View Angle

While playing back a chapter (of DVD Video) containing multi-view angles, you can view the same scene from different angles.

- You can also select the view angle using the on-screen bar (see page 27).

While playing back or paused...

1 Display the view angle selection window.



2 Select the view angle.

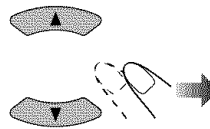

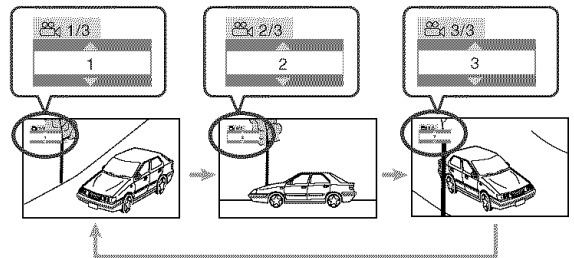

Ex.:



Special Picture Playback INFO

Still picture playback

To start still picture playback:	To resume normal playback:
While playing... 	DISC PLAY 

Frame-by-frame playback

1 While playing...



Still picture playback starts.

2 Advance the still picture frame by frame.



To resume normal playback, press **DISC PLAY** ►.

Slow-motion playback

1 While playing...



Still picture playback starts.

2 Select slow motion speed.

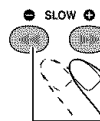

Forward slow motion starts.

Reverse slow motion* starts.

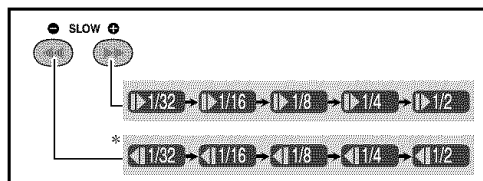

*Only for DVD Video.

To resume normal playback, press **DISC PLAY** ►.

Zoom Remote ONLY >>>

1 While playing...

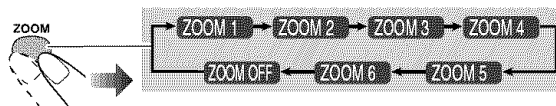

• As the number increases, magnification also increases.

2 Move the zoomed-in position.

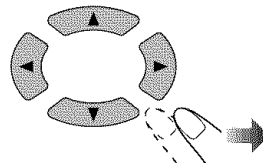

To resume normal playback, press **ZOOM** repeatedly until “**ZOOM OFF**” appears on the TV screen.

Advanced Disc Operations

Remote Control

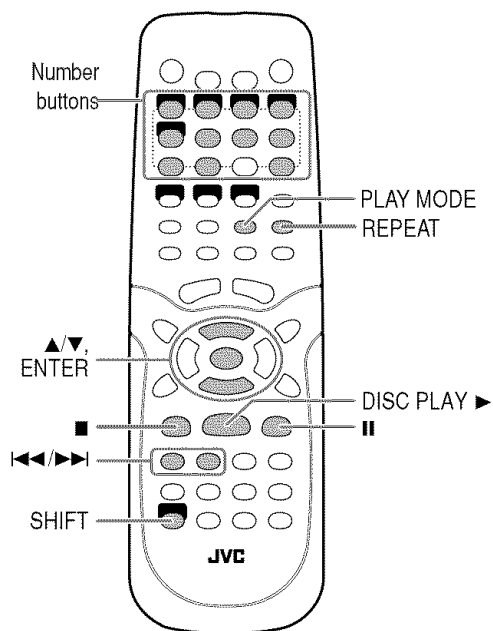

Main unit

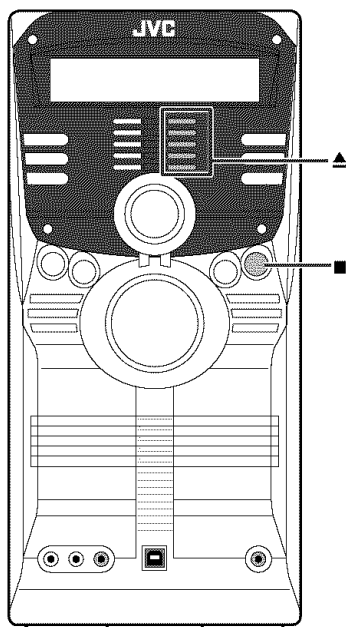

Programming the Playing Order

Program Play

You can arrange the playing order of the tracks (up to 99) before you start playback.

- Program play cannot be used for DVD-VR disc.

1 Before starting playback, activate Program Play.

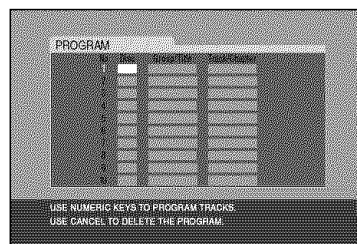
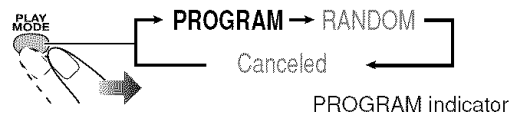

2 Select chapters or tracks you want for Program Play.

- For DVD/MP3/WMA:

- 1 Select a disc number
- 2 Select a title or group number.
- 3 Select a chapter or track number.

- For SVCD/VCD/CD:

- 1 Select a disc number
- 2 Select a track number.

- If the disc is not in the current tray, press ENTER to skip the group number entry before selecting a track.

To enter the numbers:

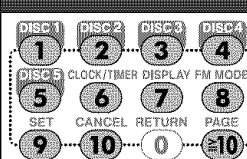

Examples:

- To select number 5, press 5.
- To select number 10, press 10.
- To select number 15, press ≥ 10 , 1, then 5.
- To select number 30, press ≥ 10 , 3, then 0.
- To select number 114, press ≥ 10 , ≥ 10 , 1, 1 then 4.

3 Repeat the steps 2 until you finish what you want to program.

4 Start playback.



Playback starts in the order you have programmed.

To skip a track:	To pause:	To stop:
	<p>To release, press DISC PLAY ►.</p>	<p>BEEP</p>

To check the programmed contents



Before or after playback...

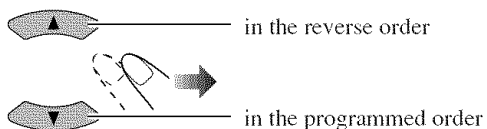

To modify the program



Before or after playback...

To erase the last entry:	To erase the entire program:
<p>(holding then...)</p>	<p>BEEP</p>
To add another entry to the program: Repeat step 2 on page 23.	

To exit from Program Play

Before or after playback...



Playing at Random



Random Play

INFO

You can play the contents of all tracks at random.

- Random play cannot be used for DVD-VR disc.

1 Before playback...

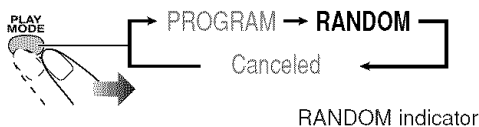

2 Start playback.



Playback starts in a random order. Random Play ends when all chapters/tracks are played.

To skip:	To pause:	To stop:
<p>To go to the beginning of the current track, press ◀◀.</p>	<p>To release, press DISC PLAY ►.</p>	<p>BEEP</p>

To exit from Random Play

Before or after playback...



Playing Repeatedly—Repeat Play

You can repeat playback.

- You can also select the repeat mode using the on-screen bar (see page 27).
- For JPEG and DVD-VR discs, see page 32.

• For DVD Video:

While playing...

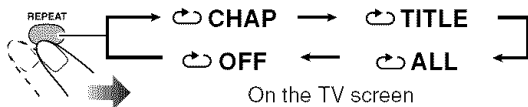

Before starting playback...

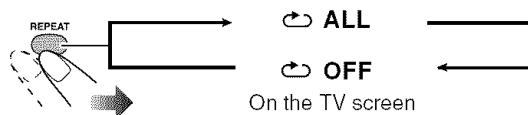

• For MP3/WMA:

While playing or before playback...

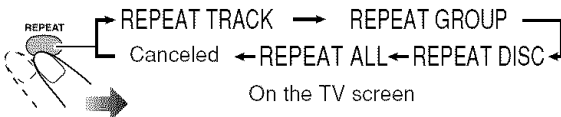

• For CD/SVCD/VCD:

While playing (without PBC for SVCD/VCD) or before playback...



• For Program Play mode:

While playing or before playback...

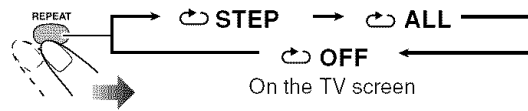

• For Random Play mode:

While playing or before playback...

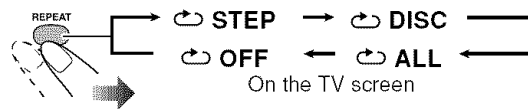

Indication		Meanings
Display window	TV screen	
REPEAT I	↻ CHAP, ↻ TRACK, REPEAT TRACK, ↻ (REPEAT) STEP	Repeats the current chapter/track.
REPEAT	↻ TITLE, ↻ GROUP, REPEAT GROUP	Repeats the current title/group.
REPEAT ALL*	↻ ALL, REPEAT ALL	Repeats all discs or all programmed tracks.
REPEAT I DISC*	↻ DISC, REPEAT DISC	Repeats the current disc.
No indication	↻ OFF	Selects to cancel Repeat Play mode.

*For DVD Video, REPEAT ALL and REPEAT I DISC may not be available depending on the disc.

Prohibiting Disc Ejection Child Lock

You can lock the disc trays so that no one can eject the loaded disc.

- This operation is possible only when the source is the disc player.

While the disc trays are closed...

1 Press for any disc tray while holding .

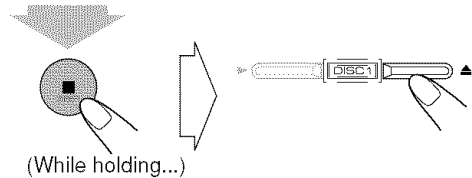

2 Release , then .

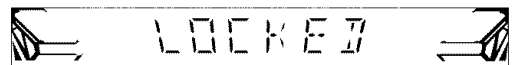

- If you try to eject discs while Tray Lock is in use, “LOCKED” appears to inform you that the disc trays are locked.

To cancel the prohibition, repeat the same procedure. “UNLOCKED” appears on the display.

On-Screen Disc Operations

Remote control

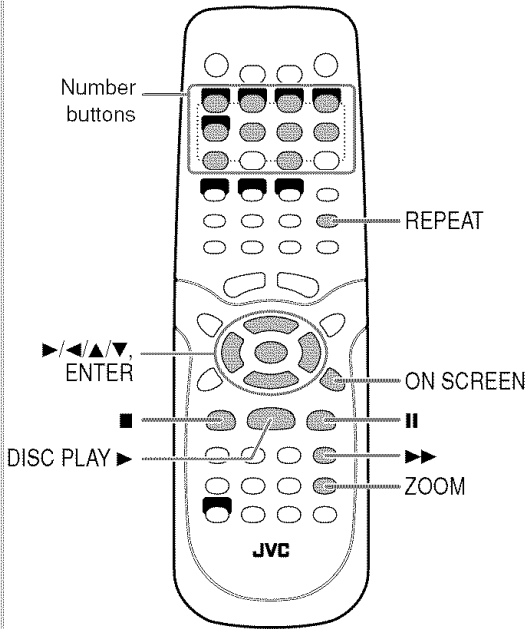

On-screen bars

See also page 27.

DVD Video

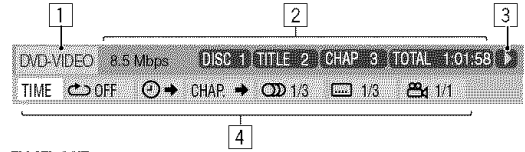

DVD-VR

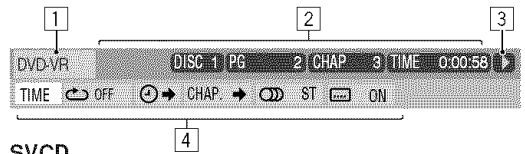

SVCD

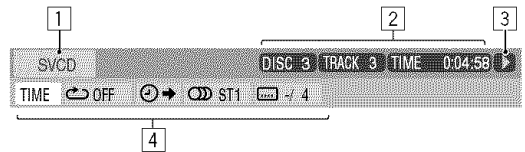

VCD

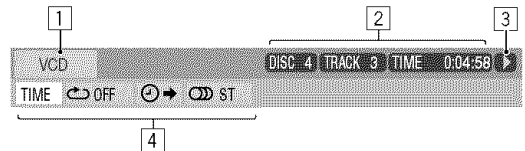

CD

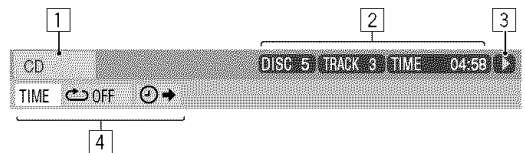

About the On-screen Bar

You can check the information on disc (except for MP3/WMA/JPEG disc) and use some functions through the on-screen bar.

On-screen bar

Ex.: While playing a DVD Video

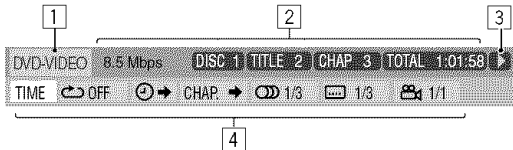

1 Disc type

2 Playback information

Indication	Meanings
Mbps	Current transfer rate (Megabits per second)
DISC 1	Current disc
TITLE 2	Current title
CHAP 3	Current chapter
GROUP 1	Current group
PG 2	Current title
PL 2	Current Play List
TRACK 14	Current track
TOTAL 1:25:58	Time indications

3 Playback conditions

Indication	Meanings
	Playback
	Forward/Reverse search
	Forward/Reverse slow-motion
	Pause
	Stop

4 Operation icons (on the pull-down menu)

Indication	Meanings
TIME	Select to change the time indication (see page 28).
	Select to repeat playback (see pages 25, 28 and 29).
	Select for time search (see page 29).
CHAP →	Select for chapter search (see page 30).
TRACK →	Select for track search (see page 30).
1/3	Select to change the audio language or channel (see page 20).
1/3	Select to change subtitle language (see page 21).
1/3	Select to change the view angle (see page 21).

Operations Using the On-screen Bar



INFO

Basic operation procedure through the on-screen bar is as follows:

Ex.: Selecting a subtitle (French) for DVD Video While a disc is selected as the source...

1 Display the on-screen bar with the pull-down menu.

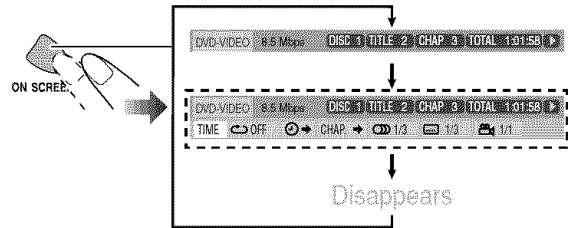

2 Select (highlight) the item you want.

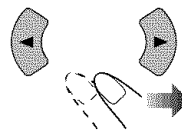

3 Display the pop-up window.

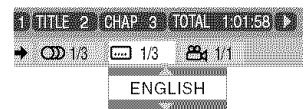

4 Select the desired option in the pop-up window.



5 Finish the setting.



Pop-up window disappears.

To erase the on-screen bar



Changing the time information

You can change the time information in the on-screen bar and the display window on the main unit.

1 Display the on-screen bar with the pull-down menu.



2 Make sure **TIME** is selected (highlighted).

3 Change the time indication.



TOTAL	<ul style="list-style-type: none"> • For DVD Video: Elapsed playing time of the title/group. • For CD/SVCD/VCD: Elapsed time of disc.
T.REM	<ul style="list-style-type: none"> • For DVD Video: Remaining time of the title/group. • For CD/SVCD/VCD: Remaining time of disc.
TIME*	Elapsed playing time of the current chapter/track.
REM*	Remaining time of the current chapter/track.

* Not available for DVD-VR.

To erase the on-screen bar



Repeat Play

• See also page 25.

1 While playing a disc (without PBC for SVCD/VCD), display the on-screen bar with the pull-down menu.

2 Select .

3 Display the pop-up window.

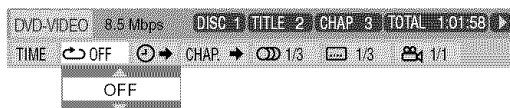

4 Select the repeat mode you want.

ALL**	Repeats all discs.
A-B	Repeats a desired portion (see page 29).
TITLE	Repeats the current title.
GROUP	Repeats the current group.
DISC**	Repeats the disc.
CHAPTER	Repeats the current chapter.
TRACK*	Repeats the current track.
OFF	Cancels Repeat Play.

* During Program Play or Random Play, "STEP" appears.

** For DVD Video, ALL (REPEAT ALL) and DISC (REPEAT 1 DISC) may not be available depending on the disc.

• Repeat modes depend on the current playback disc. Refer to page 25.

5 Finish the setting.

Pop-up window goes off.



To cancel Repeat Play, select "OFF" in step 4.

To erase the on-screen bar



A-B Repeat

- A-B repeat is not available for MP3/WMA and some DVDs.

- 1 While playing, display the on-screen bar with the pull-down menu.
- 2 Select .
- 3 Display the pop-up windows.

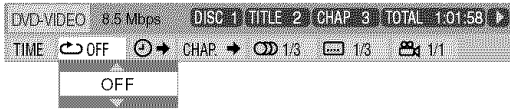

- 4 Select "A-B."

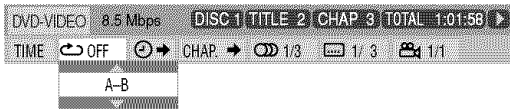

- 5 Select the start point (A).

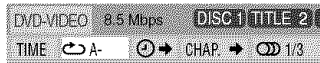

- 6 Select the end point (B).



A-B Repeat starts. The selected portion plays repeatedly.

- Before pressing ENTER, you can search for the end point using .

Time Search

You can move to a particular point by specifying the elapsed playing time from the beginning.

- 1 While playing (without PBC for SVCD/VCD), display the on-screen bar with the pull-down menu.
 - Except for DVD Video/DVD-VR: Time Search can be used before starting playback.
- 2 Select .
- 3 Display the pop-up window.



- 4 Enter the time.

You can specify the time in hours/minutes/seconds.

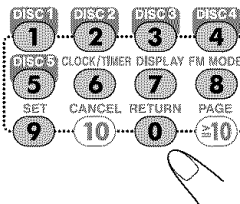

Examples:

To move to a point of 1 (hours): 02 (minutes): 00 (seconds), press 1, 0, 2, 0, then 0.

To move to a point of 54 (minutes): 00 (seconds), press 0, 5, 4, 0, then 0.

- It is always required to enter the hour digit (even "0" hour), but it is not required to enter trailing zeros (the last two digits in the examples above).
- **To correct a misentry**, press cursor  to erase the last entry.

- 5 Finish the setting.



The System starts playing from the specified time.

To remove the on-screen bar



Chapter/Track Search

You can search for the chapter (DVD Video/DVD-VR) number to play.

- 1 While playing, display the on-screen bar with the pull-down menu.
- 2 Select **CHAP. →** or **TRACK →**.
- 3 Display the pop-up window.

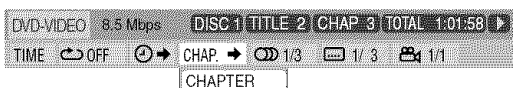

- 4 Enter the desired chapter/track number.

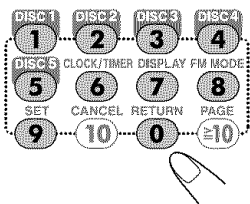

Examples:

To select chapter/track 5, press 5.

To select chapter/track 15, press 1, then 5.

To select chapter/track 30, press 3, then 0.

- To correct a misentry, press the number buttons until the desired number shown in the pop-up window.

- 5 Finish the setting.



The System starts playing the searched chapter or track.

To erase the on-screen bar



Operations on the control Screen

Remote ONLY

You can search for and play the desired items through the control screen.

Control screen for MP3/WMA and JPEG disc

The control screen automatically appears on the TV screen when you load an MP3/WMA or a JPEG disc.

- If both types of files (MP3/WMA and JPEG files) are recorded on a disc, select the file type to play (see page 37).

control screen

Ex.: When the MP3 disc is loaded.

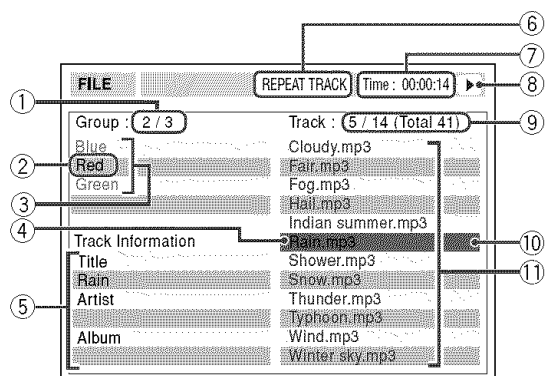



- 1 Current group number/total group number
- 2 Current group
- 3 Group list
- 4 Current track
- 5 Track information (ID3 Tag Version 1.0: only for MP3/WMA)
- 6 Repeat Play setting
- 7 Elapsed playing time of the current track (only for MP3/WMA)
- 8 Operation mode icon
- 9 Current track number/total number of tracks in the current group (total number of tracks on the loaded disc)
- 10 Highlight bar
- 11 Track list

Continue on the next page

Control screen for DVD-R/-RW in DVD-VR format

The control screen is superimposed on the TV screen when you call up Original Program (PG) or Play List (PL).

To select playback type

To select the Program List:	To select the Play List:
	
Playback starts.	
To erase the list, press the same button again.	

control screen

Ex.: When Program List is selected.

ORIGINAL PROGRAM				
No	Date	Ch	Time	Title
1	03/12/04	L	12:15	La fleur
2	09/12/04	L	23:05	The last struggle
3	18/12/04	L	08:17	free flyer
4	20/12/04	L	07:47	BOOM!
5	25/12/04	L	19:38	Mr. Lawrence
6	28/12/04	L	14:20	Satisfy U

① ② ③ ④ ⑤ ⑥

Ex.: When Play List is selected.

PLAY LIST				
No	Date	Chap	Length	Title
1	03/12/04	002	0:23:24	Nebula G.
2	15/12/04	004	1:04:39	CDJ
3	24/12/04	013	0:41:26	Secret Garden
4	27/12/04	017	0:09:08	S. Walker

① ② ⑦ ⑧ ⑥

- ① Listed number
- ② Recording date
- ③ Recording channels
- ④ Recording time
- ⑤ Title
- ⑥ Highlight bar (current selection)
- ⑦ Chapters included
- ⑧ Playback time

To move the highlight bar between group list and track list

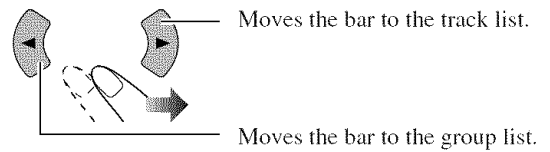

- While playing an MP3/WMA disc, selecting list starts playback. Before playing, selecting list does not start playback.

To select an item in the list

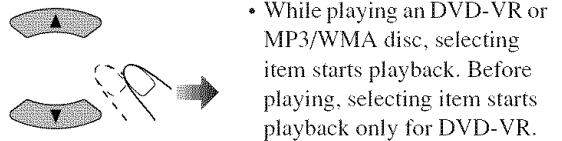

To start playback

For MP3/WMA/DVD-VR:



- Playback starts with the selected track.
- Pressing DISC PLAY ► also starts playback.

For JPEG:



The selected track (still picture) is displayed until you change it.



Slide-show playback starts. Each track (still picture) is shown on the screen for a few seconds, then changes one after another.

- Once you start playing back a JPEG track, the CONTROL screen goes off.
- To cancel slide-show, and display the current still picture, press ■.

To stop playback

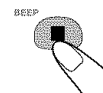

To repeat slide-show for JPEG

Before starting playback...

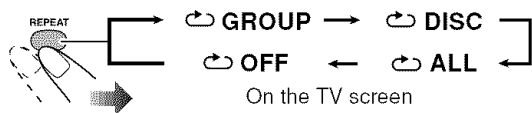

Indication		Meanings
Display window	TV screen	
REPEAT	↻ GROUP	Repeats the current group.
REPEAT 1 DISC	↻ DISC	Repeats the current disc.
REPEAT ALL	↻ ALL	Repeats all discs.
No indication	↻ OFF	Selects to cancel Repeat Play mode.

• For Repeat Play of MP3/WMA, see page 25.

To repeat playback for DVD-VR

While playing an original program...

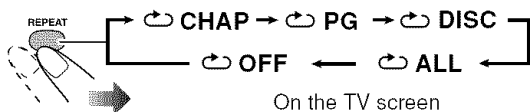

While playing a Play List...

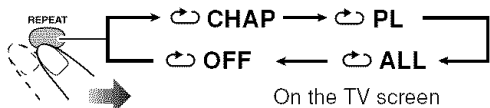

Indication		Meanings
Display window	TV monitor	
REPEAT 1	↻ CHAP	Repeats the current chapter.
REPEAT	↻ PG	Repeats the current program.
REPEAT	↻ PL	Repeats the current Play List.
REPEAT 1 DISC	↻ DISC	Repeats the current disc.
REPEAT ALL*	↻ ALL*	Repeats all discs.
No indication	↻ OFF	Selects to cancel Repeat Play mode.

* REPEAT ALL (↻ ALL) may not be available depending on the disc.

To zoom in the still picture

1 During playback is paused...

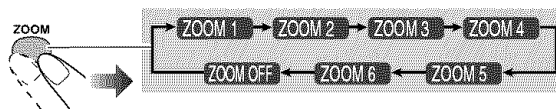

• As the number increases, magnification also increases.

2 Move the zoomed-in position.

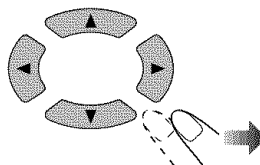

To resume normal playback, press ZOOM repeatedly until "ZOOM OFF" appears on the TV screen.

Timer Operations

Remote control

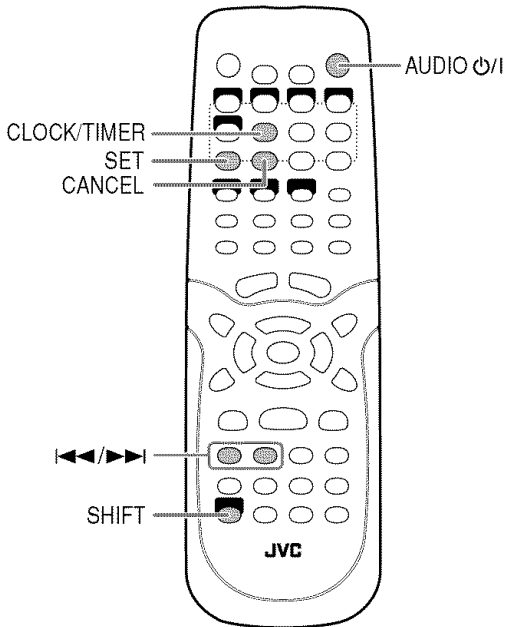

Setting the Timer Remote ONLY INFO

Using Daily Timer, you can wake up with your favorite song.

- To correct a misentry during the process, press CANCEL (while holding SHIFT). You can return to the previous step.

1 Select the timer setting mode for Daily Timer—"TIMER ON."

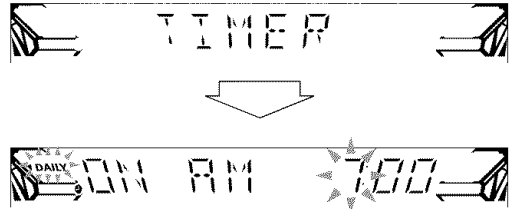
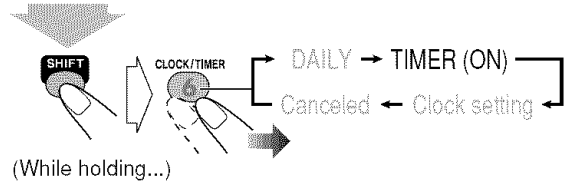

2 Set the hour then minute for on-time.

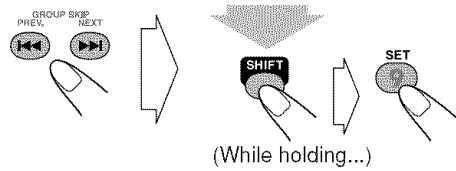

3 Enter the off-time setting mode.

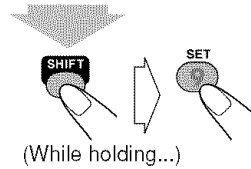

4 Set the hour then minute for off-time.

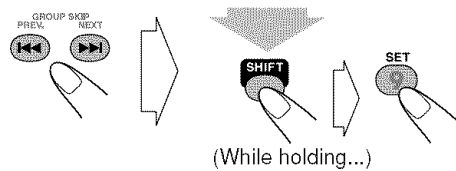

5 Select the playback source—“TUNER FM,” “TUNER AM,” “CD,” “AUX,” or “USB.”

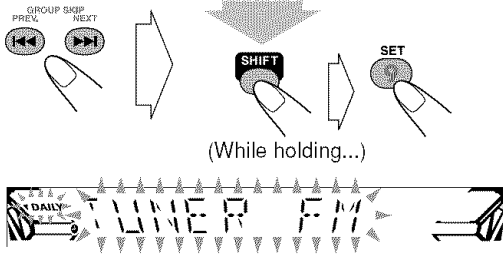

(While holding...)

Ex.: When “TUNER FM” is selected.

- When you select “TUNER FM” or “TUNER AM,” repeat the procedure to select a preset station.

6 Select the volume level.

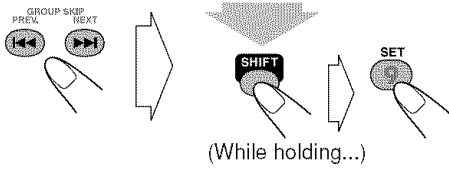

(While holding...)

7 Turn off the System (on standby) if you have set the timer with the System turned on.



How Daily Timer works

Once the Daily Timer has been set, the timer (🕒) indicator and DAILY indicator are lit on the display. Daily Timer is activated at the same time everyday until the timer is turned off manually (see the next column).

When the on-time comes

The System turns on, tunes in to the specified station or starts playing the specified source, and sets the volume level to the preset level.

When the off-time comes

- The System stops playback, and turns off (standby).
- The timer setting remains in memory until you change it.

To turn off Daily Timer

Since Daily Timer is activated at the same time everyday, you may need to cancel it on some particular days.

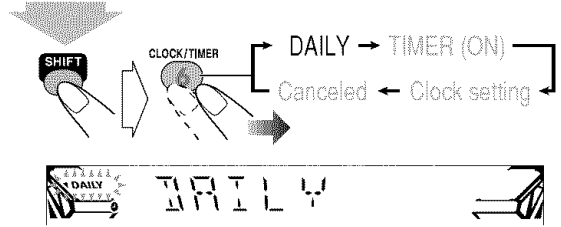

(While holding...)

- The timer (🕒) indicator goes off.

To turn on the timer again...

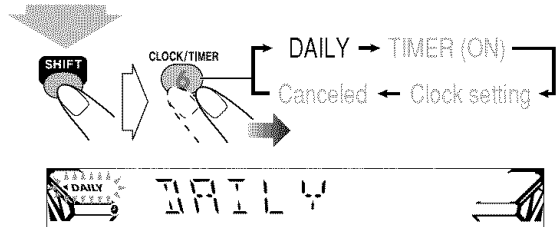

(While holding...)

Set up Menu Operations

Remote control

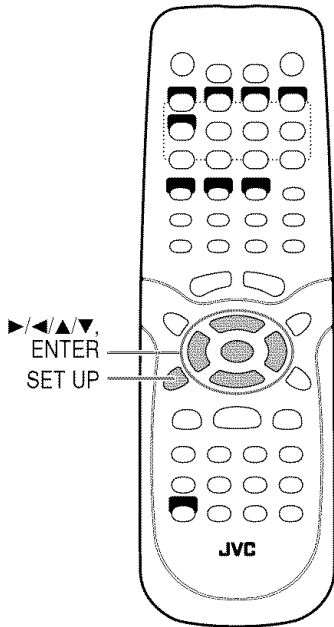

Set up Menu Icons

The icon for the selected Set up Menu will be highlighted.

Ex.: LANGUAGE Set up Menu is selected.

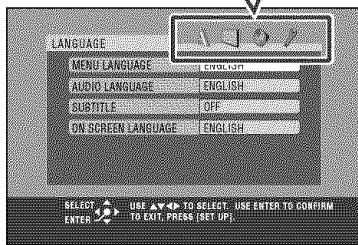
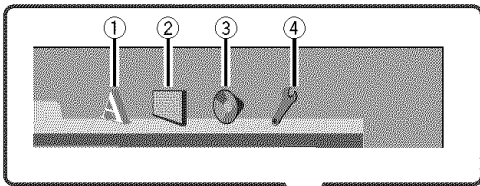

- ① LANGUAGE Set up Menu
- ② PICTURE Set up Menu
- ③ AUDIO Set up Menu
- ④ OTHERS Set up Menu

Operating Procedure



You can use the Set up Menus only when a disc is selected as the source and its playback is not yet started.

Ex.: Selecting "STILL PICTURE" for "FILE TYPE":

1 Show the set up menu.



2 Select one of the set up menus.

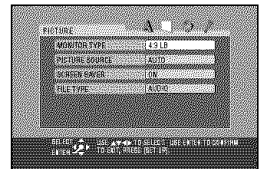
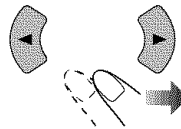

3 Select the item you want to adjust.

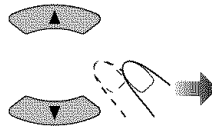

4 Display the pop-up window.

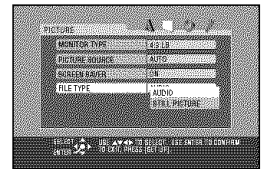

5 Select the desired option in the pop-up window.

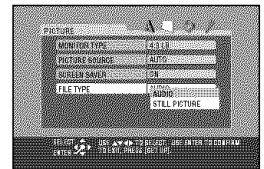
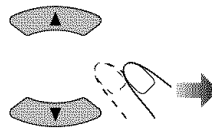

6 Finish the setting.



- 7 Repeat steps 3 to 4 to set other items on the same Set up Menu.
Repeat steps 2 to 4 to set other items on another Set up Menu.

To remove the Set up Menu



■ LANGUAGE Set up Menu

INFO

You can select the initial languages for disc playback. You can also select the language shown on the TV screen while operating this System.

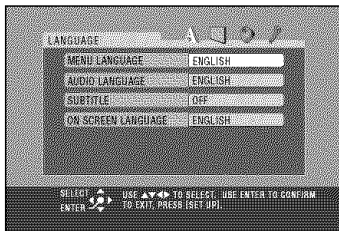

MENU LANGUAGE

Some discs have multiple menu languages. Select from—ENGLISH, SPANISH, FRENCH, CHINESE, GERMAN, ITALIAN, JAPANESE, RUSSIAN, AA – ZU (see “Language Code List” on page 44).

AUDIO LANGUAGE

Some discs have multiple audio languages. Select from—ENGLISH, SPANISH, FRENCH, CHINESE, GERMAN, ITALIAN, JAPANESE, RUSSIAN, AA – ZU (see “Language Code List” on page 44).

SUBTITLE

Some discs have multiple subtitle languages. Select from—ENGLISH, SPANISH, FRENCH, CHINESE, GERMAN, ITALIAN, JAPANESE, RUSSIAN, AA – ZU (see “Language Code List” on page 44) or “OFF (no subtitle).”

ON SCREEN LANGUAGE

Select one of the languages shown on the TV from—ENGLISH, SPANISH, and FRENCH.

■ PICTURE Set up Menu

INFO

You can select the desired options concerning a picture or monitor screen.

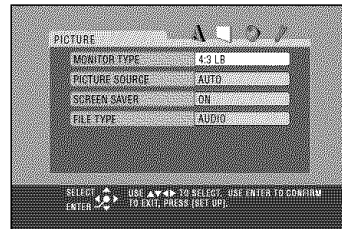

MONITOR TYPE

You can select the monitor type of your TV when you play DVD Video recorded with aspect ratio of 16:9.

Select one of the following settings:

16:9 (Wide television conversion):

Select when the aspect ratio of your TV is 16:9 (wide TV) and when the TV has the screen size adjustment function.

4:3 LB (Letter Box):

Select when the aspect ratio of your TV is 4:3 (conventional TV). While viewing a wide screen picture, the black bars appear on the top and the bottom of the screen.

4:3 PS (Pan Scan):

Select when the aspect ratio of your TV is 4:3 (conventional TV). While viewing a wide screen picture, the black bars do not appear; however, the left and right edges of the pictures will not be shown on the screen.

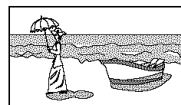

Ex.: 16:9

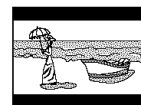

Ex.: 4:3 LB

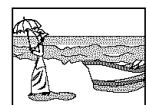

Ex.: 4:3 PS

PICTURE SOURCE

You can obtain optimal picture quality by selecting an appropriate option—picture source type (either video source or film source).

Select one of the following:

AUTO: Normally select this.
When playing back a disc containing both video and film sources, the System automatically changes the processing to match it to the picture type (film or video source) of the current chapter.

FILM: To play a film source disc.

VIDEO: To play a video source disc.

SCREEN SAVER

You can activate or deactivate screen saver while operating the built-in disc player.

Select one of the following:

ON: The picture on the TV becomes dark when no operation is done for about 5 minutes.

OFF: To cancel the screen saver.

FILE TYPE

If both audio tracks (MP3/WMA files) and still picture (JPEG files) are recorded on a disc, you can select which to play.

Select one of the following:

AUDIO: To play MP3/WMA files.

STILL PICTURE: To play JPEG files.

AUDIO Set up Menu

INFO

You can adjust the sound settings of the System.



DIGITAL AUDIO OUTPUT

When using the digital output terminal on the rear, set this correctly according to the connected component.

Select one of the following:

PCM ONLY: To connect to a linear PCM digital equipment such as an MD recorder.

DOLBY DIGITAL /PCM: To connect to a Dolby Digital decoder or an amplifier with a built-in Dolby Digital decoder.

STREAM/PCM: To connect to a DTS decoder or an amplifier with a built-in DTS decoder.

• See also “OPTICAL DIGITAL OUTPUT Signals” on page 43.

DOWN MIX

When playing a multi-channel DVD, the System converts the signals into 2 channels.

Down mix setting is effective for the speaker output (and digital audio output if “DIGITAL AUDIO OUTPUT” is set to “PCM ONLY”) from this System.

Select one of the following:

STEREO: To connect a conventional stereo amplifier, receiver, MD player, TV, etc.

DOLBY SURROUND: To connect an amplifier with the Dolby Pro Logic decoder.

D. RANGE COMPRESSION

You can compress the dynamic range (the difference between the loudest sound and the softest sound) to enjoy a powerful sound even at a low volume level when listening to Dolby Digital software. This is useful at night.

- The effectiveness varies depends on a software.

Select one of the following:

AUTO: To enjoy powerful sounds with full dynamic range.

ON: Best for watching a movie at a low volume level.

■ OTHERS Set up Menu

INFO

You can change some other convenient functions.

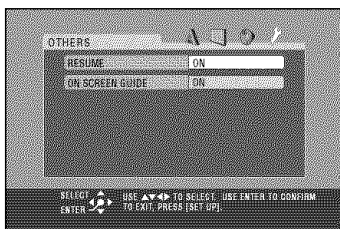

RESUME

You can activate or deactivate Resume for disc playback (see page 12).

Select one of the following:

ON: To activate Resume.

OFF: To cancel Resume.

ON SCREEN GUIDE

You can activate or deactivate the on-screen guide icons (see page 12).

- When recording the picture on a VCR, select "OFF" to avoid recording the guide icons on your video tape.

Select one of the following:

ON: To activate the on-screen guide icons.

OFF: To cancel the on-screen guide icons.

Operating the TV

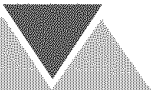

Remote control

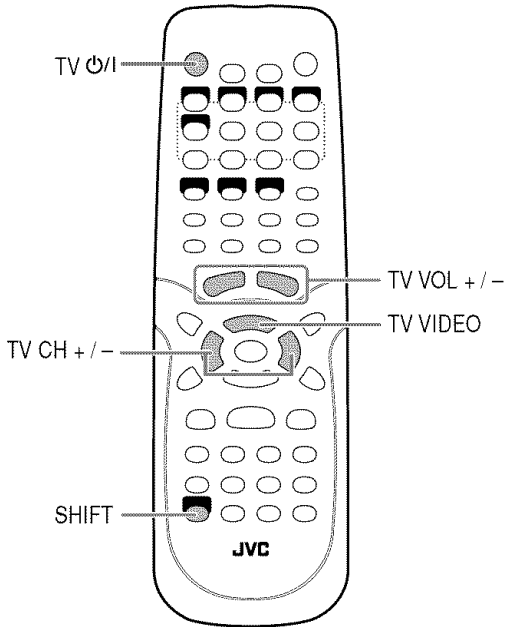

Operating TV

You can operate the JVC's TV using this remote control.

To turn on or off the TV:



To select the input mode (either TV or VIDEO):

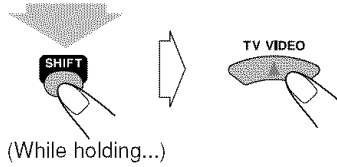

To adjust TV volume:

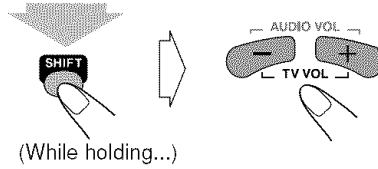

To select the TV channel:

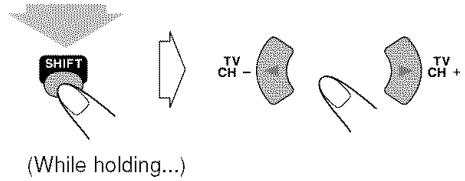

Additional Information

Learning More about This System

Before Operating the System (see page 3)

Playable Disc Types:

• About audio format

- **Linear PCM:** Uncompressed digital audio, the same format used for CDs and most studio masters.
- **Dolby Digital:** Compressed digital audio, developed by Dolby Laboratories, which enables multi-channel encode to create the realistic surround sound.
- **DTS (Digital Theater Systems):** Compressed digital audio, developed by Digital Theater Systems, Inc., which enables multi-channel like Dolby Digital. As the compression ratio is lower than for Dolby Digital, it provides wider dynamic range and better separation.

Daily Operations—Playback (see pages 10 to 15)

Listening to the Radio:

- If you store a new station into an occupied preset number, the previously stored station in that number will be erased.
- When you unplug the AC power cord or if a power failure occurs, the preset stations will be erased in a few days. If this happens, preset the stations again.

Playing Back a Disc:

- On some DVD, SVCD, or VCD discs, the actual operations may be different from what is explained in this manual, due to the programming and disc structure; such differences are not a malfunction of this System.
- For DVD-VR playback...
 - This unit cannot play back DVD-VR disc with CPRM (Content Protection for Recordable Media).
 - When making a disc, use UDF-Bridge format.
 - For details about DVD-VR format and playlist, refer to the manual of the recording equipment.
 - You cannot use reverse slow motion, Program Play, and Random Play.
- For MP3/WMA/JPEG playback...
 - MP3/WMA/JPEG discs are required a longer readout time than regular CDs. (It depends on the complexity of the group/file configuration.)
 - Some MP3/WMA/JPEG files cannot be played back and will be skipped. This results from their recording processes and conditions.
 - When making MP3/WMA/JPEG discs, use ISO 9660 Level 1 or Level 2 for the disc format.
 - This system can play back MP3/WMA/JPEG files with the extension code <.mp3>, <.wma> or <.jpg> (regardless of the letter case—upper/lower).
 - It is recommended that you make each MP3/WMA file at a sampling rate of 44.1 kHz and at bit rate of 128 kbps. This System cannot play back files made at bit rate of less than 64 kbps.

Playing Back from the PC:

- Check if your PC equipped with the CD-ROM drive is running on Windows® 98*, Windows® 98SE*, Windows® Me*, Windows® 2000*, or Windows® XP* and prepare its CD-ROM.
- DO NOT turn off the System or disconnect the USB cable while installing the drivers or until your PC has recognized the System.
- Use a full speed USB cable (version 1.1).
- If your PC does not recognize the System, disconnect the USB cable and connect it again. If this does not work, restart Windows.
- The drivers installed can be recognized only when the USB cable is connected between the System and your PC.
- The sound may not be played back correctly—interrupted or degraded—due to your PC settings or PC specifications.

*Microsoft®, Windows® 98, Windows® 98SE, Windows® Me, Windows® 2000 and Windows® XP are registered trademarks of Microsoft corporation.

Playing Back from Other External Equipment:

- When enjoying a video game with your game machine connected to this System, connect this System and your TV/monitor with the composite video cable.

Daily Operations—Sound and Other Adjustments (see pages 16 to 19)

Adjusting the Volume:

- Be sure to turn down the volume before connecting or putting the headphones.
- When you turn off the System with the volume level set to “VOL 16” or higher, the volume level is reset to “VOL 15” next time you turn on the System.

Selecting the Sound Modes:

- Sound Modes do not take effect while game is selected as the source.

Selecting 3D Phonic Mode:

- 3D Phonic function also affects the sound through the headphones.
- 3D Phonic setting is also applied to the optical digital output signals through the DIGITAL OUTPUT (OPTICAL) terminal.

Changing the Picture Tone:

- If no operation is done for about 10 seconds, the VFP setting screen disappears.

Setting the Clock:

- “—:—:—” will flash on the display until you set the clock.
- The clock may gain or lose 1 to 2 minutes per month. If this happens, reset the clock.

Turning Off the Power Automatically:

- If you turn off the System, Sleep Timer is canceled.

Unique DVD/VCD Operations (see pages 20 to 22)

Selecting the Sound Track:

On some DVD videos, you cannot change audio languages while playing back.

Special Picture Playback:

- During slow-motion playback, no sound will be reproduced.
- While zoomed in, the picture may look coarse.
- You cannot use frame-by-frame playback for DVD-VR.

Advanced Disc Operations (see pages 23 to 25)

Programming the Playing Order—Program Play:

- While programming steps...
 - If you try to program a disc number on which the System has detected no disc is loaded, “⊘” appears on the TV screen.
 - Your entry will be ignored if you have tried to program an item number that does not exist on the disc (for example, selecting track 14 on a disc that only has 12 tracks). Such entries are ignored.
 - When you enter the group number for SVCD/VCD/CD which is not in the current tray, the System will ignore these entries during playback.
- You cannot use Program Play and Random Play for DVD-VR and JPEG discs.
- If you try to add a 100th track, “FULL” appears on the display.
- The program contents will be erased when...
 - You unplug the AC power cord.
 - You open the disc tray currently selected (regardless of the play mode).

Playing at Random—Random Play:

- Random Play cannot be used on some DVD discs.

On-Screen Disc Operations (see pages 26 to 32)

Operations Using the On-screen Bar:

- **A-B Repeat:**
 - For DVD Video, A-B Repeat is possible only within the same title.
 - For SVCD/VCD/CD, A-B Repeat is possible only within the same track.

Operations on the control Screen:

- For DVD-VR playback...
 - **Original Program:** The System can play back the original picture in the recorded order.
 - **Play List:** The System can play back the play list edited by the recording equipment. The control screen for the play list appears only when the disc has the play list.
 - Resume is not available.
 - For details about DVD-VR format and play list, refer to the manual of the recording equipment.

- For JPEG files playback...
 - It is recommended that you record a file at 640 x 480 resolution. (If a file has been recorded at a resolution of more than 640 x 480, it will take a long time to be shown.)
 - This System can play only baseline JPEG files*. Progressive JPEG files* or lossless JPEG files* cannot be played.

* Baseline JPEG format: Used for digital cameras, web, etc.

Progressive JPEG format: Used for web.

Lossless JPEG format: An old type and rarely used now.

- This unit may not play back JPEG files properly which are recorded by the devices other than digital still camera.
- During Slide-show playback, zoom cannot be operated.

Timer Operations (see pages 33 and 34)

Setting the Timer:

- When you select “CD” for the playback source, playback starts from the beginning of the current disc when timer is activated.
- When you unplug the AC power cord or if a power failure occurs, the timer will be canceled. You need to set the clock first, then the timer again.
- If you set DVD Video as the source, Daily Timer may not work correctly.

Set up Menu Operations (see pages 35 to 38)

LANGUAGE Set up Menu:

- When the language you have selected for MENU LANGUAGE, AUDIO LANGUAGE, or SUBTITLE is not recorded on a disc, the original language is used as the initial language.

PICTURE Set up Menu—MONITOR TYPE:

- Even if “4:3 PS” is selected, the screen size may become 4:3 letter box with some DVD Videos. This depends on how the discs are recorded.
- When you select “16:9” for a picture whose aspect ratio is 4:3, the picture slightly changes due to the process for converting the picture width.

AUDIO Set up Menu—DOWN MIX:

- This setting is not effective when DTS multi-channel software is played back.

OTHERS Set up Menu—ON SCREEN GUIDE:

- The set up menu and on-screen bar will be displayed (and recorded) even though this function is set to “OFF.” Subtitles and the information for zooming in always appear on the display regardless of this setting.

Maintenance

To get the best performance of the System, keep your discs clean.

Handling discs

- Remove the disc from its case by holding it at the edge while pressing the center hole lightly.
- Do not touch the shiny surface of the disc, or bend the disc.
- Put the disc back in its case after use to prevent warping.
- Be careful not to scratch the surface of the disc when placing it back in its case.
- Avoid exposure to direct sunlight, extreme temperature, and moisture.

To clean the disc:

Wipe the disc with a soft cloth in a straight line from center to edge.

Cleaning the System

- Stains should be wiped off with a soft cloth. If the System is heavily stained, wipe it with a cloth soaked in water-diluted neutral detergent and wrung well, then wipe clean with a dry cloth.
- Since the System may deteriorate in quality, become damaged or get its paint peeled off, be careful about the following:
 - DO NOT wipe it with a hard cloth.
 - DO NOT wipe it forcefully.
 - DO NOT wipe it with thinner or benzine.
 - DO NOT apply any volatile substance such as insecticides to it.
 - DO NOT allow any rubber or plastic to remain in contact for a long time.

Troubleshooting

If you are having a problem with your System, check this list for a possible solution before calling for service.

General:

Adjustments or settings are suddenly canceled before you finish.

⇒ There is a time limit. Repeat procedure again.

Operations are disabled.

⇒ The built-in microprocessor may malfunction due to external electrical interference. Unplug the AC power cord and then plug it back in.

Unable to operate the System from the remote control.

⇒ The path between the remote control and the remote sensor on the System is blocked.

⇒ The batteries are exhausted.

No sound is heard.

⇒ Speaker connections are incorrect or loose.

⇒ Headphones are connected.

No picture appears on the screen.

⇒ The video cord connections are incorrect or loose.

No picture is displayed on the TV screen, the picture is blurred, or the picture is divided into two parts.

⇒ The System is connected to a TV which does not support progressive video input.

The left and right edges of the picture are missing on the screen.

⇒ Select “4:3 LB” for “MONITOR TYPE” (see page 36)

Radio Operations:

Hard to listen to broadcasts because of noise.

⇒ Antennas connections are incorrect or loose.

⇒ The AM loop antenna is too close to the System.

⇒ The FM antenna is not properly extended and positioned.

Disc Operations:

The disc does not play.

⇒ The disc is placed upside down. Place the disc with the label side up.

MP3/WMA groups and tracks are not played back as you expect.

⇒ The playing order is determined when the disc was recorded. It depends on the writing application.

MP3/WMA or JPEG files are not played back.

⇒ The inserted disc may include both types of tracks (MP3/WMA files and JPEG files). In this case, you can only play back the files selected by the “FILE TYPE” setting (see page 37).

⇒ You have changed the “FILE TYPE” setting after you inserted a disc. In this case, reload the disc.

The disc sound is discontinuous.

⇒ The disc is scratched or dirty.

No subtitle appears on the display though you have selected the initial subtitle language.

⇒ Some DVDs are programmed to always display no subtitle initially. If this happens, press SUBTITLE after starting play (see page 21).

Audio language is different from the one you have selected as the initial audio language.

⇒ Some DVDs are programmed to always use the original language initially. If this happens, press AUDIO after starting play (see page 20).

The disc tray does not open or close.

⇒ The AC power cord is not plugged in.

⇒ Child Lock is in use (see page 25).

⇒ Program Play is in use. Exit from Program Play (see page 24).

USB Operations:

Unable to play back through the USB connection.

⇒ USB connection and setting is incorrect (see page 14).

The sound through the USB connection stops.

- ⇒ Noise and static electricity may stop the sound through the USB connection. In this case, do the following operations:
- Disconnect and connect the USB cable again
 - Restart the music software on your PC
 - Turn off and on the system

Timer operations:

Daily Timer does not work.

- ⇒ The System has been turned on when the on-time comes.
 Timer starts working only when the System is turned off.

If you still have a problem, reset the System.

While in standby...

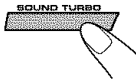

Press and hold until the display flashes.

The factory default settings are restored and all the settings you have made are erased.

OPTICAL DIGITAL OUTPUT Signals

DIGITAL AUDIO OUTPUT	Output Signals		
	STREAM/PCM	DOLBY DIGITAL/PCM	PCM ONLY
Playback disc			
DVD VIDEO	48 kHz, 16 bit Linear PCM* ¹		
with 48 kHz, 16/20/24 bit Linear PCM	48 kHz, 16 bit Linear PCM		
with 96 kHz, Linear PCM	48 kHz, 16 bit Linear PCM		
with Dolby Digital	Dolby Digital bitstream		48 kHz, 16 bit Linear PCM
with DTS Digital Surround	DTS bitstream	48 kHz, 16 bit Linear PCM	
DVD-R/-RW in DVD-VR format	48 kHz, 16 bit Linear PCM*		
with 48 kHz, 16/20/24 bit Linear PCM	48 kHz, 16 bit Linear PCM		
with Dolby Digital	Dolby Digital bitstream		48 kHz, 16 bit Linear PCM
SVCD, VCD, CD	44.1 kHz, 16 bit Linear PCM/48 kHz, 16 bit Linear PCM		
CD with DTS Digital Surround	DTS bitstream	44.1 kHz, 16 bit Linear PCM	
MP3/WMA disc	No output		

* While playing some DVDs, digital signals may be emitted at 20 bits or 24 bits (at their original bit rate) through the DIGITAL OUTPUT (OPTICAL) terminal if the discs are not copy-protected.

Language Code List

AA	Afar
AB	Abkhazian
AF	Afrikaans
AM	Ameharic
AR	Arabic
AS	Assamese
AY	Aymara
AZ	Azerbaijani
BA	Bashkir
BE	Byelorussian
BG	Bulgarian
BH	Bihari
BI	Bislama
BN	Bengali, Bangla
BO	Tibetan
BR	Breton
CA	Catalan
CO	Corsican
CS	Czech
CY	Welsh
DA	Danish
DZ	Bhutani
EL	Greek
EO	Esperanto
ET	Estonian
EU	Basque
FA	Persian
FI	Finnish
FJ	Fiji
FO	Faroese
FY	Frisian
GA	Irish
GD	Scots Gaelic
GL	Galician
GN	Guarani
GU	Gujarati
HA	Hausa
HI	Hindi
HR	Croatian
HU	Hungarian
HY	Armenian
IA	Interlingua
IE	Interlingue
IK	Inupiak
IN	Indonesian
IS	Icelandic
IW	Hebrew
JI	Yiddish

JW	Javanese
KA	Georgian
KK	Kazakh
KL	Greenlandic
KM	Cambodian
KN	Kannada
KO	Korean (KOR)
KS	Kashmiri
KU	Kurdish
KY	Kirghiz
LA	Latin
LN	Lingala
LO	Laothian
LT	Lithuanian
LV	Latvian, Lettish
MG	Malagasy
MI	Maori
MK	Macedonian
ML	Malayalam
MN	Mongolian
MO	Moldavian
MR	Marathi
MS	Malay (MAY)
MT	Maltese
MY	Burmese
NA	Nauru
NE	Nepali
NL	Dutch
NO	Norwegian
OC	Occitan
OM	(Afan) Oromo
OR	Oriya
PA	Panjabi
PL	Polish
PS	Pashto, Pushto
PT	Portuguese
QU	Quechua
RM	Rhaeto-Romance
RN	Kirundi
RO	Rumanian
RU	Russian
RW	Kinyarwanda
SA	Sanskrit
SD	Sindhi
SG	Sangho
SH	Serbo-Croatian
SI	Singhalese
SK	Slovak

SL	Slovenian
SM	Samoan
SN	Shona
SO	Somali
SQ	Albanian
SR	Serbian
SS	Siswati
ST	Sesotho
SU	Sundanese
SV	Swedish
SW	Swahili
TA	Tamil
TE	Telugu
TG	Tajik
TH	Thai
TI	Tigrinya
TK	Turkmen
TL	Tagalog
TN	Setswana
TO	Tonga
TR	Turkish
TS	Tsonga
TT	Tatar
TW	Twi
UK	Ukrainian
UR	Urdu
UZ	Uzbek
VI	Vietnamese
VO	Volapuk
WO	Wolof
XH	Xhosa
YO	Yoruba
ZU	Zulu

Parts Index

Refer to the pages to see how to use the buttons and controls.

Remote control

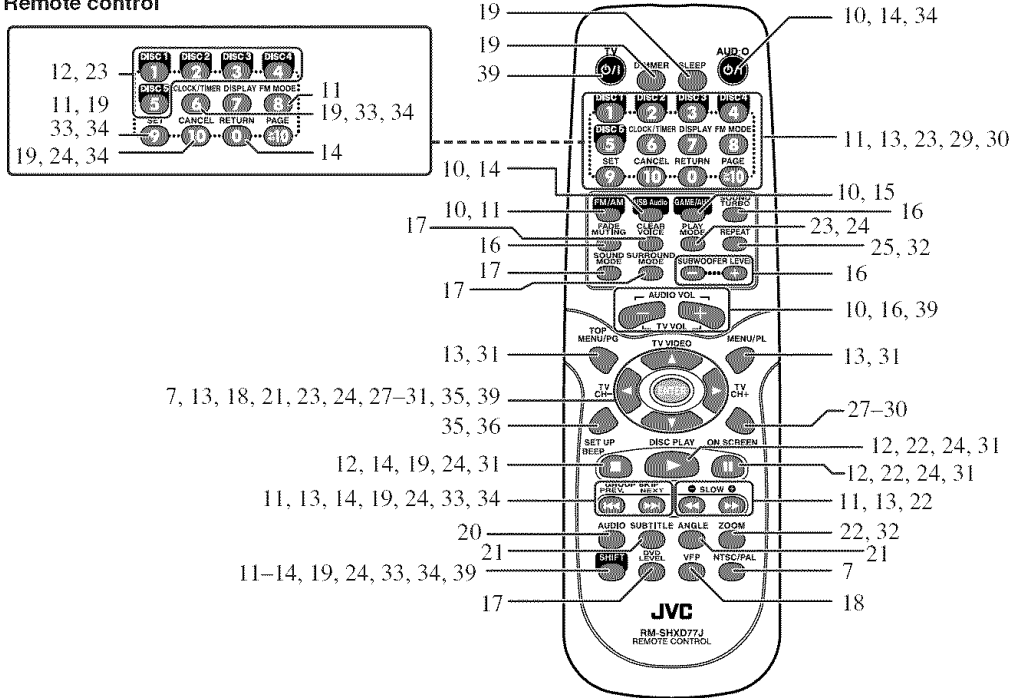

Main unit

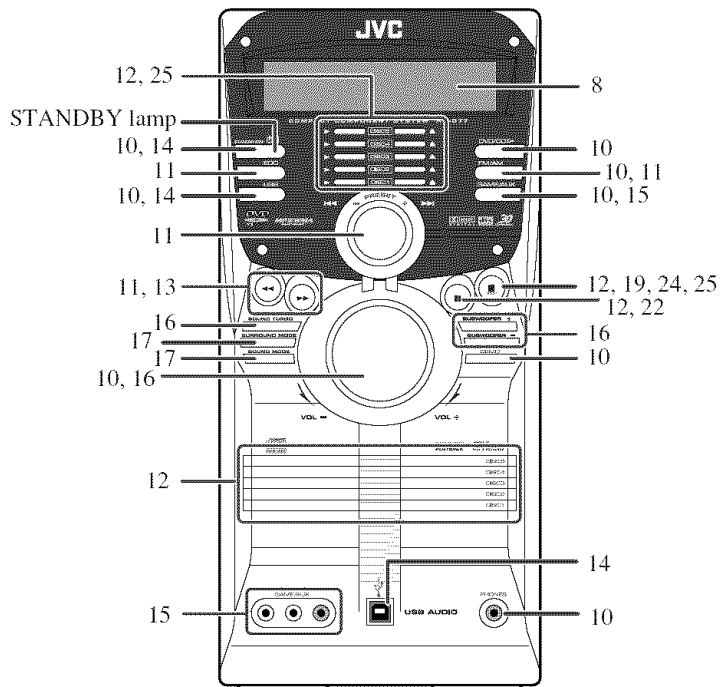

Specifications

Amplifier section—CA-HXD77

Output Power:

SUBWOOFERS: 180 W per channel, min. RMS, driven into 3 Ω at 63 Hz with no more than 10% total harmonic distortion.

MAIN SPEAKERS: 90 W per channel, min. RMS, driven into 6 Ω at 1 kHz with no more than 10% total harmonic distortion.

Audio input sensitivity/impedance

AUX: 400 mV/47 k Ω

USB: USB Version 1.1

Video input sensitivity/impedance

GAME/AUX(composite video): 1 V(p-p)/75 Ω

Digital output:

DIGITAL OUTPUT (OPTICAL):
-21 dBm to -15 dBm (660 nm \pm 30 nm)

VIDEO OUT:

Color system: NTSC or PAL

VIDEO (composite): 1 V(p-p)/75 Ω

S-VIDEO: Y (luminance) 1 V(p-p)/75 Ω

C (chrominance, burst)

NTSC 0.286 V(p-p)/75 Ω

PAL 0.3 V(p-p)/75 Ω

Speaker Terminals: 6 Ω – 16 Ω (main speakers)

3 Ω – 6 Ω (subwoofers)

Tuner section

FM tuning range: 87.5 MHz – 108.0 MHz

AM tuning range: 530 kHz – 1 710 kHz

Disc player section

Playable disc: DVD Video CD/VCD/SVCD

CD-R/CD-RW (recorded in Audio CD/
Video CD/Super Video CD/MP3/WMA/
JPEG format)

DVD-R/DVD-RW (recorded in DVD-Video
or DVD-VR format)

+R/+RW (recorded in DVD-Video or
DVD-VR format)

Dynamic range: 90 dB

Horizontal resolution: 500 lines

Wow and flutter: Immeasurable

General

Power requirement: AC 120 V \sim , 60 Hz

Power consumption: 90 W/ 150 VA (at operation)

8 W (on standby; with power saving
off—Normal mode)

1 W (on standby; with power saving
on—Eco mode)

Dimensions (approx.): 175 mm x 373 mm x 411 mm
(6 ¹⁵/₁₆ in. x 14 ¹¹/₁₆ in. x 16 ³/₁₆ in.)
(W/H/D)

Mass (approx.): 5.8 kg (12.8 lbs)

Supplied Accessories

See page 4.

Speaker section—SP-HXD77

Type: 4-Way Front Twin Woofer

(Magnetically Shielded Type)

Speakers:

Subwoofer: 16 cm (6 ⁵/₁₆ in.) cone x 1

Woofer: 16 cm (6 ⁵/₁₆ in.) cone x 1

Mid range: 7 cm (2 ¹³/₁₆ in.) cone x 1

Tweeter: 2 cm (¹³/₁₆ in.) piezo x 1

Power handling capacity:

Subwoofer: 180 W

Main speaker: 90 W

Impedance:

Subwoofer: 3 Ω

Main speaker: 6 Ω

Frequency range:

Subwoofer: 30 Hz – 1 000 Hz

Main speaker: 50 Hz – 20 000 Hz

Sound pressure level:

Subwoofer: 73 dB/W•m

Main speaker: 82 dB/W•m

Dimensions (approx.): 296 mm x 453 mm x 343 mm

(11 ¹¹/₁₆ in. x 17 ⁷/₈ in. x 13 ⁹/₁₆ in.)
(W/H/D)

Mass (approx.): 7.5 kg (16.5 lbs) each

Design and specifications are subject to change without notice.

TO OUR VALUED CUSTOMER ———

THANK YOU FOR PURCHASING THIS JVC PRODUCT.
WE WANT TO HELP YOU ACHIEVE A PERFECT EXPERIENCE.

**NEED HELP ON HOW TO HOOK UP?
NEED ASSISTANCE ON HOW TO OPERATE?
NEED TO LOCATE A JVC SERVICE CENTER?
LIKE TO PURCHASE ACCESSORIES?**

JVC[®] IS HERE TO HELP!
TOLL FREE: 1(800)252-5722
<http://www.jvc.com>

Remember to retain your Bill of Sale for Warranty Service.

————— **Do not attempt to service the product yourself** —————

Caution

To prevent electrical shock, do not open the cabinet.
There are no user serviceable parts inside.
Please refer to qualified service personnel for repairs.



LIMITED WARRANTY

AUDIO-1 **USA ONLY**

ONLY FOR PRODUCT PURCHASED IN U.S.A.

JVC COMPANY OF AMERICA (JVC) warrants this product and all parts thereof, except as set forth below ONLY TO THE ORIGINAL RETAIL PURCHASER to be FREE FROM DEFECTIVE MATERIALS AND WORKMANSHIP from the date of original purchase for the period shown below. ("The Warranty Period")

PARTS	1 YR	LABOR	1 YR
-------	-------------	-------	-------------

THIS LIMITED WARRANTY IS VALID ONLY IN THE FIFTY (50) UNITED STATES, THE DISTRICT OF COLUMBIA AND IN THE COMMONWEALTH OF PUERTO RICO.

WHAT WE WILL DO:

If this product is found to be defective within the warranty period, JVC will repair or replace defective parts with new or rebuilt equivalents at no charge to the original owner. Such repair and replacement services shall be rendered by JVC during normal business hours at JVC authorized service centers. Parts used for replacement are warranted only for the remainder of the Warranty Period. All products may be brought to a JVC authorized service center on a carry-in basis. Color televisions with a screen size of 27" or greater qualify for in-home service. In such cases, a technician will come to your home and either repair the TV there or remove and return it if it cannot be repaired in your home.

WHAT YOU MUST DO FOR WARRANTY SERVICE:

Please do not return your product to the retailer

Instead, return your product to the JVC authorized service center nearest you. If shipping the product to the service center, please be sure to package it carefully, preferably in the original packaging, and include a brief description of the problem(s). Please call 1-800-252-5722 to locate the nearest JVC authorized service center. Service locations can also be obtained from our website <http://www.jvc.com>. If your product qualifies for in-home service, the service representative will require clear access to the product.

If you have any questions concerning your JVC Product, please contact our Customer Relations Department at 800-252-5722

WHAT IS NOT COVERED:

This limited warranty provided by JVC does not cover:

1. Products which have been subject to abuse, accident, alteration, modification, tampering, negligence, misuse, faulty installation, lack of reasonable care, or if repaired or serviced by anyone other than a service facility authorized by JVC to render such service, or if affixed to any attachment not provided with the products, or if the model or serial number has been altered, tampered with, defaced or removed;
2. Initial installation, installation and removal from cabinets or mounting systems.
3. Operational adjustments covered in the Owner's Manual, normal maintenance, video and audio head cleaning;
4. Damage that occurs in shipment, due to act of God, and cosmetic damage;
5. Signal reception problems and failures due to line power surge;
6. Video Pick-up Tubes/CCD Image Sensors are covered for 90 days from the date of purchase;
7. Accessories;
8. Batteries (except that Rechargeable Batteries are covered for 90 days from the date of purchase);
9. Products used for commercial purposes, including, but not limited to rental.

There are no express warranties except as listed above.

THE DURATION OF ANY IMPLIED WARRANTIES, INCLUDING THE IMPLIED WARRANTY OF MERCHANTABILITY, IS LIMITED TO THE DURATION OF THE EXPRESS WARRANTY HEREIN.

JVC SHALL NOT BE LIABLE FOR ANY LOSS OF USE OF THE PRODUCT, INCONVIENCE, OR ANY OTHER DAMAGES, WHETHER DIRECT, INCIDENTAL OR CONSEQUENTIAL (INCLUDING, WITHOUT LIMITATION, DAMAGE TO TAPES, RECORDS OR DISCS) RESULTING FROM THE USE OF THIS PRODUCT, OR ARISING OUT OF ANY BREACH OF THIS WARRANTY. ALL EXPRESS AND IMPLIED WARRANTIES, INCLUDING THE WARRANTIES OF MERCHANTABILITY AND FITNESS FOR PARTICULAR PURPOSE, ARE LIMITED TO THE WARRANTY PERIOD SET FORTH ABOVE.

Some states do not allow the exclusion of incidental or consequential damages or limitations on how long an implied warranty lasts, so these limitations or exclusions may not apply to you. This warranty gives you specific legal rights and you may also have other rights which vary from state to state.

JVC COMPANY OF AMERICA
DIVISION OF JVC AMERICAS CORP.

1700 Valley Road
Wayne, NJ 07470

<http://www.jvc.com>

REFURBISHED PRODUCTS CARRY A SEPARATE WARRANTY, THIS WARRANTY DOES NOT APPLY. FOR DETAIL OF REFURBISHED PRODUCT WARRANTY, PLEASE REFER TO THE REFURBISHED PRODUCT WARRANTY INFORMATION PACKAGED WITH EACH REFURBISHED PRODUCT.

For customer use:

Enter below the Model No. and Serial No. which is located either on the rear, bottom or side of the cabinet. Retain this information for future reference.

Model No. : _____

Serial No. : _____

Purchase date : _____

Name of dealer : _____

JVC



EN

Free Manuals Download Website

<http://myh66.com>

<http://usermanuals.us>

<http://www.somanuals.com>

<http://www.4manuals.cc>

<http://www.manual-lib.com>

<http://www.404manual.com>

<http://www.luxmanual.com>

<http://aubethermostatmanual.com>

Golf course search by state

<http://golfingnear.com>

Email search by domain

<http://emailbydomain.com>

Auto manuals search

<http://auto.somanuals.com>

TV manuals search

<http://tv.somanuals.com>