

JVC



COMPACT COMPONENT SYSTEM

HX-Z30 — Consists of CA-HXZ30 and SP-HXZ30

HX-Z10 — Consists of CA-HXZ10 and SP-HXZ10

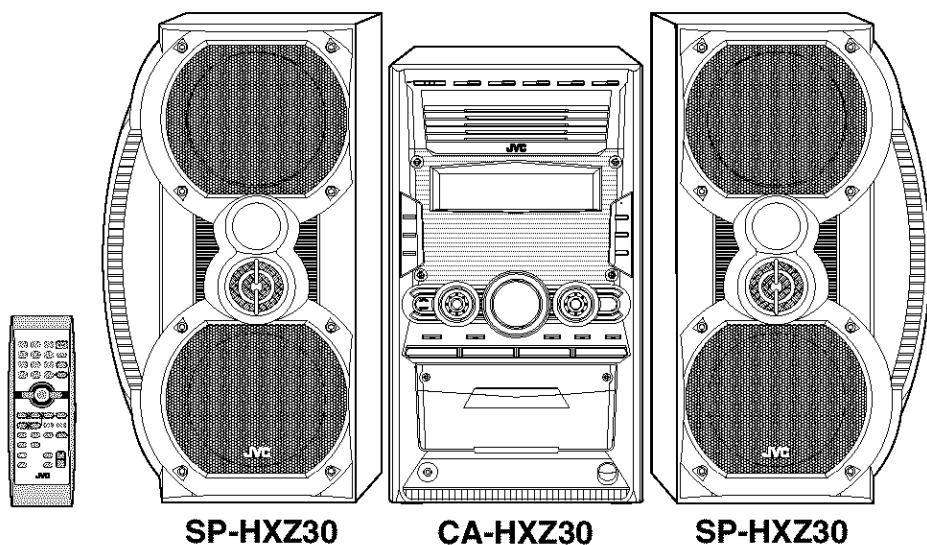

SP-HXZ30

CA-HXZ30

SP-HXZ30

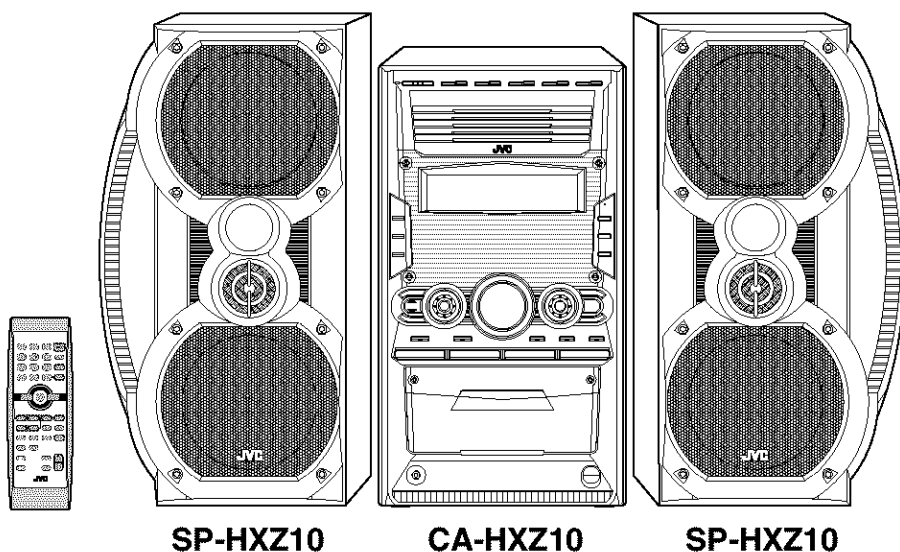

SP-HXZ10

CA-HXZ10

SP-HXZ10

COMPACT
disc
DIGITAL AUDIO

INSTRUCTIONS

For Customer Use:

Enter below the Model No. and Serial No. which are located either on the rear, bottom or side of the cabinet. Retain this information for future reference.

Model No. _____

Serial No. _____

GVT0100-001B

[J]

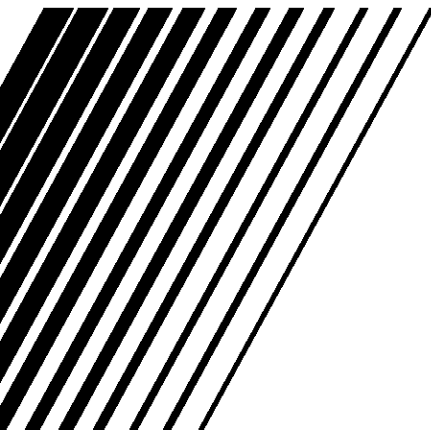

Warnings, Cautions and Others Mises en garde, précautions et indications diverses

<div style="display: inline-block; text-align: center; border: 1px solid black; padding: 2px;"> CAUTION <small>RISK OF ELECTRIC SHOCK DO NOT OPEN</small> </div>
<p>CAUTION: TO REDUCE THE RISK OF ELECTRIC SHOCK, DO NOT REMOVE COVER (OR BACK). NO USER SERVICEABLE PARTS INSIDE. REFER SERVICING TO QUALIFIED SERVICE PERSONNEL.</p>



The lightning flash with arrowhead symbol, within an equilateral triangle is intended to alert the user to the presence of uninsulated "dangerous voltage" within the product's enclosure that may be of sufficient magnitude to constitute a risk of electric shock to persons.



The exclamation point within an equilateral triangle is intended to alert the user to the presence of important operating and maintenance (servicing) instructions in the literature accompanying the appliance.

WARNING: TO REDUCE THE RISK OF FIRE OR ELECTRIC SHOCK, DO NOT EXPOSE THIS APPLIANCE TO RAIN OR MOISTURE.

For U.S.A.
 This equipment has been tested and found to comply with the limits for a Class B digital device, pursuant to part 15 of the FCC Rules. These limits are designed to provide reasonable protection against harmful interference in a residential installation.
 This equipment generates, uses and can radiate radio frequency energy and, if not installed and used in accordance with the instructions, may cause harmful interference to radio communications. However, there is no guarantee that interference will not occur in a particular installation. If this equipment does cause harmful interference to radio or television reception, which can be determined by turning the equipment off and on, the user is encouraged to try to correct the interference by one or more of the following measures:
 Reorient or relocate the receiving antenna.
 Increase the separation between the equipment and receiver.
 Connect the equipment into an outlet on a circuit different from that to which the receiver is connected.
 Consult the dealer or an experienced radio/TV technician for help.

CAUTION

To reduce the risk of electrical shocks, fire, etc.:

1. Do not remove screws, covers or cabinet.
2. Do not expose this appliance to rain or moisture.

ATTENTION

Afin d'éviter tout risque d'électrocution, d'incendie, etc.:

1. Ne pas enlever les vis ni les panneaux et ne pas ouvrir le coffret de l'appareil.
2. Ne pas exposer l'appareil à la pluie ni à l'humidité.

Caution— (standby/on) button!
 Disconnect the mains plug to shut the power off completely (all lamps and indications go off). The (standby/on) button in any position does not disconnect the mains line.

- When the unit is on standby, the STANDBY lamp lights red.
- When the unit is turned on, the STANDBY lamp goes off.

The power can be remote controlled.

Attention—Touch (attente/sous tension)!
 Déconnectez la fiche d'alimentation secteur pour mettre l'appareil complètement hors tension (tous les témoins et toutes les indications sont éteints). La touche (attente/sous tension), dans n'importe quelle position, ne déconnecte pas l'appareil du secteur.

- Quand l'appareil est en mode d'attente, le témoin STANDBY est allumé en rouge.
- Quand l'appareil est sous tension, le témoin STANBY est éteint.

L'alimentation peut être télécommandée.

Note to CATV system installer:
 This reminder is provided to call the CATV system installer's attention to Section 820-40 of the NEC which provides guidelines for proper grounding and, in particular, specifies that the cable ground shall be connected to the grounding system of the building, as close to the point of cable entry as practical.

CAUTION!
 To avoid personal injury or accidentally dropping the unit, have two persons unpack, carry, and install the unit.

HX-Z30: 35 kg / 78 lbs
HX-Z10: 30 kg / 67 lbs

For Canada/pour le Canada

CAUTION: TO PREVENT ELECTRIC SHOCK, MATCH WIDE BLADE OF PLUG TO WIDE SLOT, FULLY INSERT.

ATTENTION: POUR EVITER LES CHOCS ELECTRIQUES, INTRODUIRE LA LAME LA PLUS LARGE DE LA FICHE DANS LA BORNE CORRESPONDANTE DE LA PRISE ET POUSSER JUSQU'AU FOND.

For Canada/pour le Canada

THIS DIGITAL APPARATUS DOES NOT EXCEED THE CLASS B LIMITS FOR RADIO NOISE EMISSIONS FROM DIGITAL APPARATUS AS SET OUT IN THE INTERFERENCE-CAUSING EQUIPMENT STANDARD ENTITLED "DIGITAL APPARATUS," ICES-003 OF THE DEPARTMENT OF COMMUNICATIONS.

CET APPAREIL NUMERIQUE RESPECTE LES LIMITES DE BRUITS RADIOELECTRIQUES APPLICABLES AUX APPAREILS NUMIRIQUES DE CLASSE B PRESCRITES DANS LA NORME SUR LE MATERIEL BROUILLEUR: "APPAREILS NUMERIQUES", NMB-003 EDICTEE PAR LE MINISTRE DES COMMUNICATIONS.

1. CLASS 1 LASER PRODUCT
2. **DANGER:** Invisible laser radiation when open and interlock failed or defeated. Avoid direct exposure to beam.
3. **CAUTION:** Do not open the top cover. There are no user serviceable parts inside the unit; leave all servicing to qualified service personnel.

1. PRODUIT LASER CLASSE 1
2. **ATTENTION:** Radiation laser invisible quand l'appareil est ouvert ou que le verrouillage est en panne ou désactivé. Eviter une exposition directe au rayon.
3. **ATTENTION:** Ne pas ouvrir le couvercle du dessus. Il n'y a aucune pièce utilisable à l'intérieur. Laisser à un personnel qualifié le soin de réparer votre appareil.

Introduction

We would like to thank you for purchasing one of our JVC products. Before operating this unit, read this manual carefully and thoroughly to obtain the best possible performance from your unit, and retain this manual for future reference.

About This Manual

This manual is organized as follows:

- The manual mainly explains operations using the buttons and controls on the unit. You can also use the buttons on the remote control if they have the same or similar names (or marks) as those on the unit. If operation using the remote control is different from that using the unit, it is then explained.
- Basic and common information that is the same for many functions is grouped in one place, and is not repeated for each procedure. For instance, we do not repeat the information about turning on/off the unit, setting the volume, changing the sound effects, etc., which are explained in the section “Common Operations” on pages 9 to 11.
- The following symbols are used in this manual:



Gives you warning and caution to prevent damage or risk of fire/electric shock. Furthermore, it gives you information about what is not good for obtaining the best possible performance from the unit.



Gives you information and hints you should know.

Precautions

Installation

- Install in a place which is level, dry and neither too hot nor too cold—between 5°C (41°F) and 35°C (95°F).
- Install the unit in a location with adequate ventilation to prevent internal heat buildup in the unit.
- Leave sufficient distance between the unit and the TV.
- Keep the speakers away from the TV to avoid interference with TV.



DO NOT install the unit in a location near heat sources, or in a place subject to direct sunlight, excessive dust or vibration.

Power sources

- When unplugging the unit from the wall outlet, always pull on the plug, not the AC power cord.



DO NOT handle the AC power cord with wet hands.

Moisture condensation

Moisture may condense on the lens inside the unit in the following cases:

- After starting heating in the room
 - In a damp room
 - If the unit is brought directly from a cold to a warm place
- Should condensation occur, the unit may malfunction. In this case, leave the unit turned on for a few hours until the moisture evaporates, unplug the AC power cord, then plug it in again.

Internal heat

A cooling fan is mounted on the rear panel to prevent heat buildup inside the unit.

For safety, observe the following carefully:



- Make sure there is good ventilation around the unit. Poor ventilation could overheat and damage the unit.
- DO NOT block the cooling fan and the ventilation openings or holes. If they are blocked by a newspaper or cloth, etc., the heat may not be able to get out.

Others

- Should any metallic object or liquid fall into the unit, unplug the AC power cord and consult your dealer before operating any further.
- If you are not going to operate the unit for an extended period of time, unplug the AC power cord from the wall outlet.



DO NOT disassemble the unit since there are no user serviceable parts inside.

If anything goes wrong, unplug the AC power cord and consult your dealer.

Contents

Location of the Buttons and Controls	3
Front Panel	3
Remote Control	5
Getting Started	6
Supplied Accessories	6
Putting the Batteries into the Remote Control	6
Connecting Antennas	6
Connecting Speakers	7
Connecting Other Equipment	8
Canceling the Demonstration	8
Common Operations	9
Turning On or Off the Power	9
Setting the Clock	9
Selecting the Sources	9
Adjusting the Volume	10
Reinforcing the Bass Sound	10
Selecting the Sound Modes	10
Creating Your Own Sound Mode—User Mode	11
Turning On or Off the Key-touch Tone	11
Listening to FM and AM Broadcasts	12
Tuning in to a Station	12
Presetting Stations	12
Tuning in to a Preset Station	12
Disc Play Introduction	13
Playing Back Discs	15
Loading Discs	15
Playing Back the Entire Discs—Continuous Play ...	15
Basic Disc Operations	16
Programming the Playing Order of the Tracks	
—Program Play	17
Playing at Random—Random Play	18
Repeating Tracks or Discs—Repeat Play	19
Prohibiting Disc Ejection—Tray Lock	19
Playing Back Tapes	20
Playing Back a Tape	20
Locating the Beginning of a Song—Music Scan	20
Recording	21
Recording on a Tape	21
Synchronized Recording	22
Using the Timers	23
Using Daily Timer	23
Using Recording Timer	25
Using Sleep Timer	26
Timer Priority	26
Maintenance	27
Troubleshooting	28
Specifications	29

Location of the Buttons and Controls

Become familiar with the buttons and controls on your unit.

Front Panel

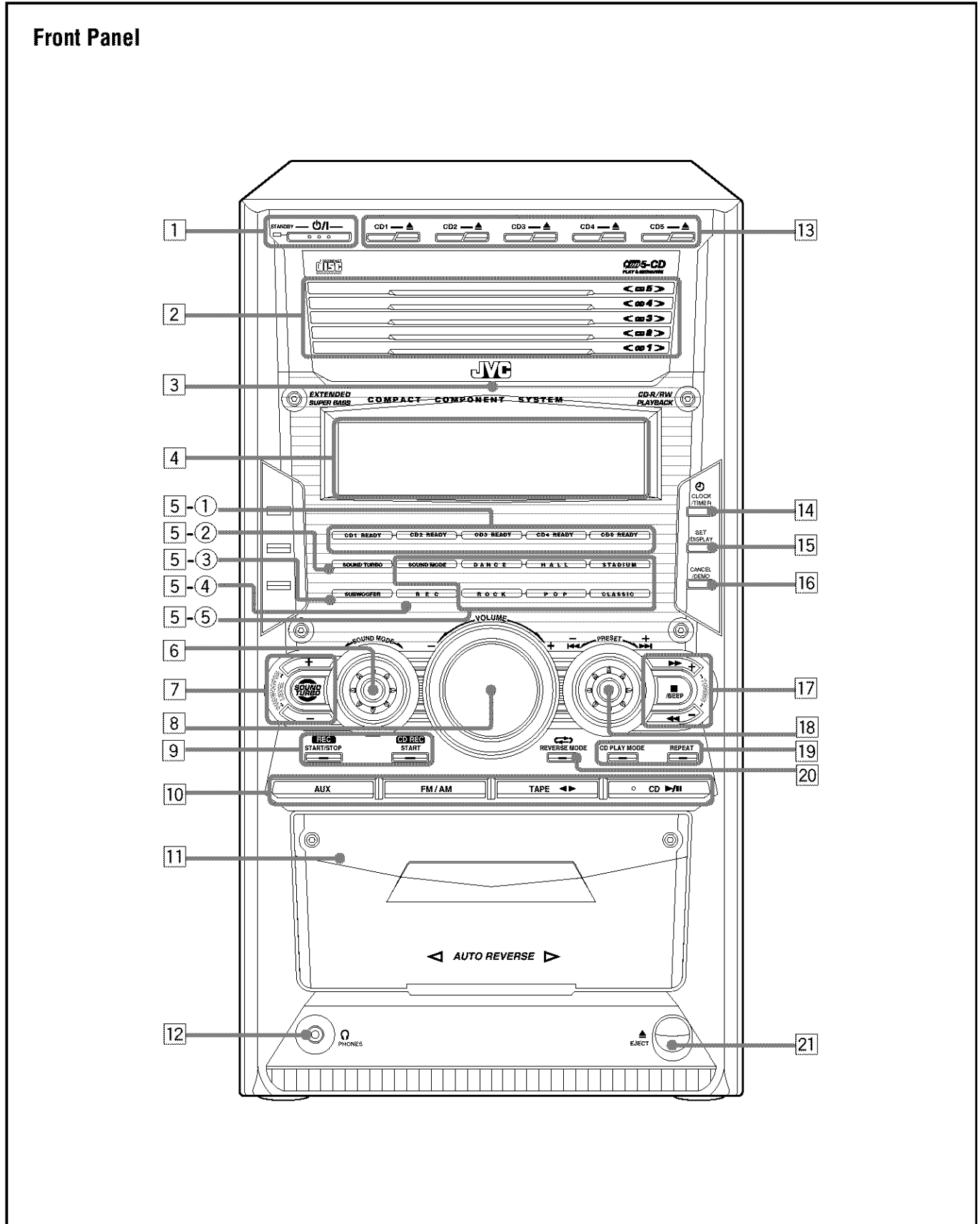

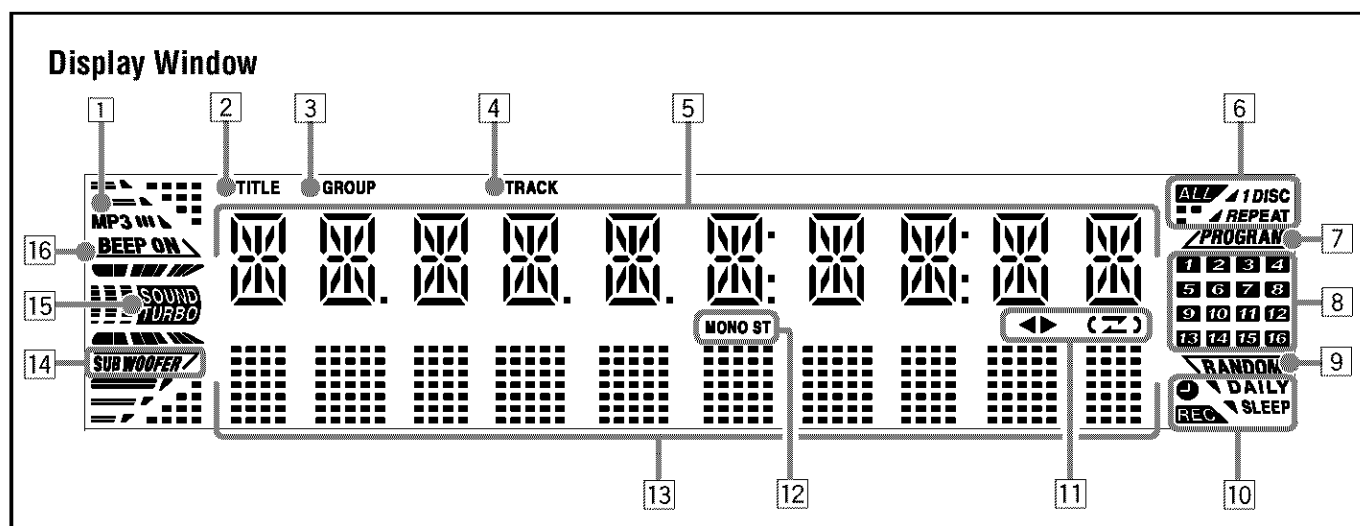

See pages in parentheses for details.

Front Panel

- 1 ϕ /I (standby/on) button and STANDBY lamp (9, 24, 25)
- 2 Disc trays (CD1 – CD5)
- 3 Remote sensor
- 4 Display window
- 5 Indication lamp panel
 - ① CD ready lamps (13)
 - CD1 READY, CD2 READY, CD3 READY, CD4 READY, CD5 READY
 - ② SOUND TURBO lamp (10)
 - ③ SUBWOOFER lamp (10)
 - ④ REC lamp (21, 22)
 - ⑤ Sound mode lamps (10)
 - SOUND MODE
 - Surround mode lamps
DANCE, HALL, STADIUM
 - SEA (Sound Effect Amplifier) mode lamps
ROCK, POP, CLASSIC
- 6 SOUND MODE control (10)
- 7 SUBWOOFER LEVEL + / – buttons (10)
SOUND TURBO button (10)
- 8 VOLUME + / – control (10)
- 9 Recording buttons (21, 22, 25)
 - REC START/STOP, CD REC START
- 10 Source buttons (9)

Pressing one of these buttons also turns on the unit.

 - AUX, FM/AM (12), TAPE \blacktriangleleft \blacktriangleright (20, 21),
CD \blacktriangleright /II (16 – 18, 22)
- 11 Cassette holder (20)
- 12 ϕ PHONES jack (10)
- 13 Disc number buttons (15 – 17, 18, 22) and \blacktriangle (disc tray open/close) buttons (15, 16, 19) (CD1 – CD5)
- 14 \odot CLOCK/TIMER button (9, 23 – 26)
- 15 SET/DISPLAY button (9, 11, 12, 17, 23 – 26)
- 16 CANCEL/DEMO button (8, 9, 18, 23 – 26)
- 17 TUNING + / – buttons (12)
 - \blacktriangleright / \blacktriangleleft (forward search/reverse search) buttons (11, 16, 20)
 - \blacksquare (stop) button
 - BEEP button (8, 11)

- 18 PRESET + / – control (12)
 - \blacktriangleright / \blacktriangleleft (forward skip/reverse skip) control (9, 11, 16 – 18, 22 – 25)
- 19 Disc play mode buttons (17 – 19)
 - CD PLAY MODE, REPEAT
- 20 \curvearrowright REVERSE MODE button (20 – 22)
- 21 \blacktriangle EJECT button for cassette deck (20 – 22)

Display Window

- 1 MP3 indicator
- 2 TITLE indicator
- 3 GROUP indicator
- 4 TRACK indicator
- 5 Main display
 - Shows the source name, frequency, etc.
- 6 REPEAT (ALL/1/DISC) indicators (19)
- 7 PROGRAM indicator (17)
- 8 Disc track number indicators
- 9 RANDOM indicator (18)
- 10 Timer indicators (23 – 26)
 - DAILY (Daily Timer), SLEEP (Sleep Timer),
REC (Recording Timer), \odot (Timer)
- 11 Tape operation indicators (20 – 22)
 - \blacktriangleleft \blacktriangleright (tape direction), \curvearrowright (Reverse Mode)
- 12 Tuner operation indicators (12)
 - MONO, ST (stereo)
- 13 Audio level indicator

When one of the 6 preset sound modes is activated, this will function as illumination display. For details, see “Selecting the Sound Modes” on pages 10 and 11.
- 14 SUBWOOFER indicator (10)
- 15 SOUND TURBO indicator (10)
- 16 BEEP ON indicator (8, 11)

Remote Control

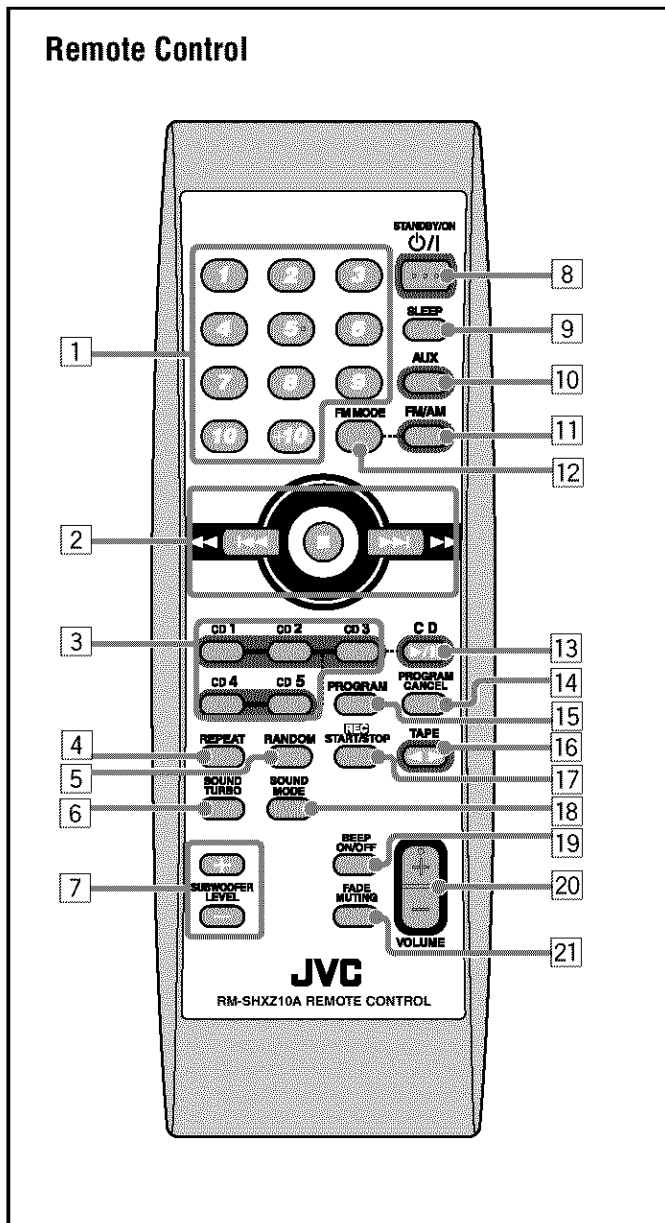

Remote Control

- 1 Number buttons (12, 16, 17)
- 2 ►► (►►►) (forward skip/forward search) button (12, 16, 18, 20)
◄◄ (◄◄◄) (reverse skip/reverse search) button (12, 16, 18, 20)
■ (stop) button
- 3 Disc number buttons (CD1 – CD5) (15, 17, 18)
Pressing one of these buttons also turns on the unit.
- 4 REPEAT button (19)
- 5 RANDOM button (18)
- 6 SOUND TURBO button (10)
- 7 SUBWOOFER LEVEL + / – buttons (10)
- 8 STANDBY/ON ϕ /I button (9)
- 9 SLEEP button (26)
- 10 AUX button (9)
Pressing this button also turns on the unit.
- 11 FM/AM button (9, 12)
Pressing this button also turns on the unit.
- 12 FM MODE button (12)
- 13 CD ►/|| button (9, 16 – 18)
Pressing this button also turns on the unit.
- 14 PROGRAM CANCEL button (18)
- 15 PROGRAM button (17)
- 16 TAPE ◄► button (9, 20, 21)
Pressing this button also turns on the unit.
- 17 REC START/STOP button (21)
- 18 SOUND MODE button (10)
- 19 BEEP ON/OFF button (8, 11)
- 20 VOLUME + / – button (10)
- 21 FADE MUTING button (10)

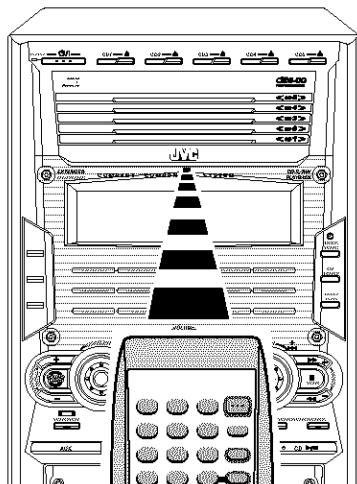

When using the remote control, point it at the remote sensor on the front panel.

Supplied Accessories

Make sure that you have all the following items. The number in parentheses indicates the quantity of each piece supplied.

- AM loop antenna (1)
- FM antenna (1)
- Remote control (1)
- Batteries (2)

If anything is missing, consult your dealer immediately.

Putting the Batteries into the Remote Control

Insert the batteries—R6(SUM-3)/AA(15F)—into the remote control, by matching the polarity (+ and –) on the batteries with the + and – markings on the battery compartment. When the remote control can no longer operate the unit, replace both batteries at the same time.

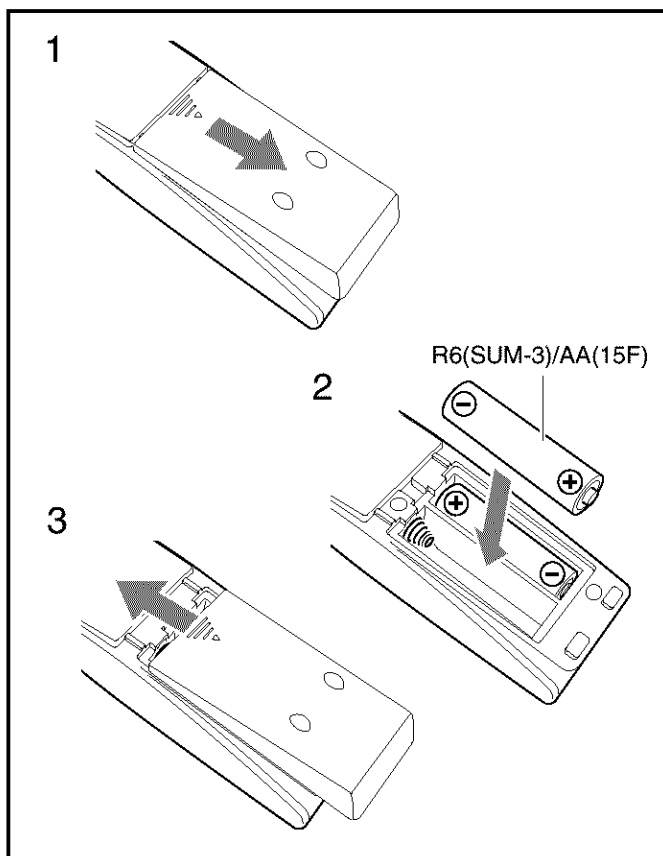

- DO NOT use an old battery together with a new one.
- DO NOT use different types of batteries together.
- DO NOT expose batteries to heat or flame.
- DO NOT leave the batteries in the battery compartment when you are not going to use the remote control for an extended period of time. Otherwise, the remote control will be damaged from battery leakage.

Connecting Antennas

FM antenna

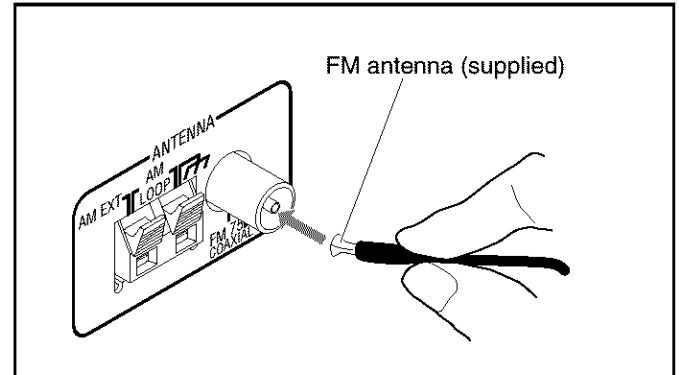

- 1 Attach the FM antenna to the FM 75 Ω COAXIAL terminal.
- 2 Extend the FM antenna.
- 3 Fasten it up in the position which gives you the best reception, then fix it on the wall, etc.



About the supplied FM antenna

The FM antenna supplied with this unit can be used as temporary measure. If reception is poor, you can connect an outdoor FM antenna.

To connect an outdoor FM antenna

Before connecting the antenna, disconnect the supplied FM antenna.

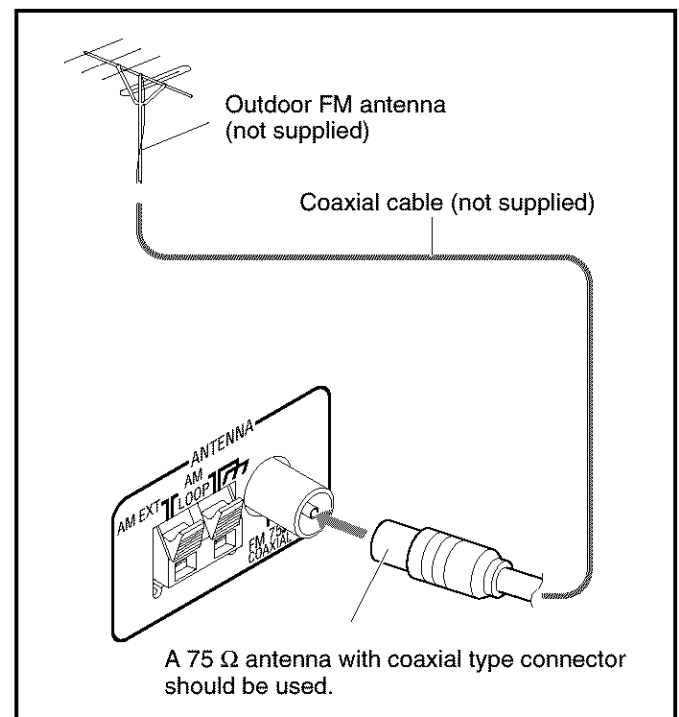

AM antenna

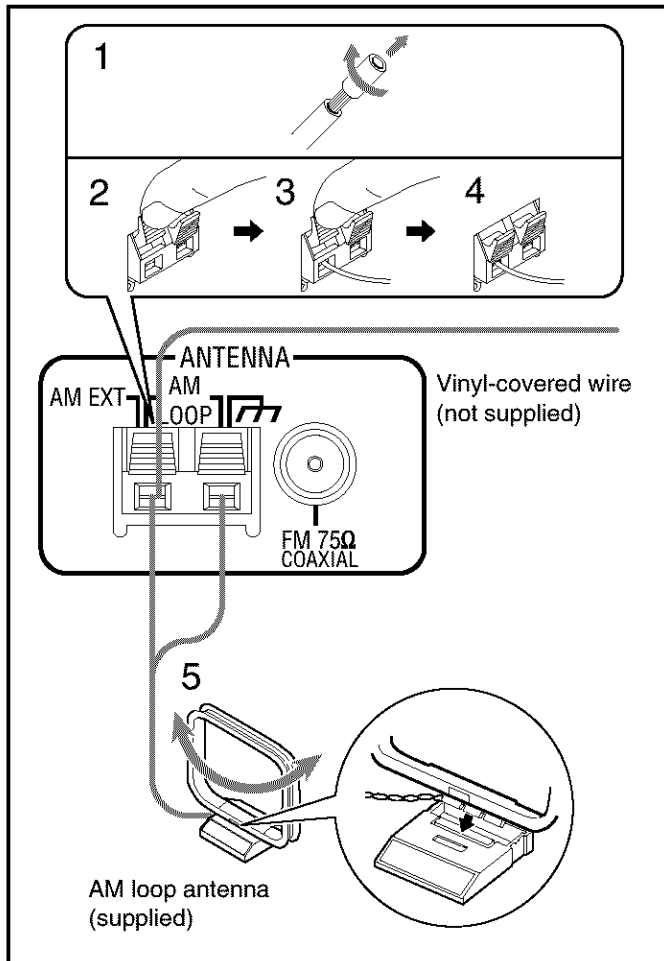

- 1 If the cords are covered with insulation, remove a short section of insulation at the end of each cord by twisting and pulling it off.
- 2 Press and hold the clamp of the AM LOOP terminals on the rear of the unit.
- 3 Insert the AM loop antenna to the AM LOOP terminals as illustrated.
- 4 Release your finger from the clamp.
- 5 Turn the AM loop antenna until you have the best reception.

To connect an outdoor AM antenna

When reception is poor, connect a single vinyl-covered wire to the AM EXT terminal and extend it horizontally. The AM loop antenna must remain connected.



For better reception of both FM and AM

- Make sure the antenna conductors do not touch any other terminals and connecting cords.
- Keep the antennas away from metallic parts of the unit, connecting cords, and the AC power cord.

Connecting Speakers

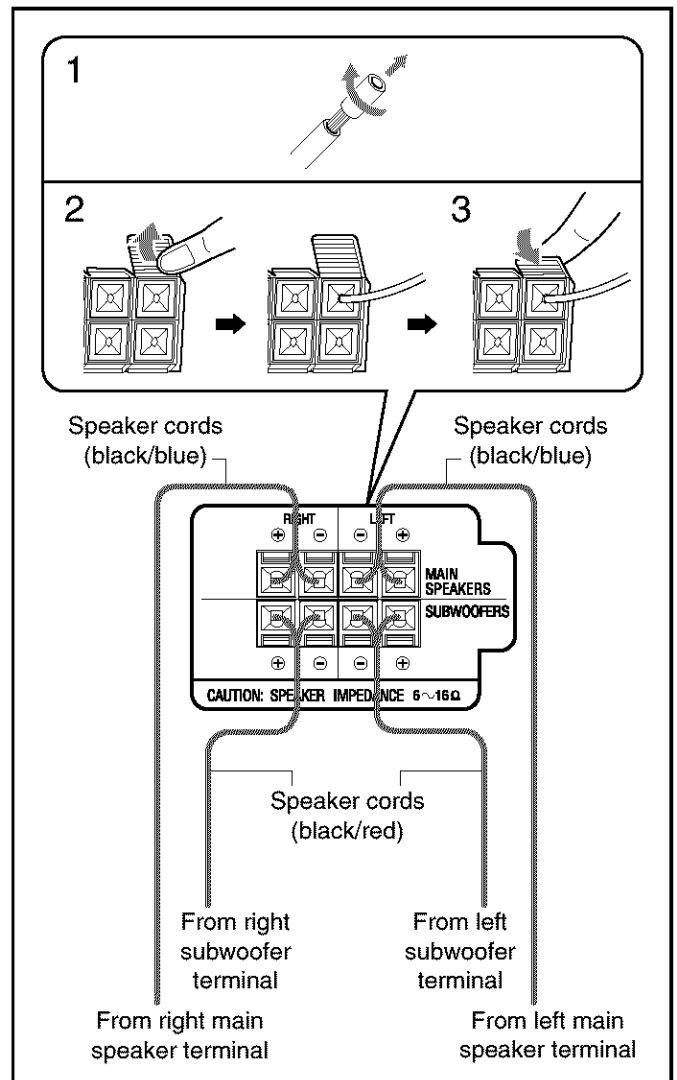

- 1 If the cords are covered with insulation, remove a short section of insulation at the end of each cord by twisting and pulling it off.
- 2 Insert the end of the speaker cord into the terminal as illustrated.
Match the same polarity: (+) to (+) and (-) to (-).
- 3 Close the speaker terminals.

IMPORTANT: Use only speakers with the same speaker impedance as indicated by the speaker terminals on the rear of the unit.



- DO NOT connect more than one speaker to each speaker terminal.
- DO NOT push or pull the speakers as this will damage the foot spacers at the bottom of the speakers.

Connecting Other Equipment

You can connect an external audio component used only as a playback device.



- DO NOT connect any equipment while the power is on.
- DO NOT plug in any equipment until all connections are complete.

To connect an external audio component

Be sure that the plugs of the audio cords are colored: White plugs and jacks are for left audio signals, and red ones for right audio signals.

To play external audio component through this unit, connect between the audio output jacks on the other equipment and AUX jacks by using an audio cord (not supplied).

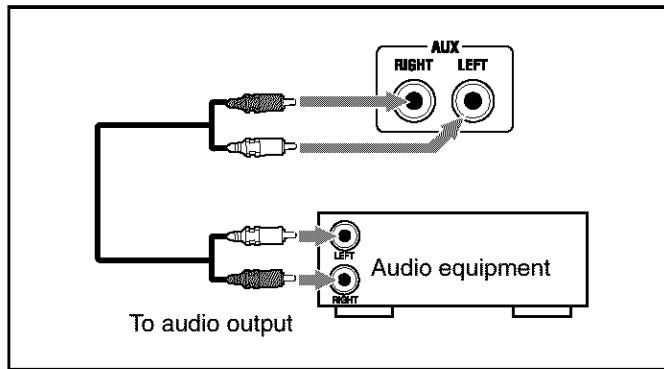

Now, you can plug the AC power cord.

IMPORTANT: Be sure to check that all connections are done before plugging the AC power cord into a wall outlet.

Canceling the Demonstration

When connecting the AC power cord to a wall outlet, the unit automatically starts demonstration.

To cancel the demonstration, press and hold CANCEL/DEMO until “DEMO OFF” appears on the display.



- To cancel only beep sounds during the demonstration, press and hold BEEP for more than 2 seconds or press BEEP ON/OFF on the remote control.



The BEEP ON indicator goes off from the display.



When you press other buttons

The demonstration stops temporarily. It will start automatically again (if no operation is done for 2 minutes) unless you cancel it by pressing CANCEL/DEMO.

To start demonstration manually

Press and hold CANCEL/DEMO again until “DEMO START” appears on the display.

Common Operations

Turning On or Off the Power

To turn on the unit, press (or STANDBY/ON on the remote control) so that the STANDBY lamp goes off.

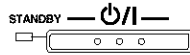

POWER ON

To turn off the unit (standby), press (or STANDBY/ON on the remote control) again so that the STANDBY lamp lights up.

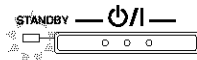

- A little power is always consumed even while the unit is on standby.

To switch off the power supply completely, unplug the AC power cord from the AC outlet.

notes When you unplug the AC power cord or if a power failure occurs

The clock is reset to “AM 12:00” immediately, while the tuner preset stations (see page 12) will be erased in a few days.

Setting the Clock

Before operating the unit any further, first set the clock built in this unit. “AM 12:00” will flash on the display until you set the clock.

- You can set the clock whether the unit is on or off.

On the unit ONLY:

1 Press CLOCK/TIMER.

The hour digits start flashing on the display.

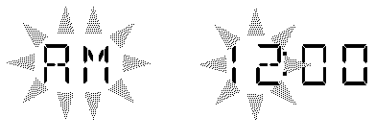

2 Turn to adjust the hour, then press SET/DISPLAY.

The minute digits start flashing on the display.

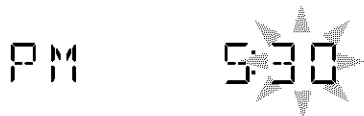
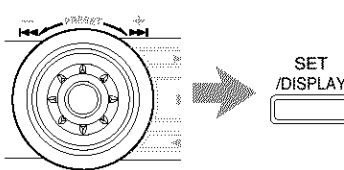

To correct the hour after pressing SET/DISPLAY, press CANCEL/DEMO. The hour digits start flashing again.



3 Turn to adjust the minutes, then press SET/DISPLAY.

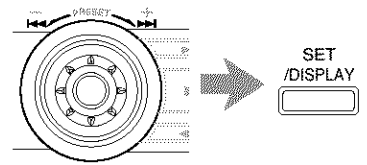

CLOCK OK

To check the clock time while playing a source

Press and hold SET/DISPLAY.

- Each time you press and hold the button, the source indication and the clock time alternate on the display.

To adjust the clock again

If you have set the clock before, press CLOCK/TIMER repeatedly until the clock setting mode is selected.

- Each time you press the button, the clock/timer setting modes change as follows:

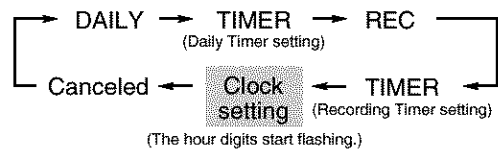

- When you unplug the AC power cord or if a power failure occurs

The clock loses its setting and is reset to “AM 12:00.” If this happens, set the clock again.

- The clock may gain or loss 1 to 2 minutes per month. If this happens, reset the clock.

Selecting the Sources

Press one of the source buttons—FM/AM, CD , TAPE , and AUX.

When you press one of the source buttons (FM/AM, CD , TAPE , and AUX), the unit turns on and starts playing the source if it is ready.

- To listen to the FM/AM broadcasts, press FM/AM. (See page 12.)
- To play back discs, press CD . (See pages 13 – 19.)
- To play back tapes, press TAPE . (See page 20.)
- To select an external component as the source, press AUX.



Adjusting the Volume

You can adjust the volume level only while the unit is turned on. The volume level can be adjusted in 32 steps (VOLUME MIN, VOLUME 1 – VOLUME 30, and VOLUME MAX).

The volume level control does not affect recording.

Turn **VOLUME + / –** clockwise (+) to increase the volume or counterclockwise (–) to decrease it.

When using the remote control, press **VOLUME +** to increase the volume or **VOLUME –** to decrease it.

- When adjusting the volume, the back color on the display changes as increasing/decreasing the level—not lighting ↔ blue ↔ purple ↔ pink ↔ red.

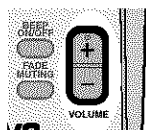
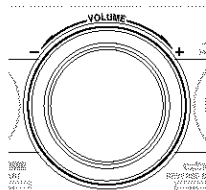

VOLUME 15

To turn off the volume level temporarily

On the remote control ONLY:

Press **FADE MUTING**.

The volume level gradually decreases to “VOLUME MIN.”

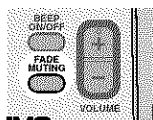

To restore the sound, press the button again.

To listen with headphones

Connect a pair of headphones to the PHONES jack on the unit. The sound will no longer come out of the speakers.

Disconnecting a pair of headphones from the PHONES jack activates the speakers again.



- DO NOT set the volume to a high level before connecting or putting on headphones.
- DO NOT turn off (standby) the unit with the volume set to an extremely high level; otherwise, a sudden blast of sound can damage your hearing, speakers and/or headphones when you turn on the unit or start playing any source next time. REMEMBER, you cannot adjust the volume level while the unit is off (standby).

Reinforcing the Bass Sound

Changing the subwoofer level

You can select one of the 3 subwoofer levels—LEVEL 0 (MIN LEVEL), LEVEL 1, and LEVEL 2 (MAX LEVEL). This function only affects the playback sound, but does not affect your recording.

Press **SUBWOOFER LEVEL +** to increase the subwoofer level or **SUBWOOFER LEVEL –** to decrease it.

The **SUBWOOFER** indicator lights up on the display.

The **SUBWOOFER** lamp also flashes when LEVEL 1 or LEVEL 2 (MAX LEVEL) is selected. The lamp stops flashing when LEVEL 0 (MIN LEVEL) is selected.

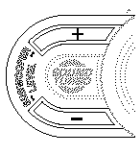

To enjoy heavy sound

You can enjoy heavy sound by using Sound Turbo. This function boosts the low and high frequency sound.

- Activating Sound Turbo cancels the sound mode and/or subwoofer adjustment.

Press **SOUND TURBO**.

The **SOUND TURBO** indicator lights up on the display and the **SOUND TURBO** lamp also flashes. The subwoofer level increases to the maximum level (LEVEL 2).

- Each time you press **SOUND TURBO**, Sound Turbo is turned on (subwoofer LEVEL 2) or off (subwoofer LEVEL 0).

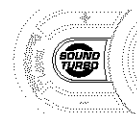

If you press **SUBWOOFER + / –** or select a sound mode during activating Sound Turbo

Sound Turbo is canceled.

Selecting the Sound Modes

You can select one of the 6 preset sound modes (3 surround modes and 3 SEA—Sound Effect Amplifier—modes) and 3 user modes. This function only affects the playback sound, but does not affect recording.

To select the sound modes,

turn **SOUND MODE** (or press **SOUND MODE** on the remote control) until the sound mode you want appears on the display.

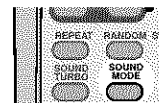
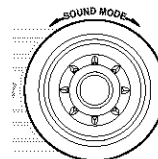

- When one of the sound modes is selected, the lamp for the selected sound mode and the **SOUND MODE** lamp flash.
- When one of the user modes (USER 1, USER 2, or USER 3) is selected, only the **SOUND MODE** lamp flashes.

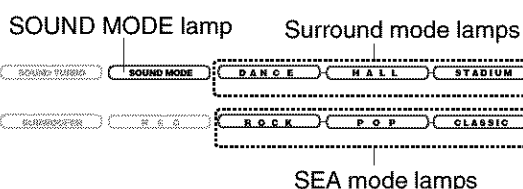

The sound modes change as follows:

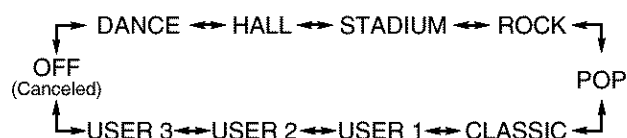

When using the remote control, the sound mode changes only clockwise in the above sequence.

Surround modes*

- DANCE:** Increases resonance and bass.
HALL: Adds depth and brilliance to the sound.
STADIUM: Adds clarity and spreads the sound, as in an outdoor stadium.

SEA (Sound Effect Amplifier) modes

- ROCK:** Boosts low and high frequency. Good for acoustic music.
POP: Good for vocal music.
CLASSIC: Good for classical music.

User modes

USER 1/2/3: Your individual mode stored in memory. See “Creating Your Own Sound Mode—User Mode” below.

OFF: The sound mode is canceled.

* Surround elements are added to the SEA elements to create a being-there feeling in your room.



When you turn on Sound Turbo

The sound mode is canceled.

Creating Your Own Sound Mode—User Mode

You can change the SEA pattern to suit your preference. The SEA pattern can be adjusted using 3 frequency ranges—BASS, MID (middle), and TRE (treble). These changed settings can be stored as the USER 1, USER 2, and USER 3 modes.

- There is a time limit in doing the following steps. If the setting is canceled before you finish, start from step 1 again.

On the unit ONLY:

1 Select one of the preset sound modes.

- If you want to add surround elements into your SEA pattern, select one of the surround modes (DANCE, HALL, or STADIUM) before starting the procedure below. (See “Selecting the Sound Modes” on page 10.)

2 Press SET/DISPLAY while the selected sound mode is still shown on the display.



SEA CONT



BASS +3

Current level appears.

3 Adjust the SEA pattern.

- 1) Turn ►►/◄◄ to select the frequency range (BASS, MID or TRE).
- 2) Press ►► or ◄◄ to adjust the level (–3 to +3) of the selected frequency range.
- 3) Repeat steps 1) and 2) to adjust the level of the other frequency ranges.

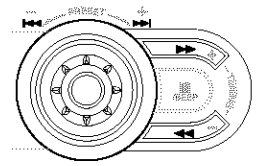

4 Press SET/DISPLAY again.

USER 1



5 Turn ►►/◄◄ to select one of the user modes (USER 1, USER 2, or USER 3) in which you want to store your SEA pattern.

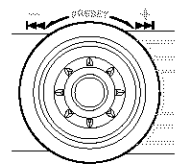

6 Press SET/DISPLAY again.

MEMORY

The SEA pattern you have created is stored into the user mode selected in step 5.

To use your own sound mode

Select USER 1, USER 2, or USER 3 mode when using the sound modes. See “Selecting the Sound Modes” on page 10.



When you unplug the AC power cord or if a power failure occurs

The setting will be erased in a few days. If this happens, set the user modes again.

Turning On or Off the Key-touch Tone

If you do not want the key-touch tone to beep each time you press a button or turn a control, you can deactivate it. The BEEP ON indicator goes off from the display.

On the unit:

Press and hold BEEP for more than 2 seconds.

On the remote control:

Press BEEP ON/OFF.

- Each time you press the button, the key-touch tone turns on and off alternately.

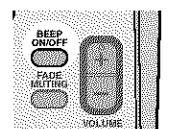
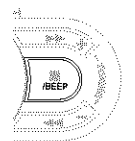

Listening to FM and AM Broadcasts

Tuning in to a Station

1 Press FM/AM.

The unit automatically turns on and tunes in to the previously received station (either FM or AM).

- Each time you press the button, the band alternates between FM and AM.



2 Start searching for stations.

On the unit:

Press and hold TUNING + or TUNING – for more than 1 second.

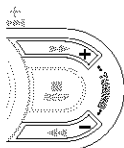

On the remote control:

Press and hold ►►► (►►►) or ◄◄◄ (◄◄◄) for more than 1 second.



The unit starts searching for stations and stops when a station of sufficient signal strength is tuned in.

- If a program is broadcast in stereo, the ST (stereo) indicator lights up.

To stop searching, press TUNING + or TUNING – (or ►►► (►►►) / ◄◄◄ (◄◄◄) on the remote control).



When you press TUNING + or TUNING – (or ►►► (►►►) / ◄◄◄ (◄◄◄) on the remote control) briefly and repeatedly

The frequency changes step by step.

To change the FM reception mode

On the remote control ONLY:

When an FM stereo broadcast is hard to receive or noisy, press FM MODE so that the MONO indicator lights up on the display. Reception will improve.

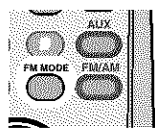

To restore the stereo effect, press FM MODE again so that the MONO indicator goes off. In this stereo mode, you can hear stereo sounds when a program is broadcasted.

Presetting Stations

You can preset 30 FM and 15 AM stations.

In some cases, test frequencies have been already memorized for the tuner since the factory examined the tuner preset function before shipment. This is not a malfunction. You can preset the stations you want into memory by following the presetting method.

- There is a time limit in doing the following steps. If the setting is canceled before you finish, start from step 2 again.

On the unit ONLY:

1 Tune in to the station you want to preset.

- See “Tuning in to a Station.”

2 Press SET/DISPLAY.



3 Turn PRESET + / – to select a preset number.

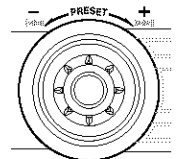

4 Press SET/DISPLAY again.



The tuned station in step 1 is stored in the preset number selected in step 3.

- Storing a new station on a number already used erases the previously stored one.



When you unplug the AC power cord or if a power failure occurs

The preset stations will be erased in a few days. If this happens, preset the stations again.

Tuning in to a Preset Station

1 Press FM/AM.

The unit automatically turns on and tunes in to the previously received station (either FM or AM).

- Each time you press the button, the band alternates between FM and AM.

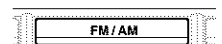

2 Select a preset number.

On the unit:

Turn PRESET + / –.

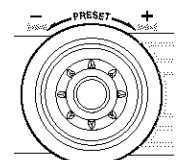

On the remote control:

Press the number buttons.

Ex.: For preset number 5, press 5.

For preset number 15, press +10, then 5.

For preset number 25, press +10, +10, then 5.

For preset number 30, press +10, +10, then 10.

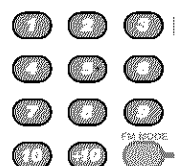

Disc Play Introduction

This unit has been designed to play back the following discs:

- CD (Audio CD)/CD-R (CD-Recordable)/CD-RW (CD-ReWritable)
- MP3 disc (MP3 files recorded on a CD-R or CD-RW)*

When playing a CD-R or CD-RW

User-edited CD-Rs (CD-Recordable) and CD-RWs (CD-ReWritable) can be played back only if they have been “finalized.”

- You can play back your original CD-Rs or CD-RWs recorded in music CD format or in MP3 format. However, they may not be played back depending on their characteristics or recording conditions.
- Before playing back CD-Rs or CD-RWs, read their instructions or cautions carefully.
- Some CD-Rs or CD-RWs may not play back on this unit because of their disc characteristics, damage or stain on them, or if the player’s lens is dirty.
- CD-RWs may require a longer readout time. This is caused by the fact that the reflectance of CD-RWs is lower than for regular discs.

About the CD ready lamps

Each CD ready lamp shows the status of a disc placed on each corresponding disc tray (CD1 – CD5).



- **CD ready lamps light up**
When the disc is loaded and currently selected.
- **CD ready lamps light slightly**
When the disc is loaded, but not currently selected.
- **CD ready lamp flashes**
When the disc is played back or paused.
- **CD ready lamps goes off**
When the unit detects there is no disc loaded on a certain tray. (“NO DISC # (number)” appears on the display.)



If the loaded disc is an MP3 disc

The corresponding CD ready lamp and the MP3 indicator will light up.

*About MP3

MP3 is an abbreviation of Motion Picture Experts Group 1 (or MPEG-1) Audio Layer 3. MP3 is simply a file format with a data compression ratio of 1:10 (128 kbps*). By using MP3 format, one CD-R or CD-RW can contain 10 times as much data volume as a regular CD can.

* Bit rate is the average number of bits that one second of audio data will consume. The basic unit of measurement for bitrate is kbps (1,024 bits per second). To get a better audio quality, choose a higher bit rate. The most popular bit rate for encoding (recording) is 128 kbps.

MP3 disc structure

On an MP3 disc, each song (material) is recorded as a file. Files are grouped into a folder. Folders can also include other directories, creating hierarchical directory layers. (See “How are MP3 files recorded and played back?” on page 14.)

This unit manages files and folders as “tracks” and “groups.” This unit can recognize up to 255 groups per disc (up to 999 tracks). The unit ignores those exceeding the maximum numbers and cannot play them back.



More about MP3 discs

- MP3 discs (either CD-R or CD-RW) require a longer readout time. (It varies due to the complexity of the recording configuration.)
- When making an MP3 disc, select ISO 9660 Level 1 or Level 2 as the disc format.
- This unit does not support multisession recording.
- This unit can play MP3 files only with the following file extensions—“.MP3,” “.Mp3,” “.mP3,” and “.mp3.”
- Files other than MP3 are ignored.
- Some MP3 discs may not be played back because of their disc characteristics or recording conditions.

How are MP3 files recorded and played back?

MP3 “tracks (files)” can be recorded in “group”—folders in PC terminology.

During recording, the tracks and groups can be arranged similarly to the tracks and folders of computer data. “Root” is similar to the root of a tree. Every track and group can be linked to the root.

In compliance with ISO 9660, the maximum allowable depth of nested directories—so called “hierarchy”—is eight (inclusive of the root).

Playback order, track search order, and group search order of the MP3 tracks recorded on a disc are determined by the writing (or encoding) application; therefore, playback order may be different from the one you have intended while recording the groups and the tracks.

The illustration shows an example of how MP3 tracks are recorded on a CD-R or CD-RW, how they are played back and how they are searched for on this unit.

- The numbers in circles next to the MP3 tracks (♫) indicate the playback order and search order of the MP3 tracks. Normally this unit plays back MP3 tracks in the recorded order.
- The numbers inside the groups indicate the playback order and search order of the groups on an MP3 disc. Normally this unit plays back MP3 tracks in the groups in the recorded order. The groups marked with asterisk (*) will be skipped since they do not include any MP3 tracks.

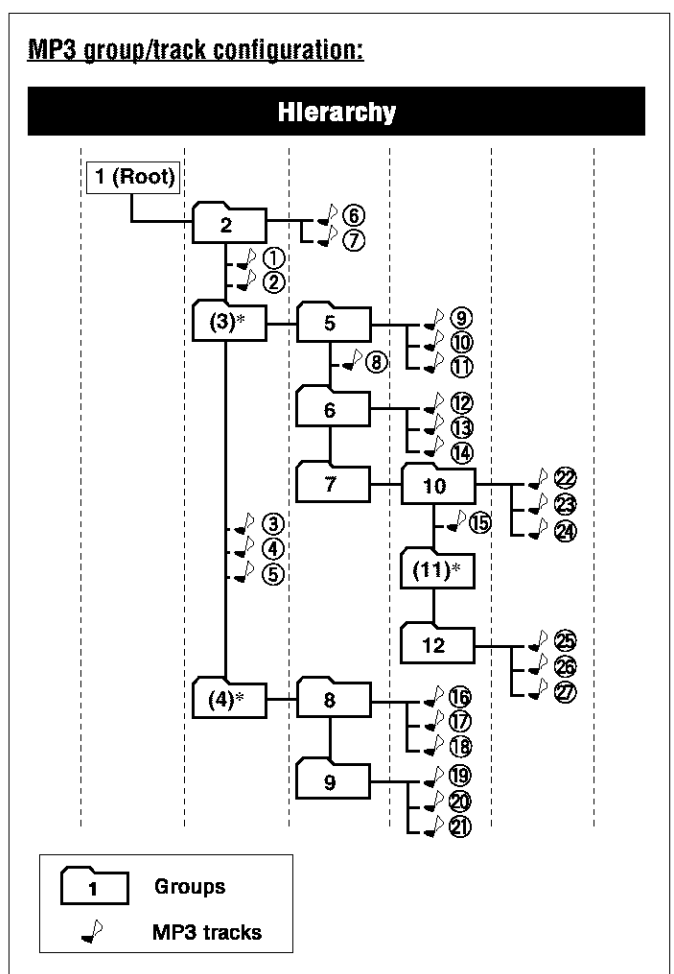

Playing Back Discs

Loading Discs

On the unit ONLY:

- 1 Press **▲** for the disc tray (CD1 – CD5) you want to load a disc onto.

The unit automatically turns on and the disc tray comes out.

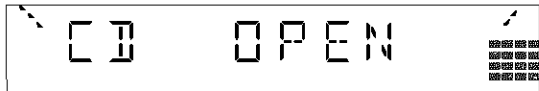
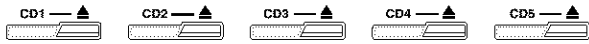

- 2 Place a disc correctly on the circle of the disc tray, with its label side up.

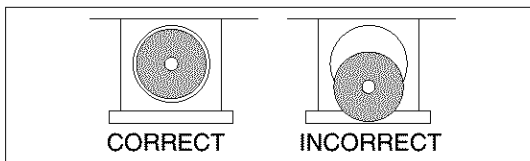

- When using a CD single (8 cm), place it on the inner circle of the disc tray.

- 3 Press the same **▲** you have pressed in step 1.

The disc tray closes.

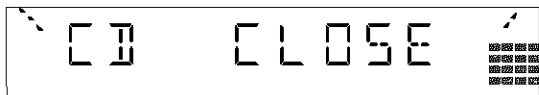

When loading more than one disc

When you press **▲** for the next tray you want to place another disc onto, the first disc tray automatically closes and then the next tray comes out.

Playing Back the Entire Discs—Continuous Play

You can play discs continuously.

- If you start Continuous Play with an MP3 disc, you can select a track to start playback.

For audio CDs

- 1 Load discs.

- 2 Press one of the corresponding disc number buttons (CD1 – CD5) for the disc you want to play.

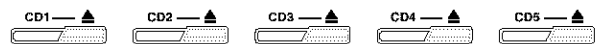

The unit searches for the disc, and starts playing with the first track of the selected disc.

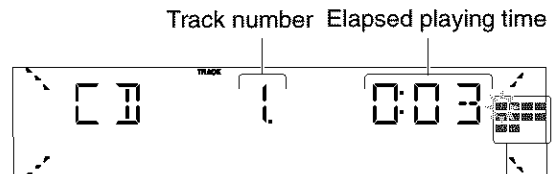

Tracks of the currently playing CD (Track numbers exceeding 16 are not displayed.)

For MP3 discs

- 1 Load discs.

- 2 Press one of the corresponding disc number buttons (CD1 – CD5) you load discs in step 1.

The unit searches for the disc (it may take time), and starts playing the first track of the disc.

- The MP3 indicator lights up on the display.

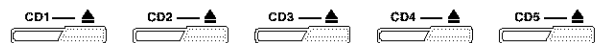

- 3 Press **■**.

The group title of the 1st group appears on the display, then the group number starts flashing.

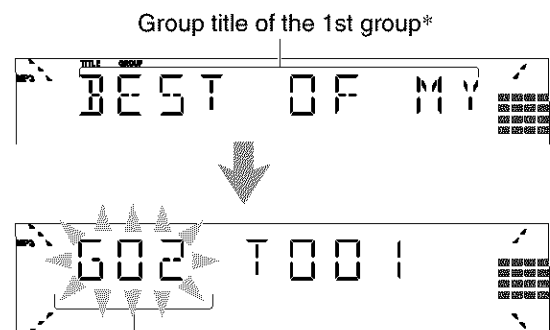

- * If the entire group title cannot be shown (exceeds 10 characters), the title scrolls.

4 Select a group and track to start playing.

- 1) Turn **▶▶▶/|◀◀◀** (or press **▶▶▶ (▶▶▶) / |◀◀◀ (◀◀◀)** on the remote control) to select a group you want, then press **CD ▶/||**.

The track number starts flashing.

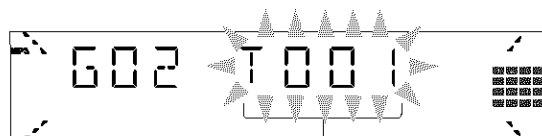
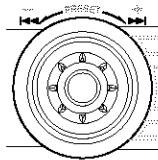

Track number flashes

- 2) Turn **▶▶▶/|◀◀◀** (or press **▶▶▶ (▶▶▶) / |◀◀◀ (◀◀◀)** on the remote control) to select a track you want to start playback with, then press **CD ▶/||**.

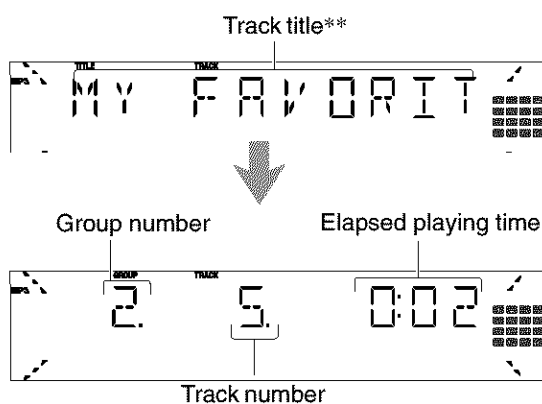

** If the entire track title cannot be shown (exceeds 10 characters), the title scrolls.

Playback starts with the selected track of the selected group.

To stop playing, press **■**.

To remove the disc, press **▲** for the corresponding disc tray.

Disc playback sequence

When discs* in more than one tray are loaded on the disc trays, they are played in sequence as follows:

Ex: When CD2 is pressed:

CD2 ⇒ CD3 ⇒ CD4 ⇒ CD5 ⇒ CD1 (then stops)

* When no disc is loaded on the tray, that disc number is skipped.

Basic Disc Operations

While playing a disc, you can do the following operations.

To exchange discs during playback of another disc

Press **▲** corresponding to a disc (CD1 – CD5), not playing or selected currently, to eject and exchange the disc.

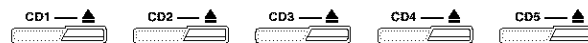

If you exchange discs during play, the current play will not stop until all discs you have exchanged are played.

To stop play for a moment

Press **CD ▶/||**.

While pausing, the elapsed playing time flashes on the display.

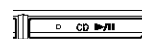

To resume playing, press **CD ▶/||** again.

To go to another track

For audio CDs: Before or during play

For MP3 discs: During play

Turn **▶▶▶/|◀◀◀** (or press **▶▶▶ (▶▶▶) / |◀◀◀ (◀◀◀)** on the remote control).

- **▶▶▶ (or ▶▶▶ (▶▶▶)):**

Skips to the beginning of the next or succeeding tracks.

- **|◀◀◀ (or |◀◀◀ (◀◀◀)):**

Goes back to the beginning of the current or previous tracks.

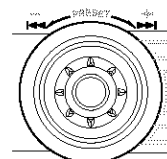

To locate a particular point in a track

During play, press and hold **▶▶▶** or **◀◀◀** (or **▶▶▶ (▶▶▶) / |◀◀◀ (◀◀◀)** on the remote control).

- **▶▶▶ (or ▶▶▶ (▶▶▶)):** Fast-forwards the disc.

- **◀◀◀ (or |◀◀◀ (◀◀◀)):** Fast-reverses the disc.

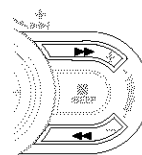

To go to another track directly using the number buttons

On the remote control ONLY:

Pressing the number button(s) before or during play allows you to start playing the track number you want.

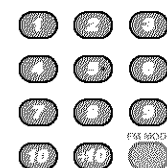

Ex.: For track number 5, press 5.

For track number 15, press +10, then 5.

For track number 20, press +10, then 10.

For track number 32, press +10 three times, then 2.

For track number 132, press +10 thirteen times, then 2.

Programming the Playing Order of the Tracks —Program Play

You can arrange the playing order of the tracks before you start playing. **You can program up to 100 tracks.**

- To use Repeat Play (see page 19) for Program Play, press REPEAT after starting Program Play. Only REPEAT 1 and REPEAT ALL can be selected for Program Play.
- There is a time limit in doing the following steps. If the setting is canceled before you finish, start from step 2 again.

1 Load discs.

- If the current playing source is not the CD player, press CD ►/■, then ■ before going to the next step.

2 Activate Program Play.

On the unit:

Press **CD PLAY MODE** repeatedly until “**CD PROGRAM**” appears on the display.

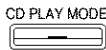

- Each time you press the button, the play mode changes as follows:

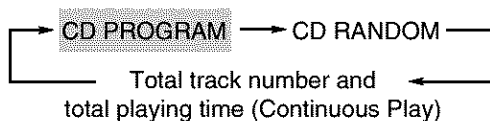

On the remote control:

Press **PROGRAM** so that “**CD PROGRAM**” appears on the display.

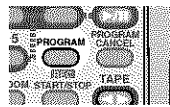

The PROGRAM indicator lights up on the display.



- If a program has been stored in memory, the program is called up.

3 Press one of the disc number buttons (CD1 – CD5) to select the disc you want.

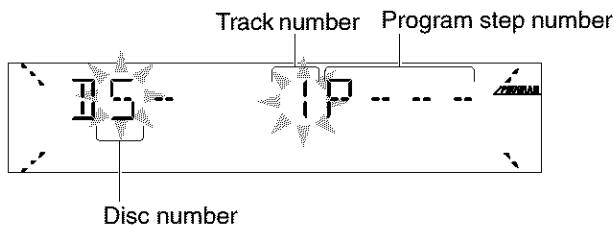
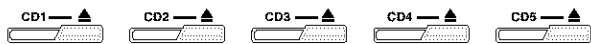

4 Select a track from the selected disc in step 3.

- Program step numbers exceeding 100 cannot be programmed.
- When making programs from MP3 discs, the unit only recognizes tracks like audio CD. You cannot make programs using group numbers.

On the unit:

Turn ►►/◄◄ to select the track number, then press **SET/DISPLAY**.

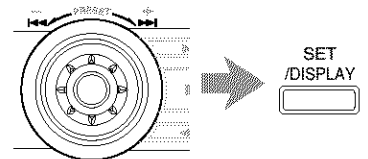

On the remote control:

Press the number buttons.

- For how to use the number buttons, see “To go to another track directly using the number buttons” on page 16.

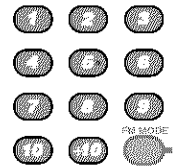

5 Program other tracks you want.

- To program tracks from the same disc, repeat step 4.
- To program tracks from a different disc, repeat steps 3 and 4.

6 Press CD ►/■.

The tracks are played in the order you have programmed.

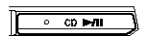

- If the playing disc is an MP3 disc, the MP3 indicator lights up.

To stop playing, press ■.

To exit from Program Play, press CD PLAY MODE repeatedly until the PROGRAM indicator goes off (or press PROGRAM on the remote control) after playback stops.



- If you try to program a 101st track, “CD FULL” appears on the display.
- If you have tried to program a track from an empty tray, “NO READ # (number)” or “NO DISC # (number)” will appear on the display for 2 seconds.
- If you have tried to program a track number that does not exist, it is ignored.
- If you try to open a disc tray during Program Play, the disc tray does not come out. Open disc trays after canceling Program Play.

To check the program contents

On the remote control ONLY:

Before playing, you can check the program contents by pressing

▶▶▶ (▶▶▶) or ◀◀◀ (◀◀◀).

- ▶▶▶ (▶▶▶): Shows them in the programmed order.
- ◀◀◀ (◀◀◀): Shows the programmed tracks in the reverse order.



To modify the program

To erase the last programmed tracks, press CANCEL/DEMO (or press PROGRAM CANCEL on the remote control).

- Each time you press the button, the last programmed track is erased from the program.

CANCEL
/DEMO

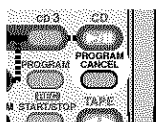

To add tracks into the program before playing, simply select the track numbers you want to add by following step 4 of the programming procedure. If you want to add tracks from another disc, follow steps 3 and 4.

To erase the entire program before or after playing, press

■ until "CD PROGRAM" appears on the display.

- The program you have made will be erased:
 - when you unplug the AC power cord, or
 - when a power failure occurs.

Playing at Random—Random Play

The tracks of all the loaded discs will be played at random.

- To use Repeat Play (see page 19) for Random Play, press REPEAT after starting Random Play. Only REPEAT 1 and REPEAT ALL can be selected for Random Play.

1 Load a disc.

2 Press the corresponding disc number button (CD1 – CD5) where a disc is loaded in step 1, then press ■.

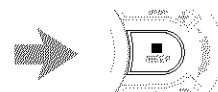

3 Activate Random Play.

On the unit:

Press CD PLAY MODE repeatedly until "CD RANDOM" appears on the display.

CD PLAY MODE



- Each time you press the button, the play mode changes as follows:

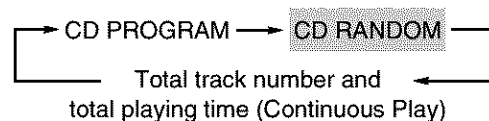

On the remote control:

Press RANDOM so that "CD RANDOM" appears on the display.

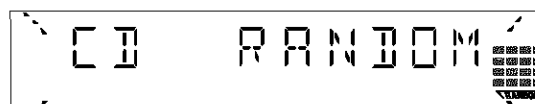
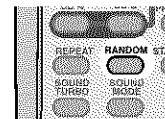

- The RANDOM indicator also lights up on the display.

4 Press CD ▶/II.

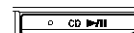

The tracks are played randomly.

Random Play ends when all the tracks of the all loaded discs are played once.

To skip the currently playing track, turn ◀◀◀ / ▶▶▶ to the right (or press ▶▶▶ (▶▶▶) on the remote control).



If you turn ◀◀◀ / ▶▶▶ to the left (or press ◀◀◀ (◀◀◀) on the remote control)

You cannot go back to the previous tracks during Random Play.

To stop playing, press ■.

To exit from Random Play, press CD PLAY MODE repeatedly until the RANDOM indicator goes off (or press RANDOM on the remote control) after playback stops.

Repeating Tracks or Discs—Repeat Play

You can have all the discs, the program or the individual track currently playing repeat as many times as you like.

Press REPEAT during or before play.

- Each time you press the button, Repeat Play mode changes as follows:

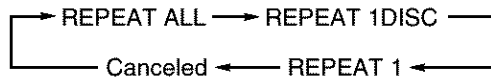
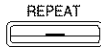

The Repeat Play mode indicators (REPEAT ALL, REPEAT 1DISC or REPEAT 1) light up on the display.

For audio CDs:

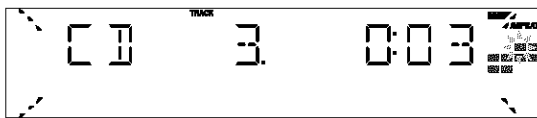

For MP3 discs:

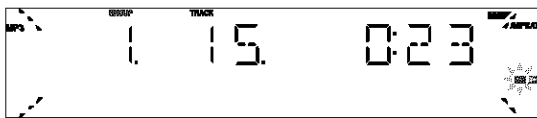

- REPEAT ALL:** During Continuous Play
Repeats all the tracks on all the loaded discs continuously.
- During Program Play
Repeats the program you have made.
- During Random Play
Repeats all the tracks of all the loaded discs randomly.
- REPEAT 1DISC:** Repeats all the tracks on the current disc continuously.
- REPEAT 1:** Repeats the track currently playing.

To cancel Repeat Play, press REPEAT repeatedly until the Repeat Play mode indicators go off from the display.



“REPEAT 1DISC” cannot be selected for Program Play or Random Play

It is also canceled when you select Program Play or Random Play.

Prohibiting Disc Ejection—Tray Lock

You can prohibit disc ejection from the unit and lock discs.

- This operation is possible only when the source is the CD player.

On the unit ONLY:

To prohibit disc ejection, press ▲ for any disc tray while holding down ■. (If any disc tray is opened, close it first.)

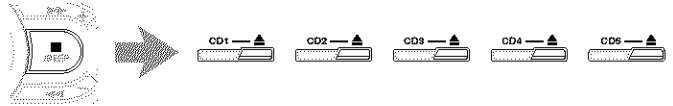

“LOCKED” appears for a while on the display, and all the loaded discs are locked.

LOCKED

To cancel the prohibition and unlock the discs, press ▲ for any disc tray while holding down ■.

“UNLOCKED” appears for a while on the display, and all the loaded discs are unlocked.

UNLOCKED



- If you try to eject discs while Tray Lock is in use, “LOCKED” appears to inform you that the disc trays are locked.
- Each time you press and hold ■ for more than 2 seconds with ▲ to lock or unlock the disc trays, key-touch tone also activates and deactivates (see page 11).

Playing Back Tapes

You can play back type I tapes.

Playing Back a Tape

1 Press **EJECT** for the cassette deck.

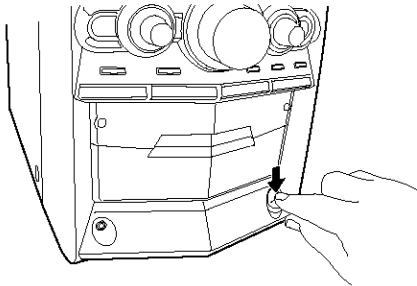

2 Insert a cassette with the exposed part of the tape down.

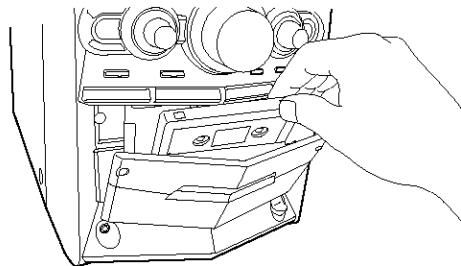

3 Close the cassette holder gently.

4 Press **TAPE**.



The tape play starts and the tape direction indicator (▶ or ◀) starts flashing slowly to indicate the tape's running direction.

- Each time you press the button, the tape direction changes and "REVERSE" appears for a while on the display.
 - ▶ : plays the front side.
 - ◀ : plays the reverse side.
- If no cassette is inserted, "NO TAPE" appears on the display.

When the tape plays to the end, the deck automatically stops if the Reverse Mode is off. (See "To play both sides repeatedly—Reverse Mode.")

To stop playing, press ■.

To fast-wind to the left or to the right, press ▶▶ or ◀◀ (or ▶▶| (▶▶) / |◀◀ (◀◀) on the remote control) while the tape is not running.

The tape direction indicator (▶ or ◀) starts flashing quickly on the display.

To remove the cassette, press EJECT to open the cassette holder.

To play both sides repeatedly—Reverse Mode

When using Reverse Mode, the tape automatically reverses at the end of one side, starts playing the other side of the tape, and repeats the same process.

On the unit ONLY:

To use Reverse Mode, press REVERSE MODE so that the Reverse Mode indicator lights up on the display like—(Z).



To cancel Reverse Mode, press the button again so that the Reverse Mode indicator lights up on the display like—Z.

Locating the Beginning of a Song—Music Scan

You can use Music Scan to locate the beginning of a song. Music Scan searches for blank portions that usually separate recorded songs, then plays the next song.

To find the beginning of the current song

During play, press ▶▶ or ◀◀ (or ▶▶| (▶▶) / |◀◀ (◀◀) on the remote control) in the **opposite direction** to the tape play.

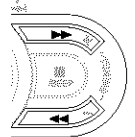

The tape direction indicator of the opposite direction to the tape play starts flashing intermittently.

Searching stops automatically at the beginning of the current song, and it starts automatically.

To find the beginning of the next song

During play, press ▶▶ or ◀◀ (or ▶▶| (▶▶) / |◀◀ (◀◀) on the remote control) in the **same direction** as the tape is playing.

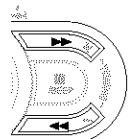

The tape direction indicator of the same direction as the tape is playing starts flashing intermittently.

Searching stops automatically at the beginning of the next song, and the song starts automatically.



Music Scan works by detecting a 4-second long blank between each song, so it will not work well in the following cases

- No blank at the beginning of a song.
- Noise (often caused by much use or poor quality dubbing) which fills the blank.
- Long, very soft passages or pauses in a song.



The use of C-120 or thinner tape is not recommended, since characteristic deterioration may occur and this tape easily jams in the pinch-rollers and the capstans.

Recording

IMPORTANT:

- It should be noted that it may be unlawful to re-record pre-recorded tapes, records, or discs without the consent of the owner of copyright in the sound or video recording, broadcast or cable program and in any literary, dramatic, musical, or artistic embodied therein.
- The recording level is automatically set correctly, so it is not affected by the VOLUME, the SUBWOOFER LEVEL, and the SOUND MODE controls, or the SOUND TURBO button. Thus, during recording you can adjust the sound you are actually listening to without affecting the recording level.
- If there are excessive noise or static in the recording you have made, the unit may be too close to a TV. Increase the distance between the TV and the unit.
- You can only use type I tape for recording.

To protect your recording

Cassettes have two small tabs on the back to protect from unexpected erasure or re-recording.

To protect your recording, remove these tabs.

To re-record on a protected tape, cover the holes with adhesive tape.



To keep the best recording and playback sound quality

If the heads, capstans, and pinch rollers of the cassette deck become dirty, the following will occur:

- Impaired sound quality
- Discontinuous sound
- Fading
- Incomplete erasure
- Difficulty in recording

To clean the heads, capstans, and pinch rollers

Use a cotton swab moistened with alcohol.

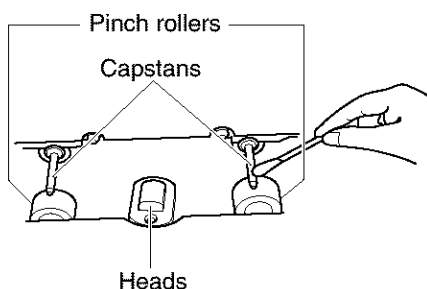

To demagnetize the heads

Turn off the unit, and use a head demagnetizer (available at electronics and audio shops).

Recording on a Tape

- 1 Press **▲ EJECT** and insert a recordable cassette with the exposed part of the tape down.

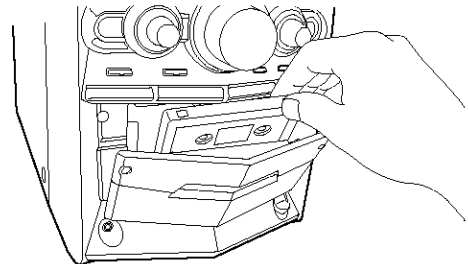

- 2 Close the cassette holder gently.
 - If you want to record on both sides of a tape, see “To record on both sides—Reverse Mode.”
- 3 Check the tape direction of the cassette deck.
 - If the tape direction is not correct, press TAPE **◀▶** twice then **■** to change the tape direction.
- 4 Start playing the source—FM, AM, CD player, or auxiliary equipment connected to AUX jacks.
 - When the source is the CD player, you can also use Synchronized Recording—(see page 22).
- 5 Start recording.

On the unit:

Press **REC START/STOP**.

On the remote control:

Press and hold **REC START/STOP** for more than 1 second.

The REC (recording) lamp flashes when recording starts, and the tape direction indicator (▶ or ◀) starts flashing slowly.

- If no cassette is inserted, “NO TAPE” appears on the display. If a protected tape is inserted, “NO REC” appears on the display.

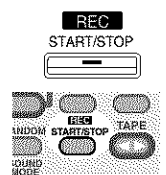

To stop recording immediately, press **REC START/STOP** or **■** (or press and hold **REC START/STOP** on the remote control for more than 1 second).

To remove the cassette, press **▲ EJECT** to open the cassette holder.

To record on both sides—Reverse Mode

On the unit ONLY:

Press **↔ REVERSE MODE** so that the Reverse Mode indicator lights up on the display like—**↔**.



- When using the Reverse Mode for recording, start recording in the forward (▶) direction first. Otherwise, recording will stop when only one side (reverse) of the tape is recorded.

To cancel Reverse Mode, press the button again so that the Reverse Mode indicator lights up on the display like—**↔**.

Synchronized Recording

By using Synchronized Recording, you can start and stop both disc play and tape recording at the same time. Everything on the disc goes onto the tape in the order it is on the disc, or according to the order you have made for Program Play.

On the unit ONLY:

- 1 Press **▲ EJECT** and insert a recordable cassette with the exposed part of the tape down.

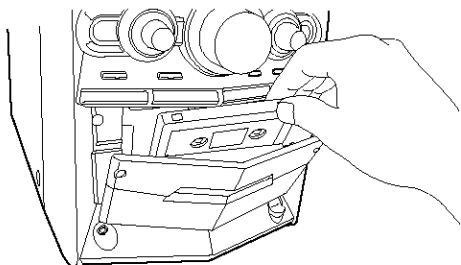

- 2 Load a disc.

- 3 Select a disc.

For audio CDs:

Press the corresponding disc number button (CD1 – CD5) where a disc is loaded in step 2, then press **■**.

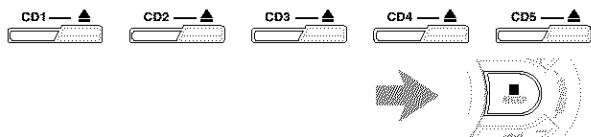

For MP3 discs:

You can select a track to start recording with.

- 1) Press the corresponding disc number button (CD1 – CD5) where a disc is loaded in step 2, then press **■**.

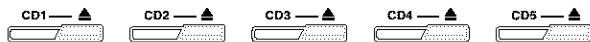

- 2) Turn **▶▶|/|◀◀** to select the group, then press **CD ▶/||**.

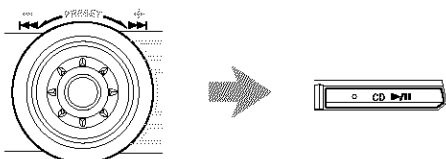

- 3) Turn **▶▶|/|◀◀** to select the track.

- 4 Press **CD REC START**.

“CD REC” appears on the display and the REC (recording) lamp flashes when recording starts.



The cassette deck starts recording when the CD player starts playing.

When the recording is done, “CD REC FINISHED” scrolls on the display, and the REC (recording) lamp turns off. Both the cassette deck and the CD player stop automatically.

To stop recording, press **■** to create a 4-second blank portion on the recording tape. (Remember a 4-second blank is important when using Music Scan—see page 20.)

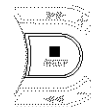

To record on both sides—Reverse Mode

On the unit ONLY:

Press **↔ REVERSE MODE** so that the Reverse Mode indicator on the display lights up like **↔**.



- When using the Reverse Mode for Synchronized Recording, start recording in the forward (**▶**) direction first. When the tape reaches its end while recording a song in the forward direction (**▶**), the last song will be re-recorded at the beginning of the reverse side (**◀**).

If you start recording on the reverse side (**◀**) first, recording will stop when only one (reverse) side of the tape is recorded.

To cancel Reverse Mode, press the button again so that the Reverse Mode indicator lights up on the display like **—**.



When making Sleep Timer settings while doing Synchronized Recording

Set enough time to allow for the disc to finish playing; otherwise, the power will go off before recording is completed.

Using the Timers

There are three timers available—DAILY (Daily Timer), REC (Recording Timer), and SLEEP (Sleep Timer).

- You can set the timers whether the unit is on or off.

Before using the timers, set the clock built in the unit. (See page 9.)

Using Daily Timer

With Daily Timer, you can wake up to your favorite music or radio program.

How Daily Timer actually works

The unit automatically turns on, sets the volume level to the preset level, and starts playing the specified source when the on-time comes. (“DAILY” and the DAILY indicator on the display flash just before the on-time. The DAILY indicator continues flashing while the timer is operating.) Then, when the off-time comes (“DAILY OFF” appears on the display just before the off-time), the unit automatically turns off (standby).

The Daily Timer works everyday automatically. If you do not want to use the Daily Timer, turn it off. (See “To turn on or off Daily Timer after its setting is done” on page 24.) The timer setting remains in memory until you change it.

- There is a time limit in doing the following steps. If the setting is canceled before you finish, start from step 1 again.
- To correct a misentry while setting the timer, press CANCEL/DEMO.

Before you start...

- When using a disc as the source to play:
 - Make sure there is a disc on the selected disc tray.
- When using a tape as the source to play:
 - Make sure that a tape is in the cassette deck.
 - Make sure that the tape direction is correct.
- When using an external component as the source to play:
 - Set the timer equipped on the external component to the same time.

On the unit ONLY:

- Press  **CLOCK/TIMER** repeatedly until “DAILY” appears on the display.



The  (Timer) indicator lights up and the DAILY (Daily Timer) indicator also starts flashing on the display.

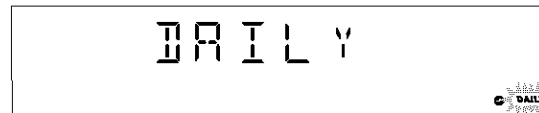

- Each time you press the button, the timer setting modes change as follows:

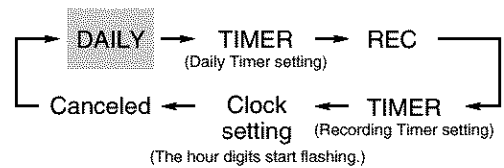

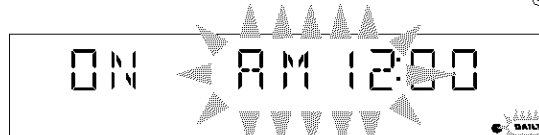

- Press  **CLOCK/TIMER** again.

“TIMER” appears for about 2 seconds, then the unit enters on-time setting mode.



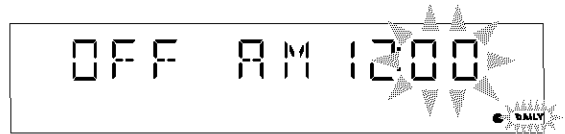
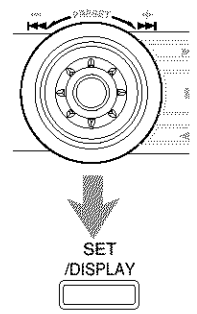

- Set the on-time you want the unit to turn on at.

- Turn  to set the hour, then press SET/DISPLAY.
- Turn  to set the minute, then press SET/DISPLAY. “SET” appears for about 1 second, then the unit enters off-time setting mode.



- Set the off-time you want the unit to turn off (standby) at.

- Turn  to set the hour, then press SET/DISPLAY.
- Turn  to set the minute, then press SET/DISPLAY. “SET” appears for about 1 second, then the unit enters source selecting mode.

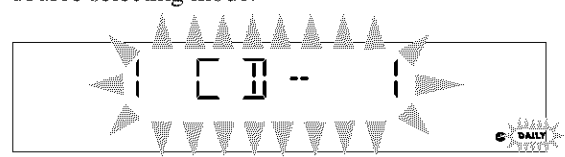

5 Turn ►►/|◄◄ to select the source to play, then press SET/DISPLAY.

“SET” appears for about 1 second.

- As you turn ►►/|◄◄, the source changes as follows:



TUNER FM: tunes in to a specified preset FM station. → Go to step 6.

TUNER AM: tunes in to a specified preset AM station. → Go to step 6.

1 CD-- 1: plays from a specified track of a specified disc. → Go to step 6.

TAPE: plays a tape in the cassette deck. → Go to step 7.

AUX IN: plays an external source. → Go to step 7.

6 When selecting “TUNER FM” or “TUNER AM”

Turn ►►/|◄◄ to select the preset station number, then press SET/DISPLAY.

The unit enters volume setting mode.

When selecting “1 CD-- 1”

1) Turn ►►/|◄◄ to select the disc number, then press SET/DISPLAY.

“SET” appears for about 1 second.

2) Turn ►►/|◄◄ to set the track number, then press SET/DISPLAY.

“SET” appears for about 1 second, then the unit enters volume setting mode.

7 Turn ►►/|◄◄ to set the volume level.

- The volume level changes as follows:

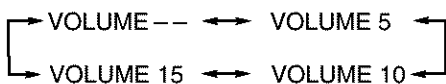
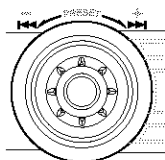

- If you select “VOLUME --,” the volume is set to the last level when the unit has been turned off.

8 Press SET/DISPLAY to complete the Daily Timer setting.



The DAILY (Daily Timer) indicator stops flashing and remains lit. “OK ✓” appears on the display for about 2 seconds.

The settings you have done are shown on the display in sequence for your confirmation.

9 Press ◻/| to turn off the unit (standby) if you have set the Daily Timer with the unit turned on.

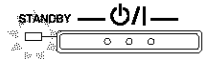

- If the unit is turned on before the on-time comes Daily Timer does not work.
- Even if you unplug the AC power cord or if a power failure occurs Once you set the timer, the timer setting may remain stored in memory in a few days. Check whether the timer setting still remains or not.

To turn on or off Daily Timer after it has been set

1 Press ◻ CLOCK/TIMER repeatedly until “DAILY” appears on the display.



The DAILY (Daily Timer) indicator starts flashing on the display and the ◻ (Timer) indicator remains lit.

2 To turn off the Daily Timer, press CANCEL/DEMO.



The DAILY (Daily Timer) and the ◻ (Timer) indicators go off from the display (“DAILY OFF” appears for a while).

The Daily Timer is canceled, but the setting for the Daily Timer remains in memory.

— Or —

To turn on the Daily Timer, press SET/DISPLAY.



“OK ✓” appears on the display for about 2 seconds.

The settings you have done are shown on the display in sequence for your confirmation.

Using Recording Timer

With Recording Timer, you can make a tape of a radio broadcast automatically.

How Recording Timer actually works

The unit automatically turns on, tunes in to the specified station, sets the volume level to "VOLUME MIN," and starts recording when the on-time comes. ("REC" and the REC indicator on the display flash just before the on-time. The REC indicator continues flashing while the timer is operating). Then, when the off-time comes ("REC OFF" appears on the display just before the off-time), the unit automatically turns off (standby).

The timer setting remains in memory until you change it.

- There is a time limit in doing the following steps. If the setting is canceled before you finish, start from step 2 again.
- To correct a mistake while setting the timer, press CANCEL/DEMO.

On the unit ONLY:

1 Insert a recordable cassette with the exposed part of the tape down.

2 Press  CLOCK/TIMER repeatedly until "REC" appears on the display.

The  (Timer) indicator lights up and the REC (Recording Timer) indicator also starts flashing on the display.



- Each time you press the button, the timer setting modes change as follows:

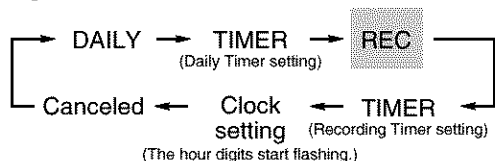



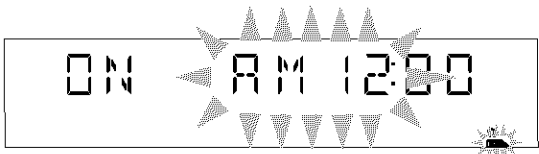

3 Press  CLOCK/TIMER again.

"TIMER" appears for about 2 seconds, then the unit enters on-time setting mode.





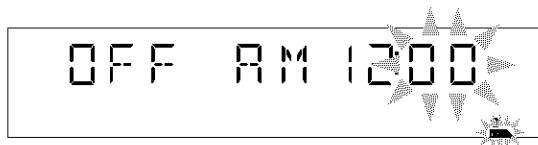
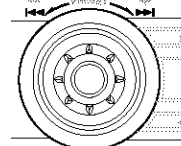

4 Set the on-time you want the unit to turn on at.





- 1) Turn  /  to set the hour, then press SET/DISPLAY.
- 2) Turn  /  to set the minute, then press SET/DISPLAY.



5 Set the off-time you want the unit to turn off (standby) at.

- 1) Turn  /  to set the hour, then press SET/DISPLAY.
 - 2) Turn  /  to set the minute, then press SET/DISPLAY.
- "SET" appears for about 1 second, then the unit enters preset station selecting mode.

6 Select the preset station.

- 1) Turn  /  to select the band ("TUNER FM" or "TUNER AM"), then press SET/DISPLAY.
 - 2) Turn  /  to select a preset channel number, then press SET/DISPLAY.
- The REC (Recording Timer) indicator stops flashing and remains lit. "OK ✓" appears on the display for about 2 seconds.
- The settings you have done are shown on the display in sequence for your confirmation.

7 Press  to turn off the unit (standby) if necessary.

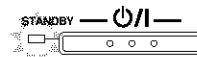

- **If you want to listen to another source while recording**
Press REC START/STOP or  to stop recording. Without stopping it, you cannot change the source.
- **Even if you unplug the AC power cord or if a power failure occurs**
Once you set the timer, the timer setting may remain stored in memory for a few days. Check whether or not the timer setting still remains.

To turn on or off Recording Timer after it has been set

1 Press **CLOCK/TIMER** repeatedly until “REC” appears on the display.

The REC (Recording Timer) indicator starts flashing on the display and the  (Timer) indicator remains lit.



2 To turn off the Recording Timer, press **CANCEL/DEMO**.

The REC (Recording Timer) indicator goes off from the display (“REC OFF” appears on the display for about 2 seconds).

The Recording Timer is canceled, but the setting for the Recording Timer remains in memory.



— Or —

To turn on the Recording Timer, press **SET/DISPLAY**.

“OK ✓” appears on the display for about 2 seconds.

The settings you have done are shown on the display in sequence for your confirmation.



Using Sleep Timer

With Sleep Timer, you can fall asleep to music. You can set Sleep Timer only while the unit is turned on.

How Sleep Timer actually works

The unit automatically turns off after the specified time length passes.

On the remote control ONLY:

1 Press **SLEEP**.

The time length until the shut-off time appears and the SLEEP indicator starts flashing on the display.

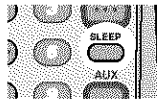

- Each time you press the button, the time length changes as follows:

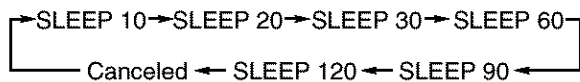

- If the built-in clock has not been set, “CLOCK ADJUST” appears on the display.

2 Wait for about 5 seconds after specifying the time length.

The SLEEP indicator flashes slowly until Sleep Timer activates.

To check the remaining time until the shut-off time, press SLEEP once so that the remaining time (minutes) until the shut-off time appears for about 5 seconds.

To change the shut-off time, press SLEEP repeatedly until the desired time length appears on the display.

To cancel the setting, press SLEEP repeatedly so that the SLEEP indicator goes off.

- Sleep Timer is also canceled when you turn off the unit.

Timer Priority

Since each timer can be set separately, you may wonder what happens if the settings for these timers overlap.

Recording Timer has priority over Daily Timer and Sleep Timer. Below are some examples.

- If Daily Timer is set to come on while Recording Timer is operating, Daily Timer will not come on at all.

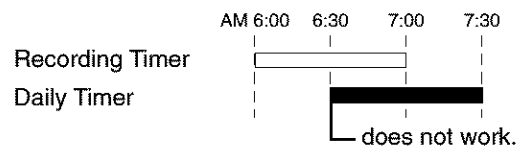

- If Sleep Timer is set to come on while Recording Timer is operating, Sleep Timer will not come on at all.

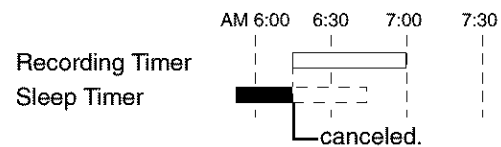

- If Recording Timer and Daily Timer are set to come on at the same time, Recording Timer will activate.

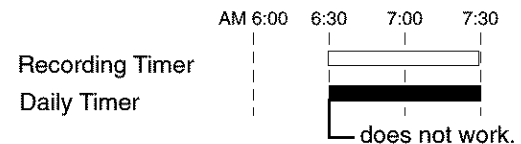

Maintenance

To get the best performance from the unit, keep your discs, tapes, and mechanism clean.

General Notes

In general, you will have the best performance by keeping your discs and the mechanism clean.

- Store discs in their cases, and keep them in cabinets or on shelves.
- Keep the unit's disc trays closed when not in use.

Handling discs



- Remove the disc from its case by holding it at the edge while pressing the center hole lightly.
- Do not touch the shiny surface of the disc, or bend the disc.
- Put the disc back in its case after use to prevent warping.

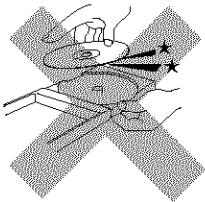

- Be careful not to scratch the surface of the disc when placing it back in its case.
- Avoid exposure to direct sunlight, temperature extremes, and moisture.



To clean the disc

Wipe the disc with a soft cloth in a straight line from center to edge.



Continued use of irregular shape discs (heart-shape, octagonal, etc.) can damage the unit.



DO NOT use any solvent—such as conventional record cleaner, spray, thinner, or benzine—to clean the disc.

Handling cassette tapes

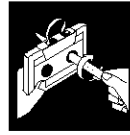

- If the tape is loose in its cassette, take up the slack by inserting a pencil in one of the reels and rotating.
- If the tape is loose, it may get stretched, cut, or caught in the cassette.

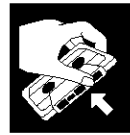

- Be careful not to touch the tape surface.



- Avoid the following places to store the tape:
 - In dusty places
 - In direct sunlight or heat
 - In moist areas
 - Near a magnet

Cleaning the unit

Stains on the unit

Should be wiped off with a soft cloth. If the unit is heavily stained, wipe it with a cloth soaked in water diluted neutral detergent and wrung well, then wipe clean with a dry cloth.

Since the unit may deteriorate in quality, become damaged or get its paint peeled off, be careful about the following:

- DO NOT wipe it with a hard cloth.
- DO NOT wipe it strong.
- DO NOT wipe it with thinner or benzine.
- DO NOT apply any volatile substance such as insecticides to it.
- DO NOT allow any rubber or plastic to remain in contact with it for a long time.

Troubleshooting

If you are having a problem with your unit, check this list for a possible solution before calling for service. If you cannot solve the problem from the hints given here, or the unit has been physically damaged, call a qualified person, such as your dealer, for service.

	Symptom	Cause	Action
GENERAL	Unable to cancel the demonstration.	A button other than CANCEL/DEMO has been pressed to cancel the demonstration temporarily.	Press CANCEL/DEMO on the unit. (See page 8.)
	No sound is heard.	Connections are incorrect or loose.	Check all connections and make corrections. (See pages 6 to 8.)
	Operations are disabled.	The built-in microprocessor may malfunction due to external electrical interference.	Unplug the AC power cord and then plug it back in.
	Unable to operate the unit from the remote control.	<ul style="list-style-type: none"> The path between the remote control and the remote sensor on the unit is blocked. The batteries are used up. 	<ul style="list-style-type: none"> Remove the obstruction. Replace the batteries.
TUNER	Hard to listen to broadcasts because of noise.	<ul style="list-style-type: none"> Antennas are disconnected. The AM loop antenna is too close to the unit. The FM antenna is not properly extended and positioned. 	<ul style="list-style-type: none"> Reconnect the antennas correctly and securely. Change the position and direction of the AM loop antenna. Extend the FM antenna to the best position.
AUDIO CD	The disc sound is discontinuous.	The disc is scratched or dirty.	Clean or replace the disc. (See page 27.)
	The disc trays will not open or close.	<ul style="list-style-type: none"> The AC power cord is not plugged in. Trays are locked. 	<ul style="list-style-type: none"> Plug in the AC power cord. Unlock the trays. (See page 19.)
MP3 DISCS	The disc does not play.	The disc is placed upside down.	Place the disc with the label side up.
	The disc does not play.	<ul style="list-style-type: none"> No MP3 files are recorded on the disc. MP3 files do not have the file extension—.MP3, .Mp3, .mp3, or .mp3, in their file names. MP3 files are not recorded in a format compliant with ISO 9660 Level 1 or Level 2. 	Replace the disc.
MP3 DISCS	The disc readout time is too long.	The readout time varies with the complexity of the recording configuration.	Do not use too many hierarchies and folders when recording. Also, do not record any other types of audio tracks together with MP3 files.
	The cassette holders cannot be opened.	Power supply from the AC power cord has been cut off while the tape was running.	Turn on the unit.
REC	Impossible to record.	Small tabs on the back of the cassette are removed.	Cover the holes with adhesive tape. (See page 21.)

Specifications

Amplifier section—CA-HXZ30

Output Power

SUBWOOFERS: 190 W per channel, min. RMS, driven into 6 Ω at 63 Hz with no more than 10% total harmonic distortion.

MAIN SPEAKERS: 80 W per channel, min. RMS, driven into 6 Ω at 1 kHz with no more than 10% total harmonic distortion.

Audio input sensitivity/impedance

(Measured at 1 kHz, with tape recording signal 300 mV)

AUX: 300 mV/47 k Ω

Speakers/impedance:

SUBWOOFERS: 6 Ω – 16 Ω

MAIN SPEAKERS: 6 Ω – 16 Ω

Tuner

FM tuning range: 87.5 MHz – 108.0 MHz

AM tuning range: 530 kHz – 1 710 kHz

CD player

Disc capacity: 5 discs

Dynamic range: 87 dB

Signal-to-noise ratio: 90 dB

Wow and flutter: Immeasurable

MP3 recording format: MPEG 1/2 Audio Layer 3

Max. Bit rate: 320 kbps

Cassette deck

Frequency response

Normal (type I): 50 Hz – 14 000 Hz

Wow and flutter: 0.15% (WRMS)

General

Power requirement: AC 120 V \sim , 60 Hz

Power consumption: 250 W/310 VA (in operation)

27 W (on standby)

Dimensions (approx.): 205 mm x 370 mm x 380.5 mm (W/H/D)

(8 $\frac{1}{8}$ inch x 14 $\frac{5}{8}$ inch x 15 inch)

Mass (approx.): 10.5 kg (23.2 lbs)

Supplied accessories

See page 6.

Speaker section—SP-HXZ30

Type: 3-Way 4-Speaker Bass-Reflex Type
Twin Hyper Power-Drive Subwoofer

Speaker units: Subwoofer: 20 cm (7 $\frac{7}{8}$ inch) cone x1

Woofers: 13.5 cm (5 $\frac{3}{8}$ inch) cone x2

Tweeter: 5 cm (2 inch) cone x1

Power handling capacity: Subwoofer: 190 W

Main speaker: 80 W

Impedance: Subwoofer: 6 Ω

Main speaker: 6 Ω

Frequency range: Subwoofer: 30 Hz – 818 Hz

Main speaker: 75 Hz – 30 000 Hz

Sound pressure level: Subwoofer: 81 dB/W•m

Main speaker: 88 dB/W•m

Dimensions (approx.): 247 mm x 452 mm x 391 mm (W/H/D)

(9 $\frac{3}{4}$ inch x 17 $\frac{13}{16}$ inch x 15 $\frac{7}{16}$ inch)

Mass (approx.): 10.0 kg (22.1 lbs) each

Design and specifications are subject to change without notice.

Amplifier section—CA-HXZ10

Output Power

SUBWOOFERS: 165 W per channel, min. RMS, driven into 6 Ω at 63 Hz with no more than 10% total harmonic distortion.

MAIN SPEAKERS: 75 W per channel, min. RMS, driven into 6 Ω at 1 kHz with no more than 10% total harmonic distortion.

Audio input sensitivity/impedance

(Measured at 1 kHz, with tape recording signal 300 mV)

AUX: 300 mV/47 k Ω

Speakers/impedance:

SUBWOOFERS: 6 Ω – 16 Ω

MAIN SPEAKERS: 6 Ω – 16 Ω

Tuner

FM tuning range: 87.5 MHz – 108.0 MHz

AM tuning range: 530 kHz – 1 710 kHz

CD player

Disc capacity: 5 discs

Dynamic range: 87 dB

Signal-to-noise ratio: 90 dB

Wow and flutter: Immeasurable

MP3 recording format: MPEG 1/2 Audio Layer 3

Max. Bit rate: 320 kbps

Cassette deck

Frequency response

Normal (type I): 50 Hz – 14 000 Hz

Wow and flutter: 0.15% (WRMS)

General

Power requirement: AC 120 V \sim , 60 Hz

Power consumption: 235 W/295 VA (in operation)

26 W (on standby)

Dimensions (approx.): 205 mm x 370 mm x 380.5 mm (W/H/D)

(8 ¹/₈ inch x 14 ⁵/₈ inch x 15 inch)

Mass (approx.): 10.5 kg (23.2 lbs)

Supplied accessories

See page 6.

Speaker section—SP-HXZ10

Type: 3-Way 4-Speaker Bass-Reflex Type

Twin Hyper Power-Drive Subwoofer

Speaker units: Subwoofer: 16 cm (6 ⁵/₁₆ inch) cone x1

Woofers: 10 cm (3 ¹⁵/₁₆ inch) cone x2

Tweeter: 5 cm (2 inch) cone x1

Power handling capacity: Subwoofer: 165 W

Main speaker: 75 W

Impedance: Subwoofer: 6 Ω

Main speaker: 6 Ω

Frequency range: Subwoofer: 30 Hz – 325 Hz

Main speaker: 70 Hz – 32 000 Hz

Sound pressure level: Subwoofer: 78 dB/W•m

Main speaker: 86 dB/W•m

Dimensions (approx.): 220 mm x 432 mm x 357 mm (W/H/D)

(8 ¹¹/₁₆ inch x 17 ¹/₁₆ inch x 14 ¹/₁₆ inch)

Mass (approx.): 8.2 kg (18.1 lbs) each

Design and specifications are subject to change without notice.



LIMITED WARRANTY

AUDIO-1

JVC COMPANY OF AMERICA warrants this product and all parts thereof, except as set forth below ONLY TO THE ORIGINAL PURCHASER AT RETAIL to be FREE FROM DEFECTIVE MATERIALS AND WORKMANSHIP from the date of original retail purchase for the period as shown below. ("The Warranty Period")

PARTS	1 YR	LABOR	1 YR
-------	-------------	-------	-------------

THIS LIMITED WARRANTY IS VALID ONLY IN THE FIFTY (50) UNITED STATES, THE DISTRICT OF COLUMBIA AND IN COMMONWEALTH OF PUERTO RICO.

WHAT WE WILL DO:

If this product is found to be defective, JVC will repair or replace defective parts at no charge to the original owner. Such repair and replacement services shall be rendered by JVC during normal business hours at JVC authorized service centers. Parts used for replacement are warranted only for the remainder of the Warranty Period. All products and parts thereof may be brought to a JVC authorized service center on a carry-in basis except for Television sets having a screen size 25 inches and above which are covered on an in-home basis.

WHAT YOU MUST DO FOR WARRANTY SERVICE:

Return your product to a JVC authorized service center with a copy of your bill of sale. For your nearest JVC authorized service center, please call toll free: (800) 537-5722.

If service is not available locally, box the product carefully, preferably in the original carton, and ship, insured, with a copy of your bill of sale plus a letter of explanation of the problem to the nearest JVC Factory Service Center, the name and location of which will be given to you by the toll-free number.

If you have any questions concerning your JVC Product, please contact our Customer Relations Department.

WHAT IS NOT COVERED:

This limited warranty provided by JVC does not cover:

1. Products which have been subject to abuse, accident, alteration, modification, tampering, negligence, misuse, faulty installation, lack of reasonable care, or if repaired or serviced by anyone other than a service facility authorized by JVC to render such service, or if affixed to any attachment not provided with the products, or if the model number or serial number has been altered, tampered with, defaced or removed;
2. Initial installation and installation and removal for repair;
3. Operational adjustments covered in the Owner's Manual, normal maintenance, video and audio head cleaning;
4. Damage that occurs in shipment, due to act of God, and cosmetic damage;
5. Signal reception problems and failures due to line power surge;
6. Video Pick-up Tubes/CCD Image Sensor, Cartridge, Stylus (Needle) are covered for 90 days from the date of purchase;
7. Accessories
8. Batteries (except that Rechargeable Batteries are covered for 90 days from the date of purchase);

There are no express warranties except as listed above.

THE DURATION OF ANY IMPLIED WARRANTIES, INCLUDING THE IMPLIED WARRANTY OF MERCHANTABILITY, IS LIMITED TO THE DURATION OF THE EXPRESS WARRANTY HEREIN.

JVC SHALL NOT BE LIABLE FOR THE LOSS OF USE OF THE PRODUCT, INCONVENIENCE, LOSS OR ANY OTHER DAMAGES, WHETHER DIRECT, INCIDENTAL OR CONSEQUENTIAL (INCLUDING, WITHOUT LIMITATION, DAMAGE TO TAPES, RECORDS OR DISCS) RESULTING FROM THE USE OF THIS PRODUCT, OR ARISING OUT OF ANY BREACH OF THIS WARRANTY. ALL EXPRESS AND IMPLIED WARRANTIES, INCLUDING THE WARRANTIES OF MERCHANTABILITY AND FITNESS FOR PARTICULAR PURPOSE, ARE LIMITED TO THE WARRANTY PERIOD SET FORTH ABOVE.

Some states do not allow the exclusion of incidental or consequential damages or limitations on how long an implied warranty lasts, so these limitations or exclusions may not apply to you. This warranty gives you specific legal rights and you may also have other rights which vary from state to state.

JVC COMPANY OF AMERICA 1700 Valley Road
 DIVISION OF JVC AMERICAS CORP. Wayne, NJ 07470

REFURBISHED PRODUCTS CARRY A SEPARATE WARRANTY, THIS WARRANTY DOES NOT APPLY. FOR DETAILS OF REFURBISHED PRODUCT WARRANTY, PLEASE REFER TO THE REFURBISHED PRODUCT WARRANTY INFORMATION PACKAGED WITH EACH REFURBISHED PRODUCT.

For customer use:
 Enter below the Model No. which is located either on the rear, bottom or side of the cabinet. Retain this information for future reference.

Model No. : _____ Serial No. : _____
 Purchase data : _____ Name of dealer : _____

Authorized Service Centers

QUALITY **JVC**[®] SERVICE
HOW TO LOCATE YOUR JVC SERVICE CENTER
TOLL FREE: 1 (800) 537-5722
<http://www.jvc.com>

Dear Customer,

In order to receive the most satisfaction from your purchase, please read the instruction booklet before operating the unit. In the event that repairs are necessary, please call 1 (800) 537-5722 for your nearest authorized servicer or visit our website at **www.JVC.com**

Remember to retain your Bill of Sale for Warranty Service.

Do not service the television yourself

Caution

To prevent electrical shock, do not open the cabinet. There are no user serviceable parts inside. Please refer to qualified service personnel for repairs.

Accessories

To purchase accessories for your JVC product, please call toll free: 1 (800) 882-2345 or on the web at **www.JVC.com**

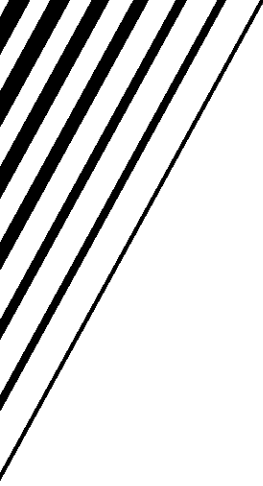

JVC
VICTOR COMPANY OF JAPAN, LIMITED

Free Manuals Download Website

<http://myh66.com>

<http://usermanuals.us>

<http://www.somanuals.com>

<http://www.4manuals.cc>

<http://www.manual-lib.com>

<http://www.404manual.com>

<http://www.luxmanual.com>

<http://aubethermostatmanual.com>

Golf course search by state

<http://golfingnear.com>

Email search by domain

<http://emailbydomain.com>

Auto manuals search

<http://auto.somanuals.com>

TV manuals search

<http://tv.somanuals.com>