



ENGLISH
ESPAÑOL
FRANÇAIS

KD-AR959BS / KD-R950BT / KD-R85MBS / KD-AR855BT / KD-R850BT

CD RECEIVER

INSTRUCTION MANUAL

RECEPTOR CON CD

MANUAL DE INSTRUCCIONES

RÉCEPTEUR CD

MANUEL D'INSTRUCTIONS

JVCKENWOOD Corporation

Please read all instructions carefully before operation to obtain the best possible performance from the unit.

Por favor lea detenidamente este manual para comprender a fondo todas las instrucciones y obtener un máximo disfrute de esta unidad.

Veuillez lire les instructions attentivement avant d'utiliser l'appareil afin d'obtenir les meilleures performances possibles de l'appareil.

For customer Use:

Enter below the Model No. and Serial No. which are located on the top or bottom of the cabinet. Retain this information for future reference.

Model No. _____

Serial No. _____

GET0981-001B [J]

CAUTION

Use of controls or adjustments or performance of procedures other than those specified herein may result in hazardous radiation exposure.
In compliance with Federal Regulations, following are reproductions of labels on, or inside the product relating to laser product safety.

JVC KENWOOD Corporation
2967-3, ISHIKAWA-MACHI,
HACHIOJI-SHI, TOKYO, JAPAN

THIS PRODUCT COMPLIES WITH DHHS RULES 21CFR
SUBCHAPTER J IN EFFECT AT DATE OF MANUFACTURE.

Location : Top Plate

Información acerca de la eliminación de equipos eléctricos y electrónicos al final de la vida útil (aplicable a los países que hayan adoptado sistemas independientes de recogida de residuos)



Los productos con el símbolo de un contenedor con ruedas tachado no podrán ser desechados como residuos domésticos. Los equipos eléctricos y electrónicos al final de la vida útil, deberán ser reciclados en instalaciones que puedan dar el tratamiento adecuado a estos productos y a sus subproductos residuales correspondientes. Póngase en contacto con su administración local para obtener información sobre el punto de recogida más cercano. Un tratamiento correcto del reciclaje y la eliminación de residuos ayuda a conservar los recursos y evita al mismo tiempo efectos perjudiciales en la salud y el medio ambiente.

FCC WARNING

This equipment may generate or use radio frequency energy. Changes or modifications to this equipment may cause harmful interference unless the modifications are expressly approved in the instruction manual. The user could lose the authority to operate this equipment if an unauthorized change or modification is made.

FCC NOTE

This equipment has been tested and found to comply with the limits for a Class B digital device, pursuant to Part 15 of the FCC Rules. These limits are designed to provide reasonable protection against harmful interference in a residential installation. This equipment may cause harmful interference to radio communications, if it is not installed and used in accordance with the instructions. However, there is no guarantee that interference will not occur in a particular installation. If this equipment does cause harmful interference to radio or television reception, which can be determined by turning the equipment off and on, the user is encouraged to try to correct the interference by one or more of the following measures:

- Reorient or relocate the receiving antenna.
- Increase the separation between the equipment and receiver.
- Connect the equipment into an outlet on a circuit different from that to which the receiver is connected.
- Consult the dealer or an experienced radio/TV technician for help.

CALIFORNIA, USA ONLY

This product contains a CR Coin Cell Lithium Battery which contains Perchlorate Material—special handling may apply. See www.dtsc.ca.gov/hazardouswaste/perchlorate

Informação sobre a eliminação de pilhas

Este produto não deve ser eliminado como lixo doméstico geral. Devolva a pilha usada ao revendedor ou entidade autorizada para que a mesma seja devolvida ao fabricante ou importador.
A reciclagem e a eliminação de lixo de maneira apropriada ajudarão a conservar os recursos naturais ao mesmo tempo que prevenirão os efeitos prejudiciais à nossa saúde e ao meio ambiente.

Para cumplimiento de la COFETEL:

“La operación de este equipo está sujeta a las siguientes dos condiciones:

- (1) es posible que este equipo o dispositivo no cause interferencia perjudicial y
- (2) este equipo o dispositivo debe aceptar cualquier interferencia, incluyendo la que pueda causar su operación no deseada”

IC (Industry Canada) Notice

This device complies with Industry Canada licence-exempt RSS standard(s).

Operation is subject to the following two conditions:

- (1) This device may not cause interference, and
- (2) this device must accept any interference, including interference that may cause undesired operation of the device.

The term “IC: ” before the certification/ registration number only signifies that the Industry Canada technical specification were met.

Note de IC (Industrie Canada)

Le présent appareil est conforme aux CNR d’Industrie Canada applicables aux appareils radio exempts de licence.

L’exploitation est autorisée aux deux conditions suivantes:

- (1) l’appareil ne doit pas produire de brouillage, et
- (2) l’utilisateur de l’appareil doit accepter tout brouillage radioélectrique subi, même si le brouillage est susceptible d’en compromettre le fonctionnement.

L’expression “IC:” avant le numéro d’homologation/ enregistrement signifie seulement que les spécifications techniques d’Industrie Canada ont été respectées.

CAUTION

This equipment complies with FCC/IC radiation exposure limits set forth for an uncontrolled environment and meets the FCC radio frequency (RF) Exposure Guidelines in Supplement C to OET65 and RSS-102 of the IC radio frequency (RF) Exposure rules. This equipment has very low levels of RF energy that it deemed to comply without maximum permissive exposure evaluation (MPE). But it is desirable that it should be installed and operated keeping the radiator at least 20cm or more away from person’s body (excluding extremities: hands, wrists, feet and ankles). Under Industry Canada regulations, this radio transmitter may only operate using an antenna of a type and maximum (or lesser) gain approved for the transmitter by Industry Canada. To reduce potential radio interference to other users, the antenna type and its gain should be so chosen that the equivalent isotropically radiated power (e.i.r.p.) is not more than that necessary for successful communication.

ATTENTION

Cet équipement est conforme aux limites d’exposition aux rayonnements énoncées pour un environnement non contrôlé et respecte les règles d’exposition aux fréquences radioélectriques (RF) CNR-102 de l’IC. Cet équipement émet une énergie RF très faible qui est considérée conforme sans évaluation de l’exposition maximale autorisée. Cependant, cet équipement doit être installé et utilisé en gardant une distance de 20 cm ou plus entre le dispositif rayonnant et le corps (à l’exception des extrémités : mains, poignets, pieds et chevilles). Conformément à la réglementation d’Industrie Canada, le présent émetteur radio peut fonctionner avec une antenne d’un type et d’un gain maximal (ou inférieur) approuvé pour l’émetteur par Industrie Canada. Dans le but de réduire les risques de brouillage radioélectrique à l’intention des autres utilisateurs, il faut choisir le type d’antenne et son gain de sorte que la puissance isotrope rayonnée équivalente (p.i.r.e.) ne dépasse pas l’intensité nécessaire à l’établissement d’une communication satisfaisante.

- Contains Bluetooth Module FCC ID: XQN-BTR60X
- Contains Bluetooth Module IC: 9688A-BTR601

CONTENTS

BEFORE USE	2
BASICS	3
GETTING STARTED	4
CD / USB / iPod	5
RADIO	7
AUX	8
Pandora®	9
iHeartRadio®	10
SiriusXM® Radio (for KD-AR959BS / KD-R85MBS)	11
BLUETOOTH®	13
AUDIO SETTINGS	19
DISPLAY SETTINGS	20
MORE INFORMATION	21
TROUBLESHOOTING	23
INSTALLATION / CONNECTION	26
SPECIFICATIONS	29

How to read this manual

- Operations are explained mainly using buttons on the faceplate of **KD-AR855BT**.
- [XX] indicates the selected items.
- (➔ XX) indicates references are available on the stated page.

BEFORE USE

⚠ Warning

Do not operate any function that takes your attention away from safe driving.

⚠ Caution

Volume setting:

- Adjust the volume so that you can hear sounds outside the car to prevent accidents.
- Lower the volume before playing digital sources to avoid damaging the speakers by the sudden increase of the output level.

General:

- Avoid using the USB device or iPod/iPhone if it might hinder safe driving.
- Make sure all important data has been backed up. We shall bear no responsibility for any loss of recorded data.
- Never put or leave any metallic objects (such as coins or metal tools) inside the unit, to prevent a short circuit.
- If a disc error occurs due to condensation on the laser lens, eject the disc and wait for the moisture to evaporate.

Remote control (RM-RK52):

- Do not leave the remote control in hot places such as on the dashboard.
- The Lithium battery is in danger of explosion if replaced incorrectly. Replace it only with the same or equivalent type.
- The battery pack or batteries shall not be exposed to excessive heat such as sunshine, fire or the like.
- Keep the battery out of reach of children and in its original packaging when not in used. Dispose of used batteries promptly. If swallowed, contact a physician immediately.

Maintenance

Cleaning the unit: Wipe off dirt on the faceplate with a dry silicone or soft cloth.

Cleaning the connector: Detach the faceplate and clean the connector gently with a cotton swab, being careful not to damage the connector.

Handling discs:

- Do not touch the recording surface of the disc.
- Do not stick tape etc. on the disc, or use a disc with tape stuck on it.
- Do not use any accessories for the disc.
- Clean from the center of the disc and move outward.
- Clean the disc with a dry silicone or soft cloth. Do not use any solvents.
- When removing discs from this unit, pull them out horizontally.
- Remove burrs from the center hole and disc edge before inserting a disc.

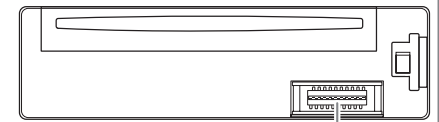

Connector (on the reverse side of the faceplate)

BASICS

Faceplate

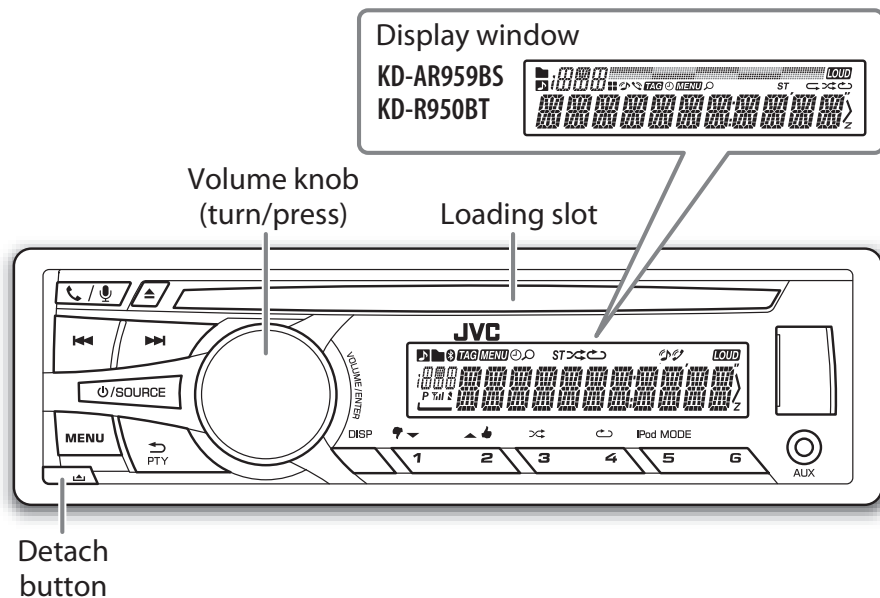

Attach

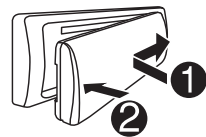

Detach

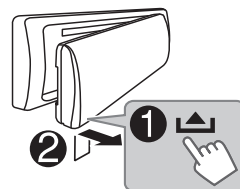

How to reset

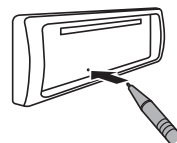

Your preset adjustments will also be erased.

Remote control (RM-RK52)

KD-R85MBS can be remotely controlled with an optionally purchased remote control.

Remote sensor (Do not expose to bright sunlight.)

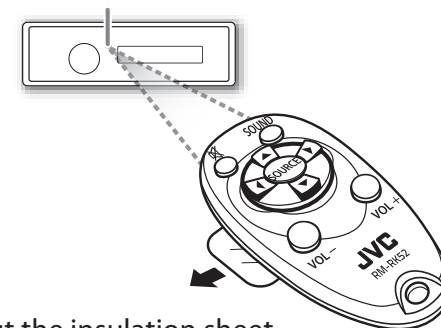

Pull out the insulation sheet when using for the first time.

How to replace the battery

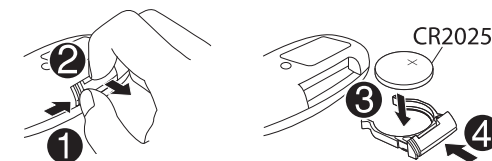

To	Do this (on the faceplate)	Do this (on the remote control)
Turn on the power	Press ⏻/SOURCE . • Press and hold to turn off the power.	(not available)
Adjust the volume	Turn the volume knob. Press the volume knob to mute the sound or pause playback. • Press again to cancel.	Press VOL + or VOL - . Press ⊗ to mute the sound or pause playback. • Press again to cancel.
Select a source	• Press ⏻/SOURCE repeatedly. • Press ⏻/SOURCE , then turn the volume knob within 2 seconds.	Press SOURCE repeatedly.
Change the display information	Press DISP repeatedly. (→ 23) • Press and hold to scroll the current display information.	(not available)

GETTING STARTED

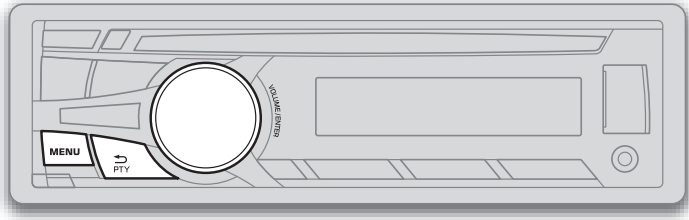

1 Cancel the demonstration

- 1 Press and hold **MENU**.
- 2 Turn the volume knob to select [DEMO], then press the knob.
- 3 Turn the volume knob to select [DEMO OFF], then press the knob.
- 4 Press **MENU** to exit.

2 Set the clock

- 1 Press and hold **MENU**.
- 2 Turn the volume knob to select [CLOCK], then press the knob.
- 3 Turn the volume knob to select [CLOCK SET], then press the knob.
- 4 Turn the volume knob to make the settings, then press the knob.
Day → Hour → Minute
- 5 Turn the volume knob to select [24H/ 12H], then press the knob.
- 6 Turn the volume knob to select [12 HOUR] or [24 HOUR], then press the knob.
- 7 Press **MENU** to exit.

3 Set the basic settings

- 1 Press and hold **MENU**.
- 2 Turn the volume knob to make a selection (see the following table), then press the knob.
- 3 Press **MENU** to exit.

To return to the previous setting item or hierarchy, press **↩** **PTY**.

Default: **XX**

CLOCK

CLOCK ADJ **AUTO**: The clock time is automatically set using the Clock Time (CT) data in FM Radio Broadcast Data System signal. ; **OFF**: Cancels.

CLOCK DISP **ON**: The clock time is shown on the display even when the unit is turned off. ; **OFF**: Cancels.

SETTINGS

BEEP **ON**: Activates the keypress tone. ; **OFF**: Deactivates.

SRC SELECT

AM* **ON**: Enables AM in source selection. ; **OFF**: Disables.

PANDORA* **ON**: Enables PANDORA in source selection. ; **OFF**: Disables.

IHEART* **ON**: Enables IHEARTRADIO in source selection. ; **OFF**: Disables.

AUX* **ON**: Enables AUX in source selection. ; **OFF**: Disables.

F/W UPDATE

SYSTEM / BLUETOOTH

F/W xxxx **YES**: Starts upgrading the firmware. ; **NO**: Cancels (upgrading is not activated).
For details on how to update the firmware, see:
<<http://www.jvc.net/cs/car/>>.

* Not displayed when the corresponding source is selected.

CD / USB / iPod

Start playback

The source changes automatically and playback starts.

CD



USB

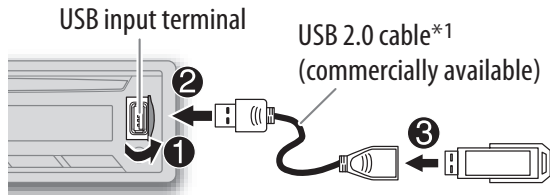

iPod/iPhone

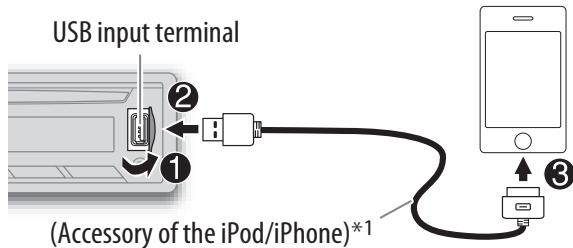

Press **5 iPod MODE** repeatedly to select the control mode ([HEAD MODE] / [IPHONE MODE]).

HEAD MODE: From the unit.

IPHONE MODE: From the iPod/iPhone.*2

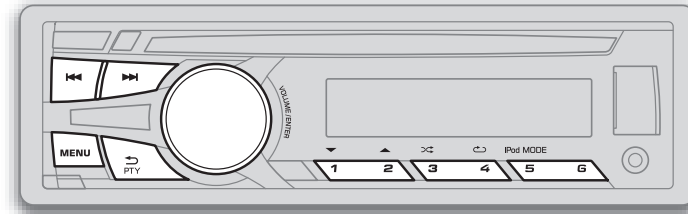

To	Do this
Select a track/file	Press 1 ◀◀/▶▶ (or press ◀/▶ on RM-RK52).
Select a folder *3	Press 1 ▼/2 ▲ (or press ▲/▼ on RM-RK52).
Reverse/ Fast-forward	Press and hold 1 ◀◀/▶▶ (or press and hold ◀/▶ on RM-RK52).
Repeat play *4	Press 4 ↺ repeatedly to make a selection. <ul style="list-style-type: none"> • Audio CD or JVC Playlist Creator (JPC) / JVC Music Control (JMC) file (→ 22): TRACK RPT, RPT OFF • MP3/WMA/WAV file: TRACK RPT, FOLDER RPT, RPT OFF • iPod: ONE RPT, ALL RPT, RPT OFF
Random play *4	Press 3 ↻ repeatedly to make a selection. <ul style="list-style-type: none"> • Audio CD: ALL RND, RND OFF • MP3/WMA/WAV file or JPC / JMC file: FOLDER RND, ALL RND, RND OFF • iPod: SONG RND, ALL RND, RND OFF

*1 Do not leave the cable inside the car when not using.

*2 You can still play/pause, file skip, fast-forward or reverse files from the unit.

*3 Only for MP3/WMA/WAV files. This does not work for iPod.

*4 **For iPod:** Applicable under [HEAD MODE] only.

Select a track/file from a list

For iPod: Applicable only when [HEAD MODE] is selected. (→ 5)

- 1 Press **MENU**.
 - 2 Turn the volume knob to make a selection, then press the knob.
 - MP3/WMA/WAV file: Select the desired folder, then a file.
 - iPod or JPC / JMC file: Select the desired file from the list (PLAYLISTS, ARTISTS, ALBUMS, SONGS, PODCASTS*, GENRES, COMPOSERS*, AUDIOBOOKS*).
- * Only for iPod.

If you have many files....

You can search through them quickly (on step 2 above) by turning the volume knob quickly.

- Not applicable for iPod.

Select a song by name

While listening to the iPod and [HEAD MODE] is selected (→ 5)....

If you have many folders or tracks/files, you can search through them quickly according to the first character (A to Z, 0 to 9 and OTHERS).

- "OTHERS" appear if the first character is other than A to Z, 0 to 9.

- 1 Press **MENU**.
- 2 Turn the volume knob to select the desired list, then press the knob.
- 3 Press **1 ▼ / 2 ▲** or turn the volume knob quickly to select the desired character.
- 4 Turn the volume knob to select the desired folder or track/file, then press the knob.

Change the USB drive

When a smartphone (Mass Storage Class) is connected to the USB input terminal, you can select its internal memory or external memory (such as an SD card) to playback the stored songs.

You can also select the desired drive to playback when a multiple drives device is connected.

Press **5 iPod MODE** repeatedly to select the desired drive.

(or)

- 1 Press and hold **MENU**.
- 2 Turn the volume knob to select [USB/IPOD], then press the knob.
- 3 Turn the volume knob to select [USB], then press the knob.
- 4 Press the volume knob to select [DRIVECHANGE].

The next drive is selected automatically.

Repeat steps 1 to 4 to select the following drives.

Selectable items: [DRIVE 1] to [DRIVE 5]

Change the playback speed of the Audiobook

While listening to the iPod and [HEAD MODE] is selected (→ 5)....

- 1 Press and hold **MENU**.
- 2 Turn the volume knob to select [USB/IPOD], then press the knob.
- 3 Turn the volume knob to select [IPOD], then press the knob.
- 4 Turn the volume knob to make a selection, then press the knob.
 - BOOK NORMAL / BOOK FASTER / BOOK SLOWER: Select the desired playback speed of the Audiobooks sound file in your iPod/iPhone.
 - (Default: Depends on your iPod/iPhone setting.)

- To return to the previous setting item or hierarchy, press **↵ PTY**.
- To cancel, press **MENU**.

RADIO

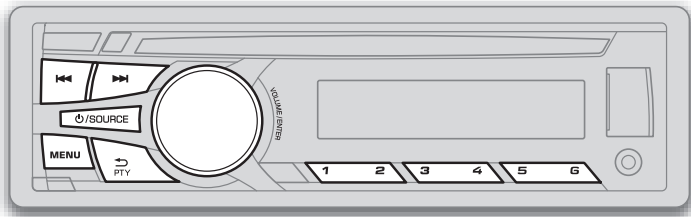

“ST” lights up when receiving an FM stereo broadcast with sufficient signal strength.

Search for a station

- 1 Press **⏻**/**SOURCE** to select FM or AM.
- 2 Press **⏪**/**⏩** (or press **⏪**/**⏩** on RM-RK52) to search for a station automatically.
(or)
Press and hold **⏪**/**⏩** (or press and hold **⏪**/**⏩** on RM-RK52) until “M” flashes, then press repeatedly to search for a station manually.

Store a station

You can store up to 18 stations for FM and 6 stations for AM.

While listening to a station....

Press and hold one of the number buttons (1 to 6) to store.

(or)

- 1 Press and hold the volume knob until “PRESET MODE” flashes.
- 2 Turn the volume knob to select a preset number, then press the knob.
The preset number flashes and “MEMORY” appears.

• **To select a stored station:** Press one of the number buttons (**1** to **6**).

(or)

Press **MENU**, then turn the volume knob to select a preset number and press the knob to confirm.

Search for your favorite program (PTY Search)

Available only for FM source.

- 1 Press and hold **↔** **PTY**.
- 2 Turn the volume knob to select a PTY code, then press the knob to start searching.
If there is a station broadcasting a program of the same PTY code as you have selected, that station is tuned in.

PTY code: **NEWS**, **INFORM** (information), **SPORTS**, **TALK**, **ROCK**, **CLS ROCK** (classic rock), **ADLT HIT** (adult hits), **SOFT RCK** (softrock), **TOP 40**, **COUNTRY**, **OLDIES**, **SOFT**, **NOSTALGA** (nostalgia), **JAZZ**, **CLASSICL** (classical), **R & B** (rhythm and blues), **SOFT R&B** (soft rhythm and blues), **LANGUAGE**, **REL MUSC** (religious music), **REL TALK** (religious talk), **PERSNLTY** (personality), **PUBLIC**, **COLLEGE**, **HABL ESP** (Spanish talk), **MUSC ESP** (Spanish music), **HIP HOP**, **WEATHER**

Other settings

- 1 Press and hold **MENU**.
- 2 Turn the volume knob to select [TUNER], then press the knob.
- 3 Turn the volume knob to make a selection (→ 8), then press the knob.
- 4 Press **MENU** to exit.

To return to the previous setting item or hierarchy, press **↔** **PTY**.

RADIO

Default: **XX**

RADIO TIMER	<p>Turns on the radio at a specific time regardless of the current source.</p> <ol style="list-style-type: none">ONCE/ DAILY/ WEEKLY/ OFF: Select how often the timer will be turned on.FM/ AM: Select the FM or AM band.01 to 18 (for FM)/ 01 to 06 (for AM): Select the preset station.Set the activation day* and time.<ul style="list-style-type: none">"⊖" lights up when complete. <p>* Selectable only when [ONCE] or [WEEKLY] is selected in step 1.</p> <p>Radio Timer will not activate for the following cases.</p> <ul style="list-style-type: none">The unit is turned off.[OFF] is selected for [AM] in [SRC SELECT] after Radio Timer for AM is selected. (→ 4)
SSM	<p>SSM 01 – 06 / SSM 07 – 12 / SSM 13 – 18: Automatically presets up to 18 stations for FM. "SSM" stops flashing when the first 6 stations are stored. Select SSM 07 – 12 / SSM 13 – 18 to store the following 12 stations.</p>
IF BAND	<p>AUTO: Increases the tuner selectivity to reduce interference noises from adjacent FM stations. (Stereo effect may be lost.) ; WIDE: Subjects to interference noises from adjacent FM stations, but sound quality will not be degraded and the stereo effect will remain.</p>
MONO	<p>Displayed only when the source is FM.</p> <p>ON: Improves the FM reception, but the stereo effect will be lost. ; OFF: Cancels.</p>
AREA	<p>AREA US: For North/Central/South America, AM/FM intervals: 10 kHz/200 kHz. ; AREA EU: For any other areas, AM/FM intervals: 9 kHz/50 kHz. ; AREA SA: For some South American countries, AM/FM intervals: 10 kHz/50 kHz.</p>

AUX

Use a portable audio player

1 Connect a portable audio player (commercially available).

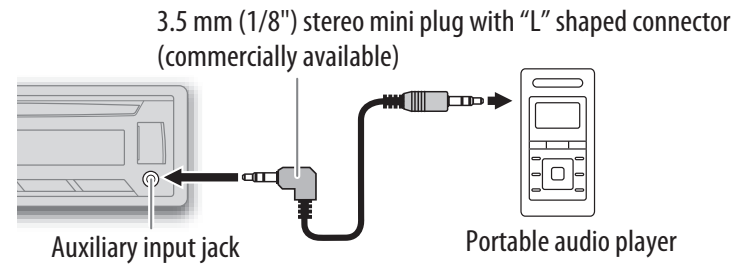

2 Select [ON] for [AUX] in [SRC SELECT]. (→ 4)

3 Press **⏻**/SOURCE to select AUX.

4 Turn on the portable audio player and start playback.

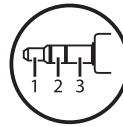

Use a 3-core plug head stereo mini plug for optimum audio output.

Pandora®

Preparation:

Install the latest version of the Pandora application onto your device (iPhone/ iPod touch), then create an account and log in to Pandora.

- Select [ON] for [PANDORA] in [SRC SELECT]. (→ 4)

Start listening

- 1 Open the Pandora application on your device.
- 2 Connect your device to the USB input terminal.

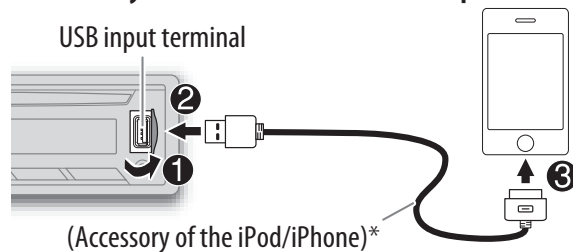

The source changes to PANDORA and broadcast starts.

* Do not leave the cable inside the car when not using.

To	Do this
Pause or resume playback	Press the volume knob (or press ⏸ on RM-RK52).
Thumbs up or thumbs down	Press 2 / 1 (or press / on RM-RK52). <ul style="list-style-type: none">• If thumbs down is selected, the current track is skipped.
Skip a track	Press (or press on RM-RK52).

Create a new station

- 1 Press **MENU**.
- 2 Turn the volume knob to select [NEW STATION], then press the knob.
- 3 Turn the volume knob to select [FROM TRACK] or [FROM ARTIST], then press the knob.

A new station is created based on the current song or artist.

Search for a registered station

- 1 Press **MENU**.
- 2 Turn the volume knob to make a selection, then press the knob.
[BY DATE]: According to the registered date.
[A-Z]: Alphabetical order.
- 3 Turn the volume knob to the desired station, then press the knob.

Bookmark a song or artist information

- 1 Press and hold the volume knob.
- 2 Turn the volume knob to select [THIS TRACK] or [THIS ARTIST], then press the knob.
"BOOKMARKED" appears and the information is stored to your device. The bookmark is available on your Pandora account but not on this unit.

iHeartRadio®

Preparation:

Install the latest version of iHeart Link for JVC application onto your device (iPhone/ iPod touch), then create an account and log in to iHeartRadio.

- Select [ON] for [IHEART] in [SRC SELECT]. (→ 4)

Start listening

- 1 Open the iHeart Link application on your device.
- 2 Connect your device to the USB input terminal.

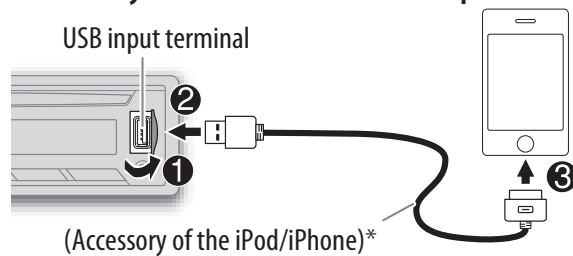

* Do not leave the cable inside the car when not using.

- 3 Press **⏻**/SOURCE to select IHEARTRADIO.
Broadcast starts automatically

To

Do this

Pause or resume playback

Press the volume knob (or press ~~⏻~~ on RM-RK52).

Thumbs up or thumbs down for custom station

Press **2** / **1** (or press **▲**/**▼** on RM-RK52).

- If thumbs down is selected, the current track is skipped.

Skip a track for custom station

Press **▶▶** (or press **▶** on RM-RK52).

Create a new/custom station

Press and hold the volume knob.

Add to favorite stations for live station

Press and hold **3**.

Scan for live station

Press **3**.

Search for a station

- 1 Press **MENU**.
- 2 Turn the volume knob to select a category, then press the knob.
- 3 Turn the volume knob to the desired station, then press the knob.
When a city list appears, you can skip cities in alphabetical order.
- 4 Press **MENU** to exit.

Skip cities by alphabetical order

While a city list appears during search...

- 1 Turn the volume knob quickly to enter character search.
You can search through the list quickly according to the first character (A to Z).
- 2 Turn the volume knob or press **2** / **1** to select the character to be search for.
- 3 Press the volume knob to start searching.

SiriusXM® Radio (for KD-AR959BS / KD-R85MBS)

Preparation:

- 1 Connect the optional SiriusXM Vehicle Tuner (commercially available).

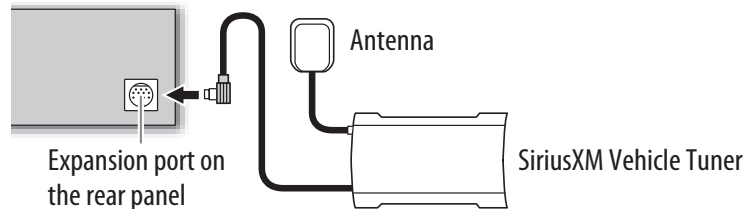

- 2 Activate the subscription through www.siriusxm.com/activatenow or call 1-866-635-2349.

The Radio ID is required to activate the SiriusXM Vehicle Tuner. The Radio ID is located on the label of the SiriusXM Vehicle Tuner and can also be shown on the unit's display window when you select "Channel 0" after SiriusXM Vehicle Tuner is connected. For users in Canada: To activate SiriusXM Canada service go to www.xmradio.ca and click on "ACTIVATE RADIO" in the top right corner, or call 1-877-438-9677.

- 3 Press **⏻**/**SOURCE** to select SIRIUS XM to start updating.

Start listening

- 1 Press **⏻**/**SOURCE** to select SIRIUS XM.
- 2 Press **MENU**.
- 3 Turn the volume knob to select a CATEGORY, then press the knob.
- 4 Turn the volume knob to select a category from the list, then press the knob.

If "ALL CHANNELS" is selected, all the available channels will be shown.

- 5 Turn the volume knob to select a channel, then press the knob. (or)

Press **⏮**/**⏭** to search for a channel manually.

- Pressing and holding **⏮**/**⏭** changes the channel rapidly.

If a locked channel or a mature channel ([MATURE CH] is set to [ON]) is selected, a pass code input screen appears. Enter the pass code to receive the channel.

Store a channel

You can store up to 18 channels.

Press and hold one of the number buttons (1 to 6).

(or)

- 1 Press and hold the volume knob until "PRESET MODE" flashes.
- 2 Turn the volume knob to select a preset number, then press the knob.

The preset number flashes and "MEMORY" appears.

To select a stored channel:

Press one of the number buttons (1 to 6).

(or)

- 1 Press **MENU**.
- 2 Turn the volume knob to select **PRESET**, then press the knob.
- 3 Turn the volume knob to select a preset number, then press the knob.

(or)

Press **▲**/**▼** on RM-RK52.

SiriusXM Replay™

- 1 Press the volume knob.

"⏮" lights up and the unit memorizes this paused position.

- 2 Press the volume knob to start Replay.

Replay starts from the paused position in step 1.

During Replay...

- To pause or resume playback, press the volume knob.
- To skip the current song backward/forward, press **⏮**/**⏭** (or press **⏮**/**⏭** on RM-RK52).
- To rewind/fast-forward, press and hold **⏮**/**⏭** (or press and hold **⏮**/**⏭** on RM-RK52).
- To exit from Replay and go to live, press and hold the volume knob.

Smart Favorites

User preset channels **1** to **6** are initially assigned as the Smart Favorites channels. SiriusXM Vehicle Tuner automatically buffers the broadcast audio content of the Smart Favorites channels in the background.

- Smart Favorite channel is available with SXV200 or later SiriusXM tuner models.
- “* ” appears at the last character of the channel name for the Smart Favorites channels.
- This unit can store a maximum of six Smart Favorites channels. If you try to assign the 7th channel, an error beep tone will be heard.

To cancel the Smart Favorites channels...

- 1 Press MENU.**
- 2 Turn the volume knob to select PRESET, then press the knob.**
- 3 Turn the volume knob to select a preset number, then press and hold the knob.**
“*” are removed from the last character.

To reassign the Smart Favorites channels...

- Repeat steps 1 to 3.**
“*” appears at the last character.

When you select a Smart Favorites channel, you can rewind and replay up to 30 minutes of any of the missed news, talk, sports or music content.

SiriusXM settings

- 1 Press and hold MENU.**
- 2 Turn the volume knob to select [SIRIUS XM], then press the knob.**
- 3 Turn the volume knob to make a selection (see the following table), then press the knob.**
- 4 Press MENU to exit.**

To return to the previous setting item or hierarchy, press **➔ PTY**.

There are two types of lock functions available:

- SiriusXM-defined: When [MATURE CH] is set to [ON]
- User-defined: Using [CHANNEL EDIT] when [MATURE CH] is set to [OFF]

CH LOCK To unlock settings:

- 1** Turn the volume knob to select a number.
- 2** Press |◀◀/▶▶| to move to the entry position.
- 3** Repeat steps **1** and **2** to enter the current pass code. (Initial pass code is 0000.)
- 4** Press the volume knob to confirm.

CODE SET

- 1** Turn the volume knob to select a number.
- 2** Press |◀◀/▶▶| to move to the entry position.
- 3** Repeat steps **1** and **2** to enter a new 4-digit pass code.
- 4** Press the volume knob to confirm.
- 5** Repeat steps **1** to **4** to reconfirm the pass code.

- Make a note of the new pass code to enter channel lock settings from next time.

CH EDIT*

- 1** Turn the volume knob to select a category, then press the knob.
- 2** Turn the volume knob to select a channel you want to lock, then press the knob. “L” appears in front of the channel number.
- 3** Press and hold **➔ PTY** to exit.

CH CLEAR* **YES:** Clears all the locked channels. ; **NO:** Cancels.

MATURE CH **ON:** Turns on the SiriusXM-defined lock setting (mature channel). ; **OFF:** Turns off.
• If [ON] is selected, your setting [CH EDIT] is temporary ignored.

SIGNAL LVL **WEAK/ GOOD/ STRONG:** Shows the strength of the current received signal.

BUF USAGE **0% — 100% (0):** Shows the memory usage for Replay buffer.

SXM RESET **YES:** Resets stored channel, locked channel setting and Mature CH setting to default. ; **NO:** Cancels.

* Displayed only when [MATURE CH] is set to [OFF].

BLUETOOTH®

You can operate Bluetooth devices using this unit.

Connect the microphone

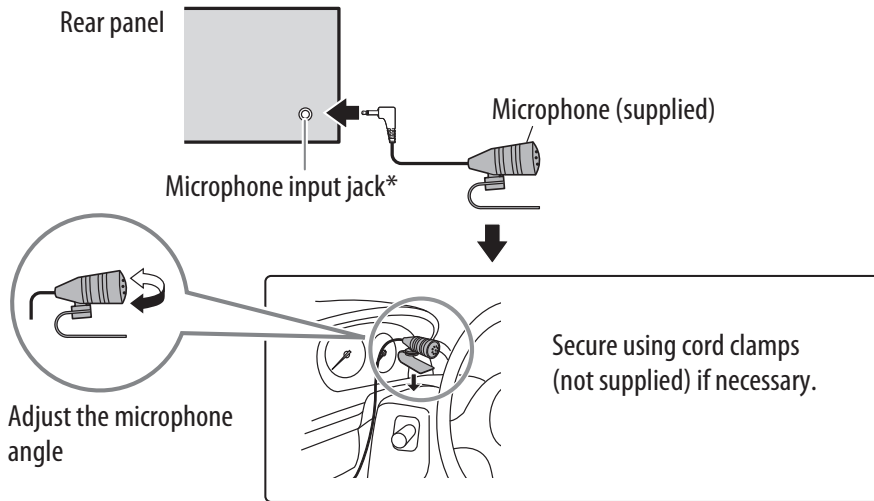

* For KD-AR959BS / KD-R85MBS, connect to the microphone input terminal. (➔ 27)

If you turn off the unit or detach the control panel during a phone call conversation, the Bluetooth connection is disconnected. Continue the conversation using your mobile phone.

Supported Bluetooth profiles

- Hands-Free Profile (HFP1.5)
- Advanced Audio Distribution Profile (A2DP)
- Audio/Video Remote Control Profile (AVRCP1.3)
- Object Push Profile (OPP)
- Phonebook Access Profile (PBAP)
- Serial Port Profile (SPP)

Pair a Bluetooth device

When connecting a Bluetooth device to the unit for the first time, perform pairing between the unit and the device. Once the pairing is completed, the Bluetooth device will remain registered in the unit even if you reset the unit.

- Up to five devices can be registered (paired) in total.
- A maximum of two Bluetooth phones and one Bluetooth audio device can be connected at any time.
- This unit supports Secure Simple Pairing (SSP).
- Some Bluetooth devices may not automatically connect to the unit after pairing. Connect the device to the unit manually. Refer to the instruction manual of the Bluetooth device for more information.

1 Press **⏻**/**SOURCE** to turn on the unit.

2 Search and select **"JVC UNIT"** on the Bluetooth device.

"BT PAIRING" flashes on the display.

- For some Bluetooth devices, you may need to enter the Personal Identification Number (PIN) code immediately after searching.

3 Perform (A) or (B) depending on what scrolls on the display.

- For some Bluetooth devices, pairing sequence may vary from the steps described below.

(A) "[Device Name]" ➔ "XXXXXX" ➔ "VOL – YES" ➔ "BACK – NO"

- "XXXXXX" is a 6-digit passkey randomly generated during each pairing.

1 Ensure that the passkey which appears on the unit and Bluetooth device is the same.

2 Press the volume knob to confirm the passkey.

3 Operate the Bluetooth device to confirm the passkey.

(B) "[Device Name]" ➔ "VOL – YES" ➔ "BACK – NO"

1 Press the volume knob to start pairing.

2 • If "PAIRING" ➔ "PIN 0000" scrolls on the display, enter the PIN code "0000" into the Bluetooth device.

You can change to a desired PIN code before pairing. (➔ 17)

- If only "PAIRING" appears, operate the Bluetooth device to confirm pairing.

BLUETOOTH®

"PAIRING COMPLETED" appears when pairing is completed.

- "📶" or "📱" will light up when a Bluetooth mobile phone is connected.
- "🎵" will light up when a Bluetooth audio player is connected.

Bluetooth compatibility check mode

You can check the connectivity of the supported profile between the Bluetooth device and the unit.

- Make sure there is no Bluetooth device connected.

1 Press and hold 📶 / 📱.

"BLUETOOTH" ↔ "CHECK MODE" appears. "SEARCH NOW USING PHONE" → "PIN IS 0000" scrolls on the display.

2 Search and select "JVC UNIT" on the Bluetooth device within 3 minutes.

3 Perform (A), (B) or (C) depending on what appears on the display.

(A) "PAIRING" → "XXXXXX" (6-digit passkey): Ensure that the same passkey appears on the unit and Bluetooth device, then operate the Bluetooth device to confirm the passkey.

(B) "PAIRING" → "PIN IS 0000": Enter "0000" on the Bluetooth device.

(C) "PAIRING": Operate the Bluetooth device to confirm pairing.

After pairing is successful, "PAIRING OK" → "[Device Name]" appears and Bluetooth compatibility check starts.

If "CONNECT NOW USING PHONE" appears, operate the Bluetooth device to allow phonebook access to continue.

The connectivity result flashes on the display.

"PAIRING OK" and/or "H.FREE OK"*1 and/or "A.STREAM OK"*2 and/or "PBAP OK"*3 : Compatible

*1 Compatible with Hands-Free Profile (HFP)

*2 Compatible with Advanced Audio Distribution Profile (A2DP)

*3 Compatible with Phonebook Access profile (PBAP)

After 30 seconds, "PAIRING DELETED" appears to indicate that pairing has been deleted, and the unit exits check mode.

- To cancel, press and hold ⏻/SOURCE to turn off the power, then turn on the power again.

Bluetooth mobile phone

To	Do this
Receive a call	Press 📶 / 📱 or the volume knob. On RM-RK52: Press ▲/▼/◀/▶. • When [AUTO ANSWER] is set to the selected time, the unit answers incoming call automatically. (→ 15)
Reject an incoming call	Press and hold 📶 / 📱 or the volume knob. On RM-RK52: Press and hold ▲/▼/◀/▶.
End a call	Press and hold 📶 / 📱 or the volume knob. On RM-RK52: Press and hold ▲/▼/◀/▶.
Activate or deactivate hands-free mode	Press the volume knob during a call. • Operations may vary according to the connected Bluetooth mobile phone.
Adjust the phone volume	Turn the volume knob during a call. Phone volume: [00] to [50] (Default: [15]) • This adjustment will not affect the volume of the other sources.
Switch between two connected phones	Press 📶 / 📱 repeatedly. • Not applicable during a call.

Improve the sound quality during a call

While talking on the phone...

1 Press and hold MENU.

2 Turn the volume knob to make a selection (→ 15), then press the knob.



3 Press MENU to exit.

To return to the previous setting item or hierarchy, press ⏪ PTY.

Default: **XX**

MIC LEVEL	-20 — +08 (0) : The sensitivity of the microphone increases as the number increased.
NOISE RDCT	-05 — -20 (-10) : Adjust the noise reduction level until the least noise is being heard during a phone conversation.
ECHO CANCEL	1 — 10 (4) : Adjust the echo cancellation delay time until the least echo is being heard during a phone conversation.

Bluetooth mode operations

- 1 Press  /  to enter Bluetooth mode.
- 2 Turn the volume knob to make a selection (see the following table), then press the knob.
- 3 Press **MENU** to exit.

To return to the previous setting item or hierarchy, press **PTV**.

RECENT CALL	<ol style="list-style-type: none"> 1 Press the volume knob to select a name or a phone number. <ul style="list-style-type: none"> • “>” indicates call received, “<” indicates call made, “M” indicates call missed. • “NO HISTORY” appears if there is no recorded call history or call number. 2 Press the volume knob to call.
PHONEBOOK	<ol style="list-style-type: none"> 1 Turn the volume knob to select a name, then press the knob. 2 Turn the volume knob to select a phone number, then press the knob to call. <ul style="list-style-type: none"> • If the phone supports PBAP, the phonebook of the connected phone is automatically transferred to the unit when pairing. If the phone does not support PBAP, “SEND P.BOOK MANUALLY” appears. Transfer the phonebook manually. (⇒ 17, P.BOOK WAIT) • This unit can display only non-accent letters. (Accent letters such as “Ú” is shown as “U”.) • If the phonebook contains many contacts, (⇒ 16, Select a contact by name).

DIAL NUMBER	<ol style="list-style-type: none"> 1 Turn the volume knob to select a number (0 to 9) or character (*, #, +). 2 Press ◀◀ / ▶▶ to move the entry position. Repeat steps 1 and 2 until you finish entering the phone number. 3 Press the volume knob to call.
--------------------	---

VOICE	Speak the name of the contact you want to call or the voice command to control the phone functions. (⇒ 16, Use Voice Recognition)
--------------	---

SETTINGS Default: **XX**

AUTO ANSWER	01 SEC — 30 SEC : The unit answer incoming call automatically in the selected time (seconds). ; OFF : Cancels.
--------------------	--

RING TONE	<p>IN UNIT: The unit rings to notify you when a call/text message comes in. (Default ring tone is different according to the paired device.)</p> <ul style="list-style-type: none"> • CALL: Selects your preferred ring tone (TONE 1 — 5) for incoming calls. • MESSAGE: Selects your preferred ring tone (TONE 1 — 5) for incoming text messages. <p>IN PHONE: The unit uses the connected phones’ ring tone to notify you when a call/text message comes in. (The connected phone will ring if it does not support this feature.)</p>
------------------	---

RING COLOR (for KD-AR959BS / KD-R950BT)	COLOR 01 — COLOR 29 (COLOR 06) : Display zone will change to the selected color during a call or when a text message comes in. ; OFF : Cancels.
---	---

MSG NOTICE*	ON : The unit rings and “RCV MESSAGE” appears to notify you of an incoming text message. ; OFF : Cancels.
--------------------	---

* Functionality depends on the type of the phone used.





BLUETOOTH®

Text message notification



When the phone receives a text message, the unit rings and “RCV MESSAGE” appears.

- You cannot read, edit, or send a message through the unit.
- To clear the message, press any button.

Use Voice Recognition

- 1 Press and hold  / .**
The connected phone (which has been paired the earliest) is activated. However, if priority device is connected, pressing and holding  /  activate the priority device. (➔ 17, PRIORITY)
- 2 Speak the name of the contact you want to call or the voice command to control the phone functions.**
 - Supported Voice Recognition features vary for each phone. Refer to the instruction manual of the connected phone for details.
 - This unit also supports the intelligent personal assistant function of iPhone.



Select a contact by name

- You can search through the contacts quickly according to the first letter (A to Z, 0 to 9, and OTHERS).
 - “OTHERS” appears if the first character is other than A to Z, 0 to 9.
- 1 Press  /  to enter Bluetooth mode.**
 - 2 Turn the volume knob to select [PHONEBOOK], then press the knob.**
 - 3 Press 1 ▼/2 ▲ to select the desired letter.**
 - 4 Turn the volume knob to select a name, then press the knob.**
 - 5 Turn the volume knob to select a phone number, then press the knob to call.**

To return to the previous setting item or hierarchy, press  **PTY**.

Store a contact in memory

You can store up to 6 contacts.

- 1 Press  /  to enter Bluetooth mode.**
- 2 Turn the volume knob to select [RECENT CALL], [PHONEBOOK], or [DIAL NUMBER], then press the knob.**
- 3 Turn the volume knob to select a contact or enter a phone number.**
If a contact is selected, press the volume knob to show the phone number.
- 4 Press and hold one of the number buttons (1 to 6).**
“MEMORY P(selected preset number)” appears when the contact is stored.



To erase a contact from the preset memory, select [DIAL NUMBER] in step **2** and store a blank number.

Make a call from memory

- 1 Press  /  to enter Bluetooth mode.**
- 2 Press one of the number buttons (1 to 6).**
- 3 Press the volume knob to call.**
“NO PRESET” appears if there is no contacts stored.

Delete a contact

Not applicable for mobile phone that supports PBAP.

- 1 Press  /  to enter Bluetooth mode.**
- 2 Turn the volume knob to select [RECENT CALL] or [PHONEBOOK], then press the knob.**
- 3 Turn the volume knob to select a contact or a phone number.**
- 4 Press and hold  **PTY**.**
- 5 Turn the volume knob to select [DELETE] or [DELETE ALL], then press the knob.**
DELETE: Selected name or phone number in step **3** is deleted.
DELETE ALL: All names or phone numbers from the selected menu in step **2** is deleted.
- 6 Turn the volume knob to select [YES] or [NO], then press the knob.**

Bluetooth mode settings

- 1** Press and hold **MENU**.
- 2** Turn the volume knob to select [BLUETOOTH], then press the knob.
- 3** Turn the volume knob to make a selection (see the following table), then press the knob.
- 4** Press **MENU** to exit.

To return to the previous setting item or hierarchy, press **↵** **PTY**.

Default: **XX**

PHONE	Selects the phone or audio device to connect or disconnect.
AUDIO	
APPLICATION	Shows the connected phone name using the JVC Smart Music Control*1 app. “*” appears in front of the device name.
DELETE PAIR	<ol style="list-style-type: none"> 1 Turn the volume knob to select a device to delete, then press the knob. 2 Turn the volume knob to select [YES] or [NO], then press the knob.
PRIORITY	<p>Selects a device to be connected as priority device. “*” appears in front of the device name set as priority.</p> <ul style="list-style-type: none"> • “NO PAIR” appears if there is no registered device found.
P.BOOK WAIT*2	Copies up to 400 numbers from the phonebook memory of a connected phone.
SET PINCODE (0000)	<p>Changes the PIN code (up to 6 digits).</p> <ol style="list-style-type: none"> 1 Turn the volume knob to select a number. 2 Press ◀◀ / ▶▶ to move the entry position. Repeat steps 1 and 2 until you finish entering the PIN code. 3 Press the volume knob to confirm.

AUTO CNNCT	ON : The unit automatically reconnect when the Bluetooth device is within range. ; OFF : Cancels.
INITIALIZE	YES : Updates all the Bluetooth settings (including stored pairing, phonebook, and etc.). ; NO : Cancels.
INFORMATION	<p>MY BT NAME: Displays the unit name (JVC UNIT). ;</p> <p>MY ADDRESS: Shows address of this unit.</p>

*1 JVC Smart Music Control is designed to view JVC car receiver status and perform simple control operations on Android smart phones. For JVC Smart Music Control operations, visit JVC website: <<http://www.jvc.net/cs/car/>>.

*2 Selectable only when the connected phone supports OPP.

Internet radio via Bluetooth

Listen to Pandora

Preparation:

Select [ON] for [PANDORA] in [SRC SELECT]. (➔ 4)

You can listen to Pandora on your smart phone (Android OS) through Bluetooth on this unit.

- 1 Open the Pandora application on your device.
 - 2 Connect to Bluetooth audio player. (➔ 13)
 - 3 Press **⏻**/SOURCE to select PANDORA.
The source switches and broadcast starts automatically.
- You can operate Pandora in the same way as Pandora for iPod/iPhone. (➔ 9)

Listen to iHeartRadio

Preparation:

Select [ON] for [IHEART] in [SRC SELECT]. (➔ 4)

You can listen to iHeartRadio on your smart phone (Android OS) through Bluetooth on this unit.

- 1 Open the iHeart Link application on your smart phone.
 - 2 Connect your smart phone via Bluetooth connection. (➔ 13)
 - 3 Press **⏻**/SOURCE to select IHEARTRADIO.
The source switches and broadcast starts automatically.
- You can operate iHeartRadio in the same way as iHeartRadio for iPod/iPhone. (➔ 10)

Bluetooth audio player

Operations and display indications may differ according to their availability on the connected device.

To	Do this
Playback	1 Press ⏻ /SOURCE to select BT AUDIO. 2 Operate the Bluetooth audio player to start playback.
Pause or resume playback	Press MENU (or press ⏻ on RM-RK52).
Select group or folder	Press 1 ▼/2 ▲ (or press ▲/▼ on RM-RK52).
Reverse/forward skip	Press ⏮ /▶ (or press ◀/▶ on RM-RK52).
Reverse/fast-forward	Press and hold ⏮ /▶ (or press and hold ◀/▶ on RM-RK52).
Repeat play	Press 4 ↺ repeatedly to make a selection. TRACK RPT, ALL RPT, RPT OFF
Random play	Press 3 ↻ repeatedly to make a selection. GROUP RND, ALL RND, RND OFF

AUDIO SETTINGS

- 1 Press and hold **MENU**.
- 2 Turn the volume knob to make a selection, then press the knob.
Repeat step 2 until the desired item is selected.
- 3 Press **MENU** to exit.

To return to the previous setting item or hierarchy, press **↩ PTY**.

Default: **XX**

EQ SETTING																												
EQ PRESET	FLAT / HARD ROCK / JAZZ / POP / R&B / TALK / USER1 / USER2 / VOCAL BOOST / BASS BOOST / CLASSICAL / DANCE: Selects a preset equalizer.																											
EASY EQ Default: 00	<ol style="list-style-type: none"> 1 USER1 / USER2: Select a preset name. 2 Adjust your own sound settings. (For KD-R85MBS / KD-AR855BT / KD-R850BT) SUB.W*1: -08 to +08 / BASS LVL: -06 to +06 / MID LVL: -06 to +06 / TRE LVL: -06 to +06 (For KD-AR959BS / KD-R950BT) SUB.W*1: -08 to +08 / BASS LVL: -10 to +10 / MID LVL: -10 to +10 / TRE LVL: -10 to +10 																											
PRO EQ (for KD-R85MBS / KD-AR855BT / KD-R850BT)	<ol style="list-style-type: none"> 1 USER1 / USER2: Select a preset name. 2 BASS / MIDDLE / TREBLE: Select a sound tone. 3 Adjust the sound elements of the selected sound tone. <table border="0"> <tr> <td>BASS</td> <td>Frequency: 60 / 80 / 100 / 200 Hz</td> <td>Default: (80 Hz)</td> </tr> <tr> <td></td> <td>Level: -06 to +06</td> <td>(00)</td> </tr> <tr> <td></td> <td>Q: Q1.0 / Q1.25 / Q1.5 / Q2.0</td> <td>(Q1.0)</td> </tr> <tr> <td>MIDDLE</td> <td>Frequency: 0.5 / 1.0 / 1.5 / 2.5 kHz</td> <td>Default: (1.0 kHz)</td> </tr> <tr> <td></td> <td>Level: -06 to +06</td> <td>(00)</td> </tr> <tr> <td></td> <td>Q: Q0.75 / Q1.0 / Q1.25</td> <td>(Q1.25)</td> </tr> <tr> <td>TREBLE</td> <td>Frequency: 10.0 / 12.5 / 15.0 / 17.5 kHz</td> <td>Default: (10.0 kHz)</td> </tr> <tr> <td></td> <td>Level: -06 to +06</td> <td>(00)</td> </tr> <tr> <td></td> <td>Q: Q FIX</td> <td>(Q FIX)</td> </tr> </table> 	BASS	Frequency: 60 / 80 / 100 / 200 Hz	Default: (80 Hz)		Level: -06 to +06	(00)		Q: Q1.0 / Q1.25 / Q1.5 / Q2.0	(Q1.0)	MIDDLE	Frequency: 0.5 / 1.0 / 1.5 / 2.5 kHz	Default: (1.0 kHz)		Level: -06 to +06	(00)		Q: Q0.75 / Q1.0 / Q1.25	(Q1.25)	TREBLE	Frequency: 10.0 / 12.5 / 15.0 / 17.5 kHz	Default: (10.0 kHz)		Level: -06 to +06	(00)		Q: Q FIX	(Q FIX)
BASS	Frequency: 60 / 80 / 100 / 200 Hz	Default: (80 Hz)																										
	Level: -06 to +06	(00)																										
	Q: Q1.0 / Q1.25 / Q1.5 / Q2.0	(Q1.0)																										
MIDDLE	Frequency: 0.5 / 1.0 / 1.5 / 2.5 kHz	Default: (1.0 kHz)																										
	Level: -06 to +06	(00)																										
	Q: Q0.75 / Q1.0 / Q1.25	(Q1.25)																										
TREBLE	Frequency: 10.0 / 12.5 / 15.0 / 17.5 kHz	Default: (10.0 kHz)																										
	Level: -06 to +06	(00)																										
	Q: Q FIX	(Q FIX)																										

PRO EQ (for KD-AR959BS / KD-R950BT)	<ol style="list-style-type: none"> 1 USER1 / USER2: Select a preset name. 2 BASS / MID BASS / MID / MID HIGH / HIGH: Select a sound tone. 3 Adjust the sound elements of the selected sound tone. <table border="0"> <tr> <td>BASS</td> <td>Frequency: 63 / 80 / 100 / 125 Hz</td> <td>Default: (80 Hz)</td> </tr> <tr> <td></td> <td>Level: -10 to +10</td> <td>(00)</td> </tr> <tr> <td></td> <td>Q: Q1.0 / Q1.25 / Q1.5 / Q2.0</td> <td>(Q1.25)</td> </tr> <tr> <td>MID BASS</td> <td>Frequency: 200 / 250 / 315 / 400 Hz</td> <td>Default: (250 Hz)</td> </tr> <tr> <td></td> <td>Level: -10 to +10</td> <td>(00)</td> </tr> <tr> <td></td> <td>Q: Q1.0 / Q1.25 / Q1.5 / Q2.0</td> <td>(Q1.25)</td> </tr> <tr> <td>MID</td> <td>Frequency: 630 / 800 Hz / 1.0 / 1.25 kHz</td> <td>Default: (800 Hz)</td> </tr> <tr> <td></td> <td>Level: -10 to +10</td> <td>(00)</td> </tr> <tr> <td></td> <td>Q: Q0.75 / Q1.0 / Q1.25 / Q2.0</td> <td>(Q1.0)</td> </tr> <tr> <td>MID HIGH</td> <td>Frequency: 2.0 / 2.5 / 3.15 / 4.0 kHz</td> <td>Default: (2.5 kHz)</td> </tr> <tr> <td></td> <td>Level: -10 to +10</td> <td>(00)</td> </tr> <tr> <td></td> <td>Q: Q0.75 / Q1.0 / Q1.25 / Q2.0</td> <td>(Q1.0)</td> </tr> <tr> <td>HIGH</td> <td>Frequency: 6.3 / 8.0 / 10.0 / 12.5 kHz</td> <td>Default: (8.0 kHz)</td> </tr> <tr> <td></td> <td>Level: -10 to +10</td> <td>(00)</td> </tr> <tr> <td></td> <td>Q: Q0.75 / Q1.0 / Q1.25 / Q2.0</td> <td>(Q1.0)</td> </tr> </table> 	BASS	Frequency: 63 / 80 / 100 / 125 Hz	Default: (80 Hz)		Level: -10 to +10	(00)		Q: Q1.0 / Q1.25 / Q1.5 / Q2.0	(Q1.25)	MID BASS	Frequency: 200 / 250 / 315 / 400 Hz	Default: (250 Hz)		Level: -10 to +10	(00)		Q: Q1.0 / Q1.25 / Q1.5 / Q2.0	(Q1.25)	MID	Frequency: 630 / 800 Hz / 1.0 / 1.25 kHz	Default: (800 Hz)		Level: -10 to +10	(00)		Q: Q0.75 / Q1.0 / Q1.25 / Q2.0	(Q1.0)	MID HIGH	Frequency: 2.0 / 2.5 / 3.15 / 4.0 kHz	Default: (2.5 kHz)		Level: -10 to +10	(00)		Q: Q0.75 / Q1.0 / Q1.25 / Q2.0	(Q1.0)	HIGH	Frequency: 6.3 / 8.0 / 10.0 / 12.5 kHz	Default: (8.0 kHz)		Level: -10 to +10	(00)		Q: Q0.75 / Q1.0 / Q1.25 / Q2.0	(Q1.0)
BASS	Frequency: 63 / 80 / 100 / 125 Hz	Default: (80 Hz)																																												
	Level: -10 to +10	(00)																																												
	Q: Q1.0 / Q1.25 / Q1.5 / Q2.0	(Q1.25)																																												
MID BASS	Frequency: 200 / 250 / 315 / 400 Hz	Default: (250 Hz)																																												
	Level: -10 to +10	(00)																																												
	Q: Q1.0 / Q1.25 / Q1.5 / Q2.0	(Q1.25)																																												
MID	Frequency: 630 / 800 Hz / 1.0 / 1.25 kHz	Default: (800 Hz)																																												
	Level: -10 to +10	(00)																																												
	Q: Q0.75 / Q1.0 / Q1.25 / Q2.0	(Q1.0)																																												
MID HIGH	Frequency: 2.0 / 2.5 / 3.15 / 4.0 kHz	Default: (2.5 kHz)																																												
	Level: -10 to +10	(00)																																												
	Q: Q0.75 / Q1.0 / Q1.25 / Q2.0	(Q1.0)																																												
HIGH	Frequency: 6.3 / 8.0 / 10.0 / 12.5 kHz	Default: (8.0 kHz)																																												
	Level: -10 to +10	(00)																																												
	Q: Q0.75 / Q1.0 / Q1.25 / Q2.0	(Q1.0)																																												

AUDIO

BASS BOOST	+01 / +02: Selects your preferred bass boost level. ; OFF: Cancels.
LOUD	01 / 02: Boosts low or high frequencies to produce a well-balanced sound at low volume. ; OFF: Cancels.
SUB.W LEVEL *1	-08 — +08 (00): Adjusts the subwoofer output level.
SUB.W*2	ON / OFF: Turns on or off the subwoofer output.
SUB.W LPF*1	THROUGH: All signals are sent to the subwoofer. ; LOW 55Hz / MID 85Hz / HIGH 120Hz: Audio signals with frequencies lower than 55 Hz / 85 Hz / 120 Hz are sent to the subwoofer.

*1 Displayed only when [L/O MODE] is set to [SUB.W] and [SUB.W] is set to [ON].

*2 Displayed only when [L/O MODE] is set to [SUB.W].

AUDIO SETTINGS

HPF* ³	OFF: All signals are sent to the front/rear speakers. ; LOW 100Hz / MID 120Hz / HIGH 150Hz: Audio signals with frequencies lower than 100 Hz/ 120 Hz/ 150 Hz are cut off from the front/rear speakers.
FADER* ⁴ ⁵	R06 — F06 (00): Adjusts the front and rear speaker output balance.
BALANCE* ⁴	L06 — R06 (00): Adjusts the left and right speaker output balance.
VOL ADJUST	−05 — +05 (00): Presets the volume adjustment level of each source (compared to the FM volume level). Before adjustment, select the source you want to adjust. (“VOL ADJ FIX” appears if FM is selected.)
AMP GAIN	LOW POWER: Limits the maximum volume level to 30. (Select if the maximum power of each speaker is less than 50 W to prevent damaging the speakers.) ; HIGH POWER: The maximum volume level is 50.
D.T.EXP (Digital Track Expander)	ON: Creates realistic sound by compensating the high-frequency components and restoring the rise-time of the waveform that are lost in audio data compression. ; OFF: Cancels.
L/O MODE* ⁶	SUB.W / REAR: Selects whether rear speakers or a subwoofer are connected to the REAR/SW line out terminals on the rear panel (through an external amplifier).

*³ For **KD-AR959BS / KD-R950BT / KD-R85MBS / KD-AR855BT**.

*⁴ This adjustment will not affect the subwoofer output.

*⁵ If you are using a two-speaker system, set the fader level to [00].

*⁶ For **KD-R950BT / KD-R850BT**.

DISPLAY SETTINGS

KD-AR959BS / KD-R950BT

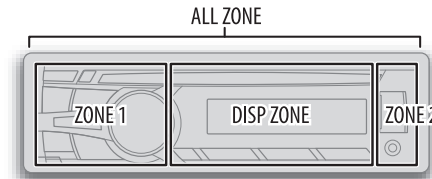

KD-R85MBS / KD-AR855BT / KD-R850BT

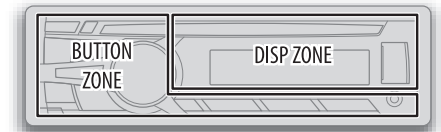

- 1 Press and hold **MENU**.
- 2 Turn the volume knob to make a selection (see the following table), then press the knob.
Repeat step 2 until the desired item is selected.
- 3 Press **MENU** to exit.

To return to the previous setting item or hierarchy, press **PTV**.

Default: **XX**

DISPLAY

DIMMER	Selects the display and button illumination adjusted in the [BRIGHTNESS] setting. AUTO: Changes between the day and night adjustments when you turn off or on the car headlights.* ¹ ; ON: Selects the night adjustments. ; OFF: Selects the day adjustments.
BRIGHTNESS	Sets the button, display and USB input terminal brightness for day and night separately. 1 DAY / NIGHT: Select day or night. 2 Select a zone for setting. (⇒ Illustration above) 3 Set the brightness level (00 to 31). (Default: DAY: 31 ; NIGHT: 15)
SCROLL* ²	ONCE: Scrolls the display information once. ; AUTO: Repeats scrolling at 5-second intervals. ; OFF: Cancels.

*¹ The illumination control wire connection is required. (⇒ 27, 28)

*² Some characters or symbols will not be shown correctly (or will be blanked).

DISPLAY SETTINGS

Default: **XX**

COLOR (for KD-AR959BS / KD-R950BT)	
PRESET	<p>You can select a color for [ALL ZONE], [ZONE 1], [DISP ZONE], or [ZONE 2] separately. For [ALL ZONE], you can also select a color pattern. Default color:</p> <p>ALL ZONE: [COLOR 06], ZONE 1: [COLOR 06], DISP ZONE: [COLOR 01], ZONE 2: [COLOR 27]</p> <ol style="list-style-type: none"> 1 Select a zone for setting. (➔ 20) 2 Select a color for the selected zone. <ul style="list-style-type: none"> • COLOR 01 to COLOR 29 • USER: The color you have created for [DAY COLOR] or [NIGHT COLOR] is shown. • COLOR FLOW 01 to COLOR FLOW 03: Color changes at different speeds. • SPECTRUM/ GROOVE/ TECHNO/ EMOTION/ RELAX/ NIGHT SWEEP: The selected color pattern is shown.* (Selectable only when [ALL ZONE] is selected in step 1.) <p>* If one of these color pattern is selected, the [ZONE 1], [DISP ZONE], [ZONE 2] illumination color will change to the default color.</p>
DAY COLOR	<p>Store your own day and night colors for different zone.</p> <ol style="list-style-type: none"> 1 Select a zone for setting. (➔ 20) 2 RED / GREEN / BLUE: Select a primary color. 3 00 to 31: Select the level.
NIGHT COLOR	<p>Repeat steps 2 and 3 for all the primary colors.</p> <ul style="list-style-type: none"> • Your setting is stored to [USER] in [PRESET]. • If [00] is selected for all primary colors for [DISP ZONE], nothing appears on the display.
COLOR GUIDE	<p>ON: Changes the button, display and USB input terminal illumination when settings are performed on menu and list search. Display zone will automatically change depending on volume level. ; OFF: Cancels.</p>

[NIGHT COLOR] or [DAY COLOR] is changed by turning on or off your car's headlight.

MORE INFORMATION

About discs and audio files

- This unit can only play the following CDs:



- This unit can play back multi-session discs; however, unclosed sessions will be skipped during playback.
- **Unplayable discs:**
 - Discs that are not round.
 - Discs with coloring on the recording surface or discs that are dirty.
 - Recordable/ReWritable discs that have not been finalized.
 - 8 cm CD. Attempting to insert using an adapter may cause malfunction.
- **DualDisc playback:** The Non-DVD side of a "DualDisc" does not comply with the "Compact Disc Digital Audio" standard. Therefore, the use of Non-DVD side of a DualDisc on this product cannot be recommended.
- **Playable files:**
 - File extensions: MP3 (.mp3), WMA (.wma)
 - Bit rate: MP3: 8 kbps — 320 kbps
WMA: 32 kbps — 192 kbps
 - Sampling frequency: MP3: 48 kHz, 44.1 kHz, 32 kHz, 24 kHz, 22.05 kHz, 16 kHz, 12 kHz, 11.025 kHz, 8 kHz
WMA: 8 kHz — 48 kHz
 - Variable bit rate (VBR) files.
- **Maximum number of characters for file/folder name:** It depends on the disc format used (includes 4 extension characters—<.mp3> or <.wma>).
 - ISO 9660 Level 1 and 2: 32 characters
 - Romeo: 32 characters
 - Joliet: 32 characters
 - Windows long file name: 32 characters

MORE INFORMATION

About USB devices

- This unit can play MP3/WMA/WAV files stored on a USB mass storage class device.
- You cannot connect a USB device via a USB hub.
- Connecting a cable whose total length is longer than 5 m may result in abnormal playback.
- The maximum number of characters for:
 - Folder names: 64 characters
 - File names: 64 characters
 - MP3 Tag: 64 characters
 - WMA Tag: 64 characters
 - WAV Tag: 64 characters
- This unit can recognize a total of 20 480 files, 999 folders (999 files per folder including folder without unsupported files), and of 8 hierarchies.
- This unit cannot recognize a USB device whose rating is other than 5 V and exceeds 1 A.

About iPod/iPhone

- Made for
 - iPod touch (1st, 2nd, 3rd, 4th, and 5th generation)
 - iPod classic
 - iPod nano (3rd, 4th, 5th, 6th and 7th generation)
 - iPhone, iPhone 3G, 3GS, 4, 4S, 5
- It is not possible to browse video files on the “Videos” menu in **[HEAD MODE]**.
- The song order displayed on the selection menu of this unit may differ from that of the iPod/iPhone.
- If some operations are not performed correctly or as intended, visit:
<<http://www.jvc.net/cs/car/>>.

About Pandora

- Pandora is available only in the U.S., Australia and New Zealand.
- Because Pandora is a third-party service, the specifications are subject to change without prior notice. Accordingly, compatibility may be impaired, or some or all of the services may become unavailable.
- Some functions of Pandora cannot be operated from this unit.
- For issues using the application, please contact Pandora at pandora-support@pandora.com.

About iHeartRadio

- iHeartRadio® is a third-party service, therefore the specifications are subject to change without prior notice. Accordingly, compatibility may be impaired or some or all of the services may become unavailable.
- Some iHeartRadio® functionality cannot be operated from this unit.

About JVC Playlist Creator and JVC Music Control

- This unit supports the PC application JVC Playlist Creator and Android™ application JVC Music Control.
- When you play audio file with song data added using the JVC Playlist Creator or JVC Music Control, you can search for audio file by Genres, Artists, Albums, Playlists, and Songs.
- JVC Playlist Creator and JVC Music Control are available from the following web site:
<<http://www.jvc.net/cs/car/>>.

About Bluetooth

- Depending on the Bluetooth version of the device, some Bluetooth devices may not be able to connect to this unit.
- This unit may not work with some Bluetooth devices.
- Signal conditions vary, depending on the surroundings.
- For more information about Bluetooth, visit the following JVC website:
<<http://www.jvc.net/cs/car/>>.

MORE INFORMATION

Change the display information

Press **DISP** repeatedly.

FM or AM	Station name (PS)*1 → Frequency → Program type (PTY)*1*2 → Title*1*2 → Day/Clock → (back to the beginning) *1 For FM Radio Broadcast Data System stations only. *2 If unavailable, "NO PTY" / "NO TEXT" appears.
CD or USB	Playing time → Day/Clock → Disc name*3 → Album title/Artist*4 → Track title*5 → Folder/file name*6 → (back to the beginning) *3 Only for CD-DA: If not recorded, "NO NAME" appears. *4 Only for MP3/WMA/WAV files: If not recorded, "NO NAME" appears. *5 If not recorded, "NO NAME" appears. *6 Only for MP3/WMA/WAV files.
USB-IPOD	Playing time → Day/Clock → Album title/Artist*7 → Track title*7 → (back to the beginning) *7 If not recorded, "NO NAME" appears.
PANDORA	Station name → Album title/Artist → Track title → Playing time → Day/Clock → (back to the beginning)
IHEART	Station name → Track title*8 → Track Artist*8 → Day/Clock → (back to the beginning) *8 If unavailable, station name appears.
SiriusXM	Channel no./Channel name → Artist → Song title → Content information → Category name → Day/Clock → (back to the beginning)
AUX	AUX ↔ Day/Clock
BT AUDIO	Playing time → Day/Clock → Album title/Artist*9 → Track title*9 → (back to the beginning) *9 If not recorded, "NO NAME" appears.

TROUBLESHOOTING

Symptom	Remedy
Sound cannot be heard.	<ul style="list-style-type: none"> Adjust the volume to the optimum level. Check the cords and connections.
"MISWIRING CHK WIRING THEN RESET UNIT" / "WARNING CHK WIRING THEN RESET UNIT" appears and no operations can be done.	Check to be sure the terminals of the speaker wires are insulated properly, then reset the unit. If this does not solve the problem, consult your nearest service center.
Source cannot be selected.	Check the [SRC SELECT] setting. (→ 4)
Radio reception is poor. / Static noise while listening to the radio.	<ul style="list-style-type: none"> Connect the antenna firmly. Pull the antenna out all the way.
Correct characters are not displayed.	This unit can only display uppercase letters, numbers, and a limited number of symbols.
"PLEASE" and "EJECT" appear alternately.	Press ▲, then insert the disc correctly.
"IN DISC" appears.	Make sure nothing is blocking the loading slot when you eject the disc.
Disc cannot be ejected.	Press and hold ▲ to forcibly eject the disc. Be careful not to drop the disc when it is ejected.
Playback order is not as intended.	The playback order is determined by the file name (USB) or the order in which files were recorded (disc).
Elapsed playing time is not correct.	This depends on the recording process earlier.
"NOT SUPPORT" appears and track skips.	Check whether the track is a playable format. (→ 21)

TROUBLESHOOTING

Symptom	Remedy	
"CANNOT PLAY" flashes and/or connected device cannot be detected.	<ul style="list-style-type: none"> Check whether the connected device is compatible with this unit and ensure the files are in supported formats. (➔ 21) Reattach the device. 	
"READING" keeps flashing.	<ul style="list-style-type: none"> Do not use too many hierarchical levels and folders. Reload the disc or reattach the USB device. 	
The iPod/iPhone does not turn on or does not work.	<ul style="list-style-type: none"> Check the connection between this unit and iPod/iPhone. Detach and reset the iPod/iPhone using hard reset. 	
Pandora	"ADD ERROR" "SEARCH ERR"	New station creation is unsuccessful.
	"CHK DEVICE"	Check the Pandora application on your device.
	"NO SKIPS"	The skip limit has been reached.
	"NO STATIONS"	No stations are found.
	"STATION LIM"	The number of registered stations has reached its limit. Retry after deleting unnecessary stations from your device.
	"UPGRADE APP"	Make sure you have installed the latest version of the Pandora application on your device.
	"CONNECT ERR"	Communication is unstable.
	"RATING ERR"	Registration of thumbs up/thumbs down has failed.
	"LICENSE ERR"	You try to access from a country which Pandora is not deliverable.
iHeartRadio	Station cannot be selected.	If "Explicit Content" in [Account Settings] is checked in the web version of iHeartRADIO, custom stations become unavailable.
	"CREATE ERR"	Custom station name creation is unsuccessful.
	"SAVE ERROR"	Addition to the favorite category failed.
	"DISCONNECTED"	Check the connection to the device.

Symptom	Remedy	
"NO SKIPS"	The skip limit has been reached. Retry later.	
"NO STATIONS"	No stations are found.	
"NOT CONNCTD"	Link to the application is impossible.	
"UPDATE APP"	Make sure you have installed the latest version of the iHeart Link for JVC application on your device.	
iHeartRadio	"PLS LOGIN"	You haven't log in. Log in again.
	"STATION NOT AVAILABLE"	Broadcast from the station is over.
	"STATION NOT SELECTED"	No station is selected.
	"STREAM ERR"	Broadcast data is interrupted.
	"THUMBS ERR"	Registration of Thumbs Up/Down has failed.
"TIMED OUT"	The request has resulted in time-out.	
SiriusXM® Radio	"CH LOCKED"	The selected channel is locked. Enter the correct pass code to unlock. (➔ 12)
	"CHAN UNSUB"	The selected channel is unsubscribed. Call 1-866-635-2349 or 1-877-438-9677 to subscribe.
	"CH UNAVAIL"	The selected channel is unavailable.
	"CHK ANTENNA"	Check the antenna and its connection are in good condition.
	"CHECK TUNER"	Make sure the SiriusXM Vehicle Tuner is connected to the unit.
	"NO SIGNAL"	Make sure the antenna is mounted outside the vehicle.
	"SUBSCRIPTN UPDATED – ENTER TO CONTINUE"	Your subscription is updated. Press the volume knob to continue.
	"WRONG CODE"	Make sure you have entered the correct pass code. (➔ 12)

Symptom	Remedy
No Bluetooth device is detected.	<ul style="list-style-type: none"> • Search from the Bluetooth device again. • Reset the unit. (➔ 3)
Pairing cannot be made.	<ul style="list-style-type: none"> • Make sure you have entered the same PIN code to both the unit and Bluetooth device. • Delete pairing information from both the unit and the Bluetooth device, then perform pairing again. (➔ 13)
“PAIRING FULL” appears.	The number of registered devices has reached its limit. Retry after deleting an unnecessary device. (➔ 17, DELETE PAIR)
“PLEASE WAIT” appears.	The unit is preparing to use the Bluetooth function. If the message does not disappear, turn off and turn on the unit, then connect the device again.
“BT DEVICE NOT FOUND” appears.	The unit failed to search for the registered Bluetooth devices during [AUTO CNNCT]. Turn on Bluetooth from your device and connect manually. (➔ 17)
Echo or noise occurs.	<ul style="list-style-type: none"> • Adjust the microphone unit’s position. (➔ 13) • Check the [ECHO CANCEL] setting. (➔ 15)
Phone sound quality is poor.	<ul style="list-style-type: none"> • Reduce the distance between the unit and the Bluetooth device. • Move the car to a place where you can get a better signal reception.
“NOT SUPPORT” appears.	The connected phone does not support Voice Recognition feature.
“ERROR” appears.	Try the operation again. If “ERROR” appears again, check if the device supports the function you have tried.

Bluetooth®

Symptom	Remedy
The unit does not respond when you try to copy the phonebook to the unit.	You may have tried to copy the same entries (as stored) to the unit. Press DISP or ↩ PTY to exit.
Sound is being interrupted or skipped during playback of a Bluetooth audio player.	<ul style="list-style-type: none"> • Reduce the distance between the unit and the Bluetooth audio player. • Turn off, then turn on the unit and try to connect again. • Other Bluetooth devices might be trying to connect to the unit.
The connected Bluetooth audio player cannot be controlled.	<ul style="list-style-type: none"> • Check whether the connected Bluetooth audio player supports Audio/Video Remote Control Profile (AVRCP). (Refer to the instructions of your audio player.) • Disconnect and connect the Bluetooth player again.
“H/W ERROR” appears.	Reset the unit and try the operation again. If “H/W ERROR” appears again, consult your nearest service center.
“BT ERROR PLS UPDATE” appears.	Update the Bluetooth firmware. (➔ 4)

Bluetooth®

If you have any troubles, try the following:

- 1 Check TROUBLESHOOTING**
- 2 Reset the unit (➔ 3)**
- 3 Contact (USA only)**
Call: 1-800-252-5722 (or) visit: <http://www.jvc.com>

⚠ Warning

- The unit can only be used with a 12 V DC power supply, negative ground.
- Disconnect the battery's negative terminal before wiring and mounting.
- Do not connect Battery wire (yellow) and Ignition wire (red) to the car chassis or Ground wire (black) to prevent a short circuit.
- Insulate unconnected wires with vinyl tape to prevent a short circuit.
- Be sure to ground this unit to the car's chassis again after installation.

⚠ Caution

- For safety's sake, leave wiring and mounting to professionals. Consult the car audio dealer.
- Install this unit in the console of your vehicle. Do not touch the metal parts of this unit during and shortly after use of the unit. Metal parts such as the heat sink and enclosure become hot.
- Do not connect the \ominus wires of speakers to the car chassis or Ground wire (black), or connect them in parallel.
- Connect speakers with a maximum power of more than 50 W. If the maximum power of the speakers is lower than 50 W, change the [AMP GAIN] setting to avoid damaging the speakers. (→ 20)
- Mount the unit at an angle of less than 30°.
- If your vehicle wiring harness does not have the ignition terminal, connect Ignition wire (red) to the terminal on the vehicle's fuse box which provides 12 V DC power supply and is turned on and off by the ignition key.
- After the unit is installed, check whether the brake lamps, blinkers, wipers, etc. on the car are working properly.
- If the fuse blows, first make sure the wires are not touching car's chassis, then replace the old fuse with one that has the same rating.

Basic procedure

- 1 Remove the key from the ignition switch, then disconnect the \ominus terminal of the car battery.**
- 2 Connect the wires properly.**
See Wiring connection. (→ 27, 28)
- 3 Install the unit to your car.**
See Installing the unit (in-dash mounting).
- 4 Connect the \ominus terminal of the car battery.**
- 5 Reset the unit. (→ 3)**

Installing the unit (in-dash mounting)

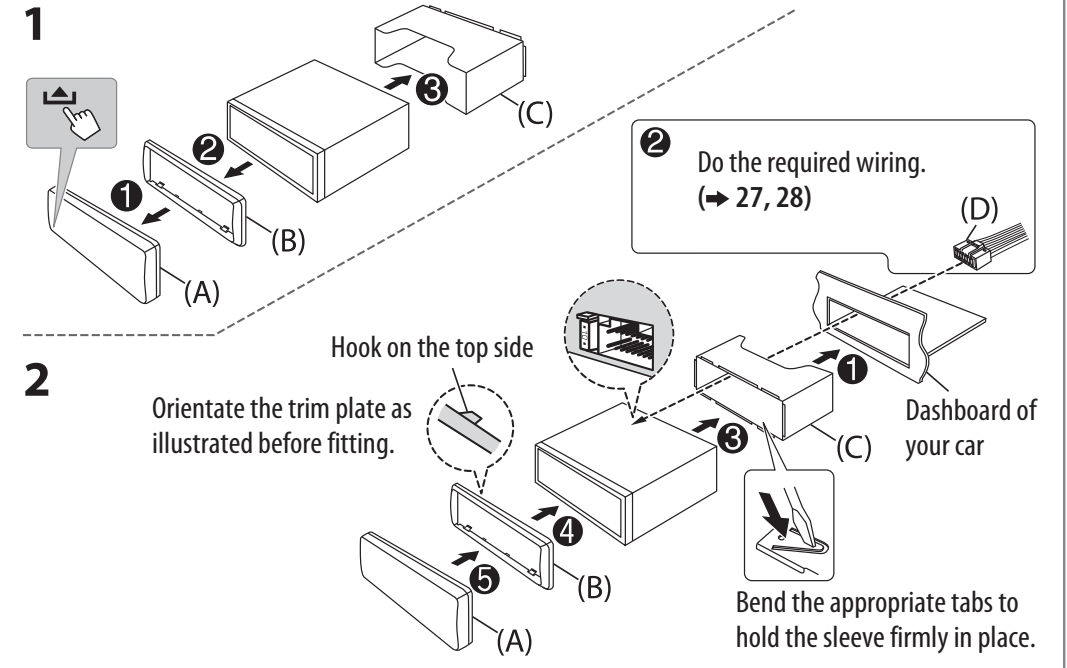

When installing without the mounting sleeve

- ⚠ Use only the specified screws. Using wrong screws might damage the unit.

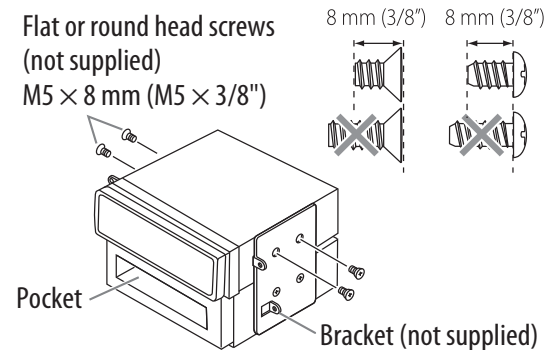

How to remove the unit

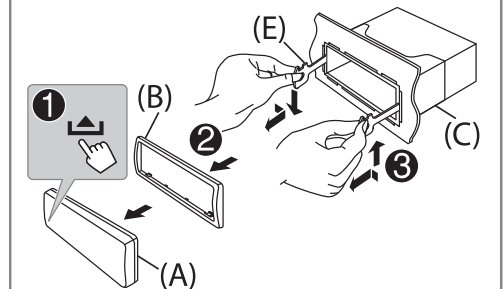

Wiring connection

(for KD-AR959BS / KD-R85MBS)

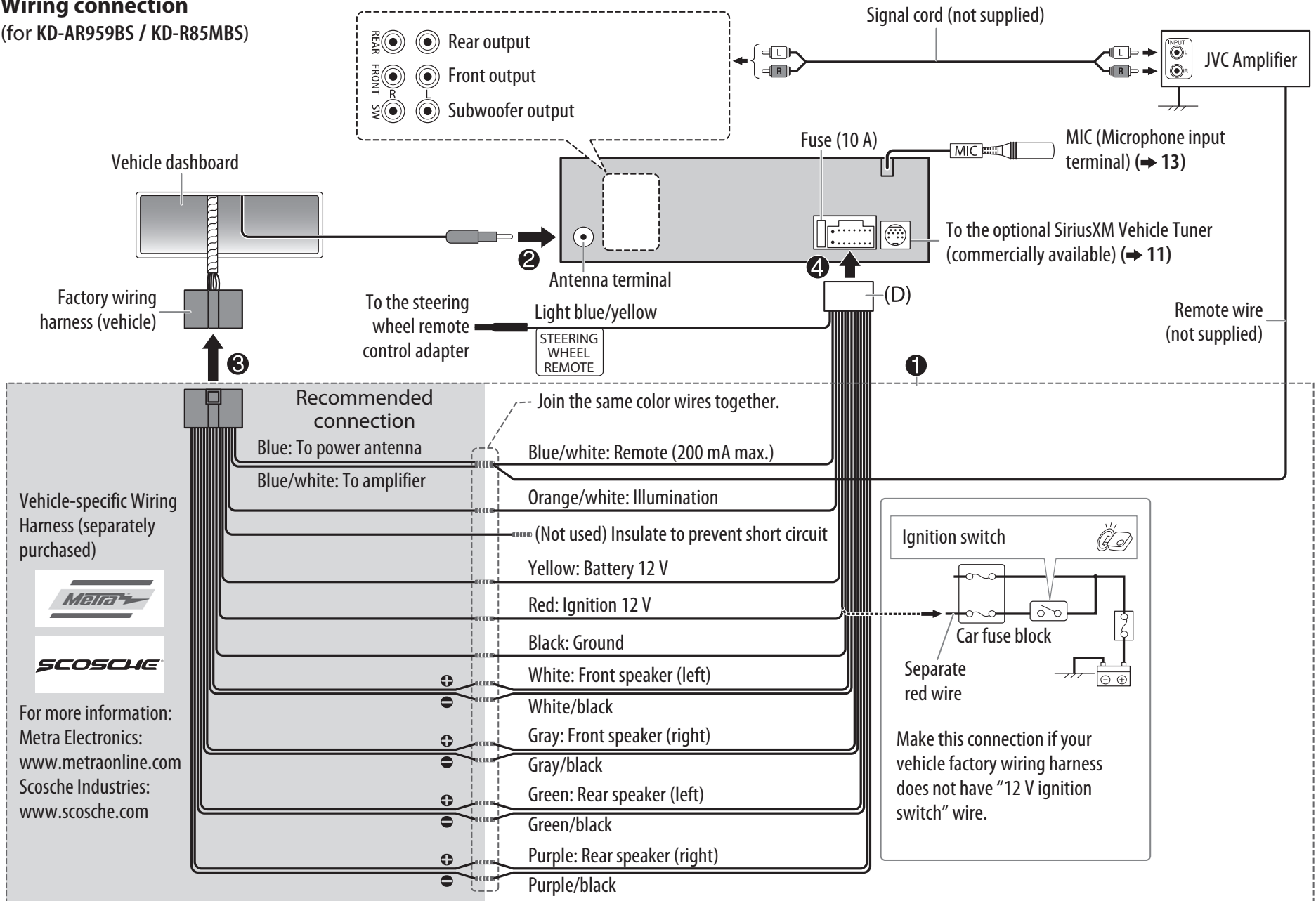

For more information:
 Metra Electronics:
www.metraonline.com
 Scosche Industries:
www.scosche.com

Wiring connection (for KD-R950BT / KD-AR855BT / KD-R850BT)

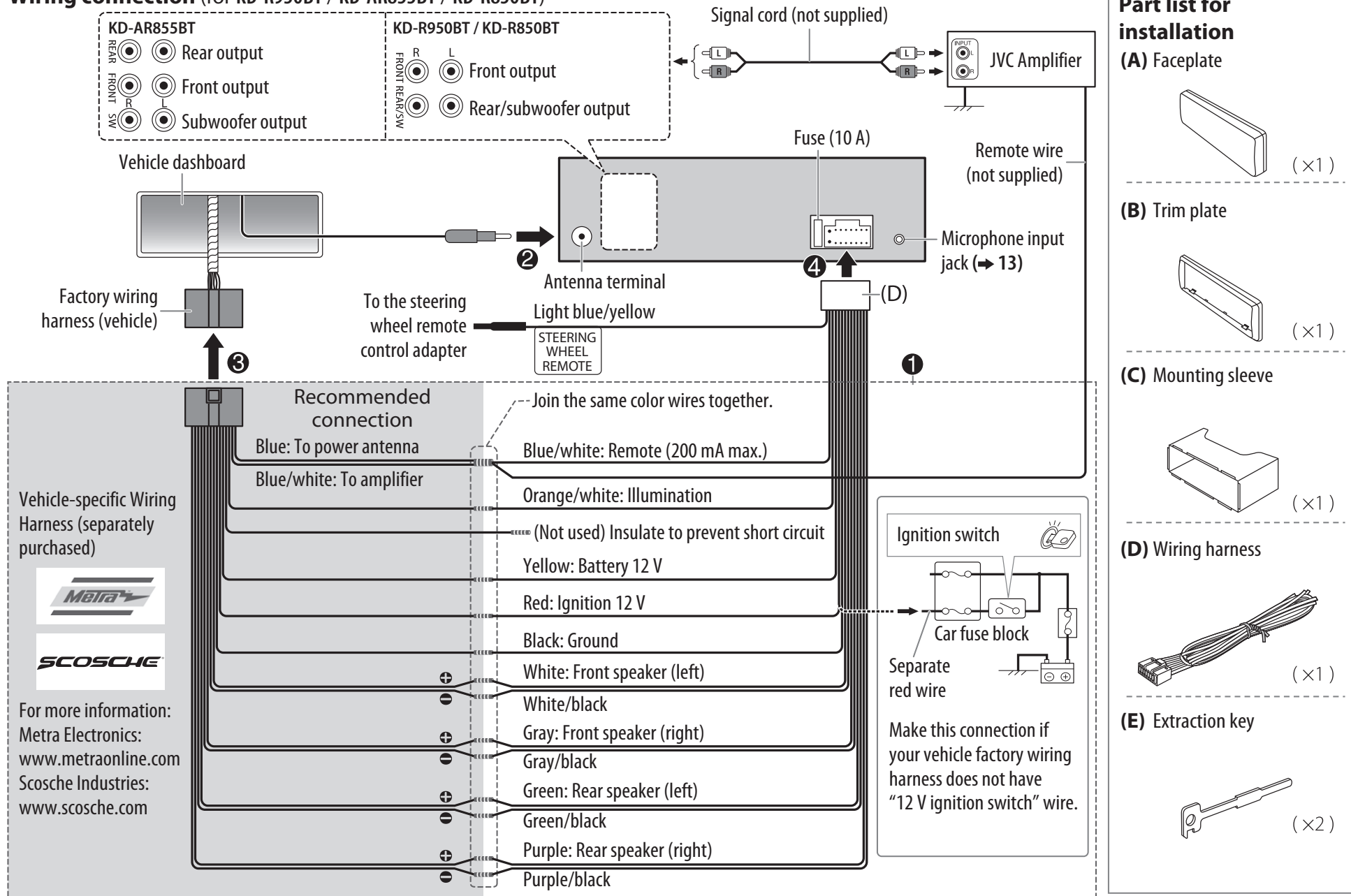

SPECIFICATIONS

TUNER	FM	Frequency Range	87.9 MHz to 107.9 MHz (200 kHz step) 87.5 MHz to 108.0 MHz (50 kHz step)
		Channel Space Selection	50 kHz/200 kHz
	Usable Sensitivity (S/N = 26 dB)	8.2 dBf (0.71 μ V/75 Ω)	
	Quieting Sensitivity (DIN S/N = 46 dB)	17.2 dBf (2.0 μ V/75 Ω)	
	Frequency Response (\pm 3 dB)	30 Hz to 15 kHz	
	Signal-to-Noise Ratio (MONO)	64 dB	
	Stereo Separation (1 kHz)	40 dB	
AM	Frequency Range	530 kHz to 1 700 kHz (10 kHz step) 531 kHz to 1 611 kHz (9 kHz step)	
		Channel Space Selection	9 kHz/10 kHz
	Usable Sensitivity (S/N = 20 dB)	29 dB μ (28.2 μ V)	
CD player	Laser Diode	GaAIs	
	Digital Filter (D/A)	8 times over sampling	
	Spindle Speed	500 rpm — 200 rpm (CLV)	
	Wow & Flutter	Below measurable limit	
	Frequency Response (\pm 1 dB)	20 Hz — 20 kHz	
	Total Harmonic Distortion (1 kHz)	0.01 %	
	Signal-to-Noise Ratio (1 kHz)	105 dB	
	Dynamic Range	90 dB	
	Channel Separation	85 dB	
MP3 Decode	Compliant with MPEG-1/2 Audio Layer-3		
WMA Decode	Compliant with Windows Media Audio		
USB	USB Standard	USB 1.1, USB 2.0 (Full speed)	
	Compatible Devices	Mass storage class	
	File System	FAT12/ 16/ 32	
	Maximum Supply Current	DC 5 V \leq 1 A	
	MP3 Decode	Compliant with MPEG-1/2 Audio Layer-3	
	WMA Decode	Compliant with Windows Media Audio	
	WAV Decode	Linear-PCM	

Auxiliary	Frequency Response (\pm 3 dB)	20 Hz — 20 kHz
	Input Maximum Voltage	KD-AR959BS / KD-R950BT: 1 000 mV KD-R85MBS / KD-AR855BT / KD-R850BT: 1 200 mV
	Input Impedance	30 k Ω
Bluetooth	Version	Bluetooth Ver.2.1+EDR
	Frequency Range	2.402 GHz — 2.480 GHz
	Output Power	+4 dBm (MAX), 0 dBm (AVE) Power Class 2
	Maximum Communication Range	Line of sight approx. 10 m
Profile	HFP1.5 (Hands-Free Profile), A2DP (Advanced Audio Distribution Profile), AVRCP1.3 (Audio/Video Remote Control Profile), OPP (Object Push Profile), PBAP (Phonebook Access Profile), SPP (Serial Port Profile)	
Audio	Maximum Output Power	50 W \times 4
	Full Bandwidth Power (at less than 1 % THD)	22 W \times 4
	Speaker Impedance	4 Ω — 8 Ω
	Preout Level/Load (CD)	KD-AR959BS / KD-R85MBS / KD-AR855BT: 4 800 mV/10 k Ω load KD-R950BT / KD-R850BT: 2 500 mV/10 k Ω load
	Preout Impedance	\leq 600 Ω
	Operating Voltage (10.5 V — 16 V allowable)	14.4 V
General	Maximum Current Consumption	10 A
	Operating Temperature Range	0°C to +40°C
	Installation Size (W \times H \times D)	182 mm \times 53 mm \times 158 mm (7-3/16" \times 2-1/8" \times 6-1/4")
	Weight	1.2 kg (2.65 lbs)

Subject to change without notice.



- Microsoft and Windows Media are either registered trademarks or trademarks of Microsoft Corporation in the United States and/or other countries.
- "Made for iPod," and "Made for iPhone" mean that an electronic accessory has been designed to connect specifically to iPod, or iPhone, respectively, and has been certified by the developer to meet Apple performance standards. Apple is not responsible for the operation of this device or its compliance with safety and regulatory standards. Please note that the use of this accessory with iPod or iPhone may affect wireless performance.
- iPhone, iPod, iPod classic, iPod nano, and iPod touch are trademarks of Apple Inc., registered in the U.S. and other countries.
- Lightning is a trademark of Apple Inc.
- Pandora, the Pandora logo, and the Pandora trade dress are trademarks or registered trademarks of Pandora Media, Inc., used with permission.
- iHeartRadio® is a registered mark of Clear Channel Broadcasting, Inc. in the United States and other countries. Such marks are used under license.
- Sirius, XM and all related marks and logos are trademarks of Sirius XM Radio Inc. All rights reserved.
- Android is trademark of Google Inc.
- The Bluetooth® word mark and logos are registered trademarks owned by Bluetooth SIG, Inc. and any use of such marks by JVC KENWOOD Corporation is under license. Other trademarks and trade names are those of their respective owners.

**WHEN IT IS NOT REQUIRED
TO DETACH THE FRONT CONTROL
PANEL FROM THE MAIN UNIT,
USE THE PROVIDED SCREW TO
ATTACH THE CONTROL PANEL TO
THE MAIN UNIT.**

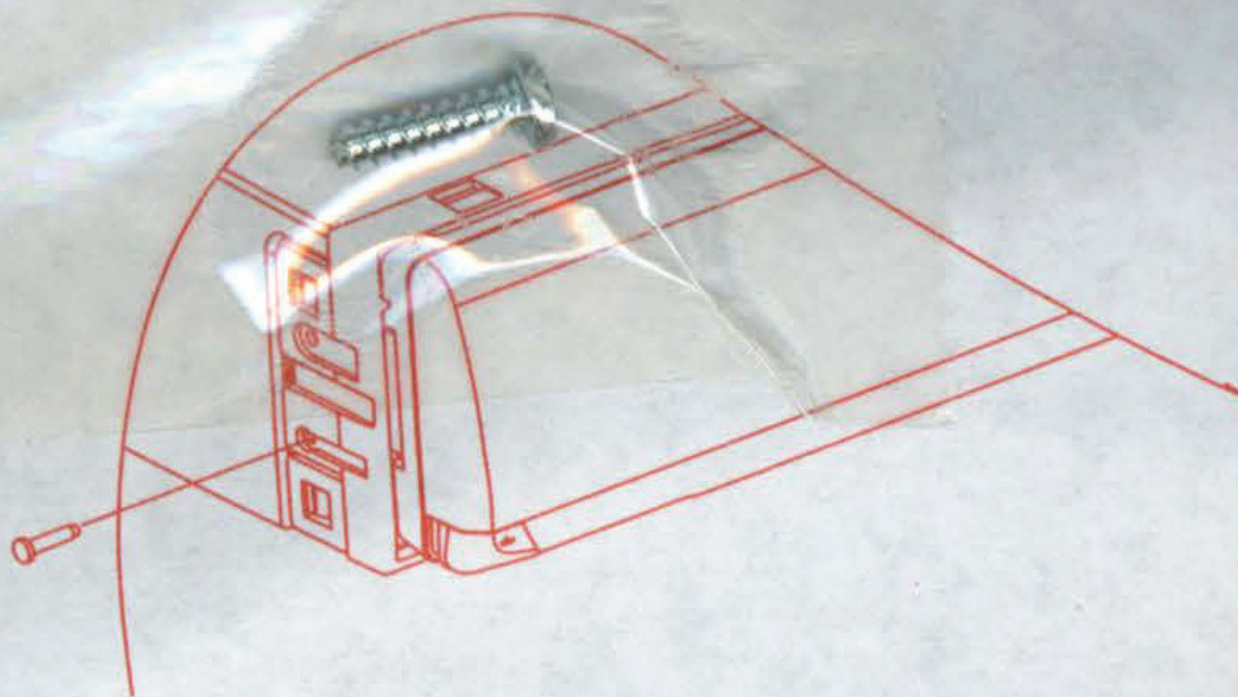

GE40401-001A



WARRANTY

Warranty applies only to PRODUCT distributed in Canada by JVC Canada Inc.

JVC CANADA INC. (hereafter called "JVC") gives the following express warranty for each new JVC product distributed in Canada by JVC and sold by an authorized JVC dealer. JVC warrants that this JVC product is free, under normal use and maintenance, from any defects in material and workmanship subject to the following terms and conditions:

1. To Obtain Warranty Service:

- JVC product requiring service must be presented together with proof of purchase.
- The JVC product must be brought in for service to an authorized JVC Service Centre.

2. Limitation:

This Warranty shall not apply to:

- Repair or replacement of any cabinets, batteries, plates, connection cords, antennas, dust covers, knobs, speaker grills, speaker cones, projection screens, projection screen savers, and all accessories.
- Any defects caused or repairs required as a result of misuse, abusive operation, negligence, improper use and/or insufficient care.
- Any defect caused or repairs required as a result of not following the instructions in the operation manual.
- Any JVC product tampered with, adjusted or repaired by any party other than JVC or authorized JVC Service Centre personnel.
- Any JVC products on which the serial number has been defaced, modified or removed.
- Maintenance, cleaning or periodic check-up
- Conversion to foreign or domestic voltage or frequency.
- Any JVC product without the Canadian Electrical Safety Regulations ID.
- Any JVC products used for commercial or institutional, rental, or display purposes.
Parts 1 year (except video head - 90 days)
Labour ... 90 days
- Any JVC product which has been resold and no longer owned by the original purchaser.
- Product purchased from "outside Canada", "bankruptcy" or "liquidator".
- Any defects caused by fire, flood, lightning, power surge, or other events beyond the control of JVC.
- FOR AUTO PRODUCTS
Warranty does not cover elimination of car static or electrical interferences, cleaning of head, adjustments, or labour cost for the removal or reinstallation of the unit for repair.

3. Standards:

If any defects should be found in a JVC product within the applicable terms, necessary repairs shall be made at no cost to the purchaser for parts or labour when JVC acknowledges that such defects are due to faulty material or workmanship.

4. Exclusion of All Other Express Warranties:

This warranty constitutes the entire express warranty given by JVC for JVC products and no dealer or service centre personnel or his, its or their agent or employee is, or are authorized to extend or enlarge this warranty on behalf of JVC.

5. Disclaimer of Consequential Damage:

To the extent the law permits JVC disclaims any responsibility for loss of time or use of its product, transportation costs, or any other indirect, incidental or consequential damage or inconvenience.

WARRANTY TERM (VALID FROM THE DATE OF PURCHASE)

Product	Parts (Years)	Labour (Years)
Projection TV In-Home Service Colour TV In-Home (25" and above) D-ILA Rear Projection In-Home Service LCD TV In-Home Service (25" and above)	1	1
* In-Home service to be provided where available. Where it is not available, the purchaser must assume the responsibility and expense for the proper packing, shipment and all costs associated with the delivery of the equipment to and from the closest JVC Authorized Service Centre.		
Receivers and Home Speakers purchased separately. Front Projection and Car Audio "ARSENAL" Series	2	2
AC Adapters, Remote controls, Headphones, Microphones and Projector lamps	90 days	90 days
Wood Cone Speakers	5	5
All Other Categories	1	1

JVC CANADA INC.

6070 kestrel Road, Mississauga, Ontario, L5T 1 S8 Canada
TEL: (905) 670-3381 FAX: (905)670-7244 Service toll free #: 1-800-964-2650
<http://www.jvc.ca> E-mail: service@jvc.ca

Product Registration

We suggest that you register your product since it will enable us to contact you directly if it is ever necessary to correct a safety related condition in your product. You can register at <http://www.jvc.ca/www/Support/Warranty.aspx>

For customer use:

Enter below the Model No. and Serial No. which is located either on the rear, bottom or side of the cabinet. Retain this information for future reference.

Model No.: _____

Serial No.: _____

Purchase date: _____

Name of dealer: _____

GARANTIE

La garants' applique seulement aux PRODUITS distribués au Canada par JVC Canada Inc.

JVC CANADA INC. (ci-après appelé "JVC") énonce la garantie expresse suivante pour tout nouveau produit JVC distribué au Canada par JVC et vendu par un détaillant JVC autorisé. JVC vous garantit que ce produit est dégage, sous utilisation et entretien normal, de tout défaut matériel et de fabrication sous réserve des modalités et conditions suivantes:

1. Pour obtenir un service de garantie:

- Les produits JVC nécessitant un service doit être présentée avec la preuve d'achat.
- Le produit JVC doit être apporté pour service chez un centre de service JVC autorisé.

2. Restrictions:

Cette garantie ne s'applique pas aux:

- Réparation ou remplacement de tout cabinet, batteries, panneau avant, cordons de raccord, antennes, housses de protection, boutons, couverts de hautparleur, cônes de hautparleur, écrans de projection, protecteurs d'écran de projection et tous les accessoires.
- Tous défauts occasionnés ou réparations requises suite à une utilisation abusive, mauvaise, négligente et/ou une utilisation incorrecte.
- Tous défauts occasionnés ou réparations requises suite à l'omission de suivre les recommandations du manuel d'instruction.
- Tout produit JVC altéré, ajusté ou réparé par tout autre entreprise que JVC ou un centre de service d'entretien ou de service autorisé JVC.
- Tout produit JVC dont le numéro de série a été altéré, modifié ou enlevé.
- L'entretien, les vérifications périodiques et nettoyage.
- La conversion à une fréquence ou une tension étrangère ou domestique.
- Tout produit JVC n'ayant pas le signe d'identification qui conforme aux norms électriques Canadiennes (CSA).
- Pour tout produit utilisé à des fins commerciales, institutionnelles, de location ou utilisé à des fins d'étalage.
Pièces 1 An (Excepté les têtes vidéo- 90 jours)
Main d'oeuvre ... 90 Jours
- Tout produit JVC ayant été revendu et qui n'est plus la propriété de l'acheteur original.
- Produit acheté à "l'extérieur du Canada", provenant d'une "faillite" ou d'un "liquidateur".
- Tout dommage causé par le feu, une inondation, un éclair, une surtension ou tout autre évènement hors du contrôle de JVC.

(m) POUR LES PRODUITS D'AUTOMOBILE

La garantie ne couvre pas l'élimination d'interférences statiques ou électriques de la voiture, le nettoyage de tête, les ajustements et les coûts de main d'œuvre associés à l'enlèvement ou à la réinstallation de l'unité pour réparation.

3. Critères:

Si un produit JVC s'avérait défectueux, selon les conditions applicables, les réparations nécessaires seront effectués sans coûts additionnels à l'acheteur pour les pièces et la main d'œuvre lorsque JVC reconnaît que de tels défauts sont causés par une défectuosité de matériel ou de fabrication.

4. Exclusion de toutes autres garanties expresses :

Cette garantie constitue l'entière garantie expresse donnée par JVC pour les produits JVC. Nul représentant ou employé d'un détaillant ou d'un service d'entretien n'est autorisé à prolonger cette garantie au nom de JVC.

5. Dénégation des dommages indirects:

Dans la mesure permise par la loi, JVC nie toute responsabilité pour perte de temps ou d'usage de ses produits, des coûts de transport ou tout autre dommage ou inconfort indirect, accidentel et conséquent.

CONDITIONS DE GARANTIE (VALABLE À PARTIR DE LA DATE D'ACHAT)

Produit	Pieces (Années)	Main-D'oeuvre (Années)
Écrans de projection Service à Domicile Écrans de TV Couleur Service à Domicile (25" et plus) TV projection arrière D-ILA Service à Domicile Écrans de LCD Service à Domicile (25" et plus)	1	1
* Service à domicile fourni par un détaillant disponible. S'il n'y a pas de service JVC disponible à proximité, l'acheteur doit assumer la responsabilité et les coûts pour un emballage adéquat, l'expédition, ainsi que tous les coûts associés à la livraison de l'équipement chez et depuis le détaillant JVC autorisé le plus près pour un service d'entretien.		
Récepteurs et Hauts-Parleurs achetés séparément, Projecteur Avant et Audio d'Auto de Série "ARSENAL"	2	2
Adaptateurs AC, Télécommande, Casque D'écoute, Microphones et Lampe de Projecteur	90 Jours	90 Jours
Enceinte à Cône en Bois	5	5
Toutes les autres catégories	1	1

JVC CANADA INC.

6070 kestrel Road, Mississauga, Ontario, L5T 1 S8 Canada
TEL: (905) 670-3381 FAX: (905)670-7244 Service toll free #: 1-800-964-2650
<http://www.jvc.ca> E-mail: service@jvc.ca

Enregistrement du produit

Nous vous conseillons d'enregistrer votre produit, car il nous permettra de vous contacter directement si jamais elle est nécessaire pour corriger un problème lié à la sécurité de votre produit. Vous pouvez vous inscrire à <http://www.jvc.ca/www/Support/Warranty.aspx>

Pour l'utilisation des clients:

Entrez ci-dessous le numéro de modèle et le numéro de série qui se trouve soit à l'arrière, en bas ou sur le côté de l'armoire. Conservez ces informations pour référence future.

No. de modèle: _____

No. de série: _____

Date d'achat: _____

Nom du revendeur: _____

TO OUR VALUED CUSTOMER

THANK YOU FOR PURCHASING THIS JVC PRODUCT.
WE WANT TO HELP YOU ACHIEVE A PERFECT EXPERIENCE.

**NEED HELP ON HOW TO HOOK UP?
NEED ASSISTANCE ON HOW TO OPERATE?
NEED TO LOCATE A JVC SERVICE CENTER?
LIKE TO PURCHASE ACCESSORIES?**

JVC IS HERE TO HELP!
TOLL FREE: 1 (800)252-5722
<http://www.jvc.com>

Remember to retain your Bill of Sale for Warranty Service.

Do not attempt to service the product yourself

Caution

To prevent electrical shock, do not open the cabinet.
There are no user serviceable parts inside.
Please refer to qualified service personnel for repairs.

PRODUCT REGISTRATION

We suggest that you register your product since it will enable us to contact you directly if it is ever necessary to correct a safety related condition in your product. You can register at www.register.jvc.com
Please note that failure to register does not diminish any of your rights during the warranty period.

JVC

LIMITED WARRANTY

ONLY FOR PRODUCT PURCHASED IN U.S.A.

JVC Americas Corp. (JVC) warrants this product and all parts thereof, except as set forth below **ONLY TO THE ORIGINAL RETAIL PURCHASER** to be **FREE FROM DEFECTIVE MATERIALS AND WORKMANSHIP** from the date of original purchase for the period shown below. ("The Warranty Period")

PARTS 2 YRS / LABOR 2 YRS : Car audio ARSENAL series

PARTS 1 YR / LABOR 1 YR : All other car audio products

THIS LIMITED WARRANTY IS VALID ONLY IN THE FIFTY (50) UNITED STATES, THE DISTRICT OF COLUMBIA AND IN THE COMMONWEALTH OF PUERTO RICO.

WHAT WE WILL DO:

If this product is found to be defective within the warranty period, JVC will repair or replace defective parts with new or rebuilt equivalents at no charge to the original owner. Such repair and replacement services shall be rendered by JVC during normal business hours at JVC authorized service centers. Parts used for replacement are warranted only for the remainder of the Warranty Period. All products may be brought to a JVC authorized service center on a carry-in basis. Color televisions with a screen size of 37" class or greater qualify for in-home service. In such cases, a technician will come to your home and either repair the TV there or remove and return it if it cannot be repaired in your home.

WHAT YOU MUST DO FOR WARRANTY SERVICE:

Please do not return your product to the retailer. Instead, return your product to the JVC authorized service center nearest you. If shipping the product to the service center, please be sure to package it carefully, preferably in the original packaging, and include a brief description of the problem(s) and a copy of the proof of purchase to verify purchase date. Please call 1-800-252-5722 to locate the nearest JVC authorized service center. Service locations can also be obtained from our website <http://www.jvc.com>. If your product qualifies for in-home service, the service representative will require clear access to the product.

If you have any questions concerning your JVC Product, please contact our Customer Care Center at 800-252-5722

WHAT IS NOT COVERED:

This limited warranty provided by JVC does not cover:

1. Products which have been subject to abuse, accident, alteration, modification, tampering, negligence, misuse, faulty installation, lack of reasonable care, or if repaired or serviced by anyone other than a service facility authorized by JVC to render such service, or if affixed to any attachment not provided with the products, or if the model or serial number has been altered, tampered with, defaced or removed;
2. Initial installation, installation and removal from cabinets or mounting systems.
3. Operational adjustments covered in the Owner's Manual, normal maintenance, video and audio head cleaning;
4. Damage that occurs in shipment, due to act of God, and cosmetic damage;
5. Signal reception problems and failures due to line power surge;
6. User Removal Memory Devices/Video Pick-up Tubes/CCD Image Sensors are covered for 90 days from the date of purchase;
7. Accessories;
8. Batteries (except that Rechargeable Batteries are covered for 90 days from the date of purchase);
9. Products used for commercial purposes, including, but not limited to rental.
10. Loss of data resultant from malfunction of hard drive or other data storage device;

There are no express warranties except as listed above.

THE DURATION OF ANY IMPLIED WARRANTIES, INCLUDING THE IMPLIED WARRANTY OF MERCHANTABILITY, IS LIMITED TO THE DURATION OF THE EXPRESS WARRANTY HEREIN. JVC SHALL NOT BE LIABLE FOR ANY LOSS OF USE OF THE PRODUCT, INCONVENIENCE, OR ANY OTHER DAMAGES, WHETHER DIRECT, INCIDENTAL OR CONSEQUENTIAL (INCLUDING, WITHOUT LIMITATION, DAMAGE TO TAPES, RECORDS OR DISCS) RESULTING FROM THE USE OF THIS PRODUCT, OR ARISING OUT OF ANY BREACH OF THIS WARRANTY. ALL EXPRESS AND IMPLIED WARRANTIES, INCLUDING THE WARRANTIES OF MERCHANTABILITY AND FITNESS FOR PARTICULAR PURPOSE, ARE LIMITED TO THE WARRANTY PERIOD SET FORTH ABOVE.

Some states do not allow the exclusion of incidental or consequential damages or limitations on how long an implied warranty lasts, so these limitations or exclusions may not apply to you. This warranty gives you specific legal rights and you may also have other rights which vary from state to state.

JVC AMERICAS CORP.

1700 Valley Road, Wayne, New Jersey 07470

<http://www.jvc.com>

REFURBISHED PRODUCTS CARRY A SEPARATE WARRANTY, THIS WARRANTY DOES NOT APPLY. FOR DETAIL OF REFURBISHED PRODUCT WARRANTY, PLEASE REFER TO THE REFURBISHED PRODUCT WARRANTY INFORMATION PACKAGED WITH EACH REFURBISHED PRODUCT.

For customer use:

Enter below the Model No. and Serial No. which is located either on the rear, bottom or side of the cabinet. Retain this information for future reference.

Model No.:

Serial No.:

Purchase date:

Name of dealer:

Free Manuals Download Website

<http://myh66.com>

<http://usermanuals.us>

<http://www.somanuals.com>

<http://www.4manuals.cc>

<http://www.manual-lib.com>

<http://www.404manual.com>

<http://www.luxmanual.com>

<http://aubethermostatmanual.com>

Golf course search by state

<http://golfingnear.com>

Email search by domain

<http://emailbydomain.com>

Auto manuals search

<http://auto.somanuals.com>

TV manuals search

<http://tv.somanuals.com>