



ENGLISH
ESPAÑOL
FRANÇAIS

KW-V51BT/KW-V31BT

MONITOR WITH DVD RECEIVER

INSTRUCTION MANUAL

MONITOR CON RECEPTOR DE DVD

MANUAL DE INSTRUCCIONES

MONITEUR AVEC RÉCEPTEUR DVD

MODE D'EMPLOI

JVC KENWOOD Corporation

This instruction manual is used to describe models listed below.

- Region 1 (DVD Region Code 1 area)/Region 4 (DVD Region Code 4 area)

En este manual de instrucciones se describen los modelos listados a continuación.

- Región 1 (DVD Código de región Área 1)/Región 4 (DVD Código de región Área 4)

Ce mode d'emploi est utilisé pour décrire les modèles de la liste ci-dessous.

- Région 1 (zone de code de région DVD 1)/Région 4 (zone de code de région DVD 4)



CONTENTS

BEFORE USE	2	Using a rear view camera	33
How to reset your unit.....	3	Using a smartphone—HDMI/MHL.....	34
INITIAL SETTINGS	4	Using an external monitor— Rear Source	34
BASICS	5	BLUETOOTH	35
Component names and functions	5	SETTINGS	43
Common operations.....	6	Settings for using applications of iPod/iPhone/ Android	43
Common screen operations.....	7	Sound adjustment	44
Selecting the playback/video source.....	8	Adjustment for video playback.....	45
DISCS	9	Changing the display design	47
USB	14	Customizing the Home screen.....	48
iPod/iPhone	16	Customizing the system settings	48
Apps	19	Setting menu items.....	49
Pandora® (Only for KW-V51BT Region 1/ KW-V31BT Region 1)	20	REMOTE CONTROLLER	51
iHeartRADIO (Only for KW-V51BT Region 1/ KW-V31BT Region 1)	22	CONNECTION/INSTALLATION	53
TUNER	24	REFERENCES	59
SiriusXM® Satellite Radio (Only for KW-V51BT Region 1/KW-V31BT Region 1)	27	Maintenance	59
OTHER EXTERNAL COMPONENTS	32	More information	59
Using external audio/video players—AV-IN	32	Error message list	63
Using external audio players—Front AUX (Only for KW-V31BT).....	32	Troubleshooting.....	64
		Specifications.....	66

How to read this manual:

- Illustrations of KW-V51BT Region 1 are mainly used for explanation. The displays and panels shown in this manual are examples used to provide clear explanations of the operations. For this reason, they may be different from the actual displays or panels.
- This manual mainly explains operations using the buttons on the monitor panel and touch panel. For operations using the remote controller (RM-RK258), see page 51.
- < > indicates the various screens/menus/operations/settings that appear on the touch panel.
- [] indicates the buttons on the touch panel.
- **Indication language:** English indications are used for the purpose of explanation. You can select the indication language from the <Settings> menu. (Page 50)
- Updated information (the latest Instruction Manual, system updates, new functions, etc.) is available from <<http://www.jvc.net/cs/car/>>.

BEFORE USE

IMPORTANT

To ensure proper use, please read through this manual before using this product. It is especially important that you read and observe WARNINGS and CAUTIONS in this manual. Please keep the manual in a safe and accessible place for future reference.

⚠ **WARNINGS: (To prevent accidents and damage)**

- DO NOT install any unit or wire any cable in a location where;
 - it may obstruct the steering wheel and gearshift lever operations.
 - it may obstruct the operation of safety devices such as air bags.
 - it may obstruct visibility.
- DO NOT operate the unit while driving. If you need to operate the unit while driving, be sure to look around carefully.
- The driver must not watch the monitor while driving.

For KW-V51BT Region 4/KW-V31BT Region 4: The marking of products using lasers



The label is attached to the chassis/case and says that the component uses laser beams that have been classified as Class 1. It means that the unit is utilizing laser beams that are of a weaker class. There is no danger of hazardous radiation outside the unit.

BEFORE USE

For KW-V51BT Region 1/KW-V31BT Region 1:

⚠ CAUTION

Use of controls or adjustments or performance of procedures other than those specified herein may result in hazardous radiation exposure. In compliance with Federal Regulations, the following are reproductions of labels on, or inside the product relating to laser product safety.

JVC KENWOOD Corporation
2967-3, ISHIKAWA-MACHI, HACHIOJI-SHI, TOKYO, JAPAN

THIS PRODUCT COMPLIES WITH DHHS RULES 21CFR
SUBCHAPTER J IN EFFECT AT DATE OF MANUFACTURE.

Location : Top plate

FCC WARNING

This equipment may generate or use radio frequency energy. Changes or modifications to this equipment may cause harmful interference unless the modifications are expressly approved in the instruction manual. The user could lose the authority to operate this equipment if an unauthorized change or modification is made.

FCC NOTE

This equipment has been tested and found to comply with the limits for a Class B digital device, pursuant to Part 15 of the FCC Rules. These limits are designed to provide reasonable protection against harmful interference in a residential installation.

This equipment may cause harmful interference to radio communications, if it is not installed and used in accordance with the instructions. However, there is no guarantee that interference will not occur in a particular installation. If this equipment does cause harmful interference to radio or television reception, which can be determined by turning the equipment off and on, the user is encouraged to try to correct the interference by one or more of the following measures:

- Reorient or relocate the receiving antenna.
- Increase the separation between the equipment and receiver.
- Connect the equipment into an outlet on a circuit different from that to which the receiver is connected.
- Consult the dealer or an experienced radio/TV technician for help.

For KW-V51BT Region 1/KW-V31BT Region 1: IC (Industry Canada) Notice

This device complies with Industry Canada license-exempt RSS standard(s).

Operation is subject to the following two conditions:

(1) This device may not cause interference, and (2) this device must accept any interference, including interference that may cause undesired operation of the device.

The term "IC: " before the certification/registration number only signifies that the Industry Canada technical specification were met.

CAUTION

This equipment complies with FCC/IC radiation exposure limits set forth for an uncontrolled environment and meets the FCC radio frequency (RF) Exposure Guidelines in Supplement C to OET65 and RSS-102 of the IC radio frequency (RF) Exposure rules. This equipment has very low levels of RF energy that it deemed to comply without maximum permissive exposure evaluation (MPE). But it is desirable that it should be installed and operated keeping the radiator at least 20 cm or more away from person's body (excluding extremities: hands, wrists, feet and ankles). Under Industry Canada regulations, this radio transmitter may only operate using an antenna of a type and maximum (or lesser) gain approved for the transmitter by Industry Canada. To reduce potential radio interference to other users, the antenna type and its gain should be so chosen that the equivalent isotropically radiated power (e.i.r.p.) is not more than that necessary for successful communication.

- Contains Transmitter Module
FCC ID : YZP-RBFAC21XX
- Contains Transmitter Module
IC: 7414A-RBFAC21XX

⚠ Cautions on the monitor:

- The monitor built into this unit has been produced with high precision, but it may have some ineffective dots. This is inevitable and is not considered defective.
- Do not expose the monitor to direct sunlight.

- Do not operate the touch panel using a ball-point pen or similar tool with a sharp tip.
Touch the buttons on the touch panel with your finger directly (if you are wearing a glove, take it off).
- When the temperature is very cold or very hot...
 - Chemical changes occur inside, causing malfunction.
 - Pictures may not appear clearly or may move slowly. Pictures may not be synchronized with the sound or picture quality may decline in such environments.

For safety...

- Do not raise the volume level too much, as this will make driving dangerous by blocking outside sounds, and may cause hearing loss.
- Stop the car before performing any complicated operations.

Temperature inside the car...

If you have parked the car for a long time in hot or cold weather, wait until the temperature in the car becomes normal before operating the unit.

□ How to reset your unit

If the unit fails to operate properly, press the reset button.

KW-V51BT

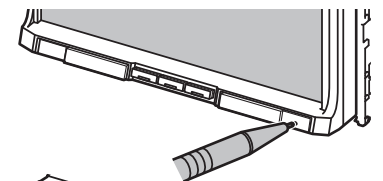

KW-V31BT

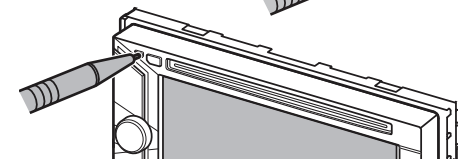

INITIAL SETTINGS

Initial setup

When you power on the unit for the first time or reset the unit, the initial setting screen appears.

- You can also change the settings on the **<Settings>** screen. (Page 49)

1



<Language>
(Page 50)

Select the text language used for on-screen information.

- Set **<GUI Language>** to display the operation buttons and menu items in the selected language (**[Local]**) or English (**[English]**).

<Camera Input>
(Page 50)

Select **[On]** when connecting the rear view camera.

<Display Design>
(Page 47)

Select the background and the panel color.

<Demonstration>
(Page 50)

Activate or deactivate the display demonstration.

2 Finish the procedure.

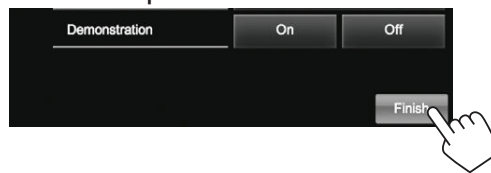

The Home screen is displayed.

- [AV Off]** is selected initially. Select the playback source. (Page 8)

Calendar/Clock settings

1 Display the Home screen.

KW-V51BT **KW-V31BT**

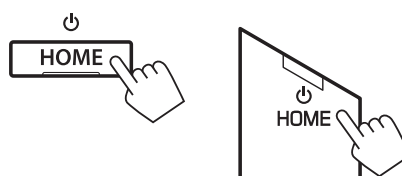

2 Display the **<Settings>** screen.

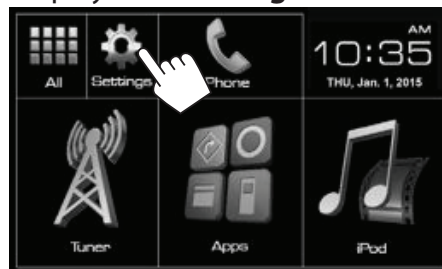

3 Display the **<Calendar Setting>** screen.



4 Select the time display format (①), then set the calendar and the clock time (②).

- Press **[Set]** to set the second to "00".



5 Finish the procedure.



BASICS

Component names and functions

⚠ Caution on the volume setting:

Digital devices produce very little noise compared with other sources. Lower the volume before playing these digital sources to avoid damaging the speakers by sudden increase of the output level.

KW-V51BT

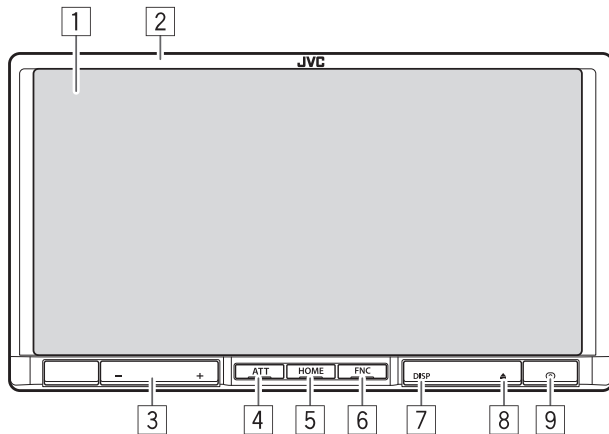

- 1 Screen (touch panel)
- 2 Monitor panel*
- 3 VOLUME -/+ button
Adjusts the audio volume. (Page 6)
- 4 ATT button
Attenuates the sound. (Page 6)
- 5 HOME/⏪ button
 - Displays the Home screen. (Press) (Page 7)
 - Turns on the power. (Press) (Page 6)
 - Turns off the power. (Hold) (Page 6)

- 6 FNC/🎤 button
 - Pops up the <Function Menu>/<Video Menu> screen on the source control screen. (Press) (Page 7)
 - Activates the voice dialing. (Hold) (Page 40)
- 7 DISP/DISP OFF button
 - Switches the screen between the current source and the App screen from the connected iPod touch/iPhone/Android. (Press) (Page 19)
 - Turns off the screen. (Hold) (Page 6)
 - Turns on the screen. (Hold) (Page 6)
- 8 ▲ (Eject) button
 - Displays the <Open/Angle> screen. (Press) (Page 6)
- 9 Reset button
Resets the unit. (Page 3)

KW-V31BT

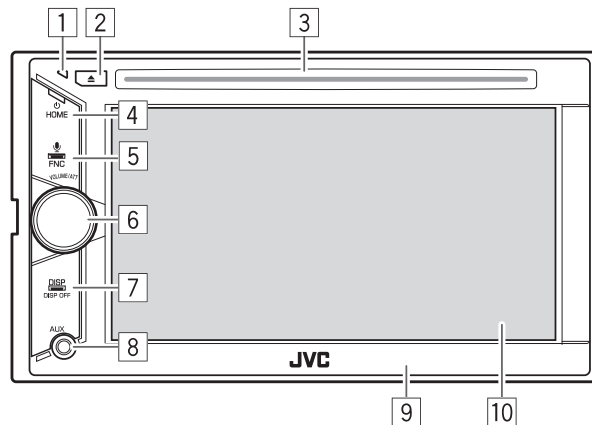

- 1 Reset button
Resets the unit. (Page 3)
- 2 ▲ (Eject) button
 - Ejects the disc. (Press) (Page 9)
- 3 Loading slot
- 4 HOME/⏪ button
 - Displays the Home screen. (Press) (Page 7)
 - Turns on the power. (Press) (Page 6)
 - Turns off the power. (Hold) (Page 6)
- 5 FNC/🎤 button
 - Pops up the <Function Menu>/<Video Menu> screen on the source control screen. (Press) (Page 7)
 - Activates the voice dialing. (Hold) (Page 40)
- 6 VOLUME/ATT knob
 - Attenuates the sound. (Press) (Page 6)
 - Adjusts the audio volume. (Turn) (Page 6)
- 7 DISP/DISP OFF button
 - Switches the screen between the current source and the App screen from the connected iPod touch/iPhone/Android. (Press) (Page 19)
 - Turns off the screen. (Hold) (Page 6)
 - Turns on the screen. (Hold) (Page 6)
- 8 AUX input jack
- 9 Monitor panel*
- 10 Screen (touch panel)

* You can change the color of the buttons on the monitor panel. (Page 47)

BASICS

Common operations

Turning on the power

KW-V51BT



KW-V31BT

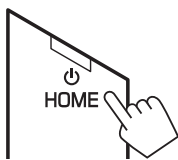

Turning off the power

KW-V51BT



KW-V31BT

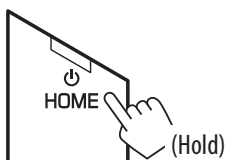

Adjusting the volume

To adjust the volume (00 to 35)

KW-V51BT

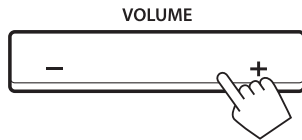

Press + to increase, and press – to decrease.

- Holding the button increases/decreases the volume continuously.

KW-V31BT



Turn to the right to increase, and turn to the left to decrease.

To attenuate the sound

KW-V51BT



KW-V31BT



The ATT indicator lights up.

To cancel the attenuation: Press the same button again.

Turning off the screen

KW-V51BT

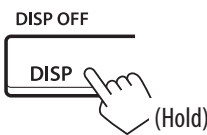

KW-V31BT

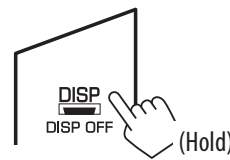

To turn on the screen: Press and hold DISP on the monitor panel.

Turning on/off the AV source

You can activate the AV function by selecting a source on the Home screen.



To select a source not displayed on the Home screen: Press [All]. (Page 8)

To turn off the AV source:



Monitor panel operations — <Open/ Angle> (only for KW-V51BT)

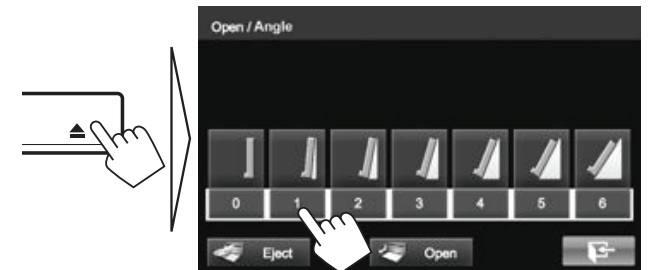

- [0] – [6] Selects an angle.
- [Eject] Ejects the disc.
- [Open] Opens the monitor panel.
- [Close] Closes the monitor panel.
- [Close] Exits from the <Open/Angle> screen.

BASICS

Common screen operations

Common screen descriptions

You can display other screens any time to change the source, show the information, or change the settings, etc.

Source control screen

Performs source playback operations.

- The operation buttons vary depending on the selected source.
- Touching the text information changes the information type.

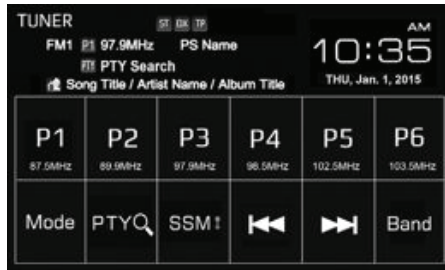

<Function Menu>/<Video Menu> screen

While displaying to the source control screen, you can display/hide other operation buttons by pressing FNC/ on the monitor panel.

<Function Menu> screen



<Video Menu> screen



Common operating buttons:

- 1 Switches to the <Video Menu> screen.
- 2 Closes the <Function Menu>/<Video Menu> screen and returns to the source control screen.
- 3 Sub-function buttons for source playback
 - The buttons vary depending on the selected source.
- 4 Short-cut buttons
 - [Phone] Displays the phone control screen. (Page 39)
 - [Voice] Activates the voice dialing. (Page 40)
 - [Equalizer] Displays the <Equalizer> screen. (Page 44)
 - [Display] Displays the <Display> menu screen. (Page 50)
 - [TP] Activates/deactivates TA standby reception mode. (Page 26)

- 5 Switches to the <Function Menu> screen.
- 6 Operation buttons for video playback.
 - The buttons vary depending on the selected source.

Home screen

Displays the source control screen/settings screen and changes the picture source.

- To display the Home screen, press HOME on the monitor panel.

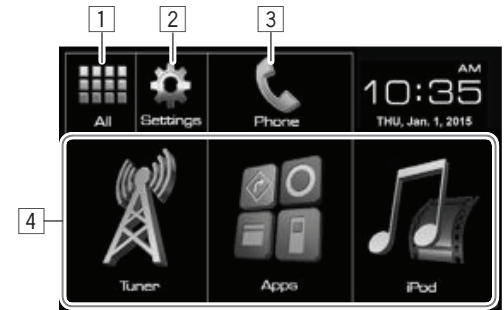

Common operating buttons:

- 1 Displays all the sources. (Page 8)
- 2 Displays the <Settings> screen. (See below.)
- 3 Displays the phone control screen. (Page 39)
- 4 Changes the playback source. (Page 8)

<Settings> screen

Changes the detailed settings. (Page 49)



Common operating buttons:

- 1 Selects the menu category.
- 2 Changes the page.
- 3 Returns to the previous screen.
- 4 Displays the current source control screen.

BASICS

Touch screen operations

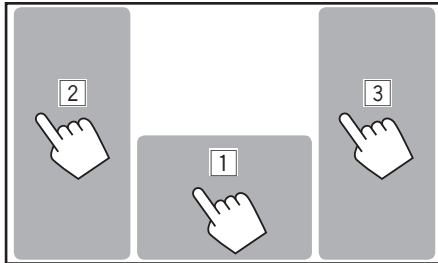

- 1 Displays the source control screen while playing a video.



- The operation buttons disappear when the screen is touched or when no operation is done for about 5 seconds.

- 2 Goes to the previous chapter/track.*
3 Goes to the next chapter/track.*

* Not available for video from an external component. Dragging your finger to the left or right functions in the same way as touching.

Selecting the playback/video source

On the Home screen:



- For **[USB]/[iPod]/[Pandora]/[iHeartRadio]**: When playing a source with the jacket picture/Artwork/picture data shown, the jacket picture/Artwork/picture data is displayed on the button instead of the source icon on the Home screen.

- [AV Off]** Turns off the AV source. (Page 6)
- [Camera]** Switches to a camera connected to the rear view camera input. (Page 33)
- [RearSource]** Selects the rear source to display on the external monitor. (Page 34)
- [Apps]** Switches to the App screen from the connected iPod touch/iPhone/Android device. (Page 19)
- [Tuner]** Switches to the radio broadcast. (Page 24)
- [Disc]** Plays a disc. (Page 9)

- [USB]** Plays files on a USB device. (Page 14)
- [iPod]** Plays an iPod/iPhone. (Page 16)
- [BT Audio]** Plays a Bluetooth audio player. (Page 41)
- [HDMI/MHL]** Plays a device connected to the HDMI/MHL input terminal. (Page 34)
- [AV-IN]** Switches to an external component connected to the AV-IN1 terminal on the rear panel. (Page 32)
- [Front AUX]*1** Switches to an external component connected to AUX input jack on the monitor panel. (Page 32)
- [Pandora]*2** Switches to the Pandora broadcast. (Page 20)
- [iHeartRadio]*2** Switches to the iHeartRADIO broadcast. (Page 22)
- [SiriusXM]*2** Switches to the SiriusXM® radio broadcast. (Page 27)

To restore the screen: Press **[Home]**.

*1 Only for KW-V31BT.

*2 Only for KW-V51BT Region 1/KW-V31BT Region 1.

Selecting the playback source on the Home screen



- You can change the items to display on the Home screen. (Page 48)

DISCS

Playing a disc

- If a disc does not have a disc menu, all tracks on it will be played repeatedly until you change the source or eject the disc.
- For playable disc types/file types, see page 60.

Inserting a disc

- Insert a disc with the label side facing up.
- For KW-V51BT: To open the monitor panel, see page 6.

KW-V51BT

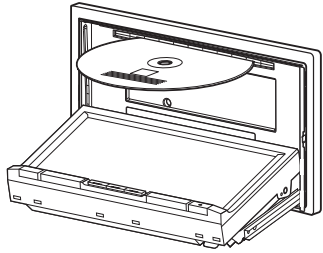

KW-V31BT

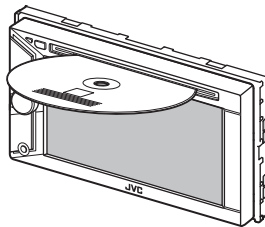

The source changes to **"DISC"** and playback starts.

- The DISC IN (DISC IN) indicator lights up while a disc is inserted.

- If "⊘" appears on the screen, the unit cannot accept the operation you have tried to do.
 - In some cases, without showing "⊘," operations will not be accepted.
- When playing back a multi-channel encoded disc, the multi-channel signals are downmixed to stereo.

Ejecting a disc

KW-V51BT

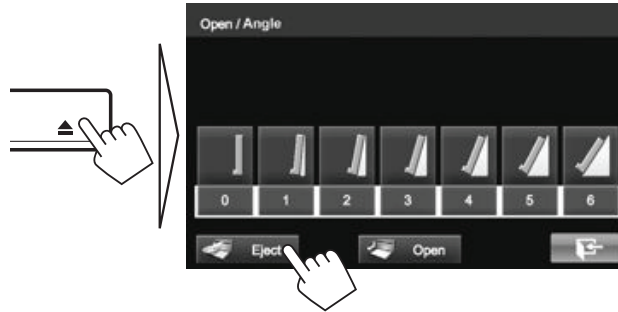

KW-V31BT



- When removing a disc, pull it horizontally.
- You can eject a disc when playing another AV source.
- If the ejected disc is not removed within 60 seconds, the disc is automatically inserted again into the loading slot to protect it from dust.

Playback operations

- When the operation buttons are not displayed on the screen, touch the area shown on the illustration.
- To change settings for video playback, see page 45.

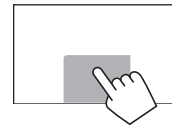

Indications and buttons on the source control screen

For video playback



Playback information

- The information displayed on the screen differs depending on the type of disc/file being played back.
 - 1 Media type
 - 2 Audio format
 - 3 Playback mode (Page 12)
 - 4 Playing time
 - 5 DISC IN indicator
 - 6 Playback status
 - 7 Current playback item information (title no./chapter no./folder no./file no./track no.)
 - 8 Progress bar

Continued on the next page...

DISCS

Operation buttons

- Available buttons on the screen and operations differ depending on the type of disc/file being played back.

[Mode]	Changes the settings for disc playback on the <Mode> screen. (Page 13)
[Q]	Displays the folder/track list. (Page 11)
[◀◀] [▶▶]	<ul style="list-style-type: none"> • Selects a chapter/track. (Press) • Reverse/forward search. (Hold)
[▶/]	Starts/pauses playback.
[■]	Stops playback.
[↺]*	Selects repeat playback mode. (Page 12)
[⌂]*	Selects random playback mode. (Page 12)
[≡]*	Displays the Original Program/Playlist screen.
[◀] [▶]*	Plays in frame-by-frame.
[<] [>]	Selects a folder.
[PBC]*	Activates or deactivates the VCD PBC (Playback Control) function.

* Press FNC/ on the monitor panel to display the <Function Menu> screen to select the item. (Page 7)

For audio playback

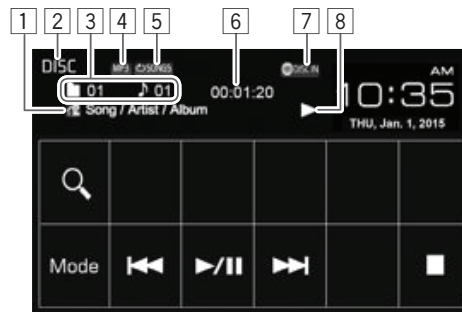

Playback information

- The information displayed on the screen differs depending on the type of disc/file being played back.
- 1 Track/file information
 - Touching the text information changes the information type.
 - 2 Media type
 - 3 Current playback item information (folder no./file no./track no.)
 - 4 Audio format
 - 5 Playback mode (Page 12)
 - 6 Playing time
 - 7 DISC IN indicator
 - 8 Playback status

Operation buttons

- Available buttons on the screen and operations differ depending on the type of disc/file being played back.
- | | |
|-----------|--|
| [Q] | Displays the folder/track list. (Page 11) |
| [<] [>]* | Selects a folder. |
| [Mode] | Changes the settings for disc playback on the <Mode> screen. (Page 13) |
| [◀◀] [▶▶] | <ul style="list-style-type: none"> • Selects a track. (Press) • Reverse/forward search. (Hold) |
| [▶/] | Starts/pauses playback. |
| [■] | Stops playback. |
| [↺]* | Selects repeat playback mode. (Page 12) |
| [⌂]* | Selects random playback mode. (Page 12) |

* Press FNC/ on the monitor panel to display the <Function Menu> screen to select the item. (Page 7)

DISCS

❑ Selecting a folder/track on the list

1

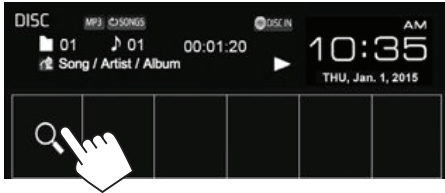

2 Select the folder (①), then the item in the selected folder (②).

- Repeat the procedure until you select the desired track.

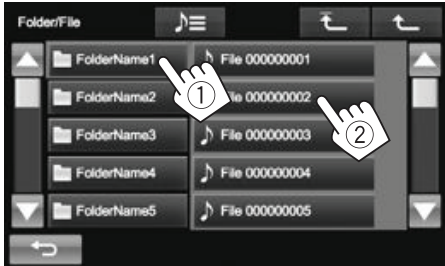

- You can change the page to display more items by pressing [▲]/[▼].
- Press [🎵] to open the folder containing the current track.
- Press [↶] to return to the root folder.
- Press [↷] to return to the upper layer.

❑ Video menu operations

You can display the video menu screen during video playback.

- The operation buttons disappear when the screen is touched or when no operation is done for about 5 seconds.

1 Display the <Video Menu> screen.

KW-V51BT

KW-V31BT

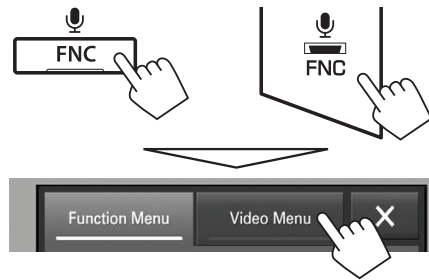

2

For video playback except VCD



- Available buttons on the screen and operations differ depending on the type of disc/file being played back.



Selects the aspect ratio. (Page 46)



Displays the picture adjustment screen. (Page 45)



Displays the picture size selection screen. (Page 46)



Switches to the direct disc menu mode. Touch the target item to select.

- To exit from the menu selection screen, press [↶].



Displays the menu/playlist/original program/scene selection screen.

- [▲] [▼] [◀] [▶]: Selects an item.
- [Enter]: Confirms the selection.
- [Return]: Returns to the previous screen.
- [↶]: Displays the menu screen of the top layer when several menu screens exist on the disc.
 - For DivX (only for KW-V51BT Region 4/KW-V31BT Region 4): Exits from the scene selection screen.

[Menu]

Displays the disc menu.

[Top Menu]

Displays the disc menu (DVD).



Selects the subtitle type.



Selects the audio type.

- For DVD-VR: Selects the audio channel (ST: stereo, L: left, R: right).



Selects the view angle.

- To close the <Video Menu> screen, press [X] or FNC/🎤 on the monitor panel.

Continued on the next page...

DISCS

For VCD



- [[]] Selects the aspect ratio. (Page 46)
- [[]] Displays the picture adjustment screen. (Page 45)
- [[]] Displays the picture size selection screen. (Page 46)
- [Menu] Displays the disc menu.
- [[]] Displays/hides the direct selection buttons. (See below.)
- [[]] Selects the audio channel (ST: stereo, LL: left, RR: right).

To select a track directly on a VCD



- When you enter a wrong number, press [CLR] to delete the last entry.

- To close the <Video Menu> screen, press [X] or FNC/ on the monitor panel.

Selecting playback mode

- 1 Display the <Function Menu> screen.

KW-V51BT



KW-V31BT



- 2



- [] Selects Repeat playback mode.
- [] Selects Random playback mode.

- To close the <Function Menu> screen, press [X] or FNC/ on the monitor panel.

- Available playback modes differ depending on the type of disc/file being played back.
- You cannot activate the repeat mode and the random mode at the same time.
- Each time you press the button, the playback mode changes. (The corresponding indicator lights up.)
 - Available items differ depending on the type of disc/file being played back.

- [] CHAPTER Repeats current chapter.
- [] TITLE Repeats current title.
- [] SONGS Repeats current track.
- [] FOLDER Repeats all tracks of the current folder.
- [] FOLDER Randomly plays all tracks of the current folder, then tracks of the next folders.
- [] ALL Randomly plays all tracks.

To cancel Repeat/Random playback: Press the button repeatedly until the indicator disappears.

DISCS

Settings for disc playback

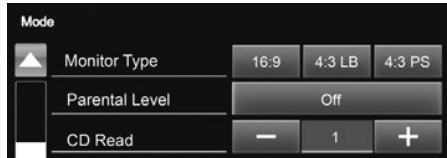
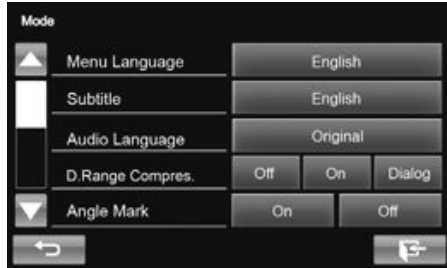

- Available items shown on the <Mode> screen differ depending on the type of disc/file being played back.

Setting items

<Menu Language>*	Select the initial disc menu language. (Initial: English) (Page 62)
<Subtitle>*	Select the initial subtitle language or turn subtitles off (Off). (Page 62) <ul style="list-style-type: none"> • Initial for KW-V51BT Region 1/ KW-V31BT Region 1: Off, for KW-V51BT Region 4/KW-V31BT Region 4: English
<Audio Language>*	Select the initial audio language. (Initial: Original) (Page 62)

<D.Range Compres.>*	<p>You can change the dynamic range while playing using Dolby Digital software.</p> <ul style="list-style-type: none"> • Off: Select this to enjoy a powerful sound at a low volume level with its full dynamic range. • On (Initial): Select this to reduce the dynamic range a little. • Dialog: Select this to reproduce movie dialog more clearly.
<Angle Mark>	<p>Select whether to display the angle mark.</p> <ul style="list-style-type: none"> • On (Initial): Select this to display the angle mark. • Off: Select this to hide the angle mark.
<Monitor Type>*	<p>Select the monitor type to watch a wide screen picture on the external monitor.</p> <p>16:9 (Initial) 4:3 LB 4:3 PS</p>
<Parental Level>*	Set the parental lock. (See the right column.)
<CD Read>	<p>Select the files to play on a disc containing music files. You cannot change the setting when a disc is inserted.</p> <ul style="list-style-type: none"> • 1 (Initial): Automatically distinguishes between audio file discs and music CDs. • 2: Forces to play as a music CD. No sound can be heard if an audio file disc is played.

* You can change these settings only while playback is stopped.

Setting the parental lock

The parental lock cannot be set during DVD playback.

- 1 Display the <Parental Pass Check> screen.

On the <Mode> screen:

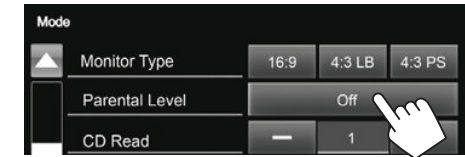

- 2 Enter the 4-digit parental pass code (①), and press [Enter] (②).

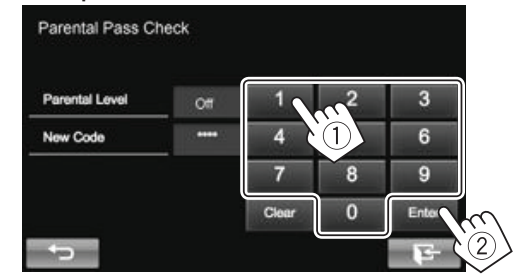

- To clear the entry, press [Clear].

- 3 Adjust the parental level ([Off], [1] to [8]).



USB

Connecting a USB device

You can connect a USB mass storage class device such as a USB memory, Digital Audio Player etc. to the unit.

- For details about connecting USB devices, see page 56.
- You cannot connect a computer or portable HDD to the USB input terminal.
- For playable file types and notes on using USB devices, see page 61.

When a USB device is connected...

The source changes to "USB" and playback starts.

- All tracks in the USB device will be played repeatedly until you change the source.

Playback operations

When the operation buttons are not displayed on the screen, touch the area shown on the illustration.

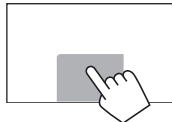

- To change settings for video playback, see page 45.

Indications and buttons on the source control screen

For audio files

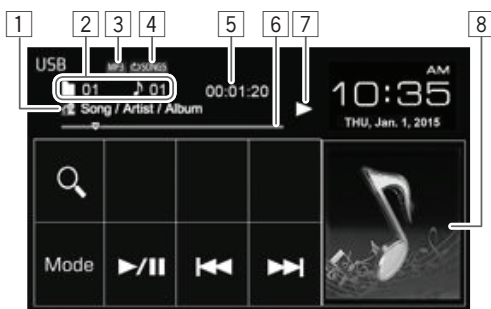

For video/picture files



Playback information

- The information displayed on the screen differs depending on the type of file being played back.

- 1 Track/file information
 - Touching the text information changes the information type.
- 2 Current playback item information (folder no./file no.)
- 3 Audio format
- 4 Playback mode (See the right column.)
- 5 Playing time
- 6 Progress bar
- 7 Playback status
- 8 Jacket picture (Shown while playing if the file has tag data that includes the jacket picture)

Operation buttons

- Available buttons on the screen and operations differ depending on the type of file being played back.

[Mode]

Changes the picture display time setting on the <Mode> screen. (Page 15)

[Q]

Displays the list selection screen. (Page 15)

[<<] [>>]

- Selects a track. (Press)
- Reverse/forward search. (Hold)

[▶/||]

Starts/pauses playback.

[<] [>]*1

Selects a folder.

[↺]*1 *2 *3

Selects repeat playback mode.

- **SONGS:** Repeats current track/file.
- **FOLDER:** Repeats all tracks/files in the current folder or specified category.

[⌘]*1 *2 *3

Activates random playback mode.

- **ALL:**
 - When selecting the track/file from the folder, randomly plays all tracks/files of the current folder, then the tracks/files of the next folder.
 - When selecting the track/file from the category, randomly plays all tracks/files of the specified category.

*1 Press FNC/ on the monitor panel to display the <Function Menu> screen to select the item. (Page 7)

*2 To cancel random or repeat mode, press the button repeatedly until the indicator disappears.

*3 You cannot activate the repeat mode and the random mode at the same time.

USB

❑ Setting <Picture Display Time>

Set the interval between slides during slide-shows of the picture files.

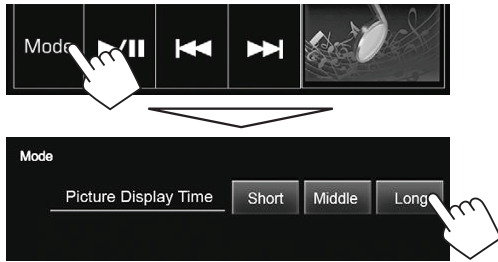

❑ Selecting a track in a list

1



2 Select the list type.

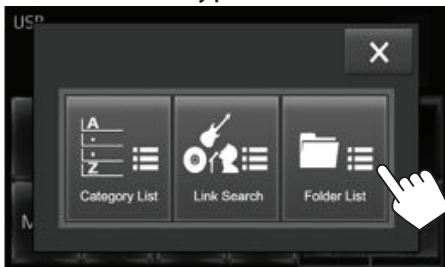

- To cancel the procedure, press [X].

3 Select the track.

- You can change the page to display more items by pressing [▲]/[▼].
- To list the items in alphabetical order, press [ABC Q].
- Press [🎵] to open the folder containing the current track.
- Press [↶] to return to the root folder.
- Press [↶] to return to the upper layer.
- If you want to play all tracks in the folder, press [▶] on the right of the desired folder.
- On the <Category List>/<Folder List> screen: You can switch the file type to list: Press [🎵] to list audio files, [📺] to list video files, or [🖼️] to list still picture files.

From the <Category List> screen:

Select the category (①), then the item in the selected category (②).

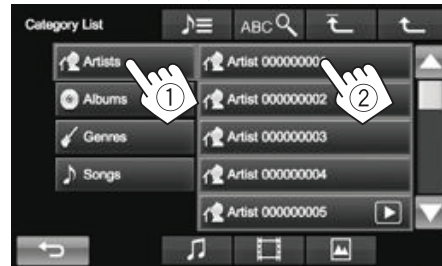

From the <Link Search> screen:

Select the tag type (①) to display a list of content that contains the same tag as the track/file currently being played, then the item (②).

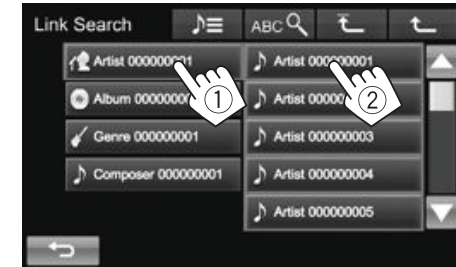

From the <Folder List> screen:

Select the folder (①), then the item in the selected folder (②).

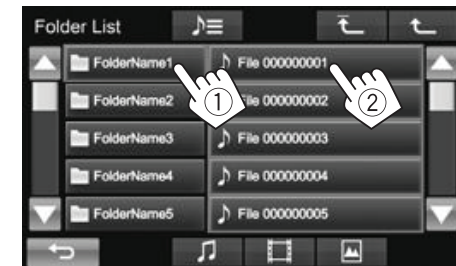

iPod/iPhone

Preparation

❑ Connecting iPod/iPhone

- For details about connecting iPod/iPhone, see page 56.
- For playable iPod/iPhone types, see page 62.

Connect your iPod/iPhone according to your purpose or the type of iPod/iPhone.

Wired connection

• To listen to music:

Use USB 2.0 cable (accessory of the iPod/iPhone) or KS-U62 (optional accessory).

• To watch video and listen to music:

- For iPod/iPhone except for iPod nano (7th Generation)/iPod touch (5th Generation)/iPhone 5S/iPhone 5C/iPhone 5, use USB Audio and Video cable for iPod/iPhone—KS-U59 (optional accessory).
- For iPod nano (7th Generation)/iPod touch (5th Generation)/iPhone 5S/iPhone 5C/iPhone 5, use the HDMI cable KS-U60 (optional accessory) and USB 2.0 cable (accessory of the iPod/iPhone)/KS-U62 (optional accessory) through a Lightning-Digital AV adapter (accessory of the iPod/iPhone).

Bluetooth connection

Pair the iPod/iPhone through Bluetooth. (Page 35)

- For iPod nano (7th Generation)/iPod touch (5th Generation)/iPhone 5S/iPhone 5C/iPhone 5: To watch video, connect your iPod/iPhone to the HDMI/MHL input terminal using KS-U60 (optional accessory). (Page 56)
- For iPod/iPhone except for iPod nano (7th Generation)/iPod touch (5th Generation)/iPhone 5S/iPhone 5C/iPhone 5: You cannot watch video with a Bluetooth connection.

❑ Selecting the iPod/iPhone device to play and connection method

When connecting the iPod/iPhone device for the first time, the setup screen (for connection, etc.) appears. Follow the procedure on the setup screen to configure the settings.

- 1 Display the <iPod Settings> screen. On the Home screen:

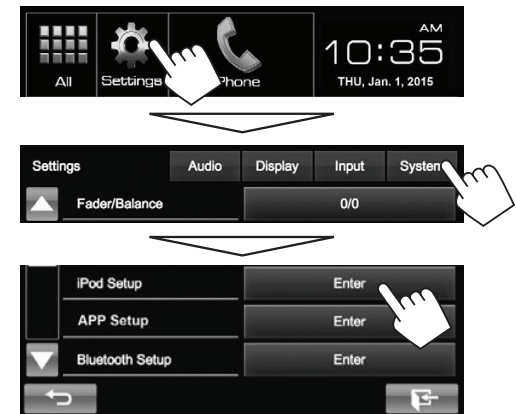

- If [Enter] for <iPod Setup> cannot be selected, turn off the AV source. (Page 6)

- 2

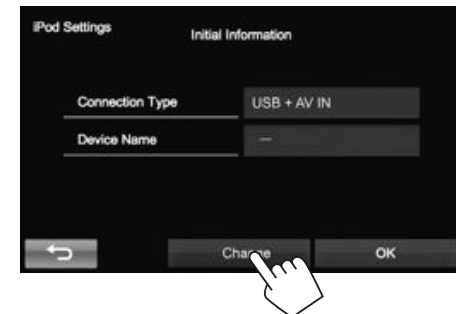

- If you do not need to change the settings, press [OK] to exit from the setup screen.

iPod/iPhone

- 3 Select the connection method (①), then press **[Next]** (②).

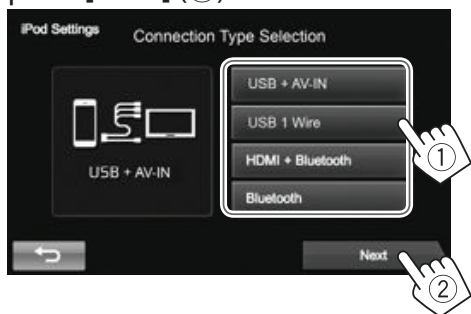

<**USB + AV-IN**>

Select this when the iPod/iPhone is connected using KS-U59 (optional accessory).

<**USB 1 Wire**>

Select this when the iPod/iPhone is connected using USB 2.0 cable (accessory of the iPod/iPhone) or KS-U62 (optional accessory).

<**HDMI + Bluetooth**>

Select this when the iPod/iPhone is connected using HDMI cable KS-U60 (optional accessory) and USB 2.0 cable (accessory of the iPod/iPhone)/KS-U62 (optional accessory) through a Lightning-Digital AV adapter (accessory of the iPod/iPhone).

<**Bluetooth**>

Select this when the iPod/iPhone is connected via Bluetooth.

- When selecting <**USB + AV-IN**> or <**USB 1 Wire**>, go to step 5.

- 4 When selecting <**HDMI + Bluetooth**> or <**Bluetooth**> as the connection method, paired device list appears. Select the target device (①), then press **[Next]** (②).

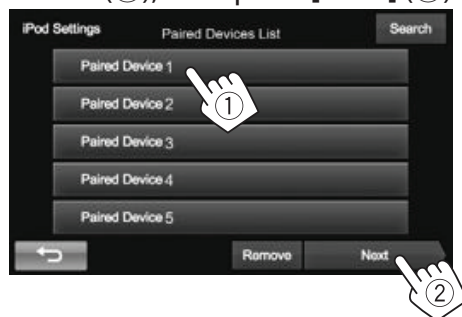

- If desired device is not listed, press **[Search]** for searching the available iPod/iPhone devices, then select the target device from the <**Available Devices**> screen.

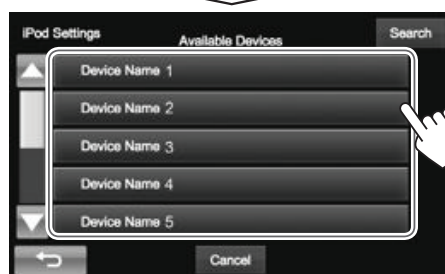
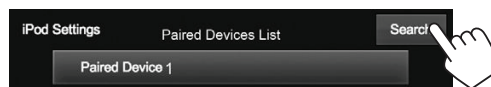

- You can change the page to display more items by pressing **[▲]**/**[▼]**.
- To stop searching, press **[Cancel]**.

- 5 Confirm the settings.

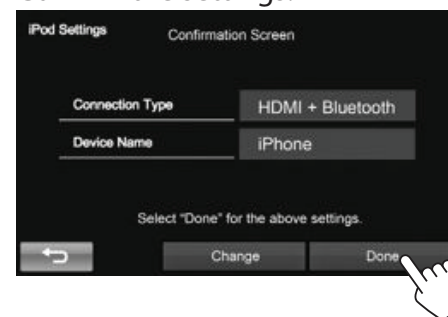

❑ Selecting preference settings for iPod/iPhone playback

When the source is "iPod"...

1



2



<**Audiobooks**> Select the speed of audio books.

<**Wide Screen**>*

- **[On]**: Select this to display video compatible with wide-screen display in wide-screen.
- **[Off]**: Select this to deactivate.

* You cannot change the setting when iPod/iPhone is connected.

iPod/iPhone

Playback operations

When the operation buttons are not displayed on the screen, touch the area shown on the illustration.

- To change settings for video playback, see page 45.

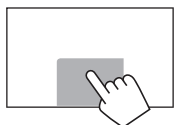

Indications and buttons on the source control screen

For audio playback

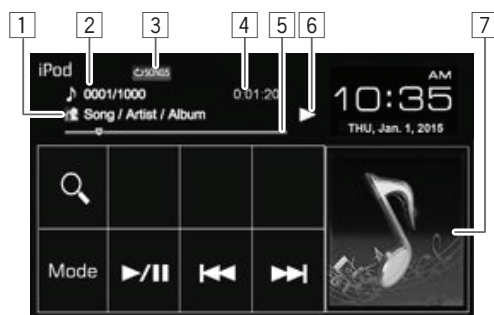

For video playback



Playback information

- 1 Song/video information
 - Touching the text information changes the information type.
- 2 Track no./Total track number
- 3 Playback mode (See below.)
- 4 Playing time
- 5 Progress bar
- 6 Playback status
- 7 Artwork (Shown if the song contains Artwork)

Operation buttons

[Mode] Changes the settings for iPod/iPhone playback on the **<Mode>** screen. (Page 17)

[Q] Displays the audio/video file list. (See the right column.)

[◀◀] [▶▶]

- Selects an audio/video file. (Press)
- Reverse/forward search. (Hold)

[▶/||] Starts/pauses playback.

[↺]*1 Selects repeat playback mode.

- **↺ SONGS:** Functions the same as Repeat One.
- **↺ ALL:** Functions the same as Repeat All.
- **↺:** Cancels the repeat mode.

[↻]*1 *2 Selects random playback mode.

- **↻ SONGS:** Functions the same as Shuffle Songs.
- **↻ ALBUMS:** Functions the same as Shuffle Albums.

*1 Press **FNC/⏏** on the monitor panel to display the **<Function Menu>** screen to select the item. (Page 7)

*2 To cancel random mode, press the button repeatedly until the indicator disappears.

Selecting an audio/video file from the list

1

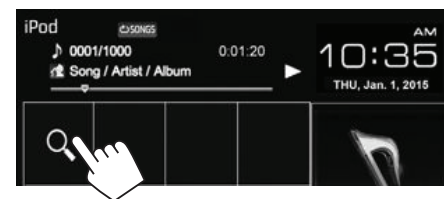

2

Select the menu (**🎵**: audio or **📺**: video) (①), a category (②), then a desired item (③).

- Select an item in each layer until you reach and select the desired file.

Audio menu:



iPod/iPhone

Video menu:



- You can change the page to display more items by pressing [▲]/[▼].
- To list the items in alphabetical order, press [ABC 🔍], then select the first character.
- Press [ALL ▶] to play all songs/videos.
- Press [⏪] to return to the top layer.
- Press [⏩] to return to the upper layer.
- Available categories differ depending on the type of your iPod/iPhone.

Apps

You can use an App of the connected iPod touch/iPhone/Android on this unit.

- For Apps you can use on this unit, visit <<http://www.jvc.net/cs/car/>>.
- For Android devices, you can use more functions with the JVC Smartphone Control application. For details, visit <<http://JVC.net/car/app/jsc/index.html>>

Preparation

- 1 Connect the iPod touch/iPhone/Android.
 - For wired connection, see page 56 for iPod touch/iPhone or page 57 for Android.
 - To view video, connect the device using KS-U59 or KS-U60 (optional accessory).
 - For Bluetooth connection, see page 35.
- 2 Select the iPod touch/iPhone/Android device to use and connection method on the <APP Settings> screen. (Page 43)

When connecting the device for the first time, the setup screen (for connection, etc.) appears. Follow the procedure on the setup screen to configure the settings.

Using an App

When the operation buttons are not displayed on the screen, touch the screen to show them.

- To change settings for video playback, see page 45.

Playback operations

- 1 Start App on your iPod touch/iPhone/Android.
- 2 Select “Apps” as the source. (Page 8)

Operation buttons on the source control screen

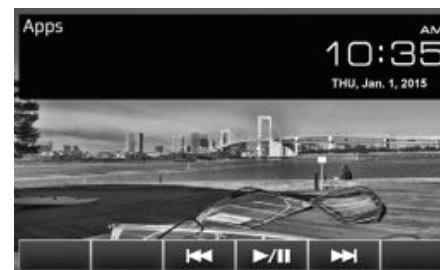

- [◀◀] [▶▶] Selects an audio/video file.
- [▶/||] Starts/pauses playback.

- You can operate some functions of the App on the touch panel.
- For some applications such as navigation applications, the operating buttons and information are not shown. You can perform the operations on the touch panel, such as scrolling the map.
 - If “⊗” appears on the screen, the unit cannot accept the touch operation you have tried to do.
- You can also play back the audio/video using iPod/iPhone itself instead of the unit.

Switching to the App screen while listening to another source

KW-V51BT

DISP OFF

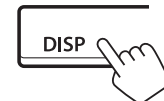

KW-V31BT



To return to the source control screen: Press DISP on the monitor panel.

Pandora® (Only for KW-V51BT Region 1/KW-V31BT Region 1)

You can stream Pandora from iPod touch/iPhone or Android devices.

- Install the latest version of the Pandora application on your iPod touch/iPhone/Android.

Preparation

Connect the device, then start the Pandora application.

- 1 Connect the device.
 - **For Android:** Pair the Android device through Bluetooth. (Page 35)
 - **For iPod touch/iPhone:** Connect iPod touch/iPhone. (Page 16)
- 2 Select the device to use and connection method on the <APP Settings> screen. (Page 43)
- 3 Select “Pandora” as the source. On the Home screen:



The Pandora application is started.

Playback operations

You can operate Pandora using the remote controller. Only playing, pausing, and skipping are available.

Indications and buttons on the source control screen

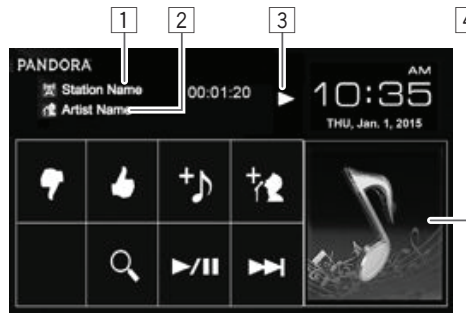

Playback information

- 1 Station name/playing time
 - Touching the text information changes the information type.
- 2 Track information
- 3 Playback status
- 4 Picture data

Operation buttons

- [👍] Registers the current track as a favorite.
- [👎] Thumbs down to the current track and skips to the next track.
- [+🎵] Adds the current track to the station.
- [+👤] Adds the current artist to the station.
- [🔍] Displays the list selection screen. (Page 21)
- [▶/⏸] Starts/pauses playback.
- [▶▶] Skips the current track.
 - Not available when the Pandora skip reaches its limit.

Pandora®

❑ Selecting a station from the list

1 Display the list selection screen.



2 Select the list type.

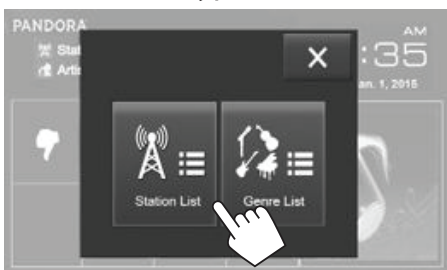

<Station List> Selects from the station names (Station List).

<Genre List> Selects from the genre names (Genre List).

3 Select a station from the list.



On the <Station List> screen



[Shuffle] Plays all the songs in the registered stations randomly.

[By Date] Sorts the list in reverse chronological order.

[A-Z] Sorts the list in alphabetical order.

- You can change the page to display more items by pressing [▲]/[▼].
- The  indicator appears on the left of the item when Shuffle is activated. (All songs on the registered stations are played randomly.)
- The  indicator appears on the right of the item when the station is shared.

On the <Genre List> screen

Select a genre, then a station.



- You can change the page to display more items by pressing [▲]/[▼].
- The selected station is added to the Station List.

Requirements for Pandora®

iPhone or iPod touch

- Install the latest version of the Pandora application on your iPhone or iPod touch. (Search for “Pandora” in the Apple App Store to find and install the most recent version.)

- Connect iPod touch/iPhone to this unit with a cable or via Bluetooth.
 - When connecting with a cable: Use KS-U59/ KS-U62 (optional accessory) or USB 2.0 cable (accessory of the iPod/iPhone).
 - When connecting via Bluetooth, the following profiles must be supported.
 - SPP (Serial Port Profile)
 - A2DP (Advanced Audio Distribution Profile)

Android™

- Visit Google play and search for “Pandora” to install.
- Bluetooth must be built in and the following profiles must be supported.
 - SPP (Serial Port Profile)
 - A2DP (Advanced Audio Distribution Profile)

NOTE

- Ensure you are logged in to your smartphone application. If you do not have a Pandora account, you can create one for free from your smartphone or at www.pandora.com.
- Pandora is available only in the U.S./Australia/New Zealand.
- Because Pandora is a third-party service, the specifications are subject to change without prior notice. Accordingly, compatibility may be impaired or some or all of the services may become unavailable.
- Some functions of Pandora cannot be operated from this unit.
- For issues using the application, contact Pandora at pandora-support@pandora.com
- Establish an Internet connection using LTE, 3G, EDGE, or WiFi.

iHeartRADIO (Only for KW-V51BT Region 1/KW-V31BT Region 1)

iHeartRADIO is a free, all-in-one digital radio service that lets you listen to your favorite Live Stations or create commercial-free, all-music Custom Stations featuring songs from the artists you select and similar music.

You can stream iHeartRADIO from iPod touch/iPhone or Android devices.

- Install the latest version of the iHeartRADIO application on your iPod touch/iPhone/Android.

Preparation

Connect the device, then start the iHeartRADIO application.

- 1 Connect the device.
 - **For Android:** Pair the Android device through Bluetooth. (Page 35)
 - **For iPod touch/iPhone:** Connect iPod touch/iPhone. (Page 16)
- 2 Select the device to use and connection method on the <APP Settings> screen. (Page 43)
- 3 Select "iHeartRADIO" as the source.



The iHeartRADIO application is started.

Playback operations

You can operate iHeartRADIO using the remote controller. Only playing, pausing, and skipping are available.

Indications and buttons on the source control screen

Live station screen:

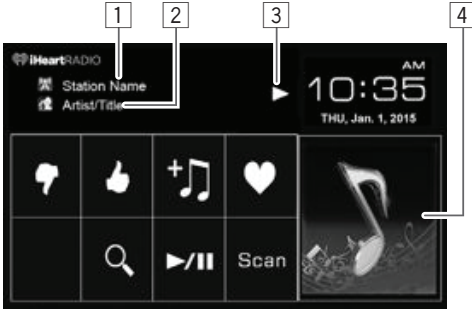

Custom station screen:



Playback information

- 1 Station name
 - Touching the text information changes the information type.
- 2 Track information
 - Touching the text information changes the information type.
- 3 Playback status
- 4 Picture data

Operation buttons

- [👎] Thumbs down to the current track and skips to the next track.
- [👍] Registers the current track as a favorite.
- [+🎵] Adds the current track to the <My Stations> list.
- [❤️]*1 Saves the current station to the <My Stations> list.
- [🔍] Displays the <Station Search> screen or the station list. (Page 23)
- [▶/⏸] Starts/pauses playback.
- [Scan]*1 Scans stations randomly.
- [🎛️]*2 Displays the variety level selection screen. (Page 23)
- [▶▶]*2 Skips the current track.

*1 Appears only for the live station screen.
*2 Appears only for the custom station screen.

iHeartRADIO

□ Selecting the variety level for your custom station

You can adjust the amount of lesser-known music that gets pushed into your custom station.

- 1 Display the variety type selection screen. On the custom station screen:

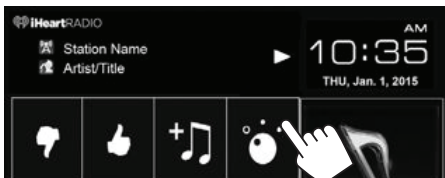

- 2 Select the variety type.



- <Familiar> Distributes well-known tracks.
 - <Mixed> Distributes a mix of the artists and track names.
 - <Less Familiar> Distributes a wide variety of tracks including lesser-known ones.
- To cancel the procedure, press [X].

□ Searching for a station

- 1 Display the <Station Search> screen.

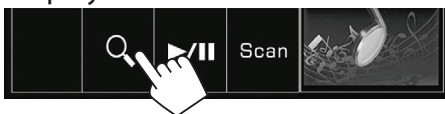

- 2 Select a station.

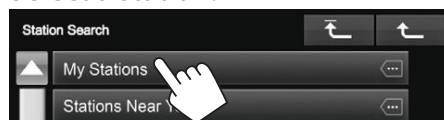

- Press [↶] to return to the top layer.
- Press [↷] to return to the upper layer.

□ Editing the <My Stations> list

- 1 Select <My Stations> on the <Station Search> screen. (See the left column.)

- 2 Display the <Station Edit> screen.



- 3 Select stations (①), then press [Delete] to delete the selected stations (②).

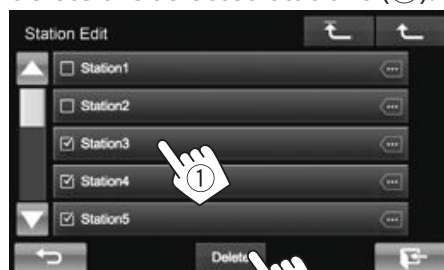

- Press [↶] to return to the top layer.
- Press [↷] to return to the upper layer.

Requirements for iHeartRADIO

iPhone or iPod touch

- Install the latest version of the iHeartRADIO for Auto application on your iPhone or iPod touch. (Search for "iHeartRADIO for Auto" in the Apple App Store to find and install the most recent version.)

- Connect iPod touch/iPhone to this unit with a cable or via Bluetooth.
 - When connecting with a cable: Use KS-U59/ KS-U62 (optional accessory) or USB 2.0 cable (accessory of the iPod/iPhone).
 - When connecting via Bluetooth, the following profiles must be supported.
 - SPP (Serial Port Profile)
 - A2DP (Advanced Audio Distribution Profile)

Android™

- Visit Google play and search for "iHeartRADIO for Auto" to install.
- Bluetooth must be built in and the following profiles must be supported.
 - SPP (Serial Port Profile)
 - A2DP (Advanced Audio Distribution Profile)

NOTE

- Ensure you are logged in to your smartphone application. If you do not have an iHeartRADIO account, you can create one for free from your smartphone or at <http://www.iheart.com/>.
- Because iHeartRADIO is a third-party service, the specifications are subject to change without prior notice. Accordingly, compatibility may be impaired or some or all of the services may become unavailable.
- Some functions of iHeartRADIO cannot be operated from this unit.
- For issues using the application, contact iHeartRADIO at <http://www.iheart.com/>.
- Establish an Internet connection using LTE, 3G, EDGE, or WiFi.

TUNER

Listening to the radio

Preparation: Select the appropriate tuner channel interval for **<Area Setting>**. (Page 25)

Indications and buttons on the source control screen

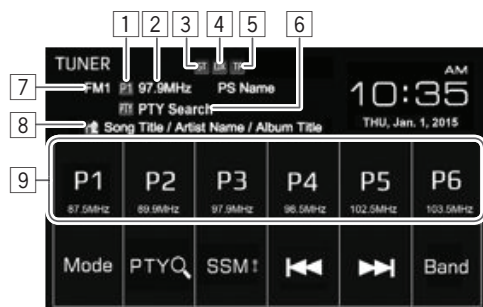

Tuner reception information

- 1 Preset no.
- 2 The station frequency currently tuned in/PS (station name) for FM RBDS when PS signal is coming in
- 3 ST/MO indicator
 - The ST indicator lights up when receiving an FM stereo broadcast with sufficient signal strength.
- 4 DX/LO indicator
- 5 Standby reception indicator
- 6 PTY code for FM RBDS
- 7 Band
- 8 Text information
 - Touching the text information changes the information type.
- 9 Preset list

Operation buttons

- [P1] – [P6]**
 - Selects a stored station. (Press)
 - Stores the current station. (Hold)
- [Mode]*1** Changes the settings for tuner reception on the **<Mode>** screen. (Page 25)
- [PTY Q]*1** Enters PTY search mode. (Page 26)
- [SSM ↕]*1** Presets the stations with the strongest signals automatically. (Hold) (Page 26)
- [◀▶]** Searches for a station.
 - Auto search (Press)
 - Manual search (Hold)
- [Band]** Selects the band.
 - FM1 → FM2 → FM3 → AM
- [MONO]*1*2** Activates/deactivates monaural mode. (See the right column.)
- [TP]*1*2** Activates/deactivates TA standby reception mode. (Page 26)

*1 Appears only when FM is selected as the source.

*2 Press FNC/🎤 on the monitor panel to display the **<Function Menu>** screen to select the item. (Page 7)

Improving the FM reception

Activate monaural mode for better reception.

- 1 Display the **<Function Menu>** screen.
KW-V51BT KW-V31BT



- 2



Monaural mode is activated. The MO indicator lights up.

- FM reception is improved, but the stereo effect will be lost.
- To close the **<Function Menu>** screen, press [X] or FNC/🎤 on the monitor panel.

To restore the stereo effect: Press [MONO] on the **<Function Menu>** screen.

TUNER

❑ Tuning in FM stations only with strong signals—LO/DX (Local/Distance-extreme)

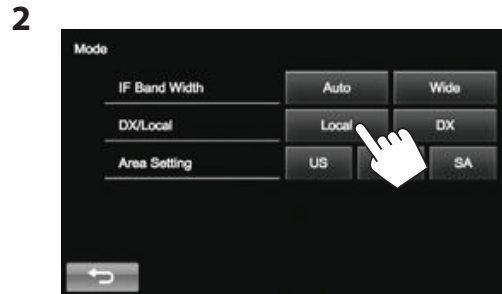

[Local] Select this to tune in only to stations with sufficient signal strength. The LO indicator lights up.

[DX] Deactivate the function. The DX indicator lights up.

❑ Reducing interference during FM reception

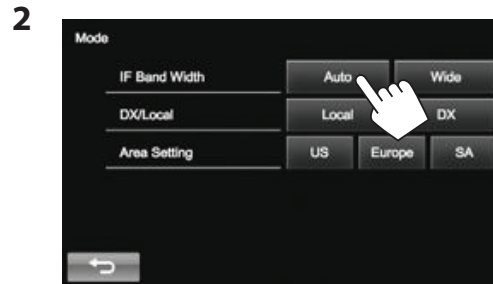
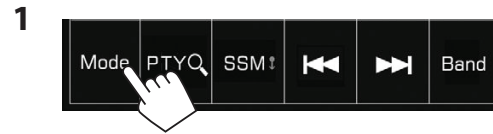

[Auto] Increases the tuner selectivity to reduce interference between adjacent stations. (Stereo effect may be lost.)

[Wide] Subject to the interference from adjacent stations, but sound quality will not be degraded and the stereo effect will remain.

❑ Changing the tuner channel interval

The tuner channel interval changes depending on the area you use this unit.

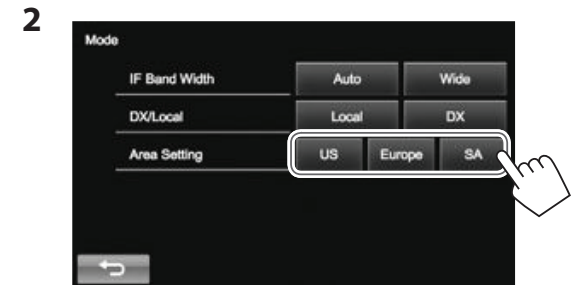
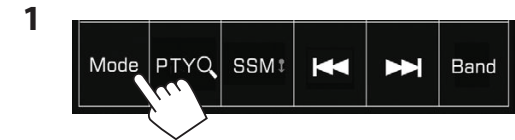

[US] Select this when using in North/Central/South America. FM/AM intervals are set to 200 kHz/10 kHz.

[Europe] Select this when using in any other areas. FM/AM intervals are set to 50 kHz/9 kHz.

[SA] Select this when using in South American countries where FM interval is 50 kHz. AM interval is set to 10 kHz.

- The initial setting is <US> for KW-V51BT Region 1/KW-V31BT Region 1, and <SA> for KW-V51BT Region 4/KW-V31BT Region 4.

TUNER

Presetting stations

❑ Storing stations in the memory

You can preset 6 stations for each band.

Automatic presetting—SSM (Strong-station Sequential Memory) (For FM only)



The local stations with the strongest signals are found and stored automatically.

Manual presetting

- 1 Tune in to a station you want to preset. (Page 24)
- 2 Select a preset number.



The station selected in step 1 is stored.

❑ Selecting a preset station



FM RBDS features

❑ Searching for FM RBDS programs—PTY Search

You can search for your favorite programs being broadcast by selecting the PTY code for your favorite programs.



- 2 Select a PTY code.

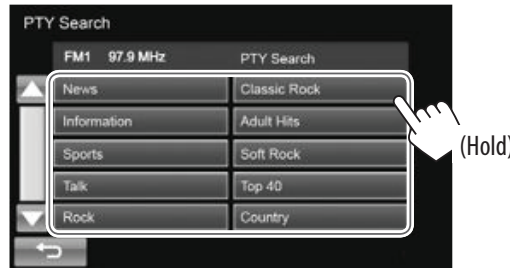

- You can change the page to display more items by pressing [▲]/[▼].

PTY Search starts.

If there is a station broadcasting a program of the same PTY code as you have selected, that station is tuned in.

❑ Activating/deactivating TA Standby Reception

- 1 Display the <Function Menu> screen.
KW-V51BT



KW-V31BT



- 2



The unit is in standby to switch to Traffic Announcement (TA) if available. (The TP indicator lights up in white.)

If the TP indicator is lit in gray, tune into another station providing RBDS signals.

To deactivate TA Standby Reception: Press [TP]. (The TP indicator turns off.)

- The volume adjustment for Traffic Announcement is automatically memorized. The next time the unit switches to Traffic Announcement, the volume is set to the previous level.

SiriusXM® Satellite Radio (Only for KW-V51BT Region 1/KW-V31BT Region 1)

Only SiriusXM® brings you more of what you love to listen to, all in one place. Get over 140 channels, including commercial-free music plus the best sports, news, talk, comedy and entertainment. Welcome to the world of satellite radio. A SiriusXM Vehicle Tuner and Subscription are required. For more information, visit www.siriusxm.com.

Activating subscription

- 1** Check your Radio ID.

The SiriusXM Satellite Radio ID is required for activation and can be found by tuning to Channel 0 as well as on the label found on the SiriusXM Connect tuner and its packaging.

 - The Radio ID does not include the letters I, O, S or F.
- 2** Activate the SiriusXM Connect Vehicle Tuner using one of the two methods below:

 - For users in the U.S.A:
 - Online: Visit www.siriusxm.com/activatenow
 - Phone: Call SiriusXM Listener Care at 1-866-635-2349
 - For users in Canada:
 - Online: Visit www.siriusxm.ca/activatexm
 - Phone: Call XM customer Care at 1-877-438-9677
- 3** Select **“SiriusXM”** as the source. (Page 8)

SiriusXM Connect Vehicle Tuner starts updating all the SiriusXM channels.

Listening to the SiriusXM® Satellite Radio

Indications and buttons on the source control screen



SiriusXM® Satellite Radio reception information

- Band
- Preset number
- Channel number/Channel name
- Signal strength indicator
- Text information
 - Touching the text changes the information between category/artist/title/information/description.
- Preset list

Operation buttons

- [P1] – [P6]**
- Selects a stored channel. (Press)
 - Stores the current channel. (Hold)
- [Mode]** Changes the settings for SiriusXM Satellite Radio reception on the **<Mode>** screen. (Pages 29 –31)
- [Q]** Displays the Category/Channel List. (Page 28)
- [Replay]/ [Preset]** Switches the Replay mode screen and the channel reception screen. (Page 28)
- [◀◀ CH]/ [▶▶ CH]**
- Selects a channel. (Press)
 - Changes the channel rapidly. (Hold)
 - While searching, invalid, skipped and unsubscribed channels are skipped.
- [Band]** Selects the band.
- SXM1 ➤ SXM2 ➤ SXM3 ➤ SXM4

SiriusXM® Satellite Radio

Selecting a channel

- 1 Display the <Channel List> screen.



- 2 Select a category (1), and then select a channel (2).

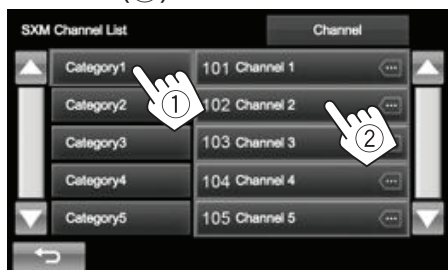

- You can change the page to display more items by pressing [▲]/[▼].

Presetting channels

Storing channels in the memory

You can preset 6 channels for each band.

- 1 Tune in to a channel you want to preset. (Page 27)
- 2 Select a preset number.



The channel selected in step 1 is stored.

Selecting a preset station



Replay

You can pause, rewind and replay content from the currently tuned channel.

- The SiriusXM Connect Vehicle Tuner continually buffers up to 60 minutes of audio.
- If you change to another channel during playback, the Replay buffer content will be lost.

Entering the Replay mode

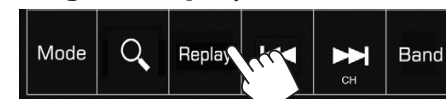

- 1 Progress bar
 - Shows the remaining capacity (gray) and the amount of buffered content (blue). If the Replay buffer is full, the entire bar becomes blue.
 - Updated every second.
- 2 Time code
 - Shows you the point in the Replay buffer you are listening to.
 - Example: -5:00
 - You are listening to audio that is 5 minutes behind the current broadcast.
 - Updated every second.
- 3 Playback status

SiriusXM® Satellite Radio

To return to the channel reception screen: Press **[Preset]**.

- When you are listening to Replay and switch to the channel reception screen, Replay still continues.

Replaying content

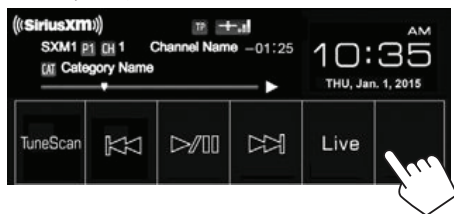

- To start/pause the playback, press **[▶||]**.
- To skip the current track segment, press **[◀◀]**/**[▶▶]**.
 - Pressing **[◀◀]** within 2 seconds of the beginning of the current track/segment returns to the previous track.
 - Pressing **[◀◀]** after 2 seconds or more of the track have been replayed returns to the beginning of the current track/segment.
- To rewind/fast forward, press and hold **[◀◀]**/**[▶▶]**.
- To return to the live position, press **[Live]**. (The time code returns to -0:00.)

SmartFavorites

User stored channels (P1 to P6) are recognized as SmartFavorites channels. SiriusXM Connect Vehicle Tuner automatically buffers their broadcast content in the background. When you select a SmartFavorite channel, you can rewind and replay up to 30 minutes of any of the missed news, talk, sports or music content.

- SmartFavorites is available only when you connect an SXV200 or later SiriusXM Connect Vehicle Tuner.
- If you change to another band, the buffered content is cleared and new channels in the current band will start buffering.

TuneStart™

When you select a preset channel, you can listen to the current song from the beginning.

Activating TuneStart™

1



2

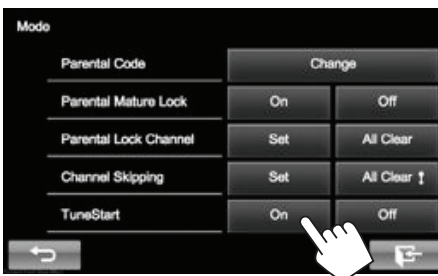

To deactivate TuneStart: Select **[OFF]** for **<TuneStart>**.

TuneScan™

When you activate TuneScan™, you will hear 6 seconds of the songs, which have not been listened to, from each of the music channel presets on the current Band.



The unit starts scanning.

- To select the previous/next content, press **[◀◀]** or **[▶▶]**.
- To end scanning and continue listening to the current song/content, press **[TuneScan]**.
- To exit scanning, press and hold **[TuneScan]**.

SiriusXM® Satellite Radio

Setting the reception restrictions

□ Setting the parental control

You can limit access to SiriusXM channels, such as those with mature content.

Setting/Changing the parental code

- The initial setting is “0000.”
- Changing the code does not change the <Parental Mature Lock>/<Parental Lock Channel> settings.

1 Display the <Parental Code> screen.

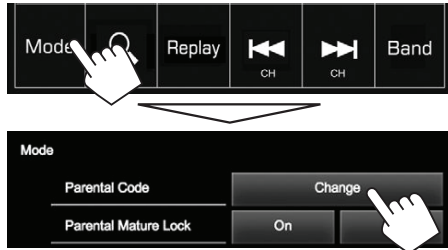

2 Enter the current code in <Current Code>, a new code in <New Code>, and then the new code again to confirm the entry in <Confirm Code>.

- ① Enter a code.
- ② Confirm the entry.



- Press [Clear] to delete the entry.

To change the parental code: Press [Change] in step 1, enter current code, then new code in step 2.

Activating/Deactivating the parental control

You can set the parental control for all channels classified as “mature” by SiriusXM®.

1

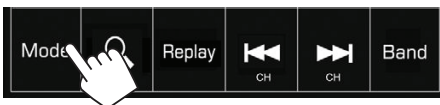

2 Press [On] (to activate) or [Off] (to deactivate).

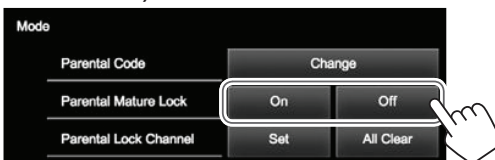

3 Enter the parental code to confirm your choice.

Selecting the channels to lock—Parental Lock Channel

1 Display the <Parental Lock Channel> screen.

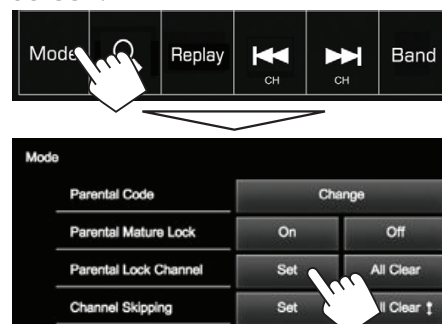

2 Enter your parental code number (①), then confirm the entry (②).



- Press [Clear] to delete the entry.

SiriusXM® Satellite Radio

- 3 Select a category (①), and then a channel (②).

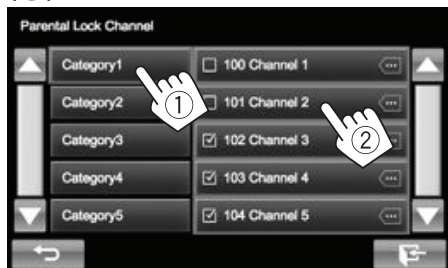

- The indicator appears beside the selected channel.
- To cancel the selection, select the channel again in step 3. The indicator disappears and the selection is canceled.
- When you try to receive a channel with the parental lock activated, the parental code input screen appears and you cannot receive the channel until you enter the correct code.

Clearing the parental lock for all locked channels

- 1 Display the <Parental Lock Channel> screen.

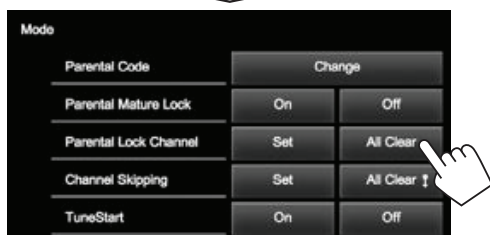
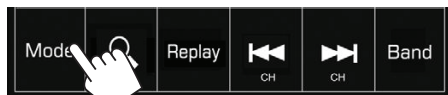

- 2 Enter your parental code number (①), then confirm the entry (②).

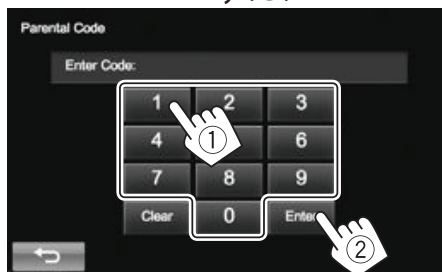

- Press **[Clear]** to delete the entry.

Skipping unwanted channels

If you do not want to receive some channels, you can skip them.

Activating channel skipping

- 1 Display the <Channel Skipping> screen.

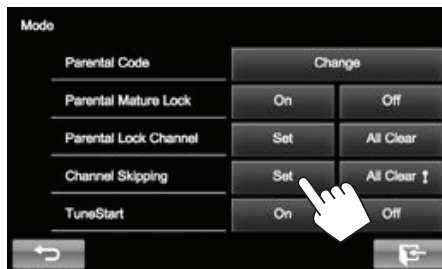
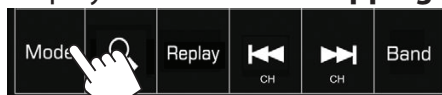

- 2 Select a category (①), and then select a channel you want to skip (②).

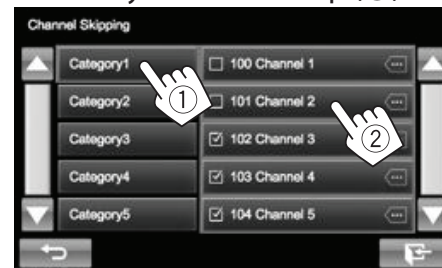

- You can change the page to display more items by pressing **[▲]**/**[▼]**. The indicator appears beside the selected channels.
- Repeat this step if you want to skip more channels.

Clearing the channel skipping for all skipped channels

On the <Mode> screen:

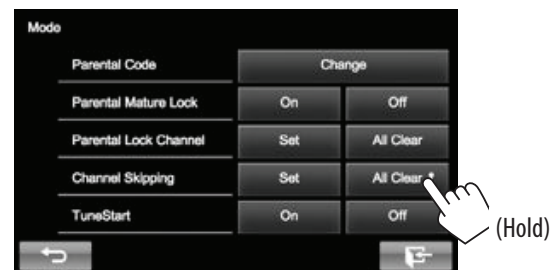

OTHER EXTERNAL COMPONENTS

Using external audio/video players—AV-IN

- When the operation buttons are not displayed on the screen, touch the area shown on the illustration.
 - To change settings for video playback, see page 45.

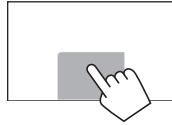

You can connect an external component to the AV-IN1 terminal. (Page 57)

Indications and buttons on the source control screen



Playback information

- AV-IN name

Operation buttons

- [Mode]** Changes the AV-IN name.
- Press [**◀**] or [**▶**] to select an AV-IN name.

Starting playback

- Connect an external component to the AV-IN1 terminal.
 - To connect an external component, see page 57.
- Select “AV-IN” as the source. On the Home screen:



- Turn on the connected component and start playing the source.

Using external audio players—Front AUX (Only for KW-V31BT)

Indications on the source control screen

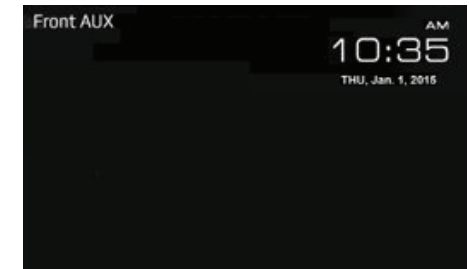

Starting playback

- Connect an external component to the AUX input jack on the monitor panel.
 - Use a 3.5 mm stereo mini plug (commercially available).

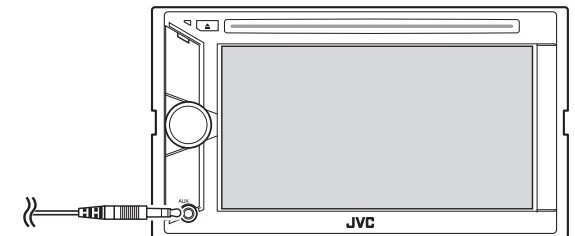

- Select “Front AUX” as the source. (Page 8)
- Turn on the connected component and start playing the source.

OTHER EXTERNAL COMPONENTS

Using a rear view camera

- To connect a rear view camera, see page 57.
- To use a rear view camera, a REVERSE lead connection is required. (Page 55)

❑ Activating the rear view camera

- 1 Display the <Input> setting screen.
On the Home screen:



2



To deactivate: Select [Off] for <Camera Input>.

❑ Displaying the picture from the rear view camera

The rear view screen is displayed when you shift the gear to the reverse (R) position.



- To erase the caution message, touch the screen.

To display the picture from the rear view camera manually

On the Home screen:

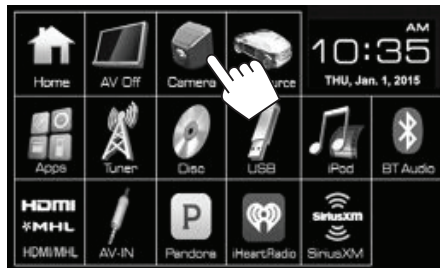

Adjusting the picture from the rear view camera

When displaying the picture from the rear view camera manually, you can change the setting of the picture.

- 1 Display the <Video Menu> screen.

KW-V51BT



KW-V31BT

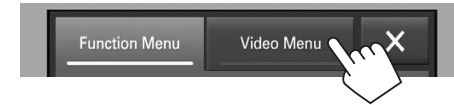

2



- [Aspect Ratio Icon] Selects the aspect ratio. (Page 46)
- [Picture Adjustment Icon] Displays the picture adjustment screen. (Page 45)

To exit the rear view screen

KW-V51BT



KW-V31BT



OTHER EXTERNAL COMPONENTS

Using a smartphone—HDMI/MHL

What is HDMI/MHL?

HDMI stands for High Definition Multi-media Interface. HDMI connections can transfer digital video source signals (such as from a DVD player) without converting them to analog.

A new feature that has been added to HDMI that extends its capabilities further is MHL, or Mobile High-definition Link.

Both interfaces allow your smartphone to connect to the device. When it is connected, you can see your smartphone's screen on the monitor.

Displaying the screen of the smartphone

You can display the screen of smartphones connected via the HDMI/MHL input terminal.

- 1 Connect your smartphone to the HDMI/MHL input terminal. (Page 57)
 - Use HDMI cable KS-U60 (optional accessory) or MHL cable KS-U61 (optional accessory).
- 2 Select **"HDMI/MHL"** as the source.

On the Home screen:



- 3 Start an application or playback on your smartphone.

Using an external monitor—Rear Source

You can enjoy the rear source playback on an external monitor connected to the AV-OUT VIDEO and AV-OUT AUDIO terminals, while listening to any source.

Displaying rear source images on the external monitor

- 1 Display the **<Rear Source>** screen.
On the Home screen:



- 2 Select the rear source.



- To close the **<Rear Source>** screen, press [X].

While activating rear source...

- To view a front source image on the rear monitor, press **[Same as Front]** on the **<Rear Source>** screen.
- If the selected source is not **"DISC"** or **"AV-IN"**, nothing appears on the rear monitor.

BLUETOOTH

Information for using Bluetooth® devices



Bluetooth is a short-range wireless radio communication technology for mobile devices such as mobile phones, portable PCs, and other devices. Bluetooth devices can be connected without cables and communicate with each other.

Notes

- While driving, do not perform complicated operations such as dialing numbers, using the phone book, etc. When you perform these operations, stop your car in a safe place.
- Some Bluetooth devices may not connect to this unit depending on the Bluetooth version of the device.
- This unit may not work for some Bluetooth devices.
- Connecting conditions may vary depending on your environment.
- For some Bluetooth devices, the device is disconnected when the unit is turned off.

Bluetooth Information: If you wish to receive more information about Bluetooth, visit the following JVC web site:
<<http://www.jvc.net/cs/car/>>

Bluetooth profile

This unit supports the following Bluetooth profiles:

- HFP (Hands-Free Profile) 1.6
- A2DP (Advanced Audio Distribution Profile) 1.2
- AVRCP (Audio/Video Remote Control Profile) 1.4
- GAP (Generic Access Profile)
- PBAP (Phone Book Access Profile) 1.0
- SDP (Service Discovery Profile)
- SPP (Serial Port Profile) 1.1
- HID (Human Interface Device Profile)

About mobile phones compatible with Phone book Access Profile (PBAP)

If your mobile phone supports PBAP, you can display the phone book and call lists on the touch panel screen when the mobile phone is connected.

- Phone book: up to 600 entries
- Dialed calls, received calls, and missed calls: up to 10 entries each

Connecting Bluetooth devices

❑ Registering a new Bluetooth device

When you connect a Bluetooth device to the unit for the first time, pair the unit and the device. Pairing allows Bluetooth devices to communicate with each other.

- The pairing method differs depending on the Bluetooth version of the device.
 - For devices with Bluetooth 2.1: You can pair the device and the unit using SSP (Secure Simple Pairing) which only requires confirmation.
 - For devices with Bluetooth 2.0: You need to enter a PIN code both on the device and unit for pairing.

- Once the connection is established, it is registered in the unit even if you reset the unit. Up to 5 devices can be registered in total.
- Two devices for Bluetooth phone and one for Bluetooth audio can be connected at a time.
- To use the Bluetooth function, you need to turn on the Bluetooth function of the device.
- To use the registered device, you need to connect the device to the unit. (Page 37)

Auto pairing

When <Auto Pairing> is set to [On], iOS devices (such as iPhone) are automatically paired when connected via USB. (Page 42)

Pairing a Bluetooth device using SSP (for Bluetooth 2.1)

When the Bluetooth device is compatible with Bluetooth 2.1, a pairing request is sent from an available device.

- 1 Search the unit (“JVC KW-V”) from your Bluetooth device.
- 2 Confirm the request both on the device and the unit.



- Press [Cancel] to reject the request.

Continued on the next page...

BLUETOOTH

Pairing a Bluetooth device from the target device using a PIN code (for Bluetooth 2.0)

1 Display the <Bluetooth Setup> screen.

On the Home screen:

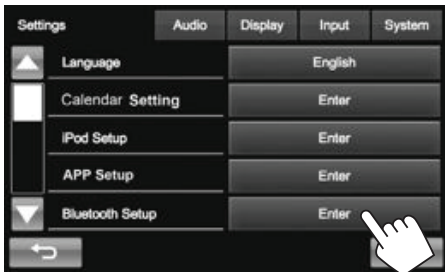

- You can also display the <Bluetooth Setup> screen by pressing [Phone Control] on the phone control screen. (Page 39)

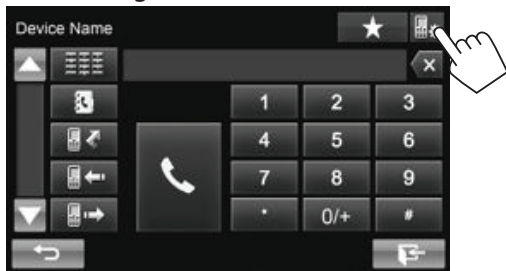

2 Change the PIN code.

- If you skip changing the PIN code, go to step 3.

- The PIN code is initially set to "0000".
- The maximum number of digits in the PIN code is 15.

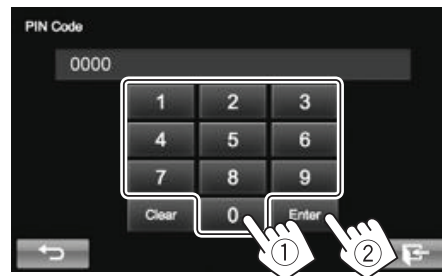

3 Search for the unit ("JVC KW-V") from your Bluetooth device.

- Press [Clear] to delete the last entry.

4 Select the unit ("JVC KW-V") for your Bluetooth device.

- If the PIN code is required, enter "0000" (initial).

When pairing is complete, the device is listed on <Paired Device List>.

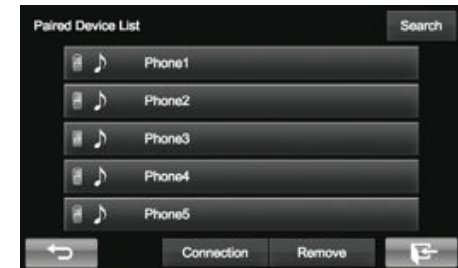

- To use the paired device, connect the device on <Paired Device List>. (Page 37)

BLUETOOTH

Pairing a Bluetooth device from this unit using a PIN code (for Bluetooth 2.0)

1 Display the <Bluetooth Setup> screen. (Page 36)

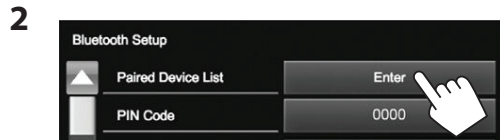

3 Search for the available devices.



- To cancel searching devices, press [**Cancel**].

4 Select the device you want to pair.

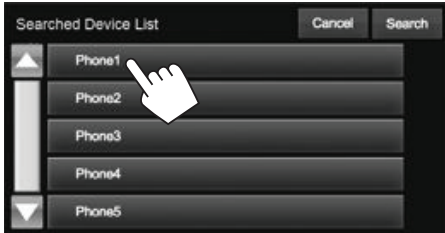

- If the PIN code is required, enter "0000" (initial).

Deleting a registered Bluetooth device

Two devices can be connected simultaneously.

1 Display the <Bluetooth Setup> screen. (Page 36)

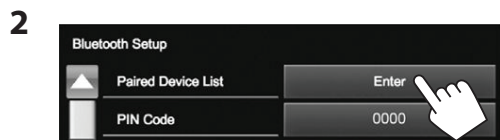

3 Select the device you want to connect (①), then press [**Connection**] (②).

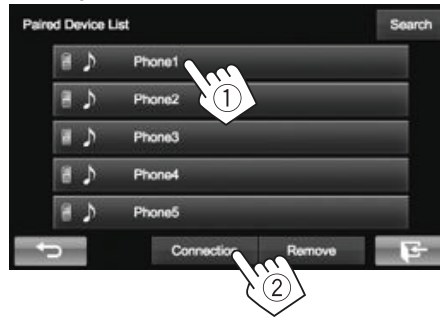

4 Select [**On**] or [**Off**] for the target.



📱: Mobile phone

🎵: Audio device

- The status is shown as follows:
 - “Connected”: A connection has been established.
 - “Connect Ready”: A connection can be established.
 - “Disconnected”: No connection is established.
- Press [**Change**] for <APP Setup> to display the <APP Settings> screen to configure settings for applications of iPod/iPhone/Android. (Page 43)

Deleting a registered Bluetooth device

1 Display the <Bluetooth Setup> screen. (Page 36)

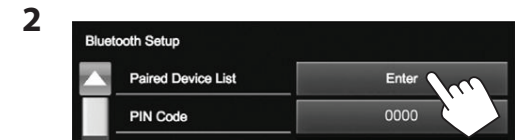

3 Select a device to delete (①), then press [**Remove**] (②).

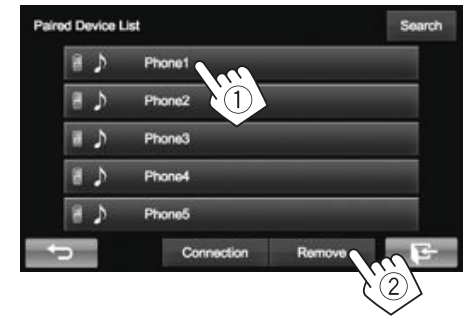

A confirmation message appears. Press [**Yes**].

BLUETOOTH

Using a Bluetooth mobile phone

❑ Receiving a call

When a call comes in...

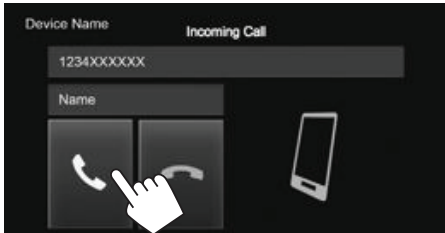

- Call information is displayed if acquired.
- Phone operation is not available while the picture from the rear view camera is displayed. (Page 33)

To reject a call

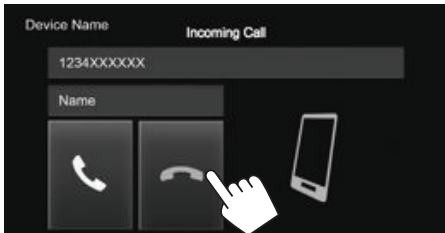

When <Auto Answer> is set to [On] (Page 42)
The unit answers incoming calls automatically.

❑ Ending a call

While talking...

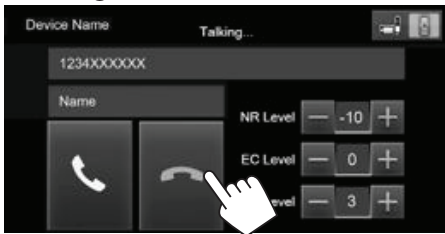

❑ Adjusting the volume of calls/earpiece/microphone

While talking...





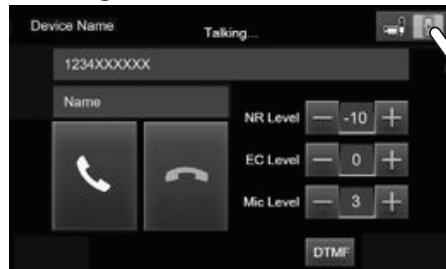

- You can adjust the volume level between 0 to 15 (initial: 3).
- Use the monitor panel to adjust the call/earpiece volume. (Page 6)

❑ Switching between handsfree mode and phone mode

While talking...



Each time you press the button, the talking method is switched (  : handsfree mode /   : phone mode).

❑ Reducing noise/adjusting the echo cancel level

While talking...



- **To adjust the noise reduction volume (between 0 to -20, initial: -10)** : Adjust <NR LEVEL>.
- **To adjust the echo volume (between -1 to +1, initial: 0)**: Adjust <EC LEVEL>.

BLUETOOTH

□ Sending text during a call

You can send text during a call using the DTMF (Dual Tone Multi Frequency) function.

While talking...

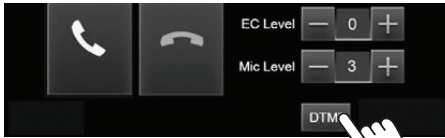

□ Switching between two connected devices

When two devices are connected, you can change the device to use.

On the phone control screen (see the right column):

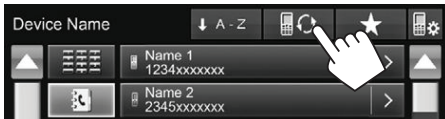

- The name of the active device appears. The devices are switched each time the button is pressed.

□ Making a call

- 1 Display the phone control screen. On the Home screen:



- You can also display the phone control screen by pressing [Phone] on the <Function Menu> screen. (Page 7)

- 2 Select a method to make a call.

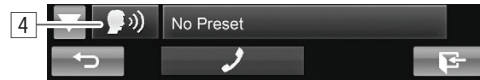

- You can display the <Bluetooth Setup> screen by pressing [Bluetooth Setup].

- 1 From the phone book*/call lists
- 2 Direct number entry
- 3 From the preset list
 - To preset, see page 41.
- 4 Voice dialing

* When the mobile phone is not compatible with Phone Book Access Profile (PBAP), the phone book is not displayed.

From the preset list/phone book/call lists

- 1



- [★] From the preset list
- [Phone Book] From the phone book
- [Missed Call] From the missed call list
- [Received Call] From the received call list
- [Dialed Call] From the dialed call list

- 2 Select the target (①), then make a call (②).



- You can change the page to display more items by pressing [▲]/[▼].

BLUETOOTH

- To use the A to Z search in the phone book:
When the phone book list is displayed, you can search by initial.

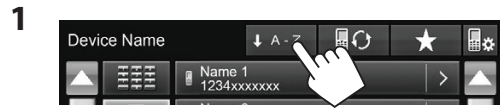

- 2 Select the initial.



- Press [**X**] to cancel the A to Z search.

- 3 Select a phone number from the list.



- To display other phone numbers:
When the phone book list is displayed, you can switch between phone numbers if several phone numbers are registered for the same person.

- 1 Switch the phone number.

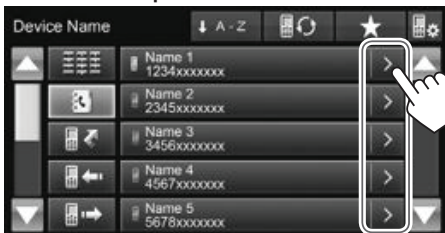

- The phone number switches each time [**>**] is pressed.
- 2 Select a phone number to call.



Direct number entry

You can enter up to 31 numbers.

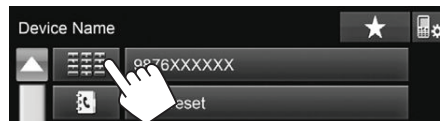

- Press [**X**] to delete the last entry.
- Press and hold [**0/+**] to add "+" to the phone number.

Voice dialing

- Available only when the connected mobile phone has a voice recognition system.

- 1 Activate voice dialing.

On the phone control screen:

- Press [**▼**] repeatedly to change the page on the phone control screen.

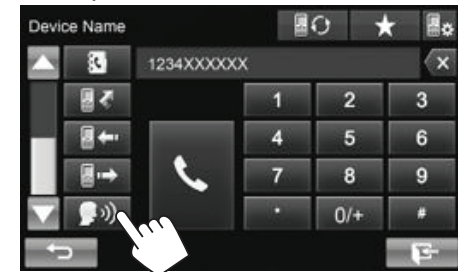

- You can also activate voice dialing by pressing [**🗨️**] on the **<Function Menu>** screen (Page 7) or holding FNC/**🗨️** on the monitor panel.

- 2 Say the name of the person you want to call.

- If the unit cannot find the target, the following screen appears. Press [**Start**], then say the name again.

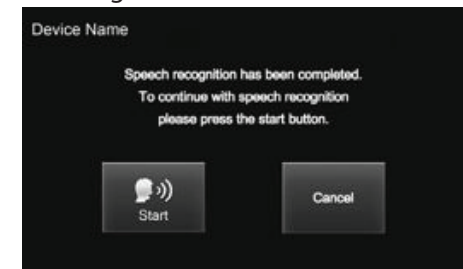

To cancel voice dialing: Press [**Cancel**].

BLUETOOTH

❑ Presetting phone numbers

You can preset up to 5 phone numbers.

- 1 Display the phone control screen.
(Page 39)
- 2 Enter the numbers on the direct number entry screen, then display the preset list.

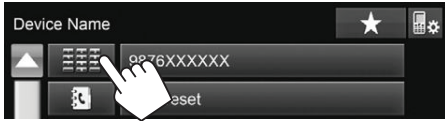

- 3 Select a preset number to store into.



- To display the preset list, press [★] on the phone control screen.

Using the Bluetooth audio player

- To register a new device, see page 35.
- To connect/disconnect a device, see page 37.

❑ Indications and buttons on the source control screen

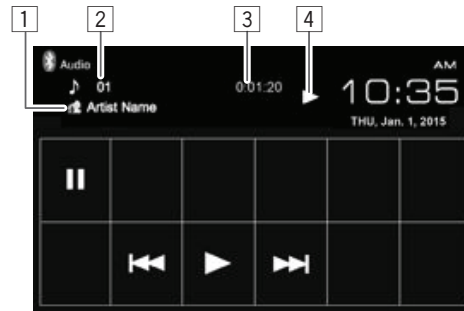

- The operation buttons, indications and information displayed on the screen differ depending on the connected device.

Playback information

- 1 Tag data (current track title/artist name/album title)*¹
 - Touching the text information changes the information type.
- 2 Track no.*¹
- 3 Playing time*¹
- 4 Playback status*¹

Operation buttons

- [↺]*¹ *² *³ Selects repeat playback mode.
- [↻]*¹ *² *³ Selects random playback mode.
- [⏸] Pauses playback.
- [▶] Starts playback.
- [◀◀] [▶▶]
 - Selects a track. (Press)
 - Reverse/forward search. (Hold)

*¹ Available only for devices compatible with AVRCP 1.3.

*² To cancel random and repeat mode, press the button repeatedly until the indicator disappears.

*³ Press FNC/[🎤] on the monitor panel to display the <Function Menu> screen to select the item. (Page 7)

BLUETOOTH

Settings for Bluetooth devices

You can change various settings for using Bluetooth devices on the <Bluetooth Setup> screen.

- 1 Display the <Bluetooth Setup> screen.
On the Home screen:

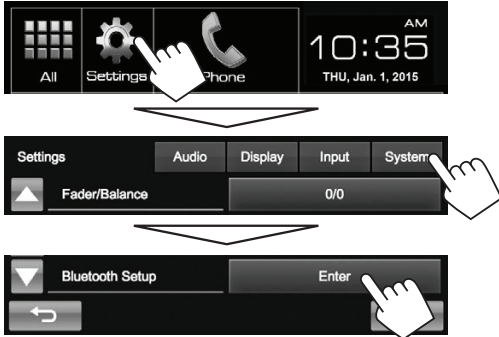

- You can also display the <Bluetooth Setup> screen by pressing [Settings] on the phone control screen. (Page 39)



- 2 Configure the Bluetooth settings.



Setting items

<Paired Device List>	Press [Enter] to show the list of registered devices. You can connect a device or delete registered devices. (Page 37)
<PIN Code>	Changes the PIN code of the unit. (Page 36)
<Device Name>	Shows the device name to be shown on the Bluetooth device—JVC KW-V.
<Device Address>	Shows the MAC address of the unit.
<Auto Connect>	<ul style="list-style-type: none"> • On (Initial): A connection is automatically established with the last connected Bluetooth device when the unit is turned on. • Off: Cancels.
<HF/Audio Output>	Select the speakers used for Bluetooth (both phone and audio player). <ul style="list-style-type: none"> • Front: Front speakers only. • All (Initial): All speakers.
<Auto Answer>	<ul style="list-style-type: none"> • On: The unit answers the incoming calls automatically after 5 seconds. • Off (Initial): The unit does not answer the calls automatically. Answer the calls manually.

<Auto Pairing>	<ul style="list-style-type: none"> • On (Initial): Establishes pairing automatically with the connected iOS device (such as iPhone) even if the Bluetooth function is deactivated on the device. (Auto pairing may not work for some devices depending on the iOS version.) • Off: Cancels.
<Ring Mode>	<ul style="list-style-type: none"> • System (Initial): The ring tone set on the unit is used. • Phone: The ring tone set on the mobile phone is used. (This function may not work depending on the mobile phone.)
<Ring Tone Change>	When <Ring Mode> is set to <System>, select the ring tone for received calls from [Tone1] (Initial), [Tone2], [Tone3].
<Initialize>	Hold [Enter] to reset all settings you have made for using Bluetooth mobile phones and Bluetooth audio players.

SETTINGS

Settings for using applications of iPod/iPhone/Android

Before using applications of iPod/iPhone/Android such as Pandora and iHeartRADIO, select the device to use and connection method.

1 Pair the iPod/iPhone/Android device through Bluetooth. (Page 35)

2 Display the **<APP Setup>** screen. On the Home screen:

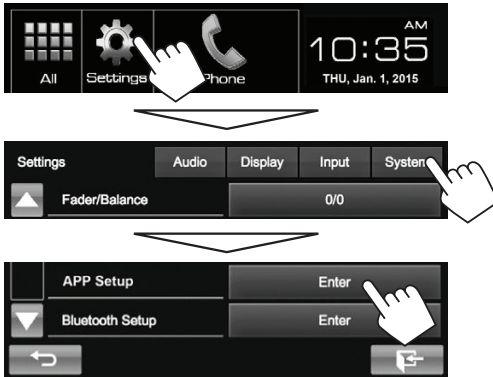

- If **[Enter]** for **<APP Setup>** cannot be selected, turn off the AV source. (Page 6)



4 Check the current device status, then press **[Change]**.

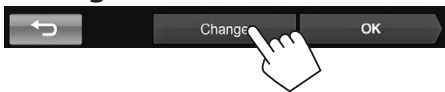

- If you do not need to change the setting, press **[OK]** to exit from the setup screen.

5 Select the device type (①), then press **[Next]** (②).



6 Select the connection method (①), then press **[Next]** (②).



For Android:

<HDMI/MHL + Bluetooth> Select this when the Android is connected both by cable to the HDMI/MHL input terminal and via Bluetooth.

<Bluetooth> Select this when the device is connected via Bluetooth.

For iPod/iPhone:

<USB + AV-IN> Select this when the iPod/iPhone is connected using KS-U59 (optional accessory).

<USB 1 Wire> Select this when the iPod/iPhone is connected using USB 2.0 cable (accessory of the iPod/iPhone) or KS-U62 (optional accessory).

<HDMI + Bluetooth>

Select this when the iPod/iPhone is connected using HDMI cable KS-U60 (optional accessory) and USB 2.0 cable (accessory of the iPod/iPhone)/KS-U62 (optional accessory) through a Lightning-Digital AV adapter (accessory of the iPod/iPhone).

<Bluetooth>

Select this when the iPod/iPhone is connected via Bluetooth.

- When selecting **<USB + AV-IN>** or **<USB 1 Wire>**, go to step 8.

7 When selecting **<HDMI + Bluetooth>** or **<Bluetooth>** as the connection method, paired device list appears. Select the target device.

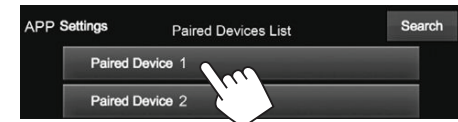

- If desired device is not listed, press **[Search]** for searching the available iPod/iPhone/Android devices, then select the target device from the **<Available Devices>** screen.

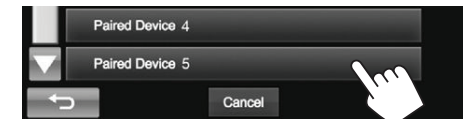

- You can change the page to display more items by pressing **[▲]/[▼]**.
- To stop searching, press **[Cancel]**.

8 Confirm the settings.



SETTINGS

Sound adjustment

Using the sound equalization

- The adjustment is memorized for each source until you adjust the sound again. If the source is a disc, the adjustment is stored for each of the following categories.
 - DVD/DVD-VR/VCD
 - CD
 - DivX/MPEG1/MPEG2/MP3/WMA/AAC
- You cannot adjust the sound when the AV source is turned off.

Selecting a preset sound mode

- 1 Display the **<Equalizer>** screen.

On the Home screen:

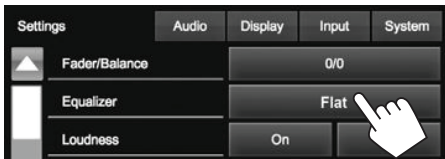

- You can also display the **<Equalizer>** screen by pressing [F1] on the **<Function Menu>** screen. (Page 7)

- 2 Select a sound mode.



- You can change the page to display more items by pressing [▲]/[▼].

Storing your own adjustment—Customizing preset sound mode

- 1 Select a sound mode. (See the left column.)
- 2 Adjust the level of each band (①), then select the subwoofer level (②).

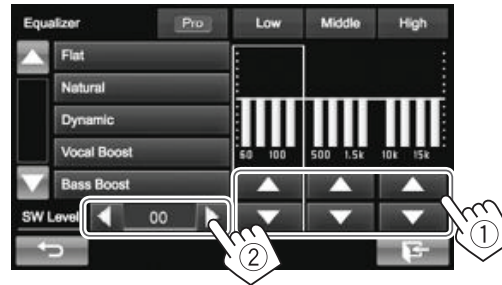

The adjustments are stored and **<User>** is activated.

- To finish the procedure, press [F2].

Storing your own adjustment—Adjusting the sound precisely

- 1 Select a sound mode. (See the left column.)
- 2 Display the adjustment screen.
- 3 Select a band.

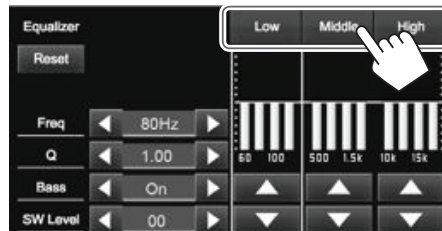

- 4 Adjust the sound.

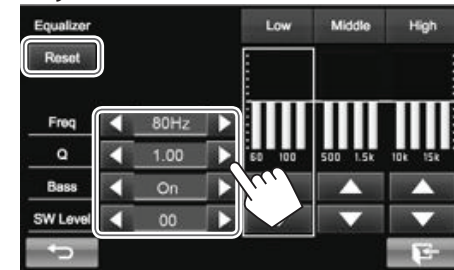

- [Reset]** Changes the level of each band to 0.
- <Freq>** Selects frequency.
- <Q>** Adjusts the width of the frequency.*1
- <Bass>** Activates/deactivates bass.*2
- <SW Level>** Adjusts subwoofer level.

The adjustments are overwritten if the **<User>** setting has been created (see the left column), and **<User>** is activated.

- To finish the procedure, press [F2].

- The adjustments are memorized until you adjust sound again.
- To make adjustment for other bands, repeat steps **3** and **4**.

*1 Fixed for "High" band.

*2 Only for "Low" band.

SETTINGS

Adjusting the crossover frequency

- 1 Display the <Crossover> screen.
On the Home screen:

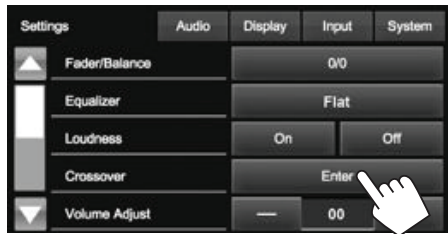

- 2 Select the item to adjust (①), then make adjustments (②).

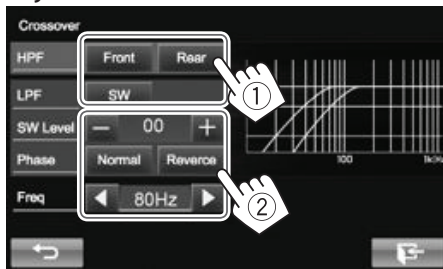

- <HPF> Adjusts the crossover for the front ([Front]) or rear ([Rear]) speakers (high pass filter).
- <LPF> Adjusts the crossover for the subwoofer (low pass filter).
- <SW Level> Adjusts the subwoofer level.
- <Phase> Selects the phase for the subwoofer.*
- <Freq> Adjusts the crossover frequency.

* Not selectable when <Freq> is set to <Through>.

Adjustment for video playback

Adjusting the picture

You can adjust the picture quality.

- 1 Display the <Video Menu> screen.

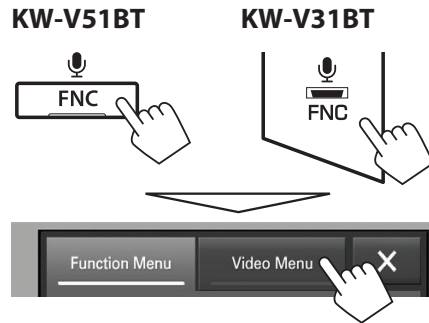

- 2 Display the adjustment menu.



- 3 Select [☾] (dimmer on) or [☀] (dimmer off).



- 4 Adjust the picture.



- <Brightness> Adjusts the brightness. (-15 to +15)
- <Contrast> Adjusts the contrast. (-10 to +10)
- <Black> Adjusts the blackness. (-10 to +10)
- <Color> Adjusts the color. (-10 to +10)
- <Tint> Adjusts the tint. (-10 to +10)
- <Detail> Adjusts the detail. (-2 to +2)

SETTINGS

❑ Changing the aspect ratio

You can change the aspect ratio for video playback.

- You cannot change the aspect ratio while playing USB device.

1 Display the <Video Menu> screen.

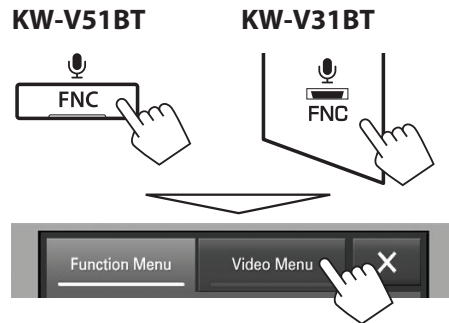

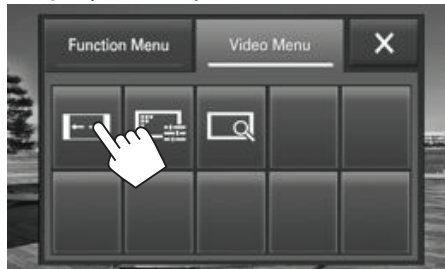

2 Display the adjustment menu.



3 Select the aspect ratio.

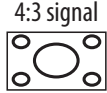
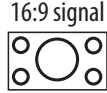

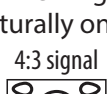
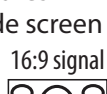
- <Full>*** For 16:9 original pictures
 4:3 signal  16:9 signal 
- <Regular>*** For 4:3 original pictures
 4:3 signal  16:9 signal 
- <Panorama>** For viewing 4:3 pictures naturally on the wide screen
 4:3 signal  16:9 signal 
- <Zoom1> –** Changes the magnification.
<Zoom3> • The aspect ratio is automatically selected to match the video source.

* While DivX is played back with <Monitor Type> set to [16:9] (Page 13), the aspect ratio may not set correctly.

❑ Zooming the picture

You can zoom the picture (<Full>, <Zoom1> to <Zoom3>). Zooming is available only when discs are played back.

- When aspect ratio is set to <Panorama> (see the left column), the picture is zoomed with the aspect ratio of the <Full> setting.

1 Display the <Video Menu> screen.

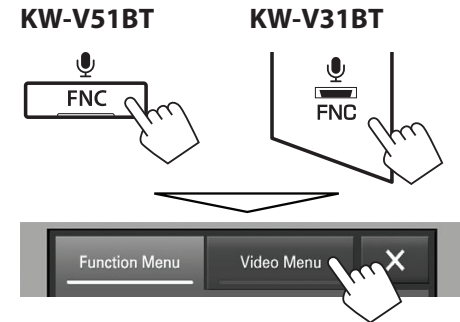

2 Display the adjustment menu.



3 Change the magnification (①), then move the zooming frame (②).



- [▲][▼][◀][▶] are not displayed when <Full> is selected.
- The zoom function cannot be used for some video sources.

SETTINGS

Changing the display design

You can change the background and panel color.

- 1 Display the <Display Design> screen.
On the Home screen:

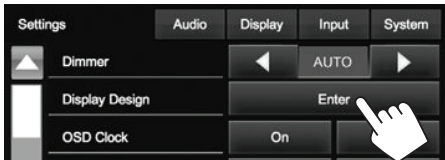
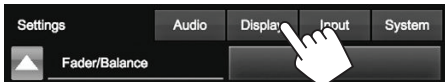

- 2 Select an item to change (①), select the dimmer setting ([☾]: dimmer on or [☀]: dimmer off) (②), then select the design or color (③).

To change the background design:

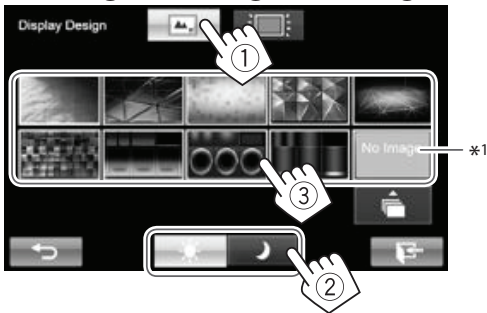

To change the panel color:

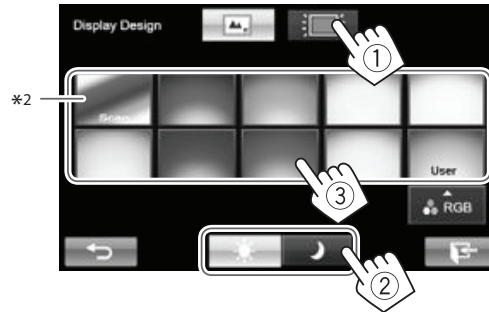

- You can also adjust the color by yourself. Press [RGB] to display the color adjuster screen, then adjust the color.

- *1 Store your own scene beforehand. (See below.)
- *2 Selecting this changes the illumination color gradually.

❑ Storing your favorite image for the background

You can set your favorite image stored on the connected USB device.

- Use a JPEG/PNG/BMP file with a resolution of 800 x 480 pixels.
- The color of the captured image may look different from that of the actual scene.

- 1 Connect the USB device on which the image is stored. (Page 56)
- 2 Display the <Display Design> screen. (See the left column.)

- 3 Display the file selection screen.

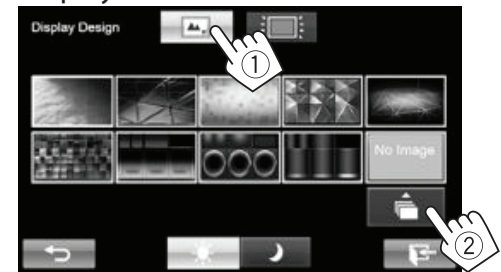

- 4 Select the file for the background image (①), then confirm the selection (②).



- You can change the page to display more items by pressing [▲]/[▼].
- Press [↶] to return to the root folder.
- Press [↷] to return to the upper layer.

- 5 Confirm the selection.



The existing image is replaced with the new one.

- Press [No] to return to the previous screen.

SETTINGS

Customizing the Home screen

You can arrange the items to display on the Home screen.

- 1 Display the **<Menu Customize>** screen.
On the Home screen:
Press and hold the icon you want to replace.



- 2 Select the item you want to display in the position selected in step 1 (①), then press **[HOME]** (②).

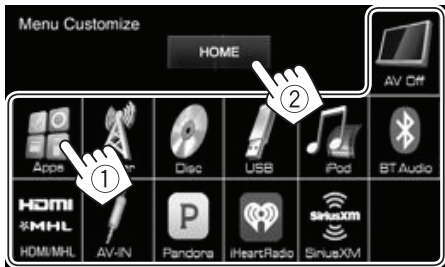

- Only selectable sources are shown.
- Repeat the procedure to place icons for other items.

Customizing the system settings

Memorizing/recalling the settings

You can memorize the following settings:

- Settings on the **<Settings>** screen: **Fader/Balance, Equalizer, Loudness, Crossover (<HPF>/<LPF>/<SW Level> settings), Volume Adjust, Speaker Select, Display Design**
- Settings for "AV-IN": **AV-IN Name**

On the Home screen:

- Press **[▼]** repeatedly to change the page on the **<System>** menu screen.

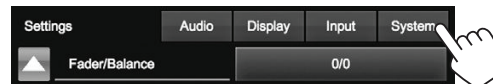

- [Recall]** Recalls saved settings.
 - [Save]** Memorizes current settings.
 - [Delete]** Deletes the memorized settings.
- A confirmation message appears. Press **[Yes]**.

Adjusting the touch position

You can adjust the touch position on the touch panel if the position touched and the operation performed do not match.

- 1 Display the **<Touch Panel Adjust>** screen.

On the Home screen:

- Press **[▼]** repeatedly to change the page on the **<System>** menu screen.

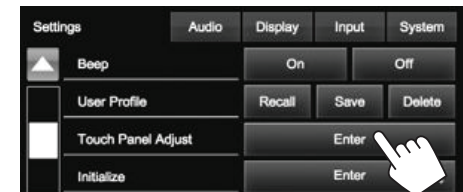
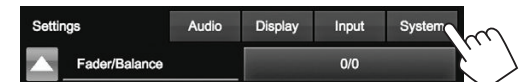

- 2 Touch the center of the marks at the lower left and at the upper right as instructed.

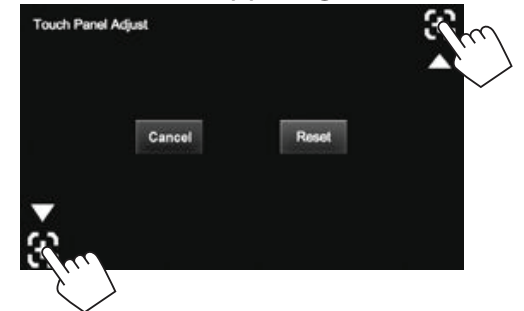

- To reset the touch position, press **[Reset]**.
- To cancel the current operation, press **[Cancel]**.

SETTINGS

Updating the system

You can update the system by connecting a USB device containing an update file.

- To update the system, visit <<http://www.jvc.net/cs/car/>>.

- Create an update file, copy it to a USB device, and connect it to the unit.
 - To connect a USB device, see page 56.
- Display the <**System Information**> screen.

On the Home screen:

- Press [▼] repeatedly to change the page on the <**System**> menu screen.

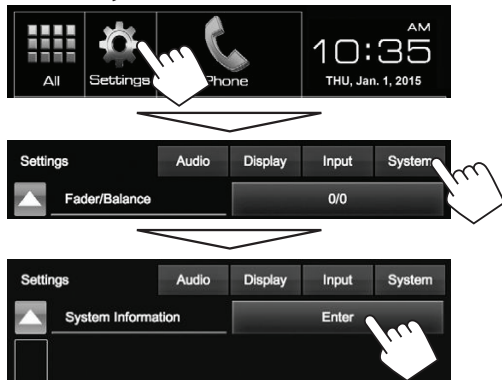

3



<**Application Version**>

Updates the system application.

<**System Version**>

Updates the system.

<**Bluetooth Version**>

Updates the Bluetooth application.

It may take a while.

If the update has been completed successfully, "Update Completed" appears. Reset the unit.

- To finish the procedure, press [↵].
- Do not disconnect the USB device while updating.
- If the update has failed, turn the power off and then on, and retry the update.
- Even if you have turned off the power during the update, you can restart the update after the power is turned on. The update will be performed from the beginning.

Setting menu items

Displaying the <Settings> menu screen



<Audio> setting screen

<Fader/Balance>

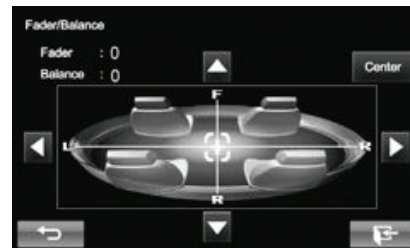

Fader: Adjust the front and rear speaker output balance.

- F6 to R6** (Initial: **0**)
 - When using a two-speaker system, set the fader to the center (**0**).

Balance: Adjust the left and right speaker output balance.

- L6 to R6** (Initial: **0**)
 - Press [▲]/[▼]/[◀]/[▶] or drag [⊕] to adjust.
 - To clear the adjustment, press [**Center**].

<Equalizer>

Change the sound mode or adjust and store the equalization for each source. (Page 44)

- Flat** (Initial)/**Natural/Dynamic/Vocal Boost/Bass Boost/Vibrant/User**

<Loudness>

You can activate/deactivate loudness.

- On** (Initial): Boost low and high frequencies to produce a well-balanced sound at a low volume level.
- Off:** Cancels.

<Crossover>

Adjust the crossover frequency. (Page 45)

<Volume Adjust>

Adjust and store the auto-adjustment volume level for each source. (For discs, the adjustment is stored for each of the following categories: DVD/DVD-VR/VCD, CD, and DivX/MPEG1/MPEG2/MP3/WMA/WMV/AAC.) The volume level will automatically increase or decrease when you change the source.

- 15 to +06** (Initial: **00**)

<Speaker Select>

Select the size of the connected speaker.

- Standard** (Initial)/**Narrow/Middle/Wide**

SETTINGS

☐ <Display> setting screen

- You can also display <Display> setting screen by pressing [] on the <Function Menu> screen. (Page 7)

<Dimmer>

- **AUTO** (Initial): Dims the screen and button illumination when you turn on the headlights.
 - The ILLUMI lead connection is required. (Page 55)
- **ON**: Activates dimmer.
- **OFF**: Cancels.

<Display Design>

Change the display design (background and panel color). (Page 47)

<OSD Clock>

- **On**: Displays the clock while a video source is played back.
- **Off** (Initial): Cancels.

<Demonstration>



- **On** (Initial): Activates the demonstration on the screen.
- **Off**: Cancels.

<Scroll>

- **Auto**: Repeats scrolling.
- **Once** (Initial): Scrolls the displayed information once.
- **Off**: Cancels.

Touching the information bar scrolls the text regardless of this setting.

<GUI Adjust>

Adjust the brightness and blackness of the screen. Press [**Enter**] to display the setting screen, select [] (dimmer on)/[] (dimmer off), then change the following settings:

- **Brightness**: Adjusts brightness.
 - **-15 to +15** (Initial: **0** for dimmer on/+**15** for dimmer off)
- **Black**: Adjusts blackness.
 - **-10 to +10** (Initial: **0**)

☐ <Input> setting screen

<Camera Input>

- **On** (Initial): Displays the picture from the rear view camera when you shift the gear to the reverse (R) position.
- **Off**: Select this when no camera is connected.

☐ <System> setting screen

<Language>

Select the text language used for on-screen information.

- **English** (Initial)/**Español/Français/Deutsch/Italiano/Nederlands/Português/Türkçe/Русский/עברית/فارسی/العربية/ภาษาไทย/简体中文/繁體中文/Bahasa Malaysia/Bahasa Indonesia**
- **GUI Language**: Select the language used for displaying operation buttons and menu items.
 - **English** (Initial)/**Local** (the language selected above)

<Calendar Setting>

Adjust the calendar/clock time. (Page 4)

<iPod Setup>

Configure the settings of iPod. (Page 16)

<APP Setup>

- **APP Connection Setup**: Configure the Apps settings. (Page 43)
- **APP Interrupt Volume**: Adjust the App volume.
 - **0 to 35** (Initial: **17**)

<Bluetooth Setup>

Configure settings for using a Bluetooth device, such as connection and other general operations. (Page 42)

<Beep>

- **On** (Initial): Activates the key-touch tone.
- **Off**: Cancels.

<User Profile>

You can memorize, recall, or clear the settings you have made. (Page 48)

<Touch Panel Adjust>

Adjust the touch position of the buttons on the screen. (Page 48)

<Initialize>

Initialize all settings you have made. Hold [**Enter**] to initialize the settings.

- After initializing the settings, adjust the settings on the <Initial Settings> screen. (Page 4)

<DivX® VOD>*

This unit has its own Registration Code. Once you have played back a file with the Registration Code recorded, this unit's Registration Code is overwritten for copyright protection.

- Press [**Enter**] to display the information.
- To return to the previous screen, press [**OK**].

<System Information>

Displays the version information of the software. You can update the software. (Page 49)

* Only for KW-V51BT Region 4/KW-V31BT Region 4.

REMOTE CONTROLLER

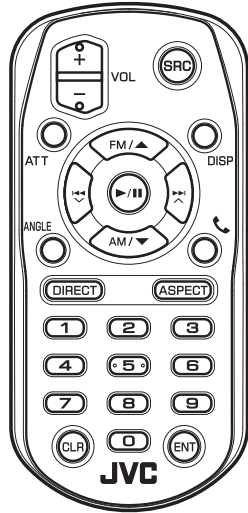

□ Changing the battery of the remote controller

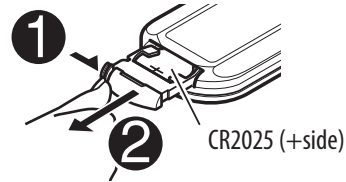

- Use a commercially available button battery (CR2025).
- Insert the battery with the + and – poles aligned properly.
 - If the effectiveness of the remote controller decreases, replace the battery.

⚠ Caution:

- Keep the battery out of reach of children and in original package until ready to use. Dispose of used batteries promptly. If swallowed contact physician immediately.
- Do not leave the battery near fire or under direct sunlight. A fire, explosion or excessive heat generation may result.
- Do not set the remote control in hot places such as on the dashboard.
- Danger of explosion if Lithium battery is incorrectly replaced. Replace only with the same or equivalent type.

Before using the remote controller:

- Aim the remote controller directly at the remote sensor on the unit.
- DO NOT expose the remote sensor to bright light (direct sunlight or artificial lighting).

Preparation

□ Removing the battery sheet

Pull the battery sheet out from the remote controller to activate the battery.

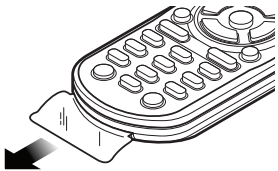



CALIFORNIA, USA ONLY

This product contains a CR Coin Cell Lithium Battery which contains Perchlorate Material — special handling may apply. See www.dtsc.ca.gov/hazardouswaste/perchlorate

REMOTE CONTROLLER

Operations using the remote controller (RM-RK258)

Basic button functions

ATT	Attenuates/restores the sound.
DISP	Switches the screen between the current source and the App screen from the connected iPod touch/iPhone/Android.
FM/▲ / AM/▼	<ul style="list-style-type: none"> • Selects the band. • Selects a title/item/folder.
	<ul style="list-style-type: none"> • Tuner: <ul style="list-style-type: none"> – Searches for stations automatically. – Searches for stations manually. (Hold) • SiriusXM Satellite Radio*¹: <ul style="list-style-type: none"> – Selects a channel. – Selects a channel rapidly. (Hold) • Selects a track. • Reverse search/forward search. (Hold)
VOL +/ VOL –	Adjusts the volume level.
SRC	Selects the source.
	Starts/pauses* ² playback.
	Answers incoming calls.
0 – 9	Enters a number. (See the far right column.)

1 – 6	Enters preset station number.
ANGLE	Tilts the monitor panel.* ³
ASPECT	Changes the aspect ratio. <ul style="list-style-type: none"> • To check the current aspect ratio setting, operate on the touch panel. (Page 46)
ENT	Confirms selection.
DIRECT	Enters direct search mode. (See the right column.)
CLR	Erases the misentry.

*¹ Only for KW-V51BT Region 1/KW-V31BT Region 1.

*² Does not work while listening to Bluetooth audio.

*³ Available for KW-V51BT only.

Searching for an item directly

Tuner frequency

- 1 Press DIRECT to enter the search mode.
- 2 Press number buttons to enter a frequency.
 - To erase a misentry, press CLR (clear).
- 3 Press  to confirm the entry.

Chapter/title/folder/file/track on the disc

- 1 Press DIRECT to enter the search mode.
 - Each time you press DIRECT, the item to search for changes.
- 2 Press a number button to select a desired item.
 - To erase a misentry, press CLR (clear).
- 3 Press ENT to confirm the selection.

Disc operations

Using the VCD menu

During PBC playback...

- 1 Press DIRECT to enter the search mode.
- 2 Press a number button to select the item you want to play.
- 3 Press ENT to confirm the selection.

CONNECTION/INSTALLATION

Before installing the unit

⚠ WARNING

- If you connect the ignition wire (red) and the battery wire (yellow) to the car chassis (ground), you may cause a short circuit, that in turn may start a fire. Always connect those wires to the power source running through the fuse box.
- Do not cut out the fuse from the ignition wire (red) and the battery wire (yellow). The power supply must be connected to the wires via the fuse.

⚠ Precautions on installation and connection

- Mounting and wiring this product requires skills and experience. For best safety, leave the mounting and wiring work to professionals.
- Make sure to ground the unit to a negative 12 V DC power supply.
- Do not install the unit in a spot exposed to direct sunlight or excessive heat or humidity. Also avoid places with too much dust or the possibility of water splashing.
- Do not use your own screws. Use only the screws provided. If you use the wrong screws, you could damage the unit.
- If the power is not turned on ("MISWIRING Check wiring connection then reset unit", "WARNING Check wiring connection then reset unit" is displayed), the speaker wire may have a short circuit or have touched the chassis of the vehicle and the protection function may have been activated. Therefore, the speaker wire should be checked.

- If your car's ignition does not have an ACC position, connect the ignition wires to a power source that can be turned on and off with the ignition key. If you connect the ignition wire to a power source with a constant voltage supply, such as with battery wires, the battery may be drained.
- Only for KW-V51BT:
If the console has a lid, make sure to install the unit so that the monitor panel will not hit the lid when closing and opening.
- If the fuse blows, first make sure the wires are not touching to cause a short circuit, then replace the old fuse with one with the same rating.
- Insulate unconnected wires with vinyl tape or other similar material. To prevent a short circuit, do not remove the caps on the ends of the unconnected wires or the terminals.
- Connect the speaker wires correctly to the terminals to which they correspond. The unit may be damaged or fail to work if you share the ⊖ wires or ground them to any metal part in the car.
- When only two speakers are being connected to the system, connect both connectors either to the front output terminals or to the rear output terminals (do not mix front and rear). For example, if you connect the ⊕ connector of the left speaker to a front output terminal, do not connect the ⊖ connector to a rear output terminal.
- After the unit is installed, check whether the brake lamps, blinkers, wipers, etc. on the car are working properly.
- Mount the unit so that the mounting angle is 30° or less.
- Do not press hard on the panel surface when installing the unit in the vehicle. Otherwise scratches, damage, or failure may result.

- This unit has a cooling fan to decrease the internal temperature. Do not mount the unit in a place where the cooling fan of the unit is blocked. Blocking these openings will prevent the cooling of the internal temperature and result in malfunction.

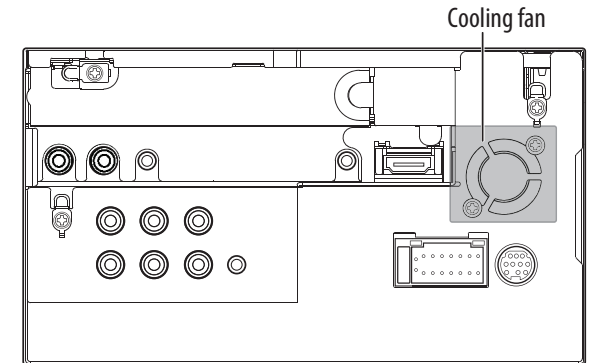

⚠ CAUTION

Install this unit in the console of your vehicle. Do not touch the metal part of this unit during and shortly after the use of the unit. Metal parts such as the heat sink and enclosure become hot.

□ Supplied accessories for installation

- ① Wiring harness x 1
- ② Trim plate x 1 *
- ③ Extension wire (2 m) x 1
- ④ Extraction keys x 2 *
- ⑤ Flat head screws (M5 x 7 mm) x 6
- ⑥ Round head screws (M5 x 6 mm) x 6
- ⑦ Microphone (3 m) x 1
- ⑧ Fixture for HDMI/MHL connector x 1
- ⑨ Screws for fixture (M2.6 x 6 mm) x 1

* Only for KW-V51BT Region 4/KW-V31BT Region 4

CONNECTION/INSTALLATION

❑ Installation procedure

- 1 To prevent a short circuit, remove the key from the ignition and disconnect the ⊖ battery.
- 2 Make the proper input and output wire connections for each unit.
- 3 Connect the speaker wires of the wiring harness.
- 4 Connect the wiring harness wires in the following order: ground, battery, ignition.
- 5 Connect the wiring harness connector to the unit.
- 6 Install the unit in your car.
- 7 Reconnect the ⊖ battery.
- 8 Press the reset button.
- 9 Configure <Initial Setup>. (Page 4)

Installing the unit

❑ Installing the unit (only for KW-V51BT Region 4/KW-V31BT Region 4)

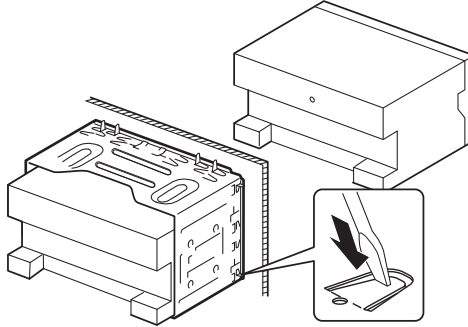

- Bend the tabs of the mounting sleeve with a screwdriver or similar utensil and attach it in place.

❑ When installing the unit using the mounting bracket removed from the car

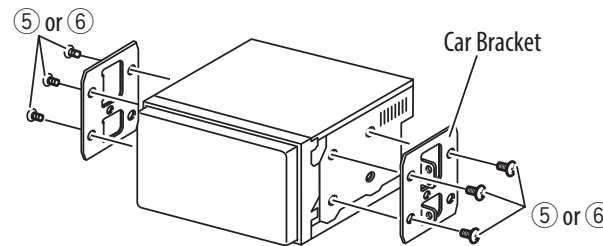

- Select the appropriate type of screw for the mounting bracket: flat head (5) or round head (6).

❑ Installing the trim plate (only for KW-V51BT Region 4/KW-V31BT Region 4)

- 1 Attach the trim plate (2).

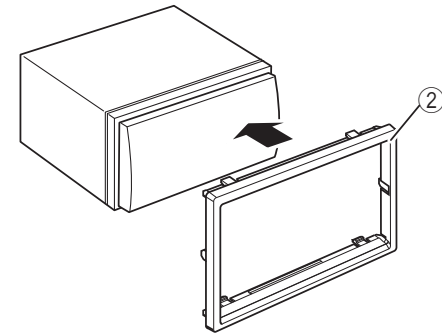

CONNECTION/INSTALLATION

Connection

Connecting wires to terminals

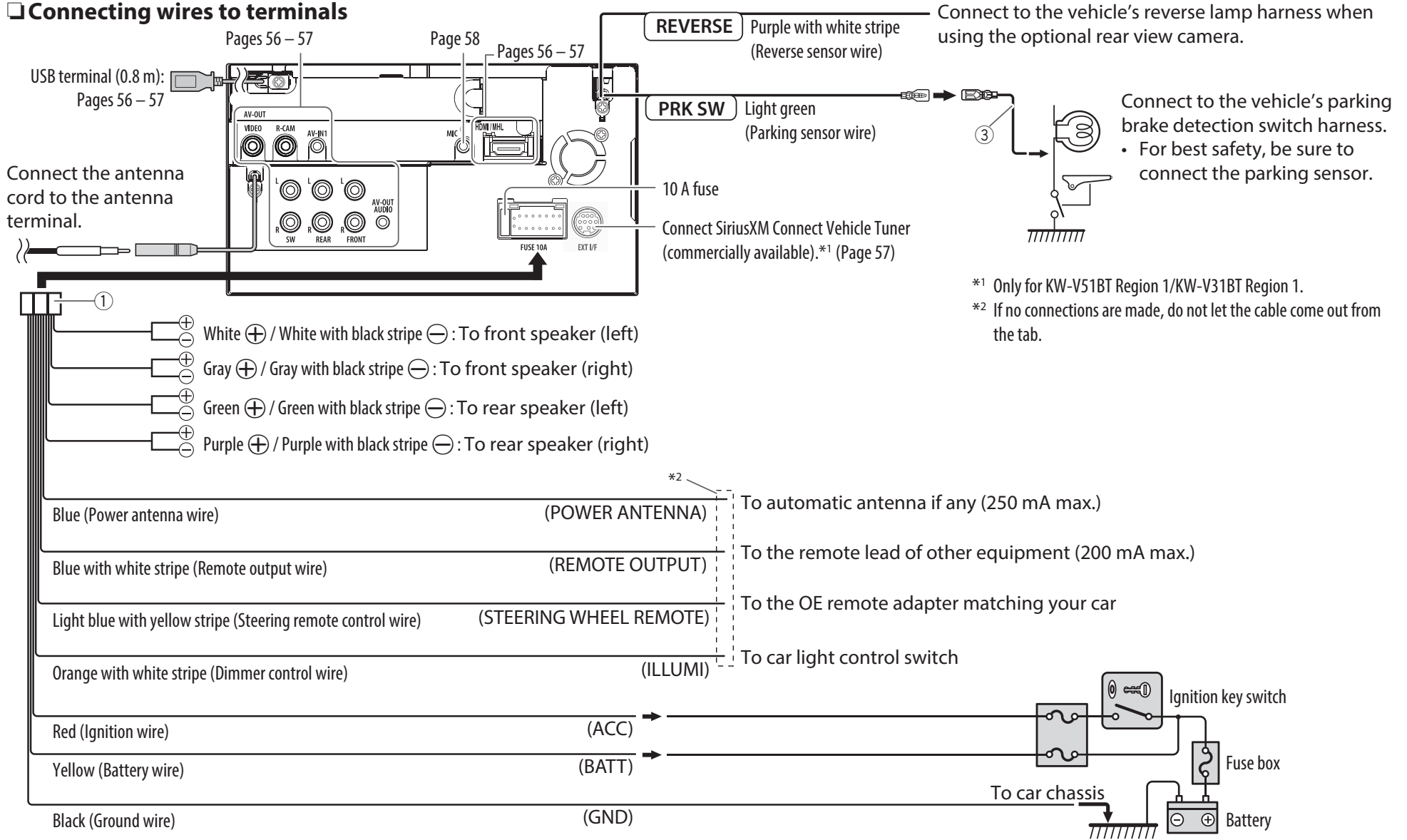

CONNECTION/INSTALLATION

Connecting a USB device

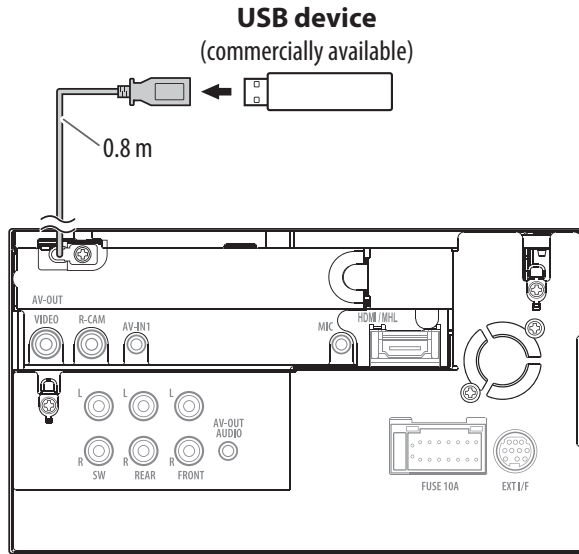

Connecting an iPod/iPhone

iPod/iPhone except for iPod nano (7th Generation)/iPod touch (5th Generation)/iPhone 5S/iPhone 5C/iPhone 5 (commercially available)

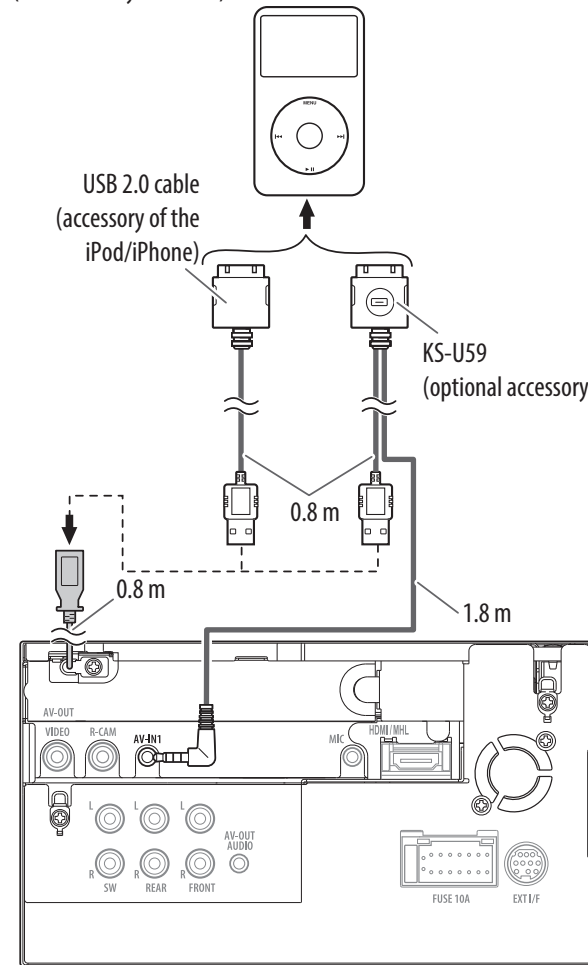

iPod nano (7th Generation)/iPod touch (5th Generation)/iPhone 5S/iPhone 5C/iPhone 5 (commercially available)

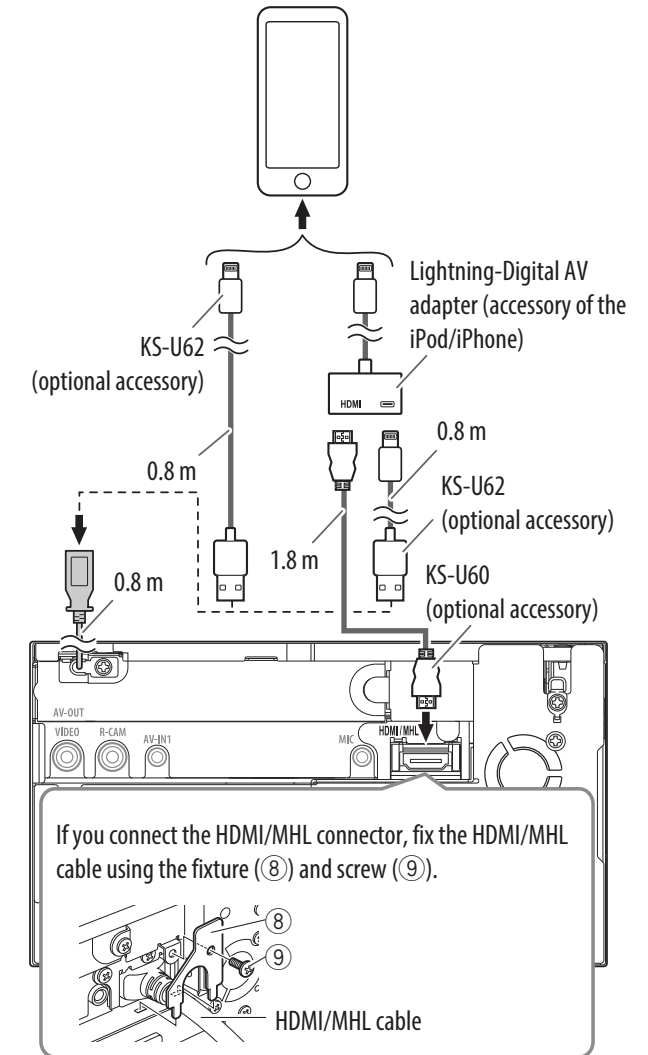

CONNECTION/INSTALLATION

Connecting a Smartphone

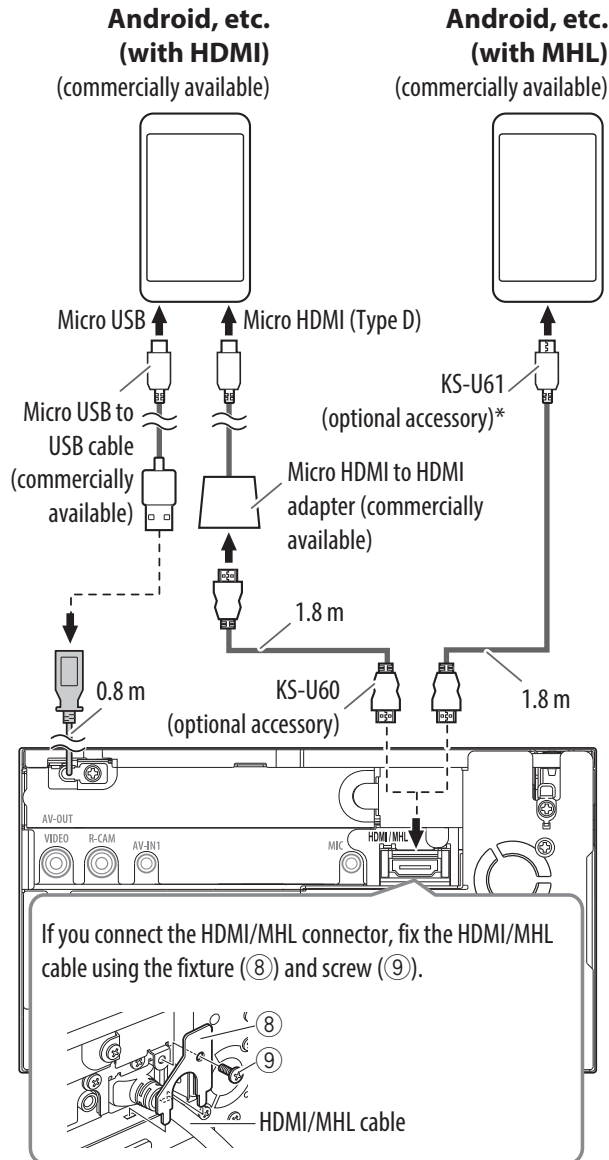

* Use conversion adapter to connect to smartphones if necessary.

Connecting external components

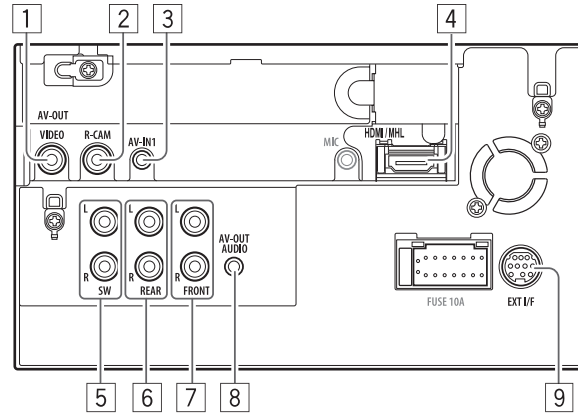

- 1 AV-OUT/Video output (Yellow)
 - 2 Rear view camera input (Yellow)
 - 3 Audio Video input (AV-IN)
 - Connect the following type of 4-pole mini plug:
-
- 1 Left audio
 - 2 Right audio
 - 3 Ground
 - 4 Composite video
- 4 HDMI/MHL input
 - 5 Subwoofer preout (monaural output)*1
 - Subwoofer left output (White)
 - Subwoofer right output (Red)
 - 6 Rear preout*1
 - Audio left output (White)
 - Audio right output (Red)

- 7 Front preout*1
 - Audio left output (White)
 - Audio right output (Red)
- 8 AV-OUT/ Audio output (ø3.5 mini plug)
Resistance-free stereo type mini plug
- 9 Expansion port for connecting SiriusXM Connect Vehicle Tuner (commercially available)*2

*1 When connecting an external amplifier, connect its ground wire to the chassis of the car; otherwise the unit may be damaged.

*2 Only for KW-V51BT Region 1/KW-V31BT Region 1.

CONNECTION/INSTALLATION

Connecting microphone for Bluetooth

- Connect the microphone (7) to the MIC terminal.
- To install the microphone, peel off the adhesive tape, fix on the installation position, then adjust the direction of the microphone to face the driver. After installing, fix the microphone cable to the car with clamps (commercially available).

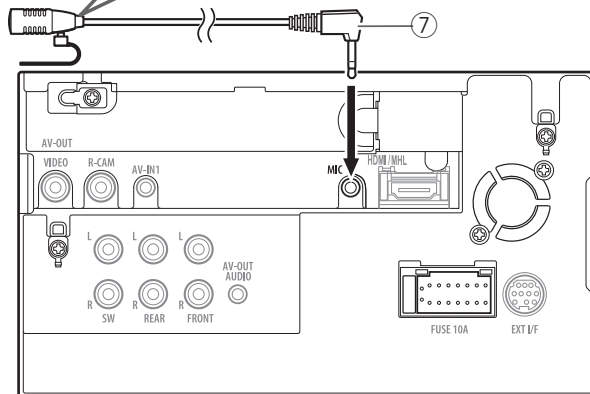
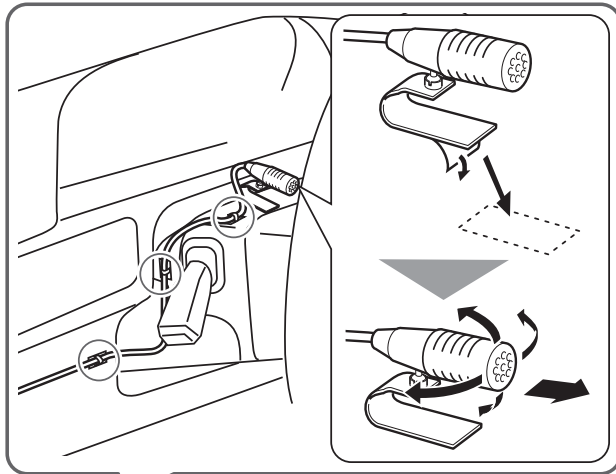

Removing the unit (only for KW-V51BT Region 4/KW-V31BT Region 4)

Removing the trim plate

- Engage the catch pins on the extraction key (4) and remove the two locks on the lower part. Lower the frame and pull it forward.

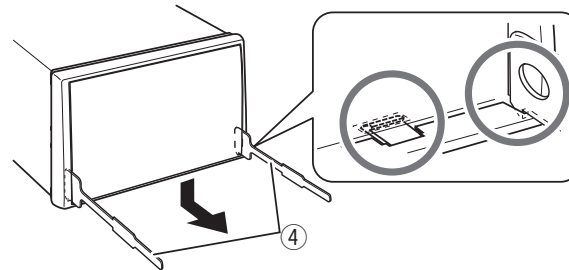

- Remove the upper two locations.

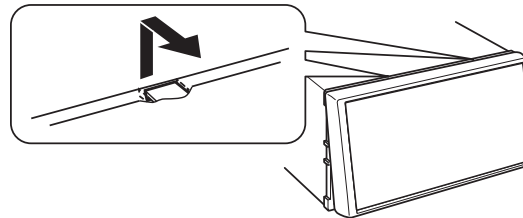

- The frame can be removed from the top side in the same manner.

Removing the unit

- Remove the trim plate. (See the left column.)
- Insert the two extraction keys (4), then pull them as illustrated so that the unit can be removed.

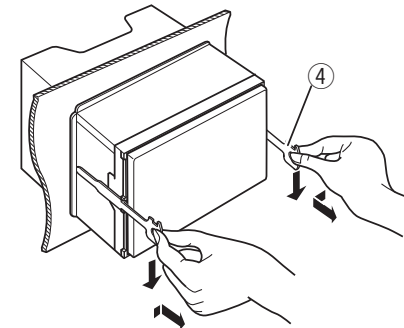

- Be careful to avoid injury from the catch pins on the extraction key.

REFERENCES

Maintenance

❑ Caution on cleaning the unit

Do not use any solvent (for example, thinner, benzene, etc.), detergent, or insecticide. This may damage the monitor or the unit.

Recommended cleaning method:

Gently wipe the panel with a soft, dry cloth.

❑ Moisture condensation

Moisture may condense on the lens inside the unit in the following cases:

- After starting the heater in the car.
- If it becomes very humid inside the car.

Should this occur, the unit may malfunction. In this case, eject the disc and leave the unit turned on for a few hours until the moisture evaporates.

❑ How to handle discs

- When removing a disc from its case, press down the center holder of the case and lift the disc out, holding it by the edges.



- Always hold the disc by the edges. Do not touch its recording surface.
- When storing a disc in its case, gently insert the disc around the center holder (with the printed surface facing up).
 - Make sure to store discs in their cases after use.

❑ To keep discs clean

A dirty disc may not play correctly.

If a disc does become dirty, wipe it with a soft cloth in a straight line from center to edge.



- Do not use any solvents (for example, conventional record cleaner, spray, thinner, benzene, etc.) to clean discs.

❑ To play new discs

New discs may have some rough spots around the inner and outer edges. If such a disc is used, this unit may reject the disc.

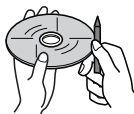

- To remove these rough spots, rub the edges with a pencil or ball-point pen, etc.

More information

❑ File playback

Playing DivX files (for discs only)*

- This unit can play back DivX files with the extension code <.divx>, <.div>, or <.avi> (regardless of the letter case—upper/lower).
- Audio stream should conform to MP3 or Dolby Digital.
- The file encoded in the interlaced scanning mode may not be played back correctly.
- The maximum bit rate for video signals (average) is 4 Mbps.

* Only for KW-V51BT Region 4/KW-V31BT Region 4.

Playing MPEG1/MPEG2 files

- This unit can play back MPEG1/MPEG2 files with the extension code <.mpg> or <.mpeg>.
- The stream format should conform to MPEG system/program stream.
The file format should be MP@ML (Main Profile at Main Level)/SP@ML (Simple Profile at Main Level)/MP@LL (Main Profile at Low Level).
- Audio streams should conform to MPEG1 Audio Layer-2 or Dolby Digital.
- The maximum bit rate for video signals (average) is 4 Mbps.

Continued on the next page...

REFERENCES

Playing JPEG/BMP/PNG files (for USB only)

- This unit can play back picture files with the extension code <.jpg>, <.jpeg>, <.bmp> or <.png>.
- This unit can play back files that are at 32 x 32 to 8 192 x 7 680 (PNG: 800 x 480) resolution. It may take time to display the file depending on its resolution.
- This unit can play back baseline JPEG files. Progressive JPEG files or lossless JPEG files cannot be played.

Playing audio files (for discs: MP3/WMA/AAC, for USB: MP3/WMA/WAV/AAC/FLAC)

- This unit can play back files with the extension code <.mp3>, <.wma>, <.wav>, <.m4a> or <.flac> (regardless of the letter case—upper/lower).
- This unit can play back files that meet the conditions below:
 - Bit rate:
 - MP3: 8 kbps – 320 kbps
 - WMA: 48 kbps – 192 kbps
 - AAC: For discs: 16 kbps – 320 kbps
 - For USB: 32 kbps – 320 kbps
 - Sampling frequency:
 - MP3: 8 kHz – 48 kHz
 - WMA: For discs: 32 kHz – 48 kHz
 - For USB: 8 kHz – 48 kHz
 - WAV: 44.1 kHz
 - AAC: 16 kHz – 48 kHz
 - FLAC : 8 kHz – 48 kHz
- This unit can show ID3 Tag Version 1.0/1.1/2.2/2.3/2.4 (for MP3).
- This unit can also show WMA/AAC/FLAC Tag.
- This unit can play back files recorded in VBR (variable bit rate).

- Files recorded in VBR have a discrepancy in elapsed time indication.
- This unit cannot play back the following files:
 - MP3 files encoded with MP3i and MP3 PRO format.
 - MP3 files encoded with Layer 1/2.
 - WMA files encoded with lossless, professional, and voice format.
 - WMA files which are not based upon Windows Media® Audio.
 - WMA/AAC files copy-protected with DRM.
 - AAC files encoded using any other application than iTunes.
 - AAC files copy-protected with FairPlay (except those stored on an iPod).
 - Files which have data such as AIFF, ATRAC3, etc.
- This unit can display jacket pictures that meet the conditions below:
 - Picture size: 32 x 32 to 1 232 x 672 resolution
 - Data size: less than 650 KB
 - File type: JPEG/PNG/BMP

Playing H.264/WMV files (for USB only)

- This unit can play back files with the extension code <.mp4>, <.wmv>, <.avi> or <.mkv>.
- This unit can only play back files which are less than 2 GB.
- The stream format should conform to MPEG system/program stream.

Disc playback

Playable disc types

Disc type	Recording format, file type, etc.
DVD <ul style="list-style-type: none"> • DTS sound cannot be reproduced or emitted from this unit. 	DVD Video* ¹
DVD Recordable/Rewritable (DVD-R/-RW*², +R/+RW*³) <ul style="list-style-type: none"> • DVD Video: UDF bridge • DVD-VR • DivX*⁵/MPEG1/MPEG2/MP3/WMA/AAC: ISO 9660 level 1, level 2, Romeo, Joliet 	<ul style="list-style-type: none"> • DVD Video • DVD-VR*⁴ • DivX*⁵/MPEG1/MPEG2 • MP3/WMA/AAC
Dual Disc	DVD side
CD/VCD	<ul style="list-style-type: none"> • VCD (Video CD) • Audio CD/CD Text (CD-DA)
CD Recordable/Rewritable (CD-R/-RW) <ul style="list-style-type: none"> • ISO 9660 level 1, level 2, Romeo, Joliet 	<ul style="list-style-type: none"> • VCD (Video CD) • CD-DA • DivX/MPEG1/MPEG2 • MP3/WMA/AAC

*¹ DVD Region code: 1/4 (depending on the country and sales area) If you insert a DVD Video disc of an incorrect Region Code, "Region Code Error" appears on the screen.

*² DVD-R recorded in multi-border format is also playable (except for dual layer discs). DVD-RW dual layer discs are not playable.

*³ It is possible to play back finalized +R/+RW (Video format only) discs. "DVD" is selected as the disc type when a +R/+RW disc is loaded. +RW double layer discs are not playable.

*⁴ This unit cannot play back contents protected with CPRM (Content Protection for Recordable Media).

*⁵ Only for KW-V51BT Region 4/KW-V31BT Region 4.

REFERENCES

Unplayable discs

- Unplayable disc types and formats are as follows:
 - DVD-Audio/DVD-ROM discs
 - DivX*/MPEG4/WAV/JPEG/FLAC/MKV/DVD+VR/DVD-RAM recorded on DVD-R/RW or +R/+RW
 - SVCD (Super Video CD), CD-ROM, CD-I (CD-I Ready), DTS-CD
 - MPEG4/WAV/JPEG/FLAC/MKV recorded on CD-R/RW
- Discs that are not round.
- Discs with coloring on the recording surface or discs that are dirty.
- Recordable/Rewritable discs that have not been finalized.
- 3 inch disc. Attempting to insert using an adapter may cause a malfunction.

* Only for KW-V51BT Region 1/KW-V31BT Region 1.

DualDisc playback

The Non-DVD side of a "DualDisc" does not comply with the "Compact Disc Digital Audio" standard. Therefore, the use of the Non-DVD side of a DualDisc on this product cannot be recommended.

Playing Recordable/Rewritable discs

- This unit can recognize a total of 64 770 files and 254 folders (a maximum of 255 files per folder).
- Use only "finalized" discs.
- This unit can play back multi-session discs; however, unclosed sessions will be skipped while playing.
- Some discs or files may not be played back due to their characteristics or recording conditions.
- Up to 64 characters of disc information can be displayed.

□ About data stored in the connected USB device/iPod/iPhone

- We bear no responsibility for any loss of data in iPod/iPhone and USB mass storage class devices while using this unit.

□ USB playback

Playable files on a USB device

- This unit can play the following types of files stored in a USB mass storage class device.
 - JPEG/BMP/PNG/MPEG1/MPEG2/MP3/WMA/WAV/AAC/FLAC/MPEG4/H.264/MPEG4 AVC/AVI/MKV/WMV
- This unit can recognize a total of 5 000 files and 250 folders (a maximum of 999 files per folder).
- Make sure all important data has been backed up to avoid losing the data.

Notes on using a USB device

- This unit may not play back files in a USB device properly when using a USB extension cable.
- USB devices equipped with special functions such as data security functions cannot be used with the unit.

- Do not use a USB device with 2 or more partitions.
- Depending on the shape of the USB devices and connection ports, some USB devices may not be attached properly or the connection might be loose.
- This unit cannot recognize a USB device whose rating is other than 5 V and exceeds 1 A.
- This unit may not recognize a memory card inserted into the USB card reader.
- Connect only one USB device to the unit at a time. Do not use a USB hub.
- When connecting with a USB cable, use the USB 2.0 cable.
- The maximum number of characters (when the characters are 1 byte):
 - Folder names: 128 characters
 - File names: 128 characters
- Avoid using the USB device if it might affect driving safety.
- Do not pull out and connect the USB device repeatedly while "Now Reading..." is shown on the screen.
- Electrostatic shock at connecting a USB device may cause abnormal playback of the device. In this case, disconnect the USB device then reset this unit and the USB device.
- Operation and power supply may not work as intended for some USB devices.
- Do not leave a USB device in the car, or expose to direct sunlight or high temperature to avoid deformation or damage to the device.

REFERENCES

Notes on playing iPod/iPhone

- iPod/iPhone that can be connected to this unit:
Made for
 - iPod with video
 - iPod classic
 - iPod nano (7th Generation)
 - iPod nano (6th Generation)
 - iPod nano (5th Generation)
 - iPod nano (4th Generation)
 - iPod nano (3rd Generation)
 - iPod touch (5th Generation)
 - iPod touch (4th Generation)
 - iPod touch (3rd Generation)
 - iPod touch (2nd Generation)
 - iPod touch (1st Generation)
 - iPhone 5S
 - iPhone 5C
 - iPhone 5
 - iPhone 4S
 - iPhone 4
 - iPhone 3GS
 - iPhone 3G
 - iPhone
- When operating an iPod/iPhone, some operations may not be performed correctly or as intended. In this case, visit the following JVC web site:
<<http://www.jvc.net/cs/car/>>
- For some iPod/iPhone models, the performance may be abnormal or unstable during operation. In this case, disconnect the iPod/iPhone device, then check its condition.
If the performance is not improved or slow, reset your iPod/iPhone.
- When you turn on this unit, the iPod/iPhone is charged through the unit.
- The text information may not be displayed correctly.

Language codes (for DVD/DVD-VR language selection)

AA	Afar	GL	Galician	MI	Maori	SO	Somali
AB	Abkhazian	GN	Guarani	MK	Macedonian	SQ	Albanian
AF	Afrikaans	GU	Gujarati	ML	Malayalam	SR	Serbian
AM	Ameharic	HA	Hausa	MN	Mongolian	SS	Siswati
AR	Arabic	HI	Hindi	MO	Moldavian	ST	Sesotho
AS	Assamese	HR	Croatian	MR	Marathi	SU	Sundanese
AY	Aymara	HU	Hungarian	MS	Malay (MAY)	SW	Swahili
AZ	Azerbaijani	HY	Armenian	MT	Maltese	TA	Tamil
BA	Bashkir	IA	Interlingua	MY	Burmese	TE	Telugu
BE	Byelorussian	IE	Interlingue	NA	Nauru	TG	Tajik
BG	Bulgarian	IK	Inupiak	NE	Nepali	TH	Thai
BH	Bihari	IN	Indonesian	NO	Norwegian	TI	Tigrinya
BI	Bislama	IS	Icelandic	OC	Occitan	TK	Turkmen
BN	Bengali, Bangla	IW	Hebrew	OM	(Afan) Oromo	TL	Tagalog
BO	Tibetan	JA	Japanese	OR	Oriya	TN	Setswana
BR	Breton	JI	Yiddish	PA	Panjabi	TO	Tonga
CA	Catalan	JW	Javanese	PL	Polish	TR	Turkish
CO	Corsican	KA	Georgian	PS	Pashto, Pushto	TS	Tsonga
CS	Czech	KK	Kazakh	QU	Quechua	TT	Tatar
CY	Welsh	KL	Greenlandic	RM	Rhaeto-Romance	TW	Twi
DZ	Bhutani	KM	Cambodian	RN	Kirundi	UK	Ukrainian
EL	Greek	KN	Kannada	RO	Rumanian	UR	Urdu
EO	Esperanto	KO	Korean (KOR)	RW	Kinyarwanda	UZ	Uzbek
ET	Estonian	KS	Kashmiri	SA	Sanskrit	VI	Vietnamese
EU	Basque	KU	Kurdish	SD	Sindhi	VO	Volapuk
FA	Persian	KY	Kirghiz	SG	Sangho	WO	Wolof
FI	Finnish	LA	Latin	SH	Serbo-Croatian	XH	Xhosa
FJ	Fiji	LN	Lingala	SI	Singhalese	YO	Yoruba
FO	Faroese	LO	Laothian	SK	Slovak	ZU	Zulu
FY	Frisian	LT	Lithuanian	SL	Slovenian		
GA	Irish	LV	Latvian, Lettish	SM	Samoan		
GD	Scots Gaelic	MG	Malagasy	SN	Shona		

REFERENCES

❑ Sound signals emitted through the rear terminals

Through the analog terminals (Speaker out/REAR preout/FRONT preout/AV-OUT AUDIO)

2-channel signal is emitted. When playing multi-channel encoded disc, multi-channel signals are downmixed.

Error message list

If an error occurs while using the unit, a message appears. Take appropriate action according to the following message/remedy/cause list.

“No Signal”:

- Start the playback on the external component connected to the AV-IN1 input terminal.
- Start playback on the smartphone connected to the HDMI/MHL input terminal.
- Check the cords and connections.
- Signal input is too weak.

“MISWIRING Check wiring connection then reset unit”/“WARNING Check wiring connection then reset unit”:

- A speaker cord has shorted or it has come in to contact with the car chassis. Wire or insulate the speaker cord as appropriate, then reset the unit. (Pages 3 and 55)

“Parking Brake”:

- No playback picture is shown when the parking brake is not engaged.

“Restricted Device”:

- Check whether the connected iPod/iPhone is compatible with this unit. (Page 62)

“USB Device Error”:

- The USB power voltage is abnormal.
- Turn off and turn on the unit.
- Connect another USB device.

“Connection Error”:

- The device is registered but the connection has failed. Connect the registered device. (Page 37)

“Please Wait...”:

- The unit is preparing to use the Bluetooth function. If the message does not disappear, turn off and turn on the unit, then connect the device again (or reset the unit).

“No Voice Device”:

- The connected mobile phone does not have a voice recognition system.

“No Data”:

- No phone book data is contained in the connected Bluetooth phone.

“Initialize Error”:

- The unit has failed to initialize the Bluetooth module. Try the operation again.

“Dial Error”:

- Dialing has failed. Try the operation again.

“Hung Up Error”:

- The call has not ended yet. Park your car, and use the connected mobile phone to end the call.

“Pick Up Error”:

- The unit has failed to receive a call.

“Disconnected”:

- The device is not connected.

“Check device”:

- The application is not active.

“Check application”:

- A connection to the application cannot be established.

“Not logged in”:

- You are not logged in.

“Request time out”:

- A network (WiFi connection, server) error has occurred.

“Station not selected”:

- No station is selected.

“Station cannot be saved”/“Station cannot be created”/“Station cannot be deleted”:

- The station cannot be saved, created, or deleted.

“Please update Pandora App”:

- The Pandora application on your iPod touch/iPhone/Android/BlackBerry is not the latest version. Update the application.

“Please check device.”:

- The Pandora application on your iPod touch/iPhone/Android/BlackBerry is not started up.
- The Pandora application is not installed in the connected device.
- An error has occurred on the Pandora application.

“Login Error”:

- You have not been signed into Pandora.

Continued on the next page...

REFERENCES

“No skips remaining”:

- No more songs can be skipped.

“Failed to save your thumb rating”:

- Thumb-up/down is prohibited.

“No Station”:

- No station is available.

“No Active Station”:

- No station is being played.

“Station limit reached”:

- The Station List is full and no more stations can be registered.

“Failed to save your bookmark”:

- The unit has failed to save a bookmark. Try the operation again.

“Limited Connectivity”:

- The connection with the Pandora application cannot be established.

“Pandora not available”:

- You cannot use the Pandora application from the area where you are currently trying to access Pandora.

“Try again later”:

- The Pandora server is under maintenance.

“Station does not exist”:

- The selected station has been deleted by another device or has expired.

“Cannot create a Station”:

- You cannot create a station during the read-only mode or when network connection is not established.

“SXM No Signal”:

- Make sure the SiriusXM radio antenna is mounted outside the vehicle. Move vehicle to an area with a clear view of the sky.

“SXM Check Antenna”:

- Check the SiriusXM radio antenna connection, and make sure the antenna is firmly attached to the tuner.
- Check whether the SiriusXM radio antenna cable is bent or broken. If it is damaged, replace the whole antenna unit.

“SXM Check Tuner”:

- Make sure the SiriusXM Connect Vehicle Tuner is connected to the unit.

“SXM Chan Unavailable” (appears on the screen for about 2 seconds, then returns to the previous channel):

- Selected channel is no longer available. Select another channel or continue listening to the previous channel.

“SXM Ch Unsubscribed”:

- Selected channel is not part of your current subscription plan. Call 1-866-635-2349 to subscribe.

“SXM Subscription Updated – Press Enter to Continue”:

- Your subscription is updated. Press the appropriate button to continue.

“SXM Channel Locked”

- The selected channel has been locked by the parental controls. Enter unlock code after you are asked. (Page 30)

“SXM Incorrect Lock Code”

- The selected channel is a mature or parental lock channel, and locked by parental lock or user lock code. Enter the correct lock code.

Troubleshooting

What appears to be trouble is not always serious. Check the following points before calling a service center.

- For operations with the external components, refer also to the instructions supplied with the adapters used for the connections (as well as the instructions supplied with the external components).

□ General

No sound comes out of the speakers.

- Adjust the volume to the optimum level.
- Check the cords and connections.

No picture is displayed on the screen.

- Turn on the screen. (Page 6)

The unit does not work at all.

- Reset the unit. (Page 3)

The remote controller does not work.

- Replace the battery.

REFERENCES

❑ Discs

Recordable/Rewritable discs cannot be played back.

- Insert a finalized disc.
- Finalize the discs with the component which you used for recording.

Tracks on the Recordable/Rewritable discs cannot be skipped.

- Insert a finalized disc.
- Finalize the discs with the component which you used for recording.

Playback does not start.

- The format of files is not supported by the unit.

No picture appears on the external monitor.

- Connect the video cord correctly.
- Select the correct input on the external monitor.

DivX*/MPEG1/MPEG2/MP3/WMA/AAC discs cannot be played back.

- Record the tracks using a compatible application on the appropriate discs. (Page 60)
- Add appropriate extension codes to the file names.

Tracks on the Recordable/Rewritable discs are not played back as you have intended them to play.

- Playback order may differ from the one played back using other players.

* Only for KW-V51BT Region 4/KW-V31BT Region 4.

❑ USB

“Now Reading...” does not disappear from the screen.

- Turn the power off and on again.

While playing a track, sound is sometimes interrupted.

- The tracks are not properly copied into the USB device. Copy tracks again, and try again.

Tracks are not played back as you have intended them to play.

- Playback order may differ from the one played back using other players.

❑ iPod/iPhone

No sound comes out of the speakers.

- Disconnect the iPod/iPhone, then connect it again.
- Select another source, then reselect “iPod”.

The iPod/iPhone does not turn on or does not work.

- Check the connecting cable and its connection.
- Update the firmware version.
- Charge the battery.
- Reset the iPod/iPhone.

Sound is distorted.

- Deactivate the equalizer either on this unit or the iPod/iPhone.

A lot of noise is generated.

- Turn off (uncheck) “VoiceOver” of the iPod/iPhone. For details, visit <<http://www.apple.com>>.

No operations are available when playing back a track containing artwork.

- Operate the unit after the artwork has loaded.

Videos cannot be played.

- Connect with USB Audio and Video cable JVC KS-U59 for iPod/iPhone except for iPod nano (7th Generation)/iPod touch (5th Generation)/iPhone 5S/iPhone 5C/iPhone 5 or JVC KS-U60 and USB2.0 cable through a Lightning-Digital AV adapter for iPod nano (7th Generation)/iPod touch (5th Generation)/iPhone 5S/iPhone 5C/iPhone 5. Other cables cannot be used.

No sound of videos comes out.

- Connect with USB Audio and Video cable JVC KS-U59 for iPod/iPhone except for iPod nano (7th Generation)/iPod touch (5th Generation)/iPhone 5S/iPhone 5C/iPhone 5 or JVC KS-U60 and USB2.0 cable through a Lightning-Digital AV adapter for iPod nano (7th Generation)/iPod touch (5th Generation)/iPhone 5S/iPhone 5C/iPhone 5. Other cables cannot be used.

❑ Tuner

SSM automatic presetting does not work.

- Store stations manually. (Page 26)

Static noise while listening to the radio.

- Connect the antenna firmly.

❑ AV-IN

No picture appears on the screen.

- Turn on the video component if it is not on.
- Connect the video component correctly.

❑ iHeartRadio/Pandora*

The application does not work.

- The application on your iPod touch/iPhone/Android is not the latest version. Update the application.

* Available only for KW-V51BT Region 1/KW-V31BT Region 1.

REFERENCES

❑ Bluetooth

Phone sound quality is poor.

- Reduce the distance between the unit and the Bluetooth mobile phone.
- Move the car to a place where you can get a better signal reception.

The sound is interrupted or skipped while using a Bluetooth audio player.

- Reduce the distance between the unit and the Bluetooth audio player.
- Disconnect the device connected for Bluetooth phone.
- Turn off, then turn on the unit.
(When the sound is not yet restored) connect the player again.

The connected audio player cannot be controlled.

- Check whether the connected audio player supports AVRCP (Audio Video Remote Control Profile).

The Bluetooth device does not detect the unit.

- Search from the Bluetooth device again.

The unit does not make pairing with the Bluetooth device.

- For devices compatible with Bluetooth 2.1: Register the device using a PIN code. (Page 36)
- For devices compatible with Bluetooth 2.0: Enter the same PIN code for both the unit and target device. If the PIN code of the device is not indicated on its instructions, try "0000" or "1234."
- Turn off, then turn on the Bluetooth device.

Echo or noise occurs.

- Adjust the microphone unit position.
- Adjust the echo volume or noise reduction volume. (Page 38)

The unit does not respond when you try to copy the phone book to the unit.

- You may have tried to copy the same entries (as stored) to the unit.

Specifications

❑ Monitor section

Picture Size (W x H)

KW-V51BT: 6.95 inches (diagonal) wide
156.6 mm x 81.6 mm (6-3/16" x 3-3/16")

KW-V31BT: 6.1 inches (diagonal) wide
136.2 mm x 72 mm (5-6/16" x 2-13/16")

Display System Transparent TN LCD panel

Drive System TFT active matrix system

Number of Pixels 1 152 000 (800H x 480V x RGB)

Effective Pixels 99.99%

Pixel Arrangement

RGB striped arrangement

Back Lighting LED

❑ DVD player section

D/A Converter 24 bit

Audio Decoder Linear PCM/Dolby Digital/MP3/WMA/AAC

Video Decoder MPEG1/MPEG2/DivX*

Wow & Flutter Below Measurable Limit

Frequency Response

96 kHz Sampling: 20 Hz to 22 000 Hz

48 kHz Sampling: 20 Hz to 22 000 Hz

44.1 kHz Sampling: 20 Hz to 20 000 Hz

Total Harmonic Distortion

0.010% (1 kHz)

Signal to Noise Ratio

94 dB (DVD-Video 96 kHz)

Dynamic Range 91 dB (DVD-Video 96 kHz)

Disc Format DVD-Video/DVD-VR/VIDEO-CD/CD-DA

Sampling Frequency

44.1 kHz/48 kHz/96 kHz

Quantifying Bit Number

16/20/24 bit

* Only for KW-V51BT Region 4/KW-V31BT Region 4.

REFERENCES

□ USB interface section

USB Standard	USB 2.0 High Speed
Compatible Devices	Mass storage class
File System	FAT 16/32
Maximum Power Supply Current	DC 5 V \equiv 1 A
D/A Converter	24 bit
Audio Decoder	MP3/WMA/AAC/WAV/FLAC
Video Decoder	MPEG1/MPEG2/MPEG4/ H.264/MPEG4 AVC/WMV/JPEG/ BMP/PNG

□ HDMI interface section

Connector Type	TYPE-A
Input Resolution	VGA (640 x 480p@59.94 Hz/ 60 Hz), 480p (720 x 480p @59.94 Hz/60 Hz)
Input Audio Type	32 kHz, 44.1 kHz, 48 kHz, 16-bit Linear PCM

□ MHL interface section

Supported Version	MHL2
Input Resolution	VGA (640 x 480p@59.94 Hz/ 60 Hz), 480p (720 x 480p @59.94 Hz/60 Hz)
Input Audio Type	32 kHz, 44.1 kHz, 48 kHz, 16-bit Linear PCM
Maximum Power Supply Current	DC 5 V \equiv 900 mA

□ Bluetooth section

Technology	Bluetooth 3.0 + EDR
Frequency	2.4 GHz to 2.4835 GHz
Output Power	+4 dBm (MAX), 0 dBm (AVE), Power Class 2
Maximum Communication Range	Line of sight approx. 10 m (32.8 ft)
Audio Codec	SBC/MP3/AAC
Profile	HFP (Hands Free Profile) 1.6 A2DP (Advanced Audio Distribution Profile) 1.2 AVRCP (Audio/Video Remote Control Profile) 1.4 GAP (Generic Access Profile) PBAP (Phonebook Access Profile) 1.0 SDP (Service Discovery Profile) SPP (Serial Port Profile) 1.1 HID (Human Interface Device Profile)

□ FM tuner section

Frequency Range	With channel interval set to 200 kHz: 87.9 MHz to 107.9 MHz (200 kHz) With channel interval set to 50 kHz: 87.5 MHz to 108.0 MHz (50 kHz)
Usable Sensitivity (S/N: 30 dB Dev 22.5 kHz)	9.3 dBf (0.8 μ V/75 Ω)
Quieting Sensitivity (S/N: 46 dB Dev 22.5 kHz)	15.2 dBf (1.6 μ V/75 Ω)
Frequency Response (\pm 3.0 dB)	30 Hz to 15 kHz
Signal to Noise Ratio	75 dB (MONO)
Selectivity (\pm 400 kHz)	\geq 80 dB
Stereo Separation	45 dB (1 kHz)

□ AM tuner section

Frequency Range (10 kHz)	530 kHz to 1 700 kHz
Signal to Noise Ratio	65 dB
Usable Sensitivity	28 dB μ

REFERENCES

□ Video section

Color System of External Video Input
NTSC/PAL

External Video Input Level (RCA/mini jack)
1 V_{p-p}/75 Ω

Video Output Level (RCA jack)
1 V_{p-p}/75 Ω

Audio Output Level (mini jack)
1.2 V/10 kΩ

□ Audio section

Maximum Power (Front & Rear)
50 W × 4

Full Bandwidth Power (Front & Rear)
(4 Ω, 14.4 V, 1% THD)
22 W × 4

External Audio Max Input Level (mini jack)*
2 V/25 kΩ

Preout Level 4 V/10 kΩ

Preout Impedance ≤ 600 Ω

Speaker Impedance
4 Ω to 8 Ω

Equalizer Control Range (3 bands)

Low: 60 Hz, 80 Hz, 100 Hz, 150 Hz, ±10 dB

Mid: 500 Hz, 1 kHz, 1.5 kHz, 2 kHz, ±10 dB

High: 10 kHz, 12.5 kHz, 15 kHz, 17.5 kHz, ±10 dB

* Only for KW-V31BT.

□ General

Operating Voltage 14.4 V (10.5 V to 16 V allowable)

Maximum Current Consumption
10 A

Installation Dimensions (W × H × D)

KW-V51BT Region 1/KW-V31BT Region 1:
178 mm × 100 mm × 159 mm
(7-1/16" × 3-15/16" × 6-5/16")

KW-V51BT Region 4/KW-V31BT Region 4:
182 mm × 111 mm × 162 mm
(7-3/16" × 4-3/8" × 6-7/16")

Operational Temperature Range
-10°C to +60°C

Weight

KW-V51BT Region 1: 2.5 kg (5.6 lbs)

KW-V51BT Region 4: 2.8 kg (6.2 lbs)

KW-V31BT Region 1: 1.9 kg (4.2 lbs)

KW-V31BT Region 4: 2.2 kg (4.9 lbs)

Design and specifications are subject to change without notice.

If a kit is necessary for your car, consult your telephone directory for the nearest car audio speciality shop.

□ Trademarks and licenses

- Manufactured under license from Dolby Laboratories. Dolby and the double-D symbol are trademarks of Dolby Laboratories.
- "DVD Logo" is a trademark of DVD Format/Logo Licensing Corporation registered in the US, Japan and other countries.
- The "AAC" logo is a trademark of Dolby Laboratories.
- Microsoft and Windows Media are either registered trademarks or trademarks of Microsoft Corporation in the United States and/or other countries.
- "Made for iPod," and "Made for iPhone" mean that an electronic accessory has been designed to connect specifically to iPod, or iPhone, respectively, and has been certified by the developer to meet Apple performance standards. Apple is not responsible for the operation of this device or its compliance with safety and regulatory standards. Please note that the use of this accessory with iPod, or iPhone may affect wireless performance. iPhone, iPod, iPod classic, iPod nano, and iPod touch are trademarks of Apple Inc., registered in the U.S. and other countries.
- Lightning is a trademark of Apple Inc.
- This item incorporates copy protection technology that is protected by U.S. patents and other intellectual property rights of Rovi Corporation. Reverse engineering and disassembly are prohibited.
- Font for this product is designed by Ricoh.

REFERENCES

- THIS PRODUCT IS LICENSED UNDER THE MPEG-4 VISUAL PATENT PORTFOLIO LICENSE FOR THE PERSONAL AND NON-COMMERCIAL USE OF A CONSUMER FOR (i) ENCODING VIDEO IN COMPLIANCE WITH THE MPEG-4 VISUAL STANDARD ("MPEG-4 VIDEO") AND/OR (ii) DECODING MPEG-4 VIDEO THAT WAS ENCODED BY A CONSUMER ENGAGED IN A PERSONAL AND NON-COMMERCIAL ACTIVITY AND/OR WAS OBTAINED FROM A VIDEO PROVIDER LICENSED BY MPEG LA TO PROVIDE MPEG-4 VIDEO. NO LICENSE IS GRANTED OR SHALL BE IMPLIED FOR ANY OTHER USE. ADDITIONAL INFORMATION INCLUDING THAT RELATING TO PROMOTIONAL, INTERNAL AND COMMERCIAL USES AND LICENSING MAY BE OBTAINED FROM MPEG LA, LLC. SEE [HTTP://WWW.MPEGLA.COM](http://www.mpegla.com).
- THIS PRODUCT IS LICENSED UNDER THE AVC PATENT PORTFOLIO LICENSE FOR THE PERSONAL USE OF A CONSUMER OR OTHER USES IN WHICH IT DOES NOT RECEIVE REMUNERATION TO (i) ENCODE VIDEO IN COMPLIANCE WITH THE AVC STANDARD ("AVC VIDEO") AND/OR (ii) DECODE AVC VIDEO THAT WAS ENCODED BY A CONSUMER ENGAGED IN A PERSONAL ACTIVITY AND/OR WAS OBTAINED FROM A VIDEO PROVIDER LICENSED TO PROVIDE AVC VIDEO. NO LICENSE IS GRANTED OR SHALL BE IMPLIED FOR ANY OTHER USE. ADDITIONAL INFORMATION MAY BE OBTAINED FROM MPEG LA, L.L.C. SEE [HTTP://WWW.MPEGLA.COM](http://www.mpegla.com)
- Pandora, the Pandora logo, and the Pandora trade dress are trademarks or registered trademarks of Pandora Media, Inc., used with permission.
- Sirius, XM and all related marks and logos are trademarks of Sirius XM Radio Inc. All rights reserved.
- Android is a trademark of Google Inc.
- The Bluetooth® word mark and logos are registered trademarks owned by Bluetooth SIG, Inc. and any use of such marks by JVC KENWOOD Corporation is under license. Other trademarks and trade names are those of their respective owners.
- The terms HDMI and HDMI High-Definition Multimedia Interface, and the HDMI logo are trademarks or registered trademarks of HDMI Licensing LLC in the United States and other countries.
- MHL and the MHL logo are a trademark or registered trademark of MHL, LLC.
 - Incorporates MHL 2
- iHeartRadio® is a registered mark of Clear Channel Broadcasting, Inc. in the United States and other countries. Such marks are used under license.
- libFLAC
 - Copyright (C) 2000,2001,2002,2003,2004,2005, 2006,2007,2008,2009 Josh Coalson
 - Redistribution and use in source and binary forms, with or without modification, are permitted provided that the following conditions are met:
 - Redistributions of source code must retain the above copyright notice, this list of conditions and the following disclaimer.
 - Redistributions in binary form must reproduce the above copyright notice, this list of conditions and the following disclaimer in the documentation and/or other materials provided with the distribution.
 - Neither the name of the Xiph.org Foundation nor the names of its contributors may be used to endorse or promote products derived from this software without specific prior written permission.

THIS SOFTWARE IS PROVIDED BY THE COPYRIGHT HOLDERS AND CONTRIBUTORS "AS IS" AND ANY EXPRESS OR IMPLIED WARRANTIES, INCLUDING, BUT NOT LIMITED TO, THE IMPLIED WARRANTIES OF MERCHANTABILITY AND FITNESS FOR A PARTICULAR PURPOSE ARE DISCLAIMED. IN NO EVENT SHALL THE FOUNDATION OR CONTRIBUTORS BE LIABLE FOR ANY DIRECT, INDIRECT, INCIDENTAL, SPECIAL, EXEMPLARY, OR CONSEQUENTIAL DAMAGES (INCLUDING, BUT NOT LIMITED TO, PROCUREMENT OF SUBSTITUTE GOODS OR SERVICES; LOSS OF USE, DATA, OR PROFITS; OR BUSINESS INTERRUPTION) HOWEVER CAUSED AND ON ANY THEORY OF LIABILITY, WHETHER IN CONTRACT, STRICT LIABILITY, OR TORT (INCLUDING NEGLIGENCE OR OTHERWISE) ARISING IN ANY WAY OUT OF THE USE OF THIS SOFTWARE, EVEN IF ADVISED OF THE POSSIBILITY OF SUCH DAMAGE.

DIVX

- This DivX Certified® device has passed rigorous testing to ensure it plays DivX® video. To play purchased DivX movies, first register your device at vod.divx.com. Find your registration code in the DivX VOD section of your device setup menu. (Page 50)
- DivX Certified® to play DivX® video, including premium content.
- DivX®, DivX Certified® and associated logos are trademarks of DivX, LLC and are used under license.

Having TROUBLE with operation?

Please reset your unit

Refer to page of How to reset your unit

Still having trouble??

USA ONLY

Call 1-800-252-5722

<http://www.jvc.com>

We can help you!

JVC

TO OUR VALUED CUSTOMER

THANK YOU FOR PURCHASING THIS JVC PRODUCT.
WE WANT TO HELP YOU ACHIEVE A PERFECT EXPERIENCE.

**NEED HELP ON HOW TO HOOK UP?
NEED ASSISTANCE ON HOW TO OPERATE?
NEED TO LOCATE A JVC SERVICE CENTER?
LIKE TO PURCHASE ACCESSORIES?**

JVC IS HERE TO HELP!
TOLL FREE: 1 (800)252-5722
<http://www.jvc.com>

Remember to retain your Bill of Sale for Warranty Service.
Do not attempt to service the product yourself

Caution

To prevent electrical shock, do not open the cabinet.
There are no user serviceable parts inside.
Please refer to qualified service personnel for repairs.

PRODUCT REGISTRATION

We suggest that you register your product since it will enable us to contact you directly if it is ever necessary to correct a safety related condition in your product. You can register at www.register.jvc.com
Please note that failure to register does not diminish any of your rights during the warranty period.

JVC

LIMITED WARRANTY

ONLY FOR PRODUCT PURCHASED IN U.S.A.

JVC Americas Corp. (JVC) warrants this product and all parts thereof, except as set forth below ONLY TO THE ORIGINAL RETAIL PURCHASER to be FREE FROM DEFECTIVE MATERIALS AND WORKMANSHIP from the date of original purchase for the period shown below. ("The Warranty Period")

PARTS 2 YRS / LABOR 2 YRS : Car audio ARSENAL series

PARTS 1 YR / LABOR 1 YR : All other car audio products

THIS LIMITED WARRANTY IS VALID ONLY IN THE FIFTY (50) UNITED STATES, THE DISTRICT OF COLUMBIA AND IN THE COMMONWEALTH OF PUERTO RICO.

WHAT WE WILL DO:

If this product is found to be defective within the warranty period, JVC will repair or replace defective parts with new or rebuilt equivalents at no charge to the original owner. Such repair and replacement services shall be rendered by JVC during normal business hours at JVC authorized service centers. Parts used for replacement are warranted only for the remainder of the Warranty Period. All products may be brought to a JVC authorized service center on a carry-in basis. Color televisions with a screen size of 37" class or greater qualify for in-home service. In such cases, a technician will come to your home and either repair the TV there or remove and return it if it cannot be repaired in your home.

WHAT YOU MUST DO FOR WARRANTY SERVICE:

Please do not return your product to the retailer. Instead, return your product to the JVC authorized service center nearest you. If shipping the product to the service center, please be sure to package it carefully, preferably in the original packaging, and include a brief description of the problem(s) and a copy of the proof of purchase to verify purchase date. Please call 1-800-252-5722 to locate the nearest JVC authorized service center. Service locations can also be obtained from our website <http://www.jvc.com>. If your product qualifies for in-home service, the service representative will require clear access to the product.

If you have any questions concerning your JVC Product, please contact our Customer Care Center at 800-252-5722

WHAT IS NOT COVERED:

This limited warranty provided by JVC does not cover:

1. Products which have been subject to abuse, accident, alteration, modification, tampering, negligence, misuse, faulty installation, lack of reasonable care, or if repaired or serviced by anyone other than a service facility authorized by JVC to render such service, or if affixed to any attachment not provided with the products, or if the model or serial number has been altered, tampered with, defaced or removed;
2. Initial installation, installation and removal from cabinets or mounting systems.
3. Operational adjustments covered in the Owner's Manual, normal maintenance, video and audio head cleaning;
4. Damage that occurs in shipment, due to act of God, and cosmetic damage;
5. Signal reception problems and failures due to line power surge;
6. User Removal Memory Devices/Video Pick-up Tubes/CCD Image Sensors are covered for 90 days from the date of purchase;
7. Accessories;
8. Batteries (except that Rechargeable Batteries are covered for 90 days from the date of purchase);
9. Products used for commercial purposes, including, but not limited to rental.
10. Loss of data resultant from malfunction of hard drive or other data storage device;

There are no express warranties except as listed above.

THE DURATION OF ANY IMPLIED WARRANTIES, INCLUDING THE IMPLIED WARRANTY OF MERCHANTABILITY, IS LIMITED TO THE DURATION OF THE EXPRESS WARRANTY HEREIN. JVC SHALL NOT BE LIABLE FOR ANY LOSS OF USE OF THE PRODUCT, INCONVENIENCE, OR ANY OTHER DAMAGES, WHETHER DIRECT, INCIDENTAL OR CONSEQUENTIAL (INCLUDING, WITHOUT LIMITATION, DAMAGE TO TAPES, RECORDS OR DISCS) RESULTING FROM THE USE OF THIS PRODUCT, OR ARISING OUT OF ANY BREACH OF THIS WARRANTY. ALL EXPRESS AND IMPLIED WARRANTIES, INCLUDING THE WARRANTIES OF MERCHANTABILITY AND FITNESS FOR PARTICULAR PURPOSE, ARE LIMITED TO THE WARRANTY PERIOD SET FORTH ABOVE.

Some states do not allow the exclusion of incidental or consequential damages or limitations on how long an implied warranty lasts, so these limitations or exclusions may not apply to you. This warranty gives you specific legal rights and you may also have other rights which vary from state to state.

JVC AMERICAS CORP.

1700 Valley Road, Wayne, New Jersey 07470

<http://www.jvc.com>

REFURBISHED PRODUCTS CARRY A SEPARATE WARRANTY, THIS WARRANTY DOES NOT APPLY. FOR DETAIL OF REFURBISHED PRODUCT WARRANTY, PLEASE REFER TO THE REFURBISHED PRODUCT WARRANTY INFORMATION PACKAGED WITH EACH REFURBISHED PRODUCT.

For customer use:

Enter below the Model No. and Serial No. which is located either on the rear, bottom or side of the cabinet. Retain this information for future reference.

Model No.: _____

Serial No.: _____

Purchase date: _____

Name of dealer: _____



WARRANTY

Warranty applies only to PRODUCT distributed in Canada by JVC Canada Inc.

JVC CANADA INC. (hereafter called "JVC") gives the following express warranty for each new JVC product distributed in Canada by JVC and sold by an authorized JVC dealer. JVC warrants that this JVC product is free, under normal use and maintenance, from any defects in material and workmanship subject to the following terms and conditions:

- To Obtain Warranty Service:**
 - JVC product requiring service must be presented together with proof of purchase.
 - The JVC product must be brought in for service to an authorized JVC Service Centre.
- Limitation:**
This Warranty shall not apply to:
 - Repair or replacement of any cabinets, batteries, plates, connection cords, antennas, dust covers, knobs, speaker grills, speaker cones, projection screens, projection screen savers, and all accessories.
 - Any defects caused or repairs required as a result of misuse, abusive operation, negligence, improper use and/or insufficient care.
 - Any defect caused or repairs required as a result of not following the instructions in the operation manual.
 - Any JVC product tampered with, adjusted or repaired by any party other than JVC or authorized JVC Service Centre personnel.
 - Any JVC products on which the serial number has been defaced, modified or removed.
 - Maintenance, cleaning or periodic check-up
 - Conversion to foreign or domestic voltage or frequency.
 - Any JVC product without the Canadian Electrical Safety Regulations ID.
 - Any JVC products used for commercial or institutional, rental, or display purposes.
Parts 1 year (except video head - 90 days)
Labour ... 90 days
 - Any JVC product which has been resold and no longer owned by the original purchaser.
 - Product purchased from "outside Canada", "bankruptcy" or "liquidator".
 - Any defects caused by fire, flood, lightning, power surge, or other events beyond the control of JVC.
- FOR AUTO PRODUCTS**
Warranty does not cover elimination of car static or electrical interferences, cleaning of head, adjustments, or labour cost for the removal or reinstallation of the unit for repair.

- Standards:**
If any defects should be found in a JVC product within the applicable terms, necessary repairs shall be made at no cost to the purchaser for parts or labour when JVC acknowledges that such defects are due to faulty material or workmanship.
- Exclusion of All Other Express Warranties:**
This warranty constitutes the entire express warranty given by JVC for JVC products and no dealer or service centre personnel or his, its or their agent or employee is, or are authorized to extend or enlarge this warranty on behalf of JVC.
- Disclaimer of Consequential Damage:**
To the extent the law permits JVC disclaims any responsibility for loss of time or use of its product, transportation costs, or any other indirect, incidental or consequential damage or inconvenience.

WARRANTY TERM (VALID FROM THE DATE OF PURCHASE)

Product	Parts (Years)	Labour (Years)
Projection TV In-Home Service Colour TV In-Home (25" and above) D-ILA Rear Projection In-Home Service LCD TV In-Home Service (25" and above)	1	1
* In-Home service to be provided where available. Where it is not available, the purchaser must assume the responsibility and expense for the proper packing, shipment and all costs associated with the delivery of the equipment to and from the closest JVC Authorized Service Centre.		
Receivers and Home Speakers purchased separately. Front Projection and Car Audio "ARSENAL" Series	2	2
AC Adapters, Remote controls, Headphones, Microphones and Projector lamps	90 days	90 days
Wood Cone Speakers	5	5
All Other Categories	1	1

JVC CANADA INC.

6070 Kestrel Road, Mississauga, Ontario, L5T 1 S8 Canada
 TEL: (905) 670-3381 FAX: (905) 670-7244 Service toll free #: 1-800-964-2650
<http://www.jvc.ca> E-mail: service@jvc.ca

Product Registration

We suggest that you register your product since it will enable us to contact you directly if it is ever necessary to correct a safety related condition in your product. You can register at <http://www.jvc.ca/www/Support/Warranty.aspx>

For customer use:

Enter below the Model No. and Serial No. which is located either on the rear, bottom or side of the cabinet. Retain this information for future reference.

Model No.: _____ Serial No.: _____
 Purchase date: _____ Name of dealer: _____

GARANTIE

La garantie s'applique seulement aux PRODUITS distribués au Canada par JVC Canada Inc.

JVC CANADA INC. (ci-après appelé "JVC") énonce la garantie expresse suivante pour tout nouveau produit JVC distribué au Canada par JVC et vendu par un détaillant JVC autorisé. JVC vous garantit que ce produit est dégage, sous utilisation et entretien normal, de tout défaut matériel et de fabrication sous réserve des modalités et conditions suivantes:

- Pour obtenir un service de garantie:**
 - Les produits JVC nécessitant un service doit être présentée avec la preuve d'achat.
 - Le produit JVC doit être apporté pour service chez un centre de service JVC autorisé.
- Restrictions:**
Cette garantie ne s'applique pas aux:
 - Réparation ou remplacement de tout cabinet, batteries, panneau avant, cordons de raccord, antennes, housses de protection, boutons, couvercles de hautparleur, cônes de hautparleur, écrans de projection, protecteurs d'écran de projection et tous les accessoires.
 - Tous défauts occasionnés ou réparations requises suite à une utilisation abusive, mauvaise, négligente et/ou une utilisation incorrecte.
 - Tous défauts occasionnés ou réparations requises suite à l'omission de suivre les recommandations du manuel d'instruction.
 - Tout produit JVC altéré, ajusté ou réparé par tout autre entreprise que JVC ou un centre de service d'entretien ou de service autorisé JVC.
 - Tout produit JVC dont le numéro de série a été altéré, modifié ou enlevé.
 - L'entretien, les vérifications périodiques et nettoyage.
 - La conversion à une fréquence ou une tension étrangère ou domestique.
 - Tout produit JVC n'ayant pas le signe d'identification qui conforme aux normes électriques Canadiennes (CSA).
 - Pour tout produit utilisé à des fins commerciales, institutionnelles, de location ou utilisé à des fins d'étalage. Pièces 1 An (Excepté les têtes vidéo- 90 jours)
Main d'oeuvre ... 90 Jours
 - Tout produit JVC ayant été revendu et qui n'est plus la propriété de l'acheteur original.
 - Produit acheté à "l'extérieur du Canada", provenant d'une "faillite" ou d'un "liquidateur".
 - Tout dommage causé par le feu, une inondation, un éclair, une surtension ou tout autre événement hors du contrôle de JVC.

(m) POUR LES PRODUITS D'AUTOMOBILE

La garantie ne couvre pas l'élimination d'interférences statiques ou électriques de la voiture, le nettoyage de tête, les ajustements et les coûts de main d'œuvre associés à l'enlèvement ou à la réinstallation de l'unité pour réparation.

- Critères:**
Si un produit JVC s'avérait défectueux, selon les conditions applicables, les réparations nécessaires seront effectués sans coûts additionnels à l'acheteur pour les pièces et la main d'œuvre lorsque JVC reconnaît que de tels défauts sont causés par une défectuosité de matériel ou de fabrication.
- Exclusion de toutes autres garanties expresses :**
Cette garantie constitue l'entière garantie expresse donnée par JVC pour les produits JVC. Nul représentant ou employé d'un détaillant ou d'un service d'entretien n'est autorisé à prolonger cette garantie au nom de JVC.
- Dénégation des dommages indirects:**
Dans la mesure permise par la loi, JVC nie toute responsabilité pour perte de temps ou d'usage de ses produits, des coûts de transport ou tout autre dommage ou inconfort indirect, accidentel et conséquent.

CONDITIONS DE GARANTIE (VALABLE À PARTIR DE LA DATE D'ACHAT)

Produit	Pièces (Années)	Main-D'oeuvre (Années)
Écrans de projection Service à Domicile Écrans de TV Couleur Service à Domicile (25" et plus) TV projection arrière D-ILA Service à Domicile Écrans de LCD Service à Domicile (25" et plus)	1	1
* Service à domicile fourni par un détaillant disponible. S'il n'y a pas de service JVC disponible à proximité, l'acheteur doit assumer la responsabilité et les coûts pour un emballage adéquat, l'expédition, ainsi que tous les coûts associés à la livraison de l'équipement chez et depuis le détaillant JVC autorisé le plus près pour un service d'entretien.		
Récepteurs et Hauts-Parleurs achetés séparément, Projecteur Avant et Audio d'Auto de Série "ARSENAL"	2	2
Adaptateurs AC, Télécommande, Casque D'écoute, Microphones et Lampe de Projecteur	90 Jours	90 Jours
Enceinte à Cône en Bois	5	5
Toutes les autres catégories	1	1

JVC CANADA INC.

6070 Kestrel Road, Mississauga, Ontario, L5T 1 S8 Canada
 TEL: (905) 670-3381 FAX: (905) 670-7244 Service toll free #: 1-800-964-2650
<http://www.jvc.ca> E-mail: service@jvc.ca

Enregistrement du produit

Nous vous conseillons d'enregistrer votre produit, car il nous permettra de vous contacter directement si jamais elle est nécessaire pour corriger un problème lié à la sécurité de votre produit. Vous pouvez vous inscrire à <http://www.jvc.ca/www/Support/Warranty.aspx>

Pour l'utilisation des clients:

Entrez ci-dessous le numéro de modèle et le numéro de série qui se trouve soit à l'arrière, en bas ou sur le côté de l'armoire. Conservez ces informations pour référence future.

No. de modèle: _____ No. de série: _____
 Date d'achat: _____ Nom du revendeur: _____

Free Manuals Download Website

<http://myh66.com>

<http://usermanuals.us>

<http://www.somanuals.com>

<http://www.4manuals.cc>

<http://www.manual-lib.com>

<http://www.404manual.com>

<http://www.luxmanual.com>

<http://aubethermostatmanual.com>

Golf course search by state

<http://golfingnear.com>

Email search by domain

<http://emailbydomain.com>

Auto manuals search

<http://auto.somanuals.com>

TV manuals search

<http://tv.somanuals.com>