



ENGLISH
ESPAÑOL
FRANÇAIS

KW-V41BT/KW-V21BT/KW-V11

MONITOR WITH DVD RECEIVER
INSTRUCTION MANUAL

MONITOR CON RECEPTOR DE DVD
MANUAL DE INSTRUCCIONES

MONITEUR AVEC RÉCEPTEUR DVD
MODE D'EMPLOI

JVCKENWOOD Corporation

This instruction manual is used to describe models listed below.

- Region 1 (DVD Region Code 1 area)/Region 4 (DVD Region Code 4 area)

En este manual de instrucciones se describen los modelos listados a continuación.

- Región 1 (DVD Código de región Área 1)/Región 4 (DVD Código de región Área 4)

Ce mode d'emploi est utilisé pour décrire les modèles de la liste ci-dessous.

- Région 1 (zone de code de région DVD 1)/Région 4 (zone de code de région DVD 4)



CONTENTS

BEFORE USE	2	BLUETOOTH	
How to reset your unit.....	3	(Only for KW-V41BT/KW-V21BT)	30
INITIAL SETTINGS	4	SETTINGS	38
BASICS	5	Sound adjustment	38
Component names and functions	5	Adjustment for video playback.....	39
Common operations.....	6	Changing display design.....	41
Common screen operations.....	8	Customizing the Home screen.....	42
Selecting the playback source.....	9	Customizing the system settings	42
DISCS	10	Setting menu items.....	44
USB	14	REMOTE CONTROLLER	47
iPod/iPhone	15	CONNECTION/INSTALLATION	49
APPS	18	REFERENCES	54
Pandora® (Only for KW-V41BT Region 1/ KW-V21BT Region 1/KW-V11 Region 1)	19	Maintenance	54
TUNER	21	More information	54
SiriusXM® Satellite RADIO (Only for KW-V41BT Region 1/KW-V21BT Region 1)	24	Error message list	57
OTHER EXTERNAL COMPONENTS	29	Troubleshooting.....	59
Using external audio/video players—AV-IN	29	Specifications.....	61
Using a rear view camera	29		

How to read this manual:

- Illustrations of KW-V41BT Region 1 are mainly used for explanation. The displays and panels shown in this manual are examples used to provide clear explanations of the operations. For this reason, they may be different from the actual displays or panels.
- This manual mainly explains operations using the buttons on the monitor panel and touch panel. For operations using the remote controller (RM-RK258: supplied only for KW-V41BT/KW-V21BT Region 4/ KW-V11 Region 4), see page 47.
- < > indicates the various screens/menus/operations/settings that appear on the touch panel.
- [] indicates the buttons on the touch panel.
- **Indication language:** English indications are used for the purpose of explanation. You can select the indication language from the <Settings> menu. (Page 46)
- Updated information (the latest Instruction Manual, system updates, new functions, etc.) is available from <<http://www.jvc.net/cs/car/>>.

BEFORE USE

IMPORTANT

To ensure proper use, please read through this manual before using this product. It is especially important that you read and observe WARNINGS and CAUTIONS in this manual. Please keep the manual in a safe and accessible place for future reference.

⚠ **WARNINGS: (To prevent accidents and damage)**

- DO NOT install any unit or wire any cable in a location where;
 - it may obstruct the steering wheel and gearshift lever operations.
 - it may obstruct the operation of safety devices such as air bags.
 - it may obstruct visibility.
- DO NOT operate the unit while driving. If you need to operate the unit while driving, be sure to look around carefully.
- The driver must not watch the monitor while driving.

For KW-V41BT Region 4/KW-V21BT Region 4/ KW-V11 Region 4:

The marking of products using lasers



The label is attached to the chassis/case and says that the component uses laser beams that have been classified as Class 1. It means that the unit is utilizing laser beams that are of a weaker class. There is no danger of hazardous radiation outside the unit.

BEFORE USE

For KW-V41BT Region 1/KW-V21BT Region 1/ KW-V11 Region 1:

⚠ CAUTION

Use of controls or adjustments or performance of procedures other than those specified herein may result in hazardous radiation exposure. In compliance with Federal Regulations, the following are reproductions of labels on, or inside the product relating to laser product safety.

JVC KENWOOD Corporation
2967-3, ISHIKAWA-MACHI, HACHIOJI-SHI, TOKYO, JAPAN

THIS PRODUCT COMPLIES WITH DHHS RULES 21CFR
SUBCHAPTER J IN EFFECT AT DATE OF MANUFACTURE.

Location : Top plate

FCC WARNING

This equipment may generate or use radio frequency energy. Changes or modifications to this equipment may cause harmful interference unless the modifications are expressly approved in the instruction manual. The user could lose the authority to operate this equipment if an unauthorized change or modification is made.

FCC NOTE

This equipment has been tested and found to comply with the limits for a Class B digital device, pursuant to Part 15 of the FCC Rules. These limits are designed to provide reasonable protection against harmful interference in a residential installation.

This equipment may cause harmful interference to radio communications, if it is not installed and used in accordance with the instructions. However, there is no guarantee that interference will not occur in a particular installation. If this equipment does cause harmful interference to radio or television reception, which can be determined by turning the equipment off and on, the user is encouraged to try to correct the interference by one or more of the following measures:

- Reorient or relocate the receiving antenna.
- Increase the separation between the equipment and receiver.
- Connect the equipment into an outlet on a circuit different from that to which the receiver is connected.

- Consult the dealer or an experienced radio/TV technician for help.

For KW-V41BT Region 1/KW-V21BT Region 1: IC (Industry Canada) Notice

This device complies with Industry Canada license-exempt RSS standard(s).

Operation is subject to the following two conditions:

- (1) This device may not cause interference, and (2) this device must accept any interference, including interference that may cause undesired operation of the device. The term "IC:" before the certification/registration number only signifies that the Industry Canada technical specification were met.

CAUTION

This equipment complies with FCC/IC radiation exposure limits set forth for an uncontrolled environment and meets the FCC radio frequency (RF) Exposure Guidelines in Supplement C to OET65 and RSS-102 of the IC radio frequency (RF) Exposure rules. This equipment has very low levels of RF energy that it deemed to comply without maximum permissive exposure evaluation (MPE). But it is desirable that it should be installed and operated keeping the radiator at least 20 cm or more away from person's body (excluding extremities: hands, wrists, feet and ankles). Under Industry Canada regulations, this radio transmitter may only operate using an antenna of a type and maximum (or lesser) gain approved for the transmitter by Industry Canada. To reduce potential radio interference to other users, the antenna type and its gain should be so chosen that the equivalent isotropically radiated power (e.i.r.p.) is not more than that necessary for successful communication.

- Contains Transmitter Module
FCC ID : XQN-BTR60X
- Contains Transmitter Module
IC: 9688A-BTR601

⚠ Cautions on the monitor:

- The monitor built into this unit has been produced with high precision, but it may have some ineffective dots. This is inevitable and is not considered defective.
- Do not expose the monitor to direct sunlight.

- Do not operate the touch panel using a ball-point pen or similar tool with a sharp tip. Touch the buttons on the touch panel with your finger directly (if you are wearing a glove, take it off).
- When the temperature is very cold or very hot...
 - Chemical changes occur inside, causing malfunction.
 - Pictures may not appear clearly or may move slowly. Pictures may not be synchronized with the sound or picture quality may decline in such environments.

Fors afety...

- Do not raise the volume level too much, as this will make driving dangerous by blocking outside sounds, and may cause hearing loss.
- Stop the car before performing any complicated operations.

Temperature inside the car...

If you have parked the car for a long time in hot or cold weather, wait until the temperature in the car becomes normal before operating the unit.

□ How to reset your unit

If the unit fails to operate properly, press the reset button.

KW-V41BT

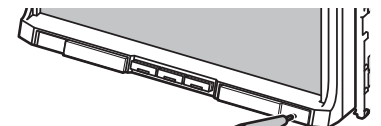

KW-V21BT KW-V11

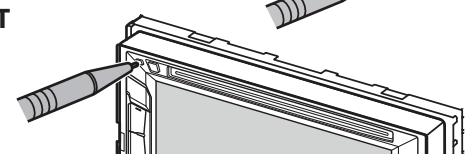

INITIAL SETTINGS

Initial setup

When you power on the unit for the first time or reset the unit, the initial setting screen appears.

- You can also change the settings on the **<Settings>** screen. (Page 44)

1 KW-V41BT



KW-V21BT/KW-V11



<Demonstration> Activate or deactivate the display demonstration. (Page 45)

<Language> Select the text language used for on-screen information.

- Set **<GUI Language>** to display the operation buttons and menu items in the selected language (**[Local]**: initially selected) or English (**[English]**).

<Angle>*1
(Page 7)

Adjust the panel angle.

<AV Input>
(Page 45)

Select an external component connected to the iPod/AV-IN terminal to play.

<R-CAM Interrupt>
(Page 45)
<Panel Color>*1
(Page 41)

Select **[ON]** when connecting the rear view camera.

Select the color of the buttons on the monitor panel.

<User Customize>*2
(Page 41)

Select the display design.

2 Finish the procedure.



The Home screen is displayed.

- [AV Off]** is selected initially. Select the playback source. (Page 9)

*1 Only for KW-V41BT.

*2 Only for KW-V21BT/KW-V11.

Clock settings

1 Display the Home screen.

KW-V41BT

KW-V21BT/KW-V11

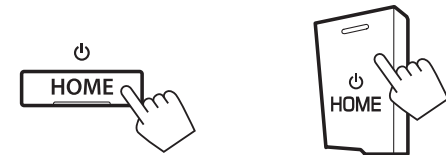

2 Display the **<Settings>** screen.



3 Display the **<Clock>** screen.

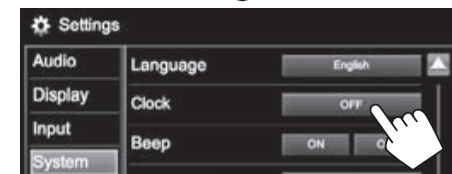
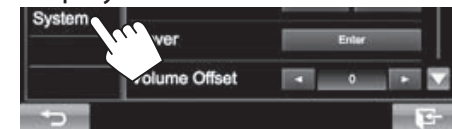

INITIAL SETTINGS

4 Set the clock time.



<Radio Data System> Synchronizes the clock time with FM RBDS.

<OFF> Sets the clock manually. (See below.)

When selecting **<OFF>**:

Adjust the hour (①), then adjust the minute (②).

- Press **[Reset]** to set the minute to "00".



5 Finish the procedure.



BASICS

Component names and functions

⚠ Caution on the volume setting:

Digital devices produce very little noise compared with other sources. Lower the volume before playing these digital sources to avoid damaging the speakers by sudden increase of the output level.

KW-V41BT

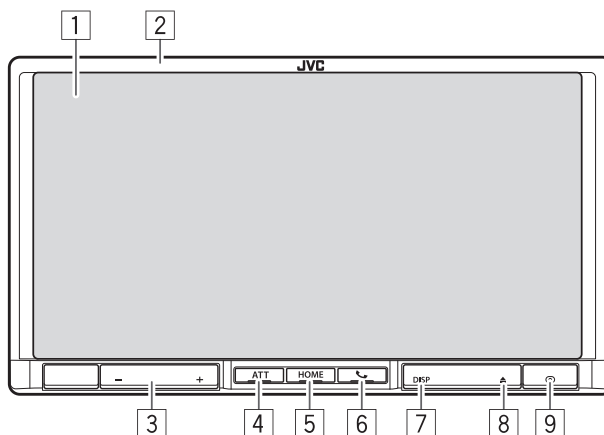

- 1 Screen (touch panel)
- 2 Monitor panel*
- 3 VOLUME -/+ button
Adjusts the audio volume. (Page 7)
- 4 ATT button
Attenuates the sound. (Page 7)

- 5 HOME/⏻ button
 - Displays the Home screen. (Press) (Page 8)
 - Turns on the power. (Press) (Page 6)
 - Turns off the power. (Hold) (Page 6)
- 6 📞/🎤 button
 - Displays the **<Hands Free>** screen. (Press) (Page 33)
 - Activates the voice dialing. (Hold) (Page 35)
- 7 DISP/DISP OFF button
 - Switches the screen. (Press)
 - The screen switched to depends on the **<Navigation Input>** setting (Page 45).
 - Turns off the screen. (Hold) (Page 7)
 - Turns on the screen. (Hold) (Page 7)
- 8 ▲ (Eject) button
 - Ejects the disc (Tilts the monitor panel fully). (Page 10)
- 9 Reset button
 - Resets the unit. (Page 3)

* You can change the color of the buttons on the monitor panel. (Page 41)

BASICS

KW-V21BT/KW-V11

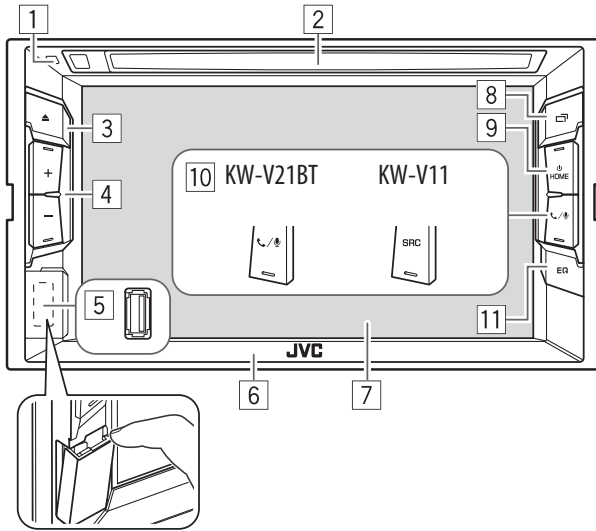

- 1 Reset button
Resets the unit. (Page 3)
- 2 Loading slot
- 3 ▲ (Eject) button
Ejects the disc. (Press) (Page 10)
- 4 Volume +/- button
Adjusts the audio volume. (Page 7)
- 5 USB input terminal (Page 52)
- 6 Monitor panel
- 7 Screen (touch panel)

- 8 button
 - Switches the screen. (Press)
 - The screen switched to depends on the **<Navigation Input>** setting (Page 45).
 - Turns off the screen. (Hold) (Page 7)
 - Turns on the screen. (Hold) (Page 7)
- 9 HOME/ button
 - Displays the Home screen. (Press) (Page 8)
 - Turns on the power. (Press) (See the right column.)
 - Turns off the power. (Hold) (See the right column.)
- 10 **For KW-V21BT:** / button
 - Displays the **<Hands Free>** screen. (Press) (Page 33)
 - Activates the voice dialing. (Hold) (Page 35)
- For KW-V11:** SRC button
Displays the source control screen. (Page 9)
- 11 EQ button
Displays the **<Equalizer>** screen. (Page 38)

Common operations

Turning on the power

KW-V41BT

KW-V21BT/KW-V11



Turning off the power

KW-V41BT

KW-V21BT/KW-V11

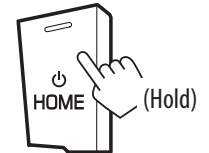

BASICS

Adjusting the volume

To adjust the volume (00 to 35)

KW-V41BT

KW-V21BT/
KW-V11

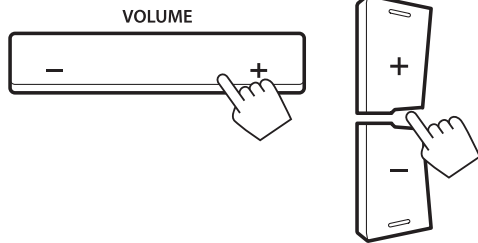

Press + to increase, and press – to decrease.

- Holding the button increases/decreases the volume continuously.

To attenuate the sound (only for KW-V41BT)



The ATT indicator lights up.

To cancel the attenuation: Press the same button again.

Turning off the screen

KW-V41BT

KW-V21BT/KW-V11

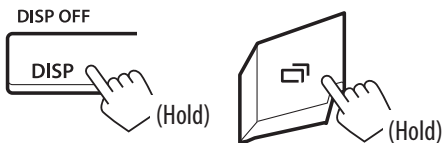

To turn on the screen: Press and hold the same button on the monitor panel, or touch the display.

Turning on/off the AV source

You can activate the AV function by selecting a source.

On the Home screen:



- You can also activate the AV function by selecting a source on the Home screen.

To turn off the AV source:



Adjusting the panel angle (only for KW-V41BT)

1 Display the <Angle Adjust> screen.

On the Home screen:

- Press [▼] repeatedly to change the page on the <Display> menu screen.

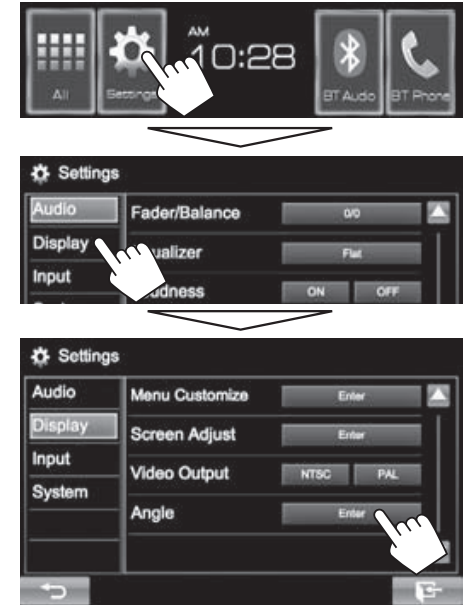

2 Select an angle (0 – 6).

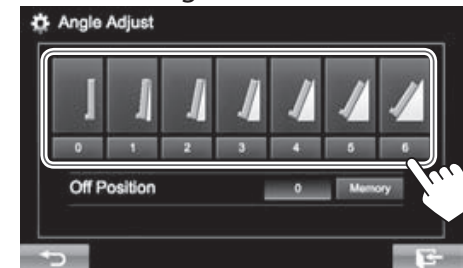

- To set the current position as the power off position, select [Memory] for <Off Position>.

BASICS

Common screen operations

Common screen descriptions

You can display other screens any time to change the source, show the information, or change the settings, etc.

Source control screen

Performs source playback operations.

- The operation buttons vary depending on the selected source.



Gesture control on the source control screen:

You can also control playback by moving your finger on the touch panel as follows (for some sources, the gesture control is not available).

- Sliding the finger towards up/down:** Functions same as pressing [▲]/[▼].
- Sliding the finger towards left/right:** Functions same as pressing [◀]/[▶].
- Moving your finger clockwise or counter-clockwise:** increases/decreases the volume.

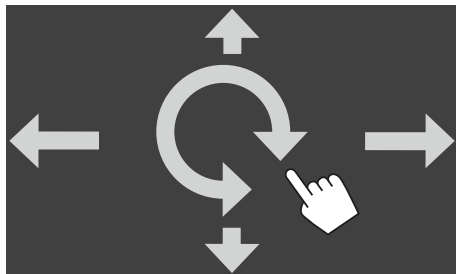

Home screen

Displays the source control screen/settings screen and changes the picture source.

- To display the Home screen, press HOME on the monitor panel.
- You can arrange the items to display on the Home screen. (Page 42)



Common operating buttons:

- Displays all the sources. (Page 9)
- Displays the <Settings> screen. (See below.)
- Changes the playback source. (Page 9)

<Settings> screen

Changes the detailed settings. (Page 44)

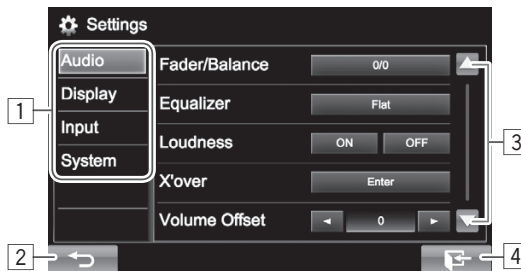

Common operating buttons:

- Selects the menu category.
- Returns to the previous screen.
- Changes the page.
- Displays the current source control screen.

Touch screen operations

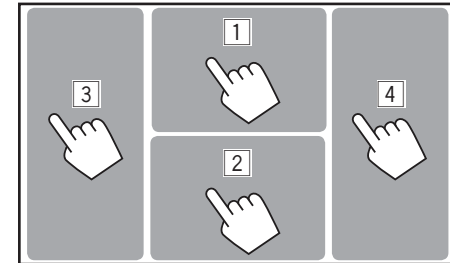

- Displays the video control menu while playing a video.



- Displays the source control screen while playing a video.



- The operation buttons disappear when the screen is touched or when no operation is done for about 5 seconds.

- Goes to the previous chapter/track.*
- Goes to the next chapter/track.*

* Not available for video from an external component. Dragging your finger to the left or right functions in the same way as touching.

BASICS

Selecting the playback source

- 1 Display the Home screen.
KW-V41BT KW-V21BT/KW-V11

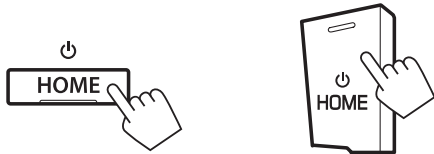

- 2 Display **[All]** screen, then select the source.



- [Tuner]** Switches to the radio broadcast. (Page 21)
- [SiriusXM]*¹** Switches to the SiriusXM® radio broadcast. (Page 24)
- [Disc]** Plays a disc. (Page 10)
- [USB]** Plays files on a USB device. (Page 14)
- [iPod]** Plays an iPod/iPhone. (Page 15)
- [Pandora]*²** Switches to the Pandora broadcast. (Page 19)
- [BT Phone]*³** Displays the **<Hands Free>** screen. (Page 33)
- [BT Audio]*³** Plays a Bluetooth audio player. (Page 37)
- [AV-IN]*⁴** Switches to an external component connected to the iPod/AV-IN terminal on the rear panel. (Page 29)
- [Apps]*⁵** Switches to the App screen from the connected iPod touch/iPhone. (Page 18)
- [AV Off]** Turns off the AV source. (Page 7)
- [Camera]** Displays the picture from the rear view camera. (Page 29)

*¹ Only for KW-V41BT Region 1/KW-V21BT Region 1.
*² Only for KW-V41BT Region 1/KW-V21BT Region 1/KW-V11 Region 1.
*³ Only for KW-V41BT/KW-V21BT.
*⁴ Appears only when **<AV Input>** is set to **[AV-IN]**. (Page 45)
*⁵ Appears only when **<AV Input>** is set to **[iPod]**. (Page 45)

□ Selecting the playback source on the Home screen



- You can change the items (other than **[Settings]**) to display on the Home screen. (Page 42)

DISCS

Playing a disc

- If a disc does not have a disc menu, all tracks on it will be played repeatedly until you change the source or eject the disc.
- For playable disc types/file types, see page 55.

Inserting a disc

Insert a disc with the label side facing up.

KW-V41BT

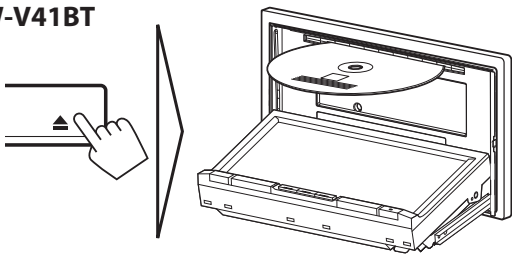

KW-V21BT/KW-V11

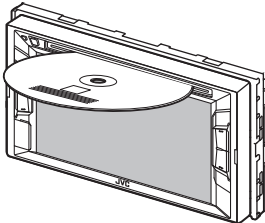

The source changes to **"DISC"** and playback starts.

- The DISC IN indicator lights up while a disc is inserted.

- If "⊘" appears on the screen, the unit cannot accept the operation you have tried to do.
 - In some cases, without showing "⊘," operations will not be accepted.
- When playing back a multi-channel encoded disc, the multi-channel signals are downmixed to stereo.

Ejecting a disc

KW-V41BT



KW-V21BT/KW-V11



- When removing a disc, pull it horizontally.
- You can eject a disc when playing another AV source.
- If the ejected disc is not removed within 15 seconds, the disc is automatically inserted again into the loading slot to protect it from dust.

Closing the monitor panel (only for KW-V41BT)

After removing the disc, press **▲** on the monitor panel. The monitor panel closes.

Playback operations

When the operation buttons are not displayed on the screen, touch the area shown on the illustration.

- To change settings for video playback, see page 39.

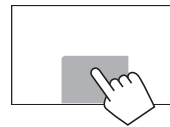

Indications and buttons on the source control screen

For video playback



Playback information

- The information displayed on the screen differs depending on the type of disc/file being played back.

- 1 Media type
- 2 Playback mode (Page 13)
- 3 File type
- 4 DISC IN indicator
- 5 Current playback item information (title no./chapter no./folder no./file no./track no.)
- 6 Playing time

DISCS

Operation buttons

- Available buttons on the screen and operations differ depending on the type of disc/file being played back.

[Mode] Changes the settings for disc playback on the <DVD Mode> or <DISC Mode> screen. (Page 13)

[Folder Left][Folder Right] Selects a folder.

[Repeat][Shuffle] Selects playback mode. (Page 13)

[Search] Displays the folder/track list. (See the far right column.)

[Stop] Stops playback.

[Play/Pause] Starts/pauses playback.

[Chapter/Track Left][Chapter/Track Right]

- Selects a chapter/track. (Press)
- Reverse/forward search. (Hold)

[Title Left] Selects a title.

[Title Right]

For audio playback

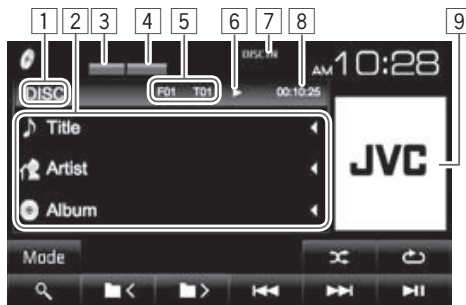

Playback information

- The information displayed on the screen differs depending on the type of disc/file being played back.

- Media type
- Track/file information
 - Pressing [Left] scrolls the text if not all of the text is shown.
- Playback mode (Page 13)
- File type
- Current playback item information (folder no./file no./track no.)
- Playback status
- DISC IN indicator
- Playing time
- Jacket picture (Shown while playing if the file has tag data that includes the jacket picture)

Operation buttons

- Available buttons on the screen and operations differ depending on the type of disc/file being played back.

[Mode] Changes the settings for disc playback on the <DISC Mode> screen. (Page 13)

[Folder Left][Folder Right] Selects a folder.

[Repeat][Shuffle] Selects playback mode. (Page 13)

[Search] Displays the folder/track list. (See the right column.)

[Play/Pause] Starts/pauses playback.

[Chapter/Track Left][Chapter/Track Right]

- Selects a track. (Press)
- Reverse/forward search. (Hold)

Selecting a folder/track on the list

1



2 Select the folder (1), then the item in the selected folder (2).

- Repeat the procedure until you select the desired track.
- If you want to play all tracks in the folder, press [Right] on the right of the desired folder.



- You can change the page to display more items by pressing [Up]/[Down].
- Press [Up] to return to the root folder.
- Press [Up] to return to the upper layer.

DISCS

Video menu operations

You can display the video menu screen during video playback.

- The operation buttons disappear when the screen is touched or when no operation is done for about 5 seconds.

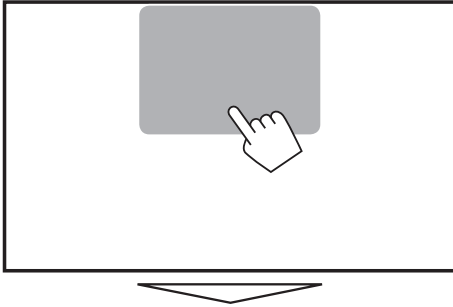

For video playback except VCD

- Available buttons on the screen and operations differ depending on the type of disc/file being played back.



- [Zoom]** Displays the picture size selecting screen. (Page 40)
- [Aspect]** Selects the aspect ratio. (Page 40)
- [Pict Adjust]** Displays the picture adjustment screen. (Page 39)
- [Audio]** Selects the audio type.
- [Subtitle]** Selects the subtitle type.
- [Angle]** Selects the view angle.
- [Menu]** Displays the disc menu (DVD).
- [Top Menu]** Displays the disc menu (DVD).
- [Highlight]** Switches to the direct disc menu mode. Touch the target item to select.
 - To restore the screen, press DISP (for KW-V41BT)/ (for KW-V21BT/KW-V11) on the monitor panel.
- [Cursor]** Displays the menu/scene selecting screen.
 - [▲] [▼] [◀] [▶]: Selects an item.
 - For DivX®: [◀] [▶] skips back or forward by about 5 minutes.
 - [Enter]: Confirms the selection.
 - [Return]: Returns to the previous screen.

For VCD

- [Menu]** Displays the disc menu.
 - [Direct]** Displays/hides the direct selecting buttons. (See below.)
 - [Audio]** Selects the audio channel (ST: stereo, L: left, R: right).
 - [Return]** Displays the previous screen or menu.
 - [Zoom]** Displays the picture size selecting screen. (Page 40)
 - [Aspect]** Selects the aspect ratio. (Page 40)
 - [Pict Adjust]** Displays the picture adjustment screen. (Page 39)
- To deactivate the PBC function, stop playback, then use the direct selecting buttons to select a track number.

To select a track directly on a VCD



- When you enter a wrong number, press **[Direct/CLR]** to delete the last entry.

DISCS

□ Selecting playback mode



[⌂] Selects Random playback mode.

[↺] Selects Repeat playback mode.

- Available playback modes differ depending on the type of disc/file being played back.
- You cannot activate the repeat mode and the random mode at the same time.
- Each time you press the button, the playback mode changes. (The corresponding indicator lights up.)
 - Available items differ depending on the type of disc/file being played back.

CHAP Repeats current chapter.

TITLE Repeats current title.

SONG Repeats current track.

FOLDER Repeats all tracks of the current folder.

FOLDER Randomly plays all tracks of the current folder, then tracks of the next folder.

ALL Randomly plays all tracks.

To cancel Repeat/Random playback: Press the button repeatedly until the indicator disappears.

Settings for disc playback



□ Setting items

- Available items shown on the <DVD Mode> or <DISC Mode> screen differ depending on the type of disc/file being played back.

<Menu Language>	Select the initial disc menu language. (Initial: English) (Page 57)
<Audio Language>	Select the initial audio language. (Initial: English) (Page 57)
<Subtitle Language>	Select the initial subtitle language or turn subtitles off (Off). (Page 57) <ul style="list-style-type: none"> • Initial for KW-V41BT Region 1/ KW-V21BT Region 1/KW-V11 Region 1: Off, for KW-V41BT Region4/KW-V21BT Region 4/ KW-V11 Region 4: English
<Down Mix>	When playing back a multi-channel disc, this setting affects the signals reproduced through the front and/or rear speakers. <ul style="list-style-type: none"> • Dolby Surround: Select this to enjoy multi-channel surround sound by connecting an amplifier compatible with Dolby Surround. • Stereo (initial): Normally select this.

<Dynamic Range Control>	You can change the dynamic range while playing Dolby Digital software. <ul style="list-style-type: none"> • Wide: Select this to enjoy a powerful sound at a low volume level with its full dynamic range. • Normal: Select this to reduce the dynamic range a little. • Dialog (initial): Select this to reproduce movie dialog more clearly.
<Screen Ratio>	Select the monitor type to watch a wide screen picture on the external monitor. <p>16:9 (Initial) 4:3 LB 4:3 PS</p>
<File Type>*	Select the playback file type when a disc contains different types of files. <ul style="list-style-type: none"> • Audio: Plays back audio files. • Still Image: Plays back picture files. • Video: Plays back video files. • Audio&Video (initial): Plays back audio files and video files.

* For playable file types, see page 55. If the disc contains no files of the selected type, the existing files are played in the following priority: audio, video, then still picture.

USB

Connecting a USB device

You can connect a USB mass storage class device such as a USB memory, Digital Audio Player etc. to the unit.

- For details about connecting USB devices, see page 52.
- You cannot connect a computer or portable HDD to the USB input terminal.
- For playable file types and notes on using USB devices, see page 56.

When a USB device is connected...

The source changes to "USB" and playback starts.

- All tracks in the USB device will be played repeatedly until you change the source.

To disconnect the USB device safely:

Press [▲], then disconnect the USB device after "No Device" appears.

Playback operations

When the operation buttons are not displayed on the screen, touch the area shown on the illustration.

- To change settings for video playback, see page 39.

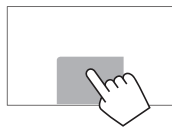

Indications and buttons on the source control screen

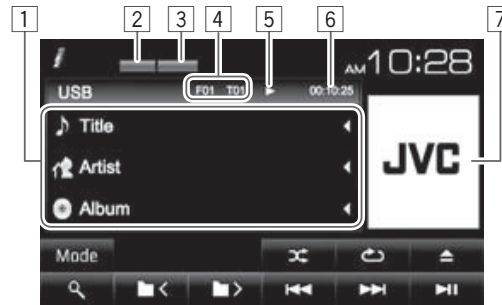

Playback information

- The information displayed on the screen differs depending on the type of file being played back.

- 1 Track/file information
 - Pressing [◀] scrolls the text if not all of the text is shown.
- 2 Playback mode (See the right column.)
- 3 File type
- 4 Current playback item information (folder no./file no.)
- 5 Playback status
- 6 Playing time
- 7 Jacket picture (Shown while playing if the file has tag data that includes the jacket picture)

Operation buttons

- Available buttons on the screen and operations differ depending on the type of file being played back.

[Mode]

Changes the settings on the <USB Mode> screen. (Page 15)

[▲]

Disconnects the USB device safely.

[Folder <]

Selects a folder.

[Folder >]

[Random]

Selects random playback mode.*1 *2

- **FOLDER:** Randomly plays all tracks in the folder.

- **ALL:** Randomly plays all tracks.

Selects repeat playback mode.*1 *2

- **SONG:** Repeats the current track.
- **FOLDER:** Repeats all tracks in the current folder.

[Repeat]

[Search]

Displays the folder/track list. (Page 15)

[Play/Pause]

Starts/pauses playback.

[Previous] [Next]

- Selects a track. (Press)
- Reverse/forward search. (Hold)

*1 To cancel random or repeat mode, press the button repeatedly until the indicator disappears.

*2 You cannot activate the repeat mode and the random mode at the same time.

USB

❑ <USB Mode> settings

Setting <File Type>

- [Audio]** Plays back audio files.
- [Still Image]** Plays back picture files.
- [Video]** Plays back video files.
- [Audio&Video] (Initial)** Plays back audio files and video files.

- For playable files, see page 56. If the USB device contains no files of the selected type, the existing files are played in the following priority: audio, video, then still picture.

Setting <Screen Ratio>

Select the monitor type to watch a wide screen picture on the external monitor.

[16:9] (Initial)



[4:3 LB]



[4:3 PS]



Setting <Drive Select>

Press **[Next]**. Switches between internal memory and the memory source of the connected device (such as mobile phone).

❑ Selecting a folder/track on the list

1



- 2 Select the folder (①), then the item in the selected folder (②).
- Repeat the procedure until you select the desired track.
 - If you want to play all tracks in the folder, press **[▶]** on the right of the desired folder.



- You can change the page to display more items by pressing **[▲]**/**[▼]**.
- Press **[↶]** to return to the root folder.
- Press **[↷]** to return to the upper layer.

iPod/iPhone

- To use iPod touch/iPhone Apps, see page 18.
- To listen to Pandora, see page 19.

Preparation

❑ Connecting iPod/iPhone

- For details about connecting iPod/iPhone, see page 52.
- For playable iPod/iPhone types, see page 56.

Connect your iPod/iPhone using the appropriate cable according to your purpose.

• To listen to music:

- For iPod/iPhone except for iPod nano (7th Generation)/iPod touch (5th Generation)/iPhone 5S/iPhone 5C/iPhone 5: USB 2.0 cable (accessory of iPod/iPhone)
- For iPod nano (7th Generation)/iPod touch (5th Generation)/iPhone 5S/iPhone 5C/iPhone 5: KS-U62 (optional accessory)

• To watch video and listen to music: USB Audio and Video cable for iPod/iPhone—KS-U59 (optional accessory)

- You cannot connect iPod nano (7th Generation)/iPod touch (5th Generation)/iPhone 5S/iPhone 5C/iPhone 5 with KS-U59.

iPod/iPhone

❑ Selecting preference settings for iPod/iPhone playback

When the source is "iPod"...

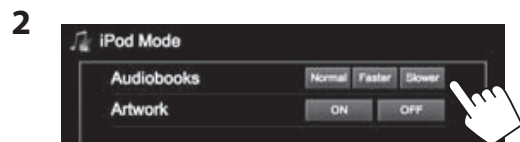

<Audiobooks> Select the speed of audio books.

<Artwork> Shows/hides artwork of iPod.

❑ Setting <AV Input> for iPod/iPhone playback

Select an appropriate input setting for <AV Input> according to the connection method of the iPod/iPhone.

- 1 Turn off the AV source.
On the Home screen:

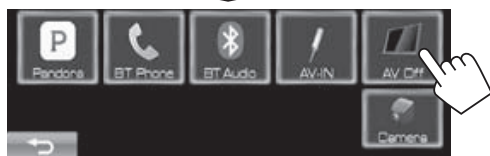
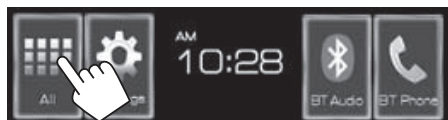

- 2 Display the <Input> setting screen.

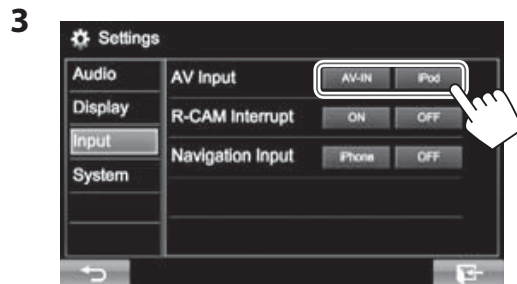
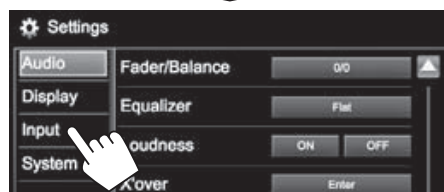

- [AV-IN] Select this when the iPod/iPhone is connected using KS-U62 (optional accessory) or the USB 2.0 cable (accessory of iPod/iPhone).
- [iPod] Select this when the iPod/iPhone is connected using KS-U59 (optional accessory).

Playback operations

When the operation buttons are not displayed on the screen, touch the area shown on the illustration.

- To change settings for video playback, see page 39.

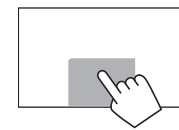

❑ Indications and buttons on the source control screen

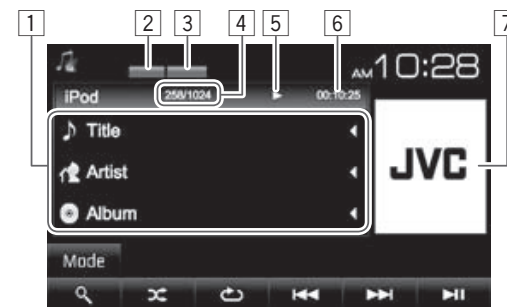

Playback information

- Song/video information
 - Pressing [◀] scrolls the text if not all of the text is shown.
- Playback mode (Page 17)
- File type
- Track no./Total track number
- Playback status
- Playing time
- Artwork (Shown if the song contains Artwork)
 - To change the Artwork display, see the far left column.

iPod/iPhone

Operation buttons

- [Mode]** Changes the settings for iPod/iPhone playback on the <iPod Mode> screen. (Page 16)
- [⏮]** Selects random playback mode.*1
- **ALL:** Functions the same as Shuffle Songs.
 - **ALBUM:** Functions the same as Shuffle Albums.
- [↺]** Selects repeat playback mode.
- **SONG:** Functions the same as Repeat One.
 - **ALL:** Functions the same as Repeat All.
- [🔍]** Displays the audio/video file list. (See the right column.)
- [▶||]** Starts/pauses playback.
- [◀◀] [▶▶]**
- Selects an audio/video file.*2 (Press)
 - Reverse/forward search. (Hold)

*1 To cancel random mode, press the button repeatedly until the indicator disappears.

*2 Resume playback is unavailable for video files.

❑ Selecting an audio/video file from the menu

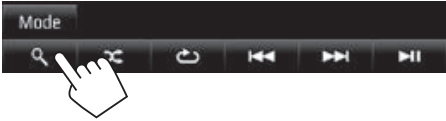
- 1 
- 2 Select the menu (🎵: audio or 📺: video) (①), a category (②), then a desired item (③).
 - Select the item in the selected layer until a desired file starts playing.
 - If you want to play all items in the layer, press [▶] on the right of the desired item.

Audio menu:

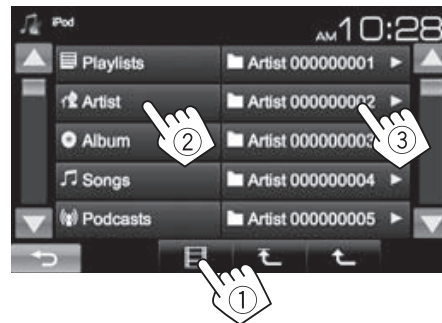

Video menu:

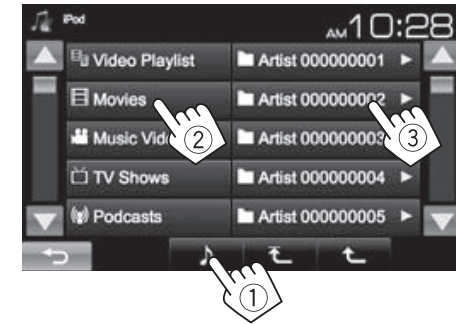

- You can change the page to display more items by pressing [▲]/[▼].
- Press [↶] to return to the root folder.
- Press [↷] to return to the upper layer.
- Available categories differ depending on the type of your iPod/iPhone.

APPs

You can use Apps of the connected iPod touch/iPhone on this unit.

- You cannot use Apps with iPod touch (5th Generation)/iPhone 5S/iPhone 5C/iPhone 5.
- For Apps you can use on this unit, visit <http://www.jvc.net/cs/car/>.

Preparation

- 1 Connect iPod touch/iPhone using KS-U59. (Page 52)
- 2 Select [iPod] for <AV Input>. (Page 16)

Using an App

When the operation buttons are not displayed on the screen, touch the screen to show them.

- To change settings for video playback, see page 39.

❑ Playback operations

- 1 Start the App on your iPod touch/iPhone.
- 2 Select “Apps” as the source.
On the Home screen:



❑ Operation buttons on the source control screen

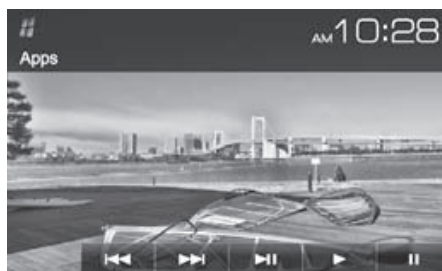

- ▶] Starts playback.
- [||] Pauses playback.
- [◀◀] [▶▶]
 - Selects an audio/video file. (Press)
 - Reverse/forward search. (Hold)
- ▶||] Starts/pauses playback.

- You can operate some functions of the App on the touch panel.
- For some applications such as navigation applications, the operation buttons and information are not shown. You can perform the operations on the touch panel, such as scrolling the map.
 - If “⊘” appears on the screen, the unit cannot accept the touch operation you have tried to do.
- You can also play back the audio/video using iPod/iPhone itself instead of the unit.

❑ Switching to the App screen while listening to another source

- Select [iPhone] for <Navigation Input> beforehand. (Page 45)

KW-V41BT

KW-V21BT/KW-V11

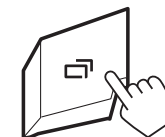
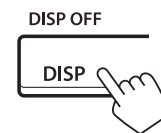

Pandora® (Only for KW-V41BT Region 1/KW-V21BT Region 1/KW-V11 Region 1)

You can stream Pandora from iPod touch/iPhone via a wired connection or from Android devices through Bluetooth.

- Install the latest version of the Pandora application on your iPod touch/iPhone/Android.
- Android devices can only be used with KW-V41BT Region 1/KW-V21BT Region 1.

Preparation

Connect the device, then start the Pandora application.

For Android

- 1 Pair the Android device through Bluetooth. (Page 30)
- 2 Select **"Pandora"** as the source. (Page 9)
- 3 Connect the Android device for using Pandora on the **<Bluetooth Setup>** screen. (Page 32)

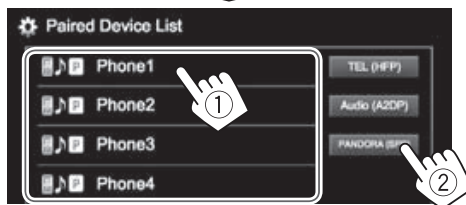
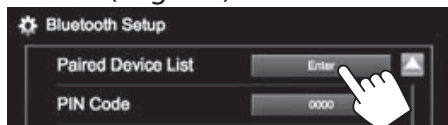

"Connected" appears. Press [OK] to confirm the operation.

When the connection is established, the Pandora application is started and the **"Pandora"** source control screen is displayed.

For iPod touch/iPhone

- 1 Connect the iPod touch/iPhone to the USB terminal using KS-U59, KS-U62 (optional accessory) or USB 2.0 cable (accessory of iPod/iPhone). (Page 52)
- 2 Start the Pandora application on the connected iPod touch/iPhone. The **"Pandora"** source control screen is displayed.

Playback operations

You can operate Pandora using the remote controller. Only playing, pausing, and skipping are available.

Indications and buttons on the source control screen

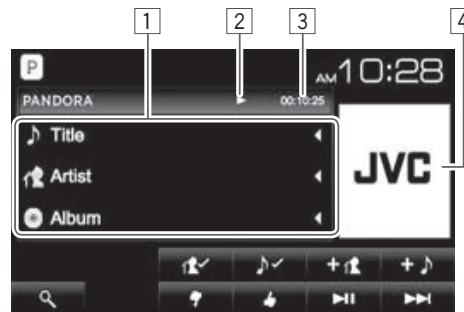

Playback information

- 1 Track information
 - Pressing [◀] scrolls the text if not all of the text is shown.
- 2 Playback status
- 3 Playing time
- 4 Picture data (Shown if available from current content and when iPod touch/iPhone is connected via USB)

Operation buttons

- [👤✓] Bookmarks the artist.
- [🎵✓] Bookmarks the current track.
- [+👤] Adds the current artist to the Station List.
- [+🎵] Adds the current track to the Station List.
- [🔍] Displays the list selecting screen. (Page 20)
- [👎] Thumbs down to the current track and skips to the next track.
- [👍] Registers the current track as a favorite.
- [▶||] Starts/pauses playback.
- [▶▶] Skips the current track.
 - Not available when the Pandora skip reaches its limit.

Pandora®

❑ Selecting a station from the list

- 1 Display the list selecting screen.



- 2 Select the list type.

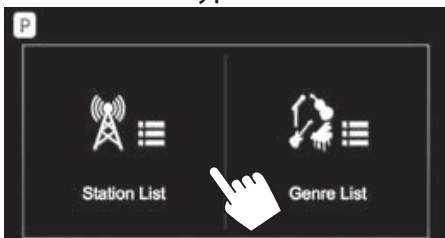

<Station List> Selects from the station names (Station List).

<Genre List> Selects from the genre names (Genre List).

- 3 Select a station from the list.

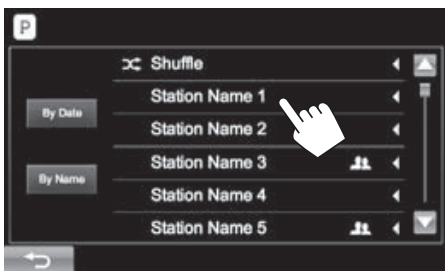

On the Station List



[Shuffle] Plays all the songs in the registered stations randomly.

[By Date] Sorts the list in reverse chronological order.

[By Name] Sorts the list in alphabetical order.

- You can change the page to display more items by pressing [▲]/[▼].
- The  indicator appears on the left of the item when Shuffle is activated. (All songs on the registered stations are played randomly.)
- The  indicator appears on the right of the item when the station is shared.

On the Genre List

Select a genre (①), then a station (②).



- You can change the page to display more items by pressing [▲]/[▼].
- The selected station is added to the Station List.

Requirements for Pandora®

iPhone or iPod touch

- Install the latest version of the Pandora application on your iPhone or iPod touch. (Search for “Pandora” in the Apple iTunes App Store to find and install the most recent version.)
- Connect iPod touch/iPhone to this unit with KS-U59, KS-U62 (optional accessory) or USB 2.0 cable (accessory of iPod/iPhone).

Android™

- Visit Google play and search for Pandora to install.
- Bluetooth must be built in and the following profiles must be supported.
 - SPP (Serial Port Profile)
 - A2DP (Advanced Audio Distribution Profile)

NOTE

- Ensure you are logged in to your smartphone application. If you do not have a Pandora account, you can create one for free from your smartphone or at www.pandora.com.
- Pandora is available only in the U.S./Australia/New Zealand.
- Because Pandora is a third-party service, the specifications are subject to change without prior notice. Accordingly, compatibility may be impaired or some or all of the services may become unavailable.
- Some functions of Pandora cannot be operated from this unit.
- For issues using the application, contact Pandora at pandora-support@pandora.com
- Establish an Internet connection using LTE, 3G, EDGE, or WiFi.

TUNER

Listening to the radio

Preparation: Select the appropriate tuner channel interval for <Area Setting>. (Page 22)

Indications and buttons on the source control screen

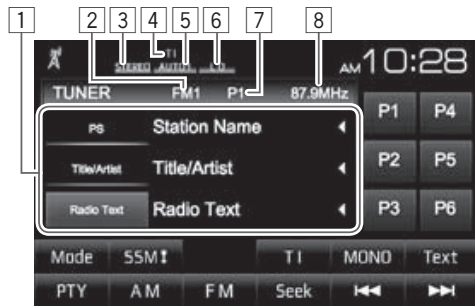

Tuner reception information

- 1 Text information
 - Pressing [**◀**] scrolls the text if not all of the text is shown.
 - Pressing [**Radio Text**] switches the information between Radio Text, Radio Text Plus, and PTY code.
- 2 Band
- 3 STEREO/MONO indicator
 - The STEREO indicator lights up when receiving an FM stereo broadcast with sufficient signal strength.
- 4 TI indicator
- 5 Seek mode
- 6 LO indicator
- 7 Preset no.
- 8 The station frequency currently tuned in

Operation buttons

- [P1] – [P6] • Selects a stored station. (Press)
• Stores the current station. (Hold)
- [Mode] Changes the settings for tuner reception on the <Tuner Mode> screen. (Page 22)
- [SSM] * Presets stations automatically. (Page 22)
- [TI]* Activates/deactivates TI standby reception mode. (Page 23)
- [MONO]* Activates/deactivates monaural mode for better FM reception. (Stereo effect will be lost.)
• The MONO indicator lights up while monaural mode is activated.
- [Text] Changes the display information. (See the right column.)
- [PTY]* Enters PTY search mode. (Page 23)
- [AM] Selects the AM band.
- [FM] Selects the FM band.
→ FM1 → FM2 → FM3
- [Seek] Changes the seek mode.
 - **AUTO1**: Auto Search
 - **AUTO2**: Tunes in stations in the memory one after another.
 - **MANUAL**: Manual Search
- [◀▶] Searches for a station.
 - The search method differs according to the selected seek mode. (See above.)

* Appears only when FM is selected as the source.

Changing the display information

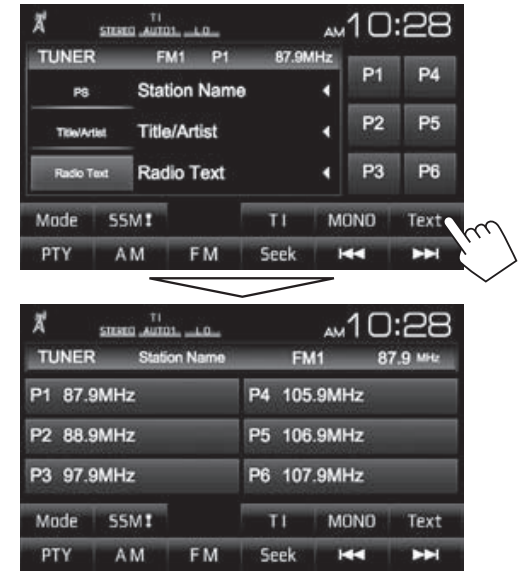

- The preset list containing the station names for FM RBDS (when a PS signal is coming in) is displayed.
- Press [**Text**] again to display the text information for the station currently being received.

TUNER

❑ Tuning in FM stations only with strong signals—Local seek

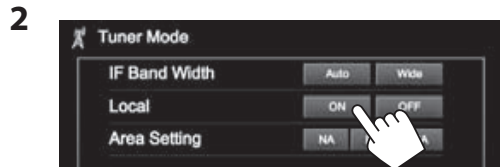

- [ON] Select this to tune in only to stations with sufficient signal strength. The LO indicator lights up.
- [OFF] Deactivate the function.

❑ Reducing interference during FM reception



- [Auto] Increases the tuner selectivity to reduce interference between adjacent stations. (Stereo effect may be lost.)
- [Wide] Subject to interference from adjacent stations, but sound quality will not be degraded and the stereo effect will remain.

❑ Changing the tuner channel interval

The tuner channel interval changes depending on the area you use this unit.



- [NA] Select this when using in North/Central/South America. FM/AM intervals are set to 200 kHz/10 kHz.
- [EU] Select this when using in any other areas. FM/AM intervals are set to 50 kHz/9 kHz.
- [SA] Select this when using in South American countries where FM interval is 50 kHz. AM interval is set to 10 kHz.
- The initial setting is [NA] for KW-V41BT Region 1/KW-V21BT Region 1/KW-V11 Region 1, and [SA] for KW-V41BT Region 4/KW-V21BT Region 4/KW-V11 Region 4.

Presetting stations

❑ Storing stations in the memory

You can preset 6 stations for each band.

Automatic resetting—SSM (Strong-station Sequential Memory) (For FM only)



Local stations with the strongest signals are found and stored automatically.

Manual presetting

- 1 Tune in to a station you want to preset. (Page 21)
- 2 Select a preset number.

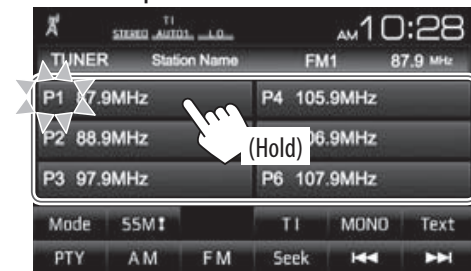

The station selected in step 1 is stored.

TUNER

❑ Selecting a preset station



FM RBDS features

❑ Searching for FM RBDS programs—PTY Search

You can search for your favorite programs being broadcast by selecting the PTY code for your favorite programs.

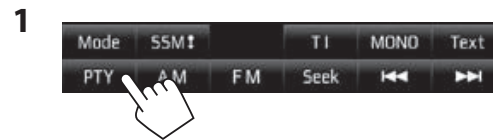

2 Select a PTY code.

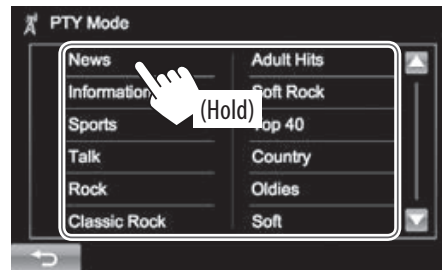

- You can change the page to display more items by pressing [▲]/[▼].

PTY Search starts.

If there is a station broadcasting a program of the same PTY code as you have selected, that station is tuned in.

❑ Activating/deactivating TI Standby Reception



The unit is in standby to switch to Traffic Information (TI) if available. (The TI indicator lights up in white.)

- If the TI indicator is lit in orange, tune into another station providing RBDS signals.

To deactivate TI Standby Reception: Press [TI]. (The TI indicator turns off.)

- The volume adjustment for Traffic Information is automatically memorized. The next time the unit switches to Traffic Information, the volume is set to the previous level.

SiriusXM® Satellite RADIO (Only for KW-V41BT Region 1/KW-V21BT Region 1)

Only SiriusXM® brings you more of what you love to listen to, all in one place. Get over 140 channels, including commercial-free music plus the best sports, news, talk, comedy and entertainment. Welcome to the world of satellite radio. A SiriusXM Vehicle Tuner and Subscription are required. For more information, visit www.siriusxm.com.

Activating subscription

- 1 Check your Radio ID.
The SiriusXM Satellite Radio ID is required for activation and can be found by tuning to Channel 0 as well as on the label found on the SiriusXM Connect tuner and its packaging.
 - The Radio ID does not include the letters I, O, S or F.
- 2 Activate the SiriusXM Connect Vehicle Tuner using one of the two methods below:
 - For users in U.S.A:
 - Online: Visit www.siriusxm.com/activatenow
 - Phone: Call SiriusXM Listener Care at 1-866-635-2349
 - For users in Canada:
 - Online: Visit www.siriusxm.ca/activatexm
 - Phone: Call XM customer Care at 1-877-438-9677

- 3 When the following screen appears, press **[Enter]**.

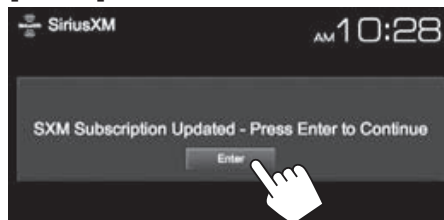

Listening to the SiriusXM® Satellite Radio

- **Indications and buttons on the source control screen**

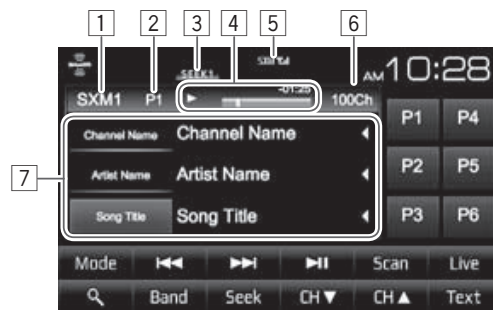

SiriusXM® Satellite Radio reception information

- 1 Band
- 2 Preset number
- 3 Seek mode
- 4 Information for the buffered data and the replay mode (Page 26)
- 5 Signal strength indicator
- 6 Channel number
- 7 Text information
 - Pressing [**◀**] scrolls the text if not all of the text is shown.

Operation buttons

- [P1] – [P6]**
 - Selects a stored channel. (Press)
 - Stores the current channel. (Hold)
- [Song Title]/ [Content Info]/ [Category]** Changes the displayed information each time this button is pressed.
- [Mode]** Changes the settings for Sirius XM Satellite Radio reception on the **<SiriusXM Mode>** screen. (Pages 26 – 28)
- [◀◀] [▶▶]** Skips or rewinds/fast forwards the content during replay mode. (Page 26)
- [Scan]** Scans the first 6 seconds of the buffered contents of the preset channels and the currently tuned channel. (Page 27)
- [Live]** Returns to the live position from the replay mode. (Page 26)
- [Text]** Displays/hides the information of the current channel. (Page 25)
- [▶ III]** Starts/pauses the content replay. (Page 26)
- [🔍]** Obtain information on channels or select a category and then a channel. (Page 25)
- [Band]** Selects the band.
➔ SXM1 ➔ SXM2 ➔ SXM3 ➔ SXM4
- [Seek]** Changes the seek mode.
 - **SEEK1**: Skip to another available channel.
 - **SEEK2**: Skip to another preset channel.
- [CH▼]/[CH▲]** Selects the channel.

SiriusXM® Satellite RADIO

❑ Changing the display information



The preset list containing the channel names is displayed.

- Press **[Text]** again to display the text information for the station currently being received.

Presetting channels

❑ Storing channels in the memory

You can preset 6 channels for each band.

- 1 Tune in to a channel you want to preset. (Page 24)
- 2 Select a preset number.

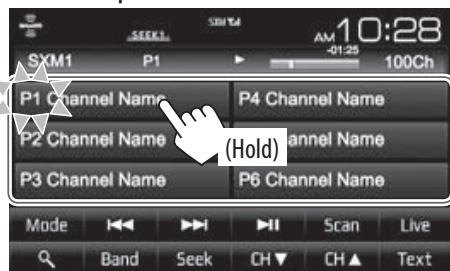

The channel selected in step 1 is stored.

❑ Selecting a preset channel



Selecting a channel

❑ Selecting a channel on the list

You can obtain information on channels or select a category and then a channel.

- 1 Display the **<List Type Select>** screen.



- 2 Select the list type.

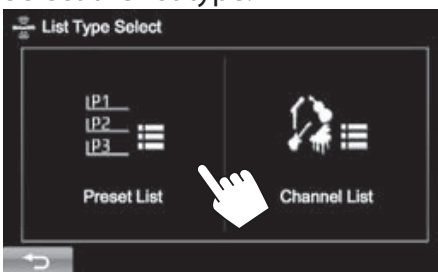

<Preset List> Selects from the preset list.
 • To preset the channels, see the left column.

<Channel List> Selects from the channel names (Channel List).

- 3 Select a channel.

On the **<Preset List>** screen

Select a band (1), and then select a preset channel (2).

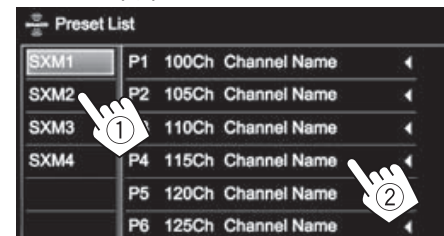

On the **<Channel List>** screen

Select a category (1), and then select a channel (2).

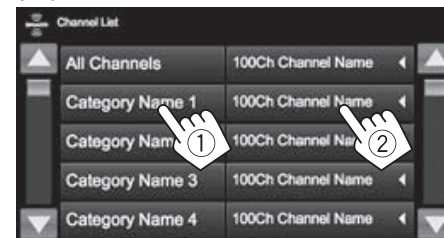

- You can change the page to display more items by pressing **[▲]/[▼]**.
- To list all the channels, select **[All Channels]**.



- Pressing the info change button above the list displays information in the following order: Channel Name, Artist Name, Song Title, Content Info.



SiriusXM® Satellite RADIO

Replay

You can pause, rewind and replay content from the currently tuned channel.

- The SiriusXM Connect Vehicle Tuner continually buffers up to 60 minutes of audio.
- If you change to another channel during playback, the Replay buffer content will be lost.

▣ Indications on the source control screen



1 Playback status

2 Progress bar

Shows the remaining capacity (black) and the amount of buffered content (gray). If the Replay buffer is full, the entire bar is indicated in blue.

- Updated every second.

3 Time code

Shows you the point in the Replay buffer you are listening to.

- Example: -5:00
 - You are listening to audio that is 5 minutes behind the current broadcast.
- Updated every second.

▣ Replaying content



- To pause the playback, press [▶||].
- To skip the current track/segment, press [◀◀] / [▶▶].
 - Pressing [◀◀] within 2 seconds of the beginning of the current track/segment returns to the previous track.
 - Pressing [◀◀] after 2 seconds or more of the track have been replayed returns to the beginning of the current track/segment.
- To rewind/fast forward, press and hold [◀◀] / [▶▶].
- To return to the live position, press [**Live**].

SmartFavorites

User stored channels (P1 to P6) are recognized as SmartFavorites channels. SiriusXM Connect Vehicle Tuner automatically buffers their broadcast content in the background. When you select a SmartFavorite channel, you can rewind and replay up to 30 minutes of any of the missed news, talk, sports or music content.

- SmartFavorites is available only when you connect a SXV200 or later Sirius XM Connect Vehicle Tuner.
- If you change band, the buffered contents are cleared.

TuneStart™

When you select a preset channel, you can listen to the song from the beginning.

Activating TuneStart™

1



2



To deactivate TuneStart: Select [**OFF**] for <Tune Start>.

SiriusXM® Satellite RADIO

TuneScan™

You can check the buffered contents by scanning the first 6 seconds of the buffered contents of the preset channels and the currently tuned channel.



The unit starts scanning.

- To select the previous/next content, press [**◀◀**] or [**▶▶**].
- To finish scanning and continue playing contents, press [**Scan**].
- To exit scanning, press and hold [**Scan**].

Setting reception restrictions

□ Setting the parental control

You can set the parental control in order to, for example, restrict children from receiving adult channels.

Setting/Changing the parental code

- The initial setting is "0000."
- Changing the code does not change the **<Parental Control>/<Parental Lock Channel>** settings.

- 1 Display the **<Parental Code Check>** screen.

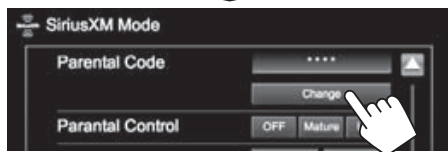

- 2 Enter a four-digit code (①), and then confirm (②).

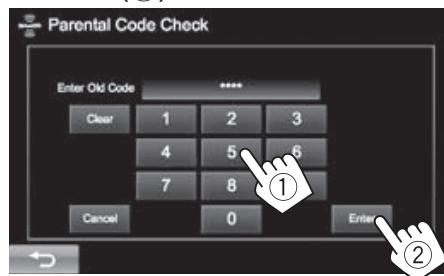

- To clear the entry, press [**Clear**].
- To cancel setting the code, press [**Cancel**].

- 3 Enter a new four-digit code (①), and then confirm (②).

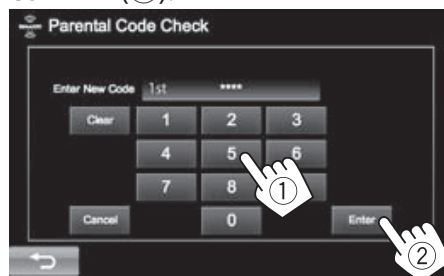

- To clear the entry, press [**Clear**].
- To cancel setting the code, press [**Cancel**].

- 4 Enter the four-digit code and then press [**Enter**] again to confirm the code.

Activating/Deactivating the parental control

You can set the parental control for all channels classified as "mature" by SiriusXM® or for selected channels by user.

- 1



- 2



[OFF] Deactivates the parental mature and user lock.

[Mature] Activates the parental mature control.

[User] Locks only the selected channels.

- 3 Enter the parental code to confirm your choice.

SiriusXM® Satellite RADIO

Selecting the channels to lock—Parental Lock Channel

This parental control option allows you to pick the channels to be locked by the parental control feature.

- When **<Parental Control>** is set to **[Mature]** or **[OFF]**, you cannot change the **<Parental Lock Channel>** setting.



2 Enter the parental code.

3 Select a category (①), and then a channel (②).



- You can change the page to display more items by pressing **[▲]/[▼]**.
- To list all the channels, select **[All Channels]**.
- A checkmark appears beside the selected channel.

Repeat this step if you want to set the lock on multiple channels.

To deactivate the parental lock for all locked channels: Select **[All Clear]** for **<Parental Lock Channel>** on the **<SiriusXM Mode>** screen, then enter the parental code number.

☐ Skipping unwanted channels

If you do not want to receive some channels, you can skip them.

Activating the channel skipping



2 Select a category (①), and then select a channel (②)



- You can change the page to display more items by pressing **[▲]/[▼]**.
- To list all the channels, select **[All Channels]**.
- A checkmark appears beside the selected channel.

Repeat this step if you want to skip multiple channels.

To clear the channel skipping for all skipped channels: Press and hold **[All Clear]** in **<Channel Skipping>** on the **<SiriusXM Mode>** screen.

☐ Resetting the SiriusXM Satellite Radio settings

You can reset the SiriusXM Satellite Radio settings you made and restore the default settings.



- Press **[▼]** repeatedly to change the page on the **<SiriusXM Mode>** screen.



OTHER EXTERNAL COMPONENTS

Using external audio/video players—AV-IN

When the operation buttons are not displayed on the screen, touch the area shown on the illustration.

- To change settings for video playback, see page 39.

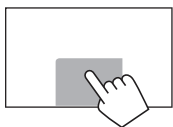

You can connect an external component to the iPod/AV-IN terminal. (Page 52)

Preparation:

Select **[AV-IN]** for **<AV Input>**. (Page 45)

- <AV Input>** can be changed only when **<Navigation Input>** is set to **[OFF]**. (Page 45)

Indications and buttons on the source control screen



Playback information

- AV-IN name

Operation buttons

[Mode] Changes the AV-IN name.

- Press **[◀]** or **[▶]** to select an AV-IN name.

Starting playback

- Connect an external component to the iPod/AV-IN terminal.
 - To connect an external component, see page 52.
- Select **"AV-IN"** as the source. (Page 9)
- Turn on the connected component and start playing the source.

Using a rear view camera

- To connect a rear view camera, see page 52.
- To use a rear view camera, a REVERSE lead connection is required. (Page 51)

Activating the rear view camera

- Display the **<Input>** setting screen. On the Home screen:

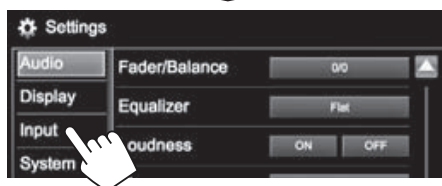
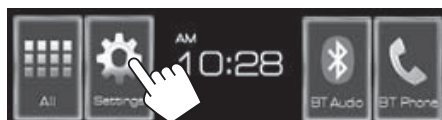

-
-

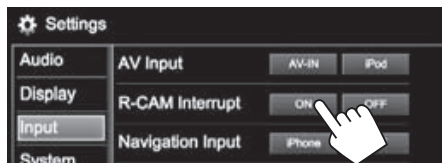

To deactivate: Select **[OFF]** for **<R-CAM Interrupt>**.

Displaying the picture from the rear view camera

The rear view screen is displayed when you shift the gear to the reverse (R) position.



- To erase the caution message, touch the screen.
- You can change the setting of the picture using **[Zoom]/[Aspect]/[Pict Adjust]**. (Page 39)

To display the picture from the rear view camera manually

On the Home screen:

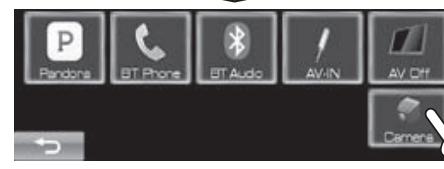

To exit the rear view screen: Press HOME on the monitor panel.

BLUETOOTH (Only for KW-V41BT/KW-V21BT)

Information for using Bluetooth® devices



Bluetooth is a short-range wireless radio communication technology for mobile devices such as mobile phones, portable PCs, and other devices. Bluetooth devices can be connected without cables and communicate with each other.

Notes

- While driving, do not perform complicated operations such as dialing numbers, using the phonebook, etc. When you perform these operations, stop your car in a safe place.
- Some Bluetooth devices may not connect to this unit depending on the Bluetooth version of the device.
- This unit may not work for some Bluetooth devices.
- Connecting conditions may vary depending on your environment.
- For some Bluetooth devices, the device is disconnected when the unit is turned off.

Bluetooth Information: If you wish to receive more information about Bluetooth, visit the following JVC web site:
<<http://www.jvc.net/cs/car/>>

Connecting Bluetooth devices

❑ Registering a new Bluetooth device

When you connect a Bluetooth device to the unit for the first time, pair the unit and the device. Pairing allows Bluetooth devices to communicate with each other.

- The pairing method differs depending on the Bluetooth version of the device.
 - For devices with Bluetooth 2.1: You can pair the device and the unit using SSP (Secure Simple Pairing) which only requires confirmation.
 - For devices with Bluetooth 2.0: You need to enter a PIN code both on the device and unit for pairing.
- Once the connection is established, it is registered in the unit even if you reset the unit. Up to 5 devices can be registered in total.
- Only one device for Bluetooth phone and one for Bluetooth audio can be connected at a time.
- To use the Bluetooth function, you need to turn on the Bluetooth function of the device.
- To use the registered device, you need to connect the device to the unit. (Page 32)

Auto pairing

When <Auto Pairing> is set to [ON], iOS device (such as iPhone) is automatically paired when connected via USB. (Page 46)

Pairing a Bluetooth device using SSP (for Bluetooth 2.1)

When the Bluetooth device is compatible with Bluetooth 2.1, a pairing request is sent from an available device.

- 1 Search “JVC KW-V” from your Bluetooth device.
- 2 Confirm the request both on the device and the unit.



- Press [**Cancel**] to reject the request.

BLUETOOTH

Pairing a Bluetooth device using a PIN code (for Bluetooth 2.0)

- 1 Display the **<Bluetooth Setup>** screen.
On the Home screen:
 - Press [▼] repeatedly to change the page on the **<System>** menu screen.

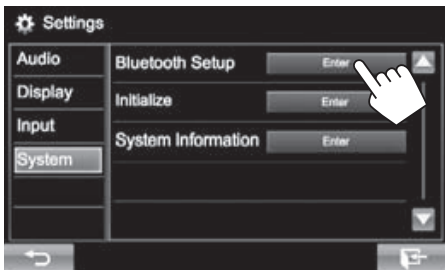
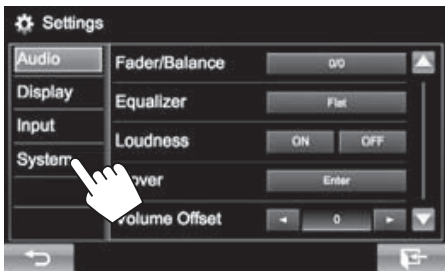

- 2 Change the PIN code.
 - If you skip changing the PIN code, go to step 3.
 - The PIN code is initially set to "0000".
 - The maximum number of digits in the PIN code is 16.

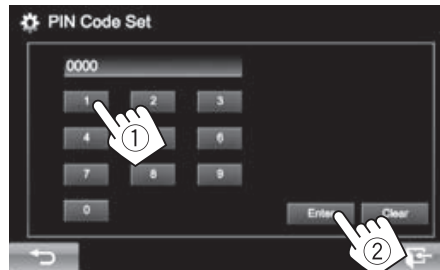
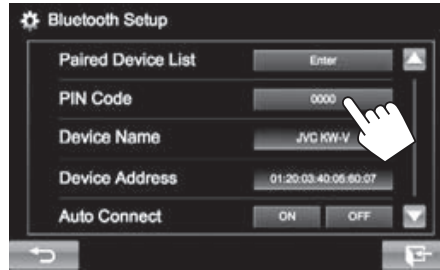

- Press [Clear] to delete the last entry.
- 3 Search "JVC KW-V" from your Bluetooth device.

- 4 Select "JVC KW-V" for your Bluetooth device.

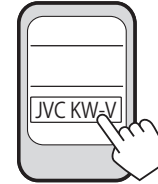

- If the PIN code is required, enter "0000" (initial).



When pairing is complete, the device is listed on **<Paired Device List>**.

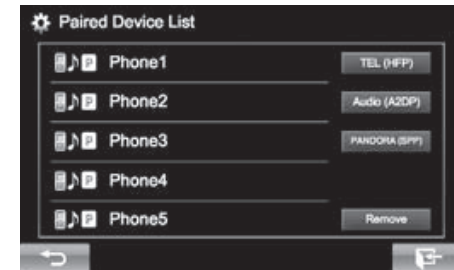

- To use the paired device, connect the device on **<Paired Device List>**. (Page 32)

BLUETOOTH

Connecting a registered Bluetooth device

1 Display the **<Bluetooth Setup>** screen. (Page 31)

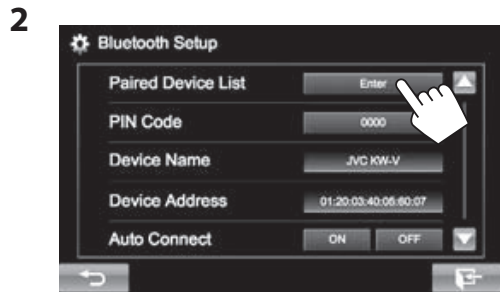

3 Select the device you want to connect (①), then select what you want to use the device for (②).



[TEL (HFP)]: for mobile phone

[Audio (A2DP)]: for Bluetooth audio player

[PANDORA (SPP)]: for Pandora*

- Selectable items depend on the device you are operating.
- If you connect a device while another device is connected, the device previously connected is disconnected and the connection for the newly connected device is established.

- When a Bluetooth mobile phone is connected, the signal strength and battery level are displayed when the information is acquired from the device.

To disconnect

Select **[TEL (HFP)]**, **[Audio (A2DP)]**, or **[PANDORA (SPP)]*** to disconnect the Bluetooth device being used for that function on the **<Paired Device List>** screen (see the left column).

* **[PANDORA (SPP)]** appears only for KW-V41BT Region 1/ KW-V21BT Region 1.

Deleting a registered Bluetooth device

1 Display the **<Bluetooth Setup>** screen. (Page 31)

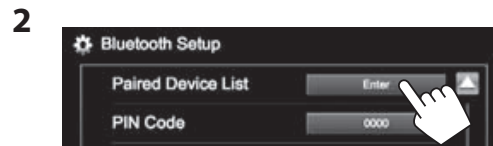

3 Select a device to delete (①), then delete the registration (②).

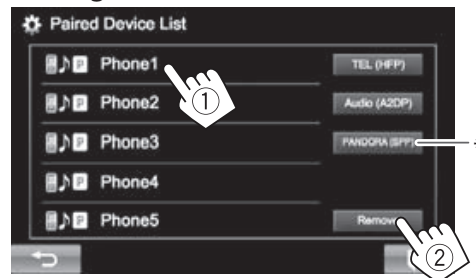

A confirmation message appears. Press **[Yes]**.

* **[PANDORA (SPP)]** appears only for KW-V41BT Region 1/ KW-V21BT Region 1.

Using the Bluetooth mobile phone

Receiving a call

When a call comes in...

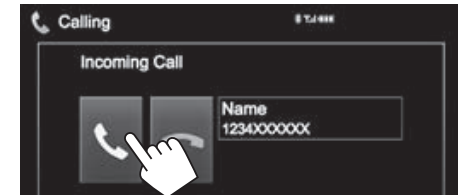

- Call information is displayed if acquired.
- Phone operation is not available while the picture from the rear view camera is displayed. (Page 29)

To reject a call

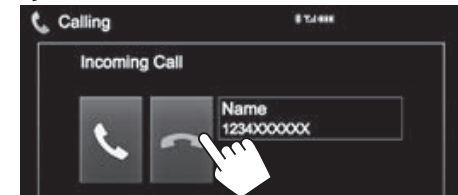

When <Auto Response> is set to [ON] (Page 37)

The unit answers the incoming call automatically.

Ending a call

While talking...



BLUETOOTH

Adjusting the volume of calls/earpiece/microphone

While talking...



- You can adjust the volume level between -20 to +8 (initial: 0).
- Use the monitor panel to adjust the call/earpiece volume. (Page 7)

Switching between handsfree mode and phone mode

While talking...

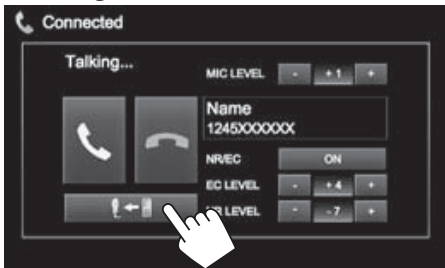

Each time you press the button, the talking method is switched (📞←📱: handsfree mode / 📞→📱: phone mode).

Notification when SMS is received

If the mobile phone is compatible with SMS (Short Message Service), the unit tells you a message has been received when <SMS Notify> is set to [ON]. (Page 37)

- To read a received message, operate the mobile phone after stopping the car in a safe place.
 - You cannot read, edit, or send a message through the unit.
- For some mobile phones, the notification message may not be shown even if the SMS function is supported.

Reducing noise/adjusting the echo cancel level

While talking...

Activate the noise reduction/echo cancel function (①), then adjust the level (②).



- **To adjust the echo volume (between 1 to 10, initial: 4):** Adjust <EC LEVEL>.
- **To adjust the noise reduction volume (between -5 to -20, initial: -7):** Adjust <NR LEVEL>.

Making a call

- 1 Display the <Hands Free> screen. On the Home screen:

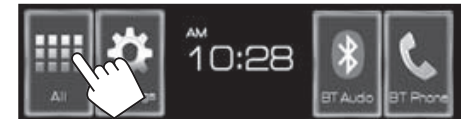

- You can also display the <Hands Free> screen by pressing 📞/📱 on the monitor panel.
- 2 Select a method to make a call.

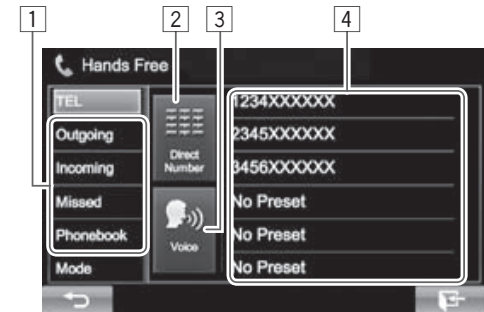

- 1 From the phone book/call lists
- 2 Direct number entry
- 3 Voice dialing
- 4 Preset list
 - To preset, see page 35.

BLUETOOTH

From the phone book/call lists



- [Outgoing]** From the dialed call list
- [Incoming]** From the received call list
- [Missed]** From the missed call list
- [Phonebook]** From the phone book
 - To copy the phone book, see page 35.

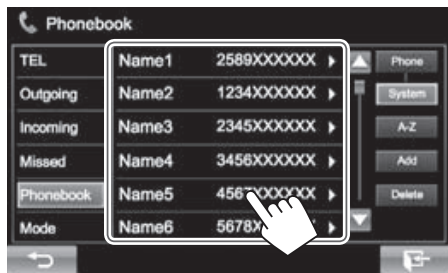

- You can change the page to display more items by pressing [▲]/[▼].



- To use the A to Z search in the phone book:
When the <Phonebook> screen is displayed, you can search by initial.

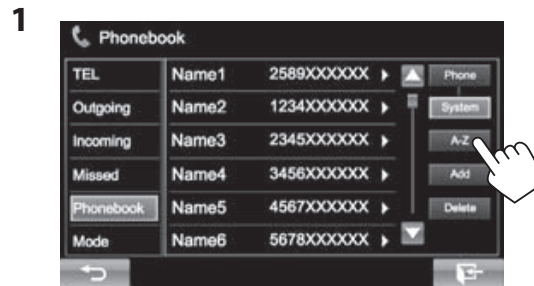

- 2 Select the initial.
 - If the initial is not a letter or number, press **[Others]**.



- 3 Select a phone number from the list.

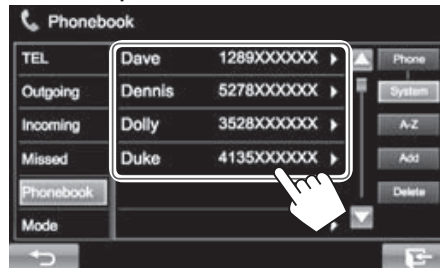

- To display the details of an entry:
When the <Phonebook> is displayed, you can display the details of an entry and select a phone number if several phone numbers are registered.

- 1 Display the details of the desired entry.

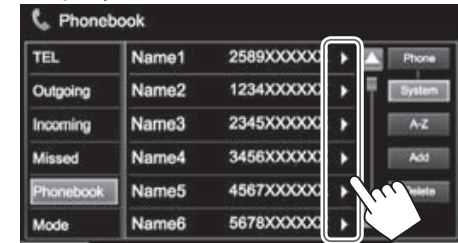

- 2 Select a phone number to call.

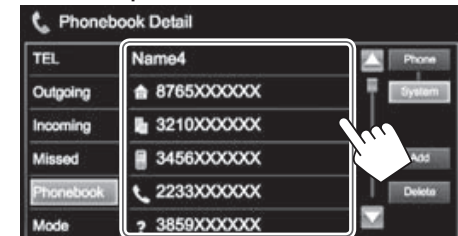

Direct number entry

You can enter up to 32 numbers.

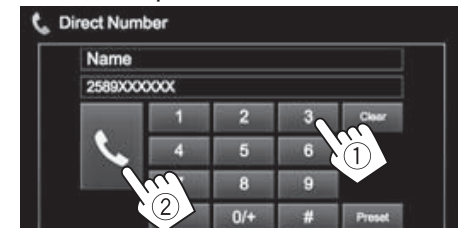

- Press **[Clear]** to delete the last entry.
- Press and hold **[0+]** to add "+" to the phone number.
- Press **[Preset]** to save the entered phone number onto the preset list.

BLUETOOTH

Voice dialing

- Available only when the connected mobile phone has a voice recognition system.

1 Activate voice dialing.

On the <Hands Free> screen:



On the monitor panel:

KW-V41BT

KW-V21BT

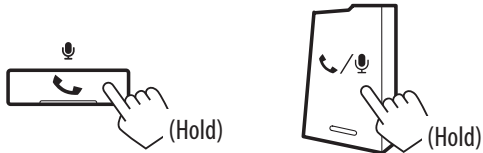

2 Say the name of the person you want to call.

- If the unit cannot find the target, the following screen appears. Press [Start], then say the name again.



To cancel voice dialing: Press [Cancel].

☐ Presetting phone numbers

You can preset up to 6 phone numbers.

1 Display the <Hands Free> screen. (Page 33)

2 Select an item from the phone book/call lists. (Page 34)

3 Select a phone number.

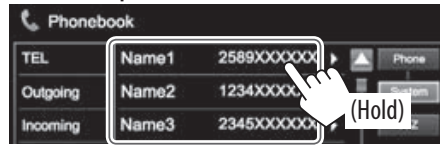

4 Select a preset number to store into.

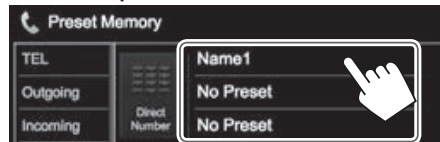

- You can also preset a phone number entered on the <Direct Number> screen by pressing [Preset]. (Page 34)

To delete the preset phone numbers: Initialize the settings from <Initialize> in <Bluetooth Setup>. (Page 46)

☐ Copying the phone book

You can copy the phone book memory of a mobile phone into the unit (up to 400 entries).

1 Display the <Hands Free> screen. (Page 33)

2



3

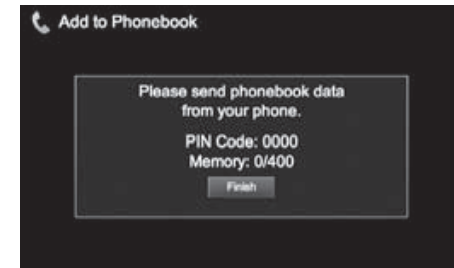
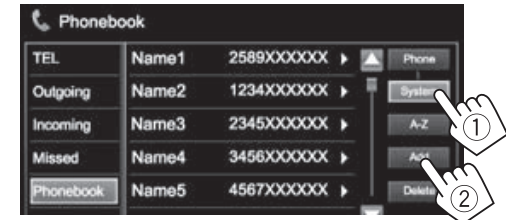

The PIN code (initial: 0000) necessary for copying the phonebook from the mobile phone and the number of copied phone book entries are displayed.

- ### 4 Operate the target mobile phone.
- Refer to the instruction manual supplied with your mobile phone.
 - To cancel the transfer, press [Finish].

5 Finish the procedure.



The phone book memory is copied from the mobile phone.

BLUETOOTH

About mobile phones compatible with Phone Book Access Profile (PBAP)

If your mobile phone supports PBAP, you can display the phone book and call lists on the touch panel screen when the mobile phone is connected.

- Phone book: up to 5 000 entries
- Dialed calls, received calls, and missed calls: up to 50 entries each

To display the phone book/call lists of the mobile phone or the unit



[Phone] Displays the phone book/call lists on the connected mobile phone.

[System] Displays the phone book/call lists copied to the unit.

Deleting the phone number entries in the unit

1 Display the phone book/call list you want to delete. (Page 33)

2

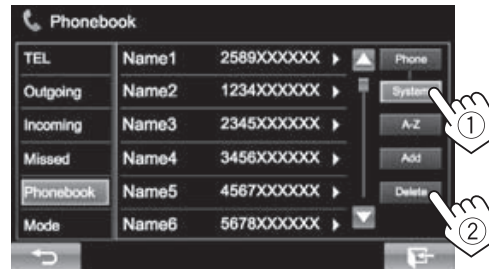

- You cannot delete data when **[Phone]** is selected.

3 Select the item you want to delete.

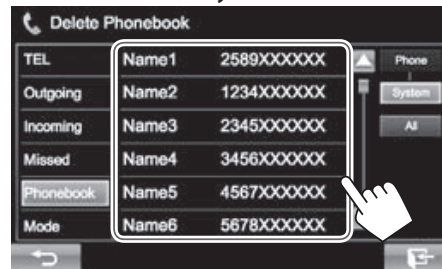

- Press **[All]** to delete all the numbers/names in the selected list.

A confirmation message appears. Press **[Yes]**.

Settings for Bluetooth mobile phones

1 Display the **<Hands Free>** screen. (Page 33)

2

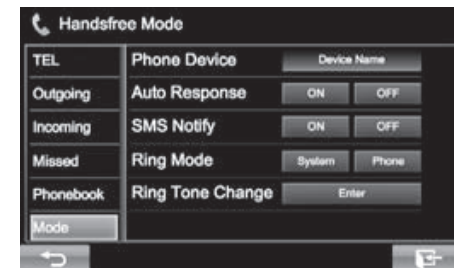

BLUETOOTH

□ Setting items

<Phone Device>	Shows the connected phone device name.
<Auto Response>	<ul style="list-style-type: none"> • ON: The unit answers the incoming calls automatically. • OFF (Initial): The unit does not answer the calls automatically. Answer the calls manually.
<SMS Notify>	<ul style="list-style-type: none"> • ON (Initial): The unit informs you of the arrival of a message by ringing and displaying "Receiving Message". • OFF: The unit does not inform you of the arrival of a message.
<Ring Mode>	<ul style="list-style-type: none"> • System (Initial): The ring tone set on the unit is used. • Phone: The ring tone set on the mobile phone is used. (This function may not work depending on the mobile phone.)
<Ring Tone Change>	<p>When <Ring Mode> is set to <System>, press [Enter], then select the ring tone for received calls and SMS from <Tone1> (Initial), <Tone2>, <Tone3>.</p> <ul style="list-style-type: none"> • Call Tone: Selects the ring tone for phone calls. • Message Tone: Selects the ring tone for SMS.

Using the Bluetooth audio player

- To register a new device, see page 30.
- To connect/disconnect a device, see page 32.

□ Indications and buttons on the source control screen

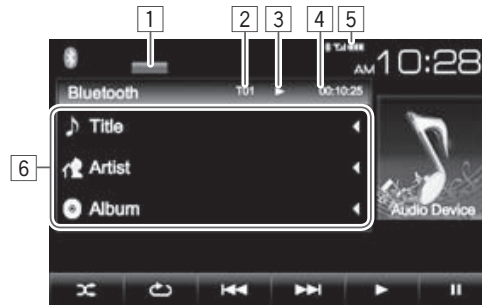

- The operation buttons, indications and information displayed on the screen differ depending on the connected device.

Playback information

- 1 Playback mode
- 2 Track no.*1
- 3 Playback status*1
- 4 Playing time*1
- 5 The signal strength and battery level (only when the information is acquired from the device)
- 6 Tag data (current track title/artist name/album title)*1
 - Pressing [◀] scrolls the text if not all of the text is shown.

Operation buttons

- [↺] Selects Repeat playback mode.*1 *2
- [⌂] Selects Random playback mode.*1 *2
- [◀◀] [▶▶]
 - Selects a track. (Press)
 - Reverse/forward search. (Hold)
- [▶] Starts playback.
- [⏸] Pauses playback.

*1 Available only for devices compatible with AVRCP 1.3.

*2 To cancel random and repeat mode, press the button repeatedly until the indicator disappears.

SETTINGS

Sound adjustment

Using the sound equalization

- The adjustment is memorized for each source until you adjust the sound again. If the source is a disc, the adjustment is stored for each of the following categories.
 - DVD/VCD
 - CD
 - DivX/MPEG1/MPEG2/MP3/WMA/WAV
- You cannot adjust the sound when the AV source is turned off.

Selecting a preset sound mode

- Display the **<Equalizer>** screen.
On the Home screen:

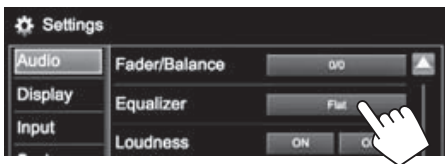
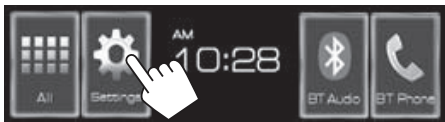

- Select a sound mode.



- You can change the page to display more items by pressing [▲]/[▼].

Storing your own adjustment—Customizing preset sound mode

- Select a sound mode. (See the left column.)
- Adjust the level of each band (①), then select the subwoofer level (②).

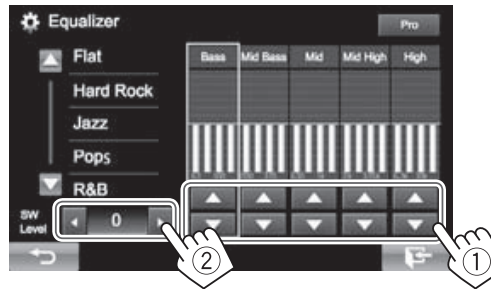

The adjustments are stored and **<User>** is activated.

Storing your own adjustment—Adjusting the sound precisely

- Select a sound mode. (See the left column.)
- Display the adjustment screen.

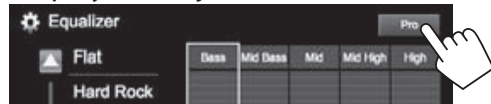

- Select a band.

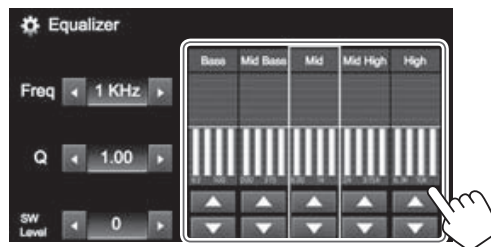

- Adjust the sound.

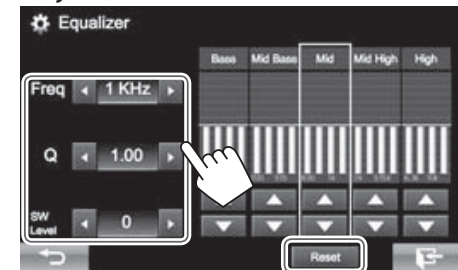

- [Reset]** Changes level of all bands to 0.
- <Freq>** Selects frequency.
- <Q>** Adjusts the width of the frequency.
- <SW Level>** Adjusts subwoofer level.*

The adjustments are overwritten if the **<User>** setting has been created (see the left column), and **<User>** is activated.

- The adjustments are memorized until you adjust sound again.
- To make adjustment for other bands, repeat steps **3** and **4**.

* Adjustable only when the subwoofer is activated. (Page 44)

SETTINGS

□ Adjusting the crossover frequency

- 1 Display the <X'over> screen.
On the Home screen:

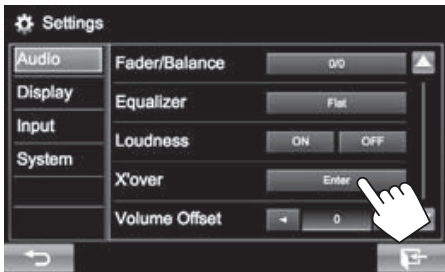

- 2 Select the item to adjust (①), then make adjustments (②).

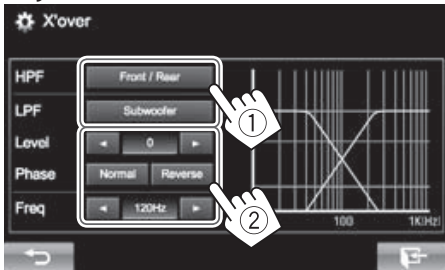

- <HPF> Adjusts the crossover for the front/rear speakers (high pass filter).
- <LPF> Adjusts the crossover for the subwoofer (low pass filter).^{*1}
- <Level> Adjusts the subwoofer level.^{*1}
- <Phase> Selects the phase for the subwoofer.^{*2}
- <Freq> Adjusts the crossover frequency.

^{*1} Adjustable only when the subwoofer is activated. (Page 44)

^{*2} Not selectable when <Freq> is set to <Through>.

Adjustment for video playback

□ Adjusting the picture

You can adjust the picture quality.

- 1 Display the adjustment menu.

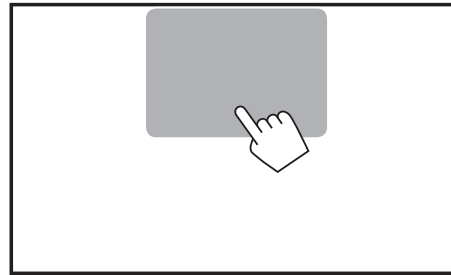

- When the App screen is displayed, you can press and hold DISP (for KW-V41BT)/ (for KW-V21BT/KW-V11) on the monitor panel to switch to the picture adjustment menu.

- 2 Select [DIM ON] (dimmer on) or [DIM OFF] (dimmer off).



- 3 Adjust the picture (-15 to +15).

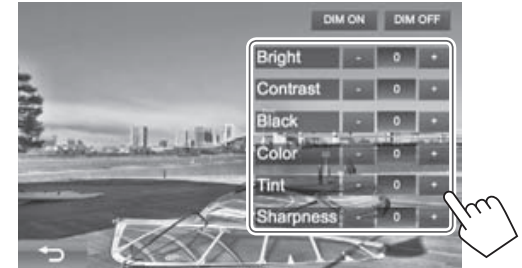

- <Bright> Adjusts the brightness.
- <Contrast> Adjusts the contrast.
- <Black> Adjusts the blackness.
- <Color> Adjusts the color.
- <Tint>^{*} Adjusts the tint.
- <Sharpness> Adjusts the sharpness.

^{*} Adjustable only when the incoming signal is NTSC.

SETTINGS

❑ Changing the aspect ratio

You can change the aspect ratio for video playback.

1 Display the adjustment menu.

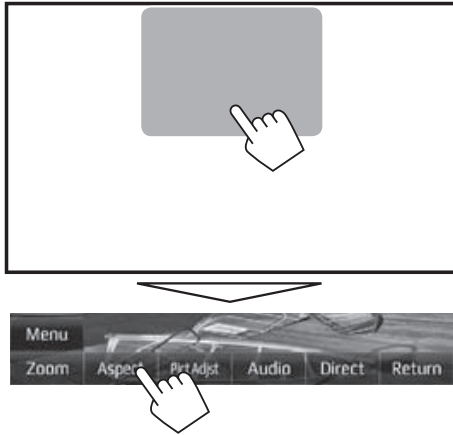

2 Select the aspect ratio.



<FULL>*

For 16:9 original pictures



<JUST>

For viewing 4:3 pictures naturally on the wide screen



<Normal>*

For 4:3 original pictures



<Auto>

For "DISC"/"USB" only: The aspect ratio is automatically selected to match the incoming signals.

* While DivX is played back with <Screen Ratio> set to [16:9] (for DVD: Page 13/for USB: Page 15), the aspect ratio is not set correctly.

❑ Zooming the picture

You can zoom the picture (<FULL>, <Zoom1> to <Zoom3>).

- When <Aspect> is set to <JUST> or <Auto> (see the left column), the picture is zoomed with the aspect ratio of the <FULL> setting.

1 Display the adjustment menu.

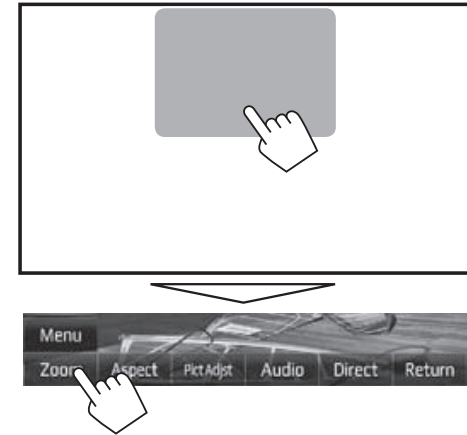

2 Change the magnification (①), then move the zooming frame (②).



- The zoom function cannot be used for some video sources.

SETTINGS

Changing display design

- 1 Display the <User Customize> screen.
On the Home screen:

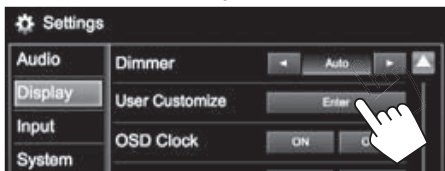
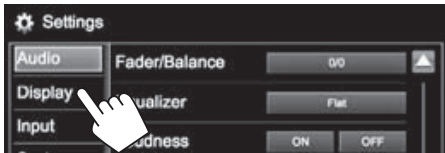

- 2 Only for KW-V41BT: Select an item to change (background design: [Background]/panel color: [Panel Color]).



- 3 Select a background/panel color*¹.
To select a background

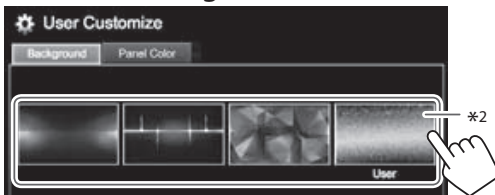

To select a panel color*¹

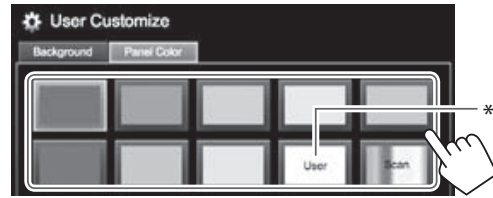

- Selecting [Scan] changes the illumination color gradually.

- *¹ Panel color is selectable only for KW-V41BT.
- *² Store your own scene beforehand. (See the right column.)
- *³ Store your own color adjustment beforehand. (See below.)

□ Making your own color adjustment (only for KW-V41BT)

- 1 Select [Panel Color] on the <User Customize> screen. (See the left column.)
- 2
- 3 Select the dimmer setting for the color (①), then adjust the color (②).

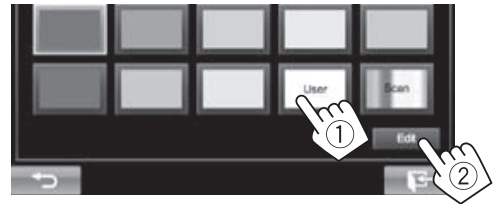

□ Storing your own scene for the background image

While playing a video or picture, you can capture an image and use the captured image as a background.

- You cannot capture copyrighted content and images from iPod/iPhone.
- When using a JPEG file as the background, make sure that the resolution is 800 x 480 pixels.
- The color of the captured image may look different from that of the actual scene.

- 1 Play a video or picture.
- 2 Display the <User Customize> screen. (See the far left column.)



- 4 Adjust the image.

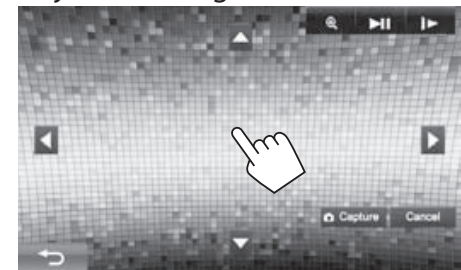

- [▲][▼][◀][▶] Moves the zooming frame.
- [+]
- [⏮]* Magnifies the scene. (<OFF>, <Zoom1> – <Zoom3>)
- [▶▶]* Starts/pauses playback.
- [▶▶]* Advances scenes frame-by-frame.

- To cancel the capture, press [Cancel].

SETTINGS

- 5 Capture the image displayed on the screen.



A confirmation message appears. Press **[Yes]** to store the newly captured image. (The existing image is replaced with the new one.)

- Press **[No]** to return to the previous screen.

- * Not displayed when playing an external component connected to the iPod/AV-IN input terminal.

- 2 Select where to place the icon (①), then select the item you want to display in the selected position (②).

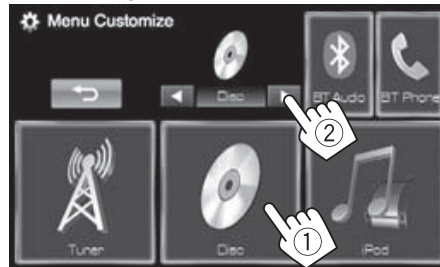

Repeat this step to place icons for other items.

- 2

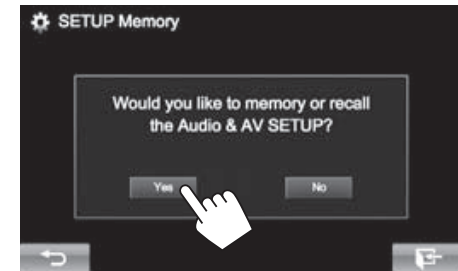
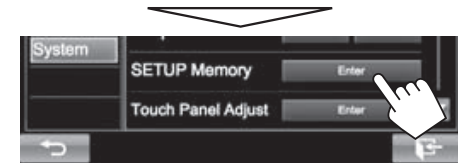

- To cancel, press **[No]**.

- 3 Select an operation.

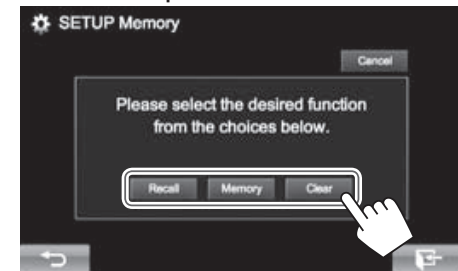

- [Recall]** Recalls the memorized settings.
- [Memory]** Memorizes the current settings.
- [Clear]** Clears the currently memorized settings.

- To cancel, press **[Cancel]**.

A confirmation message appears. Press **[Yes]**.
• When you perform recall or clear, AV source is turned off after confirmation.

Customizing the Home screen

You can arrange the items to display on the Home screen.

- 1 Display the **<Menu Customize>** screen. On the Home screen:
- Press **[▼]** repeatedly to change the page on the **<Display>** menu screen.

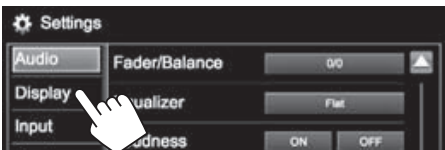
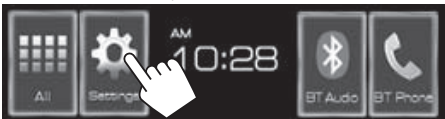

Customizing the system settings

□ Memorizing/recalling the settings

- You can memorize the settings changed in the **<Settings>** menu and recall the memorized settings anytime.
- The memorized settings are kept even when the unit is reset. (Page 3)

- 1 Display the **<SETUP Memory>** screen. On the Home screen:

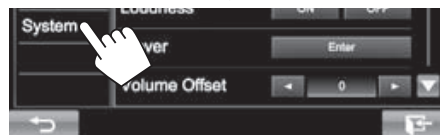

SETTINGS

Updating the system

You can update the system by connecting a USB device containing an update file.

- For system updates, visit <<http://www.jvc.net/cs/car/>>.

- Create an update file, copy it to a USB device, and connect it to the unit.
 - To connect a USB device, see page 52.
- Display the <**System Information**> screen.

On the Home screen:

- Press [▼] repeatedly to change the page on the <**System**> menu screen.

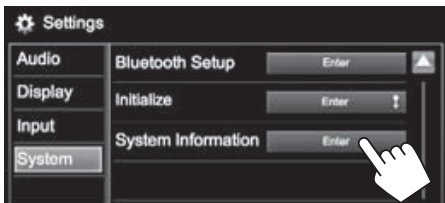
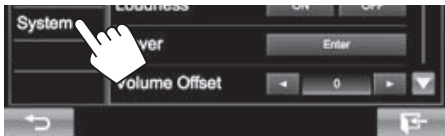

3



<**Application Version**>

Updates the system application.

<**DVD Version**>

Updates the DVD system application.

<**System Version**>

Updates the system.

<**Bluetooth Version**>*

Updates the Bluetooth application.

It may take a while.

If the update has been completed successfully, "Update Completed" appears. Reset the unit.

- If the update has failed, turn the power off and then on, and retry the update.
- Even if you have turned off the power during the update, you can restart the update after the power is turned on. The update will be performed from the beginning.

* Only for KW-V41BT/KW-V21BT.

Adjusting the touch position

You can adjust the touch position on the touch panel if the position touched and the operation performed do not match.

- Display the <**Touch Panel Adjust**> screen.

On the Home screen:

- Press [▼] repeatedly to change the page on the <**System**> menu screen.

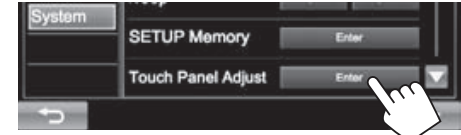
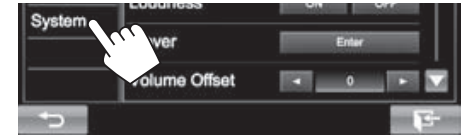

- Touch the center of the marks at the lower left and at the upper right as instructed.

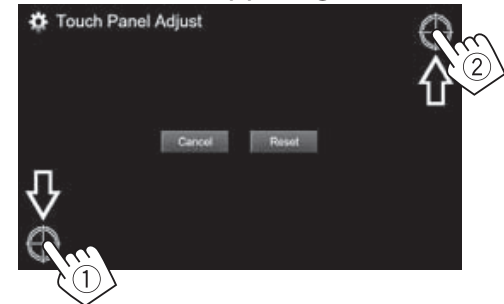

- To reset the touch position, press [**Reset**].
- To cancel the current operation, press [**Cancel**].

SETTINGS

Setting menu items

□ Displaying the <Settings> menu screen

On the Home screen:



- When changing settings for <AV Input> and <Navigation Input>, turn off the AV source (Page 7). Other settings can be changed when the AV source is turned on.

□ <Audio> setting screen

<Fader/Balance>

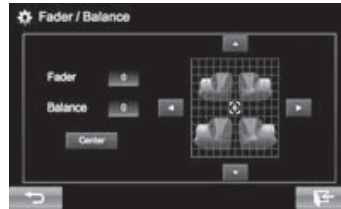

Fader: Adjust the front and rear speaker output balance.

- **F6 to R6** (Initial: **0**)
 - When using a two-speaker system, set the fader to the center (**0**).

Balance: Adjust the left and right speaker output balance.

- **L6 to R6** (Initial: **0**)
 - Press [**▲**]/[**▼**]/[**◀**]/[**▶**] or drag [**+**] to adjust.
 - To clear the adjustment, press [**Center**].

<Equalizer>

Change the sound mode or adjust and store the equalization for each source. (Page 38)

- **Flat** (Initial)/**Hard Rock/Jazz/Pops/R&B/Talk/User/Vocal Boost/Bass Boost/Classical/Dance**

<Loudness>

You can activate/deactivate loudness.

- **ON** (Initial): Boost low and high frequencies to produce a well-balanced sound at a low volume level. The LOUD indicator lights up.
- **OFF:** Cancels.

<X'over>

Adjust the crossover frequency. (Page 39)

<Volume Offset>

Adjust and store the auto-adjustment volume level for each source. (For discs, the adjustment is stored for each of the following categories: DVD/VCD, CD, and DivX/MPEG1/MPEG2/MP3/WMA/WAV.) The volume level will automatically increase or decrease when you change the source.

- **-15 to +6** (Initial: **0**)

<Subwoofer>

- **ON** (Initial): Activates the subwoofer.
- **OFF:** Deactivates the subwoofer.

<Bass Boost>

Select your preferred bass boost level.

- **OFF** (Initial)/**Level 1/Level 2**

SETTINGS

☐ <Display> setting screen

<Dimmer>

- **Auto** (Initial): Dims the screen and button illumination when you turn on the headlights.
 - The ILLUMI lead connection is required. (Page 51)
- **ON**: Activates dimmer.
- **OFF**: Cancels.

<User Customize>

Change the display design. (Page 41)

<OSD Clock>

- **ON**: Displays the clock while a video source is played back.
- **OFF** (Initial): Cancels.

<Demonstration>

- **ON** (Initial): Activates the demonstration on the screen.
- **OFF**: Cancels.

<Scroll>

- **ON**: Repeats scrolling.
 - **Once** (Initial): Scrolls the displayed information once.
 - **OFF**: Cancels.
- Pressing [**◀**] scrolls the text regardless of this setting.

<Menu Customize>

Change the items to display on the Home screen. (Page 42)

<Screen Adjust>

Adjust the brightness and blackness of the screen. Press [**Enter**] to display the setting screen, select [**DIM ON**] (dimmer on)/[**DIM OFF**] (dimmer off), then change the following settings:

- **Bright**: Adjusts brightness.
 - **-15** to **+15** (Initial: **0** for Dimmer On/**+15** for Dimmer Off)
- **Black**: Adjusts blackness.
 - **-15** to **+15** (Initial: **0**)

<Video Output>*¹

Select the color system of the external monitor.

- **NTSC** (Initial), **PAL**

<Angle>*²

Adjust the panel angle. (Page 7)

*¹ "Please Power Off" appears when the setting is changed. Turn off the power, then turn on to enable the change.

*² Only for KW-V41BT.

☐ <Input> setting screen

<AV Input>*

You can determine the use of the iPod/AV-IN terminal.

- **AV-IN** (Initial): Select to use the external component connected to the iPod/AV-IN terminal or iPod/iPhone connected using KS-U62 or a USB 2.0 cable. (Page 52)
- **iPod**: Select to use iPod/iPhone connected using KS-U59. (Page 52)

<R-CAM Interrupt>

- **ON** (Initial): Displays the picture from the rear view camera when you shift the gear to the reverse (R) position.
- **OFF**: Select this when no camera is connected.

<Navigation Input>*

- **iPhone**: Switches to the screen of App from the connected iPod touch/iPhone by pressing DISP (for KW-V41BT)/ (for KW-V21BT/KW-V11) on the monitor panel. (Page 18)
- **OFF**: Switches to the current source control screen.

* To change the setting, turn off the AV source by pressing [**AV Off**] on the Home screen beforehand.

<**AV Input**> can be changed only when <**Navigation Input**> is set to [**OFF**].

SETTINGS

☐ <System> setting screen

<Language>

Select the text language used for on-screen information.

- **English** (Initial)/**Español**/**Français**/**Deutsch**/**Italiano**/**Nederlands**/**Português**/**Türkçe**/**Русский**/**עברית**/**فارسی**/**العربية**/**ភាសាខ្មែរ**/**ไทย**/**简体中文**/**繁體中文**/**Bahasa Malaysia**/**Bahasa Indonesia**
 - “Please Power Off” appears when the setting is changed. Turn off the power, then turn on to enable the change.
- **GUI Language**: Select a language used for displaying operation buttons and menu items.
 - **English** (Initial)/**Local** (the language selected above)

<Clock>

Adjust the clock time. (Page 4)

<Beep>

- **ON** (Initial): Activates the key-touch tone.
- **OFF**: Cancels.

<SETUP Memory>

You can memorize, recall, or clear the settings you have made. (Page 42)

<Touch Panel Adjust>

Adjust the touch position of the buttons on the screen. (Page 43)

<Bluetooth Setup>*1

Configure settings for using a Bluetooth device, such as connection and other general operations.

- **Paired Device List**: Press **[Enter]** to show the list of registered devices. You can connect the device or delete the registration. (Page 32)
- **PIN Code**: Changes the PIN code of the unit. (Page 31)
- **Device Name**: Shows the device name to be shown on the Bluetooth device—JVC KW-V.
- **Device Address**: Shows the device address of the unit.
- **Auto Connect**:
 - **ON** (Initial): The connection is automatically established with the last connected Bluetooth device when the unit is turned on.
 - **OFF**: Cancels.
- **Bluetooth HF/Audio**: Select the speakers used for Bluetooth (both phone and audio player).
 - **Front Only**: From front speakers only.
 - **All** (Initial): From all speakers.
- **Auto Pairing**:
 - **ON** (initial): Establishes pairing automatically with the connected iOS device (such as iPhone) even if the Bluetooth function is deactivated on the device. (Auto pairing may not work for some devices depending on the iOS version.)
 - **OFF**: Cancels.
- **Initialize**: Hold **[Enter]** to initialize all settings you have made for using Bluetooth mobile phone and Bluetooth audio player.

<Initialize>

Initialize all settings you have made. Hold **[Enter]** to initialize the settings.

- After initializing the settings, adjust the settings on the **<Initial Settings>** screen.

<DivX® VOD>*2

This unit has its own Registration Code. Once you have played back a file with the Registration Code recorded, this unit's Registration Code is overwritten for copyright protection.

- Press **[Enter]** to display the information.
- To return to the previous screen, press **[OK]**.

<System Information>

Displays the version information of the software. You can update the software. (Page 43)

*1 Only for KW-V41BT/KW-V21BT.

*2 Only for KW-V41BT Region 4/KW-V21BT Region 4/KW-V11 Region 4.

REMOTEC ONTROLLER

For KW-V21BT Region 1/KW-V11 Region 1: To use the remote controller, purchase RM-RK258 separately.

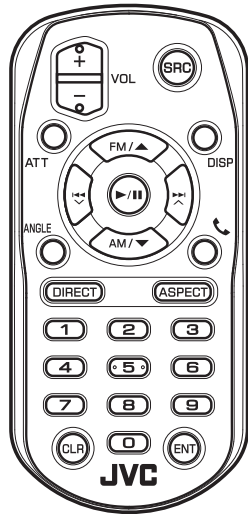

❑ Changing the battery of the remote controller

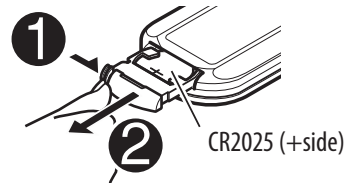

- Use a commercially available button battery (CR2025).
- Insert the battery with the + and – poles aligned properly.
 - If the effectiveness of the remote controller decreases, replace the battery.

⚠ Caution:

- Keep the battery out of reach of children and in original package until ready to use. Dispose of used batteries promptly. If swallowed contact physician immediately.
- Do not leave the battery near fire or under direct sunlight. A fire, explosion or excessive heat generation may result.
- Do not set the remote control in hot places such as on the dashboard.
- Danger of explosion if Lithium battery is incorrectly replaced. Replace only with the same or equivalent type.

Before using the remote controller:

- Aim the remote controller directly at the remote sensor on the unit.
- DO NOT expose the remote sensor to bright light (direct sunlight or artificial lighting).

Preparation

❑ Removing the battery sheet

Pull the battery sheet out from the remote controller to activate the battery.

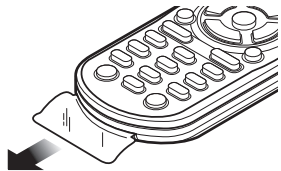



CALIFORNIA, USA ONLY

This product contains a CR Coin Cell Lithium Battery which contains Perchlorate Material — special handling may apply. See www.dtsc.ca.gov/hazardouswaste/perchlorate

REMOTE CONTROLLER

Operations using the remote controller (RM-RK258)

Basic button functions

ATT	Attenuates/restores the sound.
DISP	Switches the screen. <ul style="list-style-type: none"> The screen switched to depends on the <Navigation Input> setting (Page 45).
FM/▲ / AM/▼	<ul style="list-style-type: none"> Tuner/SiriusXM Satellite Radio *1: <ul style="list-style-type: none"> Selects the preset stations. Selects a title/item/folder.
	<ul style="list-style-type: none"> Tuner: <ul style="list-style-type: none"> Searches for stations automatically. Searches for stations manually. (Hold) SiriusXM Satellite Radio*1 : <ul style="list-style-type: none"> Selects a channel. Selects a channel rapidly. (Hold) Selects a track. Reverse search/forward search. (Hold)
VOL +/ VOL -	Adjusts the volume level.
SRC	Selects the source.
	Starts/pauses*2 playback.
	Answers incoming calls.*3
0 - 9	Enters a number. (See the far right column.)

1 - 6	Enters preset station number.
ANGLE	Tilts the monitor panel.*4
ASPECT	Changes the aspect ratio. <ul style="list-style-type: none"> To check the current aspect ratio setting, operate on the touch panel. (Page 40)
ENT	Confirms selection.
DIRECT	Enters direct search mode. (See the right column.)
CLR	Erases the misentry.

*1 Only for KW-V41BT Region 1/KW-V21BT Region 1.

*2 Does not work while listening to Bluetooth audio.

*3 Available for KW-V41BT/KW-V21BT only.

*4 Available for KW-V41BT only.

Searching for an item directly

Tuner frequency

- Press DIRECT to enter the search mode.
- Press number buttons to enter a frequency.
 - To erase a misentry, press CLR (clear).
- Press ENT to confirm the entry.

Chapter/title/folder/file/track on the disc/USB

- Press DIRECT to enter the search mode.
 - Each time you press DIRECT, the item to search for changes.
- Press a number button to select a desired item.
 - To erase a misentry, press CLR (clear).
- Press ENT to confirm the selection.

Disc operations

Using the VCD menu

During PBC playback...

- Press DIRECT to enter the search mode.
- Press a number button to select the item you want to play.
- Press ENT to confirm the selection.

CONNECTION/INSTALLATION

Before installing the unit

⚠ WARNING

- If you connect the ignition wire (red) and the battery wire (yellow) to the car chassis (ground), you may cause a short circuit, that in turn may start a fire. Always connect those wires to the power source running through the fuse box.
- Do not cut out the fuse from the ignition wire (red) and the battery wire (yellow). The power supply must be connected to the wires via the fuse.

⚠ Precautions on installation and connection

- Mounting and wiring this product requires skills and experience. For best safety, leave the mounting and wiring work to professionals.
- Make sure to ground the unit to a negative 12 V DC power supply.
- Do not install the unit in a spot exposed to direct sunlight or excessive heat or humidity. Also avoid places with too much dust or the possibility of water splashing.
- Do not use your own screws. Use only the screws provided. If you use the wrong screws, you could damage the unit.
- If the power is not turned on ("Miswiring DC Offset Error", "Warning DC Offset Error" is displayed), the speaker wire may have a short circuit or have touched the chassis of the vehicle and the protection function may have been activated. Therefore, the speaker wire should be checked.

- If your car's ignition does not have an ACC position, connect the ignition wires to a power source that can be turned on and off with the ignition key. If you connect the ignition wire to a power source with a constant voltage supply, such as with battery wires, the battery may be drained.
- Only for KW-V41BT:
If the console has a lid, make sure to install the unit so that the monitor panel will not hit the lid when closing and opening.
- If the fuse blows, first make sure the wires are not touching to cause a short circuit, then replace the old fuse with one with the same rating.
- Insulate unconnected wires with vinyl tape or other similar material. To prevent a short circuit, do not remove the caps on the ends of the unconnected wires or the terminals.
- Connect the speaker wires correctly to the terminals to which they correspond. The unit may be damaged or fail to work if you share the ⊖ wires or ground them to any metal part in the car.
- When only two speakers are being connected to the system, connect both connectors either to the front output terminals or to the rear output terminals (do not mix front and rear). For example, if you connect the ⊕ connector of the left speaker to a front output terminal, do not connect the ⊖ connector to a rear output terminal.
- After the unit is installed, check whether the brake lamps, blinkers, wipers, etc. on the car are working properly.
- Mount the unit so that the mounting angle is 30° or less.
- Do not press hard on the panel surface when installing the unit to the vehicle. Otherwise scars, damage, or failure may result.

⚠ CAUTION

Install this unit in the console of your vehicle. Do not touch the metal part of this unit during and shortly after the use of the unit. Metal parts such as the heat sink and enclosure become hot.

☐ Supplied accessories for installation

- ① Wiring harness x 1
- ② Trim plate x 1 *¹
- ③ Extension wire (2 m) x 1
- ④ Extraction keys x 2 *¹
- ⑤ Flat head screws (M5 x 8 mm) x 6
- ⑥ Round head screws (M5 x 8 mm) x 6
- ⑦ Microphone (3 m) x 1 *²

*¹ Only for KW-V41BT Region 4/KW-V21BT Region 4/KW-V11 Region 4.

*² Only for KW-V41BT/KW-V21BT.

CONNECTION/INSTALLATION

□ Installation procedure

- 1 To prevent a short circuit, remove the key from the ignition and disconnect the ⊖ battery.
- 2 Make the proper input and output wire connections for each unit.
- 3 Connect the speaker wires of the wiring harness.
- 4 Connect the wiring harness wires in the following order: ground, battery, ignition.
- 5 Connect the wiring harness connector to the unit.
- 6 Install the unit in your car.
- 7 Reconnect the ⊖ battery.
- 8 Press the reset button.
- 9 Configure <Initial Settings>. (Page 4)

Installing the unit

- #### □ Installing the unit (only for KW-V41BT Region 4/KW-V21BT Region 4/KW-V11 Region 4)

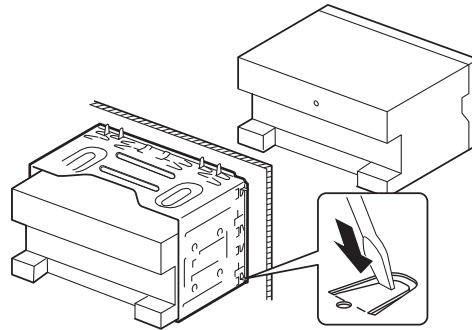

- Bend the tabs of the mounting sleeve with a screwdriver or similar utensil and attach it in place.

- #### □ Installing the unit using the mounting bracket removed from the car

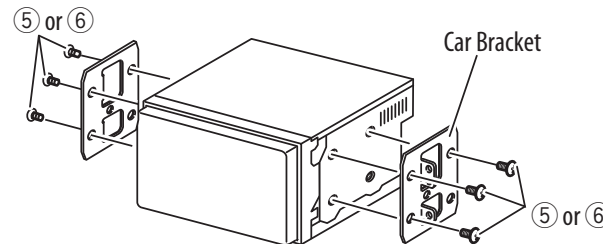

- Select the appropriate type of screw for the mounting bracket: flat head (5) or round head (6).

- #### □ Installing the trim plate (only for KW-V41BT Region 4/KW-V21BT Region 4/KW-V11 Region 4)

- 1 Attach the trim plate (2).

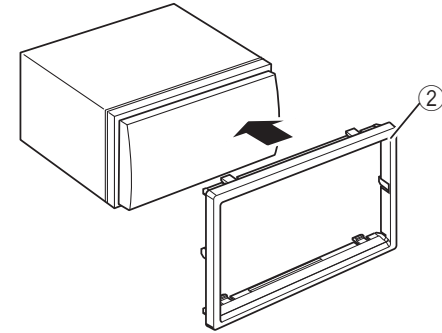

CONNECTION/INSTALLATION

Connection

Connecting wires to terminals

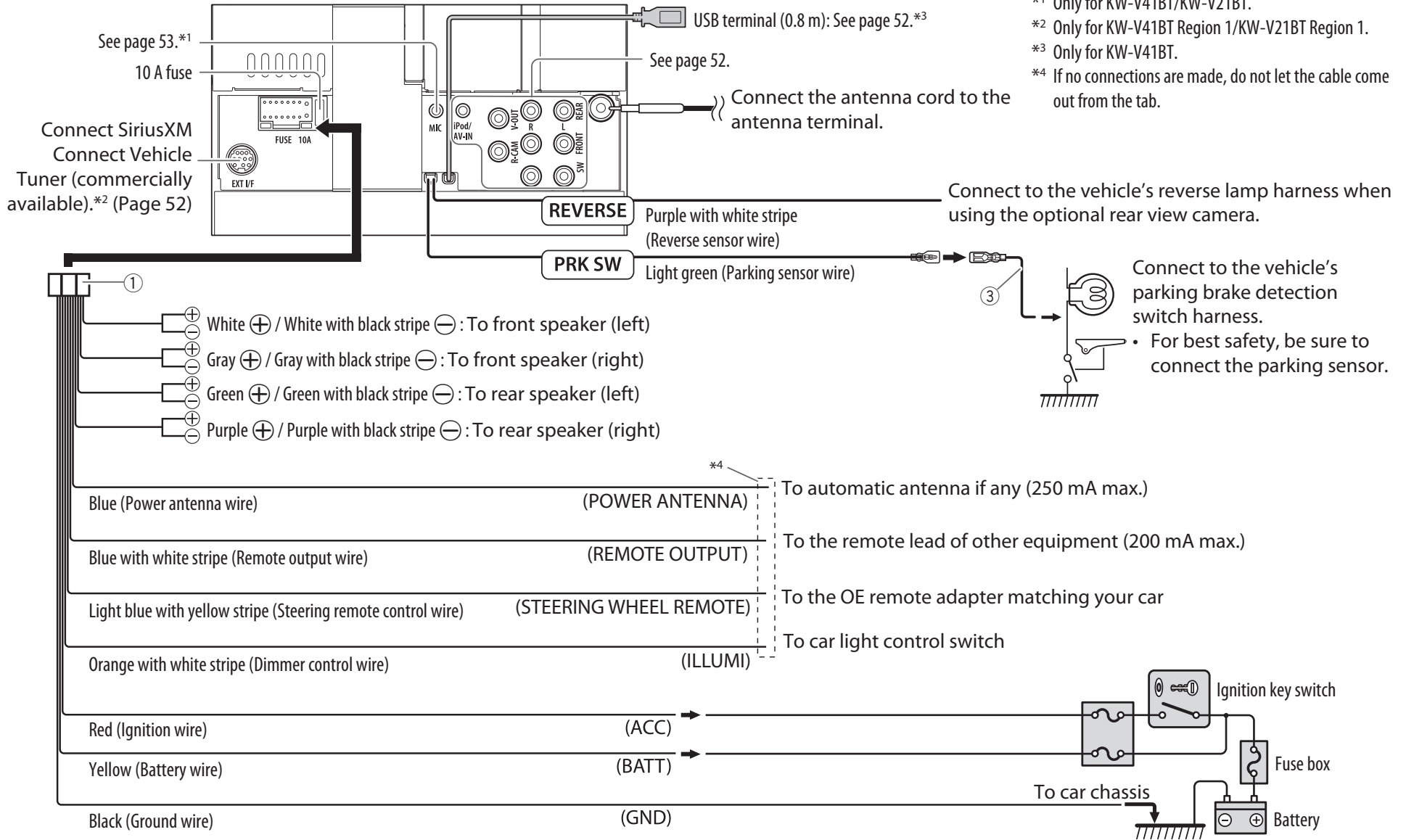

*1 Only for KW-V41BT/KW-V21BT.

*2 Only for KW-V41BT Region 1/KW-V21BT Region 1.

*3 Only for KW-V41BT.

*4 If no connections are made, do not let the cable come out from the tab.

CONNECTION/INSTALLATION

Connecting a USB device/iPod/iPhone

iPod nano (7th Generation)/ iPod touch (5th Generation)/iPhone 5S/iPhone 5C/iPhone 5 (commercially available)

iPod/iPhone except for iPod nano (7th Generation)/iPod touch (5th Generation)/iPhone 5S/iPhone 5C/iPhone 5 (commercially available)

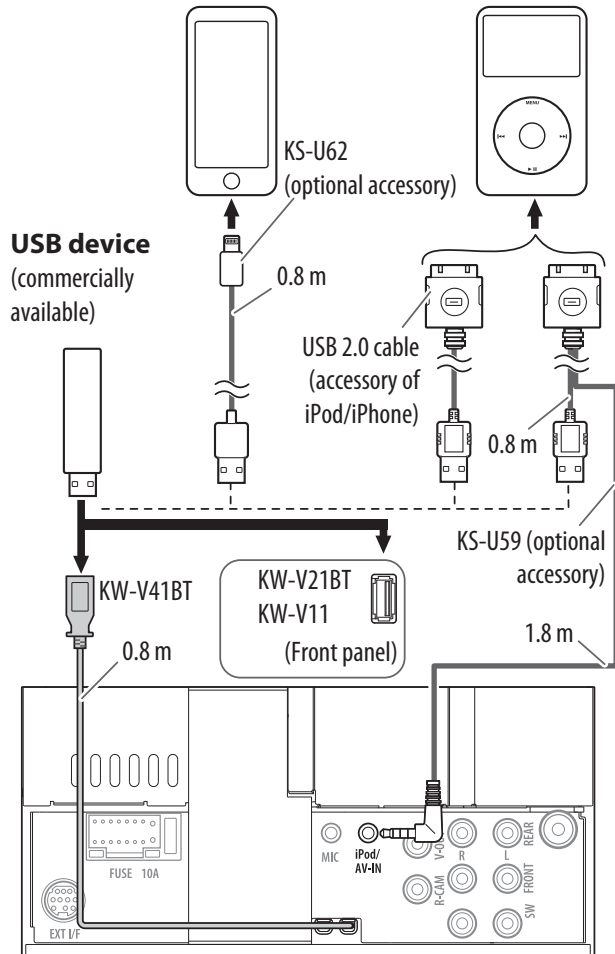

Connecting external components

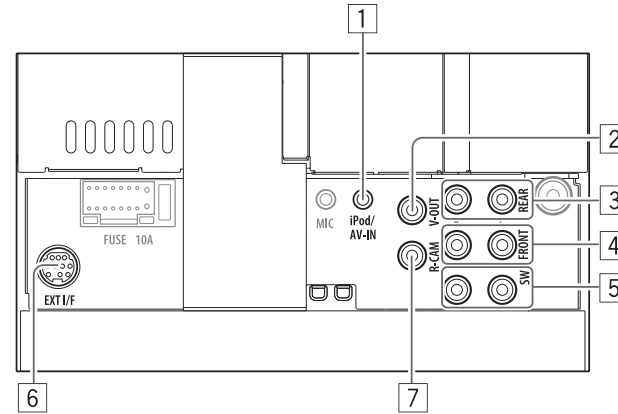

1 iPod/AV-IN

- Connect the following type of 4-pole mini plug:



2 Video output (Yellow)

3 Rear preout*1

- Audio left output (White)
- Audio right output (Red)

4 Front preout*1

- Audio left output (White)
- Audio right output (Red)

5 Subwoofer preout (monaural output)*1

- Subwoofer left output (White)
- Subwoofer right output (Red)

6 Expansion port for connecting SiriusXM Connect Vehicle Tuner (commercially available)*2

7 Rear view camera input (Yellow)

*1 When connecting an external amplifier, connect its ground wire to the chassis of the car; otherwise the unit may be damaged.

*2 Only for KW-V41BT Region 1/KW-V21BT Region 1.

CONNECTION/INSTALLATION

Connecting microphone for Bluetooth (only for KW-V41BT/KW-V21BT)

Connect the microphone (7) to the MIC terminal.

- To install the microphone, peel off the adhesive tape, fix on the installation position, then adjust the direction of the microphone to face the driver. After installing, fix the microphone cable to the car with clamps (commercially available).

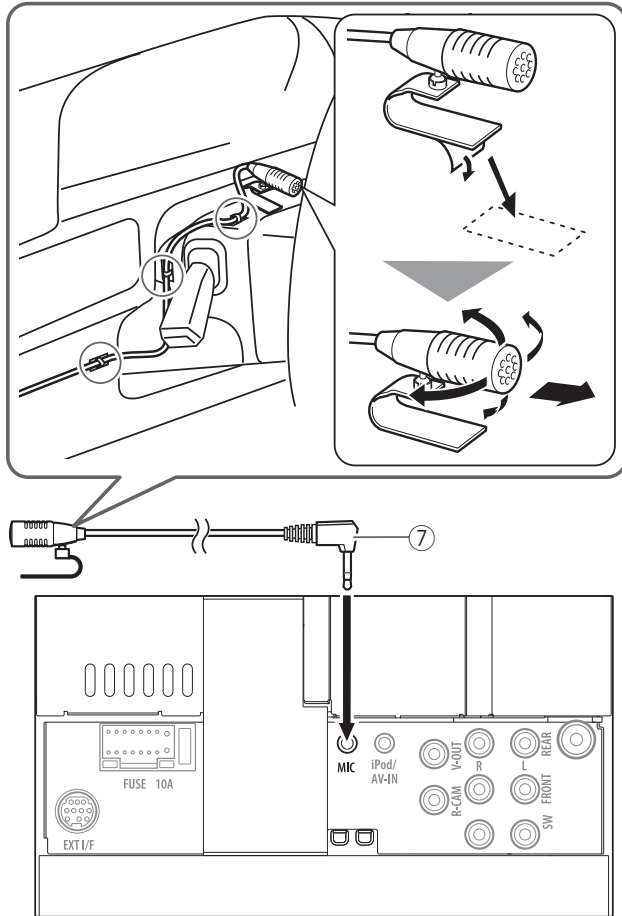

Removing the unit (Only for KW-V41BT Region 4/KW-V21BT Region 4/KW-V11 Region 4)

Removing the trim plate

- Engage the catch pins on the extraction key (4) and remove the two locks on the lower part. Lower the frame and pull it forward.

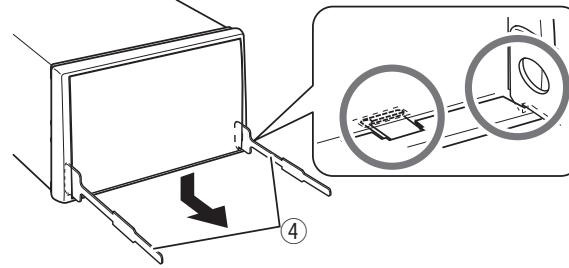

- Remove from the upper two catches.

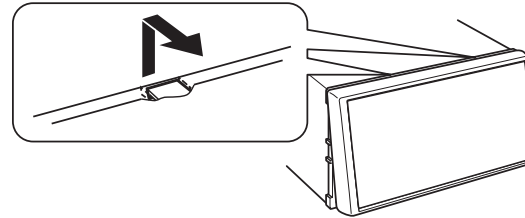

- The frame can be removed from the top side in the same manner.

Removing the unit

- Remove the trim plate. (See the left column.)
- Insert the two extraction keys (4), then pull them as illustrated so that the unit can be removed.

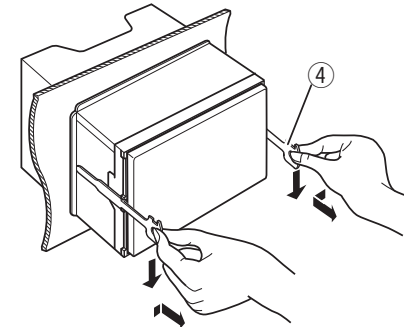

- Be careful to avoid injury from the catch pins on the extraction key.

REFERENCES

Maintenance

❑ Caution on cleaning the unit

Do not use any solvent (for example, thinner, benzene, etc.), detergent, or insecticide. This may damage the monitor or the unit.

Recommended cleaning method:

Gently wipe the panel with a soft, dry cloth.

❑ Moisture condensation

Moisture may condense on the lens inside the unit in the following cases:

- After starting the heater in the car.
- If it becomes very humid inside the car.

Should this occur, the unit may malfunction. In this case, eject the disc and leave the unit turned on for a few hours until the moisture evaporates.

❑ How to handle discs

- When removing a disc from its case, press down the center holder of the case and lift the disc out, holding it by the edges.



- Always hold the disc by the edges. Do not touch its recording surface.
- When storing a disc in its case, gently insert the disc around the center holder (with the printed surface facing up).
 - Make sure to store discs in their cases after use.

❑ To keep discs clean

Dirty discs may not play correctly.

If a disc does become dirty, wipe it with a soft cloth in a straight line from center to edge.



- Do not use any solvents (for example, conventional record cleaner, spray, thinner, benzene, etc.) to clean discs.

❑ To play new discs

New discs may have some rough spots around the inner and outer edges. If such a disc is used, this unit may reject the disc.

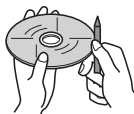

- To remove these rough spots, rub the edges with a pencil or ball-point pen, etc.

More information

❑ File playback

Playing DivX files*

- This unit can play back DivX files with the extension code <.divx>, <.div>, or <.avi> (regardless of the letter case—upper/lower).
- Audio stream should conform to MP3 or Dolby Digital.

- Files encoded in the interlaced scanning mode may not be played back correctly.
- The maximum bit rate for video signals (average) is 4 Mbps.
- * Only for KW-V41BT Region 4/KW-V21BT Region 4/KW-V11 Region 4.

Playing MPEG1/MPEG2 files

- This unit can play back MPEG1/MPEG2 files with the extension code <.mpg>, <.mpeg>, or <.mod>.
- The stream format should conform to MPEG system/program stream.
The file format should be MP@ML (Main Profile at Main Level)/SP@ML (Simple Profile at Main Level)/MP@LL (Main Profile at Low Level).
- Audio streams should conform to MPEG1 Audio Layer-2 or Dolby Digital.
- The maximum bit rate for video signals (average) is 4 Mbps.

Playing JPEG files

- This unit can play back JPEG files with the extension code <.jpg> or <.jpeg>.
- This unit can play back JPEG files that are at 32 x 32 to 8 192 x 7 680 resolution.
It may take time to display the file depending on its resolution.
- This unit can play back baseline JPEG files. Progressive JPEG files or lossless JPEG files cannot be played.

REFERENCES

Playing MP3/WMA/WAV files

- This unit can play back files with the extension code <.mp3>, <.wma>, or <.wav> (regardless of the letter case—upper/lower).
- This unit can play back files that meet the conditions below:
 - Bit rate:
 - MP3/WMA: 32 kbps — 320 kbps
 - Sampling frequency:
 - 48 kHz, 44.1 kHz, 32 kHz (for MPEG1)
 - 24 kHz, 22.05 kHz, 16 kHz (for MPEG2)
 - 48 kHz, 44.1 kHz, 32 kHz, 22.05 kHz (for WMA)
 - 44.1 kHz (for WAV)
- This unit can show ID3 Tag Version 1.0/1.1/2.2/2.3/2.4 (for MP3).
- This unit can also show WAV/WMA Tag.
- This unit can play back files recorded in VBR (variable bit rate).
- Files recorded in VBR have a discrepancy in elapsed time indication.
- This unit cannot play back the following files:
 - MP3 files encoded with MP3i and MP3 PRO format.
 - MP3 files encoded with Layer 1/2.
 - WMA files encoded with lossless, professional, and voice format.
 - WMA files which are not based upon Windows Media® Audio.
 - WMA files copy-protected with DRM.

- This unit can display jacket pictures that meet the conditions below:
 - Picture size: 32 x 32 to 1 232 x 672 resolution
 - Data size: less than 650 KB.
 - File type: JPEG

Disc playback

Playable disc types

Disc type	Recording format, file type, etc.
DVD	DVD Video* ¹
<ul style="list-style-type: none"> • DTS sound cannot be reproduced or emitted from this unit. 	
DVD Recordable/Rewritable (DVD-R/-RW*², +R/+RW*³)	<ul style="list-style-type: none"> • DVD Video • DivX*⁴/MPEG1/MPEG2 • JPEG • MP3/WMA/WAV
<ul style="list-style-type: none"> • DVD Video: UDF bridge • DivX*⁴/MPEG1/MPEG2/JPEG/MP3/WMA/WAV: ISO 9660 level 1, level 2, Romeo, Joliet 	
Dual Disc	DVD side
CD/VCD	<ul style="list-style-type: none"> • VCD (Video CD) • Audio CD/CD Text (CD-DA)
CD Recordable/Rewritable (CD-R/-RW)	<ul style="list-style-type: none"> • VCD (Video CD) • CD-DA • MPEG1/MPEG2 • JPEG • MP3/WMA/WAV
<ul style="list-style-type: none"> • ISO 9660 level 1, level 2, Romeo, Joliet 	

- *¹ DVD Region code: 1/4 (depending on the country and sales area)
If you insert a DVD Video disc of an incorrect Region Code, “Region Code Error” appears on the screen.
- *² DVD-R recorded in multi-border format is also playable (except for dual layer discs). DVD-RW dual layer discs are not playable.
- *³ It is possible to play back finalized +R/+RW (Video format only) discs. “DVD” is selected as the disc type when a +R/+RW disc is loaded. +RW double layer discs are not playable.
- *⁴ Only for KW-V41BT Region 4/KW-V21BT Region 4/KW-V11 Region 4.

Unplayable discs

- Unplayable disc types and formats are as follows:
 - DVD-Audio/DVD-ROM discs
 - MPEG4/AAC/DivX*/DVD-VR/DVD+VR/DVD-RAM recorded in the DVD-R/RW or +R/+RW
 - DTS-CD, SVCD (Super Video CD), CD-ROM, CD-I (CD-I Ready)
 - DivX/MPEG4/AAC recorded in the CD-R/RW
- Discs that are not round.
- Discs with coloring on the recording surface or discs that are dirty.
- Recordable/Rewritable discs that have not been finalized.
- 3 inch discs. Attempting to insert using an adapter may cause malfunction.
- * Only for KW-V41BT Region 1/KW-V21BT Region 1/KW-V11 Region 1.

DualDisc playback

The Non-DVD side of a “DualDisc” does not comply with the “Compact Disc Digital Audio” standard. Therefore, the use of Non-DVD side of a DualDisc on this product cannot be recommended.

REFERENCES

Playing Recordable/Rewritable discs

- This unit can recognize a total of 5 000 files and 250 folders (a maximum of 999 files per folder).
- Use only “finalized” discs.
- This unit can play back multi-session discs; however, unclosed sessions will be skipped while playing.
- Some discs or files may not be played back due to their characteristics or recording conditions.

□ About data stored in the connected USB device/iPod/iPhone

- We bear no responsibility for any loss of data in an iPod/iPhone and USB mass storage class device while using this unit.

□ USB playback

Playable files on a USB device

- This unit can play JPEG/DivX*¹/MPEG1/MPEG2*²/MP3/WMA/WAV files stored in a USB mass storage class device.
- This unit can recognize a total of 5 000 files and 250 folders (a maximum of 999 files per folder).
- Make sure all important data has been backed up to avoid losing the data.

*¹ Only for KW-V41BT Region 4/KW-V21BT Region 4/KW-V11 Region 4.

*² Except for MPEG2 files recorded by JVC Everio camcorder (extension code <.mod>).

Notes on using a USB device:

- This unit may not play back files in a USB device properly when using a USB extension cable.
- USB devices equipped with special functions such as data security functions cannot be used with the unit.
- Do not use a USB device with 2 or more partitions.

- Depending on the shape of the USB devices and connection ports, some USB devices may not be attached properly or the connection might be loose.
- This unit cannot recognize a USB device whose rating is other than 5 V and exceeds 1 A.
- This unit may not recognize a memory card inserted into the USB card reader.
- Connect only one USB device to the unit at a time. Do not use a USB hub.
- When connecting with a USB cable, use the USB 2.0 cable.
- The maximum number of characters (when the characters are 1 byte):
 - Folder names: 50 characters
 - File names: 50 characters
- Avoid using the USB device if it might affect driving safety.
- Do not pull out and connect the USB device repeatedly while “Reading” is shown on the screen.
- Electrostatic shock when connecting a USB device may cause abnormal playback of the device. In this case, disconnect the USB device then reset this unit and the USB device.
- Operation and power supply may not work as intended for some USB devices.
- Do not leave a USB device in the car, or expose to direct sunlight or high temperatures to avoid deformation or damage to the device.

□ Notes on playing iPod/iPhone

- iPod/iPhone that can be connected to this unit:
 - Made for
 - iPod with video
 - iPod classic

- iPod nano (7th Generation)*
- iPod nano (6th Generation)
- iPod nano (5th Generation)
- iPod nano (4th Generation)
- iPod nano (3rd Generation)
- iPod touch (5th Generation)*
- iPod touch (4th Generation)
- iPod touch (3rd Generation)
- iPod touch (2nd Generation)
- iPod touch (1st Generation)
- iPhone 5S*
- iPhone 5C*
- iPhone 5*
- iPhone 4S
- iPhone 4
- iPhone 3GS
- iPhone 3G
- iPhone

* You cannot watch video when connecting iPod nano (7th Generation)/iPod touch (5th Generation)/iPhone 5S/iPhone 5C/iPhone 5.

- When operating iPod/iPhone, some operations may not be performed correctly or as intended. In this case, visit the following JVC web site:
<<http://www.jvc.net/cs/car/>>
- For some iPod/iPhone models, the performance may be abnormal or unstable during operation. In this case, disconnect the iPod/iPhone device, then check its condition.
If the performance is not improved or slow, reset your iPod/iPhone.
- When you turn on this unit, the iPod/iPhone is charged through the unit.
- The text information may not be displayed correctly.

REFERENCES

Language codes (for DVD language selection)

AA	Afar	GL	Galician	MI	Maori	SO	Somali
AB	Abkhazian	GN	Guarani	MK	Macedonian	SQ	Albanian
AF	Afrikaans	GU	Gujarati	ML	Malayalam	SR	Serbian
AM	Ameharic	HA	Hausa	MN	Mongolian	SS	Siswati
AR	Arabic	HI	Hindi	MO	Moldavian	ST	Sesotho
AS	Assamese	HR	Croatian	MR	Marathi	SU	Sundanese
AY	Aymara	HU	Hungarian	MS	Malay (MAY)	SW	Swahili
AZ	Azerbaijani	HY	Armenian	MT	Maltese	TA	Tamil
BA	Bashkir	IA	Interlingua	MY	Burmese	TE	Telugu
BE	Byelorussian	IE	Interlingue	NA	Nauru	TG	Tajik
BG	Bulgarian	IK	Inupiak	NE	Nepali	TH	Thai
BH	Bihari	IN	Indonesian	NO	Norwegian	TI	Tigrinya
BI	Bislama	IS	Icelandic	OC	Occitan	TK	Turkmen
BN	Bengali, Bangla	IW	Hebrew	OM	(Afan) Oromo	TL	Tagalog
BO	Tibetan	JA	Japanese	OR	Oriya	TN	Setswana
BR	Breton	JI	Yiddish	PA	Panjabi	TO	Tonga
CA	Catalan	JW	Javanese	PL	Polish	TR	Turkish
CO	Corsican	KA	Georgian	PS	Pashto, Pushto	TS	Tsonga
CS	Czech	KK	Kazakh	QU	Quechua	TT	Tatar
CY	Welsh	KL	Greenlandic	RM	Rhaeto-Romance	TW	Twi
DZ	Bhutani	KM	Cambodian	RN	Kirundi	UK	Ukrainian
EL	Greek	KN	Kannada	RO	Rumanian	UR	Urdu
EO	Esperanto	KO	Korean (KOR)	RW	Kinyarwanda	UZ	Uzbek
ET	Estonian	KS	Kashmiri	SA	Sanskrit	VI	Vietnamese
EU	Basque	KU	Kurdish	SD	Sindhi	VO	Volapuk
FA	Persian	KY	Kirghiz	SG	Sangho	WO	Wolof
FI	Finnish	LA	Latin	SH	Serbo-Croatian	XH	Xhosa
FJ	Fiji	LN	Lingala	SI	Singhalese	YO	Yoruba
FO	Faroese	LO	Laothian	SK	Slovak	ZU	Zulu
FY	Frisian	LT	Lithuanian	SL	Slovenian		
GA	Irish	LV	Latvian, Lettish	SM	Samoan		
GD	Scots Gaelic	MG	Malagasy	SN	Shona		

Error message list

If an error occurs while using the unit, a message appears. Take appropriate action according to the following message/remedy/cause list.

“No Signal”:

- Start the playback on the external component connected to the iPod/AV-IN terminal.
- Check the cords and connections.
- Signal input is too weak.

“Miswiring DC Offset Error”/“Warning DC Offset Error”:

- A speaker cord has shorted or it has come into contact with the car chassis. Wire or insulate the speaker cord as appropriate, then reset the unit. (Pages 3 and 51)

“Parking Off”:

- No playback picture is shown when the parking brake is not engaged.

“Authorization Error”:

- Check whether the connected iPod/iPhone is compatible with this unit. (Page 56)

“USB Device Error”:

- The USB power voltage is abnormal.
- Turn off and turn on the unit.
- Connect another USB device.

“Panel Mecha Error”:

- The panel does not work properly. Reset the unit.

Continued to the next page...

REFERENCES

“Connection Error”:

- The device is registered but the connection has failed. Connect the registered device. (Page 32)

“Please Wait...”:

- The unit is preparing to use the Bluetooth function. If the message does not disappear, turn off and turn on the unit, then connect the device again (or reset the unit).

“No Voice Device”:

- The connected mobile phone does not have a voice recognition system.

“No Data”:

- No phone book data is contained in the connected Bluetooth phone.

“Initialize Error”:

- The unit has failed to initialize the Bluetooth module. Try the operation again.

“Dial Error”:

- Dialing has failed. Try the operation again.

“Hung Up Error”:

- The call has not ended yet. Park your car, and use the connected mobile phone to end the call.

“Pick Up Error”:

- The unit has failed to receive a call.

“Please update Pandora App”:

- The Pandora application on your iPod touch/iPhone/Android is not the latest version. Update the application.

“Check App”:

- The Pandora application on your iPod touch/iPhone/Android is not started up.
- The Pandora application is not installed in the connected device.
- An error has occurred in the Pandora application.

“Login Error”:

- You have not been signed into Pandora.

“No skips remaining”:

- No more songs can be skipped.

“Failed to save your thumb rating”:

- Thumb-up/down is prohibited.

“No Station”:

- No station is available.

“No Active Station”:

- No station is being played.

“Station limit reached”:

- The Station List is full and no more stations can be registered.

“Failed to save your bookmark”:

- The unit has failed to save a bookmark. Try the operation again.

“Limited Connectivity”:

- The connection with the Pandora application cannot be established.

“Pandora not available”:

- You cannot use the Pandora application from the area where you are currently trying to access Pandora.

“Try again later”:

- The Pandora server is under maintenance.

“Station does not exist”:

- The selected station has been deleted by another device or has expired.

“Cannot create a Station”:

- You cannot create a station during the read-only mode or when network connection is not established.

“SXM No Signal”:

- Make sure the SiriusXM Satellite Radio antenna is mounted outside the vehicle. Move the vehicle to an area with a clear view of the sky.

“SXM Check Antenna”:

- Check the SiriusXM Satellite Radio antenna connection, and make sure the antenna is firmly attached to the tuner.
- Check whether the SiriusXM Satellite Radio antenna cable is bent or broken. If it is damaged, replace the whole antenna unit.

“SXM Check Tuner”:

- Make sure the SiriusXM Connect Vehicle Tuner is connected to the unit.

“SXM Chan Unavailable” (appears on the screen for about 2 seconds, then returns to the previous channel):

- The selected channel is no longer available. Select another channel or continue listening to the previous channel.

“SXM Ch Unsubscribed” (appears on the screen for about 2 seconds, then returns to the previous channel):

- The selected channel is not part of your current subscription plan. Call 1-866-635-2349 to subscribe.

REFERENCES

“SXM Subscription Updated – Press Enter to Continue”:

- Your subscription has been updated. Press the appropriate button to continue.

“SXM Channel Locked”

- The selected channel has been locked by the parental controls. Enter the unlock code when you are asked. (Page 27)

“SXM Incorrect Lock Code”

- The selected channel is a mature or parental lock channel, and locked by the parental lock or user lock code. Enter the correct lock code.

Troubleshooting

What appears to be trouble is not always serious. Check the following points before calling a service center.

- For operations with the external components, refer also to the instructions supplied with the adapters used for the connections (as well as the instructions supplied with the external components).

❑ General

No sound comes out of the speakers.

- Adjust the volume to the optimum level.
- Check the cords and connections.

No picture is displayed on the screen.

- Turn on the screen. (Page 7)

The unit does not work at all.

- Reset the unit. (Page 3)

The remote controller* does not work.

- Replace the battery.

* For KW-V41BT Region 1/KW-V21BT Region 1/KW-V11 Region 1:
Purchase RM-RK258 separately.

The App screen is not displayed even when DISP (for KW-V41BT) or (for KW-V21BT/KW-V11) is pressed.

- Select an appropriate setting for <Navigation Input>. (Page 45)

The desired source button ([AV-IN] or [Apps]) cannot be selected on the Home screen.

- Select an appropriate setting for <AV Input>. (Page 16)

❑ Discs in general

Recordable/Rewritable discs cannot be played back.

- Insert a finalized disc.
- Finalize the discs with the component which you used for recording.

Tracks on the Recordable/Rewritable discs cannot be skipped.

- Insert a finalized disc.
- Finalize the discs with the component which you used for recording.

Playback does not start.

- The file format is not supported by the unit.

No picture appears on the external monitor.

- Connect the video cord correctly.
- Select the correct input on the external monitor.

❑ DivX*/MPEG1/MPEG2/JPEG/MP3/WMA/WAV

Discs cannot be played back.

- Record the tracks using a compliant application on the appropriate discs. (Page 55)
- Add appropriate extension codes to the file names.

* Only for KW-V41BT Region 4/KW-V21BT Region 4/KW-V11 Region 4.

Tracks are not played back as you have intended them to play.

- Playback order may differ from the one played back using other players.

❑ USB

“Reading” does not disappear from the screen.

- Turn the power off and on again.

While playing a track, sound is sometimes interrupted.

- The tracks are not properly copied onto the USB device. Copy the tracks again, and try again.

REFERENCES

❑ iPod/iPhone

No sound comes out of the speakers.

- Disconnect the iPod/iPhone, then connect it again.
- Select another source, then reselect “iPod”.

The iPod/iPhone does not turn on or does not work.

- Check the connecting cable and its connection.
- Update the firmware version.
- Charge the battery.
- Reset the iPod/iPhone.

Sound is distorted.

- Deactivate the equalizer either on this unit or the iPod/iPhone.

A lot of noise is generated.

- Turn off (uncheck) “VoiceOver” of the iPod/iPhone. For details, visit <<http://www.apple.com>>.

No operations are available when playing back a track containing Artwork.

- Operate the unit after the Artwork has loaded.

Sound does not synchronize with the video.

- Select [iPod] for <AV Input>. (Page 16)

Videos cannot be played.

- Connect with USB Audio and Video cable JVC KS-U59. Other cables cannot be used.
- Select [iPod] for <AV Input>. (Page 16)

Videos have no sound.

- Connect with USB Audio and Video cable JVC KS-U59. Other cables cannot be used.
- Select [iPod] for <AV Input>. (Page 16)

❑ Tuner

SSM automatic presetting does not work.

- Store stations manually. (Page 22)

Static noise while listening to the radio.

- Connect the antenna firmly.

❑ AV-IN

No picture appears on the screen.

- Turn on the video component if it is not on.
- Connect the video component correctly.

❑ Pandora (only for KW-V41BT Region 1 / KW-V21BT Region 1/KW-V11 Region 1)

The Pandora application does not work.

- The Pandora application on your iPod touch/ iPhone/Android is not the latest version. Update the application.

❑ Bluetooth (only for KW-V41BT/KW-V21BT)

Phone sound quality is poor.

- Reduce the distance between the unit and the Bluetooth mobile phone.
- Move the car to a place where you can get a better signal reception.

The sound is interrupted or skipped while using a Bluetooth audio player.

- Reduce the distance between the unit and the Bluetooth audio player.
- Disconnect the device connected for Bluetooth phone.
- Turn off, then turn on the unit.
- (If the sound is not yet restored) connect the player again.

The connected audio player cannot be controlled.

- Check whether the connected audio player supports AVRCP (Audio Video Remote Control Profile).

Bluetooth device does not detect the unit.

- Search from the Bluetooth device again.

The unit does not pair with the Bluetooth device.

- For devices compatible with Bluetooth 2.1: Register the device using a PIN code. (Page 31)
- For devices compatible with Bluetooth 2.0: Enter the same PIN code for both the unit and target device. If the PIN code of the device is not indicated in its instructions, try “0000” or “1234”.

Echo or noise occurs.

- Adjust the microphone unit position.
- Make sure that the noise reduction/echo cancel function is activated. Adjust the echo volume and the noise reduction volume. (Page 33)

The unit does not respond when you try to copy the phone book to the unit.

- You may have tried to copy the same entries (as stored) to the unit.

REFERENCES

Specifications

❑ Monitor section

Picture Size (W x H)

KW-V41BT: 6.95 inches (diagonal) wide
156.6 mm × 81.6 mm (6-3/16" × 3-3/16")

KW-V21BT/KW-V11: 6.2 inches (diagonal) wide
137.5 mm × 77.2 mm (5-7/16" × 3-1/16")

Display System	Transparent TN LCD panel
Drive System	TFT active matrix system
Number of Pixels	1 152 000 (800H × 480V × RGB)
Effective Pixels	99.99%
Pixel Arrangement	RGB striped arrangement
Back Lighting	LED

❑ DVD player section

D/A Converter	24 bit
Audio Decoder	Linear PCM/Dolby Digital/MP3/WMA/WAV
Video Decoder	MPEG1/MPEG2/DivX*/JPEG
Wow & Flutter	Below Measurable Limit
Frequency Response	96 kHz Sampling: 20 Hz – 22 000 Hz 48 kHz Sampling: 20 Hz – 22 000 Hz 44.1 kHz Sampling: 20 Hz – 20 000 Hz
Total Harmonic Distortion	0.010% (1 kHz)
Signal to Noise Ratio	99 dB (DVD-Video 96 kHz)
Dynamic Range	99 dB (DVD-Video 96 kHz)
Disc Format	DVD-Video/VIDEO-CD/CD-DA
Sampling Frequency	44.1 kHz/48 kHz/96 kHz
Quantifying Bit Number	16/20/24 bit

* Only for KW-V41BT Region 4/KW-V21BT Region 4/KW-V11 Region 4.

❑ USB interface section

USB Standard	USB 2.0 Full Speed
Compatible Devices	Mass storage class
File System	FAT 12/16/32
Maximum Power Supply Current	DC 5 V $\overline{\text{---}}$ 1 A

D/A Converter	24 bit
Audio Decoder	MP3/WMA/WAV
Video Decoder	MPEG1/MPEG2/DivX*/JPEG

* Only for KW-V41BT Region 4/KW-V21BT Region 4/KW-V11 Region 4.

❑ Bluetooth section (only for KW-V41BT/KW-V21BT)

Technology	Bluetooth 2.1 + EDR
Frequency	2.402 GHz – 2.480 GHz
Output Power	+4 dBm (MAX), 0 dBm (AVE), Power Class 2
Maximum Communication Range	Line of sight approx. 10 m (32.8 ft)
Audio Codec	SBC
Profile	HFP (Hands Free Profile) 1.5 SPP (Serial Port Profile) 1.1 SDP (Service Discovery Profile) A2DP (Advanced Audio Distribution Profile) 1.2 AVRCP (Audio/Video Remote Control Profile) 1.3 OPP (Object Push Profile) PBAP (Phonebook Access Profile) 1.0 GAP (Generic Access Profile)

REFERENCES

FM tuner section

Frequency Range

With channel interval set to 200 kHz:
87.9 MHz to 107.9 MHz

With channel interval set to 50 kHz:
87.5 MHz to 108.0 MHz

Usable Sensitivity (S/N: 30 dB Dev 22.5 kHz)
7.2 dBf (0.63 μ V/75 Ω)

Quieting Sensitivity (S/N: 46 dB Dev 22.5 kHz)
15.2 dBf (1.58 μ V/75 Ω)

Frequency Response (\pm 3.0 dB)
30 Hz – 15 kHz

Signal to Noise Ratio
68 dB (MONO)

Selectivity (\pm 400 kHz)
 \geq 80 dB

Stereo Separation 40 dB (1 kHz)

AM tuner section

Frequency Range (10 kHz)
530 kHz to 1 700 kHz

Usable Sensitivity 29 dB μ

Video section

Color System of External Video Input
NTSC/PAL

External Video Input Level (RCA/mini jack)
1 Vp-p/75 Ω

Video Output Level (RCA jack)
1 Vp-p/75 Ω

Audio section

Maximum Power (Front & Rear)
50 W \times 4

Full Bandwidth Power (Front & Rear)
(4 Ω , 14.4 V, 1% THD)

22 W \times 4

Preout Level 4 V/10 k Ω

Preout Impedance \leq 600 Ω

Speaker Impedance 4 Ω – 8 Ω

Parametric Equalizer (5 Band)

Bass : 63 Hz, 80 Hz, 100 Hz, 125 Hz,
 \pm 10 dB

Mid Bass : 200 Hz, 250 Hz, 315 Hz, 400 Hz,
 \pm 10 dB

Mid: 0.63 kHz, 0.8 kHz, 1.0 kHz,
1.25 kHz, \pm 10 dB

Mid High: 2.0 kHz, 2.5 kHz, 3.15 kHz, 4.0 kHz,
 \pm 10 dB

High: 6.3 kHz, 8.0 kHz, 10.0 kHz,
12.5 kHz, \pm 10 dB

General

Operating Voltage

14.4 V (10.5 V – 16 V allowable)

Maximum Current Consumption

10 A

Installation Dimensions (W \times H \times D)

KW-V41BT Region 1/KW-V21BT Region 1/KW-V11
Region 1:

178 mm \times 100 mm \times 162 mm
(7-1/16" \times 3-15/16" \times 6-7/16")

KW-V41BT Region 4/KW-V21BT Region 4/KW-V11
Region 4:

182 mm \times 111 mm \times 160 mm
(7-3/16" \times 4-3/8" \times 6-5/16")

Operational Temperature Range

-10°C – +60°C

Weight (Main Unit)

KW-V41BT Region 1: 2.3 kg (5.1 lbs)

KW-V41BT Region 4: 2.6 kg (5.8 lbs)

KW-V21BT Region 1/KW-V11 Region 1:
1.6 kg (3.6 lbs)

KW-V21BT Region 4/KW-V11 Region 4:
1.9 kg (4.2 lbs)

Design and specifications are subject to change
without notice.

REFERENCES

If a kit is necessary for your car, consult your telephone directory for the nearest car audio speciality shop.

☐ Trademarks and licenses

- Manufactured under license from Dolby Laboratories. Dolby and the double-D symbol are trademarks of Dolby Laboratories.
- “DVD Logo” is a trademark of DVD Format/Logo Licensing Corporation registered in the US, Japan and other countries.
- Microsoft and Windows Media are either registered trademarks or trademarks of Microsoft Corporation in the United States and/or other countries.
- “Made for iPod,” and “Made for iPhone” mean that an electronic accessory has been designed to connect specifically to iPod, or iPhone, respectively, and has been certified by the developer to meet Apple performance standards. Apple is not responsible for the operation of this device or its compliance with safety and regulatory standards. Please note that the use of this accessory with iPod, or iPhone may affect wireless performance. iPhone, iPod, iPod classic, iPod nano, and iPod touch are trademarks of Apple Inc., registered in the U.S. and other countries.
- Lightning is a trademark of Apple Inc.
- This item incorporates copy protection technology that is protected by U.S. patents and other intellectual property rights of Rovi Corporation. Reverse engineering and disassembly are prohibited.
- Font for this product is designed by Ricoh.
- DivX Certified® to play DivX® video, including premium content.
- DivX®, DivX Certified® and associated logos are trademarks of Rovi Corporation or its subsidiaries and are used under license.
- ABOUT DIVX VIDEO: DivX® is a digital video format created by DivX, LLC, a subsidiary of Rovi Corporation. This is an official DivX Certified® device that has passed rigorous testing to verify that it plays DivX video. Visit divx.com for more information and software tools to convert your files into DivX videos.
- ABOUT DIVX VIDEO-ON-DEMAND: This DivX Certified® device must be registered in order to play purchased DivX Video-on-Demand (VOD) movies. To obtain your registration code, locate the DivX VOD section in your device setup menu (Page 46). Go to vod.divx.com for more information on how to complete your registration.
- THIS PRODUCT IS LICENSED UNDER THE MPEG-4 VISUAL PATENT PORTFOLIO LICENSE FOR THE PERSONAL AND NON-COMMERCIAL USE OF A CONSUMER FOR (i) ENCODING VIDEO IN COMPLIANCE WITH THE MPEG-4 VISUAL STANDARD (“MPEG-4 VIDEO”) AND/OR (ii) DECODING MPEG-4 VIDEO THAT WAS ENCODED BY A CONSUMER ENGAGED IN A PERSONAL AND NON-COMMERCIAL ACTIVITY AND/OR WAS OBTAINED FROM A VIDEO PROVIDER LICENSED BY MPEG LA TO PROVIDE MPEG-4 VIDEO. NO LICENSE IS GRANTED OR SHALL BE IMPLIED FOR ANY OTHER USE. ADDITIONAL INFORMATION INCLUDING THAT RELATING TO PROMOTIONAL, INTERNAL AND COMMERCIAL USES AND LICENSING MAY BE OBTAINED FROM MPEG LA, LLC. SEE [HTTP://WWW.MPEGLA.COM](http://WWW.MPEGLA.COM).
- Pandora, the Pandora logo, and the Pandora trade dress are trademarks or registered trademarks of Pandora Media, Inc., used with permission.
- Sirius, XM and all related marks and logos are trademarks of Sirius XM Radio Inc. All rights reserved.
- Android is a trademark of Google Inc.
- The Bluetooth® word mark and logos are registered trademarks owned by Bluetooth SIG, Inc. and any use of such marks by JVC KENWOOD Corporation is under license. Other trademarks and trade names are those of their respective owners.

Having TROUBLE with operation?

Please reset your unit

Refer to page of How to reset your unit

Still having trouble??

USA ONLY

Call 1-800-252-5722

<http://www.jvc.com>

We can help you!

JVC

TO OUR VALUED CUSTOMER

THANK YOU FOR PURCHASING THIS JVC PRODUCT.
WE WANT TO HELP YOU ACHIEVE A PERFECT EXPERIENCE.

**NEED HELP ON HOW TO HOOK UP?
NEED ASSISTANCE ON HOW TO OPERATE?
NEED TO LOCATE A JVC SERVICE CENTER?
LIKE TO PURCHASE ACCESSORIES?**

JVC IS HERE TO HELP!
TOLL FREE: 1 (800)252-5722
<http://www.jvc.com>

Remember to retain your Bill of Sale for Warranty Service.
Do not attempt to service the product yourself

Caution

To prevent electrical shock, do not open the cabinet.
There are no user serviceable parts inside.
Please refer to qualified service personnel for repairs.

PRODUCT REGISTRATION

We suggest that you register your product since it will enable us to contact you directly if it is ever necessary to correct a safety related condition in your product. You can register at www.register.jvc.com
Please note that failure to register does not diminish any of your rights during the warranty period.

JVC

LIMITED WARRANTY

ONLY FOR PRODUCT PURCHASED IN U.S.A.

JVC Americas Corp. (JVC) warrants this product and all parts thereof, except as set forth below **ONLY TO THE ORIGINAL RETAIL PURCHASER** to be **FREE FROM DEFECTIVE MATERIALS AND WORKMANSHIP** from the date of original purchase for the period shown below. ("The Warranty Period")

PARTS 2 YRS / LABOR 2 YRS : Car audio ARSENAL series

PARTS 1 YR / LABOR 1 YR : All other car audio products

THIS LIMITED WARRANTY IS VALID ONLY IN THE FIFTY (50) UNITED STATES, THE DISTRICT OF COLUMBIA AND IN THE COMMONWEALTH OF PUERTO RICO.

WHAT WE WILL DO:

If this product is found to be defective within the warranty period, JVC will repair or replace defective parts with new or rebuilt equivalents at no charge to the original owner. Such repair and replacement services shall be rendered by JVC during normal business hours at JVC authorized service centers. Parts used for replacement are warranted only for the remainder of the Warranty Period. All products may be brought to a JVC authorized service center on a carry-in basis. Color televisions with a screen size of 37" class or greater qualify for in-home service. In such cases, a technician will come to your home and either repair the TV there or remove and return it if it cannot be repaired in your home.

WHAT YOU MUST DO FOR WARRANTY SERVICE:

Please do not return your product to the retailer. Instead, return your product to the JVC authorized service center nearest you. If shipping the product to the service center, please be sure to package it carefully, preferably in the original packaging, and include a brief description of the problem(s) and a copy of the proof of purchase to verify purchase date. Please call 1-800-252-5722 to locate the nearest JVC authorized service center. Service locations can also be obtained from our website <http://www.jvc.com>. If your product qualifies for in-home service, the service representative will require clear access to the product.

If you have any questions concerning your JVC Product, please contact our Customer Care Center at 800-252-5722

WHAT IS NOT COVERED:

This limited warranty provided by JVC does not cover:

1. Products which have been subject to abuse, accident, alteration, modification, tampering, negligence, misuse, faulty installation, lack of reasonable care, or if repaired or serviced by anyone other than a service facility authorized by JVC to render such service, or if affixed to any attachment not provided with the products, or if the model or serial number has been altered, tampered with, defaced or removed;
2. Initial installation, installation and removal from cabinets or mounting systems.
3. Operational adjustments covered in the Owner's Manual, normal maintenance, video and audio head cleaning;
4. Damage that occurs in shipment, due to act of God, and cosmetic damage;
5. Signal reception problems and failures due to line power surge;
6. User Removal Memory Devices/Video Pick-up Tubes/CCD Image Sensors are covered for 90 days from the date of purchase;
7. Accessories;
8. Batteries (except that Rechargeable Batteries are covered for 90 days from the date of purchase);
9. Products used for commercial purposes, including, but not limited to rental.
10. Loss of data resultant from malfunction of hard drive or other data storage device;

There are no express warranties except as listed above.

THE DURATION OF ANY IMPLIED WARRANTIES, INCLUDING THE IMPLIED WARRANTY OF MERCHANTABILITY, IS LIMITED TO THE DURATION OF THE EXPRESS WARRANTY HEREIN. JVC SHALL NOT BE LIABLE FOR ANY LOSS OF USE OF THE PRODUCT, INCONVENIENCE, OR ANY OTHER DAMAGES, WHETHER DIRECT, INCIDENTAL OR CONSEQUENTIAL (INCLUDING, WITHOUT LIMITATION, DAMAGE TO TAPES, RECORDS OR DISCS) RESULTING FROM THE USE OF THIS PRODUCT, OR ARISING OUT OF ANY BREACH OF THIS WARRANTY. ALL EXPRESS AND IMPLIED WARRANTIES, INCLUDING THE WARRANTIES OF MERCHANTABILITY AND FITNESS FOR PARTICULAR PURPOSE, ARE LIMITED TO THE WARRANTY PERIOD SET FORTH ABOVE.

Some states do not allow the exclusion of incidental or consequential damages or limitations on how long an implied warranty lasts, so these limitations or exclusions may not apply to you. This warranty gives you specific legal rights and you may also have other rights which vary from state to state.

JVC AMERICAS CORP.

1700 Valley Road, Wayne, New Jersey 07470
<http://www.jvc.com>

REFURBISHED PRODUCTS CARRY A SEPARATE WARRANTY, THIS WARRANTY DOES NOT APPLY. FOR DETAIL OF REFURBISHED PRODUCT WARRANTY, PLEASE REFER TO THE REFURBISHED PRODUCT WARRANTY INFORMATION PACKAGED WITH EACH REFURBISHED PRODUCT.

For customer use:

Enter below the Model No. and Serial No. which is located either on the rear, bottom or side of the cabinet. Retain this information for future reference.

Model No.: _____

Serial No.: _____

Purchase date: _____

Name of dealer: _____



WARRANTY

Warranty applies only to PRODUCT distributed in Canada by JVC Canada Inc.

JVC CANADA INC. (hereafter called "JVC") gives the following express warranty for each new JVC product distributed in Canada by JVC and sold by an authorized JVC dealer. JVC warrants that this JVC product is free, under normal use and maintenance, from any defects in material and workmanship subject to the following terms and conditions:

- To Obtain Warranty Service:**
 - JVC product requiring service must be presented together with proof of purchase.
 - The JVC product must be brought in for service to an authorized JVC Service Centre.
- Limitation:**
This Warranty shall not apply to:
 - Repair or replacement of any cabinets, batteries, plates, connection cords, antennas, dust covers, knobs, speaker grills, speaker cones, projection screens, projection screen savers, and all accessories.
 - Any defects caused or repairs required as a result of misuse, abusive operation, negligence, improper use and/or insufficient care.
 - Any defect caused or repairs required as a result of not following the instructions in the operation manual.
 - Any JVC product tampered with, adjusted or repaired by any party other than JVC or authorized JVC Service Centre personnel.
 - Any JVC products on which the serial number has been defaced, modified or removed.
 - Maintenance, cleaning or periodic check-up
 - Conversion to foreign or domestic voltage or frequency.
 - Any JVC product without the Canadian Electrical Safety Regulations ID.
 - Any JVC products used for commercial or institutional, rental, or display purposes.
Parts 1 year (except video head - 90 days)
Labour ... 90 days
 - Any JVC product which has been resold and no longer owned by the original purchaser.
 - Product purchased from "outside Canada", "bankruptcy" or "liquidator".
 - Any defects caused by fire, flood, lightning, power surge, or other events beyond the control of JVC.
- FOR AUTO PRODUCTS**
Warranty does not cover elimination of car static or electrical interferences, cleaning of head, adjustments, or labour cost for the removal or reinstallation of the unit for repair.

- Standards:**
If any defects should be found in a JVC product within the applicable terms, necessary repairs shall be made at no cost to the purchaser for parts or labour when JVC acknowledges that such defects are due to faulty material or workmanship.
- Exclusion of All Other Express Warranties:**
This warranty constitutes the entire express warranty given by JVC for JVC products and no dealer or service centre personnel or his, its or their agent or employee is, or are authorized to extend or enlarge this warranty on behalf of JVC.
- Disclaimer of Consequential Damage:**
To the extent the law permits JVC disclaims any responsibility for loss of time or use of its product, transportation costs, or any other indirect, incidental or consequential damage or inconvenience.

WARRANTY TERM (VALID FROM THE DATE OF PURCHASE)

Product	Parts (Years)	Labour (Years)
Projection TV In-Home Service Colour TV In-Home (25" and above) D-ILA Rear Projection In-Home Service LCD TV In-Home Service (25" and above)	1	1
* In-Home service to be provided where available. Where it is not available, the purchaser must assume the responsibility and expense for the proper packing, shipment and all costs associated with the delivery of the equipment to and from the closest JVC Authorized Service Centre.		
Receivers and Home Speakers purchased separately. Front Projection and Car Audio "ARSENAL" Series	2	2
AC Adapters, Remote controls, Headphones, Microphones and Projector lamps	90 days	90 days
Wood Cone Speakers	5	5
All Other Categories	1	1

JVC CANADA INC.

6070 kestrel Road, Mississauga, Ontario, L5T 1 S8 Canada
TEL: (905) 670-3381 FAX: (905)670-7244 Service toll free #: 1-800-964-2650
http://www.jvc.ca E-mail: service@jvc.ca

Product Registration

We suggest that you register your product since it will enable us to contact you directly if it is ever necessary to correct a safety related condition in your product. You can register at <http://www.jvc.ca/www/Support/Warranty.aspx>

For customer use:

Enter below the Model No. and Serial No. which is located either on the rear, bottom or side of the cabinet. Retain this information for future reference.

Model No.: _____ Serial No.: _____
Purchase date: _____ Name of dealer: _____

GARANTIE

La garantie s'applique seulement aux PRODUITS distribués au Canada par JVC Canada Inc.

JVC CANADA INC. (ci-après appelé "JVC") énonce la garantie expresse suivante pour tout nouveau produit JVC distribué au Canada par JVC et vendu par un détaillant JVC autorisé. JVC vous garantit que ce produit est déchargé, sous utilisation et entretien normal, de tout défaut matériel et de fabrication sous réserve des modalités et conditions suivantes:

- Pour obtenir un service de garantie:**
 - Les produits JVC nécessitant un service doit être présentée avec la preuve d'achat.
 - Le produit JVC doit être apporté pour service chez un centre de service JVC autorisé.
- Restrictions:**
Cette garantie ne s'applique pas aux:
 - Réparation ou remplacement de tout cabinet, batteries, panneau avant, cordons de raccord, antennes, housses de protection, boutons, couverts de hautparleur, cônes de hautparleur, écrans de projection, protecteurs d'écran de projection et tous les accessoires.
 - Tous défauts occasionnés ou réparations requises suite à une utilisation abusive, mauvaise, négligente et/ou une utilisation incorrecte.
 - Tous défauts occasionnés ou réparations requises suite à l'omission de suivre les recommandations du manuel d'instruction.
 - Tout produit JVC altéré, ajusté ou réparé par tout autre entreprise que JVC ou un centre de service d'entretien ou de service autorisé JVC.
 - Tout produit JVC dont le numéro de série a été altéré, modifié ou enlevé.
 - L'entretien, les vérifications périodiques et nettoyage.
 - La conversion à une fréquence ou une tension étrangère ou domestique.
 - Tout produit JVC n'ayant pas le signe d'identification qui conforme aux normes électriques Canadiennes (CSA).
 - Pour tout produit utilisé à des fins commerciales, institutionnelles, de location ou utilisé à des fins d'étalage.
Pièces 1 An (Excepté les têtes vidéo- 90 jours)
Main d'œuvre ... 90 Jours
 - Tout produit JVC ayant été revendu et qui n'est plus la propriété de l'acheteur original.
 - Produit acheté à "l'extérieur du Canada", provenant d'une "faillite" ou d'un "liquidateur".
 - Tout dommage causé par le feu, une inondation, un éclair, une surtension ou tout autre événement hors du contrôle de JVC.

(m) POUR LES PRODUITS D'AUTOMOBILE

La garantie ne couvre pas l'élimination d'interférences statiques ou électriques de la voiture, le nettoyage de tête, les ajustements et les coûts de main d'œuvre associés à l'enlèvement ou à la réinstallation de l'unité pour réparation.

- Critères:**
Si un produit JVC s'avérait défectueux, selon les conditions applicables, les réparations nécessaires seront effectués sans coûts additionnels à l'acheteur pour les pièces et la main d'œuvre lorsque JVC reconnaît que de tels défauts sont causés par une défectuosité de matériel ou de fabrication.
- Exclusion de toutes autres garanties expresses :**
Cette garantie constitue l'entière garantie expresse donnée par JVC pour les produits JVC. Nul représentant ou employé d'un détaillant ou d'un service d'entretien n'est autorisé à prolonger cette garantie au nom de JVC.
- Dénégation des dommages indirects:**
Dans la mesure permise par la loi, JVC nie toute responsabilité pour perte de temps ou d'usage de ses produits, des coûts de transport ou tout autre dommage ou inconvénient indirect, accidentel et conséquent.

CONDITIONS DE GARANTIE (VALABLE À PARTIR DE LA DATE D'ACHAT)

Produit	Pièces (Années)	Main-D'œuvre (Années)
Écrans de projection Service à Domicile Écrans de TV Couleur Service à Domicile (25" et plus) TV projection arrière D-ILA Service à Domicile Écrans de LCD Service à Domicile (25" et plus)	1	1
* Service à domicile fourni par un détaillant disponible. S'il n'y a pas de service JVC disponible à proximité, l'acheteur doit assumer la responsabilité et les coûts pour un emballage adéquat, l'expédition, ainsi que tous les coûts associés à la livraison de l'équipement chez et depuis le détaillant JVC autorisé le plus près pour un service d'entretien.		
Récepteurs et Hauts-Parleurs achetés séparément, Projecteur Avant et Audio d'Auto de Série "ARSENAL"	2	2
Adaptateurs AC, Télécommande, Casque D'écoute, Microphones et Lampe de Projecteur	90 Jours	90 Jours
Enceinte à Cône en Bois	5	5
Toutes les autres catégories	1	1

JVC CANADA INC.

6070 kestrel Road, Mississauga, Ontario, L5T 1 S8 Canada
TEL: (905) 670-3381 FAX: (905)670-7244 Service toll free #: 1-800-964-2650
http://www.jvc.ca E-mail: service@jvc.ca

Enregistrement du produit

Nous vous conseillons d'enregistrer votre produit, car il nous permettra de vous contacter directement si jamais elle est nécessaire pour corriger un problème lié à la sécurité de votre produit. Vous pouvez vous inscrire à <http://www.jvc.ca/www/Support/Warranty.aspx>

Pour l'utilisation des clients:

Entrez ci-dessous le numéro de modèle et le numéro de série qui se trouve soit à l'arrière, en bas ou sur le côté de l'armoire. Conservez ces informations pour référence future.

No. de modèle: _____ No. de série: _____
Date d'achat: _____ Nom du revendeur: _____

Free Manuals Download Website

<http://myh66.com>

<http://usermanuals.us>

<http://www.somanuals.com>

<http://www.4manuals.cc>

<http://www.manual-lib.com>

<http://www.404manual.com>

<http://www.luxmanual.com>

<http://aubethermostatmanual.com>

Golf course search by state

<http://golfingnear.com>

Email search by domain

<http://emailbydomain.com>

Auto manuals search

<http://auto.somanuals.com>

TV manuals search

<http://tv.somanuals.com>