

Use & Care Guide

Model No.

153.330200 30 Gallon Tall

153.330220 40 Gallon Tall

153.330230 50 Gallon Tall



Kenmore® Gas Water Heater

For potable water heating only.
Not suitable for space heating.
Not for use in mobile homes.

INSTALLER: Affix these instructions to or near the water heater.

OWNER: Retain these instructions for future reference.

FOR YOUR SAFETY: An odorant is added to the gas used by this water heater.

ADVERTENCIA

Si no puede leer o entender el inglés y necesita el manual de instrucciones en español, puede solicitarlo al 1-800-821-2017. NO TRATE DE INSTALAR U OPERAR ESTE CALENTADOR DE AGUA SI NO ENTIENDE LAS INSTRUCCIONES. No hacer caso de esta advertencia podría originar lesiones graves o mortales.

P/N 319588-002 (1010)

Sears Brands Management Corporation,
Hoffman Estates, IL 60179 U.S.A.

www.kenmore.com
www.sears.com







WARNING: If the information in these instructions is not followed exactly, a fire or explosion may result causing property damage, personal injury or death.

- Do not store or use gasoline or other flammable vapors and liquids in the vicinity of this or any other appliance.
- **WHAT TO DO IF YOU SMELL GAS:**
 - Do not try to light any appliance.
 - Do not touch any electrical switch; do not use any phone in your building.
 - Immediately call your gas supplier from a neighbor's phone. Follow the gas supplier's instructions.
 - If you cannot reach your gas supplier, call the fire department.
- Installation and service must be performed by a qualified installer, service agency or the gas supplier.

SAFE INSTALLATION, USE AND SERVICE

Your safety and the safety of others is extremely important in the installation, use and servicing of this water heater.

Many safety-related messages and instructions have been provided in this manual and on your own water heater to warn you and others of a potential injury hazard. Read and obey all safety messages and instructions throughout this manual. It is very important that the meaning of each safety message is understood by you and others who install, use or service this water heater.

	This is the safety alert symbol. It is used to alert you to potential personal injury hazards. Obey all safety messages that follow this symbol to avoid possible injury or death.
	DANGER indicates an imminently hazardous situation which, if not avoided, will result in death or injury.
	WARNING indicates a potentially hazardous situation which, if not avoided, could result in death or injury.
	CAUTION indicates a potentially hazardous situation which, if not avoided, could result in minor or moderate injury.
	CAUTION used without the safety alert symbol indicates a potentially hazardous situation which, if not avoided, could result in property damage.



All safety messages will generally tell you about the type of hazard, what can happen if you do not follow the safety message and how to avoid the risk of injury.

The California Safe Drinking Water and Toxic Enforcement Act requires the Governor of California to publish a list of substances known to the State of California to cause cancer, birth defects, or other reproductive harm, and requires businesses to warn of potential exposure to such substances. **WARNING:** This product contains a chemical known to the State of California to cause cancer, birth defects, or other reproductive harm. This appliance can cause low-level exposure to some of the substances included in the act.

IMPORTANT DEFINITIONS

- **Qualified Technician:** A qualified technician must have ability equivalent to a licensed tradesman in the fields of plumbing, air supply, venting, and gas supply, including a thorough understanding of the requirements of the National Fuel Gas Code as it relates to the installation of gas fired water heaters. The qualified technician must also be familiar with the design features and use of flammable vapor ignition resistant water heaters, and have a thorough understanding of this instruction manual.
- **Service Agency:** A service agency also must have ability equivalent to a licensed tradesman in the fields of plumbing, air supply, venting and gas supply, including a thorough understanding of the requirements of the National Fuel Gas Code as it relates to the installation of gas fired water heaters. The service agency must also have a thorough understanding of this instruction manual, and be able to perform repairs strictly in accordance with the service guidelines provided by the manufacturer.
- **Gas Supplier:** The natural gas or propane utility or service who supplies gas for utilization by the gas burning appliances within this application. The gas supplier typically has responsibility for the inspection and code approval of gas piping up to and including the natural gas meter or propane storage tank of a building. Many gas suppliers also offer service and inspection of appliances within the building.

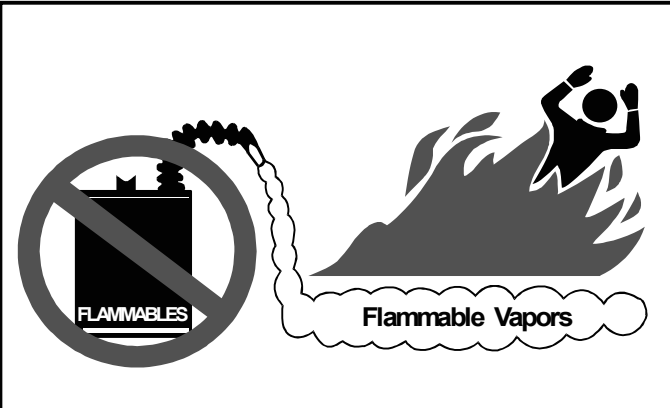
SAFETY PRECAUTIONS



	<h3> WARNING</h3> <p>FIRE AND EXPLOSION HAZARD Can result in serious injury or death</p> <p> Do not store or use gasoline or other flammable vapors and liquids in the vicinity of this or any other appliance. Storage of or use of gasoline or other flammable vapors or liquids in the vicinity of this or any other appliance can result in serious injury or death.</p>
<p>Read and follow water heater warnings and instructions.</p>	

	⚠ WARNING
	<p>Read and understand instruction manual and safety messages before installing, operating or servicing this water heater.</p> <p>Failure to follow instructions and safety messages could result in death or serious injury.</p> <p>Instruction manual must remain with water heater.</p>

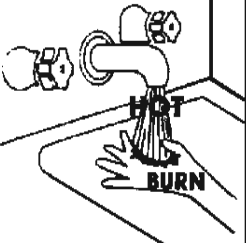
	⚠ WARNING
	<p>Fire Hazard</p> <p>For continued protection against risk of fire:</p> <ul style="list-style-type: none"> • Do not install water heater on carpeted floor. • Do not operate water heater if flood damaged.

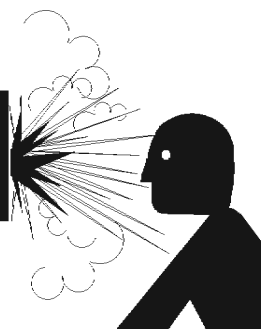
	⚠ DANGER
	<p>Water temperature over 125°F (52°C) can cause severe burns instantly resulting in severe injury or death.</p> <p>Children, the elderly, and the physically or mentally disabled are at highest risk for scald injury.</p> <p>Feel water before bathing or showering.</p> <p>Temperature limiting valves are available.</p> <p>Read instruction manual for safe temperature setting.</p>

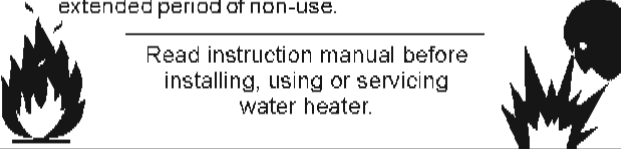
	⚠ WARNING
	<p>Explosion Hazard</p> <ul style="list-style-type: none"> • Overheated water can cause water tank explosion. • Properly sized temperature and pressure relief valve must be installed in opening provided.

⚠ WARNING	
Fire or Explosion Hazard	
<ul style="list-style-type: none"> • Do not store or use gasoline or other flammable vapors and liquids in the vicinity of this or any other appliance. • Avoid all ignition sources if you smell LP gas. • Do not expose water heater control to excessive gas pressure. • Use only gas shown on rating plate. • Maintain required clearances to combustibles. • Keep ignition sources away from faucets after extended period of non-use. 	 <p>Read instruction manual before installing, using or servicing water heater.</p> 

⚠ WARNING	
Breathing Hazard - Carbon Monoxide Gas	
	<ul style="list-style-type: none"> • Install vent system in accordance with codes. • Do not operate water heater if flood damaged. • High altitude orifice must be installed for operation above 2,000 feet (610 m). • Do not operate if soot buildup. • Do not obstruct water heater air intake with insulating jacket. • Do not place chemical vapor emitting products near water heater. • Gas and carbon monoxide detectors are available.
Breathing carbon monoxide can cause brain damage or death. Always read and understand instruction manual.	

CAUTION
Improper installation and use may result in property damage.
<ul style="list-style-type: none"> • Do not operate water heater if flood damaged. • Inspect and replace anode. • Install in location with drainage. • Fill tank with water before operation. • Be alert for thermal expansion. <p>Refer to instruction manual for installation and service.</p>

TABLE OF CONTENTS

SAFE INSTALLATION, USE AND SERVICE	2
SAFETY PRECAUTIONS.....	2-3
TABLE OF CONTENTS.....	4
WARRANTY.....	5
CUSTOMER RESPONSIBILITIES.....	6
PRODUCT SPECIFICATIONS.....	6
MATERIALS AND BASIC TOOLS NEEDED.....	7
Materials Needed	7
Basic Tools.....	7
TYPICAL INSTALLATION.....	8
INSTALLATION INSTRUCTIONS.....	9-18
Removing the Old Water Heater.....	9
Facts to Consider About the Location.....	10-11
Insulation Blankets	11-12
Combustion Air and Ventilation Appliances in Unconfined Spaces	12
Combustion Air and Ventilation Appliances in Confined Spaces	12-13
Water Piping	13-14
T & P Valve and Pipe Insulation	14
Temperature Pressure Relief Valve	15,16
Filling the Water Heater	16
Venting.....	16-17
Gas Piping.....	17,18
Sediment Trap	18
OPERATING INSTRUCTIONS.....	19-21
Lighting & Operating Label.....	19
Temperature Regulation	20
Operating the Temperature Control System.....	21
SERVICE AND ADJUSTMENT	22-27
Venting System Inspection	22
Burner Inspection	22
Removing the Burner Door Assembly	23
Ultra Low NOx Natural Gas Burner	23
Replacing the Pilot/Thermopile Assembly	23
External Inspection & Cleaning of the Flame Trap	24
Cleaning the Combustion Chamber and Flame Trap	24
Replacing the Burner Door Assembly.....	25
Piezoelectric Igniter System	25
Testing the Igniter System	25
Removing and Replacing the Gas Control Valve/Thermostat	26
Housekeeping.....	26
Anode Rod Inspection	26-27
Temperature-Pressure Relief Valve Operation	27
Draining	27
Drain Valve Washer Replacement.....	27
Service.....	27
TROUBLESHOOTING GUIDE.....	28-34
Start Up Conditions	28
Thermal Expansion	28
Strange Sounds	28
Draft Hood Operation	28
Condensation.....	29
Smoke/Odor.....	29
Operational Conditions.....	29-30
Smelly Odor	29
Water Temperature Stacking.....	29
Air in Hot Water Faucets	29
Safety Shut-Off.....	29,30
Troubleshooting Items	30-34
PARTS ORDER LIST.....	35

PRODUCT WARRANTY

6 - YEAR LIMITED WARRANTY ON WATER HEATER

For six years from the date of purchase, if this water heater is installed and operated in a single-family home in accordance with the owner's manual instructions and all local applicable plumbing codes, Sears will:

1. Supply free water heater parts for those that are defective in material or workmanship.
2. Supply a free water heater for one that develops a tank leak. See notes below also.

For the second through sixth year from the purchase date, you must pay the labor cost for installation of parts or water heater.

For commercial, institutional, industrial or residential use by two or more families, the above limited warranty is only for two years. During the second year you must pay the labor cost for parts or water heater installation.

If governmental regulations prohibit Sears from furnishing a comparable model replacement water heater under this warranty, Sears will furnish a new water heater of comparable output as permitted by such governmental regulations; however, the Owner will be charged for the additional cost associated with the changes made to comply with such governmental regulations.

Replacements furnished under this warranty do not carry a new warranty and are only covered by the unexpired portion of the original warranty.

1 - YEAR EXCLUSIVE KENMORE LABOR WARRANTY

For the first year from the date of purchase, Sears will, free of charge, supply and install new water heater parts for defective ones or a new water heater for one that develops a leak.

WARRANTY SERVICE

To obtain warranty service, call 1-800-4-MY-HOME® (1-800-469-4663). This warranty applies only while this product is in use in the United States. This warranty gives you specific legal rights, and you may also have other rights which vary from state to state.

SEARS BRANDS MANAGEMENT CORPORATION, Hoffman Estates, IL 60179

The price of your water heater does not include a free checkup service call. On water heater installations arranged by Sears, Sears warrants the installation.

A charge will be made on service calls due to poor or incomplete installation. These include:

- a. Adjusting thermostat
- b. Condensation
- c. Leaks in pipes or fittings

Master Protection Agreements

Congratulations on making a smart purchase. Your new Kenmore® product is designed and manufactured for years of dependable operation. But like all products, it may require preventive maintenance or repair from time to time. That's when having a Master Protection Agreement can save you money and aggravation.

The Master Protection Agreement also helps extend the life of your new product. Here's what the Agreement* includes:

- **Parts and labor** needed to help keep products operating properly **under normal use**, not just defects. Our coverage goes **well beyond the product warranty**. No deductibles, no functional failure excluded from coverage— **real protection**.
- **Expert service** by a force of more than **10,000 authorized Sears service technicians**, which means someone you can trust will be working on your product.
- **Unlimited service calls and nationwide service**, as often as you want us, whenever you want us.
- **"No-lemon"** guarantee – replacement of your covered product if four or more product failures occur within twelve months.
- **Product replacement** if your covered product can't be fixed.
- **Annual Preventive Maintenance Check** at your request – no extra charge.
- **Fast help by phone** – we call it **Rapid Resolution** – phone support from a Sears representative on all products. Think of us as a "talking owner's manual."
- **Power surge protection** against electrical damage due to power fluctuations.

- **\$250 Food Loss Protection** annually for any food spoilage that is the result of mechanical failure of any covered refrigerator or freezer.
- **Rental reimbursement** if repair of your covered product takes longer than promised.
- **10% discount** off the regular price of any non-covered repair service and related installed parts.

Once you purchase the Agreement, a simple phone call is all that it takes for you to schedule service. You can call anytime day or night, or schedule a service appointment online.

The Master Protection Agreement is a risk free purchase. If you cancel for any reason during the product warranty period, we will provide a full refund. Or, a prorated refund anytime after the product warranty period expires. Purchase your Master Protection Agreement today!

Some limitations and exclusions apply. For prices and additional information in the U.S.A. call 1-800-827-6655.

*** Coverage in Canada varies on some items. For full details, call Sears Canada at 1-800-361-6665.**

Sears Installation Service

For Sears professional installation of home appliances, garage door openers, water heaters, and other major home items, in the U.S.A. or Canada call **1-800-4-MY-HOME®**.

CUSTOMER RESPONSIBILITIES

Thank You for purchasing a Kenmore water heater. Properly installed and maintained, it should give you years of trouble free service. If you should decide that you want the new water heater professionally installed by Sears, call 1-800-4-MY-HOME®. They will arrange for prompt, quality installation by Sears authorized contractors.

Abbreviations Found In This Instruction Manual:

- CSA - Canadian Standards Association
- ANSI - American National Standards Institute
- NFPA - National Fire Protection Association
- ASME - American Society of Mechanical Engineers
- GAMA - Gas Appliance Manufacturers Association
- This gas-fired water heater is design certified by CSA INTERNATIONAL under American National Standard/CSA Standard for Gas Water Heaters ANSI Z21.10.1 • CSA 4.1 (current edition).
- Read the “Safety Precautions” section first (pages 2 and 3 of this manual) and then read the entire manual carefully. If you don’t follow the safety rules, the water heater will not operate properly. It could cause DEATH, SERIOUS BODILY INJURY AND/OR PROPERTY DAMAGE.

This manual contains instructions for the installation, operation, and maintenance of the gas-fired water heater. It also contains warnings through out the manual that you must read and be aware of. All warnings and all instructions are essential to the proper operation of the water heater and your safety. Since we cannot put everything on the first few pages, **READ THE**

ENTIRE MANUAL BEFORE ATTEMPTING TO INSTALL OR OPERATE THE WATER HEATER.

- The installation must conform with these instructions and the local code authority having jurisdiction. In the absence of local codes, installations shall comply with the current edition of The National Fuel Gas Code ANSI Z223.1/NFPA 54. This publication is available from the Canadian Standards Association, 8501 East Pleasant Valley Rd, Cleveland Ohio 44131, or The National Fire Protection Association, 1 Batterymarch Park, Quincy, MA 02269.
- If after reading this manual you have any questions or do not understand any portion of the instructions, call the Sears Service Center.
- Carefully plan the place where you are going to put the water heater. Correct combustion, vent action, and vent pipe installation are very important in preventing death from possible carbon monoxide poisoning and fires. See figure 1.
Examine the location to ensure the water heater complies with the *Facts to Consider About the Location* section in this manual.
- For California installation this water heater must be braced, anchored, or strapped to avoid falling or moving during an earthquake. See instructions for correct installation procedures. Instructions may be obtained from the California Office of the State Architect, 1102 Q Street, Suite 5100, Sacramento, CA 95811. Instructions can also be downloaded to your computer at WWW.dsa.dgs.ca.gov/Pubs.
- Complies with 10 ng/J SCAQMD rule #1121 and districts having equivalent NOx requirements.

PRODUCT SPECIFICATIONS

MODEL NUMBER	TANK CAPACITY IN GALS (LTRS)	TYPE OF GAS	INPUT RATE (Btu/hr)	RECOVERY RATE GALS. PER HOUR @ 90°F RISE	MINIMUM VENT PIPE INCHES (mm)	DIAMETER INCHES (mm)	DIMENSIONS IN INCHES (mm) HEIGHT TO JACKET TOP
153.330200	30 (114)	NATURAL	30,000	31	3" (76) OR 4" (102)	16 (406)	56-3/8 (1432)
153.330220	40 (151)	NATURAL	40,000	41	3" (76) OR 4" (102)	18 (457)	58-5/8 (1489)
153.330230	50 (189)	NATURAL	40,000	41	3" (76) OR 4" (102)	20 (508)	57-3/8 (1457)

MATERIALS AND BASIC TOOLS NEEDED

MATERIALS NEEDED

To simplify the installation Sears has available the installation parts shown below. You may or may not need all of these materials, depending on your type of installation.

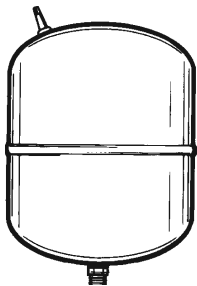

EXPANSION TANKS FOR THERMAL EXPANSION CONDITIONS AVAILABLE IN 2 GALLONS (7.6 LITERS) AND 5 GALLONS (18.9 LITERS) CAPACITY THROUGH LOCAL SEARS STORE OR SERVICE CENTER.

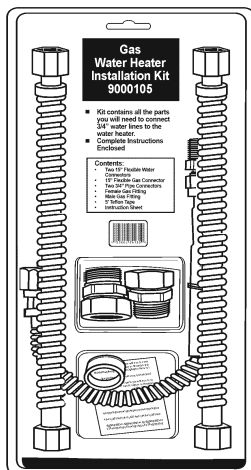

WATER HEATER INSTALLATION KIT WITH FLEXIBLE CONNECTORS FOR 3/4" (19.05 mm) COPPER PLUMBING AND FLEXIBLE GAS CONNECTOR WITH FITTINGS.

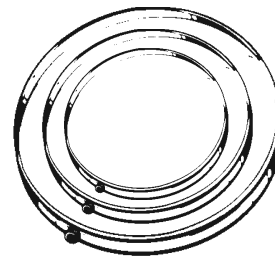

METAL DRAIN PANS AVAILABLE IN 20" (508 mm) DIAMETER FOR WATER HEATERS HAVING A DIAMETER 18" (457 mm) OR LESS, 24" (610mm) DIAMETER FOR WATER HEATERS HAVING A DIAMETER 22" (559 mm) OR LESS AND AVAILABLE IN 28" (711 mm) DIAMETER FOR WATER HEATERS HAVING A DIAMETER 26" (660 mm) OR LESS.

BASIC TOOLS

You may or may not need all these tools, depending on your type of installation. These tools can be purchased at your local Sears Store.

- Pipe Wrenches (2) 14" (356 mm)
- Screwdriver
- Tin Snips
- 6' (1.82 m) Tape or Folding Ruler
- Garden Hose
- Drill
- Pipe Dope or Teflon Tape



SLOT-HEAD SCREWDRIVER



PHILLIPS SCREWDRIVER



ROLL OF TEFLON TAPE (USE ONLY ON WATER CONNECTIONS)



GARDEN HOSE



6 FOOT TAPE



TIN SNIPS



PIPE DOPE (SQUEEZE TUBE) USE FOR WATER AND GAS CONNECTIONS



PIPE WRENCH

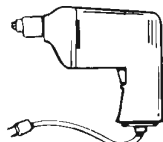

DRILL

ADDITIONAL TOOLS NEEDED WHEN SWEAT SOLDERING

- Tubing Cutters or Hacksaw
- Propane Torch
- Soft Solder
- Solder Flux
- Emery Cloth
- Wire Brushes



TUBING CUTTER



PROPANE TORCH

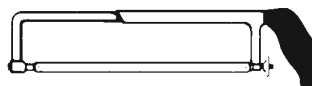

HACKSAW



ROLL OF EMERY CLOTH



3/4" (19 mm) WIRE BRUSH



1/2" (13 mm) WIRE BRUSH



ROLL OF LEAD-FREE SOFT SOLDER



SOLDER FLUX

TYPICAL INSTALLATION

GET TO KNOW YOUR WATER HEATER - GAS MODELS

- | | | |
|-------------------------------------|--|---|
| A Vent Pipe | J Drip Leg (Sediment Trap) | S Flue Baffle |
| B Draft Hood | K Inner Door | T Gas Control Valve/Thermostat |
| C Anode | L Outer Door | U Drain Valve |
| D Hot Water Outlet | M Union | V Pilot and Burner Door Assemblies |
| E Outlet | N Inlet Water Shut-off Valve | W Flue |
| F Flexible Water Connections | O Cold Water Inlet | X Metal Drain Pan |
| G Gas Supply | P Inlet Dip Tube | |
| H Manual Gas Shut-off Valve | Q Temperature-Pressure Relief Valve | |
| I Ground Joint Union | R Rating Plate | |

* INSTALL IN ACCORDANCE WITH LOCAL CODES.

* DRIP LEG AS REQUIRED BY LOCAL CODES.

TO VENT TERMINATION ON ROOF

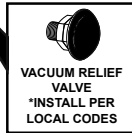
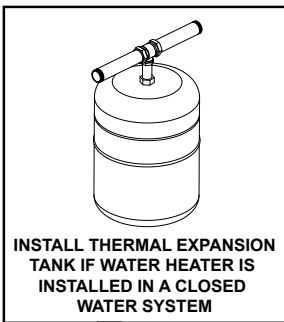
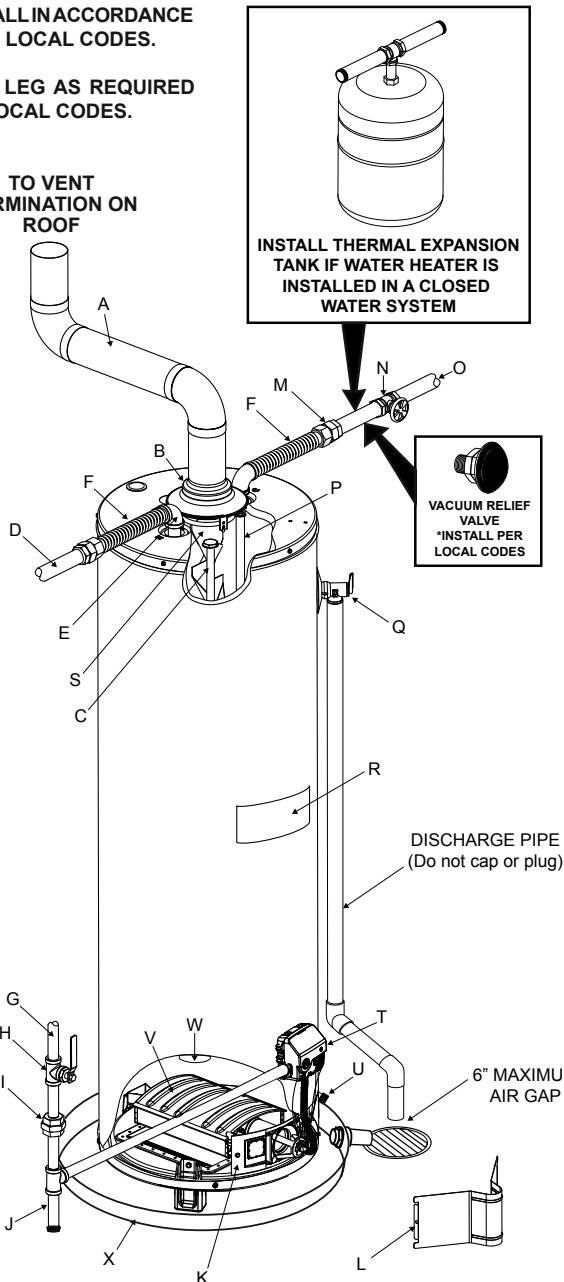

* ALL PIPING MATERIALS TO BE SUPPLIED BY CUSTOMERS.

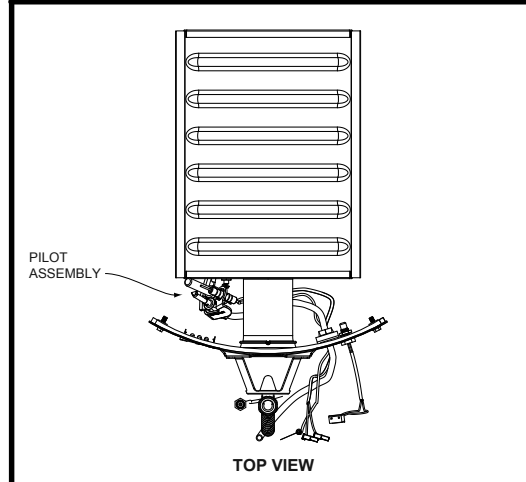
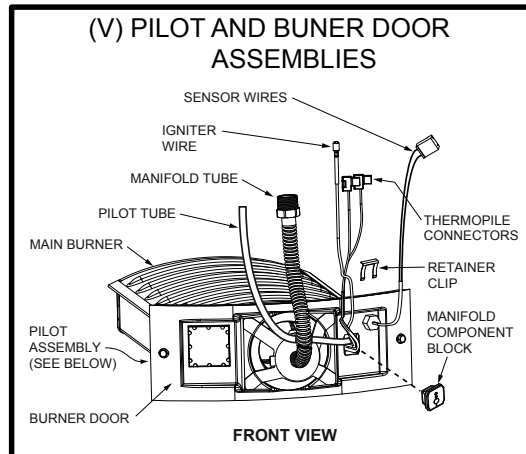
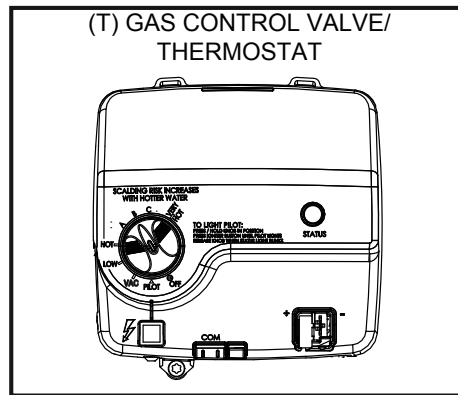

FIGURE 1.

INSTALLATION INSTRUCTIONS

Removing the Old Water Heater

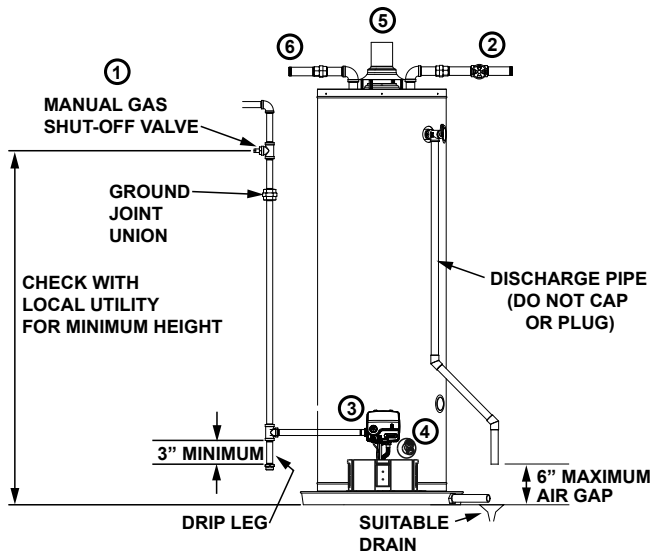

FIGURE 2.

- ① Turn "OFF" the gas supply to the water heater.

If the main gas line shutoff valve serving all gas appliances is used, also shut "OFF" the gas at each appliance. Leave all gas appliances shut "OFF" until the water heater installation is completed. See Figures 2 and 3.

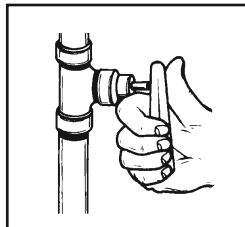

FIGURE 3.

- ② Open a nearby hot water faucet until the water is no longer hot. When the water has cooled, turn "OFF" the water supply to the water heater at the water shut off valve or water meter. Some installations require that the water be turned off to the entire house. See Figures 2 and 4.

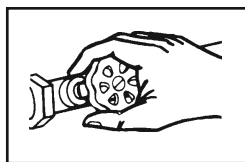
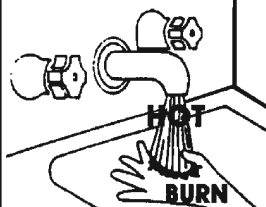

FIGURE 4.

- ③ Check again to make sure the gas supply is "OFF" to the water heater. Then disconnect the gas supply connection from the gas control valve.

▲ DANGER



- Burn hazard
- Hot water discharge.
- Keep hands clear of drain valve discharge.

- ④ Attach a hose to the water heater drain valve and put the other end in a floor drain or outdoors. (See Figures 2 and 5.) Open the water heater drain valve.

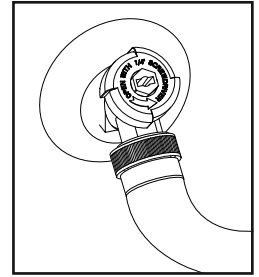

FIGURE 5.

- ⑤ Disconnect the vent pipe from the draft hood where it connects to the water heater. In most installations the vent pipe can be lifted off after any screw or other attached devices are removed. Dispose of the draft hood. The new water heater has a draft hood which must be used for proper operation.

- ⑥ If you have copper piping to the water heater, the two copper water pipes can be cut with a hacksaw approximately four inches away from where they connect to the water heater. See Figure 6. This will avoid cutting off pipes too short. Additional cuts can be made later if necessary. Disconnect the temperature-pressure relief valve drain line. When the water heater is drained, disconnect the hose from the drain valve. Close the drain valve. The water heater is now completely disconnected and ready to be removed.

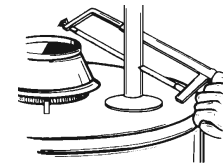

FIGURE 6.

If you have galvanized pipes to the water heater, loosen the two galvanized pipes with a pipe wrench at the union in each line. Also disconnect the piping remaining to the water heater. See Figure 7. These pieces should be saved since they may be needed when reconnecting the new water heater. Disconnect the temperature-pressure relief valve drain line. When the water heater is drained, disconnect the hose from the drain valve. Close the drain valve. The water heater is now completely disconnected and ready to be removed. Mineral buildup or sediment may have accumulated in the old water heater. This causes the water heater to be much heavier than normal and this residue, if spilled out, could cause staining.

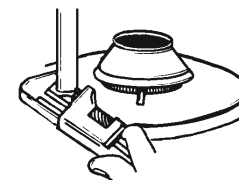

FIGURE 7.

Facts to Consider About the Location

Carefully choose an indoor location for the new water heater. The placement is a very important consideration for the safety of the occupants in the building and for the most economical use of the appliance. This water heater is not for use in manufactured (mobile) homes or outdoor installation.

Whether replacing an old water heater or putting the water heater in a new location, the following critical points must be observed:

- Select a location indoors as close as practical to the gas vent or chimney to which the water heater vent is going to be connected, and as centralized with the water piping system as possible.
- Selected location must provide adequate clearances for servicing and proper operation of the water heater.



CAUTION
Property Damage Hazard
<ul style="list-style-type: none">• All water heaters eventually leak• Do not install without adequate drainage.

Installation of the water heater must be accomplished in such a manner that if the tank or any connections should leak, the flow will not cause damage to the structure. For this reason, it is not advisable to install the water heater in an attic or upper floor. When such locations cannot be avoided, a suitable metal drain pan should be installed under the water heater. Metal drain pans are available at your local Sears or hardware store. Such a drain pan must have a minimum length and width of at least 2 inches (51 mm) greater than the water heater dimensions and must be piped to an adequate drain. The pan must not restrict combustion air flow.

Water heater life depends upon water quality, water pressure and the environment in which the water heater is installed. Water heaters are sometimes installed in locations where leakage may result in property damage, even with the use of a metal drain pan piped to a drain. Unanticipated damage can be reduced or prevented by a leak detector or water shut-off device used in conjunction with a piped metal drain pan. These devices are available from some plumbing supply wholesalers and retailers, and detect and react to leakage in various ways:

- Sensors mounted in the metal drain pan that trigger an alarm or turn off the incoming water to the water heater when leakage is detected.
- Sensors mounted in the metal drain pan that turn off the water supply to the entire home when water is detected in the metal drain pan.
- Water supply shut-off devices that activate based on the water pressure differential between the cold water and hot water pipes connected to the water heater.

- Devices that will turn off the gas supply to a gas water heater while at the same time shutting off its water supply.

⚠ WARNING
Fire or Explosion Hazard
<ul style="list-style-type: none">• Do not store or use gasoline or other flammable vapors and liquids in the vicinity of this or any other appliance.• Avoid all ignition sources if you smell LP gas.• Do not expose water heater control to excessive gas pressure.• Use only gas shown on rating plate.• Maintain required clearances to combustibles.• Keep ignition sources away from faucets after extended period of non-use.
 Read instruction manual before installing, using or servicing water heater. 

INSTALLATIONS IN AREAS WHERE FLAMMABLE LIQUIDS (VAPORS) ARE LIKELY TO BE PRESENT OR STORED (GARAGES, STORAGE AND UTILITY AREAS, ETC.): Flammable liquids (such as gasoline, solvents, propane [LP or butane, etc.] and other substances such as adhesives, etc.) emit flammable vapors which can be ignited by a gas water heater's pilot light or main burner. The resulting flashback and fire can cause death or serious burns to anyone in the area. Even though this water heater is a flammable vapor ignition resistant water heater and is designed to reduce the chances of flammable vapors being ignited, gasoline and other flammable substances should never be stored or used in the same vicinity or area containing a gas water heater or other open flame or spark producing appliance.

Also, the water heater must be located and/or protected so it is not subject to physical damage by a moving vehicle.

	⚠ WARNING
	Fire Hazard
	For continued protection against risk of fire:
	<ul style="list-style-type: none">• Do not install water heater on carpeted floor.• Do not operate water heater if flood damaged.

This water heater must not be installed directly on carpeting. Carpeting must be protected by metal or wood panel beneath the appliance extending beyond the full width and depth of the appliance by at least 3 inches (76.2mm) in any direction, or if the appliance is installed in an alcove or closet, the entire floor must be covered by the panel. Failure to heed this warning may result in a fire hazard.

⚠ WARNING

Fire or Explosion Hazard

Read instruction manual before installing, using or servicing water heater.

- Improper use may result in fire or explosion.
- Maintain required clearances to combustibles.



Minimum clearances between the water heater and combustible surfaces are 0 inch at the sides and rear, 4 inches (102 mm) at the front, and 6 inches (153 mm) from the vent pipe. See Figure 8. Clearance from the top of the jacket is 8 inches (203 mm) on most models. Note that a lesser dimension may be allowed on some models. Refer to the label attached adjacent to the gas control valve on the water heater.

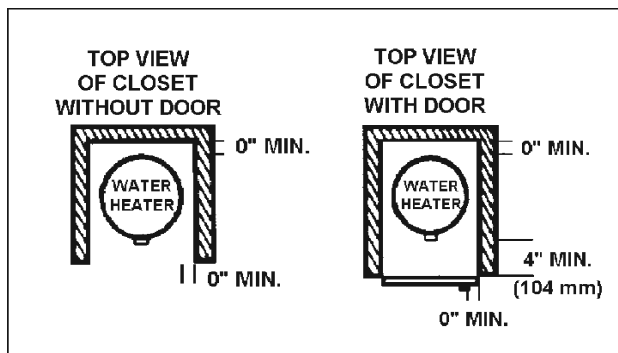
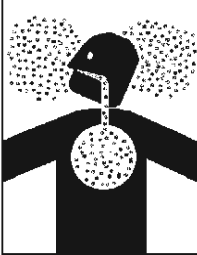

FIGURE 8.

⚠ WARNING

Breathing Hazard - Carbon Monoxide Gas



- Install water heater in accordance with the instruction manual and NFPA 54.
- To avoid injury, combustion and ventilation air must be taken from outdoors.
- Do not place chemical vapor emitting products near water heater.

Breathing carbon monoxide can cause brain damage or death. Always read and understand instruction manual.

A gas water heater cannot operate properly without the correct amount of air for combustion. See Figure 9. Do not install in a confined area such as a closet, unless you provide air as shown in the *Locating The New Water Heater* section. Never obstruct the flow of ventilation air. If you have any doubts or questions at all, call your gas supplier. Failure to provide the proper amount of combustion air can result in a fire or explosion and cause death, serious bodily injury, or property damage.

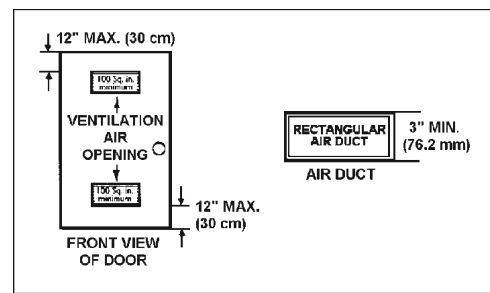

FIGURE 9.

If this water heater will be used in beauty shops, barber shops, cleaning establishments, or self-service laundries with dry cleaning equipment, it is imperative that the water heater or water heaters be installed so that combustion and ventilation air be taken directly from outdoors (direct vent).

Propellants of aerosol sprays and volatile compounds, (cleaners, chlorine based chemicals, refrigerants, etc.) in addition to being highly flammable in many cases, will also change to corrosive hydrochloric acid when exposed to the combustion products of the water heater. The results can be hazardous, and also cause product failure.

Insulation Blankets

Insulation blankets available to the general public for external use on gas water heaters are not necessary with Kenmore products. The purpose of an insulation blanket is to reduce the standby heat loss encountered with storage tank heaters. Your Kenmore water heater meets or exceeds the National Appliance Energy Conservation Act standards with respect to insulation and standby loss requirements, making an insulation blanket unnecessary.

⚠ WARNING

Breathing Hazard - Carbon Monoxide Gas

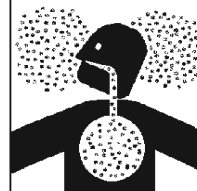

- Do not obstruct water heater air intake with insulating blanket.
- Gas and carbon monoxide detectors are available.
- Install water heater in accordance with the instruction manual.

Breathing carbon monoxide can cause brain damage or death. Always read and understand instruction manual.

⚠ WARNING

Should you choose to apply an insulation blanket to this heater, you should follow these instructions (See Figure 1 for identification of components mentioned below). Failure to follow these instructions can restrict the air flow required for proper combustion, potentially resulting in fire, asphyxiation, serious personal injury or death.

- **Do not** apply insulation to the top of the water heater, as this will interfere with safe operation of the draft hood.
- **Do not** cover the outer door, thermostat or temperature & pressure relief valve.
- **Do not** allow insulation to come within 2" (50.8 mm) of the floor to prevent blockage of combustion air flow to the burner.
- **Do not** cover the instruction manual. Keep it on the side of the water heater or nearby for future reference.

- Do obtain new warning and instruction labels from Sears for placement on the blanket directly over the existing labels.
- Do inspect the insulation blanket frequently to make certain it does not sag, thereby obstructing combustion air flow.

Combustion Air and Ventilation for Appliances Located in Unconfined Spaces

UNCONFINED SPACE is space whose volume is not less than 50 cubic feet per 1,000 Btu per hour (4.8 m³ per kW) of the aggregate input rating of all appliances installed in that space. Rooms communicating directly with the space in which the appliances are installed, through openings not furnished with doors, are considered a part of the unconfined space.

In unconfined spaces in buildings, infiltration may be adequate to provide air for combustion, ventilation and dilution of flue gases. However, in buildings of tight construction (for example, weather stripping, heavily insulated, caulked, vapor barrier, etc.), additional air may need to be provided using the methods described in *Combustion Air and Ventilation for Appliances Located in Confined Spaces*.

Combustion Air and Ventilation for Appliances Located in Confined Spaces

CONFINED SPACE is a space whose volume is less than 50 cubic feet per 1,000 Btu per hour (4.8 m³ per kW) of the aggregate input rating of all appliances installed in that space.

A. ALL AIR FROM INSIDE BUILDINGS:

(See Figure 9 on page 11 and Figure 10 below)

The confined space shall be provided with two permanent openings communicating directly with an additional room(s) of sufficient volume so that the combined volume of all spaces meets the criteria for an unconfined space. The total input of all gas utilization equipment installed in the combined space shall be considered in making this determination. Each opening shall have a minimum free area of one square inch per 1,000 Btu per hour (22 cm²/kW) of the total input rating of all gas utilization equipment in the confined space, but not less than 100 square inches (645 cm²). One opening shall commence within 12 inches (30 cm) of the top and one commencing within 12 inches (30 cm) of the bottom of the enclosures.

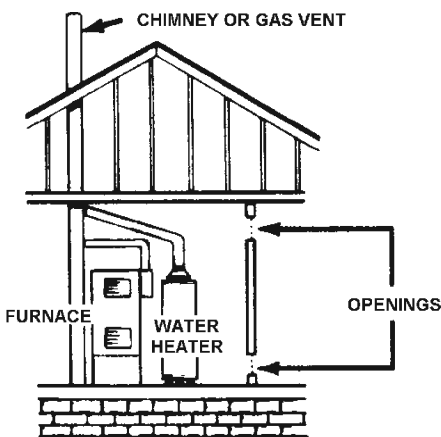

FIGURE 10.

B. ALL AIR FROM OUTDOORS: (See Figures 9, 11, 12, 13 and 13A)

The confined space shall be provided with two permanent openings, one commencing within 12 inches (30 cm) of the top and one commencing within 12 inches (30 cm) from the bottom of the enclosure. The openings shall communicate directly, or by ducts, with the outdoors or spaces (crawl or attic) that freely communicate with the outdoors.

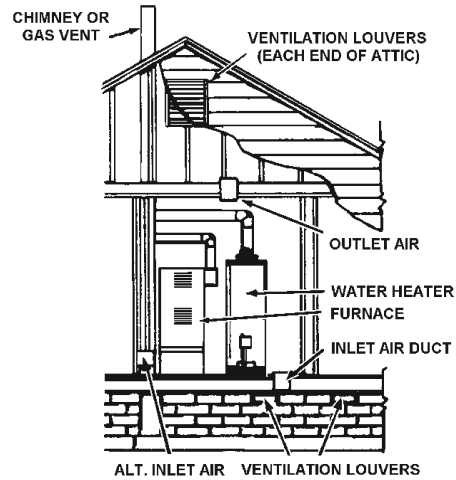

FIGURE 11.

- When directly communicating with the outdoors, each opening shall have a minimum free area of 1 square inch per 4,000 Btu per hour (5.5 cm²/kW) of total input rating of all equipment in the enclosure. See Figure 11.
- When communicating with the outdoors through vertical ducts, each opening shall have a minimum free area of 1 square inch per 4,000 BTU per hour (5.5 cm²/kW) of total input rating of all equipment in the enclosure. See Figure 12.

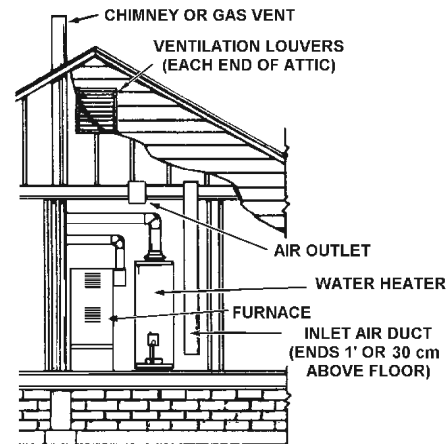

FIGURE 12.

- When communicating with the outdoors through horizontal ducts, each opening shall have a minimum free area of 1 square inch per 2,000 BTU per hour (11 cm²/kW) of total input rating of all equipment in the enclosure. See Figure 13.
- When ducts are used, they shall be of the same cross-sectional area as the free area of the openings to which they connect. The minimum short side dimension of rectangular air ducts shall not be less than 3 inches (7.6 cm). See Figure 13.

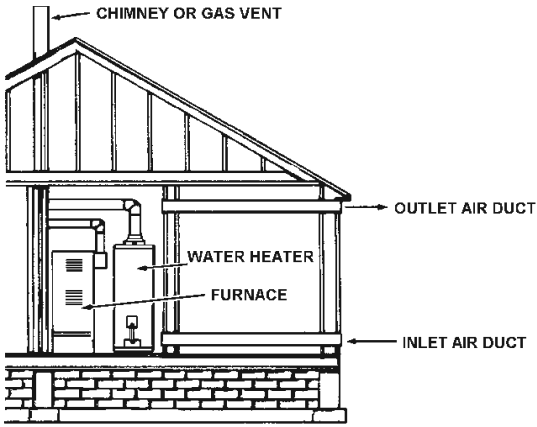

FIGURE 13.

- Alternatively, a single permanent opening may be used when communicating directly with the outdoors, or with spaces that freely communicate with the outdoors. The opening shall have a minimum free area of 1 square inch per 3,000 BTU per hour (7.3 cm²/kW) of total input rating of all equipment in the enclosure. See Figure 13A.

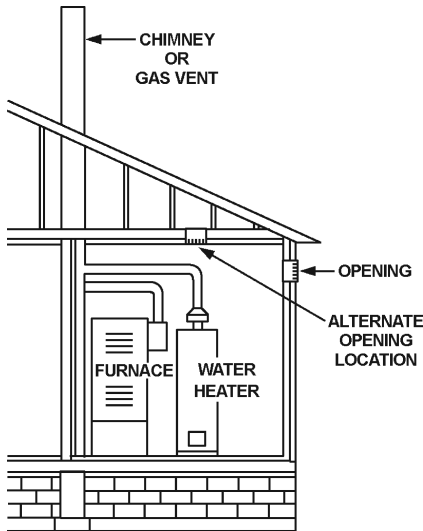

FIGURE 13A.

- Louvers and Grilles:** In calculating free area, consideration shall be given to the blocking effect of louvers, grilles or screens protecting openings. Screens used shall not be smaller than 1/4 inch (6.4 mm) mesh. If the free area through a design of louver or grille is known, it should be used in calculating the size opening required to provide the free area specified. If the design and free area is not known, it may be assumed that wood louvers will be 20-25 percent free area and metal louvers and grilles will have 60-75 percent free area. Louvers and grilles shall be fixed in the open position or interlocked with the equipment so that they are opened automatically during equipment operation.
- Special Conditions Created by Mechanical Exhausting or Fireplaces:** operation of exhaust fans, ventilation systems, clothes dryers or fireplaces may create conditions requiring special attention to avoid unsatisfactory operation of installed gas utilization equipment.

Water Piping

	<p>DANGER</p> <p>Water temperature over 125°F (52°C) can cause severe burns instantly resulting in severe injury or death.</p> <p>Children, elderly, and the physically or mentally disabled are at highest risk for scald injury.</p> <p>Feel water before bathing or showering.</p> <p>Temperature limiting valves are available.</p> <p>Read instruction manual for safe temperature setting.</p>

HOTTER WATER CAN SCALD:

Water heaters are intended to produce hot water. Water heated to a temperature which will satisfy space heating, clothes washing, dish washing, cleaning and other sanitizing needs can scald and permanently injure you upon contact. Some people are more likely to be permanently injured by hot water than others. These include the elderly, children, the infirm, or physically/mentally handicapped. If anyone using hot water in your home fits into one of these groups or if there is a local code or state law requiring a certain temperature water at the hot water tap, then you must take special precautions. In addition to using the lowest possible temperature setting that satisfies your hot water needs, a means such as a *mixing valve should be used at the hot water taps used by these people or at the water heater. Mixing valves are available at plumbing supply or hardware stores. See Figure 14. Valves for reducing point of use temperature by mixing cold and hot water are also available. Follow manufacturer's instructions for installation of the valves. Before changing the factory setting on the thermostat, read the *Temperature Regulation* section in this manual.

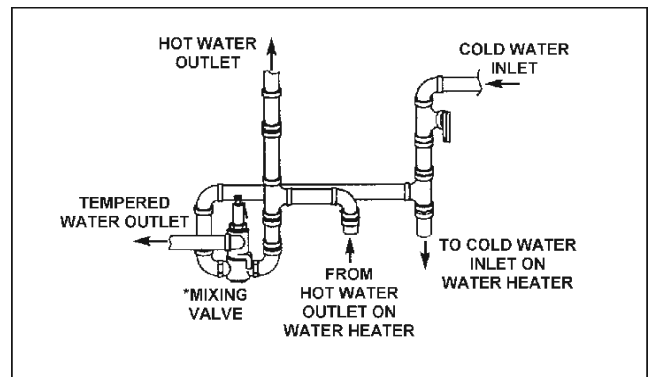

FIGURE 14.

<p>WARNING</p>
<p>Toxic Chemical Hazard</p>
<ul style="list-style-type: none"> Do not connect to non-potable water system.

This water heater shall not be connected to any heating systems or component(s) used with a non-potable water heating appliance.

Toxic chemicals, such as those used for boiler treatment, shall not be introduced into this system.

The water supply pressure should not exceed 80 psi. If this occurs, a pressure reducing valve with a bypass should be installed in the cold water inlet line. This should be placed on the supply to the entire house in order to maintain equal hot and cold water pressures.

In addition, the water within the water heater tank expands as it is heated, increasing the pressure of the water system. If the relieving point of the water heater's temperature-pressure relief valve is reached, the valve will relieve the excess pressure. **The temperature-pressure relief valve is not intended for the constant relief of thermal expansion.** This is an unacceptable condition and must be corrected. It is recommended that any devices installed which could create a closed system have a by-pass and/or the system have an expansion tank to relieve the pressure built by thermal expansion in the water system. Refer to the *Thermal Expansion* section under *Troubleshooting Guide* or contact local plumbing authority or local Sears Service Center on how to control this situation.

NOTE: To protect against untimely corrosion of hot and cold water fittings, it is strongly recommended that di-electric unions or couplings be installed on this water heater when connected to copper pipe.

INSTALLATION COMPLETED USING INSTALLATION KIT

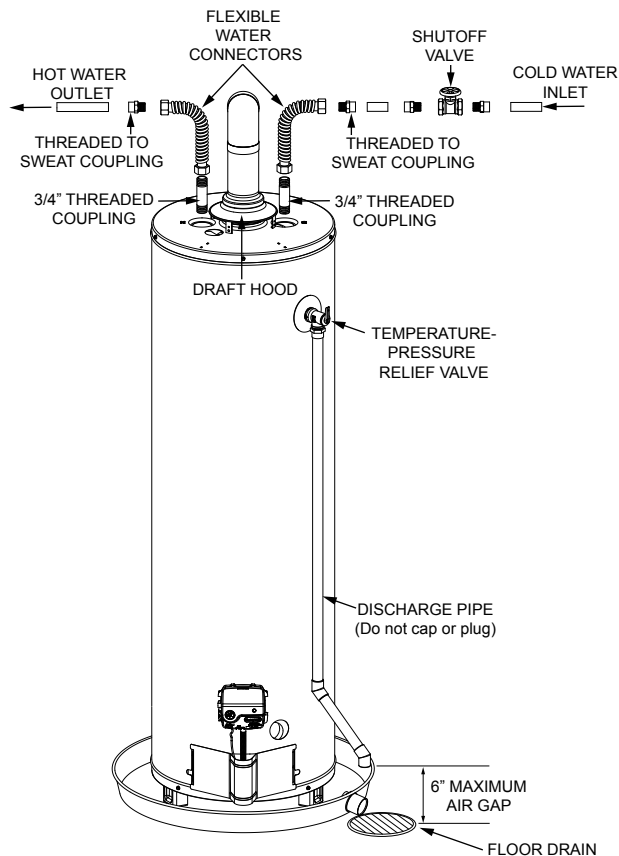

FIGURE 15.

<h1>CAUTION</h1>
Property Damage Hazard
<ul style="list-style-type: none"> • Avoid water heater damage. • Install thermal expansion tank if necessary. • Do not apply heat to cold water inlet. • Contact qualified installer or Sears Service Center.

Figure 15 shows the typical attachment of the water piping to the water heater. The water heater is equipped with 3/4" NPT water connections.

NOTE: If using copper tubing, solder tubing to an adapter before attaching the adapter to the cold water inlet connection. Do not solder the cold water supply line directly to the cold water inlet. It will harm the dip tube and damage the tank.

- Look at the top cover of the water heater. The water outlet is marked "HOT". Put two or three turns of Teflon tape around the threaded end of the threaded-to-sweat coupling and around both ends of the 3/4" NPT threaded nipple. Using flexible connectors, connect the hot water pipe to the hot water outlet on the water heater.
- Look at the top of the water heater. The cold water inlet is marked "COLD". Put two or three turns of Teflon tape around the threaded end of the threaded-to-sweat coupling and around both ends of the 3/4" NPT threaded nipple. Using flexible connectors, connect the cold water pipe to the cold water inlet of the water heater.

NOTE: This water heater is super insulated to minimize heat loss from the tank. Further reduction in heat loss can be accomplished by insulating the hot water lines from the water heater.

T & P Valve and Pipe Insulation

1. Locate the temperature and pressure relief valve on the water heater (also known as a T&P relief valve). See Figure 15A.
2. Locate the slit running the length of the T&P relief valve insulation.
3. Spread the slit open and fit the insulation over the T&P relief valve. See Figure 15A. Apply gentle pressure to the insulation to ensure that it is fully seated on the T&P Relief Valve. Once seated, secure the insulation with duct tape. **IMPORTANT:** The insulation or tape should not block or cover the T&P relief valve drain opening. Also, the insulation or tape should not block or hinder access to the manual relief lever (Figure 15A).
4. Locate the hot water (outlet) & cold water (inlet) pipes to the water heater.
5. Locate the slit running the length of a section of pipe insulation.
6. Spread the slit open and slip the insulation over the cold water (inlet) pipe. Apply gentle pressure along the length of the insulation to ensure that it is fully seated around the pipe. Also, ensure that the base of the insulation is flush with the water heater. Once seated, secure the insulation with duct tape.
7. Repeat steps 5 and 6 for the hot water (outlet) pipe.
8. Add additional sections of pipe insulation as needed.

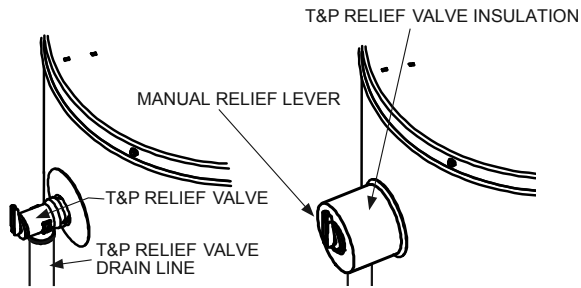

FIGURE 15A.

Temperature-Pressure Relief Valve

	<h1>! WARNING</h1>
	<h2>Explosion Hazard</h2>
	<ul style="list-style-type: none"> • Temperature-pressure relief valve must comply with ANSI Z21.22 and ASME code. • Properly sized temperature-pressure relief valve must be installed in opening provided. • Can result in overheating and excessive tank pressure. • Can cause serious injury or death.

This heater is provided with a properly certified combination temperature - pressure relief valve by the manufacturer.

The valve is certified by a nationally recognized testing laboratory that maintains periodic inspection of production of listed equipment as meeting the requirements for Relief Valves for Hot Water Supply Systems, ANSI Z21.22 and the code requirements of ASME.

If replaced, the valve must meet the requirements of local codes, but not less than a combination temperature and pressure relief valve certified as indicated in the above paragraph.

The valve must be marked with a maximum set pressure not to exceed the marked hydrostatic working pressure of the water heater (150 psi = 1,035kPa) and a discharge capacity not less than the water heater input rate as shown on the model rating plate.

For safe operation of the water heater, the relief valve must not be removed from its designated opening nor plugged.

The temperature-pressure relief valve must be installed directly into the fitting of the water heater designed for the relief valve. Position the valve downward and provide tubing so that any discharge will exit only within 6 inches (15.3 cm) above, or at any distance below the structural floor, see Figure 16. Be certain that no contact is made with any live electrical part. The discharge opening must not be blocked or reduced in size under any circumstances. Excessive length, over 30 feet (9.14 m), or use of more than four elbows can cause restriction and reduce the discharge capacity of the valve.

No valve or other obstruction is to be placed between the relief valve and the tank. Do not connect tubing directly to discharge drain unless a 6 inch air gap is provided. To prevent bodily injury, hazard to life, or property damage, the relief valve must be allowed to discharge water in quantities should circumstances

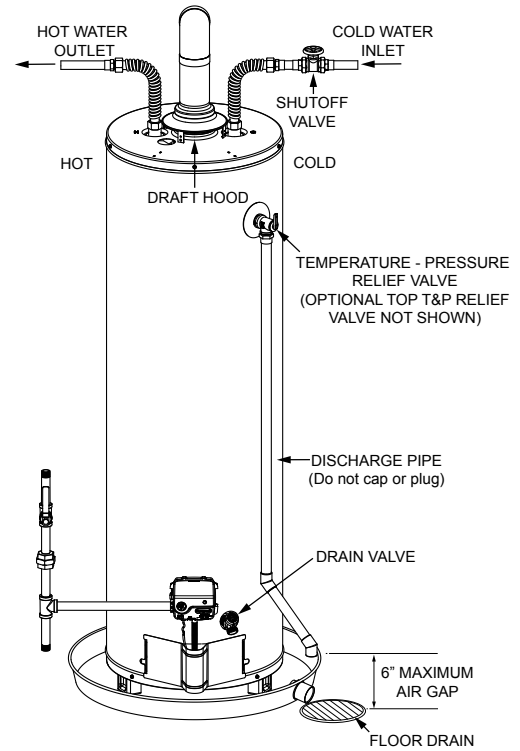

FIGURE 16.

<h1>CAUTION</h1>
<h2>Water Damage Hazard</h2>
<ul style="list-style-type: none"> • Temperature-pressure relief valve discharge pipe must terminate at adequate drain.

demand. If the discharge pipe is not connected to a drain or other suitable means, the water flow may cause property damage.

The Discharge Pipe:

- Shall not be smaller in size than the outlet pipe size of the valve, or have any reducing couplings or other restrictions.
- Shall not be plugged or blocked.
- Shall be of material listed for hot water distribution.
- Shall be installed so as to allow complete drainage of both the temperature-pressure relief valve, and the discharge pipe.
- Shall terminate a maximum of six inches above a floor drain or external to the building. In cold climates, it is recommended that the discharge pipe be terminated at an adequate drain inside the building.
- Shall terminate at an adequate drain.
- Shall not have any valve between the relief valve and tank.

<h1>! DANGER</h1>	<p>Water temperature over 125°F (52°C) can cause severe burns instantly resulting in severe injury or death.</p> <p>Children, the elderly, and the physically or mentally disabled are at highest risk for scald injury.</p> <p>Feel water before bathing or showering.</p> <p>Temperature limiting valves are available.</p> <p>Read instruction manual for safe temperature setting.</p>

The temperature-pressure relief valve must be manually operated at least once a year. Caution should be taken to ensure that (1) no one is in front of or around the outlet of the temperature-pressure relief valve discharge line, and (2) the water manually discharged will not cause any bodily injury or property damage because the water may be extremely hot.

If after manually operating the valve, it fails to completely reset and continues to release water, immediately close the cold water inlet to the water heater, follow the draining instructions, and replace the temperature-pressure relief valve with a new one.

CAUTION
Property Damage Hazard
<ul style="list-style-type: none">• Avoid water heater damage.• Fill tank with water before operating.

Filling the Water Heater

Never use this water heater unless it is completely full of water. To prevent damage to the tank, the tank must be filled with water. Water must flow from the hot water faucet before turning "ON" gas to the water heater.

To fill the water heater with water:

- Close the water heater drain valve by inserting a flat head screwdriver in the slot on the stem and turn to the right (clockwise). The drain valve is on the lower front of the water heater.
- Open the cold water supply valve to the water heater. **NOTE: The cold water supply valve must be left open when the water heater is in use.**
- To ensure complete filling of the tank, allow air to exit by opening the nearest hot water faucet. Allow water to run until a constant flow is obtained. This will let air out of the water heater and the piping.
- Check all water piping and connections for leaks. Repair as needed.

Venting

VENT DAMPERS - Any vent damper, whether it is operated thermally or otherwise must be removed if its use inhibits proper drafting of the water heater.

Thermally Operated Vent Dampers: Gas-fired water heaters having thermal efficiency in excess of 80% may produce a relatively low flue gas temperature. Such temperatures may not be high enough to properly open thermally operated vent dampers. This would cause spillage of the flue gases and may cause carbon monoxide poisoning.

Vent dampers must bear evidence of certification as complying with the current edition of the American National Standard ANSI Z21.68 (ANSI Z21.66 & 67, respectively, cover electrically and mechanically actuated vent dampers). Before installation

of any vent damper, consult your local Sears Service Center or the local gas supplier for further information.

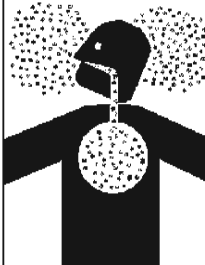
! WARNING	
Breathing Hazard - Carbon Monoxide Gas	
	<ul style="list-style-type: none">• Vent dampers must be certified in accordance with ANSI Z21.68.• Vent damper must permit proper drafting of water heater.• Install properly sized venting.• Do not install without venting outdoors.• Do not install without drafthood.• If common vented install in accordance with NFPA 54.• Be alert for obstructed or deteriorated vent system to avoid serious injury or death.
Breathing carbon monoxide can cause brain damage or death. Always read and understand instruction manual.	

To ensure proper venting of this gas-fired water heater, the correct vent pipe diameter must be utilized. Any additions or deletions of other gas appliances on a common vent with this water heater may adversely affect the operation of the water heater. Consult your gas supplier if any such changes are planned. For replacement heater installations where pre-existing venting is used, the venting must be inspected for obstructions and if deterioration is present, it must be replaced.

IMPORTANT: Do not common vent this water heater with any power vented appliance.

For proper venting in certain installations, a larger diameter vent pipe may be necessary. Consult your local Sears Service Center or gas supplier to aid you in determining the proper venting for your water heater from the vent tables in the current edition of the National Fuel Gas Code ANSI Z223.1/NFPA 54.

Periodically check the venting system for signs of obstruction or deterioration and replace if needed.

The combustion and ventilation air flow must not be obstructed.

The water heater with draft hood installed must be connected to a chimney or listed vent pipe system, which terminates to the outdoors. Never operate the water heater unless it is vented to the outdoors and has adequate air supply to avoid risks of improper operation, explosion or asphyxiation.

- For proper draft hood attachment, the draft hood legs may be angled slightly inward.
- Place the draft hood legs in the receiving holes on the top of the water heater. The legs will snap in the holes to give a tight fit. Secure the legs to top with sheet metal screws. See Figure 17.
- Place the vent pipe over the draft hood. With the vent pipe in position, drill a small hole through both the vent pipe and draft hood. Secure them together with a sheet metal screw.

Obstructed or deteriorated vent systems may present serious health risk or asphyxiation.

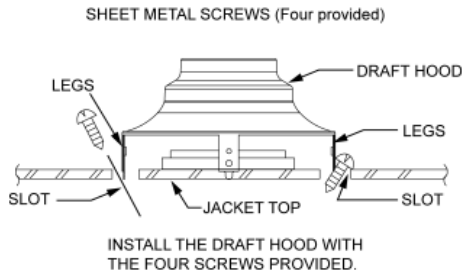

FIGURE 17.

The vent pipe from the water heater must be no less than the diameter of the draft hood outlet on the water heater and must slope upward at least 1/4 inch per linear foot (21 mm per meter). See Figure 18.

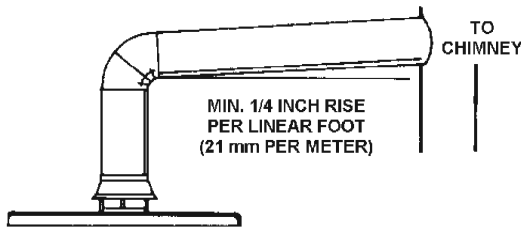

FIGURE 18.

All vent gases must be completely vented to the outdoors of the structure (dwelling). Install only the draft hood provided with the new water heater and no other draft hood.

Vent pipes must be secured at each joint with sheet metal screws.

There must be a minimum of 6 inches (153 mm) clearance between single wall vent pipe and any combustible surface. Fill and seal any clearance between single wall vent pipe and combustible surfaces with mortar mix, cement, or other noncombustible substance. For other than single wall, follow vent pipe manufacturer's clearance specifications. To ensure a tight fit of the vent pipe in a brick chimney, seal around the vent pipe with mortar mix cement.

⚠ WARNING	
Breathing Hazard - Carbon Monoxide Gas	
	<ul style="list-style-type: none"> • Flue gases may escape if vent pipe is not connected. • Do not store corrosive chemicals in vicinity of water heater. • Chemical corrosion of flue and vent system can cause serious injury or death. • Contact a qualified installer or service agency.
Breathing carbon monoxide can cause brain damage or death. Always read and understand instruction manual.	

Failure to have required clearances between vent piping and combustible surfaces will result in a fire hazard.

Be sure vent pipe is properly connected to prevent escape of dangerous flue gases which could cause deadly asphyxiation.

Chemical vapor corrosion of the flue and vent system may occur if air for combustion contains certain chemical vapors. Spray can propellants, cleaning solvents, refrigerator and air conditioner refrigerants, swimming pool chemicals, calcium and sodium chloride, waxes, bleach and process chemicals are typical compounds which are potentially corrosive.

Gas Piping

	⚠ WARNING
	Fire and Explosion Hazard
	<ul style="list-style-type: none"> • Do not use water heater with any gas other than the gas shown on the rating plate. • Excessive pressure to gas control valve can cause serious injury or death. • Turn off gas lines during installation. • Contact qualified installer or service agency.

Make sure the gas supplied is the same type listed on the model rating plate. The inlet gas pressure must not exceed 14 inch water column (3.5kPa) for natural and propane gas (L.P.) gas. The minimum inlet gas pressure listed on the rating plate is for the purpose of input adjustment. If the gas control valve is subjected to pressures exceeding 1/2 pound per square inch (3.5kPa), the damage to the gas control valve could result in a fire or explosion from leaking gas.

If the main gas line shutoff serving all gas appliances is used, also turn "OFF" the gas at each appliance. Leave all gas appliances shut "OFF" until the water heater installation is complete.

A gas line of sufficient size must be run to the water heater. Consult the current edition of National Fuel Gas Code ANSI Z223.1/NFPA 54 and your gas supplier concerning pipe size.

There must be:

- A readily accessible manual shut off valve in the gas supply line serving the water heater.
- A drip leg (sediment trap) ahead of the gas control valve to help prevent dirt and foreign materials from entering the gas control valve.
- A flexible gas connector or a ground joint union between the shut off valve and control valve to permit servicing of the unit.

Be sure to check all the gas piping for leaks before lighting the water heater. Use a soapy water solution, not a match or open flame. Rinse off soapy solution and wipe dry.

The minimum inlet gas pressure shown on the rating plate is that which will permit firing at the rated input.

⚠ WARNING	
Breathing Hazard - Carbon Monoxide Gas	
	<ul style="list-style-type: none"> • High altitude orifice must be installed for operation above 2,000 feet (610 m). • Contact a qualified installer or service agency.
<p>Breathing carbon monoxide can cause brain damage or death. Always read and understand instruction manual.</p>	

Water heaters covered in this manual have been tested and approved for installation at elevations up to 2,000 feet (610 m) above sea level. For installation above 2,000 feet (610 m), the water heater's Btu input should be reduced at the rate of 4 percent for each 1,000 feet (305 m) above sea level which requires replacement of the burner orifice in accordance with the National Fuel Gas Code ANSI Z223.1/NFPA 54. Contact your local gas supplier for further information.

Failure to replace the standard orifice with the proper high altitude orifice when installed at elevations above 2,000 feet (610 m) could result in improper and inefficient operation of the appliance, producing carbon monoxide gas in excess of the safe limits. This could result in serious injury or death. Contact your local gas supplier for any specific changes that may be required in your area.

⚠ WARNING	
Fire and Explosion Hazard	
	<ul style="list-style-type: none"> • Use joint compound or tape compatible with propane. • Leak test before operating heater. • Disconnect gas piping and shut-off valve before pressure testing system.

Use pipe joint compound or Teflon tape marked as being resistant to the action of petroleum (Propane [L.P.]) gases.

The appliance and its gas connection must be leak tested before placing the appliance in operation.

The appliance and its individual shutoff valve shall be disconnected from the gas supply piping system during any pressure testing of that system at test pressures in excess of 1/2 pound per square inch (3.5 kPa). It shall be isolated from the gas supply piping system by closing its individual manual shutoff valve during any pressure testing of the gas supply piping system at test pressures equal to or less than 1/2 pound per square inch (3.5 kPa).

Connecting the gas piping to the gas control valve of the water heater can be accomplished by either of the two methods shown in Figures 19 and 20.

TEFLON[®] is a registered trademark of E.I. Du Pont De Nemours and Company.

Sediment Traps

⚠ WARNING	
Fire and Explosion Hazard	
	<ul style="list-style-type: none"> • Contaminants in gas lines can cause fire or explosion. • Clean all gas piping before installation. • Install drip leg in accordance with NFPA 54.

Contaminants in the gas lines may cause improper operation of the gas control valve that may result in fire or explosion. Before attaching the gas line be sure that all gas pipe is clean on the inside. To trap any dirt or foreign material in the gas supply line, a drip leg (sometimes called a sediment trap) must be incorporated in the piping. The drip leg must be readily accessible. Install in accordance with the *Gas Piping* section. Refer to the current edition of the National Fuel Gas Code, ANSI Z223.1/NFPA 54.

A sediment trap shall be installed as close to the inlet of the water heater as practical at the time of water heater installation. The sediment trap shall be either a tee fitting with a capped nipple in the bottom outlet or other device recognized as an effective sediment trap. If a tee fitting is used, it shall be installed in conformance with one of the methods of installation, shown in Figures 19 and 20.

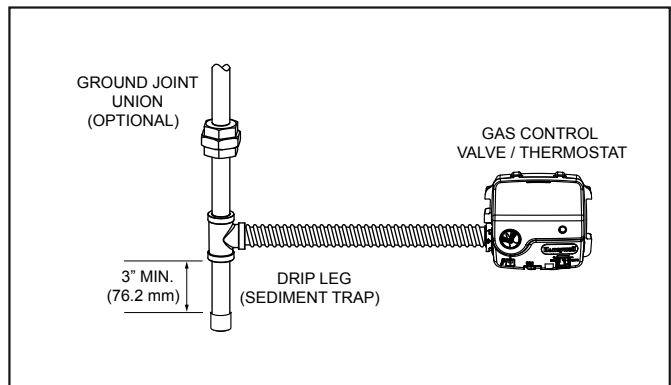

FIGURE 19. GAS PIPING WITH FLEXIBLE CONNECTOR.

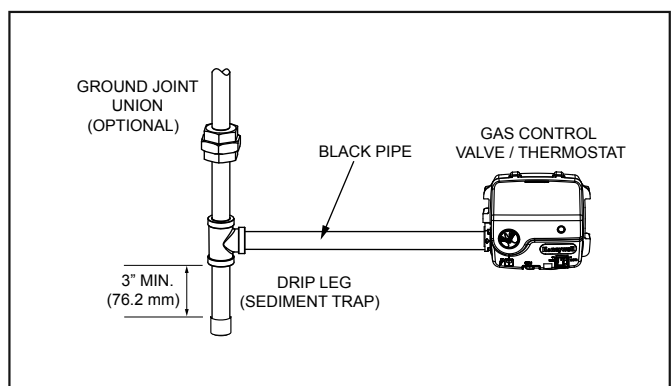

FIGURE 20. GAS PIPING WITH ALL BLACK IRON PIPE TO GAS CONTROL.



OPERATING INSTRUCTIONS

FOR YOUR SAFETY READ BEFORE LIGHTING

WARNING: If you do not follow these instructions exactly, a fire or explosion may result causing property damage, personal injury or loss of life.

- A. This appliance has a pilot which is lighted by a piezoelectric igniter. When lighting the pilot, follow these instructions exactly.
- B. **BEFORE LIGHTING** smell all around the appliance area for gas. Be sure to smell next to the floor because some gas is heavier than air and will settle on the floor.
WHAT TO DO IF YOU SMELL GAS:
 - Do not try to light any appliance.
 - Do not touch any electrical switch; do not use any phone in your building.
 - Immediately call your gas supplier from a neighbor's phone. Follow the gas supplier's instructions.
 - If you cannot reach your gas supplier, call the fire department.
- C. Use only your hand to push in or turn the gas control temperature knob. Never use tools. If the knob will not push in or move by hand, don't try to repair it, call a qualified service technician. Force or attempted repair may result in a fire or explosion.
- D. Do not use this appliance if any part has been under water. Immediately call a qualified service technician to inspect the appliance. Water heaters subjected to flood conditions or anytime the gas controls, main burner or pilot have been submerged in water require replacement of the entire water heater.
- E. **DO NOT USE THIS APPLIANCE IF THERE HAS BEEN AN IGNITION OF VAPORS.** Immediately call a qualified service technician to inspect the appliance. Water heaters subjected to a flammable vapors ignition will show a discoloration on the air intake grid (bottom of combustion chamber) and require replacement of the entire water heater.

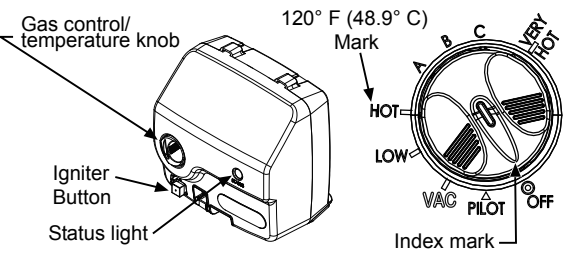
LIGHTING INSTRUCTIONS

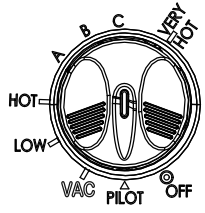
1. **STOP!** It is imperative that you read all safety warnings before lighting the pilot.
2. Turn the gas control/temperature knob counterclockwise  to the "OFF" setting.

3. Wait ten (10) minutes to clear out any gas. If you then smell gas, **STOP!** Follow "B" in the safety information above on this label. If you do not smell gas, go to the next step.
4. Turn the gas control/temperature knob clockwise  to "PILOT".

5. Press the gas control/temperature knob all the way in and hold it in. The knob should travel in about 1/4 inch (6.35 mm) if it is set to "PILOT" correctly.
While holding the gas control/temperature knob in, click the igniter button continuously (about once a second) for up to 90 seconds or until Status Light begins to blink.
6. When the status light starts blinking, release the gas control/temperature knob. Set the gas control/temperature knob to the desired setting.

If the status light does not start blinking within 90 seconds, repeat steps 2 through 5 up to THREE (3) times, waiting 10 minutes between lighting attempts.

The circuitry in this advanced gas valve requires that you wait 10 minutes between lighting attempts.

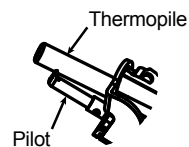
If the status light turns solid red, release the gas control/temperature knob and repeat steps 2 through 5 (waiting 10 minutes before attempting to relight the pilot).

If the status light does not start blinking after three lighting attempts, turn the gas control/temperature knob to "OFF" and call a qualified service technician or your gas supplier.



TO TURN OFF GAS TO APPLIANCE

1. Turn the gas control/temperature knob counterclockwise  to the "OFF" setting. The status light will stop blinking and stay on for a short time after the water heater is turned off.

Temperature Regulation

The thermostat is adjusted to the pilot position when it is shipped from the factory. Water temperature can be regulated by moving the temperature dial to the preferred setting. The preferred starting point is 120°F at the “HOT” setting. Align the knob with the desired water temperature as shown in Figure 22. There is a hot water scald potential if the thermostat is set too high. **NOTE:** Temperatures shown on the gas control valve/thermostat are approximates. The actual temperature of the heated water may vary.

Due to the nature of the typical gas water heater, the water temperature in certain situations may vary up to 30F° (16.7 C°) higher or lower at the point of use such as, bathtubs, showers, sink, etc.

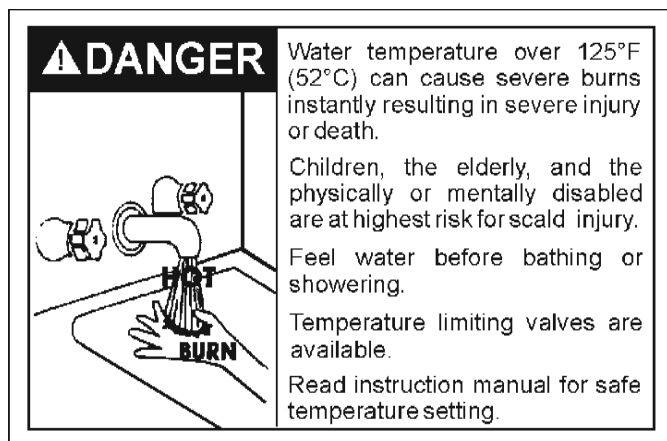

HOTTER WATER CAN SCALD: Water heaters are intended to produce hot water. Water heated to a temperature which will satisfy space heating, clothes washing, dish washing, and other sanitizing needs can scald and permanently injure you upon contact. Some people are more likely to be permanently injured by hot water than others. These include the elderly, children, the infirm, or physically/mentally handicapped. If anyone using hot water in your home fits into one of these groups or if there is a local code or state law requiring a certain temperature water at the hot water tap, then you must take special precautions. In addition to using the lowest possible temperature setting that satisfies your hot water needs, a means such as a mixing valve should be used at the hot water taps used by these people or at the water heater. Mixing valves are available at plumbing supply or hardware stores. Follow manufacturer’s instructions for installation of the valves. Before changing the factory setting on the thermostat, see Figures 21 and 22.

Never allow small children to use a hot water tap, or to draw their own bath water. Never leave a child or handicapped person unattended in a bathtub or shower.

NOTE: A water temperature range of 120°F-140°F (49°C-60°C) is recommended by most dishwasher manufacturers.

IMPORTANT: Adjusting the thermostat past the 120°F bar on the temperature dial will increase the risk of scald injury. Hot water can produce first degree burns within:

Water Temperature °F	Time for 1st Degree Burn (Less Severe Burns)	Time for Permanent Burns 2nd & 3rd Degree (Most Severe Burns)
110	(normal shower temp.)	
116	(pain threshold)	
116	35 minutes	45 minutes
122	1 minute	5 minutes
131	5 seconds	25 seconds
140	2 seconds	5 seconds
149	1 second	2 seconds
154	instantaneous	1 second

(U.S. Government Memorandum, C.P.S.C., Peter L. Armstrong, Sept. 15, 1978)

FIGURE 21.

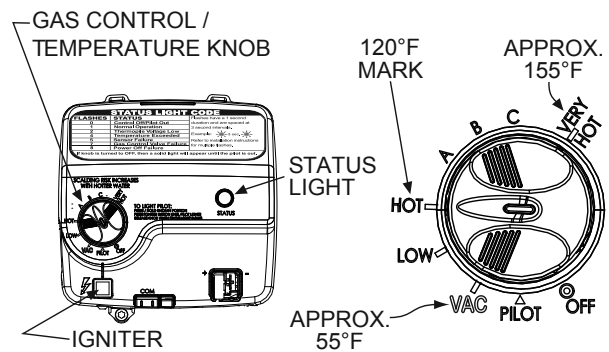

FIGURE 22.

NOTE: During low demand periods when hot water is not being used, a lower thermostat setting will reduce energy losses and may satisfy your normal hot water needs. If hot water use is expected to be more than normal, a higher thermostat setting may be required to meet the increased demand. When leaving your home for extended periods (vacations, etc.), turn the temperature dial to the vacation (VAC) setting. This will maintain the water at low temperatures with minimum energy losses and prevent the tank from freezing during cold weather.

Operating the Temperature Control System

Water Temperature Adjustment

The water temperature setting can be adjusted from 55°F to 155°F. Turn the Gas Control/Temperature Knob to the desired setting/temperature. See Figure 22 on page 20.

NOTE: The temperatures indicated are approximates. The actual temperature of the heated water may vary.

Operating Modes and Settings

- **Standard Mode** - The controller adjusts the water heater to maintain the temperature set by the user.
- **Vacation Setting** - The Vacation Setting (VAC) sets the controller at approximately 55°F. This setting is recommended when the water heater is not in use for a long period of time. This effectively turns the controller temperature setting down to a temperature that prevents the water in the water heater from freezing while still conserving energy.

Status Light Codes

Normal Flashes:

- 0 Flashes Indicates Control Off/Pilot Out.
- 1 Flash Indicates Normal Operation.
- Continuous Light indicates the gas control valve/thermostat is shutting down.

Diagnostic Flashes: If the water heater is not working, look for the following diagnostic flashes after lighting the pilot.

- 2 Flashes Indicates thermopile voltage is low.
- 4 Flashes Indicates overheat failure.
- 5 Flashes Indicates water temperature sensor failure.
- 7 Flashes Indicates electronic control failure.
- 8 Flashes See "Status Light Code Troubleshooting Chart."
- 9 Flashes Indicates chamber temperature sensor circuit is open or shorted.
- 10 Flashes Indicates an LDO occurrence was detected in the combustion chamber (contaminants).

LIST OF STATUS CODES ARE SHOWN AT TOP OF GAS CONTROL VALVE / THERMOSTAT.

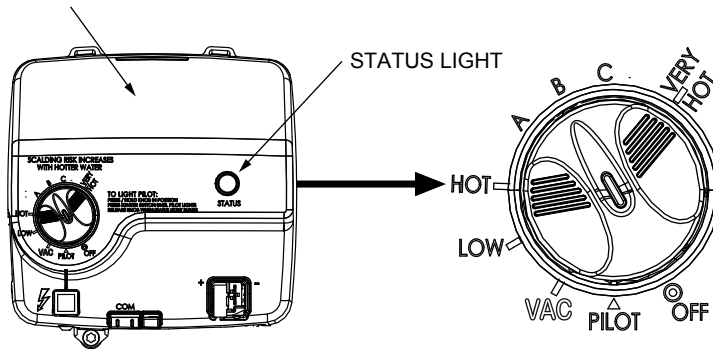



FIGURE 22B.

SERVICE AND ADJUSTMENT

Vent System Inspection

! WARNING	
Carbon Monoxide and Fire Hazard	
	<ul style="list-style-type: none">• Flue gases may escape if vent pipe is not connected.• Be alert for obstructed, sooted or deteriorated vent system to avoid serious injury or death.• Do not store corrosive chemicals in the vicinity of water heater.• Chemical corrosion of flue and vent system can cause serious injury or death.
Breathing carbon monoxide can cause brain damage or death. Always read and understand instruction manual.	

At least once a year, a visual inspection should be made of the venting system. You should look for:

- Obstructions which could cause improper venting. The combustion and ventilation air flow must not be obstructed.
- Damage or deterioration which could cause improper venting or leakage of combustion products.
- Rusted flakes around top of water heater.

Be sure the vent piping is properly connected to prevent escape of dangerous flue gasses which could cause deadly asphyxiation.

Obstructions and deteriorated vent systems may present serious health risk or asphyxiation.

Chemical vapor corrosion of the flue and vent system may occur if air for combustion contains certain chemical vapors. Spray can propellants, cleaning solvents, refrigerator and air conditioner refrigerants, swimming pool chemicals, calcium and sodium chloride, waxes, bleach and process chemicals are typical compounds which are potentially corrosive.

If when inspecting the vent system you find sooting or deterioration, something is wrong. Call the local gas supplier to correct the problem and clean or replace the flue and venting before resuming operation of the water heater.

Burner Inspection

Flood damage to a water heater may not be readily visible or immediately detectable. However, over a period of time a flooded water heater will create dangerous conditions which can cause DEATH, SERIOUS BODILY INJURY, OR PROPERTY DAMAGE. Contact a Sears Service Center to replace a flooded water heater. Do not attempt to repair the unit! It must be replaced!

At least once a year, a visual inspection should be made of the main burner. See Figure 23.

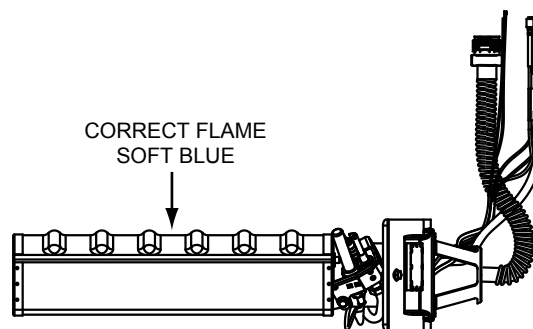

FIGURE 23.

Inspect burner flames through viewport. Flames should be very small with a blue haze and small amounts of yellow or orange at the edges. After several minutes of operation, the burner screen may glow red. If large flames are observed at any time, shut-off the unit and contact the Sears Service Center.

Removing the Burner Door Assembly

1. Turn off the gas to the water heater at the manual shut-off valve (Figure 2).
2. Turn the gas control/temperature knob to the "OFF" position (Figure 22).
3. Remove the outer door.
4. Remove the two screws (1/4" nut driver) securing the burner door assembly to the combustion chamber (Figure 24).
5. Disconnect the pilot tube (7/16" wrench), the igniter wire from the igniter lead wire, and manifold tube (3/4" wrench) at the gas control valve/thermostat. Disconnect the sensor wires (lift white lever outward, then gently pull the plug downward). Also, use needle nose pliers to disconnect the red (+) and white (-) thermopile wires from the gas control valve/thermostat. See Figures 24 & 25.

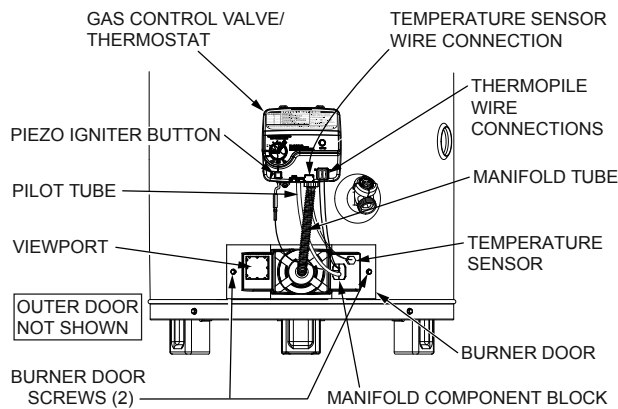

FIGURE 24.

6. Grasp the manifold tube and push down slightly to free the manifold, pilot tube, and thermopile.
7. Carefully remove the burner door assembly from the burner compartment.

NOTE: Be sure not to damage internal parts.

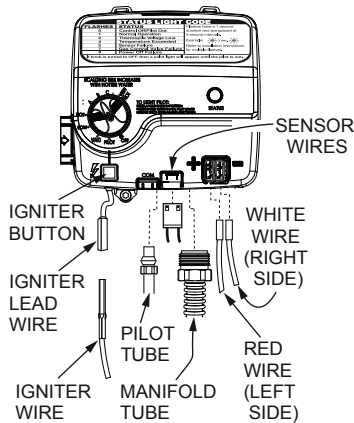

FIGURE 25.

Ultra Low NOx Natural Gas Burner

Check the burner to see if it is dirty or clogged. The burner may be cleaned with soft paint brush (Figure 26). Do not use a wire brush or any tool that may damage the burner screen. Important: Do not use the burner if the burner screen is damaged. NOTE: Damage may be rips or holes in the burner screen. Discoloration is normal.

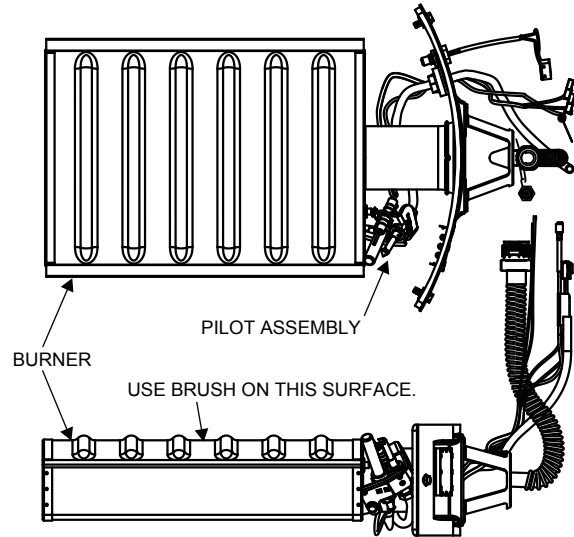

FIGURE 26.

Replacing the Pilot/Thermopile Assembly

1. Remove the burner assembly as directed previously.
2. Lift the retainer clip straight up from the back of the manifold component block (using a flat-blade screwdriver), then remove the manifold component block from the burner door assembly (Figure 27).

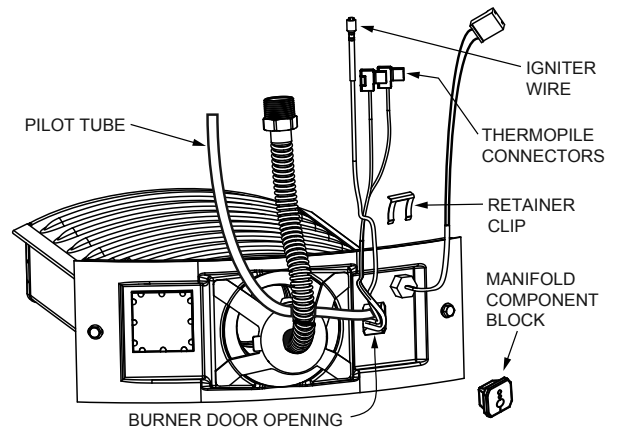

FIGURE 27.

3. Locate and remove the phillips screw attaching the pilot to the pilot bracket, then pull the pilot/thermopile assembly (including the igniter wire) out of the burner door assembly.
4. Using a 7/16" wrench, loosen the nut securing the pilot tube to the pilot assembly (right-hand threads).
5. Pull the pilot tube from the pilot assembly (Figure 28). IMPORTANT: Be careful not to bend or alter the position of the pilot assembly components.

- Using the old pilot tube as a guide, bend the new pilot tube to match the old one. Make only the bends closest to the pilot before going to the next step.

NOTE: Skip this step if you are reusing the existing pilot tube.

- Reconnect the pilot tube and tighten the nut securing it to the new pilot assembly. To prevent any bending of the pilot bracket, use pliers to hold the pilot assembly bracket while tightening the pilot nut. **IMPORTANT:** Keep the pilot orifice in the pilot when making the connection. **DO NOT** operate the water heater without the pilot orifice installed.

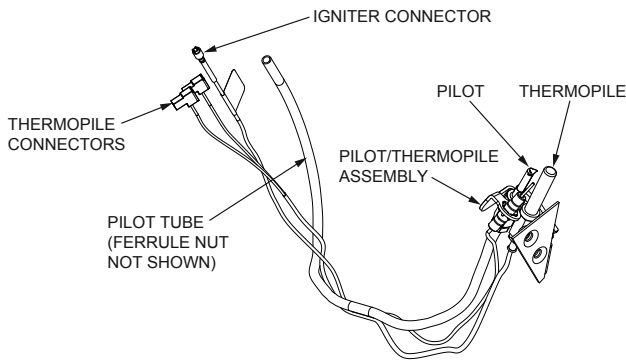

FIGURE 28.

- Push the new pilot assembly connectors through the opening in the burner door (See Figure 27).
- Attach the pilot assembly to the Burner Door Assembly.
- Position the new thermopile wires through the top opening of the manifold component block (Figure 27). Be sure that the igniter wire is positioned through the middle opening of the manifold component block. Position the pilot tube through the bottom opening of the manifold component block.
- See "Replacing the Burner Door Assembly."

External Inspection & Cleaning of the Flame Trap

Although not likely to occur, if debris collects on the flame trap (flame arrester), use a vacuum, compressed air, or a soft bristle brush to remove it. NOTE: If unable to inspect or clean the flame trap from underneath, follow the "Cleaning the Combustion Chamber and Flame Trap" section instructions.

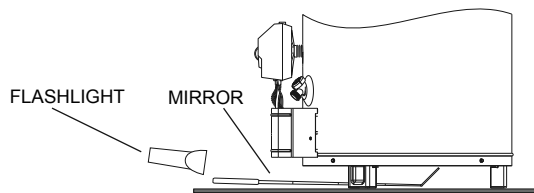

FIGURE 29

Cleaning the Combustion Chamber and Flame Trap

- Follow the procedure outlined in "Removing the Burner Door Assembly" section.
- Use a vacuum cleaner/shop vac to remove all loose debris in the combustion chamber (Figure 30). Use compressed air to clear any dust or debris that may have accumulated in the flame trap (flame arrester).
- Reassemble following the procedure under the "Replacing the Burner Door Assembly" section.

Replacing the Burner Door Assembly

⚠ WARNING

Fire or Explosion Hazard

- Tighten both manifold door screws securely.
- Remove any fiberglass between gasket and combustion chamber.
- Replace viewport if glass is missing or damaged.
- Replace manifold component block if missing or removed.
- Replace door gasket if damaged.
- Failure to follow these instructions can result in death, explosion, or fire.



Read instruction manual before installing, using or servicing water heater.



1. Check the door gasket for damage or imbedded debris prior to installation.



2. Inspect the viewport for damage and replace as required.
3. Insert the burner assembly into the burner compartment, making sure that the burner assembly sits firmly against the burner bracket inside the combustion chamber (Figure 30).
4. Inspect the door gasket and make sure there is no fiberglass insulation between the gasket and the combustion chamber.
5. Replace the two screws which secure the burner assembly to the combustion chamber and tighten securely. There should be no space between the gasket part of the burner door and combustion chamber. **IMPORTANT:** Do not operate the water heater if the door gasket does not create a seal between the burner door and the combustion chamber.
6. Reconnect the manifold tubing (3/4" wrench), pilot tubing (7/16" wrench), temperature sensor wires, and thermopile wires to the gas control valve/thermostat. (See Figure 25 for the correct position of the thermopile wires.) Do not cross-thread or apply any thread sealant to the fittings.
7. Reconnect the igniter wire.
8. Turn the gas supply on and refer to "Lighting Instructions" in the "Operating Instructions" section.
9. Check for leaks by brushing on an approved noncorrosive leak detection solution. Bubbles forming indicate a leak. Correct any leak found. **IMPORTANT:** All leaks must be fixed immediately.
10. Replace the outer door.

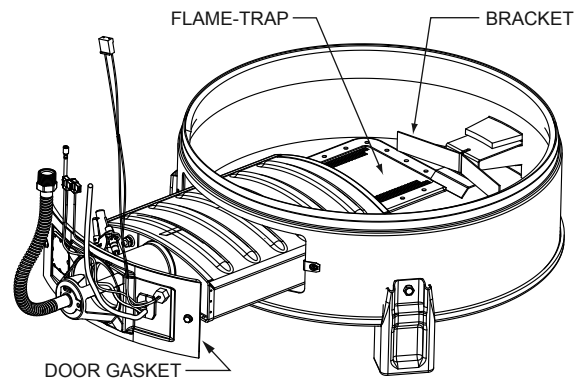

FIGURE 30.

Piezoelectric Igniter System

The piezoelectric igniter system consists of the igniter button, electrode, and wire. The pilot is ignited by an electric spark generated when the igniter button is pressed. (See Figure 31.) Use only factory authorized piezoelectric igniter parts for replacement.

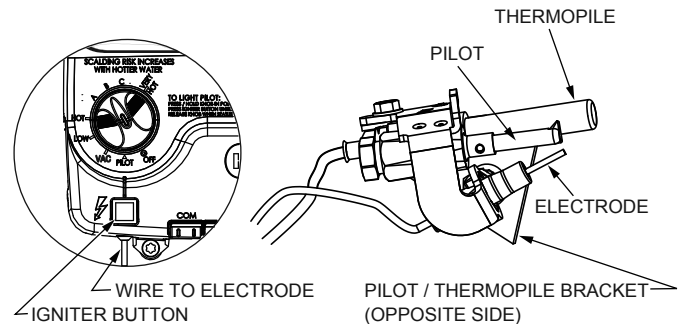

FIGURE 31.

Testing the Igniter System

Turn off the gas to the water heater at the manual gas shut-off valve. Watch the electrode tip while activating the igniter. A visible spark should jump from the electrode. To avoid shock, do not touch the burner or any metal part on the pilot or pilot assembly. If no spark is visible, check the wire connections and make sure the electrode is not broken. Replace the electrode if defective. **NOTE:** The electrode is part of the pilot assembly and cannot be replaced separately. Dirt and rust on the pilot or electrode tip can prevent the igniter spark. Wipe clean with a damp cloth and dry completely. Rust can be removed from the electrode tip and metal surfaces by lightly sanding with an emery cloth or fine grit sandpaper.

Removing and Replacing the Gas Control Valve/Thermostat

Removing the Gas Control Valve/Thermostat:

1. Turn the gas control/temperature knob to the "OFF" position (Figure 22).
2. Turn off the gas at the manual shut-off valve on the gas supply pipe (Figure 2).
3. Drain the water heater. Refer to the section on "Draining and Flushing" and follow the procedure.
4. Disconnect the igniter wire from the igniter lead wire. Disconnect the temperature sensor wire, then use needle nose pliers to disconnect the red (+) and white (-) thermopile wires. Disconnect the pilot tube (7/16" wrench) and manifold tube (3/4" wrench) at the gas control valve/thermostat (Figure 25).
5. Refer to "Gas Piping" (Figure 2) and disconnect the ground joint union in the gas piping. Disconnect the remaining pipe from the gas control valve/thermostat.
6. To remove the gas control valve/thermostat, thread a 4-inch section of gas pipe into the inlet and use it to turn the gas control valve/thermostat (counterclockwise.) Do not use a pipe wrench or equivalent to grip body. Damage may result. Do not insert any sharp objects into the inlet or outlet connections. Damage to the gas control valve/thermostat may result.

Replacing the Gas Control Valve/Thermostat:

To replace the gas control valve/thermostat, reassemble in reverse order. When replacing the gas control valve/thermostat, thread a 4-inch section of gas pipe into the inlet and use it to turn the gas control valve/thermostat (clockwise.) DO NOT OVER TIGHTEN. Damage may result.

- Be sure to use approved Teflon® tape or pipe joint compound on the gas piping connections and fitting on the back of the gas control valve that screws into tank.
- Be sure to remove the pilot ferrule nut from the new gas control valve/thermostat.
- Turn the gas supply on and check for leaks. Test the water heater by brushing on an approved noncorrosive leak detection solution. Bubbles forming indicate a leak. Correct any leak found.
- Be sure tank is completely filled with water before lighting and activating the water heater. Follow the "Lighting Instructions" in the "Operating Instructions" section.
- If additional information is required, contact Sears Service at: 1-800-4-MY-HOME® (1-800-469-4663).

TEFLON® is a registered trademark of E.I. Du Pont De Nemours and Company.

Housekeeping

Vacuum around base of water heater for dust, dirt, and lint on a regular basis.

	⚠ DANGER
	Fire and Explosion Hazard <ul style="list-style-type: none">• Do not obstruct combustion air openings at the bottom of the water heater.• Do not use or store flammable vapor products such as gasoline, solvents or adhesives in the same room or area near water heater or other appliance.• Visibly inspect flame arrestor at least once every six months and clean if accumulated lint.• Can cause serious injury or death.

AT LEAST ONCE EVERY SIX MONTHS, A VISUAL INSPECTION SHOULD BE MADE OF THE FLAME ARRESTOR. CLEAN IF LINT ACCUMULATIONS ARE NOTICED.

INSTALLED IN SUITABLE AREA: To ensure sufficient ventilation and combustion air supply, proper clearances from the water heater must be maintained. See *Facts to Consider About the Location* section. Combustible materials such as clothing, cleaning materials, or flammable liquids, etc. must not be placed against or adjacent to the water heater because they could catch on fire.

Anode Rod Inspection

CAUTION
Property Damage Hazard
<ul style="list-style-type: none">• Avoid water heater damage.• Inspection and replacement of anode rod required.

The anode rod is used to protect the tank from corrosion. Most hot water tanks are equipped with an anode rod. The submerged rod deteriorates to protect the tank. Instead of corroding the tank, water ions attack and eat away the anode rod. This does not affect the water's taste or color. The rod must be maintained to keep the tank in operating condition.

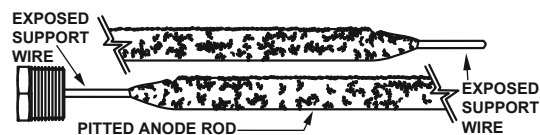

FIGURE 32

Anode deterioration depends on water conductivity, not necessarily water condition. A corroded or pitted anode rod indicates high water conductivity and should be checked and/

or replaced more often than an anode rod that appears to be intact. Replacement of a depleted anode rod can extend the life of your water heater. Inspection should be conducted by calling the Sears Service Center for an authorized contractor. The anode rod should be checked after a maximum of three years of use, then annually until the condition of the anode rod dictates the replacement of it. NOTE: Artificially softened water requires the anode rod to be inspected annually.

Temperature-Pressure Relief Valve Operation

The temperature-pressure relief valve must be manually operated at least once a year.

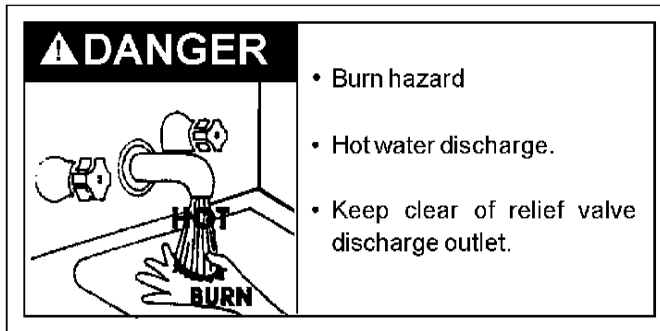

When checking the temperature-pressure relief valve operation, make sure that (1) no one is in front of or around the outlet of the temperature-pressure relief valve discharge line, and (2) that the water discharge will not cause any property damage, as the water may be extremely hot, see Figure 33.

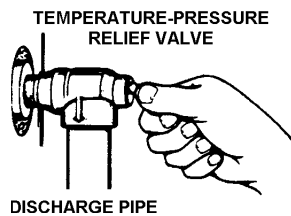
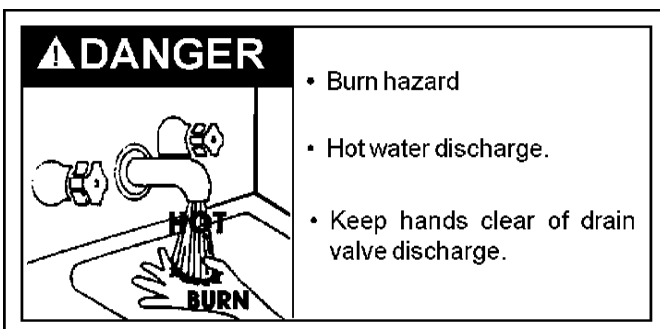

FIGURE 33.

If after manually operating the valve, it fails to completely reset and continues to release water, immediately close the cold water inlet to the water heater, follow the draining instructions, and replace the temperature-pressure relief valve with a new one.

If the temperature-pressure relief valve on the appliance weeps or discharges periodically, this may be due to thermal expansion. You may have a check valve installed in the water line or a water meter with a check valve. Consult the Sears Service Center for further information. Do not plug the temperature-pressure relief valve.

Draining



It is recommended that the tank be drained and flushed every 6 months to remove sediment which may build up during operation. The water heater should be drained if being shut down during freezing temperatures. To drain the tank, perform the following steps:

1. Turn off the gas to the water heater at the manual gas shut-off valve.
2. Open a nearby hot water faucet until the water is no longer hot.
3. Close the cold water inlet valve.
4. Connect a hose to the drain valve and terminate it to an adequate drain or external to the building.
5. Open the water heater drain valve and allow all of the water to drain from the tank. Flush the tank with water as needed to remove sediment.
6. Close the drain valve, refill the tank, and restart the heater as directed in this manual.

If the water heater is going to be shut down for an extended period, the drain valve should be left open.

IMPORTANT: Condensation may occur when refilling the tank and should not be confused with a tank leak.

Follow the lighting instructions in the Lighting section to restart the water heater.

Drain Valve Washer Replacement

(See Figure 34)

1. Turn "OFF" gas supply to water heater.
2. Follow "Draining" instructions.
3. Turning counter clockwise (↺), remove the cap.
4. Unscrew the stem by turning it counter clockwise (↺), and remove it from the drain valve body.
5. Remove the bottom washer and put the new one in place.
6. Re-insert the stem into the drain valve body and retighten the cap to the body using a wrench. DO NOT OVER TIGHTEN.
7. Follow instructions in the *Filling The Water Heater* section.
8. Check for leaks.
9. Follow the lighting instructions in the *Lighting* section to restart the water heater.

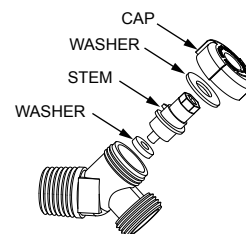

FIGURE 34.

Service

Before calling for repair service, read the *Start Up Conditions* and *Operational Conditions* found in the *Troubleshooting Guide* of this manual.

If a condition persists or you are uncertain about the operation of the water heater, let the Sears Service Center check it out.

Contact Sears Service Center at:
1-800-4-MY-HOME® (1-800-469-4663).

TROUBLESHOOTING GUIDE

Start Up Conditions

Thermal Expansion

CAUTION

Property Damage Hazard

- Avoid water heater damage.
- Install thermal expansion tank or device if necessary.
- Contact qualified installer or service agency.

As water is heated, it expands (thermal expansion). In a closed system, the volume of water will grow. As the volume of water grows, there will be a corresponding increase in water pressure due to thermal expansion. Thermal expansion can cause premature tank failure (leakage). This type of failure is not covered under the limited warranty. Thermal expansion can also cause intermittent temperature-pressure relief valve operation: water discharged from the valve due to excessive pressure build up. The temperature-pressure relief valve is not intended for the constant relief of thermal expansion. This condition is not covered under the limited warranty.

A properly-sized thermal expansion tank should be installed on all closed systems to control the harmful effects of thermal expansion. Contact a plumbing service agency or your retail supplier regarding the installation of a thermal expansion tank.

Table 1: Thermal Expansion Tank Specifications

Model Number	Tank Capacity In Gallons	Dimensions in Inches		Pipe Fitting On Tank
		Diameter	Length	
153.331020	2	8 (203 mm)	12-3/4 (323 mm)	3/4" Male
153.331050	5	11 (279 mm)	14-3/4 (375 mm)	3/4" Male

Table 2: Expansion Tank Sizing Chart

Expansion Tank Capacity Needed	Inlet* Water Pressure	Water Heater Capacity (Gallons)				
		30	40	50	66	82
40 psi	2	2	2	2	5	5
50 psi	2	2	2	2	5	5
60 psi	2	2	2	2	5	5
70 psi	2	2	2	5	5	5
80 psi	2	5	5	5	5	5

*Highest recorded inlet water pressure in a 24 hour period or regulated water pressure.

NOTE: Expansion tanks are pre-charged with a 40 psi air charge. If the inlet water pressure is higher than 40 psi, the expansion tank's air pressure must be adjusted to match that pressure, but must not be higher than 80 psi.

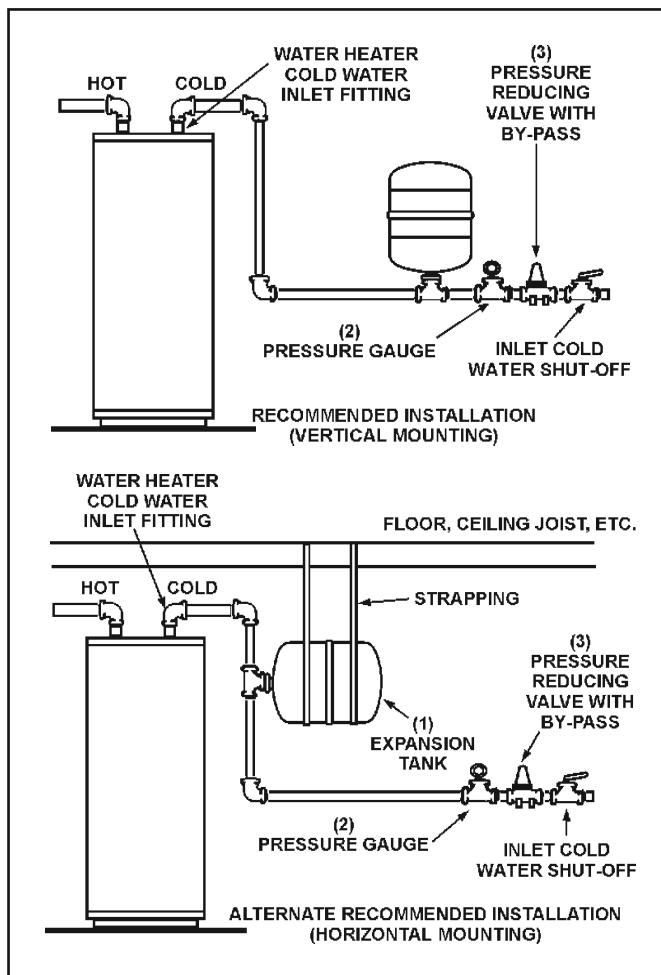

FIGURE 35.

Strange Sounds

Possible noises due to expansion and contraction of some metal parts during periods of heat-up and cool-down do not represent harmful or dangerous conditions.

Condensation causes sizzling and popping within the burner area during heating and cooling periods and should be considered normal. See *Condensation* section.

Draft Hood Operation

⚠ WARNING

Burn Hazard

Do not touch vent.

Doing so can result in burns.

Check draft hood operation by performing a worst case depressurization of the building. With all doors and windows closed, and with all air handling equipment and exhaust fans operating such as furnaces, clothes dryers, range hoods and bathroom fans, a match flame should still be drawn into the draft hood of the water heater with its burner firing. If the flame is not drawn toward the draft hood after 15 minutes of burner operation, shut off water heater and make necessary air supply changes to correct.

Condensation

Whenever the water heater is filled with cold water, some condensate will form while the burner is on. A water heater may appear to be leaking when in fact the water is condensation. This usually happens when:

- A new water heater is filled with cold water for the first time.
- Burning gas produces water vapor. In water heaters, particularly high efficiency models where flue temperatures are lower.
- Large amounts of hot water are used in a short time and the refill water in the tank is very cold.

Moisture from the products of combustion condense on the cooler tank surfaces and form drops of water which may fall onto the burner or other hot surfaces to produce a “sizzling” or “frying” noise.

Excessive condensation can cause pilot outage due to water running down the flue tube onto the main burner and putting out the pilot.

Because of the suddenness and amount of water, condensation water may be diagnosed as a “tank leak”. After the water in the tank warms up (about 1-2 hours), the condition should disappear.

Do not assume the water heater is leaking until there has been enough time for the water in the tank to warm up.

An undersized water heater will cause more condensation. The water heater must be sized properly to meet the family's demands for hot water including dishwashers, washing machines and shower heads.

Excessive condensation may be noticed during the winter and early spring months when incoming water temperatures are at their lowest.

Good venting is essential for a gas fired water heater to operate properly as well as to carry away products of combustion and water vapor.

Smoke Odor

It is not uncommon to experience a small amount of smoke and odor during the initial start-up. This is due to burning off of oil from metal parts, and will disappear in a short while.

Operational Conditions

Smelly Odor

In each water heater there is installed at least one anode rod (see parts section) for corrosion protection of the tank. Certain water conditions will cause a reaction between this rod and the water. The most common complaint associated with the anode rod is one of a “rotten egg smell”. This odor is derived from hydrogen sulfide gas dissolved in the water. The smell is the result of four factors which must all be present for the odor to develop:

- a concentration of sulfate in the supply water.
- little or no dissolved oxygen in the water.
- a sulfate reducing bacteria within the water heater. (This harmless bacteria is non-toxic to humans.)
- an excess of active hydrogen in the tank. This is caused by the corrosion protective action of the anode.

Smelly water may be eliminated or reduced in some water heater models by replacing the anode(s) with one of less active material, and then chlorinating the water heater tank and all hot water

lines. Contact Sears Service for further information concerning an Anode Replacement Kit #9001453 and this Chlorination Treatment. Anode replacement and chlorination of the tank are not covered by the water heater's limited warranty.

If the smelly water persists after the anode replacement and chlorination treatment, it may be necessary to chlorinate or aerate your water supply to eliminate the problem.

Do not remove the anode leaving the tank unprotected. By doing so, all warranty on the water heater tank is voided.

Water Temperature Stacking

Stacking occurs when a series of short draws of hot water (3 gallons or less) are taken from the water heater tank. This causes increased cycling of the burner and can result in increased water temperatures at the hot water outlet.

This water heater's temperature control has been designed to accurately regulate the water temperature. However, under certain operating conditions, the water temperature may temporarily exceed the dial setting. Consequently, in addition to setting the temperature no higher than 120°F, we recommend the installation of a mixing valve or an anti-scald device in the hot water supply line or at the point of use to further reduce the risk of scald injury. These devices can be obtained from a plumbing service agency or your retail supplier.

“AIR” In Hot Water Faucets

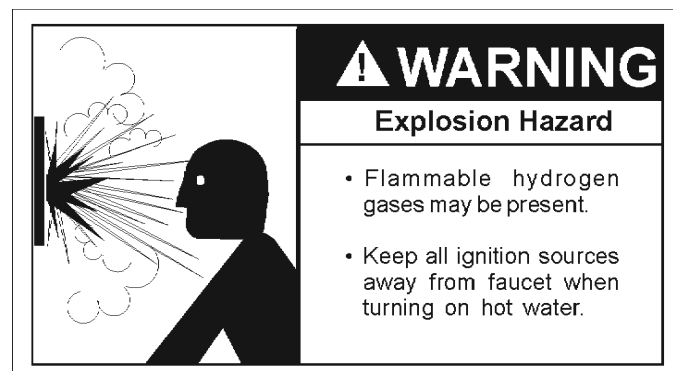

HYDROGEN GAS: Hydrogen gas can be produced in a hot water system that has not been used for a long period of time (generally two weeks or more). Hydrogen gas is extremely flammable and explosive. To prevent the possibility of injury under these conditions, we recommend the hot water faucet, located farthest away, be opened for several minutes before any electrical appliances which are connected to the hot water system are used (such as a dishwasher or washing machine). If hydrogen gas is present, there will probably be an unusual sound similar to air escaping through the pipe as the hot water faucet is opened. There must be no smoking or open flame near the faucet at the time it is open.

Safety Shut-Off

This water heater is equipped with an automatic gas shutoff system. This system works when high water temperatures are present. The high temperature shutoff is built into the gas control valve. It is non-resettable. If the high temperature shutoff activates, the gas control valve must be replaced. Turn “OFF” the entire gas supply to the water heater and contact your gas supplier.

This water heater is designed to automatically shut-off in the event of the following:

1. The pilot flame is extinguished for any reason.

2. The water temperature exceeds 189°F (87°C).
3. Excessive contaminants in the combustion chamber.
4. The ignition of flammable vapors.

A thermopile is used to determine if a pilot flame is present and will shut off the gas supply to the main burner and pilot if the flame is absent. This unit is also equipped with a combustion chamber temperature sensor. This sensor will shut off the gas supply to the burner if lint, dust, or other contaminants pollute the burner. If the gas control valve/thermostat shuts off the gas supply, check the diagnostic flash code and refer to the "Status Light Troubleshooting Chart." If necessary, also refer to the "Troubleshooting Guide."

Also, a temperature limit switch or ECO (Energy Cut Off) sensor located in the gas control valve/thermostat is used to shut off the water heater if the water temperature exceeds 189°F (87°C). The Diagnostic Status Light will flash a code indicating an "Overheat Failure" (4 Flashes). See "Operating the Temperature Control System." If the ECO has functioned, the gas control valve/thermostat should be replaced by a qualified technician. Contact Sears Service for service information.

If the Diagnostic Status Light indicates an "LDO Occurrence" (10 Flashes), refer to the "Status Light Troubleshooting Chart."

Leakage Checkpoints

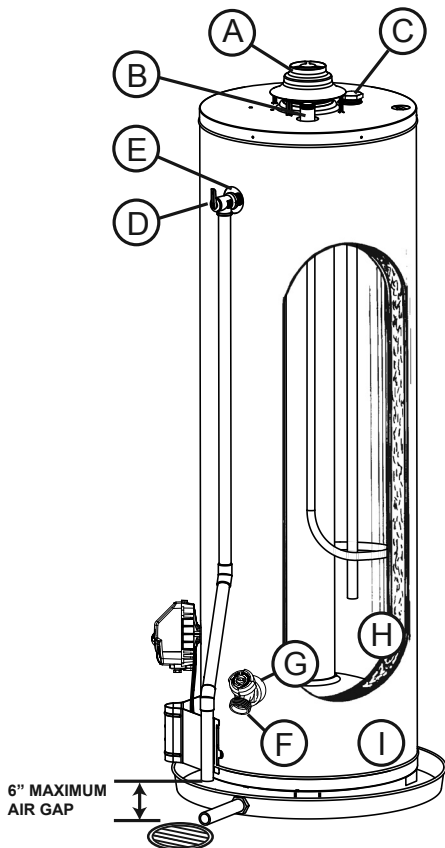
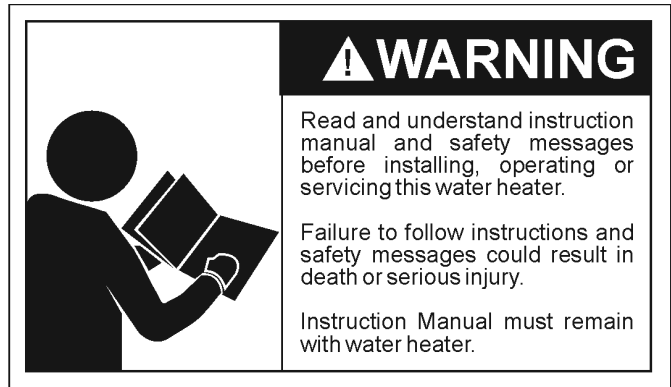

FIGURE 36.



Read this manual first. Then, before checking the water heater, make sure the gas supply has been turned "OFF", and never turn the gas "ON" before the tank is completely full of water.

Never use this water heater unless it is completely filled with water. To prevent damage to the tank, the tank must be filled with water. Water must flow from the hot water faucet before turning "ON" gas to the water heater.

- A. Water at the draft hood is water vapor which has condensed out of the combustion products. This is caused by a problem in the vent. Contact a qualified technician.
- B. *Condensation may be seen on pipes in humid weather or pipe connections may be leaking.
- C. *The anode rod fitting may be leaking.
- D. Small amounts of water from temperature-pressure relief valve may be due to thermal expansion or high water pressure in your area.
- E. *The temperature-pressure relief valve may be leaking at the tank fitting.
- F. Water from a drain valve may be due to the valve being slightly opened.
- G. *The drain valve may be leaking at the tank fitting.
- H. Combustion products contain water vapor which can condense on the cooler surfaces of the tank. Droplets form and drip onto the burner or run on the floor. This is common at the time of start-up after installation and when incoming water is cold.
- I. Water in the water heater bottom or on the floor may be from condensation, loose connections, or the relief valve. DO NOT replace the water heater until a full inspection of all possible water sources is made and necessary corrective steps taken.

Leakage from other appliances, water lines, or ground seepage should also be checked.

- * To check where threaded portion enters tank, insert cotton swab between jacket opening and fitting. If cotton is wet, follow draining instructions in the "Draining" section and then remove fitting. Put pipe dope or teflon tape on the threads and replace. When you are finished, follow the steps in "Filling the Water Heater" in the Installation Instructions earlier in this manual.

TROUBLESHOOTING GUIDE

PROBLEM	POSSIBLE CAUSE(S)	CORRECTIVE ACTION
BURNER WILL NOT IGNITE	<ol style="list-style-type: none"> 1. Pilot not lit 2. Thermostat set too low 3. No gas 4. Dirt in the gas lines 5. Pilot line clogged 6. Main burner line clogged 7. Non-functioning thermopile 8. Non-functioning thermostat 9. Heater installed in a confined area 	<ol style="list-style-type: none"> 1. Light pilot 2. Turn temp. dial to desired temperature 3. Check with gas utility company 4. Notify utility-install trap in gas line 5. Clean, locate source and correct 6. Clean, locate source and correct 7. Replace thermopile 8. Replace thermostat 9. Provide fresh air ventilation
SMELLY WATER	<ol style="list-style-type: none"> 1. Sulfides in the water 	<ol style="list-style-type: none"> 1. Replace the anode with a special anode
BURNER FLAME YELLOW-LAZY	<ol style="list-style-type: none"> 1. Insufficient secondary air 2. Low gas pressure 3. Flue clogged 4. Main burner line clogged 5. Heater installed in a confined area 6. Obstruction in main burner orifice 	<ol style="list-style-type: none"> 1. Provide ventilation to water heater 2. Check with gas utility company 3. Clean, locate source and correct 4. Clean, locate source and correct 5. Proper fresh air ventilation 6. Clean or replace orifice
PILOT WILL NOT LIGHT OR REMAIN LIT	<ol style="list-style-type: none"> 1. Non-functioning igniter 2. Thermopile connection loose 3. Air in gas line 4. Proper Lighting Sequence not followed. Gas Control / Temperature Knob was not held in for sufficient time. 5. Low gas pressure 6. No gas 7. Dirt in gas lines 8. Cold drafts 9. ECO switch open 10. Pilot line or orifice clogged 11. Non-functioning thermopile 12. Air for combustion obstructed 13. Flammable vapors incident, FVIR function utilized 	<ol style="list-style-type: none"> 1. Replace igniter pilot assembly 2. Seat connector firmly in socket 3. Bleed the air from the gas line 4. Do not attempt to relight if the red light is lit and the pilot flame is not visible through the view port. Wait until the red light is no longer lit, then follow lighting instructions on the water heater. 5. Check with gas utility company 6. Check with gas utility company 7. Notify utility-install dirt trap in gas line 8. Locate source and correct 9. Replace gas control valve/thermostat 10. Clean, locate source and correct 11. Replace thermopile 12. See maintenance section for inspection and cleaning of flame trap 13. Eliminate flammable vapor source(s), Call 1-800-4-MY-HOME® (1-800-469-4663)
HIGH OPERATION COSTS	<ol style="list-style-type: none"> 1. Thermostat set too high 2. Sediment or lime in tank 3. Water heater too small for job 4. Wrong piping connections 5. Leaking faucets 6. Gas leaks 7. Wasted hot water 8. Long runs of exposed piping 9. Hot water piping in exposed wall 	<ol style="list-style-type: none"> 1. Set temperature dial to lower setting 2. Drain/flush-provide water treatment if needed 3. Install adequate heater 4. Correct piping-dip tube must be in cold inlet 5. Repair faucets 6. Check with utility-repair at once 7. Advise customer 8. Insulate piping 9. Insulate piping
INSUFFICIENT HOT WATER	<ol style="list-style-type: none"> 1. Thermostat set too low 2. Sediment or lime in tank 3. Water heater too small 4. Wrong piping connections 5. Leaking faucets 6. Wasted hot water 7. Long runs of exposed piping 8. Hot water piping in outside wall 9. Low gas pressure 	<ol style="list-style-type: none"> 1. Turn temperature dial to desired setting 2. Drain/flush-provide water treatment if needed 3. Install adequate heater 4. Correct piping-dip tube must be in cold inlet 5. Repair faucets 6. Advise customer 7. Insulate piping 8. Insulate piping 9. Check with gas utility company
SLOW HOT WATER RECOVERY	<ol style="list-style-type: none"> 1. Insufficient secondary air 2. Flue clogged 3. Low gas pressure 4. Improper calibration 5. Thermostat set too low 6. Water heater too small 7. Wrong piping connections 8. Wasted hot water 	<ol style="list-style-type: none"> 1. Provide ventilation to water heater. Check flue way, flue baffle, and burner 2. Clean flue, locate source and correct 3. Check with gas utility company 4. Replace thermostat 5. Turn temperature dial to desired setting 6. Install adequate heater 7. Correct piping-dip tube must be in cold inlet 8. Advise customer

TROUBLESHOOTING GUIDE (Continued)

DRIP FROM RELIEF VALVE	<ol style="list-style-type: none"> 1. Excessive water pressure 2. Heater stacking 3. Closed water system 	<ol style="list-style-type: none"> 1. Use a pressure reducing valve and relief valve 2. Lower the thermostat setting 3. See "Closed System/Thermal Expansion"
THERMOSTAT FAILS TO SHUT-OFF	<ol style="list-style-type: none"> 1. Thermostat not functioning properly 2. Improper calibration 	<ol style="list-style-type: none"> 1. Replace thermostat 2. Replace thermostat
COMBUSTION ODORS	<ol style="list-style-type: none"> 1. Insufficient secondary air 2. Flue clogged 3. Heater installed in a confined area 	<ol style="list-style-type: none"> 1. Provide ventilation to water heater. Check flue way, flue baffle, and burner 2. Clean, locate source and correct 3. Provide fresh air ventilation
SMOKING AND CARBON FORMATION (SOOTING)	<ol style="list-style-type: none"> 1. Insufficient secondary air 2. Low gas pressure 3. Flue clogged 4. Thermostat not functioning properly 5. Heater installed in a confined area 6. Burner flame yellow-lazy 	<ol style="list-style-type: none"> 1. Provide ventilation to water heater. Check flue way, flue baffle, burner 2. Check with gas utility company 3. Clean, locate source and correct 4. Replace thermostat 5. Provide fresh air ventilation 6. See "Burner Flame Yellow-Lazy"
CONDENSATION	<ol style="list-style-type: none"> 1. Temperature setting too low 	<ol style="list-style-type: none"> 1. Increase the temperature setting
BURNER FLAME FLOATS AND LIFTS OFF PORTS	<ol style="list-style-type: none"> 1. Orifice too large 2. High gas pressure 3. Flue clogged 4. Cold drafts 	<ol style="list-style-type: none"> 1. Replace with correct orifice 2. Check with gas utility company 3. Clean flue and burner-locate source and correct 4. Locate source and correct
BURNER FLAME TOO HIGH	<ol style="list-style-type: none"> 1. Orifice too large 	<ol style="list-style-type: none"> 1. Replace with correct orifice
PILOT FLAME TOO SMALL	<ol style="list-style-type: none"> 1. Pilot line or orifice clogged 2. Low gas pressure 	<ol style="list-style-type: none"> 1. Clean, locate source and correct 2. Check with gas utility company

STATUS LIGHT TROUBLESHOOTING CHART

LED STATUS	PROBLEM	CORRECTIVE ACTION
0 FLASHES (LED NOT LIT)	Pilot light is not lit. Not enough power (millivolts) to keep it lit.	Follow the lighting instructions on the front of the water heater and record any diagnostic codes. See Status Light Codes section.
1 FLASH (EVERY 3 SECONDS)	Normal operation.	No corrective action necessary.
2 FLASHES	Insufficient power (millivolts) to the gas control valve/thermostat.	<ol style="list-style-type: none"> 1. Check all wiring connections. If problem persists proceed to step 2. 2. Replace the thermopile. If you feel uncomfortable with this procedure, contact a qualified technician.
4 FLASHES	High water temperature has activated the over heat sensor.	Replace the gas control valve/thermostat. If you feel uncomfortable with this procedure, contact a qualified technician.
5 FLASHES	Water temperature sensor failure	Replace the gas control valve/thermostat. If you feel uncomfortable with this procedure, contact a qualified technician.
7 FLASHES	Gas Control Valve/Thermostat failure.	Replace the gas control valve/thermostat. If you feel uncomfortable with this procedure, contact a qualified technician.
8 FLASHES	This condition only appears if the gas control/temperature knob has been turned off and the thermopile continued to produce electric power. This condition can occur if the thermopile does not cool down as quickly as expected when the unit is shut off. This condition can also occur if the gas control/temperature knob has been turned off and the pilot continues to operate because the pilot valve is stuck in the open position.	<p>Make sure that the gas control valve/thermostat knob is set to OFF. Wait one minute. Remove the outer door. Look through the sight glass for a pilot flame. If a pilot flame is observed with the gas control valve/thermostat knob set to the OFF position, the pilot valve is stuck open. Turn the main gas supply OFF. Replace the gas control valve/thermostat. If you feel uncomfortable with this procedure, contact a qualified technician.</p> <p>If the pilot flame is not observed when the gas control valve/thermostat knob is set to the OFF position, wait 10 minutes for the thermopile to cool, then attempt to relight the pilot by following the lighting instructions on the water heater's label. If this condition returns, replace the gas control valve/thermostat. Contact a qualified technician if you are uncomfortable with this procedure.</p>
9 FLASHES	Combustion chamber temperature sensor circuit is open or shorted	<ol style="list-style-type: none"> 1. Check all connections. If the problem persists, proceed to step 2. 2. Replace the temperature sensor. If you feel uncomfortable with this procedure, contact a qualified technician. If the problem persists, proceed to step 3. 3. Replace the gas control valve/thermostat. If you feel uncomfortable with this procedure, contact a qualified technician.
10 FLASHES	LDO occurrence was detected in the combustion chamber (contaminants)	<ol style="list-style-type: none"> 1. Reset the system by following these steps: 1.) Turn the temperature adjustment knob to OFF. 2.) Unplug the thermopile plug from the gas control valve/thermostat. 3.) Wait for about three minutes. 4.) Plug the thermopile plug back into the gas control valve/ thermostat. 5.) Turn the temperature adjustment knob to PILOT and restart the water heater as directed in this manual. If the problem persists, proceed to step 2. 2. Follow the procedure outlined in "Cleaning the Combustion Chamber and Flame-Trap." If the problem persists, proceed to step 3. 3. Shut off the gas supply to the water heater and contact Sears Service: 1-800-4-MY-HOME ® (1-800-469-4663).

PILOT LIGHT TROUBLESHOOTING CHART

Section A: Pilot light will not light (new installation).

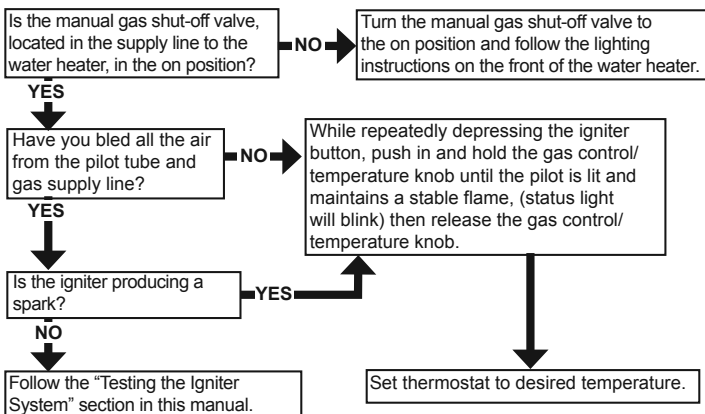

Section B: Pilot light repeatedly goes out.

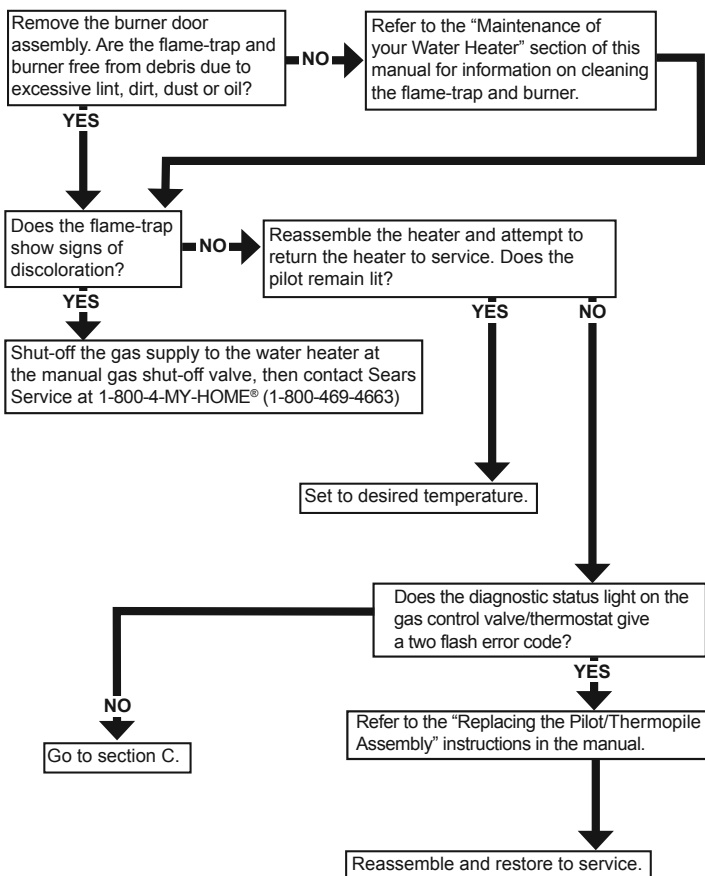

Section C: Pilot light will not remain lit.

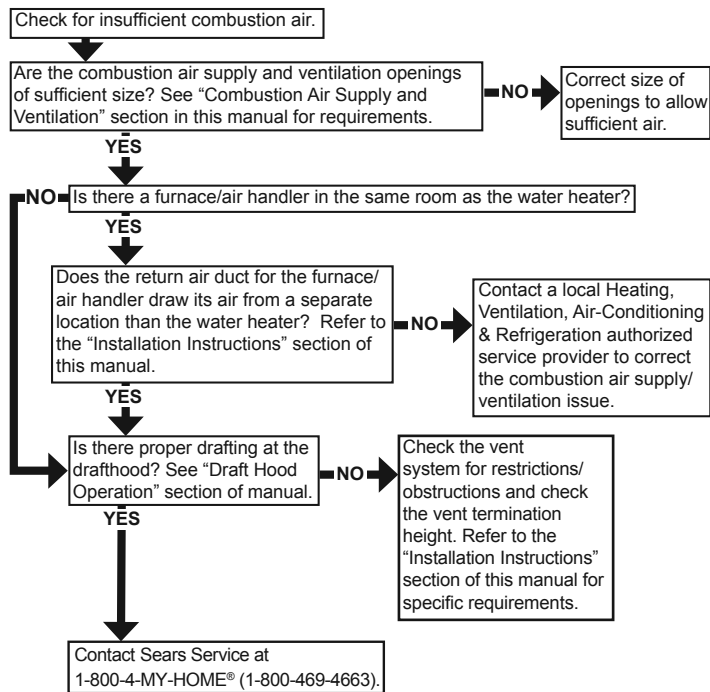

NOTE: If you are still experiencing difficulties after following the steps in sections A, B, and C, contact Sears Service at 1-800-4-MY-HOME® (1-800-469-4663).

PARTS ORDER LIST

KENMORE ULTRA LOW NOx GAS WATER HEATER

MODEL NO'S	
153.330200	30 Gallon
153.330220	40 Gallon
153.330230	50 Gallon

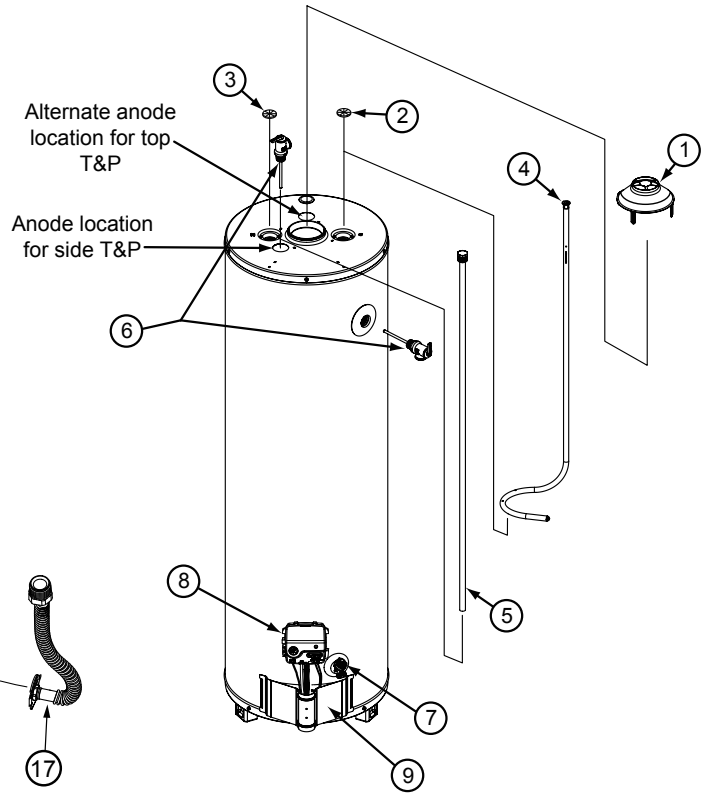
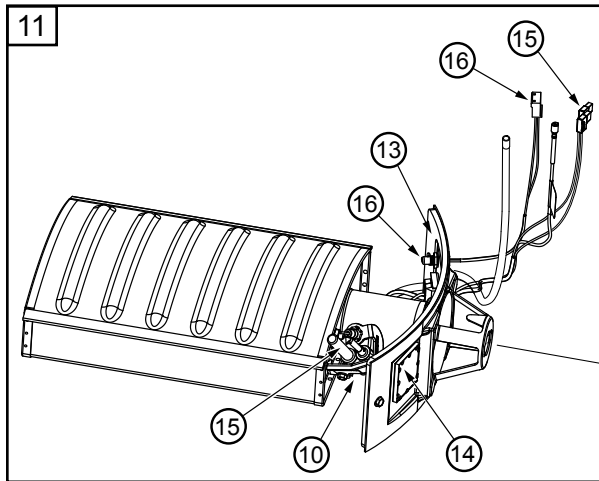

Key No.	Part Description	Model Numbers		
		153.330200	153.330220	153.330230
1	Draft Hood	185917-001	185917-001	185917-001
2	Heat Trap (Cold) - Some Models	9003915	9003915	9003915
3	Heat Trap (Hot) - Some Models	9003915	9003915	9003915
4	Cold Water Dip Tube	9003637	9002432	9002432
5	Anode Rod	9003892	9003892	9003892
6	T & P Relief Valve (Located Top Or Side)	9000071	9000071	9000071
7	Drain Valve	9000254	9000254	9000254
8	Gas Control Valve/Thermostat	9007631	9007631	9007631
9	Outer Door	700795-018	700795-018	700795-018
10	Pilot/Thermopile Assembly (Natural Gas)	9007633	9007633	9007633
11	Burner Door Assembly (Natural Gas/Low Nox)**	9007655	9007656	9007657
12*	Manifold Component Block With Retainer Clip	9006449	9006449	9006449
13	Burner Door Gasket	9006141	9006141	9006141
14	Viewport Assembly	9006142	9006142	9006142
15	Thermopile	9007630	9007630	9007630
16	Temperature Sensor	9007634	9007634	9007634
17	Flexible Manifold Tube***	9006445	9006445	9006445
18*	Instruction Manual	319588-002	319588-002	319588-002

* Not Shown.

** Includes Inner Door Gasket

*** Flexible manifold tube sold as a separate part (burner not included).

Now that you have purchased your gas water heater, should a need ever exist for repair parts or service, simply contact any Sears Service Center or call 1-800-4-MY-HOME® (1-800-469-4663). Be sure to provide all pertinent facts when you call or visit.

- MODEL NUMBER
- SERIAL NUMBER
- TYPE GAS - NATURAL
- PART DESCRIPTION

WHEN ORDERING REPAIR PARTS, ALWAYS GIVE THE FOLLOWING INFORMATION:

THIS IS A REPAIR PARTS LIST, NOT A PACKING LIST.

Get it fixed, at your home or ours!

Your Home

For troubleshooting, product manuals and expert advice:



www.managemylife.com

For repair – **in your home** – of **all** major brand appliances, lawn and garden equipment, or heating and cooling systems, **no matter who made it, no matter who sold it!**

For the replacement parts, accessories and owner's manuals that you need to do-it-yourself.

For Sears professional installation of home appliances and items like garage door openers and water heaters.

1-800-4-MY-HOME[®] (1-800-469-4663)

Call anytime, day or night (U.S.A. and Canada)

www.sears.com www.sears.ca

Our Home

For repair of carry-in items like vacuums, lawn equipment, and electronics, call anytime for the location of your nearest

Sears Parts & Repair Service Center

1-800-488-1222 (U.S.A.)

www.sears.com

1-800-469-4663 (Canada)

www.sears.ca

To purchase a protection agreement on a product serviced by Sears:

1-800-827-6655 (U.S.A.)

1-800-361-6665 (Canada)

Para pedir servicio de reparación a domicilio, y para ordenar piezas:

1-888-SU-HOGAR[®]

(1-888-784-6427)

www.sears.com

Au Canada pour service en français:

1-800-LE-FOYER^{MC}

(1-800-533-6937)

www.sears.ca

The Sears logo, featuring the word "Sears" in a large, bold, serif font with a stylized 'S'.

® Registered Trademark / TM Trademark of KCD IP, LLC in the United States, or Sears Brands, LLC in other countries

® Marca Registrada / TM Marca de Fábrica de KCD IP, LLC en Estados Unidos, o Sears Brands, LLC in otros países

^{MC} Marque de commerce / ^{MD} Marque déposée de Sears Brands, LLC

Free Manuals Download Website

<http://myh66.com>

<http://usermanuals.us>

<http://www.somanuals.com>

<http://www.4manuals.cc>

<http://www.manual-lib.com>

<http://www.404manual.com>

<http://www.luxmanual.com>

<http://aubethermostatmanual.com>

Golf course search by state

<http://golfingnear.com>

Email search by domain

<http://emailbydomain.com>

Auto manuals search

<http://auto.somanuals.com>

TV manuals search

<http://tv.somanuals.com>