

# Kenmore Sewing Machine

**MODEL**  
**1581**  
**1680**  
**1682**  
**1690**  
**1780**  
**1781**  
**1782**  
**1785**  
**17860**  
**17861**  
**17862**

## TABLE OF CONTENTS

### 1. KNOWING YOUR SEWING MACHINE

Machine identification .....	1 - 2
Parts list .....	3 - 5
Setting up your machine .....	6
Foot control, Light/power switch, Spool pins and caps .....	
Converting to free-arm sewing .....	7
Winding the bobbin .....	8
Threading the bobbin case .....	9
Threading top thread .....	10
Picking up bobbin thread .....	11
<b>CONTROLS</b>	
Thread tension control .....	12
Stitch length control, Stitch width control .....	13
Special stitch dial, Stitch modifier .....	14
Reverse stitch lever, Pressure regulator, Seam guides, Presser foot lever .....	15
<b>ACCESSORIES</b>	
Needles .....	16
Changing needle, Presser feet .....	17
Needle plates, Darning plate .....	18
Pattern cams, Buttonhole attachment .....	19
<b>CARING FOR THE MACHINE</b>	
Cleaning feed dogs and shuttle .....	20
Oiling .....	21 - 22
Changing light bulb .....	22
<b>CHECKING PERFORMANCE PROBLEMS</b> .....	23 - 24

### 2. STARTING TO SEW

Machine setting chart .....	25 - 26
Straight stitching .....	27 - 29
Zigzag stitching .....	30 - 32
Blind hemming .....	33
Mending and overcast stitching (three-step zigzag) .....	33
Shell stitching .....	34
Box stitch .....	34
Fagoting stitch .....	34
Stretch stitches .....	35 - 38
Designing with orange pattern cams .....	39 - 40
Designing with green pattern cams .....	41 - 42
Getting the most from fabrics that give .....	43 - 44
Hints on sewing different fabrics .....	45
Buttonhole making .....	46 - 50

**OWNER'S  
MANUAL**

# 1. KNOWING YOUR SEWING MACHINE

## IDENTIFICATION CHART

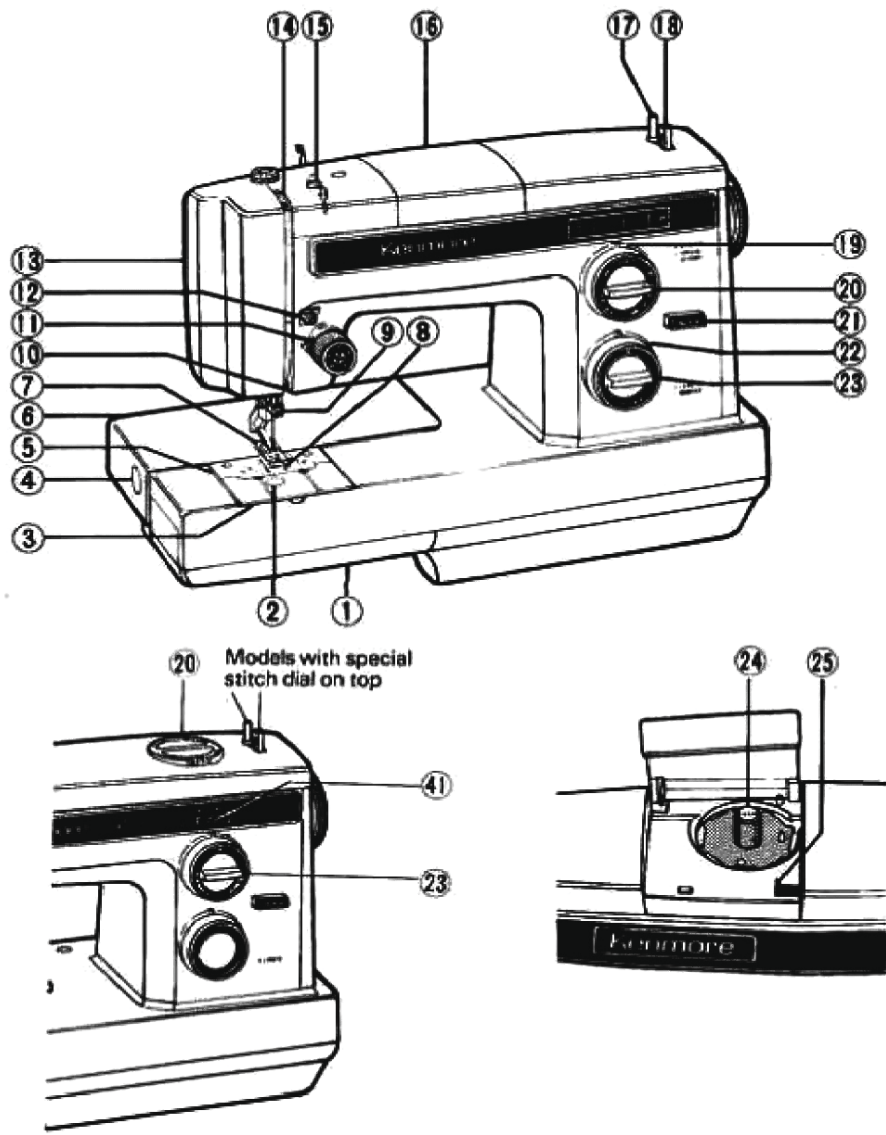

## BUTTONHOLE MAKING- USING BUTTONHOLE ATTACHMENT

### SETTINGS

Special Stitch Dial -  $\approx \bullet \bullet \bullet$   
 Stitch Width Control - 1 to 1-1/2  
 Stitch Length Control - 0  
 Stitch Modifier - Red Dot  
 Pressure Regulator - 1 or 2  
 Buttonhole Foot  
 Zig Zag Needle Plate  
 Darning Plate

1. Raise needle to its highest point and raise presser foot. Remove base cover by pressing release button.
2. Insert a template into the slot of template holder. Select the proper size buttonhole by turning template advance knob.
3. Slip guide plate onto position from the rear of the machine making sure to insert guide pin into guide slot.
4. Pull guide plate all the way forward so that guide pin is at S making sure to drop guide plate into place over pinion gear on base. This will enable you to start at one end of the buttonhole.
5. Pick up bobbin thread through guide plate by turning hand wheel and drawing thread to back of machine. Place fabric between presser foot and guide plate. Line up edge of fabric with marked indentation on guide. See Fig. 4. If you wish all buttonholes to be 3/4 inch from edge of garment, line up fabric with 3/4 inch marking each time you start sewing a buttonhole.

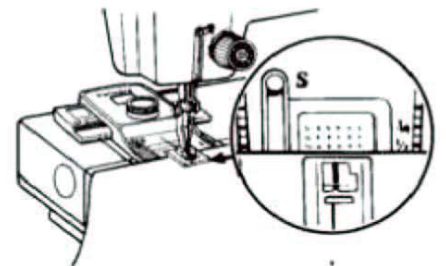
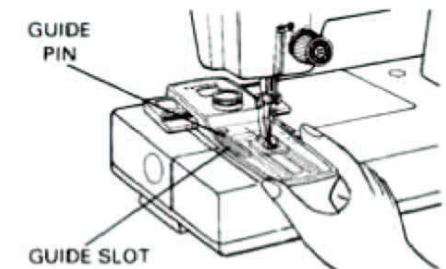
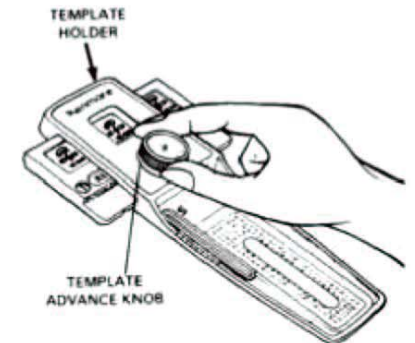
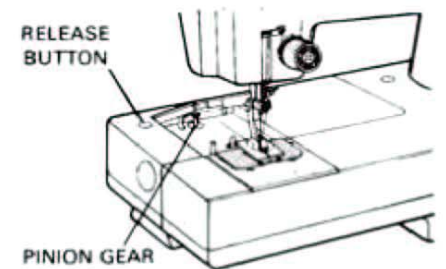

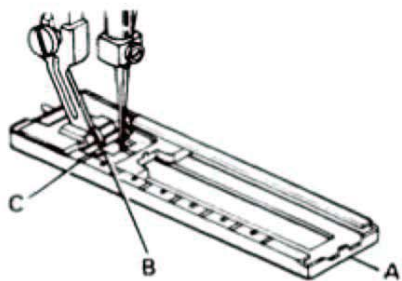

## BUTTONHOLE MAKING - BUILT-IN SYSTEM

### SETTINGS

Special Stitch Dial —   
 Stitch Width Control — Red Dot   
 Stitch Length Control — Red Zone to 24   
 Stitch Modifier — Desired point of length on   
 Buttonhole Guide Foot   
 Zigzag Needle Plate

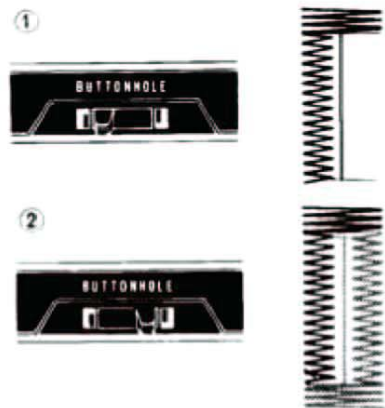

### PREPARATION

Carefully mark the buttonhole length on your garment. Place the fabric with the buttonhole marked under the buttonhole foot. Pull the guide foot (A) all the way forward so that the index mark (B) is aligned with the graduation (C), with thread to rear. (Reproduction of the identical size buttonholes is facilitated with the aid of the graduations on both sides of the buttonhole guide foot. These graduations are 1/8" apart. Graduations act as reference mark.)

### PROCEDURE

1. Switch the control to left. (If it is already at left, set it at right, sew several stitches and switch to left again before you start to sew buttonholes.) Step on foot control to form first bartack and left side of buttonhole.
2. When you reach end of left side, switch the control to the right and complete the buttonhole.

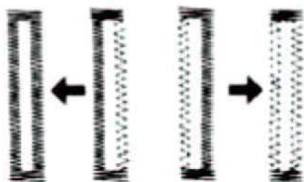

### ADJUSTING STITCH BALANCE

Stitch length differences in forward and reverse stitches of the buttonhole are equalized with the stitch modifier within the range of marking.

If the reverse stitches are too far apart, turn the modifier slightly clockwise; if they are too close together, turn counter-clockwise.

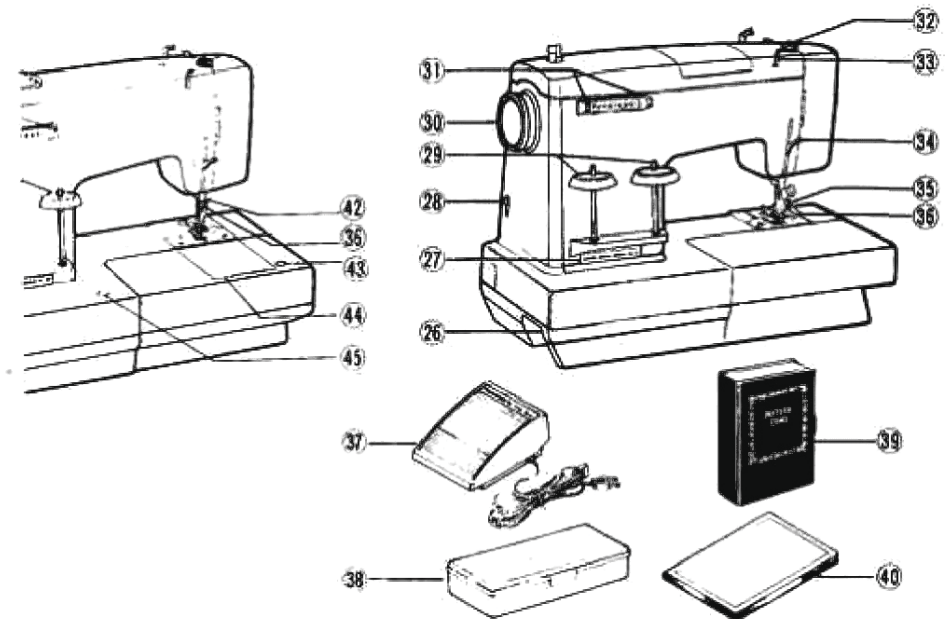

- |                                |                                |
|--------------------------------|--------------------------------|
| 1. Free arm                    | 24. Cam holder                 |
| 2. Bobbin window               | 25. Cam lever                  |
| 3. Bobbin cover plate          | 26. Electric cord receptacle   |
| 4. Swing-away base release     | 27. Nomenclature plate         |
| 5. Needleplate                 | 28. Light and power switch     |
| 6. Swing away base             | 29. Spool pins and caps        |
| 7. Presser foot                | 30. Hand wheel                 |
| 8. Feed dogs                   | 31. Rear thread guide          |
| 9. Needle clamp screw          | 32. Foot pressure regulator    |
| 10. Thread guide               | 33. Rear thread guide          |
| 11. Top thread tension control | 34. Presser foot lever         |
| 12. Thread guide               | 35. Presser foot release lever |
| 13. Face cover plate           | 36. Thread cutter              |
| 14. Slotted take-up lever      | 37. Foot control               |
| 15. Bobbin tension disc        | 38. Accessory box              |
| 16. Cam holder cover           | 39. Pattern cam box            |
| 17. Bobbin winder shaft        | 40. Owner's manual             |
| 18. Bobbin winder latch        | 41. Buttonhole control         |
| 19. Stitch width control       | 42. Presser foot lock          |
| 20. Special stitch dial        | 43. Attachment cover release   |
| 21. Reverse stitch lever       | 44. Attachment cover plate     |
| 22. Stitch length control      | 45. Base release button        |
| 23. Stitch modifier            |                                |

\* Available on some models.

## PARTS LIST

### PARTS AND ACCESSORIES PROVIDED WITH MACHINE

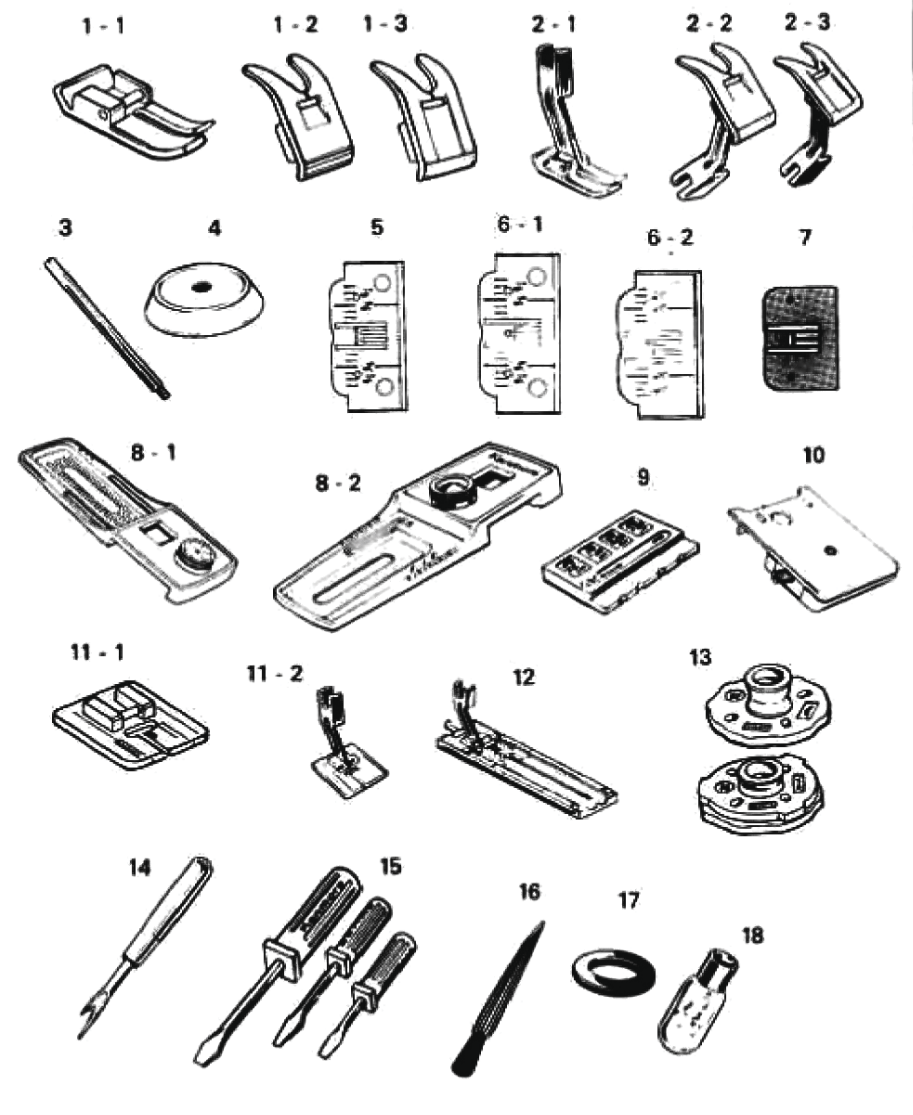

## ADJUSTING STITCH DENSITY

Depending upon the fabrics on which you are sewing, or your own preference in buttonholes, you may alter buttonhole stitch density by turning stitch density control knob.

1. For more density, turn the knob toward you.
2. For less density, turn the knob away from you.

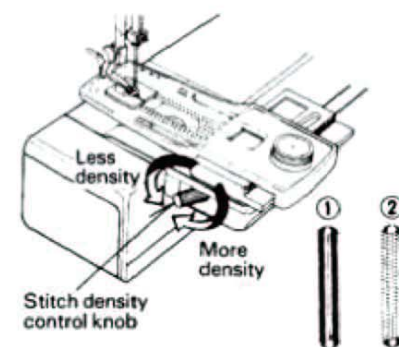

## CHOOSING BUTTONHOLE STYLE AND SIZE

Each buttonholing situation will be different so you will want to experiment with your garment, considering fabric and placement of button. Here are some basic applications:

**Straight buttonholes** are most popular for everyday sewing – for series of buttons on dress, blouse, vest, jacket or coat.

**Keyhole buttonholes** are a variation of the above, with an enlarged opening at one end to allow more room for button shank. These are normally used in tailored vests, jackets, coats.

ROUND END  
STRAIGHT  
BUTTONHOLE



KEYHOLE  
BUTTONHOLE



Template	45195	45196	45197
Sizes	$\frac{3}{8}$ " - $\frac{1}{2}$ " - $\frac{3}{8}$ " - $\frac{9}{16}$ "	$\frac{7}{16}$ " - $1\frac{1}{16}$ " - $1\frac{1}{4}$ " - $1\frac{1}{2}$ "	$\frac{3}{8}$ " - $1\frac{1}{16}$ " - $1\frac{1}{4}$ " - $1\frac{3}{8}$ "

## TIPS ON BUTTONHOLING

Always make a practice buttonhole on a scrap of fabric you plan to use. Try the buttonhole with the button you will use.

For heavier weight fabrics, loosen your top thread tension slightly and use a wider stitch width setting.

**Always use an interfacing in the area of**

**the garment where buttonholes are placed. Tissue paper or regular interfacing can be used. Tear paper away after stitching, if it is used.**

Be sure that you are using the zigzag needle plate with the darning plate on top of it.

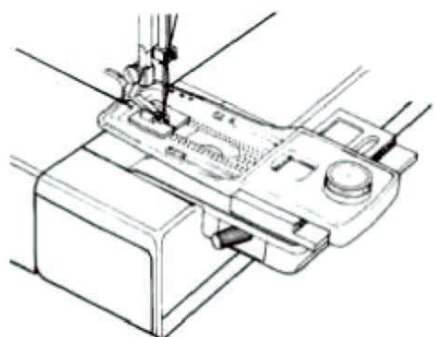

3. Slip guide plate onto machine so it fits in place with **pinion gear** in the center of arc hole of template. Be sure guide block is inserted in guide slot.

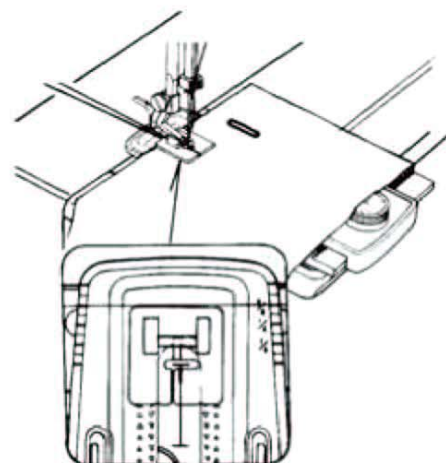
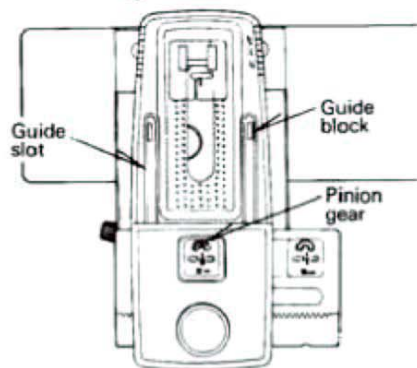

4. Pick up bobbin thread through guide plate by turning hand wheel. Place fabric between presser foot and guide plate. Align marked buttonhole with center marking on foot. Line up edge of fabric with markings on guide plate. If you wish all buttonholes to be 3/4" from edge of garment, for example, line up fabric with 3/4" marking each time you start a buttonhole.

**OPTIONAL ACCESSORIES** (Available as standard accessories on some models)

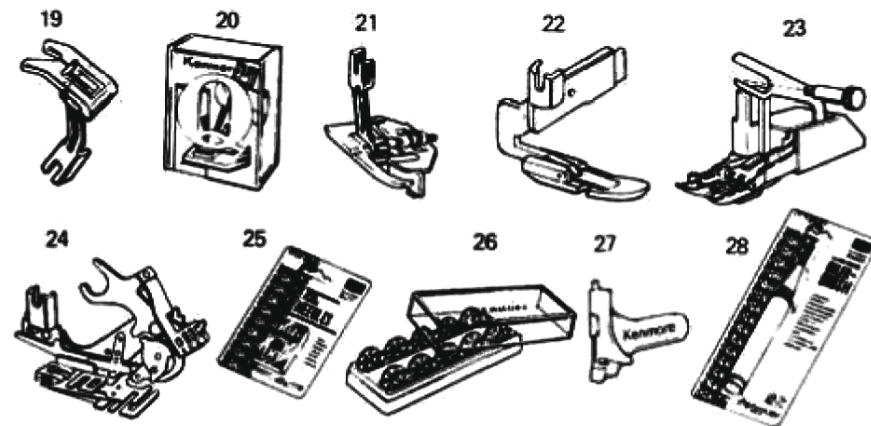

**PARTS LIST** (Use only genuine Kenmore replacement parts and accessories.)

All parts listed herein may be ordered from any Sears, Roebuck and Co. store or service center.

3. MODEL NUMBER shown on the nomenclature plate.

4. NAME OF ITEM

WHEN ORDERING REPAIR PARTS, ALWAYS GIVE THE FOLLOWING INFORMATION:

If the parts you need are not stocked locally, your order will be electronically transmitted to a Sears Repair Parts Distribution Center for expedited handling.

1. PART NUMBER
2. PART DESCRIPTION

Ref. No.	Part No.	Description	Ref. No.	Part No.	Description
1-1	57976	Straight stitch foot	5	57860	Zigzag needle plate for model 1786
1-2	57975	Standard zigzag foot		45747	Zigzag needle plate for model 1785
1-3	57977	Satin stitch foot		43164	Zigzag needle plate for model 1780
2-1	45686	Straight stitch foot for center needle position		45718	Zigzag needle plate for other models
	28567	Straight stitch foot for left needle position		6-1	45719
2-2	45727	Standard zigzag foot for 5.8 mm zigzag width models	6-2	57861	Straight stitch needle plate for model 1786
	43872	Standard zigzag foot for 7.0 mm zigzag width models		45747	Straight stitch needle plate for model 1785
2-3	45729	Satin stitch foot for 5.8 mm width models		43165	Straight stitch needle plate for left needle position except models 1785 and 1786
	43777	Satin stitch for for 7.0 mm width models			
3	44999	Spool pin			
4	55503	Spool pin cap			

Ref. No.	Part No.	Description	Ref. No.	Part No.	Description
7	43166	Darning plate for 7.0 mm width models		28771	Pattern cam No. 32
	45870	Darning plate for 5.8 mm width models		28763	Pattern cam No. 34
8-1	58232	Buttonhole guide plate for model 1786		28766	Pattern cam No. 36
8-2	55511	Buttonhole guide plate for other models		34769	Pattern cam No. 38
9	45195	Buttonhole template No. 1		34770	Pattern cam No. 39
	45196	Buttonhole template No. 2		28767	Pattern cam No. 40
	45197	Buttonhole template No. 3	13	28765	Pattern cam No. 41
10	58210	Buttonhole cover plate		28769	Pattern cam No. 43
11-1	57979	Buttonhole foot		28764	Pattern cam No. 44
11-2	43852	Buttonhole foot		28761	Pattern cam No. 45
12	43840	Built-in buttonhole guide foot		39000	Pattern cam No. 53
				43850	Pattern cam No. 56
1	57976	Straight stitch foot	14	6830	Buttnhole opener
2	57975	Standard zigzag foot	15	55501	Large screw driver
3	57977	Satin stitch foot		55500	Small screw driver
4	44999	Spool pin		55499	Magnetized mini screw driver
5	55503	Spool pin cap	16	35848	Lint brush
6	57861	Straight stitch needle plate	17	1939	Bobbin winder rubber ring
7	57860	Zigzag needle plate	18	6797	Light bulb
8	43166	Darning plate	19	6843	Q FOOT
9	58232	Buttonhole guide plate	20	6858	Q SET
10	45195	Buttonhole template No. 1	21	6886	Blind hem foot
	45196	Buttonhole template No. 2	22	6794	Hinged zipper foot
	45197	Buttonhole template No. 3	23	6888	Even-feeding foot
11	58210	Buttonhole cover plate	24	6895	Ruffler/pleater
12	57979	Buttonhole foot	25	6550	No. 9 needles
13	26844	Pattern cam No. 4		6551	No. 11 needles
	26845	Pattern cam No. 5		6552	No. 14 needles
	26847	Pattern cam No. 7		6553	No. 16 needles
	26848	Pattern cam No. 8		6554	No. 18 needles
	26849	Pattern cam No. 9		6746	Q NEEDLE
	26850	Pattern cam No. 10		6749	Double needle
	26851	Pattern cam No. 11		6862	10 metal bobbins
	26852	Pattern cam No. 12		6868	10 plastic bobbins
	26858	Pattern cam No. 18		43780	Needle threader
	26862	Pattern cam No. 22	26	6889	Oiler-brush combination
	26863	Pattern cam No. 23	27	6842	Accessory set (not shown) for cording, binding, attaching braid and zippers, shirring, quilting incl. Q SET
	26864	Pattern cam No. 24	28		
	26866	Pattern cam No. 25	29		
	26867	Pattern cam No. 26			
	26868	Pattern cam No. 27			
	26869	Pattern cam No. 28			
	28772	Pattern cam No. 30			
	28762	Pattern cam No. 31			

## BUTTONHOLE MAKING - USING BUTTONHOLE ATTACHMENT

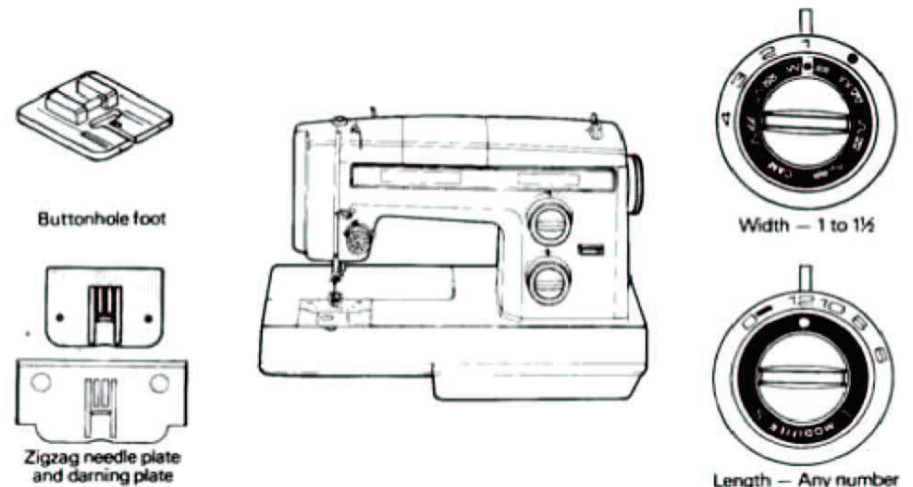

### PROCEDURE

1. Raise needle to its highest position and raise presser foot. Remove accessory box and bobbin cover plate.

Insert buttonhole cover plate at 45 degree angle and snap into place.

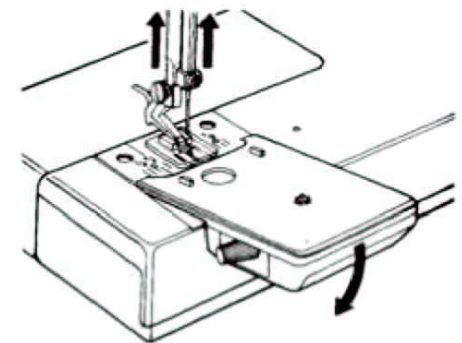

2. Select correct template for type buttonhole you want. Insert template into slot of guide plate. Turn template advance knob to desired size.

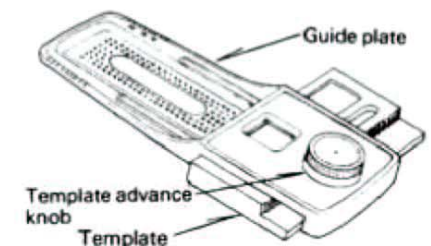

## HINTS ON SEWING DIFFERENT FABRICS

The chart below provides many details but you'll also want to remember...

•Soft fabrics may need backing – especially where stitches are close together.

•In sewing knits, if you can't match fabric and thread exactly, use the strongest fine thread available and use a Q NEEDLE.

•When working on tweed – or other multi-colored bulky fabrics – use one color thread on bobbin, another on top. (Great for repairs – the "patch" practically disappears!)

FABRICS	USEFUL STITCHES TO USE	SPECIAL NOTIONS TO USE
NYLON TRICOT	Serging Stitch Overcast Stretch Elastic Stretch (for sewing on elastic) Feather Stretch Blind Hem Mending Stitch	Q NEEDLE™ Polyester, nylon or dacron core thread Q FOOT™
TERRY CLOTH REGULAR CORDUROY	Simple Zigzag Mending Stitch	Mercerized Thread Size 14 needle
TERRY CLOTH STRETCH	Simple Zigzag Mending Stitch Serging Stitch Overcast Stretch Serging Stretch	Mercerized thread Polyester, nylon or dacron core thread Q NEEDLE™ Q FOOT™
LEATHER	Straight or simple Zigzag	Mercerized or silk thread Size 14 needle ½ pressure on presser foot Even feed foot
STRETCH KNITS FOR SWIMWEAR AND SKI WEAR OR GIRDLES	Serging Stretch Overcast Stretch Elastic Stretch Feather Stretch Mending Stitch Scallop Stitch	Polyester, nylon or dacron core thread Q NEEDLE™ Q FOOT™ Lace seam tape Pre-shrunk zippers

## SETTING UP YOUR MACHINE

1. Install your Kenmore sewing machine in a Kenmore cabinet, case or set the machine on a sturdy flat surface.
2. Your Kenmore sewing machine has been thoroughly oiled at the factory. Be sure to wipe off the needle plate area and bed plate carefully before sewing a garment. It is wise to practice on a scrap of fabric so any surplus oil is absorbed.
3. **FOOT CONTROL**  
Plug foot control into machine receptacle. Then connect cord into any 110-120 volt A. C. wall outlet.
4. **LIGHT/POWER SWITCH**  
Your machine **will not operate** unless the light/power switch is turned on. Turning on the power automatically illuminates the whole stitching area. If you're interrupted or stop sewing, turn off the light/power switch.
5. **SPOOL PINS AND CAPS**  
You will find spool pins and caps in the accessory box. Using a screw driver, attach spool pins at rear as indicated. Place spool of thread on the spool pin and cover with cap for smooth supply of thread.

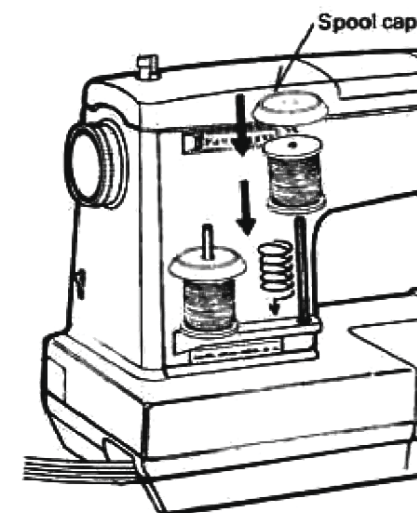
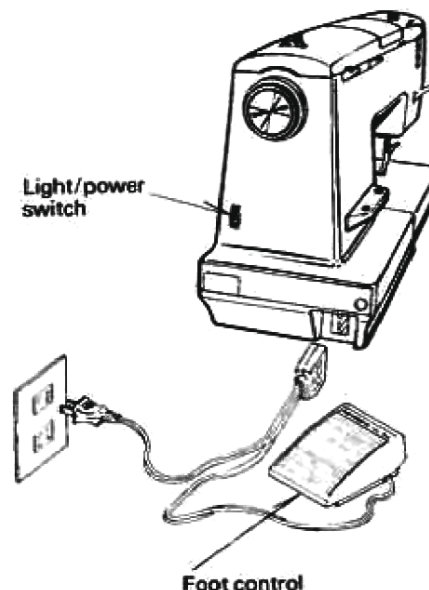

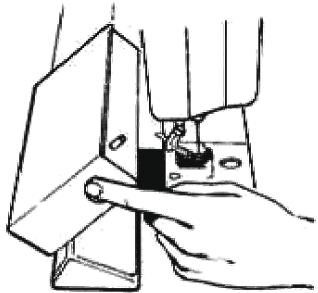

**CONVERTING TO FREE-ARM SEWING**

This machine easily converts from a flat-bed to a free-arm machine for easy handling of awkward, hard-to-reach sewing tasks. To convert to free-arm, push Release Button, swing base up and away.

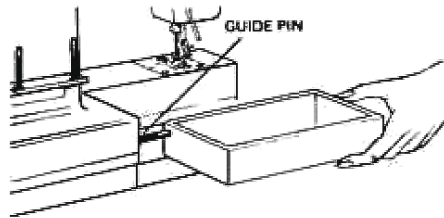



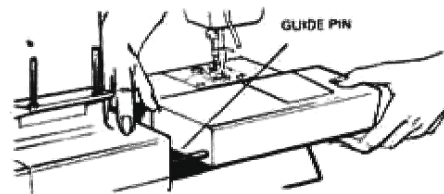

**REMOVING BASE IF SPACE IS NEEDED**

To slip the base off, swing the base away and pull it to the left. To replace base, insert Guide Pin into position and swing base down toward you, until it snaps in place.



**FOR MODELS WITH BASE RELEASE BUTTON**

To slip off the base, push base release button, pull base to left. To replace base, insert Guide Pin into position and swing base down toward you, until it snaps in place.

 <b>SMOCKING STRETCH</b>	<p>A decorative stitch for use on children's clothing, lingerie, yokes of blouses, dress bodice.</p>
 <b>ELASTIC STRETCH</b>	<p>Use to apply elastic to top of lingerie or to repair ready-made lingerie and replace or restitch elastic.</p>
 <b>SERGING OR PINE LEAF</b>	<p>Use for overcasting fabrics that ravel or fray easily... and for seams that need a great deal of stretch (i. e. swimwear, other sportswear, girdles). Also good-looking!</p>
<p><b>"Everyday" Stitches with Stretch Applications</b></p>	
 <b>PLAIN ZIGZAG</b>	<p>Use for all-purpose stretch sewing, seam finishing, edge finishing, or attaching stretch laces.</p>
 <b>SHELL STITCH</b>	<p>A good finishing stitch for nylon tricot lingerie.</p>



## GETTING THE MOST FROM FABRICS THAT GIVE

### Some stretchy suggestions...

Be sure to use the Q SET™ with knits and any synthetic woven fabric — and zigzag or satin foot as required.







Loosely constructed knits sometimes catch over toes of presser foot. To remedy this, wrap short strip of transparent tape around the foot encasing both toes.

To avoid tangled threads when working with knits, start seams carefully. Position fabric

and lower needle before lowering presser foot.

It is always a good idea to test thread tension and stitches on a scrap of the fabric being used.

Knits contain more yarn than woven fabrics, so you will need to take greater care to keep your machine clean specially in feed dog and bobbin case area.

WHERE TO USE WHICH STRETCH STITCH: A CHECK-CHART	
A few of the most popular cams for stretch	
SPECIAL CAM STITCH	MOST FREQUENT USES
 MAXI-STRETCH CAM 38	Good for mending tears, overcasting seam edges that ravel or joining two edges that overlap, like darts in interfacing. Great for mending worn shirt collars on inside so stitches won't show outside.
 OVEREDGE STRETCH — CAM 56	Use on sportswear where ½" seams are required. Makes and finishes seams at same time.
 FEATHER STRETCH — CAM 40	Use with laces, on lingerie, bar and girdles; and to apply bias tape. It's great when quilting.
 SCALLOP STITCH — CAM 10	Can be used for attaching girdle panels and applying stretch laces.
Built-in stitches specially for stretch	
 STRAIGHT STRETCH	Use on stretch and knit fabrics and to repair ready made garments at stress points. Basic stitch for all garment seams requiring "give" (i. e. armholes, crotch area, etc.). Use also to sew center seam of men's neck ties and seams cut on the bias.
 RICK RACK STRETCH	A basic multi-purpose stretch stitch with same usage as zigzag stitch, especially for lightweight stretch fabrics.

## WINDING THE BOBBIN

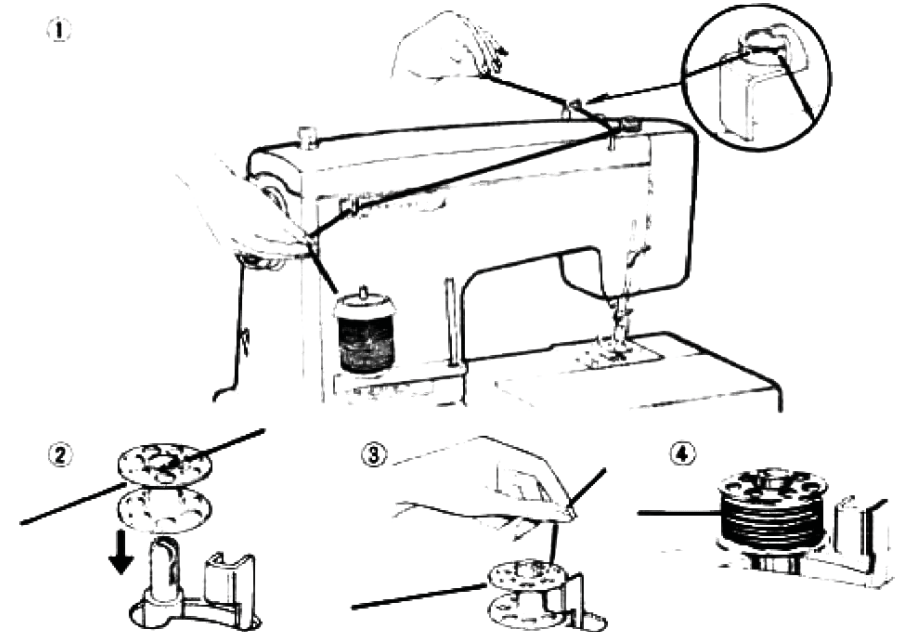

1. Place thread on Spool Pin and cover with a cap as shown above. To wind bobbin, draw thread from spool through Rear Thread Guides and the Bobbin Winder Tension Disc as indicated.
2. Pull end of thread through any hole in bobbin, place bobbin on Bobbin Winder Shaft with end of thread coming from top of bobbin as shown above.
3. Push Bobbin Winder Latch against bobbin until it clicks. Then pull Hand Wheel away from machine to disengage clutch (see diagram below). Hold end of thread coming from bobbin (see above) and step on foot control. After several rotations of bobbin release thread.
4. When bobbin is full, winding stops automatically. Push in Hand Wheel. Remove bobbin from shaft and trim thread end.

For best stitching results use clear plastic lightweight bobbins when stitching at high speed with widest and longest stitch setting.

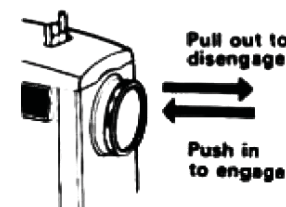

- \* Treat Hand Wheel as a "clutch" It controls the needle mechanism so that when pulled out (disengaged), the rest of the machine will not operate while the bobbin is being wound.

## THREADING THE BOBBIN CASE

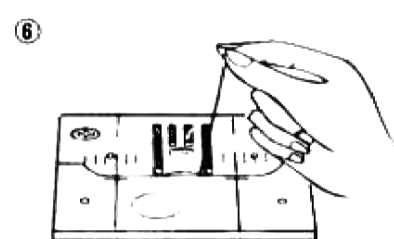
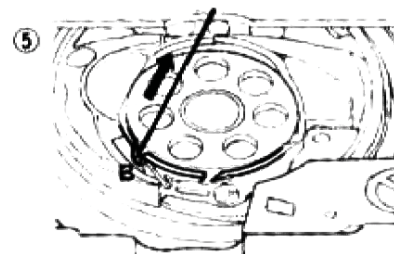
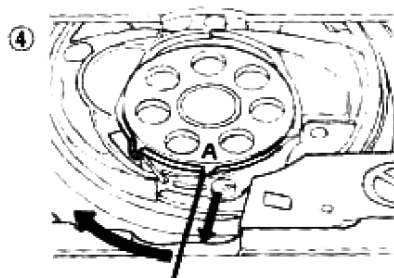
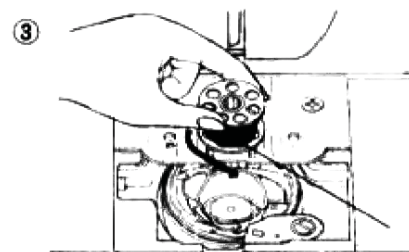
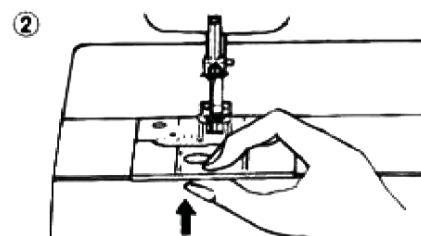
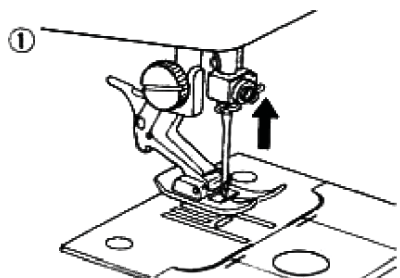

1. Raise needle to its highest position by rotating hand wheel toward you.
2. Remove bobbin cover plate by lifting up the front.
3. Insert bobbin into bobbin case making sure bobbin rotates counter clockwise.
4. Pull thread through slot (A) and then to the left.
5. Pull thread through slot (B) and leave about 4 inches of thread.
6. Replace bobbin cover plate allowing thread to emerge through slot in needle plate.

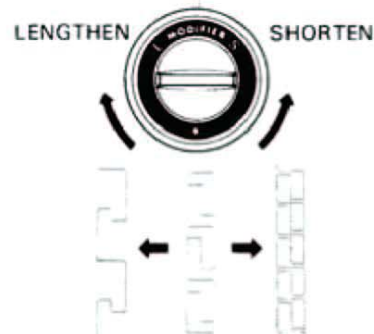

## STRETCHING OR SHORTENING DESIGNS

You can modify green cam designs — and change their looks impressively. Try squeezing them up... then stretching them out... all you need to do is turn the Stitch Modifier (inside the Length Control) slightly.

To shorten design, turn Stitch Modifier control toward "S"... to lengthen, turn toward "L".

## APPLICATIONS

You may get the look and feel of hand embroidery infinitely faster and easier on your Kenmore—thanks to your pattern cams. Just choose which of the designs you want to sew alone or in combination with each other.

Create the loveliest of custom designs—your own personal touch. There is much you can do by adjusting stitch width or length. Below you see some applications and variations. You'll find many more design ideas as you become more expert.



Orange cam 10 design on collar



Orange cam 5 on narrow hem

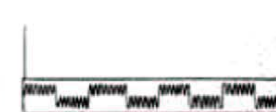

Orange cam 9 on bias tape

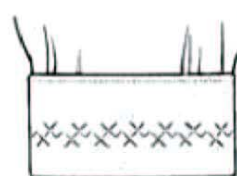

Green cam 36 on sleeve

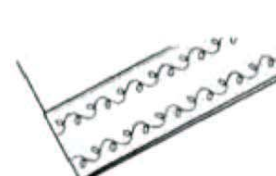

Green cam 41 on pillow



Orange cam 10 and 4 in combination



Variation of width of orange cam 4



Variation of both width and length of green cam 32

## DESIGNING WITH GREEN PATTERN CAMS

Look at the attractive designs shown below. They go both forward and backward – and your machine does all the hard work with

these special cams. Your friends may think you've mastered magic when you use these designs on gifts.

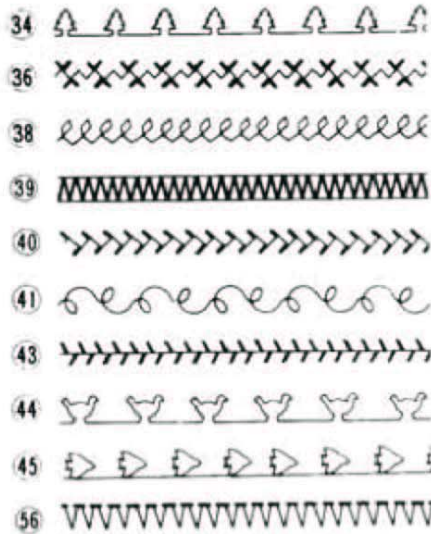
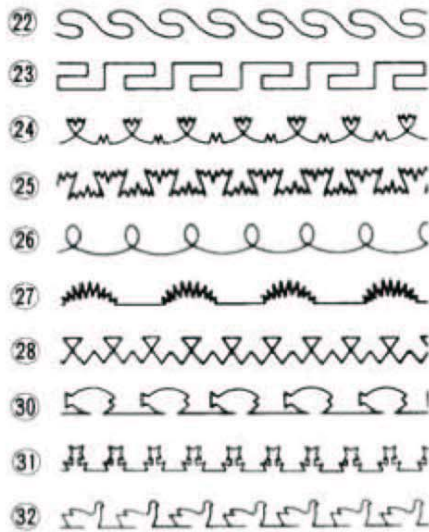

## THREADING TOP THREAD

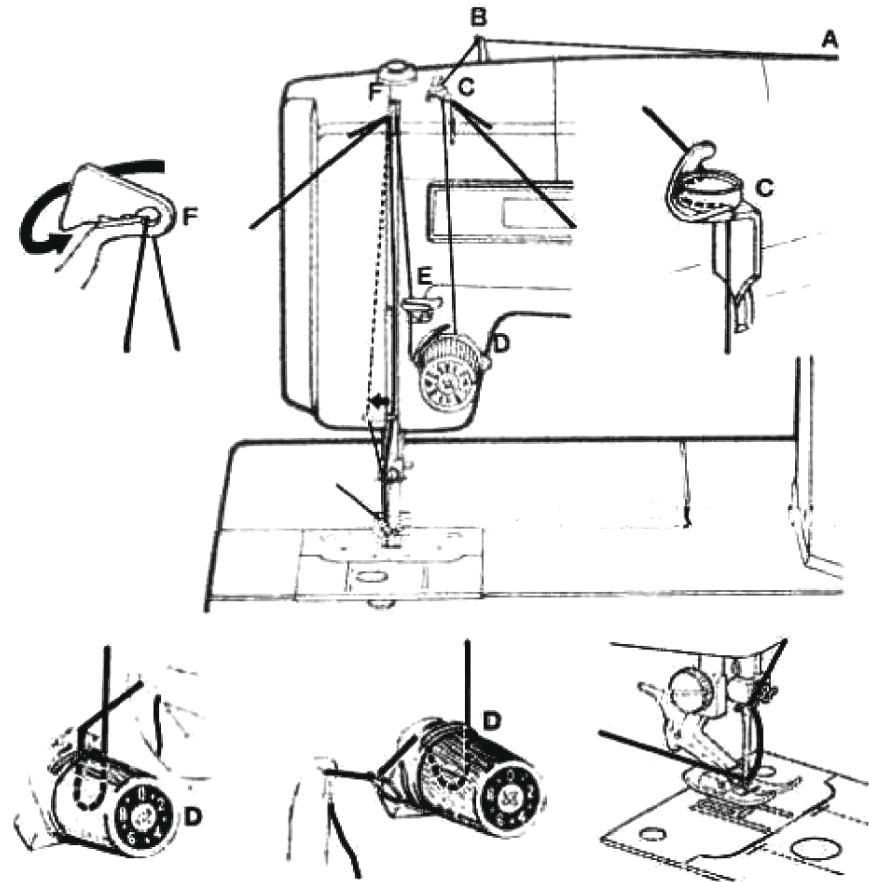

1. Raise thread take-up lever to its highest position by turning hand wheel toward you. Raise presser foot lever. Place thread spool on spool pin. Place spool cap over the spool.

Draw thread through rear thread guides A, B, and C. Pull thread through the tension discs D. Pull the end of the thread taut with the left hand. This will pull the spring wire up and past the end of the

hook, D. The thread will then slip into the hook when the spring is released.

2. Draw thread up through thread guide E, take-up lever F and down through lower thread guides to needle.
3. The needle must be threaded from front to rear. Draw 3 to 4 inches of thread through the eye of needle.

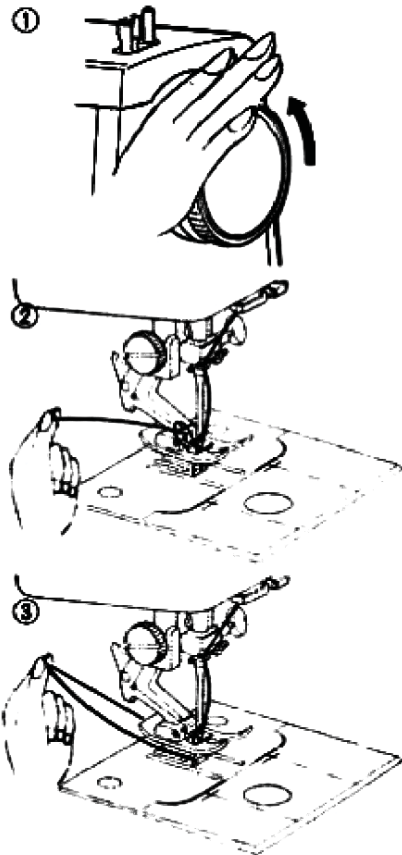

### PICKING UP BOBBIN THREAD

1. Raise presser foot lever. Hold needle thread loosely in left hand and rotate handwheel toward you one complete turn.
2. Bring bobbin thread up by pulling upper thread.
3. Pull both threads under and to the back of the presser foot, leaving 3 to 4 inches of thread clear.

If you can not pick up bottom thread by following above steps, then check:

1. Is thread through needle?
2. Is thread tangled around needle?
3. Is there 3 to 4 inches of thread coming out of bobbin case?
4. Is thread from bobbin case tangled?

### INSERTING A CAM

Raise Cam Holder Cover and place cam in Cam Holder while pushing Cam Lever to the right. Just be sure the retaining pin in the cam holder enters one of the holes in the cam. Push down as far as possible.

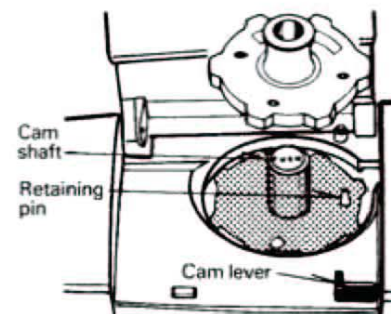

### REMOVING A CAM

Just push down on the cam shaft with left hand, and push cam lever to the right with right hand. The cam will pop up for removal.

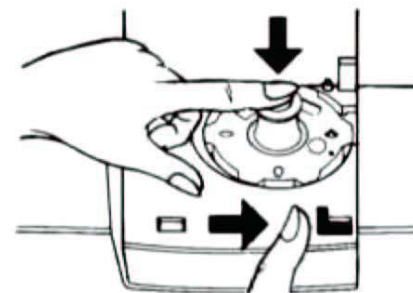

### STARTING A PATTERN AT ITS BEGINNING

Align the engraved dot on the cam as close as possible to the cam follower. You're ready to sew.

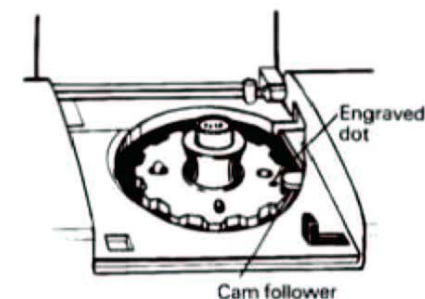

### TIPS ON DESIGN STITCHING

1. Always make a practice design on a scrap of the fabric you plan to use.
2. Start with a full bobbin and plenty of thread on the spool to avoid running out of thread in the middle of your design.
3. Reduce the top thread tension slightly.
4. On a very soft fabric you may want to use a tissue paper backing or organdy that can be cut away.

## DESIGNING WITH ORANGE PATTERN CAMS

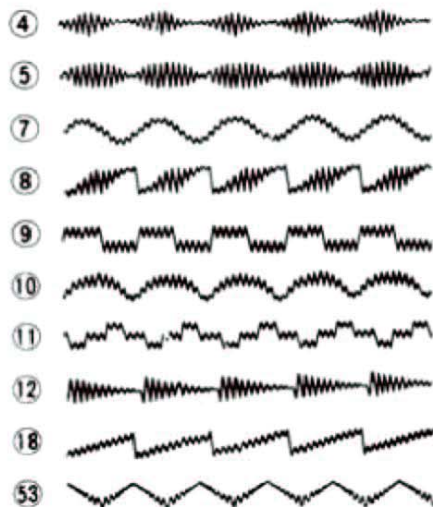

You can sew beautiful decorative patterns with your cams. These are numbered for easy selection.

Here you see basic decorative designs that you can do with your pattern cams. Think of these as "trim" for collars, cuffs, even waistbands or belts... and for making pillowcases, towels, other super-special "domestics"!

## ■ CONTROLS

### THREAD TENSION CONTROL

#### STRAIGHT STITCHING

The good looking appearance of your straight stitching is mainly determined by the balanced tension of the top thread and bobbin thread. The tension is well balanced when the two threads lock in the middle of the layers of fabric when straight stitching.

You can achieve balanced tension by regulating the Top Thread Tension Control. If the upper thread appears to be too **tight**, turn counter clockwise (lower numbers) to **decrease** tension. If the upper thread is too **loose**, turn clockwise (higher numbers) to **increase** tension.

#### ZIGZAG STITCHING

Always practice stitching on two layers of the fabric you will be using.

Make sure that you are using the right size and type of needle for the fabric.

Choose a thread of good quality and type for your fabric.

Remember – the wider the zigzag setting, the more chance for puckering. Reduce the top tension, if puckering occurs.

The **top** thread will be visible on the bottom to varying degrees depending on the thread, fabric, type of stitch being used and speed of sewing.

The **bobbin** thread should **never** be visible on the top of the fabric.

#### BOBBIN TENSION

The bobbin tension has been correctly set at the factory, so you do not need to adjust it.



Decrease tension



Increase tension

### STITCH WIDTH CONTROL

This control regulates the width of the stitch you select. THE HIGHER THE NUMBER THE WIDER THE STITCH. You may vary your zigzag stitch width by adjusting this control to the setting you desire. Turn only the **outer rim** of this control to set the stitch width.

This control must be on Orange Dot in order to do straight stitching.

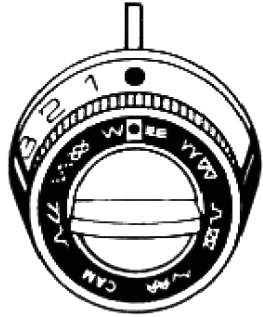

### STITCH LENGTH CONTROL

The stitch length control regulates the length of the stitch you select. THE HIGHER THE NUMBER THE SHORTER THE STITCH. Turn only the **outer rim** of this control to set the stitch length.

The number on stitch length control indicates the approximate number of stitches per inch. The stitch setting you use will be determined by the thickness of the fabric you are sewing.

A longer stitch setting should be used for thicker fabric or more layers of fabric. The middle range of the control is the 10 - 12 stitch per inch range which is the most commonly used.

A basting stitch is made by using the longest possible stitch setting - 6 stitches per inch.

The orange zone  on the control is the setting used for the shortest stitches such as in Satin Stitching.



### FEATHER STRETCH

Special Stitch Dial -   
Special Stitch Modifier - GREEN DOT

This is a good stitch to use with laces, on lingerie, bra and girdles; and to apply bias tape. It's great when quilting.

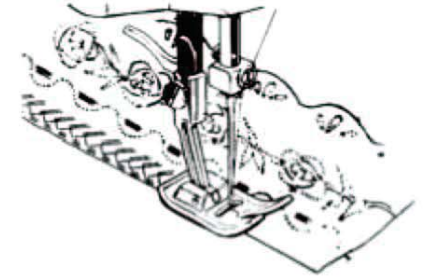

### FISH-BONE STRETCH

Special Stitch Dial -   
Special Stitch Modifier - GREEN DOT

This stitch is very useful for sewing on flat and most resistant material, and for hemming on jeans and working wear.

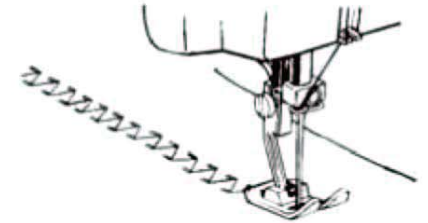

### OVEREDGE STRETCH

Special Stitch Dial -   
Special Stitch Modifier - GREEN DOT

Use on sportswear, swimwear and skiwear where 1/4 seams are required, It makes and finishes seam at the same time.

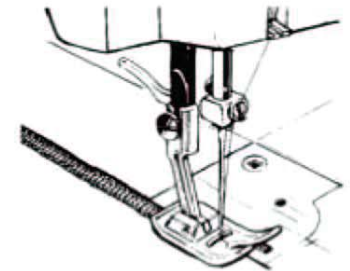

### SLANT OVERCAST STRETCH

Special Stitch Dial -   
Special Stitch Modifier - GREEN DOT

Use for repairing underwear and finishing fabrics that ravel.

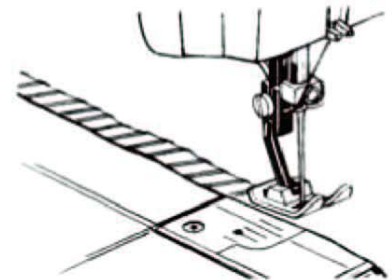

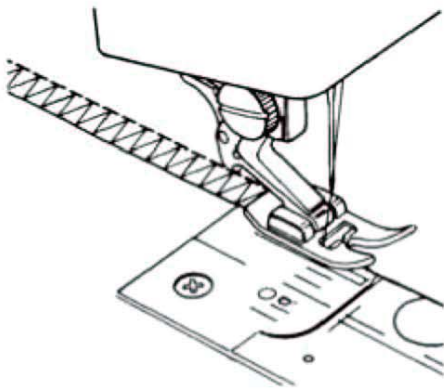

### OVERCAST STRETCH STITCH

This is the same type stitch used by the garment industry in making sportswear—it forms and finishes the seam in one operation (for seams of  $\frac{1}{4}$ " to  $\frac{3}{8}$ "). It's very effective for use in repairing raw or worn edges of older garments.

Note: To sew overcast stretch stitch in the opposite direction, use serging (or pine leaf) stretch stitch.

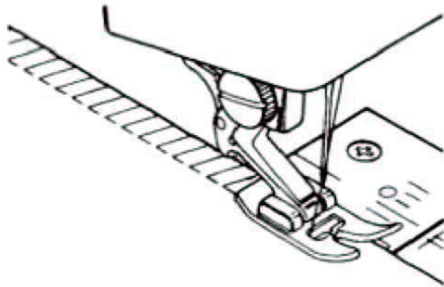

### SERGING (OR PINE LEAF) STRETCH STITCH

Great in making elastic swimwear—as well as for overcasting a neat edge on seams. It's equally useful with woven and knitted fabrics. Tension may need to be tightened to achieve desired look.

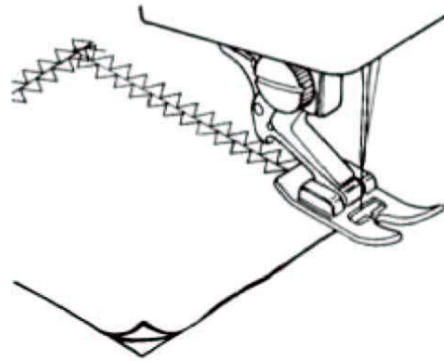

### PATCHING STRETCH STITCH

If the kids keep "busting out" elbows or knees... if someone burns a hole in expensive knits... this recipe will save you big money! It can be decorative, too — When you want patches to show!

### SPECIAL STITCH DIAL

There are certain types of stitches that are used more often than others in your garment construction. Because of their frequent use, you will soon realize the convenience offered to you by this control. All of the stitches that are made by this machine are illustrated on the stitch selector dial. You can obtain your desired stitch by simply turning the stitch selector dial.

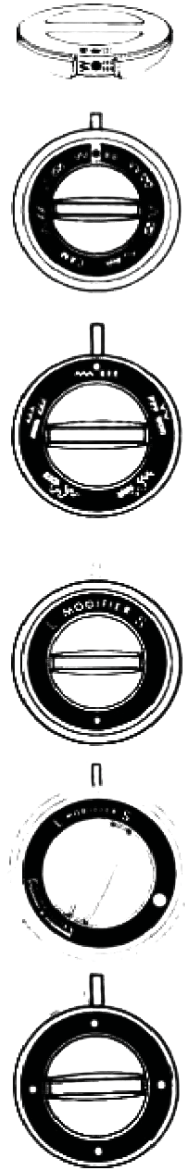

### STITCH MODIFIER

This regulates the special movement of fabric backward and forward necessary when stretch stitching and designing with green cams. For all normal sewing other than these stitches it should be set at orange dot.



### REVERSE STITCH LEVEL

It is best to begin and end seams with a few stitches taken in reverse. This is called back tacking. Back tacking fastens the ends of the seams firmly and prevents raveling.

When reverse stitching is needed, turn the control clockwise and hold there during sewing. The fabric will immediately start feeding backwards and seam will be fastened.

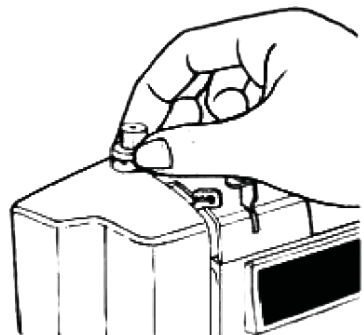

### PRESSURE REGULATOR

Push down the outer ring of the pressure regulator. This will release the pressure on the presser foot. To increase the pressure, push down inner pin until a suitable pressure is obtained.

Insufficient pressure may cause poor feeding of the fabric, skipped stitches, or difficulty in guiding the fabric. If feed dogs or presser foot marks appear on the fabric, reduce the pressure.

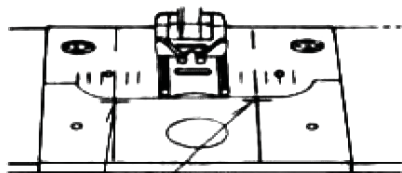

### SEAM GUIDES

Seam guides are printed on needle plate, at both sides of needle, to help you line up the fabric and keep it straight. The standard seam width is 5/8". So these lines are emphasized, easy to follow.

Also the cross lines are "cornering guides" to help when turning a square corner 5/8" from the fabric edge. (For details on cornering, see page 15.)

Cornering Guide

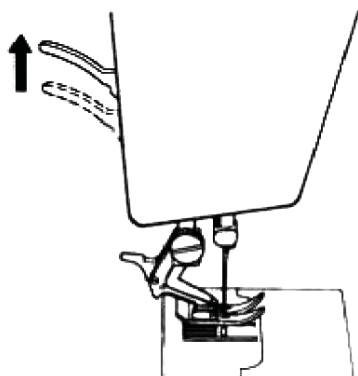

### PRESSER FOOT LEVER

Presser foot lever has a two position lift. In order to place heavy fabric under the presser foot or to change the presser foot raise the presser foot lever to its maximum upward position as shown.

### STRAIGHT STRETCH STITCH

You may use either a zig zag or straight stitch foot BUT -- for best control of fabric, best looking straight stitches and best feeding of fabric use **Straight Stitch Foot** and **Straight Stitch Needle Plate**.

Use this stretch stitch with knit or synthetic fabric. Sew as you do with regular straight stitch.

This is also a good stitch to use on curved seams regardless of the type of fabric. Any seam that will receive a great deal of strain when worn should be sewn with the stretch stitch. Use in children's shorts and slacks as well as adult sports clothes.

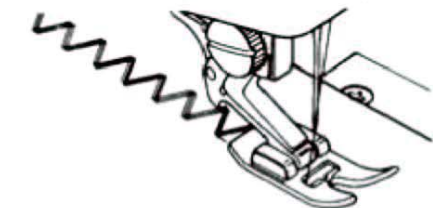
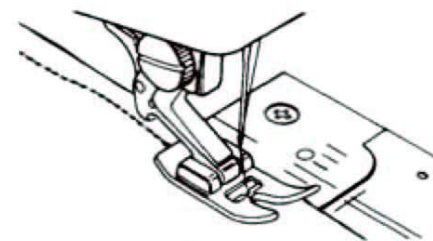

### RICK-RACK STRETCH STITCH

Sew on stretch fabrics in any area that you might use a zig zag stitch. This stitch can be used as a decorative top stitch as well.

It is useful also on lapped or abutted seams where you lap one edge of a seam over another with seamlines meeting in the center.

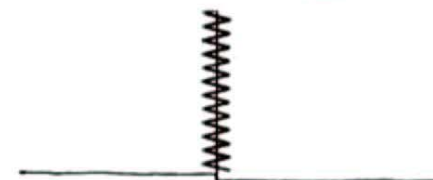

### SMOCKING STRETCH STITCH

1. Make a straight line of gathers across the fabric that you wish to smock.
2. With a narrow strip of fabric directly under the line of gathering, stitch over the gathers. The design will be a series of small diamonds.

Note: When smocking a garment, the stitching should be done before the piece is sewn into the garment.

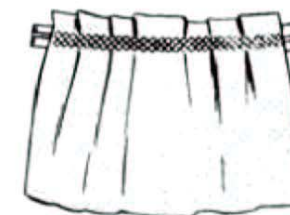

### ELASTIC STRETCH STITCH

Use this versatile stitch to insert elastic in garments. Simply stitch elastic into place, making sure it is evenly spaced. To do this, mark the correct length piece into quarters, then match these markings with center front and side seams.

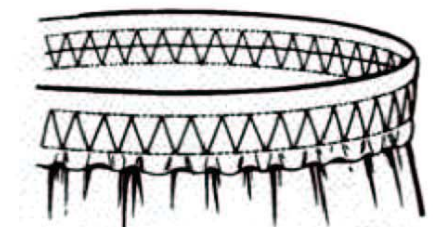



## STRETCH STITCHES

The stitches shown at right are all for use with stretch and knit fabrics. These are special stitches built into the machine for your quick selection.

\* Available on model 1690 only.

## ADJUSTING STITCH LENGTH \*\*

Depending upon your preference in stitch patterns, you may make stretch stitches closer together without changing the balance of stitches by turning stitch length control to higher numbers up to "12".

\*\* This feature is available on model 17860, 17861 and 17862 only.

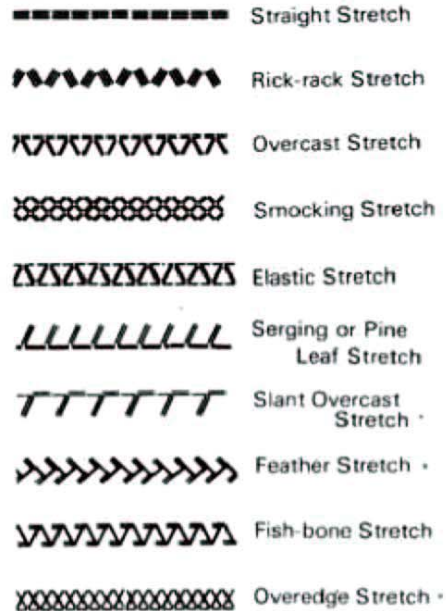

## ADJUSTING STRETCH STITCH BALANCE

Stitch modifier should be in notched position between S and L for most materials. Depending upon the type of fabric used, you may need to adjust this control to match forward stitches of stretch sewing with reverse motion stitches. To shorten stretch stitches, turn the modifier slightly toward "S" ... to lengthen, turn toward "L".

## RECOMMENDATION

1. It is recommended you use the Q set for sewing knit and woven synthetic fabrics.
2. It may be necessary to use an interfacing or backing when sewing very soft and thin knits or woven synthetic fabrics.

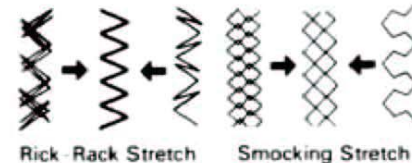
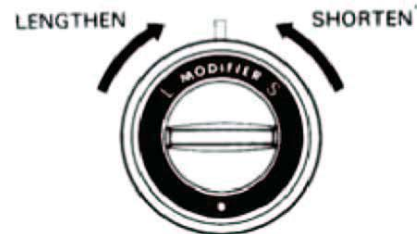

## ACCESSORIES

### NEEDLES



Use KENMORE needles. The size of the needle should conform with the size of the thread and both should be suitable to the fabric. Kenmore needles are color-coded by size for your convenience.

Never use a bent needle or one with a dull point.

The exact length of your needle is shown at left. Be sure you never use one in your machine that is not this exact length.

You will find among your accessories a "Q-NEEDLE" with blue shank. This special needle is to be used when sewing knits and certain difficult synthetic fabrics. If you experience **skipped stitches** in any of your sewing, use "Q-NEEDLE" and "Q-FOOT" \*.

\* Available at most Sears retail stores and catalog.

## NEEDLE, THREAD AND FABRIC CHART

FABRIC	NEEDLE SIZE AND COLOR	THREAD SIZE	RECOMMENDED STITCH LENGTH SETTING
<b>LIGHTWEIGHT:</b> Batiste, Dimity, Chiffon, Silks, Synthetic Jerseys, Fine Lace, Organza, Crepe, Taffeta, Voile, Organdy	9 BROWN or 11 ORANGE	Polyester Core/Cotton Wrap Fine Mercerized Cotton Silk A	12 stitches per inch
<b>MEDIUMWEIGHT:</b> Cotton, Cotton Blends, Percale, Gingham, Shantung, Pique, Seersucker, Satin, Knits, Vinyl, Suitings, Linen, Wool Crepe, Leather	14 RED	Polyester Core/Cotton Wrap 50 Mercerized Cotton Silk A	10 to 12 stitches per inch
<b>MEDIUM HEAVYWEIGHT:</b> Corduroy, Denim, Wool, Sailcloth, Wool Flannel, Gabardine, Velvets, Leather	14 RED or 15 PURPLE	Polyester Core/Cotton Wrap 50 Mercerized Cotton Mercerized Heavy Duty Silk A	8 to 10 stitches per inch
<b>HEAVYWEIGHT:</b> Coatings, Upholstery, Cotton Duck, Heavy Twills, Canvas	18-GREEN	Polyester Core/Cotton Wrap Heavy-Duty Mercerized Cotton Polyester Synthetic Silk A	8 stitches per inch
Decorative top-stitching on all types of fabric	16-PURPLE 18-GREEN or Q-BLUE	Buttonhole Twist	6 stitches per inch
<b>Synthetic Knits and Stretch:</b> Polyester Double Knits, Nylon Tricot, Jersey, Stretch Terry, Spandex, Crepe Tricot	Q-BLUE with "Q-FOOT"	Polyester Core/Cotton Wrap 50 Mercerized Cotton	10 for Regular or 6 for Stretch Stitches

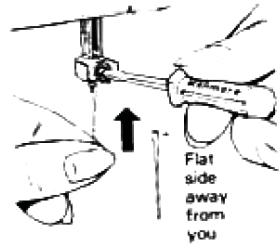

## CHANGING NEEDLE

Raise needle bar to its highest position by turning the hand wheel toward you. Loosen the needle clamp screw. Holding the needle with the flat side away from you, slip the needle into the needle bar. When it is in as far as it will go, tighten the needle clamp screw with small screwdriver provided in the accessory box.

## PRESSER FEET

This machine is supplied fitted with a zigzag presser foot for general sewing purposes. In the accessory box are the following additional presser feet:

1. Straight stitch foot
2. Satin stitch foot
3. Buttonhole foot
4. Built in buttonhole guide foot
5. Zipper foot

## CHANGING PRESSER FEET

Make sure needle is in the up position. Raise presser foot lever.

### Snap-on presser feet

1. Raise foot release lever to remove the foot. (Fig. 1)
2. Place desired foot on the needle plate aligning needle holes. Lower the presser foot lever so that foot holder snaps on the foot. (Fig. 2)

### One-piece presser feet (Fig. 3)

1. Loosen presser foot thumb screw and remove the foot holder.
2. Insert desired foot from the left. Lower the presser foot lever and tighten the screw using the large screw driver to make certain the foot is secure.

### For machines with presser foot lock (Fig. 4).

To change presser feet, simply drop Presser Foot Lock and slip foot away from the Presser Bar. Raise Presser Foot Lever beyond the normal up position and place new foot on presser bar. To lock foot securely, raise presser foot lock as high as possible.

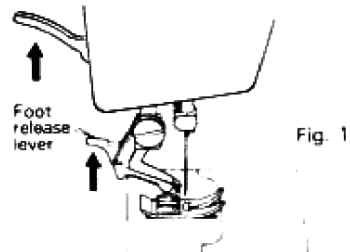

Fig. 1

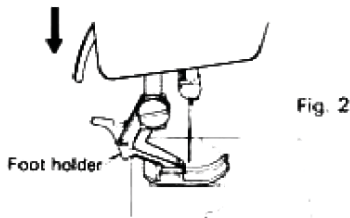

Fig. 2

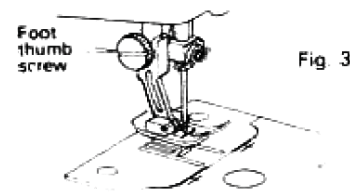

Fig. 3

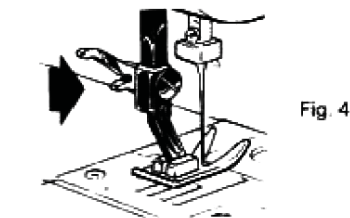

Fig. 4

## SHELL STITCHING

### PROCEDURE

This shell stitched edge is a popular finish for lingerie and nightgowns. To achieve this multiple scalloped effect, allow needle to just clear the right edge of the fabric when it zigzags.

## BOX STITCH

### OVERLAPPED SEAM

Box stitch is ideal for producing flat overlapped seams on almost any type of fabric and a bolder effect will result from sewing with a contrasting thread.

Overlap the raw edges of two pieces of fabric 1/4" and pin or tack. Place the fabric right side up with the middle of the overlap under the center of the presser foot, so that the stitch sews just over the top and bottom raw edges.

## DECORATIVE EDGING

Turn the raw edge under 1/4" and press. Place the fabric right side up with the middle of the turnover under the center of the presser foot, so that the stitch sews on to the fold and just over the raw edge underneath.

## FAGOTING STITCH

### PROCEDURE

This is a popular decorative stitch (used in sleeves or fronts of blouses and dresses). To attach two separate pieces of fabric together, leave a little space inbetween. To prepare the fabric:

Fold under the seam allowances on the cut edges, and press. Baste folded edges to tissue paper with about 1/8" space between. Stitch over the 1/8" allowance, just catching the fabric fold on both sides with needle. Remove bastings and paper; press.

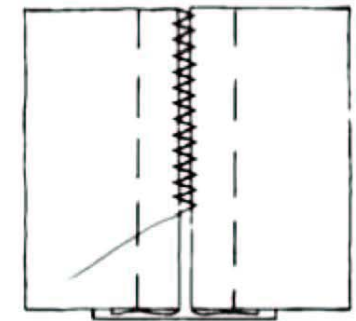
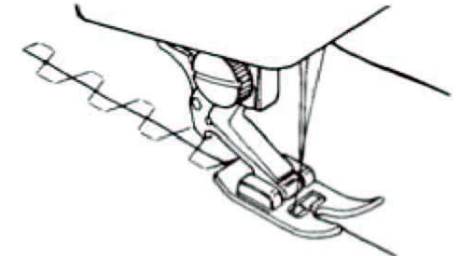
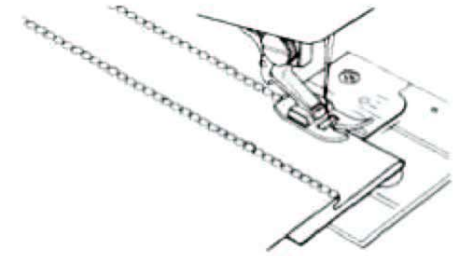

## BLIND HEMMING

For easier blind hemming it is recommended you use the adjustable blind hem foot, optional accessory item No. 6886. See Fig. 3.

### PROCEDURE



Finish edge of hem anyway you desire. Turn up hem appropriate width.



Fold garment away from hem leaving 1/8" of hem edge extending.

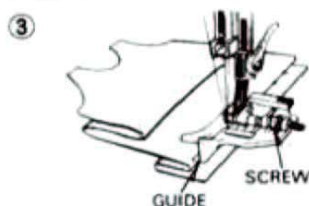

Place garment under presser foot in such a manner that straight stitches will be sewn on extended edge. The zigzag stitch should just catch the fold of the garment.

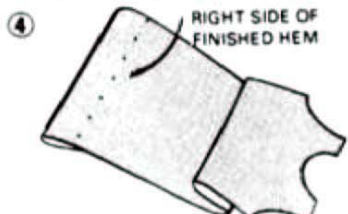

Press both sides of the finished hem. The right side of the garment will show only the blind stitches.

## MENDING AND OVERCAST STITCHING (THREE-STEP ZIGZAG)

### MENDING A TEAR

Stitch Length - Orange Zone

To repair a straight or three-cornered tear, position the tear under the needle in such a way that the stitching catches both sides of the tear. When mending a three-cornered tear, stitch from each end to the center. It is well to use a piece of fabric under the tear for reinforcement.

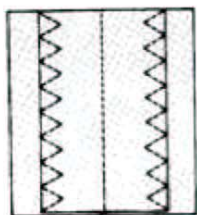
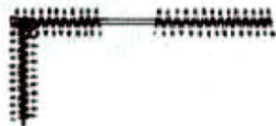

### OVERCASTING WITH MENDING STITCH

Stitch Length - 12 or higher

Three-step zig-zag is a strong stitch because, as its name implies, it takes three short stitches where normal zig-zag takes one. For this reason it is highly recommended for overcasting, i. e. finishing a raw edge, on all types of fabric.

## NEEDLE PLATES

You are provided with two needle plates:

- Needle plate with wide oval hole for all zigzag stitching.
- Needle plate with round hole for regular straight stitching and straight stretch sewing.



Fig. 1

## CHANGING NEEDLE PLATE

- Raise needle to its highest position and raise presser foot.
- Remove accessory box and bobbin cover plate.
- Remove needle plate by placing thumb under edge of plate and lifting up and out. (See Fig. 2)
- Place other needle plate making sure bobbin case is in position as shown in Fig. 3. Push it down with both hands to lock.
- Replace bobbin cover plate.

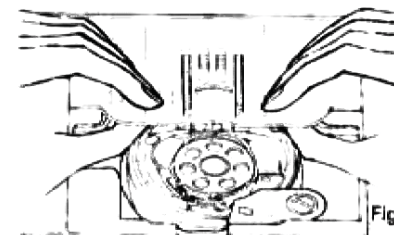
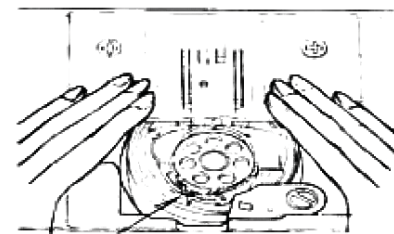

Fig. 2

**NOTE:** Don't turn hand wheel away from you while needle plate is removed, or needle may hit bobbin case and cause needle damage.



Bobbin case

Fig. 3

## DARNING PLATE

There are a few times when you want to control the feeding of the fabric yourself. Raise needle to its highest position and raise presser foot. Attach darning plate over needle plate aligning two pins of darning plate with holes of needle plate. You may then determine the movement of the fabric yourself.

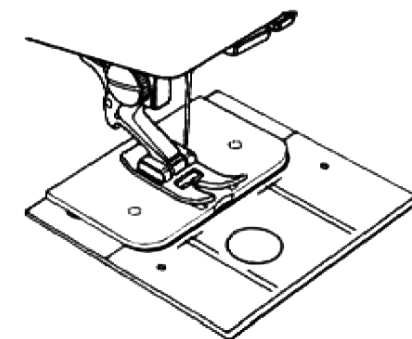

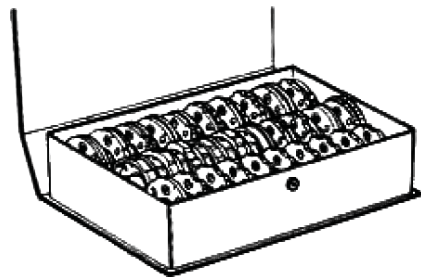

## PATTERN CAMS

When you open your Pattern Cams Attachment box you open a world of wonderful decorative designs. Thirty tiny discs to make your clothing and home accessories big fashion news. The best part is that your machine does the work... you get the compliments!

## BUTTONHOLE ATTACHMENT

Your buttonhole attachment is a Kenmore "special" that guides the fabric for you, eliminates the need to turn fabric by hand.

You will find following parts in your accessory box:

1. Buttonhole guide plate.
2. Three templates which give you a choice of buttonhole styles and lengths.
3. Cover plate with pinion gear.
4. Buttonhole foot.

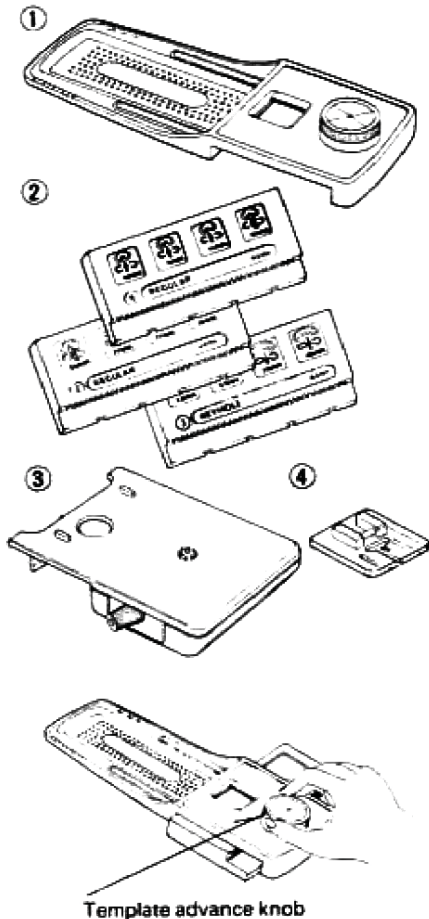

Template advance knob

Desired size of buttonhole is selected by turning template advance knob. Length of buttonhole appears in window on the top side of guide plate.

## APPLIQUEING

Settings same as Satin Stitching

Select an applique design to be applied to your garment and baste it in place. Satin stitch around the raw edge of the applique completely covering the edge. You may want to do this with a contrasting color of thread.

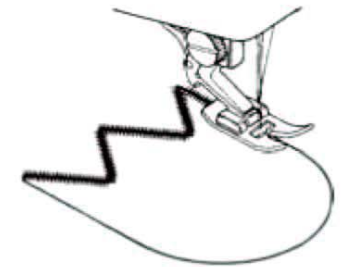

## BUTTON SEWING

Special Stitch Dial -  $\nabla$   $\bullet$   $\equiv$   
Stitch Width - Must be adjusted to Button  
Use Darning Plate.

1. Fix the button on fabric at desired position with clear tape.
2. Center the left hole of button between straight seamline and the left edge of needle slot of foot and lower foot to hold the button securely.
3. Turn hand wheel manually until needle point is just above button.
4. Adjust stitch width control so needle will enter right hole of the button.
5. Turn hand wheel again by hand so needle enters second hole. Readjust stitch width if necessary. Stitch a number of times.
6. Finish sewing with an extra two inches of thread remaining. Draw these threads to reverse side of garment and tie.

When sewing a flat button, place needle or pin between holes of button as shown to provide flexibility for buttoning.

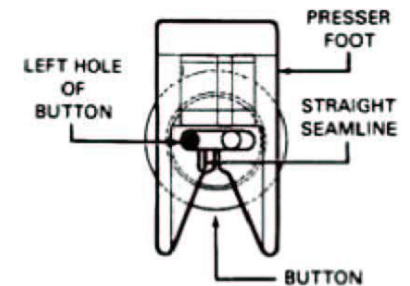
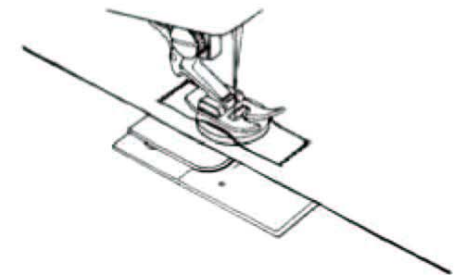

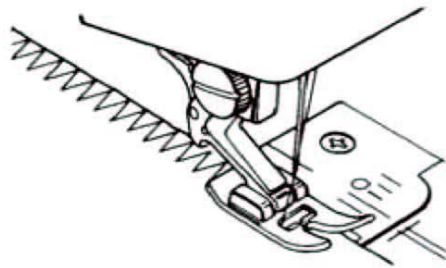

## OVERCASTING

This is one of the more frequently used zigzag stitches on garment construction. You may want to overcast along the raw edge of each seam allowance or fold the raw edge toward the garment and stitch.

Stitch so the needle pierces the fabric just short of the outside edge. Raw or worn edges of older garments can be overcast to prevent further raveling.

## SATIN STITCHING

Special Stitch Dial -  =  
 Stitch Width - 1 to 4  
 Stitch Modifier - Orange Dot  
 Stitch Length - Orange Zone  
 Satin Stitch Foot

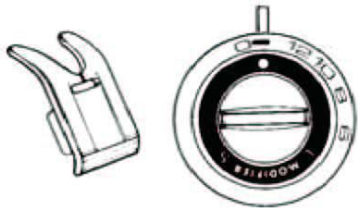

Closely-spaced zigzag stitches are called satin stitches. They add a lovely finishing touch to garments and linens – whether in simple sewing or super decorations with any of your pattern cams or embroidery designing. Use special **Satin Stitch Foot** which is “grooved” to permit dense stitching to pass under it easily.

**Important tips on satin stitching:** It's a good idea to **loosen** the tension of the **top** thread slightly. The wider the stitch, the looser the tension needed.

If you are stitching on a very soft fabric, use a backing of tissue paper or interfacing for a well-formed stitch. Also, this will prevent puckering and bobbin thread will not show on the right side of the material.

As with all special stitches, it's best to try it out on a remnant of your fabric.

## BAR TACKING

Settings same as Satin Stitching

This stitch is similar to a very short satin stitch and is used to reinforce points of strain such as corners of pockets and straps on lingerie.

Sew 4 to 6 zigzag stitches.

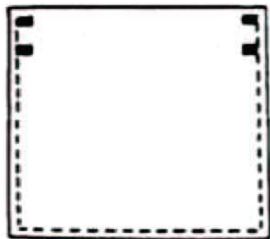

## CARING FOR THE MACHINE

### CLEANING THE FEED DOGS WITH A BRUSH

To insure the best possible operation of your machine, it is necessary to keep the essential parts clean at all times.

Remove bobbin cover plate and needle plate. Using a small brush, remove the lint that accumulates in and around the feed dogs and shuttle area.

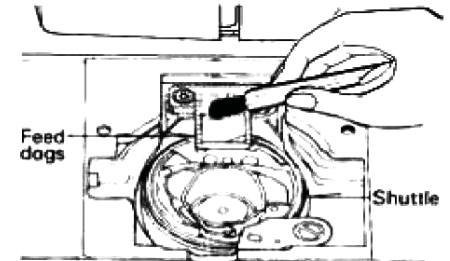

### CLEANING AND OILING SHUTTLE AREA

On rare occasions, you may want to clean the shuttle area. Just follow these simple steps.

1. Remove bobbin case by lifting it out from left side.
2. Clean the shuttle with small brush and put a drop of oil to the points indicated by arrows. Don't over-oil. (Reminder: don't use household oil... use sewing machine oil.)

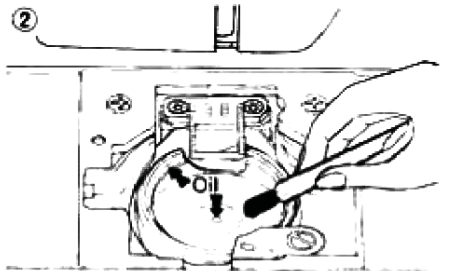
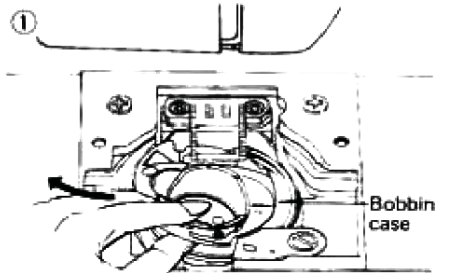

### REPLACING BOBBIN CASE

1. Insert bobbin case into shuttle from left side and turn it counter-clockwise until it stops.
2. Replace needle plate in position.

Note: Oil and lint brush No. 6889 is available at most Sears retail stores and catalog.

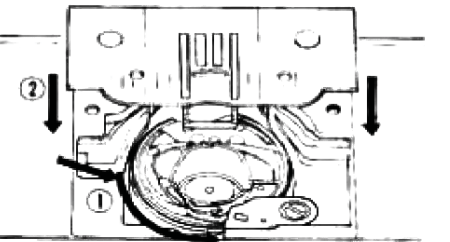

## OILING UNDER TOP COVER PLATE

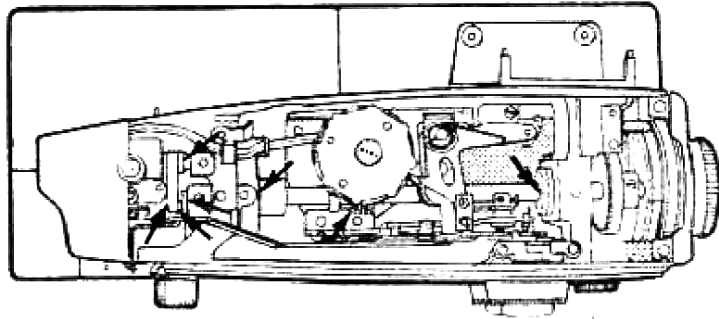

Remove top cover by inserting a screw driver between top cover plate and arm casting. Pry up on top cover plate. Then oil points indicated by arrows in top of machine head.

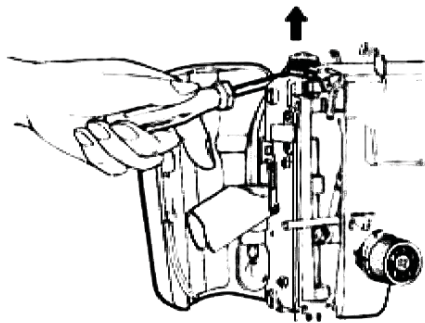

## OILING UNDERSIDE

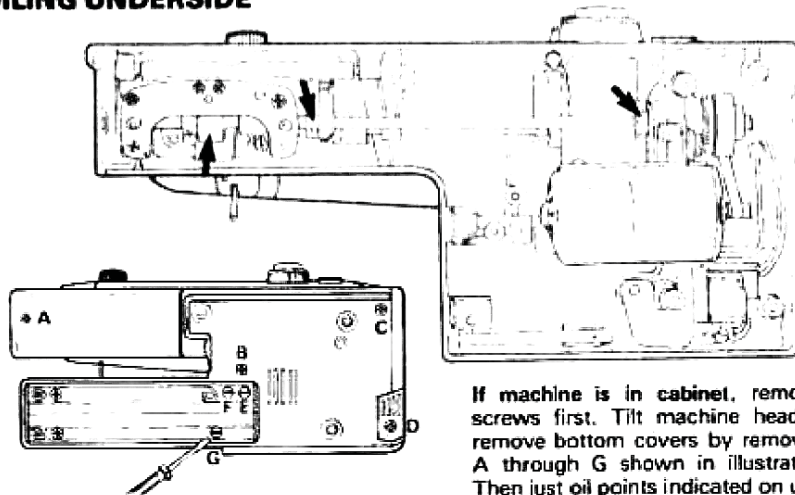

If machine is in cabinet, remove bottom screws first. Tilt machine head back and remove bottom covers by removing screws A through G shown in illustration at left. Then just oil points indicated on underside of unit as shown.

## ZIGZAG STITCHING

Simple zigzag stitching enables you to do many exciting things with your Kenmore sewing machine. Beyond basics, you'll use zigzag stitching to applique, embroider and monogram. Unlike straight stitches, zigzag stitches have a side-to-side width as well as a

stitch length. You'll find "recipes" for many zigzag operations on following pages. You can create an exciting variety of zigzag stitches by adjusting stitch width and length controls (see chart below).

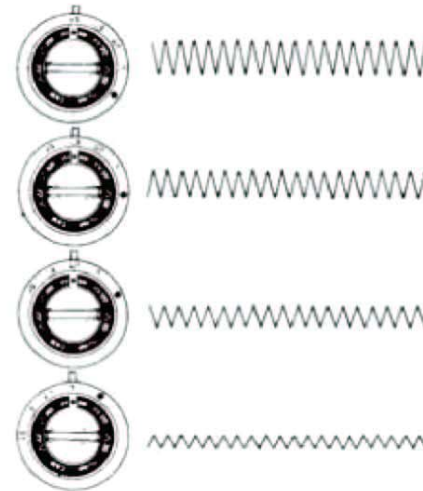

**Extra wide zigzag** for heavy fabrics or those that fray – set width at 4.

**Wide zigzag** for double layers, like hemming – set at 3.

**Medium zigzag** for most construction seams – set at 2.

**Narrow zigzag** for light fabrics, barely shows – set at 1.

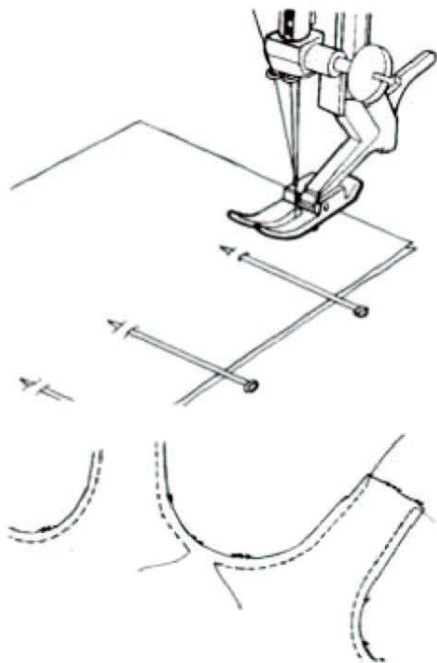

## TEMPORARY SEWING BY MACHINE

**No longer do you need to baste by hand!**

Basting by machine is easy – simply use **straight stitching** with longest available length setting.

### PIN BASTING

You can sew over pins easily (if done **correctly**) because your presser feet are hinged. Pins must be inserted at right angles to seam line. Tip of pin should just **touch** seam line. Sew over **tip** of pins. Pins must **not** come in contact with feed dogs: **Never** pin on the **under-side** of the fabric. Sew slowly. If in doubt about sewing over pins, **remove** each pin as you approach it.

### STAY-STITCHING

“**Stay-stitching**” is a form of temporary seaming that prevents stretching of **curved** edges of garments. Usually this is on a single layer of fabric, so reduce **top** thread tension slightly to prevent puckering. Baste about  $\frac{1}{4}$ ” away from intended seamline.

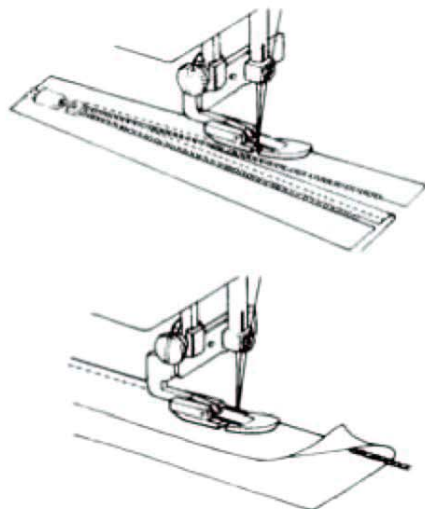

## ZIPPER APPLICATION - CORDING

Use zipper foot which is available at most Sears retail stores and catalog.

### REGULAR ZIPPER

The foot is adjustable for use on the right or left side of needle when sewing regular type of zipper. Adjust the foot so the needle clears the side notch on the foot. Carefully follow directions given on the zipper package.

### CORDING

To make cording for slipcovers, etc., cover a cord with a strip of true bias. Adjust the foot to the left of the needle.

## OILING IN FACE COVER PLATE

Swing face cover plate open and oil points indicated by arrows in illustration.

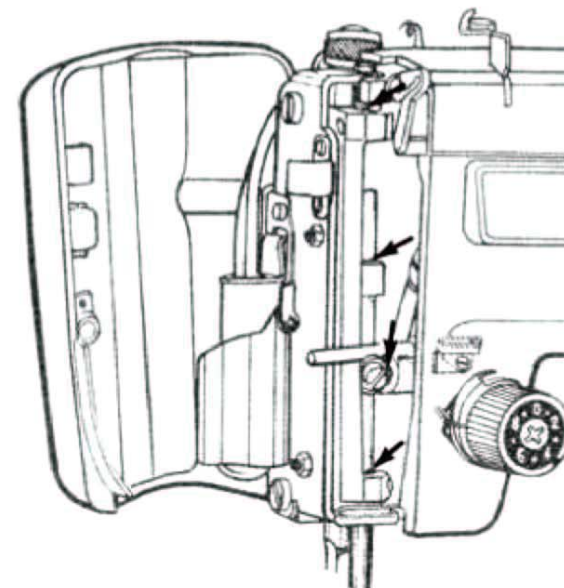

## CHANGING LIGHT BULB

The sewing light is located inside the face cover plate as shown. To replace the bulb, push switch to off, unplug machine and swing the face cover plate open. Raise lamp shade. Push up on the bulb slightly and turn bulb to the left. Withdraw bulb from socket. Push in new bulb and turn to the right.

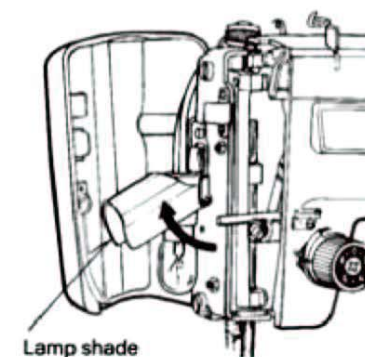

Lamp shade

## CHECKING PERFORMANCE PROBLEMS

SUSPECTED PROBLEM	PROBABLE CAUSE
<b>IRREGULAR STITCHES</b>	Incorrect size needle. Improper threading. Loose upper thread tension. Pulling fabric. Light pressure on presser foot. Loose presser foot. Unevenly wound bobbin. Nicks or burrs at needleplate opening.
<b>BREAKING NEEDLE</b>	Pulling fabric. Incorrect size needle. Incorrect setting of needle. Loose presser foot.
<b>BUNCHING OF THREAD</b>	Upper and lower threads not drawn back under presser foot before starting seam.
<b>PUCKERING</b>	Incorrect thread tension(s). Light pressure on presser foot. Using two different sizes or kinds of thread. Bent or blunt needle. Loose presser foot. Fabric too sheer or too soft.
<b>SKIPPING STITCHES</b>	Incorrect size needle. Certain knits and synthetics. Bent or blunt needle. Incorrect setting of needle. Tight upper thread tension. Light pressure on presser foot.
<b>BREAKING UPPER THREAD</b>	Starting to stitch too fast. Improper threading. Tight upper thread tension. Incorrect size needle. Sharp eye in needle. Nicks or burrs at needleplate opening.
<b>BREAKING BOBBIN THREAD</b>	Improper bobbin case threading. Lint in bobbin case or shuttle.
<b>FABRIC NOT MOVING</b>	Darning plate attached. Light pressure on presser foot. Thread knotted under fabric.
<b>MACHINE JAMMING, KNOCKING NOISE</b>	Thread caught in shuttle. Damaged needle. Bent needle plate.
<b>MACHINE DOES NOT SEW</b>	Hand wheel not returned to stitching position. Power cord not connected. Power/light switch off.

## REMOVING FABRIC

First turn the handwheel toward you until the needle is at its highest position, then raise the presser foot, draw materials to the rear and cut off excess thread with the thread cutter located on the presser bar as shown.

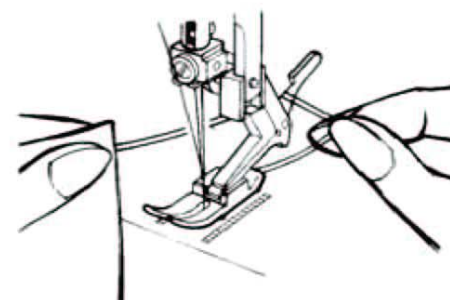

## TOP-STITCHING

**This is a seam you may want to show off!** It's on the **front** side of the garment, possibly at the top of a "kick pleat" or on a lapel, both functional and decorative. Usually, it's a simple, forward stitch — with an extra-long stitch length, or with special thread, matching or contrasting.

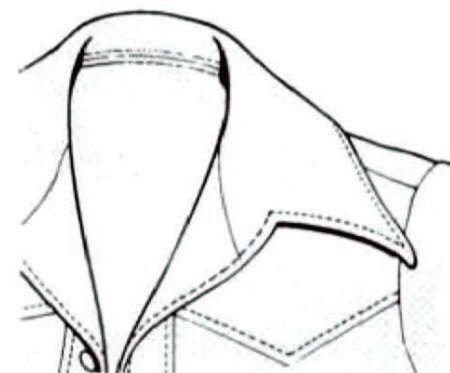

## DARNING

### SETTINGS

Darning plate  
No Presser Foot

Remove presser foot, stretch fabric between embroidery hoops with hole centered. Draw the bobbin thread up through the fabric by holding the top thread and taking one stitch at the spot where you wish to start darning. **Lowering the presser bar**, start sewing at a slow to medium speed. Move the fabric back and forth with a steady rhythm to cover the darning area. When it is covered, turn the fabric and sew another layer of stitching across the first layer of stitching.

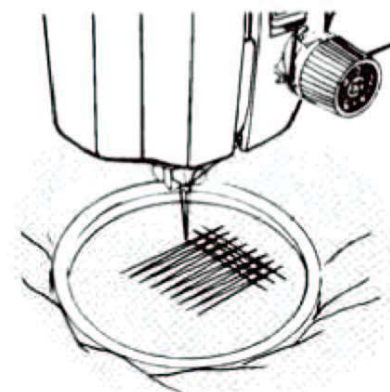



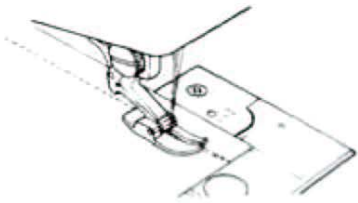

## STRAIGHT STITCHING

You may use zigzag, straight stitch foot or Q foot, but for best control of fabric, best looking straight stitches and best feeding of fabric use **Straight Stitch Foot and Needle Plate**.

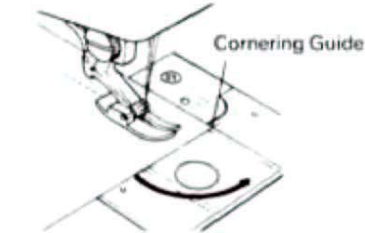

## FASTENING A SEAM

Be sure both threads are drawn back under the presser foot. Lower needle into fabric about 1/2 inch from beginning of seam. Depress the reverse stitch lever and stitch in reverse until needle reaches beginning of seam. Release control and complete seam. When you reach the end, depress the reverse stitch lever and sew back (backtack) over 1/2 inch of completed seam.

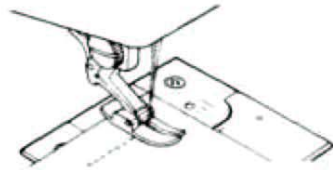

## TURNING A SQUARE CORNER

To turn a square corner 5/8" from the fabric edge, stop stitching with the needle piercing the fabric, when reaching the cornering guide as shown. Raise the presser foot, turn fabric. New stitching line will align with 5/8" seam guide on side of needle plate. Lower the presser foot and begin stitching in new direction.

## POSSIBLY EASY CORRECTION

Choose correct size needle for thread and fabric.  
Rethread machine; check tension spring threading.  
Tighten upper thread tension.  
Do not pull fabric; guide it gently.  
Increase pressure on presser foot.  
Reset presser foot.  
Rewind bobbin.  
Replace needleplate, or polish off burrs completely.

Do not pull fabric; guide it gently.  
Choose correct size needle for thread and fabric.  
Reset needle.  
Reset presser foot.

When starting a seam be sure to draw both threads under and back of presser foot about 4" and hold until a few stitches are formed.

Reset thread tension(s).  
Increase pressure on presser foot.  
Upper thread and bobbin thread should be same size and kind.  
Insert new needle.  
Reset presser foot.  
Use underlay of tissue paper.

Choose correct size needle for thread and fabric.  
Use "Q NEEDLE"™ and "Q FOOT"™.  
Insert new needle.  
Reset needle.  
Loosen upper thread tension.  
Increase pressure on presser foot.

Start to stitch at a medium speed.  
Rethread machine.  
Loosen upper thread tension.  
Choose correct size needle for thread and fabric.  
Insert new needle.  
Replace needleplate, or polish off burrs completely.

Check bobbin case threading.  
Clean bobbin case and shuttle.

Remove darning plate.  
Increase pressure on presser foot.  
Place both threads back under presser foot before beginning to stitch.

Disassemble and clean shuttle.  
Replace needle.  
Replace needle plate.

Push in clutch.  
Check plug.  
Push to on position.

**PRACTICAL STITCH CHART**

**2. STARTING TO SEW**

STITCH	1. STITCH DIAL	2. WIDTH DIAL	3. LENGTH DIAL	4. STITCH MODIFIER	5. PRESSER FOOT	6. NEEDLE PLATE
STRAIGHT		ORANGE DOT	ANY NUMBER		A	D
ZIGZAG		1 - 4	ANY NUMBER		B	E
MENDING		3 - 4	ORANGE ZONE		B	E
BOX		2 - 4	ORANGE ZONE - 12	ORANGE DOT	B	E
BLIND		1 1/2 - 2	12 - 10		B	E
SHELL		2 - 4			B	E
FAGOTING		4	ORANGE ZONE - 12		B	E
STRAIGHT STRETCH		ORANGE DOT			A	D
RICK-RACK		1 - 4			B	E
SMOCKING		2 - 4			B	E
ELASTIC		2 - 4	6 6-12*	WHITES - L	B	E
OVERCAST		4			B	E
SERGING		2 - 4			B	E
PATCHING		4			B	E
DARNING		ORANGE DOT	NOT APPLICABLE	NOT APPLICABLE	NONE	E and F
SATIN		1 - 4	ORANGE ZONE	ORANGE DOT	C	E
		1 - 4	ORANGE ZONE	ORANGE DOT	B or C	E
DECORATIVE DESIGNS	7		6 6-12*	WHITES - L		
	ORANGE CAMS GREEN CAMS					

\* For Model 17680, 17681, 17682 only.



A. Straight foot B. Zigzag foot C. Satin foot D. Straight stitch needle plate E. Zigzag needle plate F. Darning plate

**MACHINE SETTING CHART (MODEL 1690 ONLY)**

STITCH	1. STITCH DIAL	2. WIDTH DIAL	3. LENGTH DIAL	4. STITCH MODIFIER	5. PRESSER FOOT	6. NEEDLE PLATE
STRAIGHT		RED DOT	ANY NUMBER		A or B	D or E
ZIGZAG		1 - 4	ANY NUMBER		B	E
MENDING		3 - 4	RED ZONE	RED DOT	B	E
BOX		2 - 4	RED ZONE - 12		B	E
BLIND		1 1/2 - 2	12 - 10		D	E
SHELL		2 - 4	12		B	E
STRAIGHT STRETCH		RED DOT		WHITE OR GREEN DOT	A or B	D or E
RICK-RACK		1 - 4			B	E
SERGING		4		WHITE DOT	B	E
OVERCAST		4			B	E
ELASTIC		4	6		B	E
SMOCKING		2 - 4			B	E
SLANT OVERCAST		4			B	E
FEATHER		4			B	E
FISH-BONE		4		GREEN DOT	B	E
OVEREDGE		4			B	E
DARNING		RED DOT	NOT APPLICABLE	NOT APPLICABLE	NONE	E and F
SATIN		1 - 4	RED DOT	RED ZONE	C	E

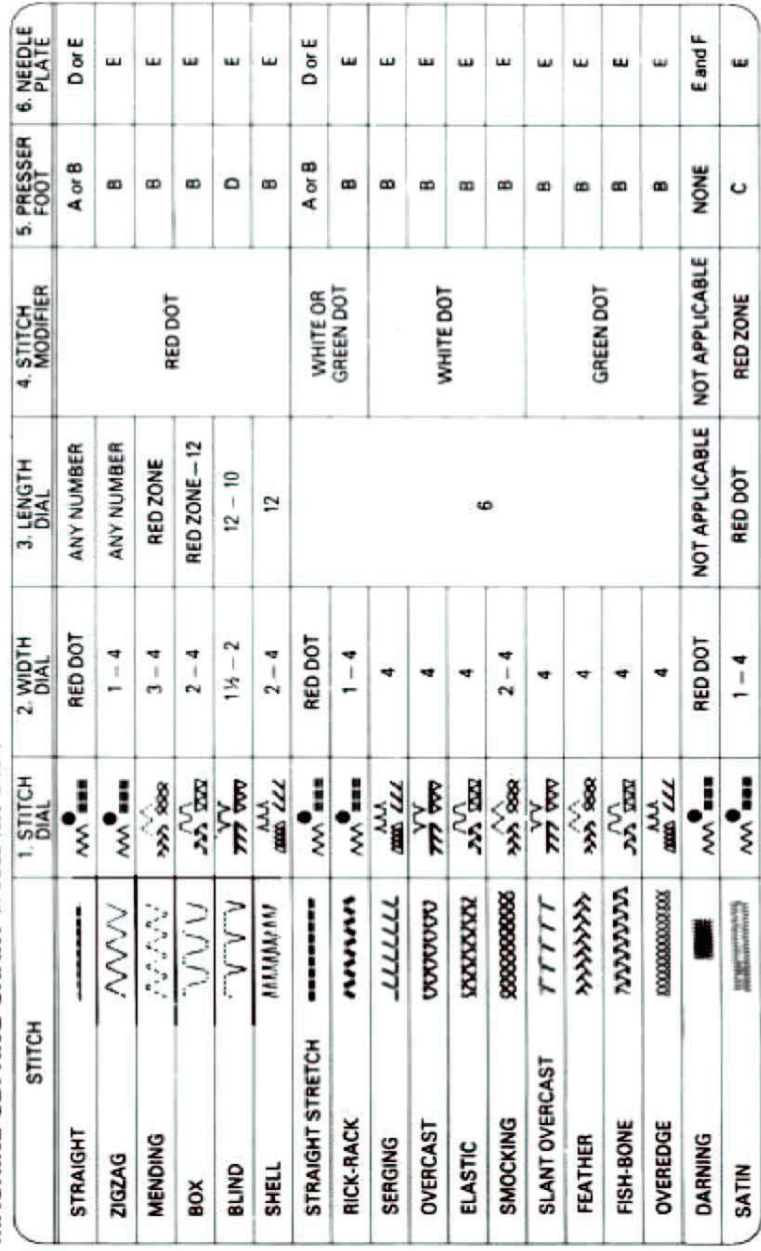

1. STITCH DIAL 2. WIDTH DIAL 3. LENGTH DIAL 4. STITCH MODIFIER 5. PRESSER FOOT 6. NEEDLE PLATE

## Free Manuals Download Website

<http://myh66.com>

<http://usermanuals.us>

<http://www.somanuals.com>

<http://www.4manuals.cc>

<http://www.manual-lib.com>

<http://www.404manual.com>

<http://www.luxmanual.com>

<http://aubethermostatmanual.com>

Golf course search by state

<http://golfingnear.com>

Email search by domain

<http://emailbydomain.com>

Auto manuals search

<http://auto.somanuals.com>

TV manuals search

<http://tv.somanuals.com>