

Owner's Manual
Manual Del Propietario
Manuel Du Propriétaire



Vacuum Cleaner
Aspiradora
Aspirateur

Model, Modelo, Modèle
216.37010 (US)
216.31701 (Canada)

CAUTION:

Read and follow all safety and operating instructions before first use of this product.

CUIDADO:

Lea y sigue todas las instrucciones de operación y seguridad antes del uso de este producto.

ATTENTION :

Veuillez lire toutes les consignes de sécurité et le mode d'emploi avant d'utiliser ce produit.

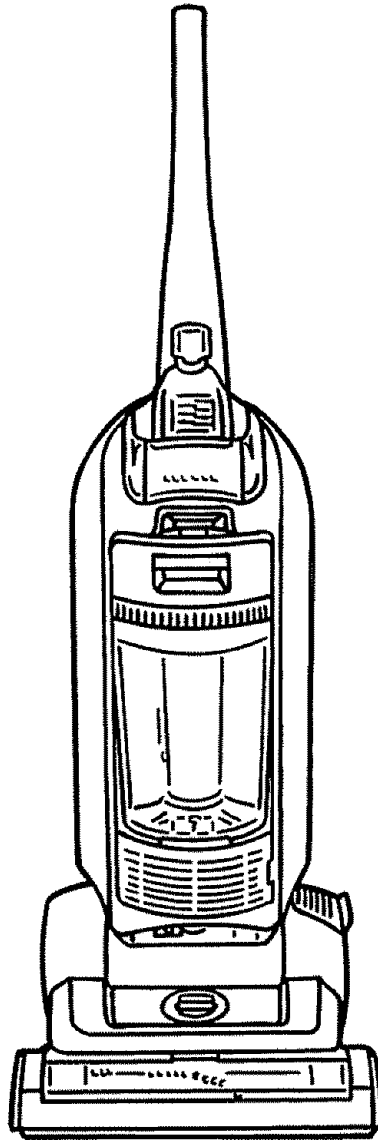

ENGLISH

ESPAÑOL

FRANÇAIS

Sears Brands, LLC, Hoffman Estates, IL 60179 U.S.A.
www.sears.com

Part # 1-115603-000 Rev. 9/07

Printed in China
Impreso en China
Imprimé en Chine

TABLE OF CONTENTS

Before Using Your New Vacuum Cleaner	2	Vacuum Cleaner Care	10-14
Kenmore Vacuum Cleaner Warranty	3	Dirt Container and Filter Removal and Replacement	11-12
Important Safety Instructions	4-5	Exhaust Filter Removal And Replacement	12
Parts and Features	6	Belt or Brushroll Removal And Replacement	13
Assembly Instructions	7	Light Bulb Replacement	14
Operating Instructions	8-10	Vacuum Cleaner Storage	14
Power Cord	8	Troubleshooting	15
Floor/ Carpet Cleaning	9	Master Protection Agreements ...	16
Above Floor Cleaning	10	Requesting Service	(back page)
Pet Handi-Mate	10		

BEFORE USING YOUR NEW VACUUM CLEANER

Please read this guide. It will help you assemble and operate your new Kenmore vacuum cleaner in the safest and most effective way.

For more information about vacuum cleaner care and operation, call your nearest Sears store. You will need the complete model and serial numbers when requesting information. Your vacuum cleaner's model and serial numbers are located on the Model and Serial Number Plate.

Use the space below to record the model number and serial number of your new Kenmore vacuum cleaner.

Model No. _____

Serial No. _____

Date of Purchase _____

Keep this book and your sales check (receipt) in a safe place for future reference.

KENMORE VACUUM CLEANER WARRANTY

ONE YEAR LIMITED WARRANTY ON KENMORE VACUUM CLEANER

When installed, operated and maintained according to all instructions supplied with the product, if this appliance fails due to a defect in material and workmanship within one year from the date of purchase, return it to any Sears store, Sears Parts & Repair Service Center, or other Kenmore outlet for free repair.

If this appliance is ever used for other than private family purposes, this warranty applies for only 90 days from the date of purchase.

This warranty covers only defects in material and workmanship. Sears will NOT pay for:

1. Expendable items that can wear out from normal use, including but not limited to filters, belts, light bulbs, and bags.
2. A service technician to instruct the user in correct product installation, operation or maintenance.
3. A service technician to clean or maintain this product.
4. Damage to or failure of this product if it is not installed, operated or maintained according to the all instructions supplied with the product.
5. Damage to or failure of this product resulting from accident, abuse, misuse or use for other than its intended purpose.
6. Damage to or failure of this product caused by the use of detergents, cleaners, chemicals or utensils other than those recommended in all instructions supplied with the product.
7. Damage to or failure of parts or systems resulting from unauthorized modifications made to this product.



Disclaimer of implied warranties; limitation of remedies

Customer's sole and exclusive remedy under this limited warranty shall be product repair as provided herein. Implied warranties, including warranties of merchantability or fitness for a particular purpose, are limited to one year or the shortest period allowed by law. Sears shall not be liable for incidental or consequential damages. Some states and provinces do not allow the exclusion or limitation of incidental or consequential damages, or limitation on the duration of implied warranties of merchantability or fitness, so these exclusions or limitations may not apply to you.

This warranty applies only while this appliance is used in the United States or Canada. This warranty gives you specific legal rights, and you may also have other rights which vary from state to state.

**Sears, Roebuck and Co., Hoffman Estates, IL 60179
Sears Canada Inc., Toronto, Ontario, Canada M5B 2B8**

IMPORTANT SAFETY INSTRUCTIONS



WARNING

Your safety is important to us. To reduce the risk of fire, electrical shock, injury to persons or damage when using your vacuum cleaner, follow basic safety precautions including the following:

READ ALL INSTRUCTIONS IN THIS MANUAL BEFORE ASSEMBLING OR USING YOUR VACUUM CLEANER.

Do not use outdoors or on wet surfaces. Electrical shock could occur.

Do not allow to be used as a toy. Close attention is necessary when used by or near children.

Use only as described in this manual. Use only manufacturer's recommended attachments.

Do not use with damaged cord or plug. If appliance is not working as it should, has been dropped, damaged, left outdoors, or dropped into water, return it to a service center for inspection. Call 1-877-839-2046 to locate the nearest service centers.

Do not pull or carry by cord, use cord as handle, close a door on a cord, or pull cord around sharp edges or corners. Do not run appliance over cord. Keep cord away from heated surfaces.

Do not unplug by pulling on cord. To unplug, grasp the plug, not the cord.

Do not leave appliance when plugged in. Unplug from outlet when not in use and before servicing.

Do not handle plug or appliance with wet hands.

Do not put any objects into openings. Do not use with any opening blocked; keep free of dust, lint, hair, and anything that may reduce air flow.

Keep hair, loose clothing, fingers, and all parts of body away from openings and moving parts.

Do not pick up anything that is burning or smoking, such as cigarettes, matches, or hot ashes.

Do not use without dirt container and filters in place.

Turn off all controls before unplugging.

Do not use to pick-up flammable or combustible liquids, such as gasoline, or use in areas where they may be present.

Keep the vacuum cleaner on the floor. Do not use on stairs.

Do not use an extension cord with this vacuum cleaner.

Store the vacuum cleaner indoors. Put vacuum cleaner away after use to prevent tripping accidents.

IMPORTANT SAFETY INSTRUCTIONS

Using improper voltage may result in damage to the motor and possible injury to the user. Proper voltage is listed on the cleaner plate.

Unplug before connecting Pet Handi-Mate.

WARNING: The cords, wires, and/or cables supplied with this product contains chemicals, including lead or lead compounds, known to the state of California to cause cancer and birth defects or other reproductive harm. Wash hands after using.

SAVE THESE INSTRUCTIONS

Proper assembly and safe use of your vacuum cleaner are your responsibilities. Your vacuum cleaner is intended only for **Household use**. Read this Owner's Manual carefully for important use and safety information. This guide contains safety statements under warning and caution symbols. Please pay special attention to these boxes and follow any instructions given.

Your cleaner contains a thermal protective device to shut off the motor to avoid overheating. If this happens, turn switch off and unplug the cleaner. Inspect the exhaust, inlet, and filters for any blockage. Empty the dirt container and clean filters. After approximately 30 minutes the motor will have cooled and the vacuum will be ready to use. **Note:** The cleaner must remain unplugged during the 30 minute cooling period.

PARTS AND FEATURES

It is important to know your vacuum cleaner's parts and features to assure its proper and safe use. Review these before using your vacuum cleaner.

Item	Part No.	Style No. In U.S.
Pleated Filter	301974002	DCF-4
Belt	1-860140-600	UB-11

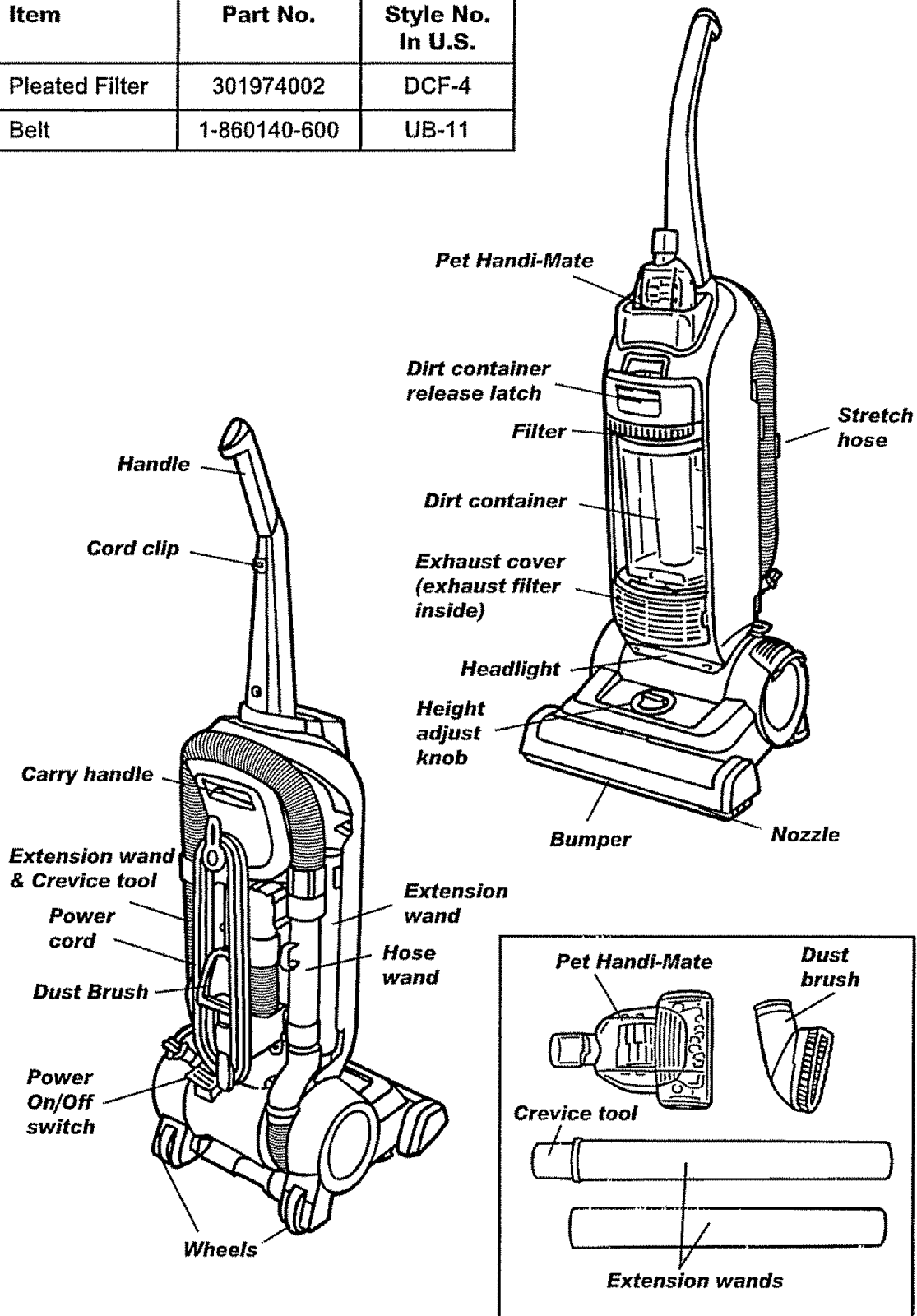



Please pay special attention to these hazard alert boxes, and follow any instructions given. **WARNING** statements alert you to such dangers as fire, electric shock, burns and personal injury. **CAUTION** statements alert you to such dangerous personal injury and/or property damage.

ASSEMBLY INSTRUCTIONS



WARNING

Electrical Shock Hazard

Do not plug into the electrical supply until the assembly is complete. Failure to do so could result in electrical shock or injury.

Before assembling the vacuum cleaner, check the **PACKING LIST** on the cover of the separate **REPAIR PARTS LIST** or on the carton. Use this list to verify that you have received all the components of your new Kenmore vacuum cleaner.

HANDLE ASSEMBLY

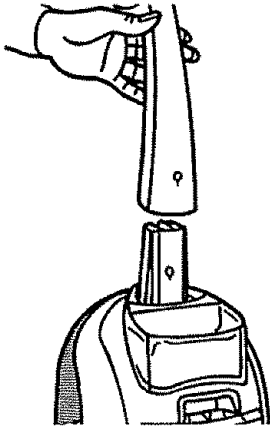

1. Attach upper handle to main body of cleaner.

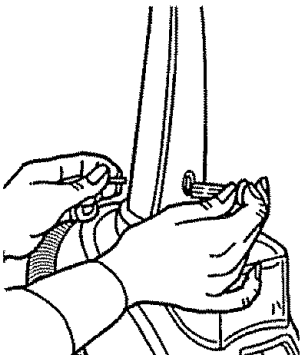

2. Push handle plug onto the front of cleaner. Insert the one (1) screw into the back of the handle and tighten, making sure the handle plug is secure.



CAUTION

Do not overtighten.

Overtightening could strip the screw holes.

Do not operate the vacuum cleaner without the screws in place.

EXTENSION WAND/ CREVICE TOOL PLACEMENT

Place the crevice tool (A) in the top of the extension wand. Place in wand holder on left side of vacuum cleaner. Place the extra extension wand (B) in the wand holder on the right side of the vacuum cleaner.

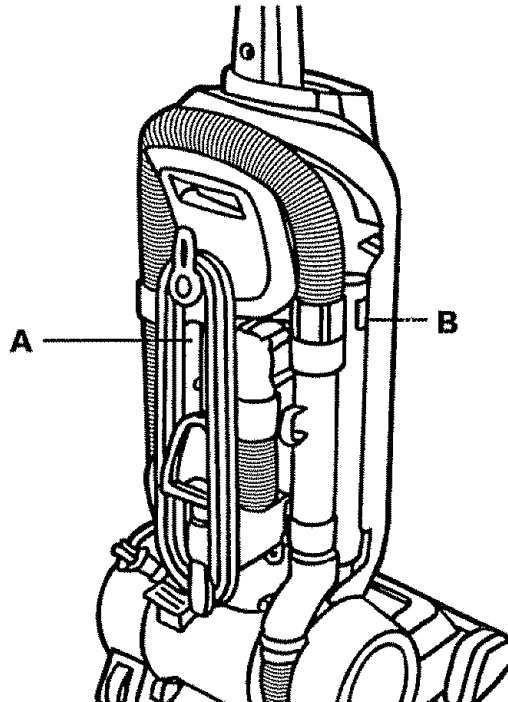

OPERATING INSTRUCTIONS

POWER CORD

1. Turn the quick release upper cord hook to either side and down to release the power cord.

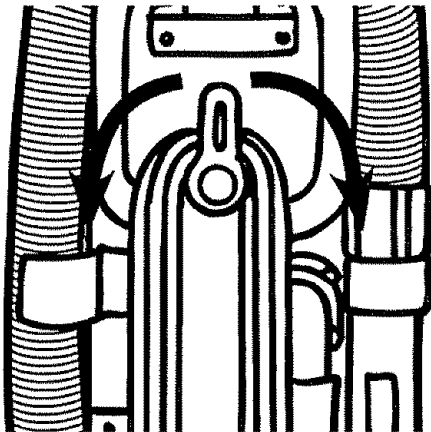

2. Detach the power cord plug from the power cord. Make sure the power cord is placed into the cord clip on the body as shown. This helps keep the power cord out from under the vacuum cleaner nozzle.

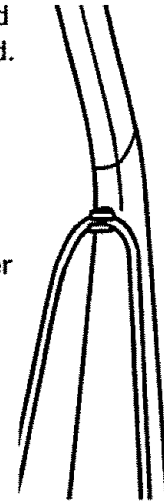

3. Plug the polarized power cord into a 120 Volt outlet located near the floor.

4. To store cord, turn upper cord hook to the up position, then wrap cord.



WARNING

To reduce the risk of electric shock, this appliance has a polarized plug (one blade is wider than the other). This plug will fit in a polarized outlet only one way. If the plug does not fit fully in the outlet, reverse the plug. If it still does not fit, contact a qualified electrician to install the proper outlet. Do not change the plug in any way.



WARNING

Personal Injury and Product Damage Hazard

- **DO NOT** plug in if switch is in the **ON** position. Personal injury or damage could result.
- **DO NOT** use outlets above counters. Damage from cord to items in surrounding area could occur.

FLOOR/CARPET CLEANING

HEIGHT ADJUST KNOB

IMPORTANT: For easiest adjustment, place cleaner in full upright position. Turn the height adjust knob to match the surface being cleaned.

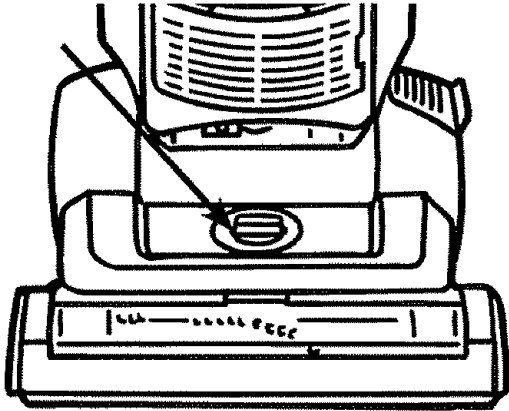

ON/OFF BUTTON

Turn cleaner on by depressing foot pedal located on the back left side of the cleaner.

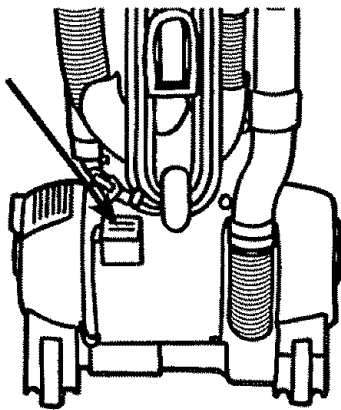

HANDLE RELEASE

To release handle, push the handle release pedal located on the lower left side of the cleaner.

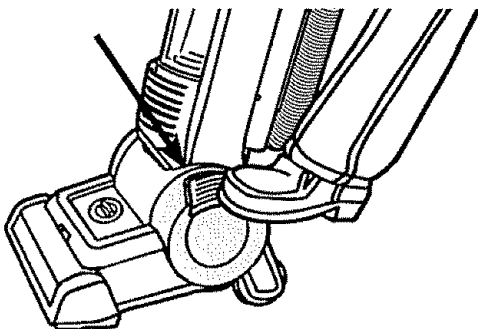

Rotate the handle and adjust it to the desired position for (A) storing the upright, (B) operating the cleaner, and (C) to clean under furniture. **NOTE:** Rotating brush could cause area rug fringe to become tangled within cleaner. Use caution when vacuuming any rugs with fringe.

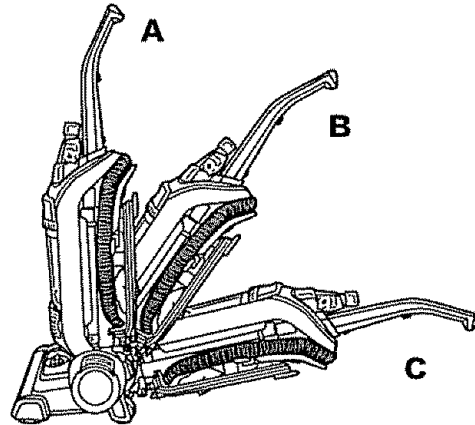

CARRY HANDLE

Use the carry handle located on the back of the cleaner to carry from room to room.



ABOVE FLOOR CLEANING



CAUTION

Brush agitator continues to rotate while hose is removed or in use and at all times while cleaner is on. Keep hair, loose clothing, fingers, and all parts of body away from brush area while cleaner is on. Cleaner must be in the upright position to lift the rotating brushroll off the carpet when cleaning above the floor.

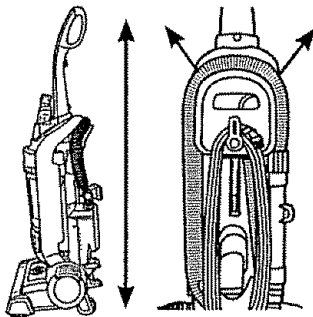

Cleaner must be in its upright position to raise brushroll from floor. Remove the hose from the tool caddy.

Choose any of the handy accessories or use the hose alone. Simply push the attachment firmly onto the end of the wand or hose handle. To remove tool, twist and pull apart gently.

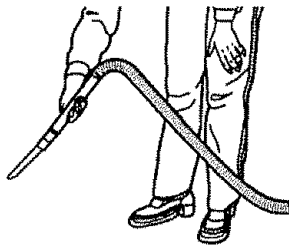

If additional length is needed, use the extension wand and crevice tool. Use extension wand and crevice tool together or separately.

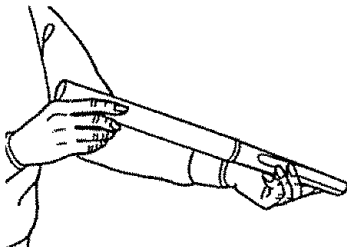

PET HANDI-MATE

Attach the Pet Handi-Mate to the hose wand. Brushroll will start automatically.

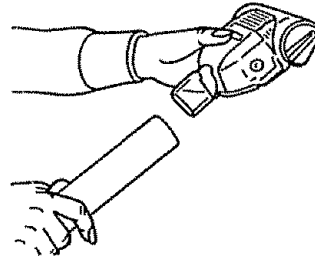

The Pet Handi-Mate can be used for cleaning stairs and upholstery.

DEBRIS REMOVAL

Slide locking tabs to outward position to unlock. Pivot lower housing and remove clog.

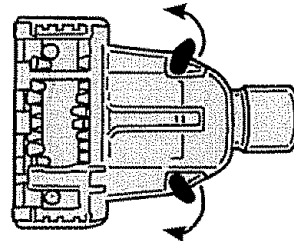

To reassemble, align tabs on the lower housing with the slots on the cover and pivot cover back into position on top of lower housing. Rotate locking tabs inward into locking position.

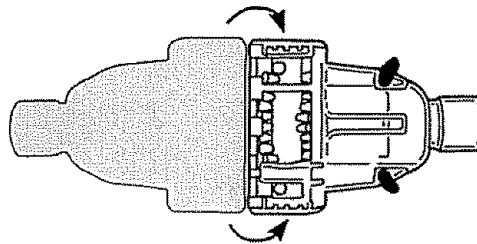

VACUUM CLEANER CARE

DIRT CONTAINER REMOVAL AND REPLACEMENT



WARNING

Electrical Shock and Personal Injury Hazard

Disconnect electrical supply before servicing or cleaning the unit. Failure to do so could result in electrical shock or personal injury from vacuum cleaner suddenly starting.

Note: For best performance, replace filter a minimum of every 6 months.

EMPTY DIRT CONTAINER

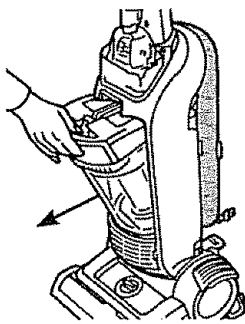

Press dirt container release button and remove dirt container from cleaner.

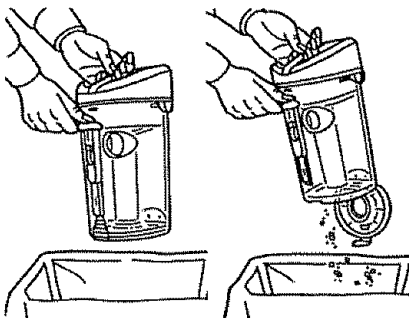

Empty contents of dirt container into garbage can.

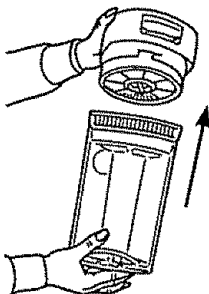

Twist and lift dirt container lid to remove.

PLEATED LID FILTER: Each time the dirt container is emptied, the filter should be cleaned. Filter will be discolored after use; this will not affect the filter's performance. Do not brush the filter.

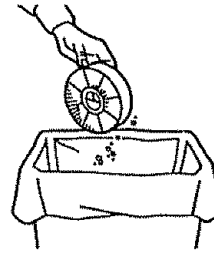

Tap the lid on the inside of a garbage can to remove excess dust and dirt from filter. **DO NOT APPLY WATER TO PLEATED FILTER!**

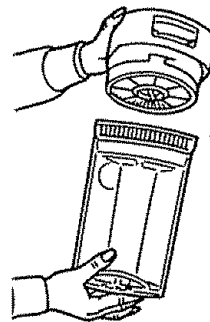

Return lid to dirt container and lock into place. Align arrow on lid with arrow on dirt container and twist to "LOCK" position.

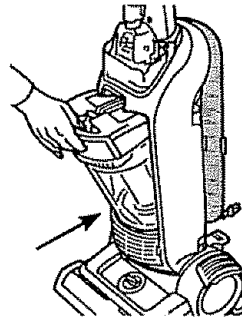

Return dirt container by latching to base of unit.

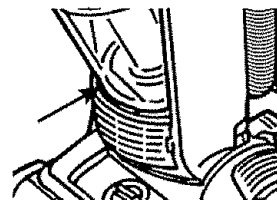

NOTE: The bottom of the dirt container must be placed behind the plastic rib on the top of the motor housing. Failure to properly locate the dirt container will result in a loss of performance and may cause debris to leak from the dirt container while vacuuming.

FOAM FILTER CARE

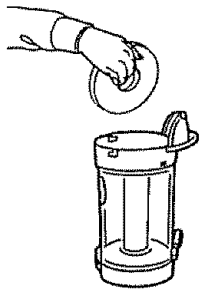

Remove foam filter from dirt container.

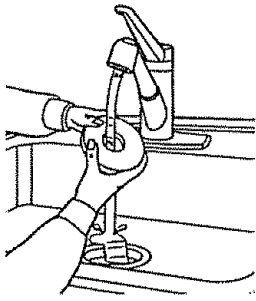

Hold filter under running water to wash. Ring excess water out of filter. Allow filter to dry for at least 24 hours.



Return filter to dirt container by placing on top of screen inside dirt container.

IMPORTANT: Do not return filter to the dirt container before it has completely dried.

EXHAUST FILTER REMOVAL AND REPLACEMENT



WARNING

Electrical Shock and Personal Injury Hazard

Disconnect electrical supply before servicing or cleaning the unit. Failure to do so could result in electrical shock or personal injury from vacuum cleaner suddenly starting.

Note: For best performance, replace the exhaust filter a minimum of every 6 months.

Grasp tab on exhaust filter cover and pivot forward to remove.

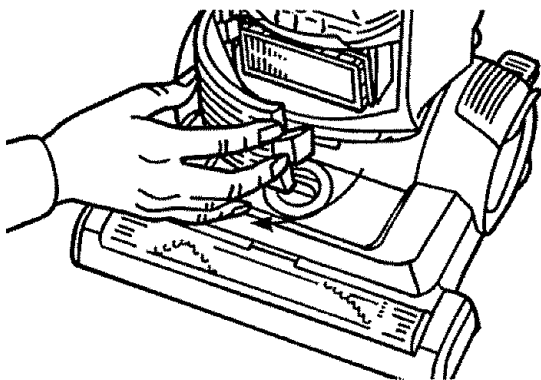

Remove exhaust filter from cleaner. Tap filter on inside of garbage can to remove excess dust and dirt from filter.

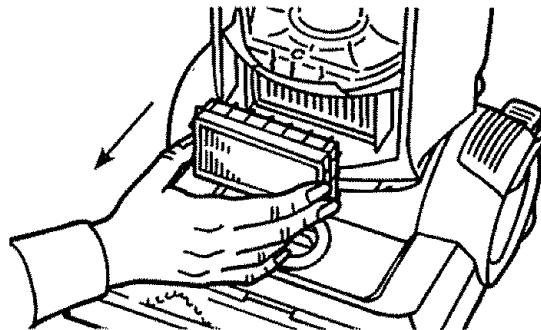

Return exhaust filter to cleaner. Replace exhaust filter cover by inserting the tab on the cover into the slot on the cleaner. Pivot toward cleaner until cover snaps into place.

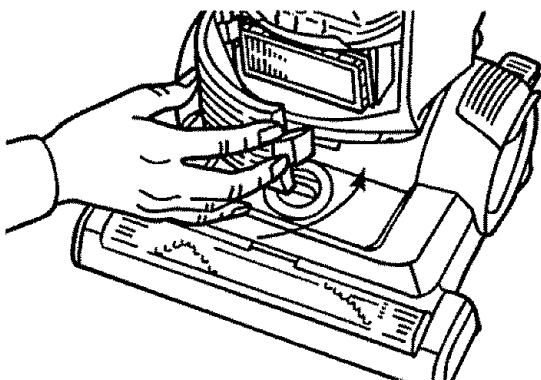

BELT OR BRUSHROLL REMOVAL AND REPLACEMENT



WARNING

Electrical Shock and Personal Injury Hazard

Disconnect electrical supply before servicing or cleaning the unit. Failure to do so could result in electrical shock or personal injury from vacuum cleaner suddenly starting.

TO REMOVE BELT

Lay cleaner flat and flip cleaner to expose nozzle base. To remove nozzle guard, slide lock A to unlock position, to the left. Then depress lock B to unlock nozzle guard.

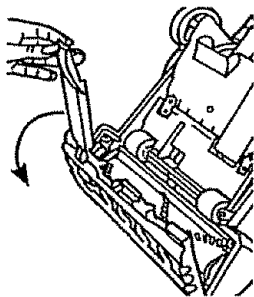
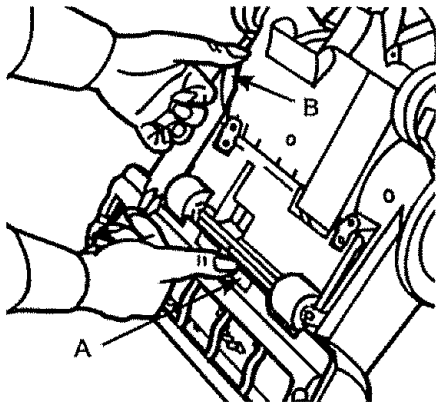

Rotate/pivot the nozzle guard and pull off

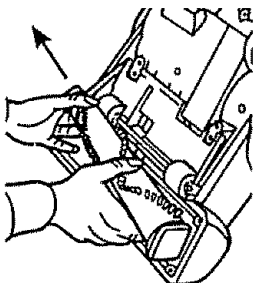

Lift and remove brushroll. Dispose of old belt.

TO REPLACE BELT OR BRUSHROLL

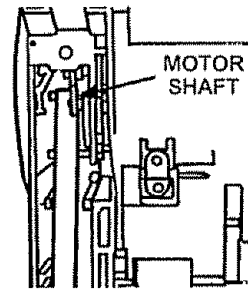

Slide belt onto motor shaft.

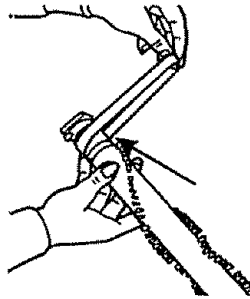

Place new belt in area of brushroll without bristles.

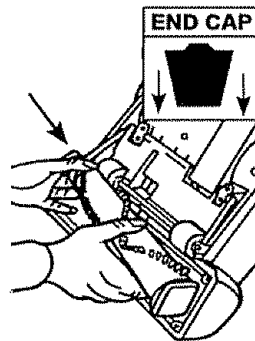

With new belt in place, pull and slide brushroll into nozzle making sure that the brushroll end caps are in the correct orientation (see diagram for end cap orientation). Rotate brushroll manually to make sure belt is properly aligned.

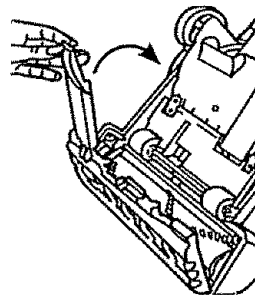

Secure by aligning the three (3) tabs in the base slots. To reattach nozzle guard, rotate/pivot back into position.

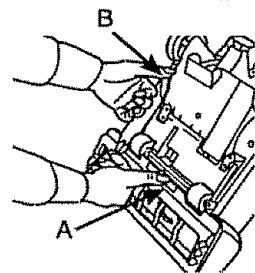

To secure nozzle guard, push lock B down to lock position. Slide lock A into lock position, to the right.

LIGHT BULB REPLACEMENT



WARNING

Electrical Shock and Personal Injury Hazard

Disconnect electrical supply before servicing or cleaning the unit. Failure to do so could result in electrical shock or personal injury from vacuum cleaner suddenly starting.

TO REMOVE LIGHT BULB

1. Disconnect power cord from electrical outlet.
2. Press handle release pedal and lay vacuum cleaner back.

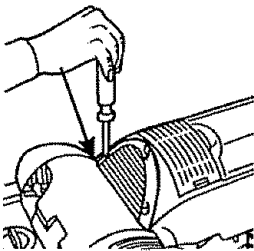

3. Remove the two (2) screws from the lens cover.

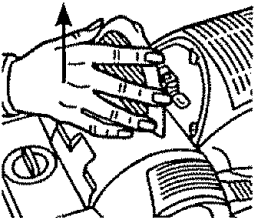

4. Insert flat blade of screwdriver into slot at top of the lens. Lift the lens cover to remove.



CAUTION

Do not use a bulb rated over 9W (13V). During extended use, heat from the bulb could overheat surrounding plastic parts.

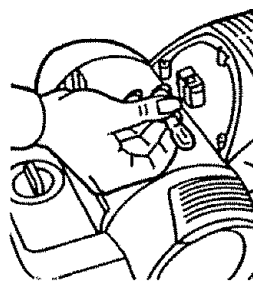

5. Pull bulb out of socket. Do NOT twist. Gently push replacement bulb into socket to replace.

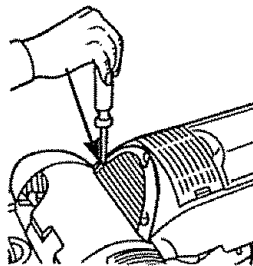

6. Snap lens cover back into place and secure the headlight lens by replacing the two screws.

Note: See separate **PARTS LIST** for bulb number.

VACUUM CLEANER STORAGE

Gather the cord and wrap it loosely around the upper and lower cord hooks. Lock power cord plug onto the power cord.

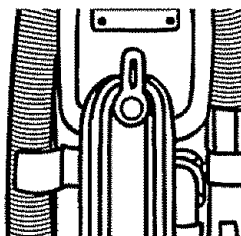

Store the vacuum cleaner in a dry, indoor area, on the floor with the handle locked in the upright position.



WARNING

Electrical Shock and Personal Injury Hazard

Wrapping the cord too tightly puts stress on the cord and can cause cord damage.

TROUBLESHOOTING

Review this table to find do-it-yourself solutions for minor performance problems. Any service needed, other than maintenance described in this Owner's Manual, should be performed by a Sears or other qualified service agent.



WARNING

Disconnect electrical supply before performing maintenance to the unit. Failure to do so could result in electrical shock or personal injury.

PROBLEM	POSSIBLE CAUSE	POSSIBLE SOLUTION
Cleaner won't run	<ol style="list-style-type: none"> 1. Power cord not firmly plugged into outlet. 2. Blown fuse or tripped breaker. 3. Thermal Protector activated. 4. Needs service. 	<ol style="list-style-type: none"> 1. Plug unit in firmly. 2. Check fuse or breaker in home. Replace fuse/reset breaker. 3. Allow cleaner to cool - Pg. 5. 4. Take to Sears Service Center.
Cleaner won't pick up or low suction	<ol style="list-style-type: none"> 1. Dirt container not installed correctly. 2. Dirt container full. 3. Brushroll worn. 4. Broken or worn belt. 5. One or both filters clogged. 6. Carpet height setting is incorrect. 	<ol style="list-style-type: none"> 1. Review DIRT CONTAINER REMOVAL AND REPLACEMENT - Pg. 11, 12. 2. Empty dirt container - Pg. 11. 3. Replace brushroll - Pg. 13. 4. Replace belt - Pg. 13. 5. Remove filters and clean - Pg. 11, 12. 6. Set carpet height adjust lever to appropriate setting for carpet being cleaned - Pg. 9.
Dust escaping from cleaner	<ol style="list-style-type: none"> 1. Dirt container full. 2. Dirt container not installed correctly. 3. Hose not installed correctly. 4. One or both filters not installed completely. 	<ol style="list-style-type: none"> 1. Empty dirt container - Pg. 11. 2. Review DIRT CONTAINER REMOVAL AND REPLACEMENT - Pg. 11, 12. 3. Review hose placement - Pg. 6. 4. Review filter removal and replacement - Pg. 11, 12.
Cleaner tools won't pick-up	<ol style="list-style-type: none"> 1. Hose clogged. 2. Dirt container full. 3. One or both filters clogged. 	<ol style="list-style-type: none"> 1. Check inlets, hose and dirt container for obstructions; remove obstruction. If clog persists, call 1-877-839-2046. 2. Empty dirt container - Pg. 11. 3. Clean filters - Pg. 11, 12.
Headlight not working	<ol style="list-style-type: none"> 1. Bulb burnt out. 2. Loose electrical wires. 	<ol style="list-style-type: none"> 1. Replace bulb - Pg. 14. 2. Take to Sears Service Center.
Cleaner is difficult to push	<ol style="list-style-type: none"> 1. Carpet height setting is incorrect. 2. Broken or worn belt. 	<ol style="list-style-type: none"> 1. Set carpet height adjust lever to appropriate setting for carpet being cleaned - Pg. 9. 2. Replace belt - Pg. 13.

For any questions, please call 1-877-839-2046.

MASTER PROTECTION AGREEMENT

Congratulations on making a smart purchase. Your new Kenmore® product is designed and manufactured for years of dependable operation. But like all products, it may require preventive maintenance or repair from time to time. That's when having a Master Protection Agreement can save you money and aggravation.

The Master Protection Agreement also helps extend the life of your new product. Here's what the Agreement* includes:

- Parts and labor** needed to help keep products operating properly **under normal use**, not just defects. Our coverage goes **well beyond the product warranty**. No deductibles, no functional failure excluded from coverage – **real protection**.
- Expert service** by a force of more than **10,000 authorized Sears service technicians**, which means someone you can trust will be working on your product.
- Unlimited service calls and nationwide service**, as often as you want us, when ever you want us.
- "No-lemon" guarantee** – replacement of your covered product if four or more product failures occur within twelve months.
- Product replacement** if your covered product can't be fixed.
- Annual Preventive Maintenance Check** at your request – no extra charge.
- Fast help by phone** – we call it **Rapid Resolution** – phone support from a Sears representative on all products. Think of us as a "talking owner's manual."
- Power surge protection** against electrical damage due to power fluctuations.
- \$250 Food Loss Protection** annually for any food spoilage that is the result of mechanical failure of any covered refrigerator or freezer.
- Rental reimbursement** if repair of your covered product takes longer than promised.
- 10% discount** off the regular price of any non-covered repair service and related installed parts.

Once you purchase the Agreement, a simple phone call is all that it takes for you to schedule service. You can call anytime day or night, or schedule a service appointment online.

The Master Protection Agreement is a risk free purchase. If you cancel for any reason during the product warranty period, we will provide a full refund. Or, a prorated refund anytime after the product warranty period expires. Purchase your Master Protection Agreement today!

Some limitations and exclusions apply. For prices and additional information in the U.S.A. call 1-800-827-6655.

*** Coverage in Canada varies on some items. For full details call Sears Canada at 1-800-361-6665.**

Sears Installation Service

For Sears professional installation of home appliances, garage door openers, water heaters, and other major home items, in the U.S.A. or Canada call **1-800-4-MY-HOME®**.

Get it fixed, at your home or ours!

Your Home

For repair - **in your home** - of **all** major brand appliances, lawn and garden equipment, or heating and cooling systems, **no matter who made it, no matter who sold it!**

For the replacement parts, accessories and owner's manuals that you need to do-it-yourself.

For Sears professional installation of home appliances and items like garage door openers and water heaters.

1-800-4-MY-HOME Anytime, day or night
(1-800-469-4663) (U.S.A. and Canada)
www.sears.com **www.sears.ca**

For expert home solutions advice: www.managemyhome.com

Our Home

For repair of carry-in products like vacuums, lawn equipment, and electronics, call or go on-line for the nearest **Sears Parts and Repair Center.**

1-800-488-1222 Anytime, day or night (U.S.A. only)
www.sears.com

To purchase a protection agreement (U.S.A.) or maintenance agreement (Canada) on a product serviced by Sears:

1-800-827-6655 (U.S.A.) **1-800-361-6665** (Canada)

Para pedir servicio de reparación a domicilio, y para ordenar piezas:
1-888-SU-HOGAR®
(1-888-784-6427)

Au Canada pour service en français:
1-800-LE-FOYER^{MC}
(1-800-533-6937)
www.sears.ca



© Sears Brands, LLC

® Registered Trademark / ™ Trademark / ™ Service Mark of Sears Brands, LLC

® Marca Registrada / ™ Marca de Fábrica / ™ Marca de Servicio de Sears Brands, LLC

MC Marque de commerce / MD Marque déposée de Sears Brands, LLC

Free Manuals Download Website

<http://myh66.com>

<http://usermanuals.us>

<http://www.somanuals.com>

<http://www.4manuals.cc>

<http://www.manual-lib.com>

<http://www.404manual.com>

<http://www.luxmanual.com>

<http://aubethermostatmanual.com>

Golf course search by state

<http://golfingnear.com>

Email search by domain

<http://emailbydomain.com>

Auto manuals search

<http://auto.somanuals.com>

TV manuals search

<http://tv.somanuals.com>