

# SEARS OWNER'S MANUAL



## Electronic Air Cleaning System Featuring the Forever Filter™

Model  
635.83147

- ◆ Operating Instructions
- ◆ Parts List

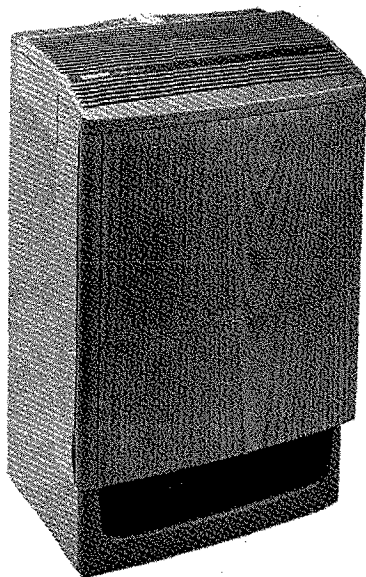

### CAUTION:

Read this manual  
and follow all its  
Safety and Operating  
Instructions.



### INFO-LINE

After reading this manual, if  
you have any questions or  
comments on your Kenmore  
Air Cleaner call:  
1-800-227-3917

Sold by Sears, Roebuck and Co., Hoffman Estates, IL 60179

## INTRODUCTION

Congratulations on your purchase of the Kenmore Air Cleaner featuring the Forever Filter™. This Kenmore Air Cleaner will remove airborne pollutants such as dust, smoke, pollen, and mold that are circulating in your home, most of which you cannot see with the naked eye. As the air recirculates through your room and through the air cleaner system, the air is cleaned continuously.

Please read this Owner's Manual thoroughly before operating your air cleaner.

If, at any time, you have any questions about the operation of your Kenmore Air Cleaning System, please contact the Help Line at 1-800-227-3917.

## GENERAL SAFETY INSTRUCTIONS

When using electrical appliances, basic precautions should always be followed to reduce the risk of fire, electrical shock and injury to persons, including the following:

- ◆ Please read this Owner's Manual before using your Electronic Air Cleaner
- ◆ This air cleaner is equipped with a 3-prong plug and should only be plugged into a standard 3-prong (grounded) 120 volt AC outlet.
- ◆ DO NOT use an extension cord with the air cleaner
- ◆ Unplug the air cleaner prior to moving the unit or cleaning filters
- ◆ DO NOT use this electronic air cleaner when oxygen is being used or when combustible gases are present
- ◆ DO NOT use outdoors
- ◆ DO NOT place any foreign objects inside the Air Cleaner

**CAUTION** - Do not operate this air cleaner in the presence of candles, wood burning fireplaces or stoves, or improperly maintained gas appliances. These products can produce smoke that may cause property damage such as staining on walls, furniture, draperies or other household furnishings if used while operating this air cleaner, especially if the "Forever Filter" is not cleaned on a regular basis. Follow all Owner's Manual instructions.

## WARRANTY

If within one year from the date of purchase, this air cleaner fails due to a defect in material or workmanship, Sears will repair or replace it, free of charge.

Warranty service is available by simply returning the air cleaner to the nearest Sears store throughout the United States.

This warranty gives you specific legal rights and you may have other rights which may vary from state to state.

Sears, Roebuck and Co. Department 817WA,  
Hoffman Estates, IL 60179

## GETTING STARTED WITH YOUR ELECTRONIC AIR CLEANER

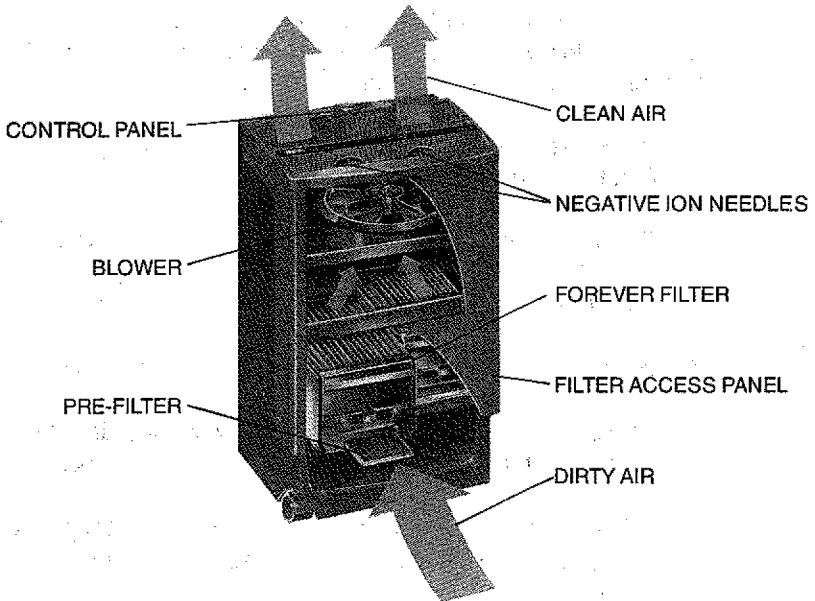

## HOW IT WORKS

**Stage One - Pre-Filter:** As dirty air is forced through the unit, large airborne particles are trapped by the Pre-filter.

**Stage Two - Forever Filter™ - Ionizer:** Airborne particles such as dust, smoke and pollen pass through the ionizer section and receive an electrical charge.

**Stage Three - Forever Filter™ - Collector:** Charged particles are collected, like a powerful magnet, on a series of alternately charged collection plates.

**Stage Four - Negative Ion Generator:** Emits negative ions into the air that freshens stale air. In addition, it also charges existing airborne particles so they can be collected by the Forever Filter™.

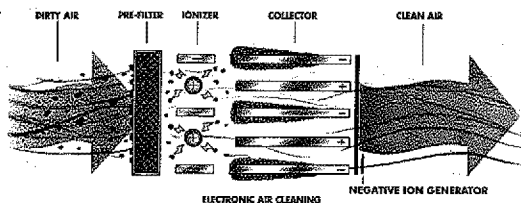

**NOTE:** Since the collected dirt is distributed across several metal plates inside the Forever Filter™, it may take awhile to notice the accumulated dirt with the naked eye.

## PLACEMENT OF AIR CLEANER

- ◆ Your air cleaner should be placed where air can freely move in, out and around it.
- ◆ Do not place the unit
  - (1) Directly on or against any soft furnishings such as bedding or curtains.
  - (2) Near computers, radios, TVs or other electronically sensitive devices
  - (3) Near sources of heat (such as stove tops, or ovens)
- ◆ Please keep in mind that the air movement created by the air cleaner will draw any airborne particles towards it. Depending on the specific types and weight of airborne particles present in your environment, some particles may fall onto other surfaces in the general vicinity of the air cleaner before reaching the air cleaner.

**DO NOT use where oxygen or combustible gases are in use!**

## OPERATION

**WARNING:** To reduce the risk of electrical shock, this equipment is supplied with a 3-prong power cord with a grounding lug on the plug. It is intended to be used with a standard 3-prong 120 volt AC outlet. If the plug does not fit your outlet, contact qualified personnel to install the proper receptacle. DO NOT alter the plug in any way.

The operation of the unit is very simple. Turn it on by setting the green control switch to high (3), med (2) or low (1). When the Clean Air Light (green) is on, this is an indication that the Forever Filter™ is working properly. The light will NOT be on when the switch is in the "Quick Dry" position. The "Quick Dry" position is provided for drying the filter after cleaning.

## OPERATION NOTES

1. The speed should be set on high (3) for two minutes before switching to the desired speed to initially start the unit.

### Control Panel Diagram

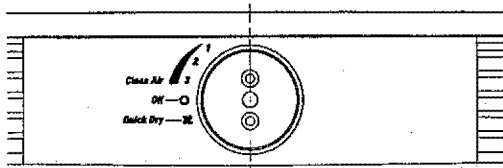

2. Your Sears Kenmore Air Cleaner is equipped with a Negative Ion Generator (Ionizer). The negative ions are discharged through needles located just beneath the air discharge grill.

If you place your hand close to the negative ion field generated by the needles (within 6-12 inches of the grill) for a period of time, and then touch a grounded (metal) object, you may experience a mild static discharge similar to the static electricity charge from "carpet shock". The static discharge is simply a result of the negative ions that have built up on your hand being discharged to ground.

Please note that there is no cause for alarm should this occur. Your air cleaner is not defective.

## CLEANING AND CARE

In addition to the exterior of the unit, there are three areas that require periodic cleaning: the pre-filter, the Forever Filter™, and the Negative Ion Generator Needles.

### ACCESS TO FILTERS

Before performing any maintenance, turn the unit to the OFF position and unplug the power cord.

To access the filters for cleaning, simply place your hands on each side of the front access panel and pull towards you.

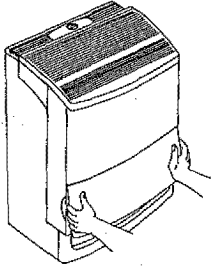

### CLEANING THE FOREVER FILTER™

Please use care when handling the Forever Filter™ to ensure you do not damage the ionizing wires or metal plates.

1. Remove access panel as described above.
2. Pivot tension clips 90 degrees (horizontal orientation) to release the Forever Filters™.
3. Pull on the plastic handles at the base of the Forever Filter™.
4. After removing the Forever Filter™, the Pre-Filter can be easily slid out of its track (please see instructions for cleaning the Pre-Filter).

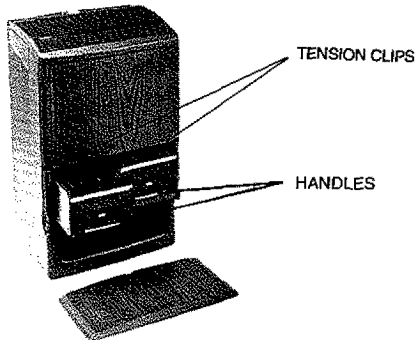

The twin Forever Filters™ should be cleaned every one to three months depending on the conditions in your particular environment. Failure to clean the Forever Filter periodically will degrade performance of the air cleaner.

The filter can be washed with Zap-It cleaner sold through Sears (Sears stock # 8395) or with a dishwashing detergent such as Electrasol.

If using Zap-It, spray the filter with water and then spray the metal plates with Zap-It. Allow to soak for 5-10 minutes before rinsing with water.

Or

If using dishwashing detergent, completely immerse the Forever Filter™ in hot soapy water for 20 to 30 minutes.



Rinse it off, using a sprayer if available.

Shake as much water from the filter as possible. After the first cleaning, the metal surface of the electronic filter may not be as shiny as before. This is normal and does not reduce effectiveness.

### **CLEANING THE PRE-FILTER**

1. Remove the filter from its rack.
2. Simply rinse the pre-filter in warm soapy water.
3. Shake off the excess water.
4. Return to its rack on the air intake of the Forever Filter™

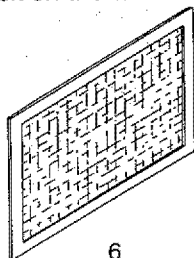

## REINSTALLING FOREVER FILTERS™

1. Ensure the Pre-filter is placed in the tracks provided on the bottom side of the Forever Filter™ (same side as plastic handles).
2. Return the Forever Filters™ to their original position in the air cleaner.
3. Pivot the tension clips back to their original position (vertical orientation) to ensure the Forever Filter™ is properly located.
4. Replace the front access panel by inserting the top first and then push the lower outside corners toward the rear of the cabinet until it snaps into place.

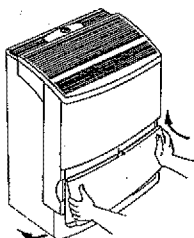

5. After reinstalling the cleaned filters in the unit, operate the unit in the "Quick Dry" position for about two hours to ensure the filter is thoroughly dry (Failure to dry the filters may cause permanent damage to the Forever Filters™).

**NOTE:** If access panel does not close securely, check to make sure that the Forever Filters are properly installed. The plastic handles should be at the bottom.

## CLEANING THE NEGATIVE ION NEEDLE

When cleaning the Forever Filters™, you should also take a cotton swab dipped in water or alcohol and wipe the two needles located beneath the air discharge grill.

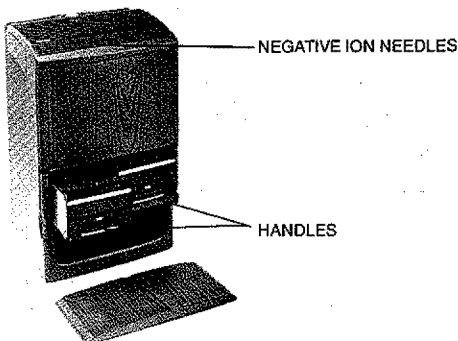



## DIAGNOSTIC CHECKLIST

Should you ever have any questions or concerns about the operation of your Kenmore Air Cleaning System, you may want to check this chart first. If the problem persists, call our Help Line.

Condition	Checkpoints
<b>Unit won't come on</b>	Make sure that the power cord is plugged in
	Set the Rotary Switch to the desired speed
	Make sure that the Front Access Panel is properly installed
	Make sure Forever Filter™ is properly installed
<b>Unit does not operate on Low (1) Speed</b>	Run on High (3) for two minutes then reset to Low (1) Speed
<b>Unit does not remove pollutants</b>	Wash Forever Filter™
<b>Unit snaps or pops</b>	Wash the Forever Filter™ and make sure that it is thoroughly dry
	Make sure ionizing wires in Forever Filter™ are not broken
	Check for bent plates in Forever Filter™ - straighten if possible
	Check for large particles such as hair or lint on ionizing wires. Remove if possible
<b>Interference with Radio and TV</b>	Move unit to a different location away from TV or Radio. Do not operate unit on the same electrical outlet as TV or Radio
	Clean Forever Filter™ if dirty
<b>Unit does not operate properly</b>	Call Help Line/ Have unit serviced

The Help Line: 1 800/227-3917

## **QUESTIONS & ANSWERS**

### **How can I get the most out of my air cleaner?**

For peak efficiency in maintaining air quality, we recommend that the unit be run continuously at least at its lowest speed. The daily operating cost of an electronic air cleaner running at the lowest speed is about the same as for a single 35 watt light bulb. Just pennies a day.

When you use the air cleaner, you will want to have your windows closed for maximum efficiency.

### **My air cleaner occasionally makes a snapping sound. . .**

You may notice an occasional light snapping sound coming from your unit. This may happen when a large particle is charged in the Forever Filter™. This is completely normal and is no cause for concern.

# REPLACEMENT PARTS

Please order by Part Number and not by Key Number  
 When ordering replacement parts always give the model number,  
 part number and description.

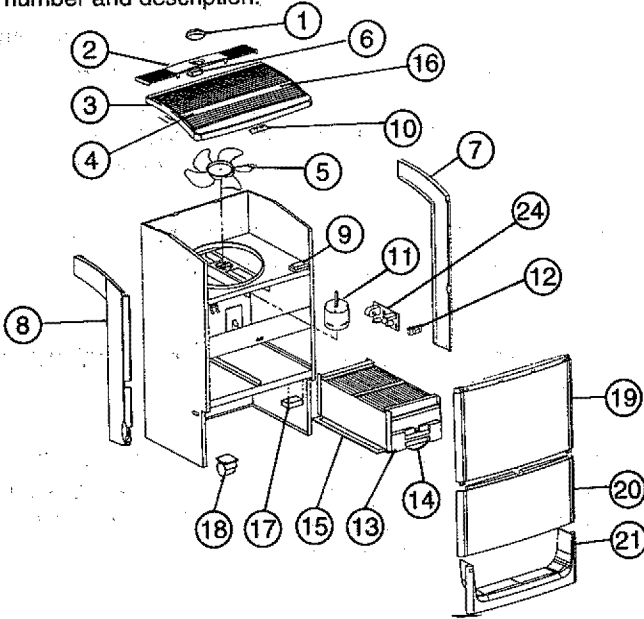

Item No.	Part Number	Description
1	250071-001	Control knob
2	450039-001	Control panel
3	450038-001	Discharge Grill
4	350247-001	Product Label
5	350244-001	Fan
6	150496-001	Control Switch
7	450041-001	Right Side Panel
8	450042-001	Left Side Panel
9	250494-002	Negative Ion Generator
10	150617-001	Negative Ion Needle Assembly
11	250243-001	Motor
12	250121-001	Transformer
13	350074-001	Forever Filter™ (2 required)
14	150218-001	Filter Handle
15	250307-001	Pre-filter (2 required)
16	250248-001	LED Assembly
17	242404-002	Interlock Switch
18	245998-001	Casters (4 required)
19	450043-001	Front Panel
20	450044-001	Filter Access Panel
21	450040-001	Intake Bezel
22	250250-001	Power Cord (Not Shown)
23	150255-001	Owner's Manual (Not shown)
24	349960-002	Power Supply

## TECHNICAL SPECIFICATIONS

Dimensions	Height	26 1/2"
	Width	16 1/4"
	Depth	11 3/4"
Weight	37 lbs	
Air Flow	Hi	350 CFM
	Med	250 CFM
	Low	125 CFM
Input Voltage	120V/60Hz	
Power Consumption	Hi	105 watts
	Med	55 watts
	Low	35 watts

Sears reserves the right to change or modify any specifications without notice.

### CUSTOMER ASSISTANCE LINE

Please DO NOT attempt to repair this unit yourself. Doing so will void your warranty and could cause damage to the Air Cleaner or personal injury to yourself. If you have any questions concerning this appliance, please call toll free:

**1-800-227-3917**

Mon.-Fri., 8 a.m.-5 p.m. EST

Model No. 635.83147

Sears Roebuck and Co.  
3333 Beverly Road  
Hoffman Estates, IL 60179

**The Help Line 1-800-227-3917**



## Free Manuals Download Website

<http://myh66.com>

<http://usermanuals.us>

<http://www.somanuals.com>

<http://www.4manuals.cc>

<http://www.manual-lib.com>

<http://www.404manual.com>

<http://www.luxmanual.com>

<http://aubethermostatmanual.com>

Golf course search by state

<http://golfingnear.com>

Email search by domain

<http://emailbydomain.com>

Auto manuals search

<http://auto.somanuals.com>

TV manuals search

<http://tv.somanuals.com>