

DPX504U DPX404U DPX304

DUAL DIN SIZED CD RECEIVER
INSTRUCTION MANUAL

Kenwood Corporation

Before reading this manual, click the button below to check the latest edition and the modified pages.



Contents

Before use	4	Operation of hands-free phoning	28
Component names and functions	6	Connecting a Bluetooth Device	
General operation	8	Receiving a Call	
Before Using		During a Call	
Common Operation		Call Waiting	
Function setting Operation		Other Functions	
iPod/iPhone Operation	10	Making a Call	
Basic Operation		Speed Dialing (Preset Dial)	
Selecting a song by browsing iPod		Calling a Number in the Phone Book	
Play function		Calling a Number in the Call log	
iPod Control by Hand Mode		Dial a Number	
iPod Setting		Make a Voice Dialing Call	
Selecting the Search mode		Registering to the Preset Dial Number List	
Related Search		Display of Phone Number type (category)	
Direct Search		Display Settings	36
Alphabet Search		Display type select	
My Playlist		Display Setting	
USB device Operation	16	Text scroll	
Basic Operation		Selecting text display	
File Search		Information display setting	
Play function		Text Display Selection	
USB Setting		Illumination Color Selection	
Music CD/ Audio file Operation	18	Auxiliary Input Display Setting	
Basic Operation		Clock and Other Functions	42
Music Search		Clock and Date Adjustment	
Play function		Dual clock city setting	
Basic Operation of Disc Changer (Optional)		Clock Adjustment	
Tuner Operation	20	Initial Settings	
Basic Operation		Demonstration mode Setting	
Tuner Setting		Muting volume upon reception of Phone call	
Station Preset Memory		Activating Security Code	
Auto Memory Entry		Deactivating Security Code	
Preset Tuning		Audio Adjustments – DPX504U –	48
PTY (Program Type)		Audio Control	
Program Type Preset		Preset Equalizer curve Select	
Changing Language for PTY Function		Manual Equalizer Control	
Bluetooth Audio Operation	26	Listening Position Selection	
Connecting a Bluetooth Device		Listening Position Fine Adjustments	
Basic Operation		Dual Zone System	
		Audio Adjustments	52
		– DPX404U/ DPX304 –	
		Audio Control	

DSP Setup **54**

- Car Type Selection
- Speaker Setting
- Car Type Fine Adjustments
- X'Over Setting
- Audio Preset Memory
- Audio Preset Recall

Log Function **58**

- Log Function recall
- Log Function item lock
- Deleting a Log Function item
- Log Function category setting
- Tuner Log Function time setting

Bluetooth Setup **62**

- Bluetooth Setting
- Registering Bluetooth device
- Registering PIN Code
- Selecting the Bluetooth device You Wish to Connect
- Deleting a Registered Bluetooth device
- Downloading the Phone Book
- Adding a Voice Dialing Command
- Setting a Voice Command for Category

SMS (Short Message Service) **70**

- Downloading the SMS
- SMS (Short Message Service)

Appendix **72**

Troubleshooting Guide **74**

Specifications **78**

Before use

Before using this unit for the first time

This unit is initially set on the Demonstration mode. When using this unit for the first time, cancel the Demonstration mode. Refer to <Demonstration mode Setting> (page 45).

▲ WARNING

To prevent injury or fire, take the following precautions:

- Stop the car before operating the unit.
- To prevent a short circuit, never put or leave any metallic objects (such as coins or metal tools) inside the unit.

▲ CAUTION

- Adjust the volume so that you can hear sounds outside the car. Driving with the volume too high may cause an accident.
- Wipe off the dirt on the panel with a dry silicon or soft cloth.
Failure to observe this precaution may result in damage to the monitor or unit.





Condensation

When the car is air-conditioned, moisture may collect on the laser lens. This may cause disc read errors. In this case, remove the disc and wait for the moisture to evaporate.

Notes

- If you experience problems during installation, consult your Kenwood dealer.
- When you purchase optional accessories, check with your Kenwood dealer to make sure that they work with your model and in your area.
- Characters that conform to ISO 8859-1 can be displayed.
- Characters that conform to ISO 8859-5 or ISO 8859-1 can be displayed. Refer to "Russian"/"RUSSIAN SET" of <Initial Settings> (page 44).
- The Radio Data System feature won't work where the service is not supported by any broadcasting station.
- The illustrations of the display and the panel appearing in this manual are examples used to explain more clearly how the controls are used. Therefore, what appears on the display in the illustrations may differ from what appears on the display on the actual equipment, and some of the illustrations on the display may be inapplicable.

About discs used with this unit

- This unit can only play the CDs with    
- The following discs cannot be used:
 - Discs that are not round
 - Discs with coloring on the recording surface or discs that are dirty
 - Recordable/Rewritable disc that has not been finalized (For the finalization process, refer to your disc writing software, and your disc recorder instruction manual.)
 - 8 cm (3 inch) disc (Attempt to insert using an adapter can cause malfunction.)

Handling discs

- Do not touch the recording surface of the disc.
- Do not stick tape etc. on the disc, or use a disc with tape stuck on it.
- Do not use any accessories for the disc.
- Do not use any solvents to clean discs. Use a dry silicon or soft cloth.
- Clean from the center of the disc and move outward.
- When removing discs from this unit, pull them out horizontally.
- Remove the rims from the center hole and disc edge before inserting a disc.

How to reset your unit

If the unit fails to operate properly, press the Reset button. The unit returns to factory settings when the Reset button is pressed.

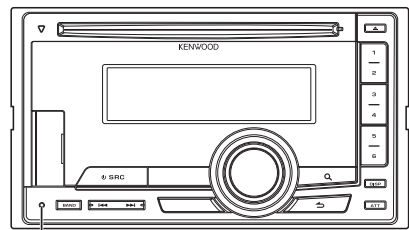

Reset button

Component names and functions

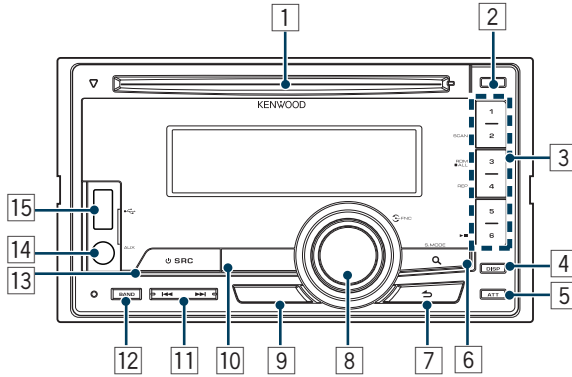

1 Disc slot

When inserted a disc (label side up), the source is switched automatically and a song starts playing.

2 [▲] button

To eject the disc.

3 [1] – [6] button

To recall the memorized station.

Switches the play mode between music discs, Audio files, and iPod.

4 [DISP] button

To change the display mode.

5 [ATT] button

Turning the volume down quickly.

6 [Q] button

To enter the music search mode.

To enter the PTY mode.

To turn on and off the Traffic information mode. (press the button at least 1 second)

7 [↶] button

To return to previous item.

8 [VOL] knob

To adjust volume.

Enters function setting mode and setting item (turn and press the knob). Refer to [<Function setting Operation>](#) (page 9) for details.

9 [DPX504U]

[LOG] button

To display a Log Function list.

[DPX404U] [DPX304]

[B.BOOST] button

To boost the bass tone in two steps (LV1, LV2, OFF).

10 [DPX504U] [DPX404U]

[iPod] button

Select the iPod source.

[DPX304]

[▶||] button

To start or interrupt playback for CD and Audio file.

Mute the volume. (During Tuner, AUX source)

11 [◀◀] / [▶▶] button

To select a station, song and setting items.

12 [BAND] button

To select the receiving band, and the folder for Audio file.

13 [SRC] button

To turn on this unit and select the Source.

To turn off this unit (press the button at least 1 second).

14 Auxiliary Input Terminal

Portable audio device can be connected with the mini-plug (3.5 mm \emptyset).

- Use the mini-plug cable which is stereo type and does not have any resistance.

15 [DPX504U] [DPX404U]

USB Terminal

When connecting, open up the USB terminal lid. A USB device or an iPod can be connected.

General operation

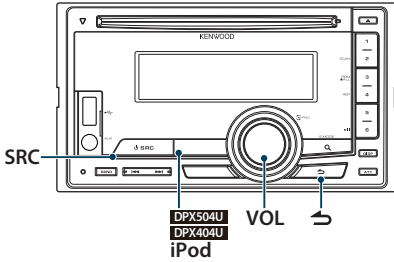

Before Using

Canceling the Demonstration Mode

Cancel the demonstration mode when you use it for the first time after installation.

- 1 Press the [VOL] knob to cancel the demonstration mode when the messages "To cancel DEMO press the volume knob"/"CANCEL DEMO PRESS VOLUME KNOB" are displayed (approx. 15 seconds).
- 2 Turn the [VOL] knob to select "YES" and press the [VOL] knob.



- Demonstration mode can also be cancelled in "DEMO Mode" of Function setting mode. Refer to [<Demonstration mode Setting>](#) (page 45).

Common Operation

Power and source select

Turns the power ON by pressing the [SRC] button.

When the power is ON, select a source. Press the [SRC] button each time switches between sources.

Tuner ("TUNER") → USB ("USB") or iPod ("iPod") (DPX504U/ DPX404U only) → CD ("CD") → Auxiliary input ("AUX") → Standby ("STDBY"/ "STANDBY") → Tuner...

DPX504U DPX404U

Press the [iPod] button to switch the source to iPod.

Press the [SRC] button for at least 1 second to turns the power OFF.



- The SRC Select mode can be set in "SRC Select" of [<Initial Settings>](#) (page 44). (DPX504U only)
- When an optional accessory is connected, the source name for each device appears. (DPX504U only)
- When connection of the iPod is recognized, the source display changes from "USB" to "iPod".
- This unit automatically turns full power OFF after 20 minutes lapses in Standby mode in order to save the vehicle's battery. The time until full power OFF can be set in "Power OFF Wait" of [<Initial Settings>](#) (page 44).

Volume

Turning the [VOL] knob adjusts the sound volume.

Function setting Operation

The basic operating procedure for using this function is described below. The individual function items are covered in the operating procedures.

1 Select the source

Press the [SRC] button.

Function items vary from source to source.

2 Enter Function setting mode

Press the [VOL] knob.

3 Select the setting item

Turn the [VOL] knob and press it when the desired item is displayed.

Repeat the operation until your desired setup item is selected.

Operation example:

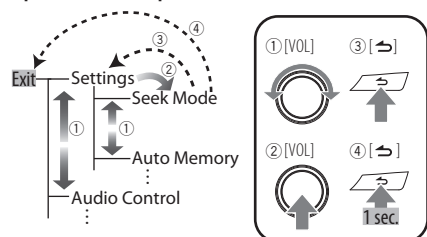

In this manual, the above selection is indicated as **Select "Settings"/"SETTINGS" > "Seek Mode"/"SEEK MODE"**.

4 Make a setting

Turn the [VOL] knob to select a setting value, and then press the [VOL] knob.

5 Exit Function setting mode

Press the [↵] button for at least 1 second.

iPod/iPhone Operation

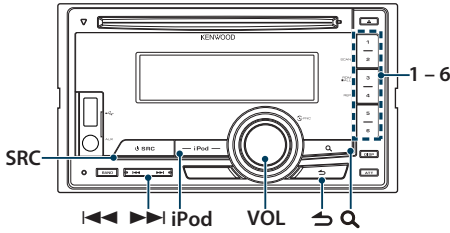

Basic Operation

Playing iPod

- **Connect an iPod**
When connected, the source is switched automatically and a song starts playing.
- **Select iPod source**
Press the [iPod] button.



- KCA-iP101/iP102 (optional accessory) is recommended to connect an iPod.

Song Select

Press the [◀◀] or [▶▶] button.

Fast Forwards or Fast Backwards

Hold down the [◀◀] or [▶▶] button.

Pause and Play

Press the [6] button to pause or resume playback.

Remove iPod

- 1 **Select a source other than the iPod**
Press the [SRC] button.
- 2 **Remove the iPod.**



- Removing the iPod with it selected as a source can damage the data stored in the iPod.

Selecting a song by browsing iPod

Searching for the song you want to play.

- 1 **Select iPod source**
Press the [iPod] button.
- 2 **Enter Music search mode**
Press the [Q] button.
- 3 **Select a song**

Operation type	Operation
Move between items	Turn the [VOL] knob.
Select an item	Press the [VOL] knob.
Skip Search	Press the [◀◀] or [▶▶] button.
Return to previous item	Press the [↶] button.

↶ For example: Searching by Artist name.

Turn the [VOL] knob and press it when the desired item is displayed.

Select "Artists"/"ARTISTS" > Artist name > Album name > Song title

Cancelling Enter Music search mode

Press the [↶] button for at least 1 second.



- Characters which cannot be displayed are left blank. If non of the characters can be displayed, the browse item name and digits are displayed.

Items	Display	Items	Display
Playlists	"PLIS****"	Podcasts	"PDCT****"
Artists	"ART****"	Genres	"GEN****"
Albums	"ALB****"	Composers	"COM****"
Songs	"PRGM****"		

- Set the ratio with "Skip Search" in <iPod Setting> (page 12).

Play function

Repeat play

Press the [4] button.

Switches between Repeat ("File Repeat ON"/"FILE REPEAT") and off ("File Repeat OFF"/"REPEAT OFF") when pressed.

Random play

Press the [3] button.

Randomly plays the music.

Pressing the button toggles the setting between Random play on ("Folder Random ON"/"FOLDER RANDOM") and off ("Folder Random OFF"/"RANDOM OFF").

Press this button again cancels the Random play.

All Random play

Press the [3] button for at least 1 second.

All songs in iPod are played at random.

Pressing the button toggles the setting between All random play on ("All Random ON"/"ALL RANDOM") and off ("All Random OFF"/"RANDOM OFF").

Press this button again cancels the All Random play.



- The time required to turn on the all random function may become longer depending on the number of songs in iPod.
- Turning on the all random function changes the iPod browse item to "Songs". This browse item will not be changed even if the all random function is turned off.
- If the browse item is changed to search for music while the all random function is on, the all random function is turned off and the songs in the browse item are played at random.

iPod Control by Hand Mode

Allowing you to operate iPod with the control on the iPod.

Press the [iPod] button for at least 1 second.

When the iPod control by hand mode is selected, "iPod by Hand Mode"/"HANDS ON" is displayed.



- In the iPod Control by hand mode, iPod cannot be operated using this unit.
- This mode is not compatible with music information display. The display will show "iPod by Hand Mode"/"iPod MODE".
- iPod can be operated when it conforms to the iPod control function.

iPod/iPhone Operation

iPod Setting

You can select the following iPod Setting items.

1 Select iPod source

Press the [iPod] button.

2 Enter Function setting mode

Press the [VOL] knob.

3 Turn the [VOL] knob and press it when the desired item is displayed.

Select "Settings"/"SETTINGS".

4 Select the setting item

Turn the [VOL] knob and press it when the desired item is displayed.

Display	Overview
"Settings"/ "SETTINGS"	
"Skip Search"/ "SKIP SEARCH"	Sets the ratio of skip performed with <Skip Search> (page 10). "0.5%"/"1%"/"5%"/"10%"
"Delete My Playlist"/"MPLIST DELETE"	Deletes the registered My Playlist. Refer to <Deleting a Song from the Playlist> (page 14) for the operation.

(__ : Factory setting)

5 Make a setting

Turn the [VOL] knob to select a setting value, and then press the [VOL] knob.

6 Exit Function setting mode

Press the [↵] button for at least 1 second.



- The setting of "Skip Search" in <iPod Setting> (page 12) and that in <USB Setting> (page 17) are always the same. Changing the setting of one reflects the other.

Selecting the Search mode

You can select the most suited search method for the desired song from 4 types of the Search mode.

Search mode	Operation	Overview
"Related Search"/ "RELATED SRCH"	Press the [1] button.	Searches for music of the same artist or genre as the one being played. Refer to the <Related Search> (page 13).
"Direct Search"	Press the [2] button.	You can quickly search the desired song by specifying its Search item (artist, album, etc.) and initial. Function of DPX504U. Refer to <Direct Search> (page 13).
"Alphabet Search"/ "ALPHABET SRCH"	Press the [3] button.	You can select an alphabetic character from the list in the Search item (artist, album, etc.) selected now. Refer to <Alphabet Search> (page 14).
"Register My Playlist"/"Recall My Playlist"/ "MY PLAYLIST"	Press the [5] button.	Registers a song to My Playlist. Refer to <My Playlist> (page 14).

1 Select iPod source

Press the [iPod] button.

2 Enter Music search mode

Press the [Q] button.

3 Select the Search mode

Press the [1]/ [2]/ [3]/ [5] button.

Canceling Music search mode

Press the [↵] button for at least 1 second.

Related Search

Searches for music of the same artist or genre as the one being played.

1 Select iPod source

Press the [iPod] button.

2 Enter Music search mode

Press the [Q] button.

3 Enter Related search mode

Press the [1] button.

4 Select the Search item

Turn the [VOL] knob and press it when the desired Search item is selected.

Display	Searches music
"Search Artist"/ "SRCH ARTIST"	Displays the album of the same artist.
"Search Album"/ "SRCH ALBUM"	Displays music in the album in which the one being played is included.
"Search Genre"/ "SRCH GENRE"	Displays the artist of the same genre.
"Search Composer"/ "SRCH COMPOSER"	Displays the album including music created by the same Composer.

After this step, you need to browse. See step 3 of [<Selecting a song by browsing iPod> \(page 10\)](#) to select a song.

Canceling the Related search

Press the [↵] button for at least 1 second.



- Related search cannot be performed while playing the Podcast.
- When the music being played has no information on browsing items or no music was found, "Not Found"/"NOT FOUND" is displayed.

Function of DPX504U

Direct Search

You can quickly search the desired song by specifying its Search item (artist, album, etc.) and initial.

1 Select iPod source

Press the [iPod] button.

2 Enter Music search mode

Press the [Q] button.

3 Enter Direct Search mode

Press the [2] button.

4 Select the Search item

Turn the [VOL] knob and press it when the desired Search item is selected.

Display	Items	Display	Items
"PLAY LIST"	Playlists	"PODCAST"	Podcasts
"ARTIST"	Artists	"GENRE"	Genres
"ALBUM"	Albums	"COMPOSER"	Composers
"SONG"	Songs		

5 Select the character to be searched for

Operation type	Operation
Move between items	Turn the [VOL] knob.
Select an item	Press the [VOL] knob.
Move to the next column	Press the [◀◀] or [▶▶] button.

Up to 3 characters can be entered.

6 Determine the selected initial

Turn the [VOL] knob and press it when the desired item is displayed.

Select "DONE".

Start search. When search is completed, the music search mode is selected again at the selected character position.

After this step, you need to browse. See step 4 of [<Selecting a song by browsing iPod> \(page 10\)](#) to select a song.

Canceling the Direct Search

Press the [↵] button for at least 1 second.



- Characters that can be entered are alphabetical characters (A to Z), numerical characters(0 to 9), and " * ".
- " * " indicates characters other than alphabetical and numerical characters. You cannot enter any more characters when entering " * " in the first character position.
- If the first character string begins with an article "a", "an", or "the" in the Direct Search mode, it is searched for in defiance of the article.

iPod/iPhone Operation

Alphabet Search

You can select a song by alphabet. This function searches songs whose name contain the specified character(s) in the list of the selected Search item (artist, album, etc).

- 1 Select iPod source**
Press the [iPod] button.
- 2 Enter Music search mode**
Press the [Q] button.
- 3 Select search item**
Turn the [VOL] knob and press it when the desired item is displayed.
Select the item (artist, album, etc.) you want to search.
- 4 Enter Alphabet Search mode**
Press the [3] button.
- 5 Search for song**

DPX504U

Operation type	Operation
Select the character	Turn the [VOL] knob.
Select an item	Press the [VOL] knob.

DPX404U

Operation type	Operation
Select the character	Turn the [VOL] knob.
Move the cursor to the enter character position	Press the [◀◀] or [▶▶] button.
Determine the selected character	Press the [VOL] knob.

Canceling the Alphabet Search

Press the [↵] button for at least 1 second.



- The time of search by alphabet may become long depending on the number of songs or items in iPod.
- If the first character string begins with an article "a", "an", or "the" in the Alphabet Search mode, it is searched for in defiance of the article.

My Playlist

Allows you to register your favorite songs in the Playlist of this unit. You can register up to 10 songs in the Playlist.

Registering Songs in the Playlist

- 1 Play the song you want to register**
- 2 Register the song**
Press the [5] button for at least 2 second.
"## Stored"/"## STORED" (Registration number) is displayed.



- Make a Playlist from the songs stored in one iPod. If you attempt to register a song stored in a different iPod, "No Information"/"NO INFO" appears and then "Delete My Playlist All Delete?"/"MPLIST DELETE" appears. Select "YES" to delete the Playlist when you want to remake it.
- If you attempt to register the eleventh song, "Memory Full"/"MEMORY FULL" appears and you cannot register it accordingly. To register the song, delete an unnecessary song.
- Do not register Podcasts. Songs you do not want to register may be registered, or playback may not be carried out correctly.

Playing the Song in the Playlist

- 1 Enter Playlist mode**
Press the [5] button.
- 2 Play the song in the Playlist**
Turn the [VOL] knob and press it when the desired item is displayed.
Select the song you want to play.



- Turning ACC OFF or the power OFF cancels the My Playlist mode.
- The ending of a song may be cut unless the song has a silence of 1 second or longer at the end.
- Random play cannot be performed during playback of a song in the Playlist.

Deleting a Song from the Playlist

- 1 Enter Playlist mode**
Press the [5] button.
- 2 Enter Delete Playlist mode**
Press the [VOL] knob for at least 1 second.
- 3 Select Delete Playlist mode**
Turn the [VOL] knob and press it when the desired item is displayed.
Select "Delete One"/"DELETE ONE" or "Delete All"/"DELETE ALL".

- 4 Turn the [VOL] knob to select "YES", and then press the [VOL] knob.

"Completed"/"COMPLETED" is displayed.

Deleting the all song from the Playlist (In Function setting mode)

- 1 Enter Function setting mode

Press the [VOL] knob.

- 2 Enter Delete Playlist mode

Turn the [VOL] knob and press it when the desired item is displayed.

Select "Settings"/"SETTINGS" > "Delete My Playlist"/"MPLIST DELETE".

- 3 Turn the [VOL] knob to select "YES", and then press the [VOL] knob.

"Completed"/"COMPLETED" is displayed.



- If you connect the different iPod from one registered to My Playlist, "Delete One"/"DELETE ONE" and "Delete All"/"DELETE ALL" will not appear and all songs be deleted.

USB device Operation

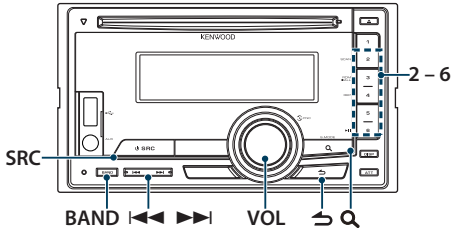

Basic Operation

Playing USB device

- **Connect a USB device**
When connected, the source is switched automatically and a song starts playing.
- **Select USB source**
Press the [SRC] button.
Select the "USB" display.



- CA-U1EX (optional accessory) is recommended to connect a USB device.

Moving to the next folder

Press the [BAND] button.



- The Music Editor media does not allow you to select a folder.

Song Select

Press the [◀◀] or [▶▶] button.

Fast Forwards or Fast Backwards

Hold down the [◀◀] or [▶▶] button.



- No sound is output while playing Audio file.

Pause and Play

Press the [6] button to pause or resume playback.

Remove USB device

- 1 **Select a source other than the USB**
Press the [SRC] button.
- 2 **Remove the USB device.**



- Removing the USB device with it selected as a source can damage the data stored in the USB device.

File Search

Selecting the file you want to listen to from the device being played now.

- 1 **Select USB source**
Press the [SRC] button.
Select the "USB" display.
- 2 **Enter Music search mode**
Press the [Q] button.
- 3 **Select a file**

Operation type	Operation
Move between items	Turn the [VOL] knob.
Select an item	Press the [VOL] knob.
Skip Search (Function of Music Editor media)	Press the [◀◀] or [▶▶] button.
Return to previous item	Press the [↶] button.

➤ For example: Searching for ♪②.

Turn the [VOL] knob and press it when the desired item is displayed.

Select "Music" > [1] > [2] > ♪②

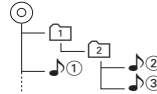

Canceling Music search mode

Press the [↷] button for at least 1 second.



- Set the ratio with "Skip Search" in <USB Setting> (page 17).

Play function

Scan play

Press the [2] button.

Successively plays the intro of the music in the folder.

When Scan Play is turned on, "File Scan ON"/"FILE SCAN" is displayed.

Pressing this button again plays songs in the normal mode starting with the song being played now.

Random play

Press the [3] button.

Randomly plays the music in the folder.

When Random Play is turned on, "Folder Random ON"/"FOLDER RANDOM" is displayed.

Press this button again cancels the Random play.

Repeat play

Press the [4] button.

Switches between File Repeat ("File Repeat ON"/"FILE REPEAT"), Folder Repeat ("Folder Repeat ON"/"FOLDER REPEAT"), and OFF ("Folder Repeat OFF"/"REPEAT OFF") when pressed.



- The Music Editor media does not allow you select folder repeat play.

USB Setting

You can select the following USB Setting items.

1 Select USB source

Press the [SRC] button.

Select the "USB" display.

2 Enter Function setting mode

Press the [VOL] knob.

3 Turn the [VOL] knob and press it when the desired item is displayed.

Select "Settings"/"SETTINGS".

4 Select the setting item

Turn the [VOL] knob and press it when the desired item is displayed.

Display	Overview
"Settings"/ "SETTINGS"	
"Skip Search"/ "SKIP SEARCH"	Sets the ratio of skip performed with <Skip Search (Function of Music Editor media)> (page 16). "0.5%"/"1%"/"5%"/"10%"

(__ : Factory setting)

5 Make a setting

Turn the [VOL] knob to select a setting value, and then press the [VOL] knob.

6 Exit Function setting mode

Press the [↩] button for at least 1 second.



- The setting of "Skip Search" in <iPod Setting> (page 12) and that in <USB Setting> (page 17) are always the same. Changing the setting of one reflects the other.

Music CD/ Audio file Operation

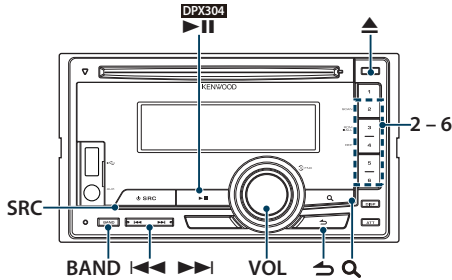

Basic Operation

Disc play

- Insert a disc.
When inserted, the source is switched automatically and a song is starts playing.
When a CD is inserted, the “IN” indicator is ON.
- Select CD source
Press the [SRC] button.
Select the “CD” display.

Disc ejection

Press the [▲] button.

Moving to the next folder

Press the [BAND] button.



- This operation can be performed only for the Audio file.

Song Select

Press the [◀◀] or [▶▶] button.

Fast Forwards or Fast Backwards

Hold down the [◀◀] or [▶▶] button.



- No sound is output while playing Audio file.

Pause and Play

DPX504U DPX404U

Press the [6] button to pause or resume playback.

DPX304

Press the [▶||] button to pause or resume playback.

Function of Internal CD source

Music Search

Selecting the music you want to listen to from the disc being played now.

- 1 Select CD source**
Press the [SRC] button.
Select the “CD” display.
- 2 Enter Music search mode**
Press the [Q] button.
- 3 Search for music**

Operation type	Operation
Move between items	Turn the [VOL] knob.
Select an item	Press the [VOL] knob.
Return to previous item	Press the [↶] button.

Canceling Function setting mode

Press the [↶] button for at least 1 second.

Play function

Scan play

Press the [2] button.

Successively plays the intro of the music in the disc or folder.

When Scan Play is turned on, "Track Scan ON"/ "TRACK SCAN"/ "File Scan ON"/ "FILE SCAN" is displayed.

Pressing this button again plays songs in the normal mode starting with the song being played now.

Random play

Press the [3] button.

Randomly plays the music in the disc or folder.

When Random Play is turned on, "Disc Random ON"/ "DISC RANDOM"/ "Folder Random ON"/ "FOLDER RANDOM" is displayed.

Press this button again cancels the Random play.

Repeat play

Press the [4] button.

Switches between Track Repeat ("Track Repeat ON"/ "TRACK REPEAT") and OFF ("Track Repeat OFF"/ "REPEAT OFF") when pressed while playing a CD.

Switches between File Repeat ("File Repeat ON"/ "FILE REPEAT"), Folder Repeat ("Folder Repeat ON"/ "FOLDER REPEAT"), and OFF ("Folder Repeat OFF"/ "REPEAT OFF") when pressed while playing an Audio file.

Function of DPX504U

Basic Operation of Disc Changer (Optional)

Select CD changer source

Press the [SRC] button.

Select the "CD CH" display.

Moving to the next disc

Press the [BAND] button.

Song Select

Press the [◀◀] or [▶▶] button.

Fast Forwards or Fast Backwards

Hold down the [◀◀] or [▶▶] button.

Pause and Play

Press the [6] button to pause or resume playback.

Playing the Current Song or Disc Repeatedly. (Repeat play)

Press the [4] button.

Switches between Track Repeat play on ("Track Repeat ON"), Disc Repeat play on ("Disc Repeat ON"), and Repeat play off ("Repeat OFF") when pressed.

Randomly plays the music in the disc changer. (Magazine random play)

Press the [5] button.

When Magazine random play is turned on, "Magazine Random ON" is displayed.

Press this button again cancels the Magazine random play.

Tuner Operation

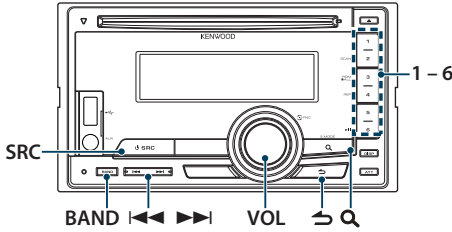

Basic Operation

Selecting Tuner source

Press the [SRC] button.

Select the "TUNER" display.

Selecting the Receiving Band

Press the [BAND] button.

Pressing the button switches the receiving band (FM1, FM2, FM3, AM).

Selecting the Receiving station

Press the [◀◀] or [▶▶] button.

Details of the station selecting in operation are set in the "Seek Mode"/"SEEK MODE" of <Tuner Setting> (page 20).

Traffic information

Press the [Q] button for at least 1 second.

Turns ON or OFF the Traffic Information function. When the function is set to ON, "TI" indicator is ON. If traffic bulletin starts when the function is ON, "Traffic INFO"/"TRAFFIC INFO" is displayed and traffic information is received.

If the volume is adjusted during reception of traffic information, the adjusted volume is memorized automatically. The memorized volume will be applied next time the Traffic Information function is turned ON.

Tuner Setting

You can select the following Tuner Setting items.

1 Select Tuner source

Press the [SRC] button.

Select the "TUNER" display.

2 Enter Function setting mode

Press the [VOL] knob.

3 Turn the [VOL] knob and press it when the desired item is displayed.

Select "Settings"/"SETTINGS".

4 Select the setting item to adjust

Turn the [VOL] knob and press it when the desired item is displayed.

Display	Overview
"Settings"/ "SETTINGS"	
"Local Seek"/ "LOCAL SEEK"	Only stations whose reception is good are searched in auto seek tuning. "ON"/"OFF"
"Seek Mode"/ "SEEK MODE"	Selects the tuning mode of the radio. "Auto1"/"AUTO1": Automatic search for a station. "Auto2"/"AUTO2": Search in order of the stations in the Preset memory. "Manual"/"MANUAL": Normal manual tuning control.
"Auto Memory"/ "AUTO MEMORY"	Memorizes 6 stations with good reception automatically. Refer to <Auto Memory Entry> (page 22).
"Forced MONO"/ "FORCED MONO"	Reduces the noise when stereo broadcasts are received as monaural. "ON"/"OFF"
"News"/"NEWS"	Turns ON/OFF the News Bulletin Automatic Reception function and sets the news bulletin interrupt disabled time. "OFF"/"00MIN"/"00M" – "90MIN"/"90M"
"AF"	When station reception is poor, automatically switches to the station that is broadcasting the same program over the same Radio Data System network. (AF: Alternative Frequency) "ON"/"OFF"
"Regional"/ "REGIONAL"	Sets whether to switch to the station only in the specific region using the "AF" control. "ON"/"OFF"
"Auto TP Seek"/ "AUTO TP SEEK"	When traffic information station reception is poor, automatically searches for a station that can be received better. "ON"/"OFF"

(_ : Factory setting)

5 Make a setting

Turn the [VOL] knob.

6 Exit Function setting mode

Press the [] button for at least 1 second.

Remarks

• News (News Bulletin with Timeout Setting)

Automatically receives news bulletin when it starts. Set the time during which interrupt is to be disabled after start of another news bulletin. Changing "News 00MIN"/"NEWS 00M" to "News 90MIN"/"NEWS 90M" turns this function ON. If news bulletin starts when this function is ON, "News"/"NEWS" is displayed and news is received. If "20MIN"/"20M" is has been set, reception of another news bulletin will not start for 20 minutes. The news bulletin volume is the same level that was set for Traffic Information.



• Forced MONO

Strong electrical fields (such as from power lines) may cause unstable sound quality when it is set to ON. In such a situation, turn it OFF.

Station Preset Memory

Putting a station in the memory.

1 Select the frequency to put in the memory

Press the [] or [] button.

2 Select the number to put in the memory

Press the [1] – [6] button for at least 2 seconds.



- Up to 6 stations with a different band (FM/AM) can be memorized to the [1] – [6] button according to the setting of "Tuner Preset Type"/"PRESET TYPE" of <Initial Settings> (page 44).

Tuner Operation

Auto Memory Entry

Putting stations with good reception in the memory automatically.

- 1 Select the radio band you wish to store in the preset memory**
- 2 Enter Function setting mode**
Press the [VOL] knob.
- 3 Enter Auto Memory Entry mode**
Turn the [VOL] knob and press it when the desired item is displayed.
Select "Settings"/"SETTINGS" > "Auto Memory"/"AUTO MEMORY".
- 4 Open Auto Memory Entry**
Turn the [VOL] knob and press it when the desired item is displayed.
Select "YES".

When 6 stations that can be received are put in the memory, auto memory entry closes.

Preset Tuning

Recalling the stations in the memory.

- 1 Select the radio band**
- 2 Recalls the memorized station**
Press the [1] – [6] button.

PTY (Program Type)

Selecting the Program Type below and searching for a station.

DPX504U

Program Type	Display	Program Type	Display
Speech	"Speech"	Serious Classical	"Classics"
Music	"Music"	Other Music	"Other M"
News	"News"	Weather	"Weather"
Current Affairs	"Affairs"	Finance	"Finance"
Information	"Info"	Children's programs	"Children"
Sport	"Sport"	Social Affairs	"Social"
Education	"Educate"	Religion	"Religion"
Drama	"Drama"	Phone In	"Phone In"
Culture	"Culture"	Travel	"Travel"
Science	"Science"	Leisure	"Leisure"
Varied	"Varied"	Jazz Music	"Jazz"
Pop Music	"Pop M"	Country Music	"Country"
Rock Music	"Rock M"	National Music	"Nation M"
Easy Listening Music	"Easy M"	Oldies Music	"Oldies"
Light Classical	"Light M"	Folk Music	"Folk M"
		Documentary	"Document"

DPX404U | DPX304

Program Type	Display	Program Type	Display
Speech	"SPEECH"	Serious Classical	"CLASSICS"
Music	"MUSIC"	Other Music	"OTHER M"
News	"NEWS"	Weather	"WEATHER"
Current Affairs	"AFFAIRS"	Finance	"FINANCE"
Information	"INFO"	Children's programs	"CHILDREN"
Sport	"SPORT"	Social Affairs	"SOCIAL"
Education	"EDUCATE"	Religion	"RELIGION"
Drama	"DRAMA"	Phone In	"PHONE IN"
Culture	"CULTURE"	Travel	"TRAVEL"
Science	"SCIENCE"	Leisure	"LEISURE"
Varied	"VARIED"	Jazz Music	"JAZZ"
Pop Music	"POP M"	Country Music	"COUNTRY"
Rock Music	"ROCK M"	National Music	"NATION M"
Easy Listening Music	"EASY M"	Oldies Music	"OLDIES"
Light Classical	"LIGHT M"	Folk Music	"FOLK M"
		Documentary	"DOCUMENT"

- Speech and Music include the Program type shown below.
Speech: Items in the white letters.
Music: Items in the black letters.

1 Enter PTY mode

Press the [Q] button.

2 Select the Program Type

Turn the [VOL] knob.

3 Search for the selected Program Type station

Press the [◀◀] or [▶▶] button.

4 Exit PTY mode

Press the [↵] button.



- When the selected Program Type is not found, "NO PTY"/ "NO PTY" is displayed. Select another Program Type.
- The operation ends automatically if you do not operate within 30 seconds.

Tuner Operation

Program Type Preset

Putting the Program Type in the Preset button memory and quick recall.

Presetting the Program Type

1 Select the Program Type to preset

Refer to <PTY (Program Type)> (page 23).

2 Preset the Program Type

Press the desired [1] — [6] button for at least 2 seconds.

Recalling the preset Program Type

1 Enter PTY mode

Press the [Q] button.

2 Recall the Program Type

Press the desired [1] — [6] button.

Changing Language for PTY Function

Selecting the Program Type display language as follows.

DPX504U

Language	Display	Language	Display
English	"English"	Norwegian	"Norwegian"
Spanish	"Spanish"	Portuguese	"Portuguese"
French	"French"	Swedish	"Swedish"
Dutch	"Dutch"	German	"German"

DPX404U DPX304

Language	Display
English	"ENGLISH"
French	"FRENCH"
German	"GERMAN"

1 Enter PTY mode

Press the [Q] button.

2 Enter Changing Language mode

Press the [Q] button.

3 Select the language

Turn the [VOL] knob and press it when the desired item is displayed.

Select a language.

Bluetooth Audio Operation

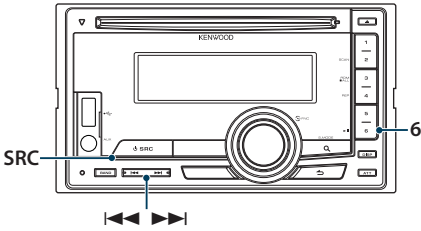

Connecting a Bluetooth Device

Before use the Bluetooth device, you need to connect Bluetooth device to this unit.

Pairing (Registering from Bluetooth devices)

To make your Bluetooth Audio player usable with this unit, you need to register it (pairing).

1 Turn on this unit

Press the [SRC] button.

2 Start registering this unit by operating the Bluetooth device

By operating the Bluetooth device, register the audio player (pairing). Select "KCA-BT200"/"KCA-BT300" from the list of connected units.

3 Enter a PIN code

Input the PIN code ("0000") in the Bluetooth device.

Check that registration is complete on the Bluetooth device.

↗ PIN code is set to "0000" as the default. You can change this code. Refer to [<Registering PIN Code>](#) (page 65).

4 By operating the Bluetooth device, start Bluetooth connection.



- If pairing does not succeed, try followings.
 - PIN code is set to "0000". See [<Registering PIN Code>](#) (page 65)
 - Turn off the power of this unit and turn it back on. And then try the pairing operation again.
 - If other audio players have been registered, delete them. And then try the pairing operation again. See [<Deleting a Registered Bluetooth device>](#) (page 66)
- When registering from this unit, refer to [<Registering Bluetooth device>](#) (page 64).

Basic Operation

Selecting Bluetooth Audio source

Press the [SRC] button.

Select the "BT Audio" display.

Pause and play

Press the [6] button.

Music Search

Press the [◀◀] or [▶▶] button.



- All or some of the operations above cannot be performed if the Bluetooth audio player is not ready for remote control.
- Switching between Bluetooth audio sources does not start or stop playback automatically. Perform the operation for starting or stopping playback.
- Some audio players cannot be controlled remotely or reconnected after Bluetooth disconnection. Operate the main unit of the audio player to connect Bluetooth.

Operation of hands-free phoning

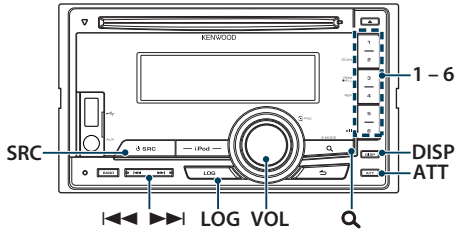

- When registering from this unit, refer to <[Registering Bluetooth device](#)> (page 64).

Connecting a Bluetooth Device

Before use the Bluetooth device, you need to connect Bluetooth device to this unit. The following 3 steps procedure is necessary.

Step 1. Pairing (Registering from Bluetooth devices)

To make your Bluetooth device (cell-phone) usable with this unit, you need to register it (pairing).

1 Turn on this unit Press the [SRC] button.

2 Start registering a this unit by operating the Bluetooth device

By operating the Bluetooth device, register the hands-free unit (pairing). Select "KCA-BT200"/"KCA-BT300" from the list of connected units.

3 Enter a PIN code Input the PIN code ("0000") in the Bluetooth device.

Check that registration is complete on the Bluetooth device.

⚠ PIN code is set to "0000" as the default. You can change this code. Refer to <[Registering PIN Code](#)> (page 65).

4 By operating the Bluetooth device, start hands-free connection.

Step 2. Connection

If you have registered 2 or more cell-phones, you need to select one of them. For more details, see <[Selecting the Bluetooth device You Wish to Connect](#)> (page 65).

When a cell-phone is connected, the "BT" indicator is light up.

Step 3. Hands-free phoning

You can do hand-free phoning when the connection is made.

Receiving a Call

Answering a Phone Call

Press the [VOL] knob.



- The following operations disconnect the line:
 - Insert a CD.
 - Connect a USB device.
- The name of the calling party is displayed if it has already been registered in the Phone Book.

Rejecting an Incoming Call

Press the [SRC] button.

During a Call

Disconnecting a Call

Press the [SRC] button.

Switching to the Private Mode

Press the [6] button.

Switches between Private talk ("PRIVATE") and Hands-free talk each time this button is pressed.



- Depending on the type of your cell-phone, switching to the private talk mode may select the source that was used before commencing the hands-free connection. If this happens, the source cannot be switched back to the hands-free talk mode by operating this unit. Operate your cell-phone to return to the hands-free talk mode.

Adjusting the Voice Volume during a Call

Turn the [VOL] knob.

Operation of hands-free phoning

Call Waiting

Answering Another Incoming Call with the Current Call Suspended

- 1 Press the [VOL] knob.
- 2 Turn the [VOL] knob and press it when the desired item is displayed.
Select "ANSWER".

Answering another Incoming Call after Terminating the Current Call

Press the [SRC] button.

Continuing the Current Call

- 1 Press the [VOL] knob.
- 2 Turn the [VOL] knob and press it when the desired item is displayed.
Select "REJECT".

Answering the Waiting Call after Terminating the Current Call

Press the [SRC] button.

Switching between the Current Call and Waiting Call

Press the [VOL] knob.

Each pressing of this knob switches the calling party.

Other Functions

Clearing the Disconnection Message

Press the [LOG] buttons for at least 1 second.

"HF Disconnect"/"HF D-CON" disappears.

Making a Call

1 Enter Bluetooth mode

Press the [LOG] button for at least 1 second.

2 Select a dialing method

Turn the [VOL] knob and press it when the desired item is displayed.

Display	Overview
"Phonebook"	Selecting the initial to be searched for the phone book.
"Incoming Calls"	Calling a number in the incoming call list.
"Outgoing Calls"	Calling a number in the outgoing call list.
"Missed Calls"	Calling a number in the missed calls list.
"Number Dial"	Making a call by entering phone number.

Operation method of each mode is described below.

3 Exit the dialing method mode

Press the [LOG] button for at least 1 second.

Speed Dialing (Preset Dial)

1 Enter Bluetooth mode

Press the [LOG] button for at least 1 second.

2 Select the number you want to recall from the memory

Press the [1] – [6] button.

3 Make a call

Press the [VOL] knob.



- You need to register the preset dial number. Refer to [<Registering to the Preset Dial Number List>](#) (page 34).

Operation of hands-free phoning

Calling a Number in the Phone Book

1 Enter Bluetooth mode

Press the [LOG] button for at least 1 second.

2 Select the Phone Book mode

Turn the [VOL] knob and press it when the desired item is displayed.

Select "Phonebook".

3 Select the initial to be searched for

Operation type	Operation
Move to the next character.	Turn the [VOL] knob.
Determine the selected initial.	Press the [VOL] knob.

4 Select the name

Operation type	Operation
Select the Phone number.	Turn the [VOL] knob.
Select the name.	Press the [◀◀] or [▶▶] button.

Switching between Display Modes

Press the [DISP] button.

5 Make a call

Press the [VOL] knob.



- During search, a non-accent character such as "u" is searched for instead of an accent character such as "ü".

Calling a Number in the Call log

1 Enter Bluetooth mode

Press the [LOG] button for at least 1 second.

2 Select the call log mode

Turn the [VOL] knob and press it when the desired item is displayed.

Select "Outgoing Calls" (outgoing call), "Incoming Calls" (incoming call), or "Missed Calls" (missed call).

3 Select a name or phone number

Turn the [VOL] knob.

Switching between Display Modes

Press the [DISP] button.

4 Make a call

Press the [VOL] knob.



- The outgoing call list and the incoming call list, and the missed call list are the lists of calls originated from and received at this unit. They are not the ones stored in the cell-phone memory.

Dial a Number

1 Enter Bluetooth mode

Press the [LOG] button for at least 1 second.

2 Select the number dial mode

Turn the [VOL] knob and press it when the desired item is displayed.

Select "Number Dial".

3 Enter a phone number

Operation type	Operation
Select the numbers.	Turn the [VOL] knob.
Move to the next digit.	Press the [▶▶] button.
Delete the last digit.	Press the [◀◀] button.

• Press the number ([1] – [0]), #([FM]), *([AM]), or +([▶▶]i) button on the remote controller.

✎ To erase the entered phone number digit by digit:

Press the [◀◀] button on the remote controller.

4 Make a call

• Press the [VOL] knob.

• Press the [DIRECT] button on the remote controller.



• You can input max 32 digits.

Make a Voice Dialing Call

1 Enter voice recognition mode

Press the [ATT] button for at least 1 second.

2 "PB Name?" is displayed.

When a beep is heard, say the name within 2 seconds.

3 "PN Type?" is displayed.

When a beep is heard, say the category name within 2 seconds.

4 Make a call

Press the [VOL] knob.

➔ This step is the same as step 4 of the procedure in <Calling a Number in the Phone Book> (page 32). You can make a call or select a category.



- If your voice cannot be recognized, a message is displayed. Pressing the [VOL] knob allows you to retry voice input. Refer to <Troubleshooting Guide> (page 76).
- Both the name and category require registration of a voice tag. Refer to <Setting a Voice Command for Category> (page 68).
- Audio sound is not output during voice recognition.

Operation of hands-free phoning

Registering to the Preset Dial Number List

1 Select the phone number you wish to register

Select the phone number with reference to the following:





- <Calling a Number in the Phone Book> (page 32)
- <Calling a Number in the Call log> (page 32)
- <Dial a Number> (page 33)

2 Select the number to put in the memory

Press the [1] – [6] button for at least 2 seconds.

Display of Phone Number type (category)

The category items in the Phone Book are displayed as follows:

Display	Information
"General" / 	General
"Home" / 	Home
"Office" / 	Office
"Mobile" / 	Mobile
"Other" / 	Other

Display Settings

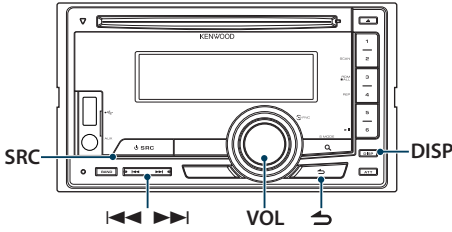

Function of DPX504U

Display type select

Press the [DISP] button.

Mode	Display Type
4-line display mode	Displays 3 to 4 lines of text.
3-line display mode	Displays 2 to 3 lines of text.
Clock display mode	Displays the clock.
Spectrum analyzer display mode	Displays a line of text and the spectrum analyzer.
Display off mode	Turns off the display. Turns on temporarily when you perform an operation.



- When the 4-line/3-line display mode is selected, the status (ON/OFF indicator of each function) can be displayed on the first line, and the icon of the currently selected source and the text information title can be displayed on the left side by the following <Information display setting> (page 39) operation.

Status display: Select "Settings" > "Display & Illumination" > "Display Select" > "Status"

Side display: Select "Settings" > "Display & Illumination" > "Display Select" > "Side Select"

Display Setting

You can select following Display Setting items.

- Select the source**
Press the [SRC] button.
- Enter Function setting mode**
Press the [VOL] knob.
- Enter Display Setting mode**
Turn the [VOL] knob and press it when the desired item is displayed.
Select "Settings"/"SETTINGS" > "Display & Illumination"/"DISP & ILLUMI".
- Select the Function item**
Turn the [VOL] knob and press it when the desired item is displayed.

DPX504U

Display	Overview
"Settings"	
"Display & Illumination"	Making Display and Illumination settings.
"Display Select"	Selecting and customizing the Display type.
"Color Select"	Selecting the Illumination Color of the panel. Refer to <Illumination Color Selection> (page 41).
"DISP & ILLUMI OFF"	When Display off mode is selected in <Display type select> (page 36), sets whether to turn off display only or display and key illumination. "DISP&ILLUMI"/"DISP"
"Display Dimmer"	Reduces the display Illumination brightness. "Auto": Dims the illumination in conjunction with the Light switch of the vehicle. "Manual1": Dims the illumination constantly. "Manual2": Dims the illumination darker than Manual1. "OFF": Does not dim the illumination.
"Contrast"	Adjusting the display contrast. "1" - "5" - "12"
"DISP N/P"	Switches the panel display between positive or negative. "POS1"/"POS2"/"NEGA1"/"NEGA2"
"Text Scroll"	Sets the method of scroll to view hidden text. "Auto": Scrolls. "Once": Scrolls once. "OFF": Does not scroll.
"BT DVC STATUS"	You can display the connection status, signal strength, and battery level. : Battery level of cell-phone. : Signal strength of cell-phone.

"ILLUMI Dimmer"	Reduces the key illumination brightness. "AUTO" : Dims the illumination in conjunction with the Light switch of the vehicle. "MANUAL1" : Dims the illumination constantly. "MANUAL2" : Dims the illumination darker than Manual1. "OFF" : Does not dim the illumination.
"ILLUMI Effect"	Sets whether the key illumination brightness is changed in conjunction with the key operation. "ON"/"OFF"
"ILLUMI MSC SYNC"	Sets whether the key illumination color is changed in conjunction with the sound volume. "ON"/"OFF"

(__ : Factory setting)

DPX404U | DPX304

Display	Overview
"SETTINGS"	
"DISP & ILLUMI"	Making Display and Illumination settings.
"COLOR SELECT"	Selecting the Illumination Color of the panel. Refer to <Illumination Color Selection> (page 41).
"TEXT SCROLL"	Sets the method of scroll to view hidden text. "AUTO" : Scrolls. "ONCE" : Scrolls once. "OFF" : Does not scroll.
"DISP OFF MODE"	Sets the clock and button illumination when "DISP OFF MODE" is selected as described in <Text Display Selection> (page 40).
"CLOCK"	"ON" : Displays the clock. "OFF" : Dims the clock.
"KEY ILLUMI"	"ON" : Turns on the button illumination. "OFF" : Dims the button illumination.
"DISP DIMMER"	Reduces the display illumination brightness. "AUTO" : Dims the illumination in conjunction with the Light switch of the vehicle. "MANUAL1" : Dims the illumination constantly. "MANUAL2" : Dims the illumination darker than Manual1. "OFF" : Does not dim the illumination.
"ILLUMI DIMMER"	Reduces the key illumination brightness. "AUTO" : Dims the illumination in conjunction with the Light switch of the vehicle. "MANUAL1" : Dims the illumination constantly. "MANUAL2" : Dims the illumination darker than Manual1. "OFF" : Does not dim the illumination.

(__ : Factory setting)

Text scroll

Press the [DISP] button for at least 1 second.
The displayed text scrolls.

5 Make a setting

Turn the [VOL] knob to select a setting value, and then press the [VOL] knob.

6 Exit Function setting mode

Press the [↵] button for at least 1 second.

Display Settings

Function of DPX504U

Selecting text display

Changes displayed information on each of the following sources:

1 Select the source

Press the [SRC] button.

2 Enter Function setting mode

Press the [VOL] knob.

3 Select Text display selection mode

Turn the [VOL] knob and press it when the desired item is displayed.

Select "Settings" > "Display & Illumination" > "Display Select" > "Text Select".

4 Select the text display part

Turn the [VOL] knob.

The selected text display part blinks.

5 Select the text

Press the [◀◀] or [▶▶] button

6 Exit Function setting mode

Press the [↵] button for at least 1 second.

In FM Tuner source

4-line display mode

Frequency & Program Service name ("Frequency/PS")	Radio text ("Radio Text")
Song title* ("Song Title")	Spectrum analyzer & Clock ("Speana/Clock")
Artist name* ("Artist Name")	Date ("Date")
Station name* ("Station Name")	Blank ("Blank")
Radio text plus* ("Radio Text Plus")	

* Information of Radio text plus is displayed.

3-line display mode

Frequency & Program Service name ("Frequency/PS")	Radio text ("Radio Text")
Song title & Artist name* ("Title/Artist")	Spectrum analyzer & Clock ("Speana/Clock")
Station name* ("Station Name")	Date ("Date")
Radio text plus* ("Radio Text Plus")	Blank ("Blank")

* Information of Radio text plus is displayed.

In AM Tuner source

Frequency ("Frequency")	Date ("Date")
Spectrum analyzer & Clock ("Speana/Clock")	Blank ("Blank")

In USB/ iPod/ Audio file source

4-line display mode

Song title ("Song Title")	Play time ("P-Time")
Album name ("Album Name")	Spectrum analyzer & Clock ("Speana/Clock")
Artist name ("Artist Name")	Date ("Date")
Folder name ("Folder Name")	Blank ("Blank")
File name ("File Name")	

3-line display mode

Title & Artist ("Title/Artist")	Spectrum analyzer & Clock ("Speana/Clock")
Album & Artist ("Album/Artist")	Date ("Date")
Folder name ("Folder Name")	Blank ("Blank")
File name ("File Name")	
Play time ("P-Time")	

In Music CD source

Disc title ("Disc Title")	Spectrum analyzer & Clock ("Speana/Clock")
Track title ("Track Title")	Date ("Date")
Play time ("P-Time")	Blank ("Blank")

In Auxiliary input source

Source name ("Source Name")	Date ("Date")
Spectrum analyzer & Clock ("Speana/Clock")	Blank ("Blank")

In Standby

Source name ("Source Name")	Date ("Date")
Clock ("Clock")	Blank ("Blank")

In Bluetooth audio source

4-line display mode

Bluetooth audio ("Source Name")	Spectrum analyzer & Clock ("Speana/Clock")
Song title* ("Song Title")	Date ("Date")
Artist name* ("Artist Name")	Blank ("Blank")
Album name* ("Album Name")	

3-line display mode

Bluetooth audio ("Source Name")	Spectrum analyzer & Clock ("Speana/Clock")
Title & Artist* ("Title/Artist")	Date ("Date")
Album & Artist* ("Album/Artist")	Blank ("Blank")

* Function of KCA-BT300

In Disc changer source (Optional)

Disc title ("Disc Title")	Spectrum analyzer & Clock ("Speana/Clock")
Track title ("Track Title")	
Play time ("P-Time")	Date ("Date")
	Blank ("Blank")



- Setting is available when the 4-line display mode, 3-line display mode, Clock display mode, or Spectrum analyzer display (Spectrum analyzer&Text type) mode which allows text display. Refer to <Display type select> (page 36).
- If the selected display item does not have any information, alternative information is displayed.
- Some items cannot be selected depending on the display type and row.
- When selecting "Folder Name" while playing with iPod, names will be displayed depending on currently selected browsing items.
- If the iPod Control by Hand Mode is set to on while playing the iPod, "iPod by Hand Mode" is displayed.
- If all characters cannot be displayed while playing with iPod, the file number in the list is displayed.

Information	Display
Music title	"TITLE****"
Folder name	"FLD****"
File name	"FILE****"

Function of DPX504U

Information display setting

You can customize the display of the Spectrum analyzer display mode.

1 Select the source

Press the [SRC] button.

2 Enter Function setting mode

Press the [VOL] knob.

3 Enter the Display Setting mode and select the Spectrum analyzer display mode

Turn the [VOL] knob and press it when the desired item is displayed.

Select "Settings" > "Display & Illumination" > "Display Select".

4 Select the setting item to adjust

Turn the [VOL] knob and press it when the desired item is displayed.

Display	Setting
"Display Select"	
"Side Select"	Sets the side part display for 4-line display mode and 3-line display mode. Text/ Icon/ Disappear
"Graphic Select"	Sets the spectrum analyzer display for Spectrum analyzer display mode. Spectrum analyzer A/ Spectrum analyzer B / Spectrum analyzer&Text
"Clock Select"	Sets the Clock display for Clock display mode. Home/ Home&Sub
"Status"	Sets the status display (ON/OFF indicator for each function) for 4-line display mode and 3-line display mode. Appear/ Disappear

5 Make a setting

Turn the [VOL] knob.

6 Exit Function setting mode

Press the [↵] button for at least 1 second.



- To adjust the "Sub time" with "Home & Sub" selected for "Clock Select", select a city in advance using the <Dual clock city setting> (page 43) function.

Display Settings

Function of DPX404U/ DPX304

Text Display Selection

Changing displayed information on each source following;

Press the [DISP] button.

In Tuner source

Information	Display
Program Service name (FM)	"FREQUENCY/PS"
Song title (FM)*	"SONG TITLE"
Artist name (FM)*	"ARTIST NAME"
Station name (FM)*	"STATION NAME"
Radio text + (FM)*	"RADIO TEXT +"
Radio text (FM)	"RADIO TEXT"
Frequency (MW, LW)	"FREQUENCY"
Display off	"DISP OFF MODE"

*Information of Radio text plus is displayed.

In CD source

Information	Display
Disc title	"DISC TITLE"
Track title	"TRACK TITLE"
Play time & Track number	"P-TIME"
Display off	"DISP OFF MODE"

In Audio file/ iPod source

Information	Display
Music title & Artist name	"TITLE/ARTIST"
Album name & Artist name	"ALBUM/ARTIST"
Folder name	"FOLDER NAME"
File name	"FILE NAME"
Play time & Music number	"P-TIME"
Display off	"DISP OFF MODE"

In Standby/ Auxiliary input source

Information	Display
Source name	"SOURCE NAME"
Display off	"DISP OFF MODE"



- When you select the Display off mode, the display setting of each source will be changed to the Display off.
- If the selected display item does not have any information, alternative information is displayed.
- When selecting "FOLDER NAME" while playing with iPod, names will be displayed depending on currently selected browsing items.

- If all characters cannot be displayed while playing with iPod, the file number in the list is displayed.

Information	Display
Music title	"TITLE****"
Folder name	"FOLDER****"
File name	"FILE****"

Illumination Color Selection

Selecting the Illumination Color of the panel.

1 Enter Function setting mode

Press the [VOL] knob.

2 Enter Illumination color selection mode

Turn the [VOL] knob and press it when the desired item is displayed.

Select "Settings"/"SETTINGS" > "Display & Illumination"/"DISP & ILLUMI" > "Color Select"/"COLOR SELECT".

3 Select the place where you want to set the Illumination Color

Turn the [VOL] knob and press it when the desired item is displayed.

Place	Display
Display and key	"All"/"ALL"
Display	"Display"/"DISPLAY"
Key	"Key"/"KEY"
Volume knob (DPX504U only)	"Knob"

4 Select the Illumination Color

Turn the [VOL] knob and press it when the desired item is displayed.

Select the color from "Variable Scan"/"VARIABLE SCAN", "Color1"/"COLOR1" — "Color24"/"COLOR24", or "User"/"USER".

Creating "User"/"USER" color

You can create your original color during the selection from "Color1"/"COLOR1" — "Color24"/"COLOR24".

The color you created can be called when you select "User"/"USER".

1. Press the [VOL] knob for at least 1 second.

Enter the detail color adjustment mode.

2. Set the color.

Operation type	Operation
To select the color to adjust. (red, green, or blue)	Press the [◀◀] or [▶▶] button.
To adjust color. (Range: 0 – 9)	Turn the [VOL] knob.

3. Press the [VOL] knob.

Exit the detail color adjustment mode.

5 Exit Function setting mode

Press the [↵] button for at least 1 second.

Auxiliary Input Display Setting

Selecting the display when changing to Auxiliary input source.

1 Select the AUX source

Press the [SRC] button.

Select the "AUX" display.

2 Enter Function setting mode

Press the [VOL] knob.

3 Enter Auxiliary input display setting mode

Turn the [VOL] knob and press it when the desired item is displayed.

Select "Settings"/"SETTINGS" > "AUX Name Set"/"AUX NAME SET".

4 Select the Auxiliary input display

Turn the [VOL] knob.

Select "AUX", "DVD", "PORTABLE", "GAME", "VIDEO", or "TV".

5 Exit Function setting mode

Press the [↵] button for at least 1 second.



- The Auxiliary input display can be set only when the built-in auxiliary input or the auxiliary input of optional KCA-S220A is used. On the KCA-S220A, "AUX EXT" is displayed by default.

Clock and Other Functions

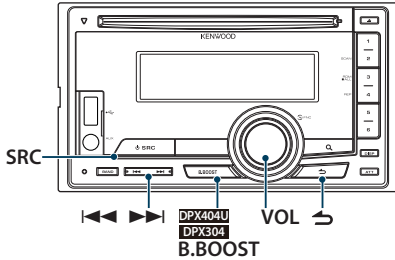

Function of DPX504U

Clock and Date Adjustment

You can adjust the clock and date.

Display	Overview
"Settings"	
"Clock & Date"	
"Clock Adjust"	Sets the clock.
"City Select"	Sets the two cities to be displayed when "Home&Sub type" is selected for "Clock Select". Refer to <Information display setting> (page 39), <Dual clock city setting> (page 43).
"Time Synchronized"	Synchronizing the Radio Data System station time data and this unit's clock. "ON" / "OFF"
"Sub Clock Adjust"	Adjusts the time difference caused by summer time. "-1h" / "0h" / "+1h"
"Summer Time"	Advances the clock one hour when set to ON. "ON" / "OFF"
"Date Adjust"	Sets the date.
"Date Mode"	Sets the date display mode.

(_ : Factory setting)

1 Enter Function setting mode

Press the [VOL] knob.

2 Enter Clock adjustment mode

Turn the [VOL] knob and press it when the desired item is displayed.

Select "Settings" > "Clock & Date" > "Clock Adjust".

3 Adjusting Clock

1. Turn the [VOL] knob to set the hours.
2. Press the [▶▶|] button.
3. Turn the [VOL] knob to set the minutes.
4. Press the [VOL] knob.

4 Enter Date adjustment mode

Turn the [VOL] knob and press it when the

desired item is displayed.

Select "Date Adjust".

5 Adjusting Date

1. Turn the [VOL] knob to adjust the year.
2. Press the [VOL] knob.
3. Turn the [VOL] knob to adjust the month.
4. Press the [VOL] knob.
5. Turn the [VOL] knob to adjust the day.
6. Press the [VOL] knob.

6 Enter Date format mode

Turn the [VOL] knob and press it when the desired item is displayed.

Select "Date Mode".

7 Select Date format

Turn the [VOL] knob and press it when the desired item is displayed.

Select from 7 types.

8 Exit Function setting mode

Press the [↵] button for at least 1 second.



- When Radio Data System station time data is received with "ON" selected for "Time Synchronized", the clock is adjusted automatically.

Dual clock city setting

You can select cities for two clocks.

1 Enter Function setting mode

Press the [VOL] knob.

2 Select City Select mode

Turn the [VOL] knob and press it when the desired item is displayed.

Select "Settings" > "Clock & Date" > City Select"

3 Select the city display part

Turn the [VOL] knob.

The selected city display part blinks.

4 Set cities for Home/ Sub

Press the [◀◀] or [▶▶] button

5 Exit Function setting mode

Press the [↵] button for at least 1 second.



- To display the clocks of two cities, select "Home&Sub" type for "Clock Select" described in [<Information display setting>](#) (page 39).
- For adjustment of Home time, refer to [<Clock and Date Adjustment>](#) (page 42).
- Time of Sub City is automatically derived from Home time. When summer time systems are different between Home and Sub cities, adjustment can be done by referring to "Sub Clock Adjust" of [<Clock and Date Adjustment>](#) (page 42).

Clock Adjustment

You can adjust the clock and date.

1 Enter Clock adjustment mode

Press the [B.BOOST] button for at least 1 second.

The hour display blinks.

2 Adjust the hour

Turn the [VOL] knob to adjust the hour, and then press the [VOL] knob.

The minute display blinks.

3 Adjust the minute

Turn the [VOL] knob to adjust the minute, and then press the [VOL] knob.

Finish the Clock Adjustment.

Clock and Other Functions

Initial Settings

You can select the following Initial Setting items.

1 Select the Standby

Press the [SRC] button.

Select the "STDBY"/"STANDBY" display.

2 Enter Function setting mode

Press the [VOL] knob.

3 Enter Initial Setting mode

Turn the [VOL] knob and press it when the desired item is displayed.

Select "Initial Settings"/"INITIAL SET".

4 Select the setting item to adjust

Turn the [VOL] knob.

Display	Overview
"Initial Settings"/ "INITIAL SET"	
"Security Set"/ "SECURITY SET"	When Security Code is set, possibility of theft is reduced because input of Security Code is prompted to turn on the unit once it is turned off. Refer to <Activating Security Code> (page 46).
"Source Select"*	Sets the source selection method. Select "2" to change the source selection method. Press the [SRC] button, turn the [VOL] knob to select the source, and then press the [VOL] knob to determine it. "Settings 1"/"2"
"Tuner Preset Type"/"PRESET TYPE"	Sets the Tuner preset type. "Type Normal"/"TYPE NORMAL": 1 station can be assigned to 1 preset button in each of 4 bands (FM1, FM2, FM3, and AM), i.e., a total of 24 stations (6 stations x 4 bands) can be preset. "Type Mixed"/"TYPE MIXED": A total of 6 stations can be assigned to a total of 6 preset buttons regardless of band (FM1, FM2, FM3, and AM). You can recall a preset station without switching between bands.
"Beep"/"KEY BEEP"	Setting the operation check sound (beep sound) ON/OFF. "ON"/"OFF"
"Russian"/ "RUSSIAN SET"	When this is set to ON, the following character strings are displayed in Russian: Folder name/ File name/ Song title/ Artist name/ Album name/ KCA-BT200 (optional accessory) "ON"/"OFF"
"Menu Language"*	You can select the display language for the Function setting item. "English"/"Français"/"Español"/"Deutsch"/ "Italiano"/"Русский"

"Power Off Wait"/ "P-OFF WAIT"	Setting the timer to turn this unit's power OFF automatically when Standby mode continues. Using this setting can save the vehicle's battery power. "OFF": Power Off Timer function is OFF. "20MIN/M"/"40MIN/M"/"60MIN/M": Turns the power OFF after minutes.
"Built in AUX"/ "BUILT-IN AUX"	When this is set to ON, AUX source can be selected. "ON": Allows AUX source to be selected. Use this setting when the built-in AUX terminal is connected to the external equipment all the time. "OFF": Disable AUX source selection. Use this setting when the built-in AUX terminal is not used.
"Forced CD-DA"/ "CD READ"	Sets the CD read mode. "Settings 1"/"1": Automatically distinguishes between Audio file disc and music CD when playing disc. "Settings 2"/"2": Forces playing as music CD.
"Built in AMP"*	Selecting "OFF" turns off the built-in amplifier. Turning off the built-in amplifier improves the quality of the sound from Preout. "ON"/"OFF"
"Switchable Preout"/"SWITCH PREOUT"	Switches the preout between rear output and subwoofer output. "Rear"/"REAR": Rear output "SubWoofer"/"SUB-W": Subwoofer output
"SP SELECT"***	Fine-tuning so that the System Q value is optimal when setting the speaker type as follows; "SP OFF": Off "SP 5/4": For 5 & 4 in. speaker "SP 6*9/6": For 6 & 6x9 in. speaker "SP OEM": For the OEM speaker
"System F/W Update"/"F/W UP"	Upgrades the firmware. Selecting "YES" and then pressing [VOL] knob starts upgrading the firmware. For how to update the firmware, access our web site. http://www.kenwood.com/cs/ce/

(_ : Factory setting)

* Function of DPX504U

** Function of DPX404U/DPX304

5 Make a setting

Turn the [VOL] knob to select a setting value, and then press the [VOL] knob.

6 Exit Function setting mode

Press the [↵] button for at least 1 second.

Demonstration mode Setting

Turning the demonstration mode ON/OFF.

1 Enter Function setting mode

Press the [VOL] knob.

2 Enter Demonstration mode setting

Turn the [VOL] knob and press it when the desired item is displayed.

Select "DEMO Mode"/"DEMO MODE".

3 Set the Demonstration mode

Turn the [VOL] knob and press it when the desired item is displayed.

Select "ON" or "OFF".

4 Exit Function setting mode

Press the [] button for at least 1 second.

Muting volume upon reception of Phone call

The audio system automatically mutes upon reception of an incoming call.

When a call comes in

"CALL" is displayed.

The audio system pauses.

Listening to the audio during a call

Press the [SRC] button.

The "CALL" display disappears and the audio system comes back ON.

When the call ends

Hang up the phone.

The "CALL" display disappears and the audio system comes back ON.



- To use the TEL Mute feature, you need to hook up the MUTE wire to your telephone using a commercial telephone accessory. Refer to <Connecting Wires to Terminals> (page 10) of Quick start guide.

Clock and Other Functions

Activating Security Code

When Security Code is set, possibility of theft is reduced because input of Security Code is prompted to turn on the unit once it is turned off.



- You can set the Security Code with a 4 digit number of your choice.
- The Security Code cannot be displayed or referenced. Make a note of the Security Code and treasure it up.

1 Select the Standby

Press the [SRC] button.

Select the "STDBY"/"STANDBY" display.

2 Enter Function setting mode

Press the [VOL] knob.

3 Select Security Code mode

Turn the [VOL] knob and press it when the desired item is displayed.

Select "Initial Settings"/"INITIAL SET" >
"Security Set"/"SECURITY SET"

4 Enter Security Code mode

Press the [VOL] knob for at least 1 second.

When "Enter"/"ENTER" is displayed, "[-][-][-]"/
"CODE" is also displayed.

5 Select the digits to enter

Press the [◀◀] or [▶▶] button.

6 Select the Security Code numbers

Turn the [VOL] knob.

7 Repeat steps 5 and 6, and complete the Security Code.

8 Confirm the Security Code

Press the [VOL] knob for at least 3 seconds.

When "Re-Enter"/"RE-ENTER" is displayed, "[-][-][-]
[-]"/"CODE" is also displayed.

9 Do the step 5 through 8 operation, and reenter the Security Code.

"Approved"/"APPROVED" is displayed.

The Security Code function activates.



- If you enter the wrong Code in steps 5 through 7, repeat from step 4.

10 Exit Function setting mode

Press the [↵] button for at least 1 second.

Resetting the Security Code function when the audio unit is first used after removed from the battery power source or the Reset button is pressed.

1 Turn the power ON.

2 Do the step 5 through 8 operation, and enter the Security Code.

"Approved"/"APPROVED" is displayed.

Now, you can use the unit.



- To deactivate the Security Code function, see the next section <Deactivating Security Code> (page 47).

Deactivating Security Code

To deactivate the Security Code function.

1 Select the Standby

Press the [SRC] button.

Select the "STDBY"/"STANDBY" display.

2 Enter Function setting mode

Press the [VOL] knob.

3 Select Security Code mode

Turn the [VOL] knob and press it when the desired item is displayed.

Select "Initial Settings"/"INITIAL SET" >
"Security Clear"/"SECURITY CLR"

4 Enter Security Code mode

Press the [VOL] knob for at least 1 second.

When "Enter"/"ENTER" is displayed, "[-][-][-]"/
"CODE" is also displayed.

5 Select the digits to enter

Press the [◀◀] or [▶▶] button.

6 Select the Security Code numbers

Turn the [VOL] knob.

7 Repeat steps 5 and 6, and complete the Security Code.

8 Confirm the Security Code

Press the [VOL] knob for at least 3 seconds.

"Clear"/"CLEAR" is displayed.

The Security Code function deactivates.

9 Exit Function setting mode

Press the [↶] button for at least 1 second.



- If a wrong security code is entered, "Error"/"ERROR" is displayed. Enter a correct security code.

Audio Adjustments – DPX504U –

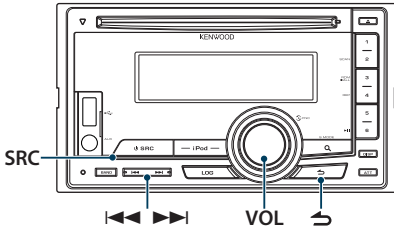

"Volume offset"	Sets each source's volume as a difference from the basic volume. "–8" — "±0" (AUX: "–8" — "+8")
"2Zone"	Sets the Dual Zone System.
"2Zone Select"	- <Dual Zone System> (page 51).
"Preset"	Sets the audio preset. - <Audio Preset Memory> (page 56). - <Audio Preset Recall> (page 57).

(__ : Factory setting)

Audio Control

You can adjust the following Audio Setting items.

Display	Overview
"Audio Control"	
"SubWoofer Level"	You can set subwoofer level. "–15" — "0" — "+15"
"DSP Set"	"Bypass": Disables the DSP function. "Through": Enables the DSP function.
"Equalizer"	Sets the sound quality. - <Preset Equalizer curve Select> (page 49). - <Manual Equalizer Control> (page 49).
"Bass Boost"	Sets the Bass Boost level in two steps. "OFF" / "Step1" — "2"
"HIGHWAY-SOUND"	Compensates the low volume or bass sound being lost by road noises to make vocal sound clearer. Unavailable when the tuner source is selected. "OFF" / "Step1" / "2" / "3"
"Supreme+"	Turns ON/OFF the Supreme plus function. Can be set while Music CD source, Audio file source of USB and iPod source. "ON" / "OFF"
"Position"	Compensates the sound environment in accordance with the listening position. - <Listening Position Selection> (page 50). - <Listening Position Fine Adjustments> (page 50).
"Balance"	Adjusts left/right speaker balance. (Left) "L15" — "0" — "R15" (Right)
"Fader"	Adjusts front/rear speaker balance. (Rear) "R15" — "0" — "F15" (Front)
"2Zone Rear Volume"	Refer to <Dual Zone System> (page 51).
"SubWoofer"	Turns on/off the subwoofer output. "ON" / "OFF"
"Detailed Setup"	
"Car Type"	To get clear sound, set the sound environment according to the location and size of physically installed speakers with reference to the followings:
"Speaker Setting"	
"Car Type Adjust"	
"X'Over"	- <Car Type Selection> (page 54). - <Speaker Setting> (page 54). - <Car Type Fine Adjustments> (page 55). - <X'Over Setting> (page 56).

1 Select the source

Press the [SRC] button.

Select a source other than "STDBY".

2 Enter Function setting mode

Press the [VOL] knob.

3 Enter Audio Control mode

Turn the [VOL] knob and press it when the desired item is displayed.

Select "Audio Control".

4 Select the setting item to adjust

Turn the [VOL] knob and press it when the desired item is displayed.

5 Make a setting

Turn the [VOL] knob to select a setting value, and then press the [VOL] knob.

6 Exit Function setting mode

Press the [] button for at least 1 second.

Remarks

• DSP Set

When "DSP Set" is set to "Bypass", the DSP function is disabled, and the colored items can not be set.

• HIGHWAY-SOUND

Increases the volume of faintest sound being lost by road noises to make the sound more audible. Additionally, it accentuates bass sound being lost by road noises to make the bass sound more dynamic.

• Supreme+ (Supreme Plus)

Technology to extrapolate and supplement with proprietary algorithm, the high-frequency range that is cut off when encoding. The bass and vocal sound that are cut off by encoding are supplemented for the reproduction of natural sound quality. Supplementing is optimized by compression format (AAC, MP3 or WMA) and processed according to bit rate. The effect is negligible with music that is encoded at high bit rate, variable bit rate or has minimal high frequency range.
The bass and vocal sound of Music CD/ iPod is also supplemented.

• Dual Zone System

Main source and sub source (Auxiliary input) output Front channel and Rear channel separately.

Preset Equalizer curve Select

You can select the following Equalizer curve.

Display	Equalizer curve
"Natural"	Natural
"User"	User*
"Rock"	Rock
"Pops"	Pops
"Easy"	Easy
"Top 40"	Top 40
"Jazz"	Jazz
"Game"	Game
"iPod"	iPod (During iPod source only)

* The Equalizer curve set in the section <Manual Equalizer Control> is recalled.

(__ : Factory setting)

1 Select the source

Press the [SRC] button.

Select a source other than "STDBY".

2 Enter Function setting mode

Press the [VOL] knob.

3 Enter Preset Equalizer mode

Turn the [VOL] knob and press it when the desired item is displayed.

Select "Audio Control" > "Equalizer" > "Preset Equalizer".

4 Select the Equalizer curve

Turn the [VOL] knob.

↻ Select the iPod Equalizer curve

You can select from 22 Equalizer curve types for iPod when "iPod" is selected.

1. Enter iPod Equalizer mode

Press the [VOL] knob.

2. Select the iPod Equalizer curve

Turn the [VOL] knob and press it when the desired item is displayed.

5 Exit Function setting mode

Press the [↵] button for at least 1 second.



- You can select for each source.

Manual Equalizer Control

You can adjust the following Equalizer Control items.

Band	Item	Range
"BAND1" (62.5 Hz)	"GAIN" Band level	-9 — +9 dB
	"EFFECT" Bass Effect	"ON"/"OFF"
"BAND2" (250 Hz)	"GAIN" Band level	-9 — +9 dB
"BAND3" (1 kHz)	"GAIN" Band level	-9 — +9 dB
"BAND4" (4 kHz)	"GAIN" Band level	-9 — +9 dB
"BAND5" (16 kHz)	"GAIN" Band level	-9 — +9 dB

(__ : Factory setting)

1 Select the source

Press the [SRC] button.

Select a source other than "STDBY".

2 Enter Function setting mode

Press the [VOL] knob.

3 Enter Manual Equalizer Control mode

Turn the [VOL] knob and press it when the desired item is displayed.

Select "Audio Control" > "Equalizer" > "Manual Equalizer".

4 Select the item you want to set

Operation type	Operation
Selects the item.	Turn the [VOL] knob.
Adjust each item.	Press the [◀◀] or [▶▶] button.
Set the value.	Press the [VOL] knob.

5 Exit Function setting mode

Press the [↵] button for at least 1 second.



- When "iPod" is selected in the section <Preset Equalizer curve Select> (page 49), Manual Equalizer Control is disabled.
- You can select for each source.

Audio Adjustments – DPX504U –

Listening Position Selection

The sound environment can be compensated in accordance with the selected position. According to the listening position, select the position from the following settings.

Compensation seat	Display
Not compensating.	"All"
Front-Left seat	"Front-Left"
Front-Right seat	"Front-Right"
Front seat	"Front"

(_ : Factory setting)

1 Select the source

Press the [SRC] button.

Select a source other than "STDBY".

2 Enter Function setting mode

Press the [VOL] knob.

3 Enter Preset position setting mode

Turn the [VOL] knob and press it when the desired item is displayed.

Select "Audio Control" > "Position" > "Preset Position".

4 Select the seat you want to compensate

Turn the [VOL] knob.

5 Exit Function setting mode

Press the [↵] button for at least 1 second.

Listening Position Fine Adjustments

Making fine adjustment of the value specified at Preset position selection per speaker.

1 Select the source

Press the [SRC] button.

Select a source other than "STDBY".

2 Enter Function setting mode

Press the [VOL] knob.

3 Enter Manual position setting mode

Turn the [VOL] knob and press it when the desired item is displayed.

Select "Audio Control" > "Position" > "DTA".

4 Select the speaker you want to set

Turn the [VOL] knob and press it when the desired value is displayed.

Item	Setting overview
"Front"	
"L"	Front Left speaker
"R"	Front Right speaker
"Rear"	
"L"	Rear Left speaker
"R"	Rear Right speaker
"Subwoofer"	
"L"	Subwoofer Left
"R"	Subwoofer Right
"Initialize"	Initialize the setting values.

5 Set the value

Press the [◀◀] or [▶▶] button

Adjust between 0 and 170 cm.

6 Exit Function setting mode

Press the [↵] button for at least 1 second.

Dual Zone System

Main source and sub source (Auxiliary input) output Front channel and Rear channel separately.

Display	Overview
"2Zone Rear Volume"*	Adjust the volume of Rear channel. "0" — "35"
"Detailed Setup"	
"2Zone"	Sets the Dual Zone System. "ON"/"OFF"
"2Zone Select"*	Specifies the destination of sub source sound when the Dual Zone function is turned on. "Rear"/"Front"

* The Dual Zone System is set to "ON".
(_ : Factory setting)

1 Select the source

Press the [SRC] button.

Select a source other than "STDBY".

2 Enter Function setting mode

Press the [VOL] knob.

3 Turn the [VOL] knob and press it when the desired item is displayed.

Select "Audio Control" > "Detailed Setup".

4 Select the item you want to set

Turn the [VOL] knob and press it when the desired item is displayed.

5 Exit Function setting mode

Press the [↵] button for at least 1 second.



- Select Main source by [SRC] button.
- Adjust the volume of Front channel by [VOL] knob.
- The Audio Control has no effect on sub source.
- There are following limitations when Dual Zone System is enabled.
 - There is no output from the subwoofer.
 - "Fader", "SubWoofer Level" of <Audio Control> (page 48) and DSP function are not available.
- The Bluetooth audio source can be set exclusively to the front speaker. Set "2Zone Select" to "Rear".

Audio Adjustments – DPX404U/ DPX304 –

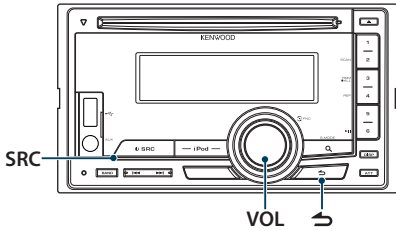

Audio Control

You can adjust the following Audio Setting items.

Display	Overview
"AUDIO CONTROL"	
"SUBWOOFER SET"	Turns on/off the subwoofer output. "OFF"/"ON"
"SYSTEM Q"	Switches between the following preset equalizer curves. "NATURAL"/"USER"/"ROCK"/"POPS"/ "EASY"/"TOP40"/"JAZZ"/"GAME" For USER: This appears when Bass level, Middle level, and Treble level are adjusted.
"BASS ADJUST"	You can set bass for each source.
"BASS FREQ"	Bass Center Frequency 40/50/60/70/80/100/120/150 (Hz)
"BASS LEVEL"	Bass level "-8" — "0" — "+8"
"BASS Q"	Bass Q Factor 1.00/1.25/1.50/2.00
"BASS EXT"	Bass Extend "ON"/"OFF"
"MID ADJUST"	You can set middle for each source.
"MID FREQ"	Middle Center Frequency 0.50/1.00/1.50/2.00 (kHz)
"MID LEVEL"	Middle level "-8" — "0" — "+8"
"MID Q"	Middle Q Factor 1.00/2.00
"TRE ADJUST"	You can set treble for each source.
"TRE FREQ"	Treble Center Frequency 10.0/12.5/15.0/17.5 (kHz)
"TRE LEVEL"	Treble level "-8" — "0" — "+8"
"BALANCE"	Adjusts left/right speaker balance. (Left) "L15" — "0" — "R15" (Right)
"FADER"	Adjusts front/rear speaker balance. (Rear) "R15" — "0" — "F15" (Front)
"SUB-W LEVEL"	You can set subwoofer level. "-15" — "0" — "+15"

"DETAILED SET"	
"LPF SUBWOOFER"	Selects cut off frequency of subwoofer output. "85"/"120"/"160"/"THROUGH" (OFF) Hz
"SUB-W PHASE"	Selects the phase of subwoofer output. "REVERSE" (180°)/"NORMAL" (0°)
"SUPREME SET"	Turns on/off the supreme function. Can be set while Audio file source of CD/ USB (excluding iPod). "ON"/"OFF"
"VOLUME OFFSET"	Sets each source's volume as a difference from the basic volume. "-8" — "0" (AUX: "-8" — "0" — "+8")

(__ : Factory setting)

1 Select the source

Press the [SRC] button.

Select a source other than "STANDBY".

2 Enter Function setting mode

Press the [VOL] knob.

3 Enter Audio Control mode

Turn the [VOL] knob and press it when the desired item is displayed.

Select "AUDIO CONTROL".

4 Select the setting item to adjust

Turn the [VOL] knob and press it when the desired item is displayed.

5 Make a setting

Turn the [VOL] knob to select a setting value, and then press the [VOL] knob.

6 Exit Function setting mode

Press the [↵] button for at least 1 second.



- The "SUB-W PHASE" item can be made when a setting other than "THROUGH" is selected for the "LPF SUBWOOFER" item.

Remarks

• Supreme

Technology to extrapolate and supplement with proprietary algorithm, the high-frequency range that is cut off when encoding at low bit rate (less than 128Kbps, Sampling frequency is 44.1kHz). Supplementing is optimized by compression format (MP3, WMA and AAC) and processed according to bit rate. The effect is negligible with music that is encoded at high bit rate, variable bit rate or has minimal high frequency range.

DSP Setup

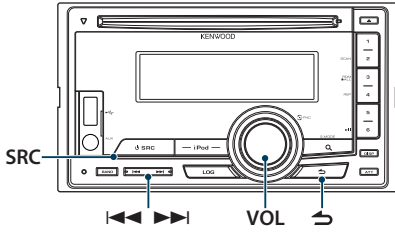

Car Type Selection

You can compensate the delay of the sound arrival time by selecting your environment from the following car types.

Display	Overview
"OFF"	Not compensating.
"Compact"	Compact car
"Sedan"	Sedan
"Wagon"	Station wagon
"Minivan"	Minivan
"SUV"	Sport-utility vehicle
"Passenger Van"	Passenger van

(__ : Factory setting)

1 Select the source

Press the [SRC] button.

Select a source other than "STDBY".

2 Enter Function setting mode

Press the [VOL] knob.

3 Enter Cabin select mode

Turn the [VOL] knob and press it when the desired item is displayed.

Select "Audio Control" > "Detailed Setup" > "Car Type".

4 Select the car type

Turn the [VOL] knob to select the car type, and then press the [VOL] knob.

5 Exit Function setting mode

Press the [↵] button for at least 1 second.



- You can compensate the distances in more details by using <Car Type Fine Adjustments> (page 55) function.

Speaker Setting

The speaker X'Over is automatically set when the position and size of each speaker are selected from the following items.

Speaker	Item	Range
"Front"	"SIZE"	Speaker Size Front "O.E.M.", "10cm", "13cm", "16cm", "17cm", "18cm", "4x6", "5x7", "6x8", "6x9", "7x10"
	"LOCATION"	Speaker Location Front "Door", "On Dash", "Under Dash"
	"TWEETER"	Speaker Size Tweeter "None", "Use"
"Rear"	"SIZE"	Speaker Size Rear "None", "O.E.M.", "10cm", "13cm", "16cm", "17cm", "18cm", "4x6", "5x7", "6x8", "6x9", "7x10"
	"LOCATION"	Speaker Location Rear • "Door", "Rear Deck" • "2nd Row", "3rd Row" (Car Type: "Minivan", "Passenger Van")
"SubWoofer"	"SIZE"	Speaker Size Subwoofer "None", "16cm", "20cm", "25cm", "30cm", "38cm Over"

(__ : Factory setting)

1 Select the source

Press the [SRC] button.

Select a source other than "STDBY".

2 Enter Function setting mode

Press the [VOL] knob.

3 Enter Speaker setting mode

Turn the [VOL] knob and press it when the desired item is displayed.

Select "Audio Control" > "Detailed Setup" > "Speaker Setting".

4 Select the item you want to set

Operation type	Operation
Selects the item.	Turn the [VOL] knob.
Adjust each item.	Press the [◀▶] or [▶▶] button.
Set the value	Press the [VOL] knob.

5 Exit Function setting mode

Press the [↵] button for at least 1 second.

Car Type Fine Adjustments

Adjusting fine tuning of the speaker position compensation value specified at <Car Type Selection> (page 54).

Display	Item	Range
"FRONT"	Front speaker	0 – 440 cm
"REAR"	Rear speaker	0 – 440 cm
"SW"	Subwoofer	0 – 440 cm

(_ : Factory setting)

1 Select the source

Press the [SRC] button.

Select a source other than "STDBY".

2 Enter Function setting mode

Press the [VOL] knob.

3 Enter Car Type Adjustment mode

Turn the [VOL] knob and press it when the desired item is displayed.

Select "Audio Control" > "Detailed Setup" > "Car Type Adjust".

4 Select the item you want to set

Operation type	Operation
Selects the item.	Turn the [VOL] knob.
Adjust each item.	Press the [◀] or [▶] button.
Set the value	Press the [VOL] knob.

The settings of the delay time are automatically identified and compensated by specifying the distances of each speaker from the center of the vehicle interior.

- 1 Set the front and rear positions and the height of the reference point to the position of the ears of the person sitting in the front seat, and set the right and left positions to the center of the vehicle interior.
- 2 Measure the distances from the reference point to the speakers.
- 3 Calculate the distance difference in accordance with the farthest speaker.

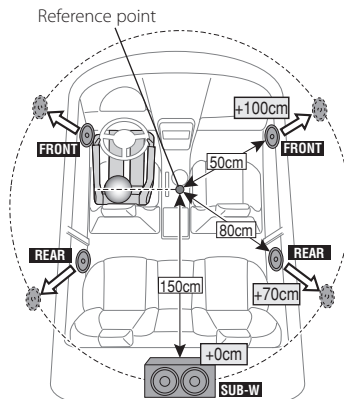

5 Exit Function setting mode

Press the [↵] button for at least 1 second.

DSP Setup

X'Over Setting

Fine adjusting the following setting values corresponding to the X'Over values set in the section <Speaker Setting> (page 54).

Display	Item	Range
"X'Over"		
"Front"	"FC"	Front High Pass Filter Through, 30, 40, 50, 60, 70, 80, 90, 100, 120, 150, 180, 220, 250 (Hz)
	"SLOPE"	Front High Pass Slope -6, -12, -18, -24 dB/Oct
"Rear"	"FC"	Rear High Pass Filter Through, 30, 40, 50, 60, 70, 80, 90, 100, 120, 150, 180, 220, 250 (Hz)
	"SLOPE"	Rear High Pass Slope -6, -12, -18, -24 dB/Oct
"SubWoofers"	"FC"	Subwoofer Low Pass Filter 30, 40, 50, 60, 70, 80, 90, 100, 120, 150, 180, 220, 250, Through (Hz)
	"SLOPE"	Subwoofer Slope -6, -12, -18, -24 dB/Oct
	"PHASE"	Subwoofer Phase Reverse (180°) / Normal (0°)

(_ : Factory setting)

1 Select the source

Press the [SRC] button.

Select a source other than "STDBY".

2 Enter Function setting mode

Press the [VOL] knob.

3 Enter X'Over setting mode

Turn the [VOL] knob and press it when the desired item is displayed.

Select "Audio Control" > "Detailed Setup" > "X'Over".

4 Select the speaker you want to set

Turn the [VOL] knob and press it when the desired item is displayed.

Select "Front", "Rear", or "SubWoofers".

5 Select the item you want to set

Operation type	Operation
Selects the item.	Turn the [VOL] knob.
Adjust each item.	Press the [◀] or [▶] button.
Set the value	Press the [VOL] knob.

6 Repeat steps 4 to 5 to complete the X'Over settings.

7 Exit Function setting mode

Press the [↵] button for at least 1 second.

Audio Preset Memory

Registering the value setup by Sound Control.

1 Setup Sound Control

Refer to the following operations to setup the Sound Control.

- <Car Type Selection> (page 54)
- <Speaker Setting> (page 54)
- <Car Type Fine Adjustments> (page 55)
- <X'Over Setting> (page 56)
- <Manual Equalizer Control> (page 49)
- <Listening Position Selection> (page 50)
- <Listening Position Fine Adjustments> (page 50)

2 Enter Audio preset memory mode

Turn the [VOL] knob and press it when the desired item is displayed.

Select "Audio Control" > "Detailed Setup" > "Preset" > "Preset Memory".

3 Select the number to put in the memory

Turn the [VOL] knob and press it when the desired item is displayed.

Select a preset number.

4 Turn the [VOL] knob and press it when the desired item is displayed.

Select "YES".

"Memory Completed" is displayed.

5 Exit Function setting mode

Press the [↵] button for at least 1 second.



- Register 6 patterns of Audio Preset Memory.
- Preset number "1":
When you press the Reset, all the sources will be the setting value which is registered.
- Preset number "1" and "2":
The memory cannot be erased by the Reset button.
- This function cannot be registered when the iPod Equalizer set in <Preset Equalizer curve Select> (page 49).

Audio Preset Recall

Recalling the sound setup registered by <Audio Preset Memory> (page 56).

1 Select the source

Press the [SRC] button.

Select a source other than "STDBY".

2 Enter Function setting mode

Press the [VOL] knob.

3 Enter Audio preset recall mode

Turn the [VOL] knob and press it when the desired item is displayed.

Select "Audio Control" > "Detailed Setup" > "Preset" > "Preset Recall".

4 Select the number to recall in the memory

Turn the [VOL] knob and press it when the desired item is displayed.

Select preset number.

5 Turn the [VOL] knob and press it when the desired item is displayed.

Select "YES".

"Recall Completed" is displayed.

6 Exit Function setting mode

Press the [↵] button for at least 1 second.



- The "User" of <Preset Equalizer curve Select> (page 49) is changed to the value which was recalled.
- The Equalizer curve is changed to the value which was recalled by the selected source.

Log Function

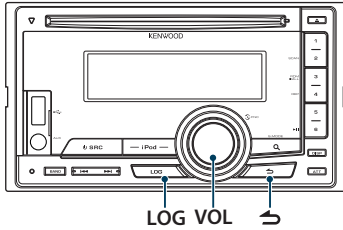

Log Function recall

This unit automatically memorizes the previously used functions and Function setting items, which can easily be recalled.

1 Display the Log Function list

Press the [LOG] button.

2 Recall the desired function

Turn the [VOL] knob to select Log Function item, and then press the [VOL] knob.

Category display	Function category
"FM"	FM broadcast
"MW/LW"	AM broadcast
"iPod"	iPod music
"USB"	USB music
"CD"	CD music
"INIT"	Initial setting item
"SET"	Setting item
"DISP"	Display setting item
"AUD"	Audio control setting
"BT"	Calling number

Cancelling the Log Function recall

Press the [➡] button.



- Maximum of 15 recently used functions are logged. When this limit is reached, they are deleted from the oldest.
- Logged functions can be deleted. Refer to <Deleting a Log Function item> (page 59).
- Functions to be logged can be set by categories. Refer to <Log Function category setting> (page 59).
- Logged functions can be locked to avoid them being deleted. Refer to <Log Function item lock> (page 58).
- Stations are logged after 1 minutes of reception. This timing can be changed. Refer to <Tuner Log Function time setting> (page 60).

Log Function item lock

Locks the Log Function items to prevent them from being deleted automatically.

1 Display the Log Function list

Press the [LOG] button.

2 Lock the Log Function item

Turn the [VOL] knob to select item, and then press the [VOL] knob for at least 1 second.

Locked items are indicated with "L".

Performing this step again will unlock the locked item.

3 Exit Log Function

Press the [➡] button.

Deleting a Log Function item

Deletes Log Function items.

1 Enter Function setting mode

Press the [VOL] knob.

2 Select the Log delete mode

Turn the [VOL] knob and press it when the desired item is displayed.

Select "Settings" > "Log" > "Log Delete"

3 Select the Log Function item to delete

Turn the [VOL] knob to select Log Function item, and then press the [VOL] knob.

Selecting "All" deletes all Log Function. (exclude a locked items.)

4 Turn the [VOL] to select "YES", and then press the [VOL] knob.

"Completed" is displayed.

5 Exit Function setting mode

Press the [↵] button for at least 1 second.

Log Function category setting

Sets the function category to be logged.

1 Enter Function setting mode

Press the [VOL] knob.

2 Select the Log Function setting mode

Turn the [VOL] knob and press it when the desired item is displayed.

Select "Settings" > "Log" > "Log settings"

3 Set the category to be logged

Category display	Setting category
"Tuner Log"	Radio-related
"Data CD Log"	CD-related
"iPod Log"	iPod-related
"USB Log"	USB-related
"Phone Log"	Call-related (KCA-BT200/BT300 only)
"Function Log"	Function setting-related

Turn the [VOL] knob to select category, and then press the [VOL] knob.

Check-mark ("✓") the category you want to register.

4 Exit Function setting mode

Press the [↵] button for at least 1 second.

Log Function

Tuner Log Function time setting

You can set the timing to log the station by the reception time.

1 Enter Function setting mode

Press the [VOL] knob.

2 Select the Tuner Log time set mode

Turn the [VOL] knob and press it when the desired item is displayed.

Select "Settings" > "Log" > "Tuner Log Time Set"

3 Set the reception time for the timing to start logging the station

Turn the [VOL] knob to select time ("10SEC", "30SEC", "1MIN", "2MIN", or "5MIN"), and then press the [VOL] knob.

4 Exit Function setting mode

Press the [↵] button for at least 1 second.

Bluetooth Setup

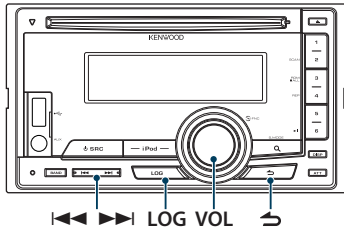

Bluetooth Setting

You can select the following Bluetooth Setting items.

- 1** Press the [LOG] button for at least 1 second.
- 2** Turn the [VOL] knob and press it when the desired item is displayed.
Select "Settings".
- 3** Select the Setting item
Turn the [VOL] knob and press it when the desired item is displayed.

Display	Overview
"Settings"	
"PAIRING"	
"Device Registration"	Register a Bluetooth device (pairing). Refer to <Registering Bluetooth device> (page 64).
"Phone Selection"	Select a cell-phone or Bluetooth audio player connection.
"Audio Selection"	Refer to <Selecting the Bluetooth device You Wish to Connect> (page 65).
"Special Device Select"	Register a Bluetooth device (pairing). Refer to <Registering Bluetooth device> (page 64).
"Device Delete"	Cancel registration of the Bluetooth device. Refer to <Deleting a Registered Bluetooth device> (page 66).
"SMS Download"	Download a short message. Refer to <Downloading the SMS> (page 70).
"Voice Tag"	Registers voice for voice recognition and voice to select the Phone number category in Phone book. - <Adding a Voice Dialing Command> (page 67) - <Setting a Voice Command for Category> (page 68)
"Detailed Setup"	Move to detailed item.
"PIN Code Edit"	Specify the PIN code required when registering this unit using the Bluetooth device. Refer to <Registering PIN Code> (page 65).
"Auto Answer"	Answer a call automatically after lapse of the preset time interval for automatic answer. "OFF"/"0SEC" – "8SEC" – "99SEC"

"Bluetooth HF/ Audio"	You can specify output speakers for hands-free voice communication and Bluetooth audio sound. "Front": Outputs voice from the front speakers. "All": Outputs voice from the front and rear speakers.
"Call Beep"	You can output a beep from the speaker when a call comes in. "ON": Beep is heard. "OFF": Beep is canceled.
"BT F/W Update"	Display the version of the firmware of this unit.
"Mic Gain"*	Adjust the sensitivity of the microphone for a telephone call. Adjust the voice of caller. Setting to "+" increases the voice volume. "-3" – "0" – "+3"
"NR Level"*	Reduce the noises generated by surrounding environment without changing the microphone volume. Adjust the voice of caller when it is not clear. Setting to "+" increases the noise reduction. "-3" – "0" – "+3"
"Echo Cancel Level"*	Adjust the level of echo cancellation. Setting to "+" increases the echo cancel reduction. "-2" – "0" – "+2"

(_ : Factory setting)

* Function of KCA-BT300

4 Make a setting

Turn the [VOL] knob to select a setting value, and then press the [VOL] knob.

5 Exit BT Settings mode

Press the [LOG] button for at least 1 second.

Remarks

- "Auto Answer" (Setting the Time Interval for Automatic Answer)

This function automatically answers (responds to) a call after lapse of the preset time interval for automatic answer.
"OFF": Does not answer the phone call automatically.
"0": Automatically answers the phone call at once.
"1s" – "99s": Automatically answers the phone call after lapse of 1 – 99 seconds.



- If the time set in the cell-phone is shorter than that set in the unit, the former will be used.
- This function does not work for call waiting.
- **“Bluetooth HF/Audio” (Setting up the Voice Output Speakers)**
Select the speaker which is further from the microphone in order to prevent howling or echoes.
- **“BT F/W Update” (Displaying the Firmware Version)**
Display the version of the firmware of this unit.
For how to update the firmware, access our web site.
<http://www.kenwood.com/cs/ce/bt/>

Bluetooth Setup

Registering Bluetooth device

To make your Bluetooth device (cell-phone) usable with this unit, you need to register it (pairing). You can register up to 5 Bluetooth devices to this unit.

Registering from this unit

1 Enter Bluetooth mode

Press the [LOG] button for at least 1 second.

2 Enter Bluetooth device registration mode

Turn the [VOL] knob and press it when the desired item is displayed.

Select "Settings" > "PAIRING" > "Device Registration".

Search for the Bluetooth device.

When search is completed, "Finished" is displayed.

3 Select a Bluetooth device

Turn the [VOL] knob and press it when the desired item is displayed.

4 Input the PIN code

Operation type	Operation
Select the numbers.	Turn the [VOL] knob.
Move to the next digit.	Press the [▶▶] button.
Delete the last digit.	Press the [◀◀] button.

5 Transmit the PIN code

Press the [VOL] knob.

If "Pairing Success" is displayed, registration is completed.

⚠ If the error message appears even though the PIN code is correct, try <Registering Special Bluetooth device> (page 64).

6 Return to the device list

Press the [↩] button.

7 Exit BT Settings mode

Press the [LOG] button for at least 1 second.



- This unit allows up to eight digits to be input for a PIN code. If a PIN code cannot be input from this unit, it can be input from the Bluetooth device.
- If there are 5 or more Bluetooth devices registered, you cannot register a new Bluetooth device.

Registering Special Bluetooth device

Allow registration of a special device that cannot be registered normally (pairing).

1. Select Special device registration mode

Turn the [VOL] knob and press it when the desired item is displayed.

Select "Settings" > "PAIRING" > "Special Device

Select".

2. Enter Special device registration mode

Press the [VOL] knob.

A list is displayed.

3. Select a device name

Turn the [VOL] knob and push the center when the desired device name is displayed.

If "Completed" is displayed, registration is completed.

4. Go through the procedure step 3 of

<Registering from this unit> (page 64) and complete the registration (pairing).

Canceling Special device registration mode

Press the [↩] button for at least 1 second.



- If the device name is not in the list, select "Other Phones".

Registering PIN Code

By operating the Bluetooth device, specify the PIN code necessary for registering this unit.

1 Enter Bluetooth mode

Press the [LOG] button for at least 1 second.

2 Enter PIN code edit mode

Turn the [VOL] knob and press it when the desired item is displayed.

Select "Settings" > "Detailed Setup" > "PIN Code Edit".

The current setting of PIN code is displayed.

3 Input the PIN code

Operation type	Operation
Select the numbers.	Turn the [VOL] knob.
Move to the next digit.	Press the [▶▶] button.
Delete the last digit.	Press the [◀◀] button.

4 Register a PIN code

Press the [VOL] knob.

If "Completed" is displayed, registration is completed.

5 Exit BT Settings mode

Press the [LOG] button for at least 1 second.



- By default, "0000" is specified.
- A PIN code can be specified with up to eight digits.

Selecting the Bluetooth device You Wish to Connect

When two or more Bluetooth devices have already been registered, you need to select the Bluetooth device you wish to use.

1 Enter Bluetooth mode

Press the [LOG] button for at least 1 second.

2 Select Bluetooth device selection mode

Turn the [VOL] knob and press it when the desired item is displayed.

Cell-phone

Select "Settings" > "PAIRING" > "Phone Selection".

Audio player

Select "Settings" > "PAIRING" > "Audio Selection".

3 Enter Bluetooth device selection mode

Press the [VOL] knob.

"(name)" is displayed.

4 Select the Bluetooth device

Turn the [VOL] knob.

5 Set up the Bluetooth device

Press the [VOL] knob.

"*(name)" or "-(name)" is displayed.

"*": The selected Bluetooth device is busy.

"-": The selected Bluetooth device is on standby.

" " (blank): The Bluetooth device is deselected.

6 Exit BT Settings mode

Press the [LOG] button for at least 1 second.



- If a Bluetooth device is already selected, deselect it, and then select a different one.
- If you cannot select a device using the audio player, connect the device with the audio player.

Bluetooth Setup

Deleting a Registered Bluetooth device

You can delete a registered Bluetooth device.

1 Enter Bluetooth mode

Press the [LOG] button for at least 1 second.

2 Enter Bluetooth device deletion mode

Turn the [VOL] knob and press it when the desired item is displayed.

Select "Settings" > "PAIRING" > "Device Delete".
"(name)" is displayed.

3 Select the Bluetooth device

Turn the [VOL] knob.

4 Delete the selected Bluetooth device

Press the [VOL] knob.

5 Turn the [VOL] knob and press it when the desired item is displayed.

Select "YES".

"Completed" is displayed.

6 Exit BT Settings mode

Press the [LOG] button for at least 1 second.



- When a registered cell-phone is deleted, its Phone Book, log, SMS, and voice tag are also deleted.

Downloading the Phone Book

Download the phone book data from the cell-phone to this unit so that you can use the Phone Book of this unit.

To download automatically

If the cell-phone supports a phone book synchronization function, the phone book is downloaded automatically after Bluetooth connection.



- Setting on the cell-phone may be required.
- If no phone book data is found in the unit even after the complete display, your cell-phone may not support automatic download of phone book data. In this case, try downloading manually.

To download from the cell-phone manually

1 By operating the cell-phone, end the hands-free connection.

2 By operating the cell-phone, send the phone book data to this unit

By operating the cell-phone, download the phone book data to this unit.

- During downloading:
"Downloading"/"Download.." is displayed.
- After completion of downloading:
"Completed" is displayed.

3 By operating the cell-phone, start the hands-free connection.

To clear the downloading completion message

Press any button.



- Up to 1000 phone numbers can be registered for each registered cell-phone.
- Up to 32 digits can be registered for each phone number along with up to 50* characters representing a name. (* 50: Number of alphabetic alphabetical characters. Fewer characters can be input depending on the type of characters.)
- To cancel downloading of the phone book data, operate the cell-phone.

Adding a Voice Dialing Command

Add a voice tag to the phone book for voice dialing. You can register up to 35 voice tags.

1 Enter Bluetooth mode

Press the [LOG] button for at least 1 second.

2 Enter Phone book name edit mode

Turn the [VOL] knob and press it when the desired item is displayed.

Select "Settings" > "Voice Tag" > "PB Name Edit".

3 Search for the name to register

Select the name to register with reference to 4 in <Calling a Number in the Phone Book> (page 32).

If a voice tag has already been registered for a name, "*" is displayed before the name.

4 Select a mode

Turn the [VOL] knob.

Display	Operation
"PB Name Regist."	Register a voice tag.
"PB Name Check"*	Play a voice tag.
"PB Name Delete"*	Delete a voice tag.

* Displayed only when a name for which a voice tag has been registered is selected.

Select "PB Name Regist." (Regist)

5 Register a voice tag (first)

"Enter Voice 1" is displayed.

When a beep is heard, say a voice tag within 2 seconds.

6 Confirm the voice tag (second)

"Enter Voice 2" is displayed.

When a beep is heard, say the same voice tag as that you said in step 6 within 2 seconds.

"Completed" is displayed.

7 End registration

Press the [VOL] knob.

Return to step 2. You can register another voice tag continuously.



- If your voice cannot be recognized, a message is displayed. Pressing the [VOL] knob allows you to retry voice input.

Select "PB Name Check" (Play)

5 Press the [VOL] knob.

Select "PB Name Delete" (Delete)

5 Delete a voice tag

Press the [VOL] knob.

6 Turn the [VOL] knob to select "YES", and then press the [VOL] knob.

Exit BT Settings mode

Press the [LOG] button for at least 1 second.



- Audio sound is not output during voice tag registration.

Bluetooth Setup

Setting a Voice Command for Category

Add a voice tag to the phone number category (type) for voice calling.

1 Enter Bluetooth mode

Press the [LOG] button for at least 1 second.

2 Enter Phone Number type edit mode

Turn the [VOL] knob and press it when the desired item is displayed.

Select "Settings" > "Voice Tag" > "PN Type Edit".

3 Select the category (type) you wish to set

Turn the [VOL] knob and press it when the desired item is displayed.

Select "General", "Home", "Office", "Mobile", or "Other"

4 Select a mode

Turn the [VOL] knob.

Display	Operation
"PN Type Regist."	Register a voice tag.
"PN Type Check"*	Play a voice tag.
"PN Type Delete"*	Delete a voice tag.

* Displayed only when a name for which a voice tag has been registered is selected.

5 Register the category (type) by performing steps 5 to 7 in <Adding a Voice Dialing Command> (page 67).

6 Exit BT Settings mode

Press the [LOG] button for at least 1 second.



- Set the voice tag for all the 5 categories. If the voice tag is not registered for all the categories, the Phone book may not be recalled by voice command.

SMS (Short Message Service)

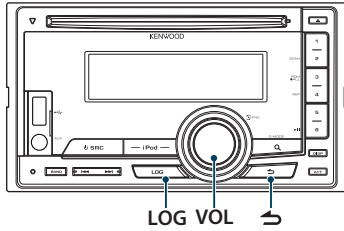

Downloading the SMS

Download the short message (SMS) arrived at the cell-phone so that it can be read on this unit.

1 Enter Bluetooth mode

Press the [LOG] button for at least 1 second.

☞ You can also select from "Settings" in Function setting mode.

2 Enter SMS download mode

Turn the [VOL] knob and press it when the desired item is displayed.

Select "Settings" > "SMS Download".

3 Start downloading

Press the [VOL] knob.

"Downloading" is displayed.

When the downloading finishes, "Completed" is displayed.

4 Exit BT Settings mode

Press the [LOG] button for at least 1 second.



- The cell-phone must be able to transmit the SMS using Bluetooth. Setting on the cell-phone may be required. If the cell-phone does not support SMS function, the SMS download item in Function Control mode is not displayed.
- When the SMS is downloaded from the cell-phone, the unopened messages in the cell-phone are opened.
- The already-read and unread short messages can be respectively downloaded up to 75.

SMS (Short Message Service)

The SMS arrived at the cell-phone is displayed on the receiver.

A newly arrived message is displayed.



- To prevent car accidents, the driver should not read the SMS while driving.

When a new message arrives

"SMS Received" is displayed.

The display disappears with any operations.

Displaying the SMS

1 Enter Bluetooth mode

Press the [LOG] button for at least 1 second.

☞ You can also select from "Settings" in Function setting mode.

2 Enter SMS Inbox mode

Turn the [VOL] knob and press it when the desired item is displayed.

Select "SMS Inbox".

A message list appears.

3 Select a message

Turn the [VOL] knob.

Each pressing of the [DISP] button switches between telephone number or name and message reception date.

4 Display the text

Press the [VOL] knob.

Turning the [VOL] knob scrolls the message.

Pressing the [VOL] knob again returns to the message list screen.

5 Exit SMS Inbox mode

Press the [↵] button.

6 Exit BT Settings mode

Press the [LOG] button for at least 1 second.



- The unopened message is displayed at the beginning of the list. Other messages are displayed in the order of reception.
- The SMS that has arrived when the cell-phone is not linked with Bluetooth cannot be displayed. Download the SMS.
- The short message cannot be displayed during downloading the SMS.

Appendix

About Audio file

- **Playable Audio file**
AAC-LC (.m4a), MP3 (.mp3), WMA (.wma)
- **Playable disc media**
CD-R/RW/ROM
- **Playable disc file format**
ISO 9660 Level 1/2, Joliet, Romeo, Long file name.
- **Playable USB device**
USB mass storage class
- **Playable USB device file system**
FAT16, FAT32

Even if the Audio files comply with the standards listed above, the play may be impossible depending on the types or conditions of media or device.

Playing order of the Audio file

In the example of folder/file tree shown below, the files are played in the order from ① to ⑩.

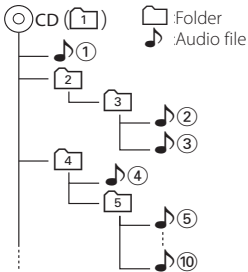

An online manual about Audio files is put on the site, www.kenwood.com/cs/ce/audiofile/. On this online manual, detailed information and notes which are not written in this manual are provided. Make sure to read through the online manual as well.



- In this manual, the word "USB device" is used for flash memories and digital audio players which have USB terminals.

About USB device

- When the USB device is connected to this unit, it can be charged up provided that this unit is powered.
- Install the USB device in the place where it will not prevent you from driving your vehicle properly.
- You cannot connect a USB device via a USB hub and Multi Card Reader.
- Save backups of the Audio files used with this unit. The files can be erased depending on the operating conditions of the USB device. We shall have no compensation for any damage arising out of erasure of the stored data.
- No USB device comes with this unit. You need to purchase a commercially available USB device.
- When connecting the USB device, usage of the CA-U1EX (option) is recommended.
- Normal playback is not guaranteed when a cable other than the USB compatible cable is used. Connecting a cable whose total length is longer than 4 m can result in abnormal playback.

iPod/iPhone that can be connected to this unit

Made for

- iPod nano (6th generation)
- iPod nano (5th generation)
- iPod nano (4th generation)
- iPod nano (3rd generation)
- iPod nano (2nd generation)
- iPod nano (1st generation)
- iPod with video
- iPod classic
- iPod touch (4th generation)
- iPod touch (3rd generation)
- iPod touch (2nd generation)
- iPod touch (1st generation)
- iPhone 4
- iPhone 3GS
- iPhone 3G
- iPhone

- For information on the compatibility of iPod/iPhone software, visit www.kenwood.com/cs/ce/ipod/.
- Type of control available varies depending on the type of connected iPod. See www.kenwood.com/cs/ce/ipod/ for further details.
- The word "iPod" appearing in this manual indicates the iPod or the iPhone connected with the iPod connection cable* (optional accessory).
* Not supported model KCA-iP500.
- Refer to the web site for connectable iPod and iPod connection cable.
www.kenwood.com/cs/ce/ipod/



- If you start playback after connecting the iPod, the music that has been played by the iPod is played first. In this case, "RESUMING" is displayed without displaying a folder name, etc. Changing the browse item will display a correct title, etc.
- You cannot operate iPod if "KENWOOD" or "✓" displayed on iPod.

About "KENWOOD Music Editor"

- This unit supports the PC application "KENWOOD Music Editor Light ver1.1" or later.
- When you use the Audio file with database information added by the "KENWOOD Music Editor Light ver1.1", you can search a file by title, album or artist name using the <File Search> (page 16).
- In the Instruction manual, the term "Music Editor media" is used to mean the device that contains Audio files with database information added with KENWOOD Music Editor.
- "KENWOOD Music Editor Light ver1.1" is available from the following web site:
www.kenwood.com/cs/ce/
- For further information on "KENWOOD Music Editor Light ver1.1", refer to the site above or the application help.

Troubleshooting Guide

Some functions of this unit may be disabled by some settings made on this unit.

- ! Cannot set up the subwoofer.**
- No output from the subwoofer.**
- Cannot set up the subwoofer position of Manual position setting.**
 - ▶ The Dual zone function is enabled. [☞] <Dual Zone System> (page 51)
 - “SubWoofers” of <Audio Control> (page 48)/ “SUBWOOFER SET” of <Audio Control> (page 52) is not set to ON.
 - “SubWoofers” > “FC” of <X’Over Setting> (page 56)/ “LPF SUBWOOFER” of <Audio Control> (page 52) is set to “Through”/ “THROUGH”.
 - In the speaker select option, None is selected for the subwoofer. [☞] <Speaker Setting> (page 54)

- ! Cannot set up the equalizer.**
- Cannot set up the Bass Boost.**
- Cannot set up the Highway sound.**
- Cannot set up the Supreme.**
- Cannot set up the Position control.**
 - ▶ The Dual zone function is enabled. [☞] <Dual Zone System> (page 51)
 - The DSP function is disabled. [☞] “DSP Set” of <Audio Control> (page 48)
 - In the speaker select option, None is selected for the rear speakers. [☞] <Speaker Setting> (page 54)

- ! Cannot select the output destination of the subsource in the Dual zone.**
- Cannot adjust the volume of the rear speakers.**
 - ▶ The Dual zone function is disabled. [☞] <Dual Zone System> (page 51)

- ! Cannot set up Display.**
 - ▶ <Demonstration mode Setting> (page 45) is not turned off.

- ! Cannot switch to USB/iPod source.**
 - ▶ The Dual zone function is set to USB/iPod. [☞] <Dual Zone System> (page 51)

- ! The number of songs contained in “SONGS” category of this unit is different from that contained in “SONGS” category of iPod.**
 - ▶ Podcast files are not counted in this unit as this unit does not support the playback of podcast files.

What might seem to be a malfunction in your unit may just be the result of slight misoperation or miswiring. Before calling service, first check the following table for possible problems.

General

- ? The operation check sound (beep sound) does not sound.**

- ✓ The preout jack is being used.
 - [☞] The Touch Sensor Tone cannot be output from the preout jack.

- ? The illumination flashes when the knob or button is operated.**

- ✓ This is the key illumination effect.
 - [☞] You set this effect in “ILLUMI Effect” of <Display Setting> (page 36).

- ? The key illumination effect brought about in conjunction with the sound volume is small.**

- ✓ The key illumination effect may be insufficient depending on the sound volume and sound quality.

Tuner source

- ? Radio reception is poor.**

- ✓ The car antenna is not extended.
 - [☞] Connect the Antenna control wire to the power terminal for the booster amplifier of the film-type or short pole type antenna
- Pull the antenna out all the way.

Disc source

- ? The specified disc does not play, but another one plays instead.**

- ✓ The specified CD is quite dirty.
 - [☞] Clean the CD, referring to the CD cleaning of the section on <Handling discs> (page 4).
- ✓ The disc is loaded in a different slot from that specified.
 - [☞] Eject the disc magazine and check the number for the specified disc.
- ✓ The disc is severely scratched.
 - [☞] Try another disc instead.

Audio file source

- ? The sound skips when an Audio file is being played.**

- ✓ The media is scratched or dirty.
 - [☞] Clean the media, referring to the CD cleaning of the section on <Handling discs> (page 4).
- ✓ The recording condition is bad.
 - [☞] Record the media again or use another media.

Hands-free

? The hands-free talk volume is low.

- ✓ The hands-free talk volume is set at a low level.
 - ☞ The hands-free talk volume can be adjusted independently. Adjust it during hands-free talk. "Mic Gain" and "NR Level" <Bluetooth Setting> (page 62).

? No sound is heard from the rear speakers.

- ✓ You are talking in the hand-free talk mode.
 - ☞ No sound is heard from the rear speakers in the hands-free talk mode.

? No beep is heard at reception of an incoming call.

- ✓ No beep is heard depending on the type of your cell-phone.
 - ☞ The "Call Beep" of <Bluetooth Setting> (page 62) is set ON.

? Voice is not recognized.

- ✓ The vehicle window is open.
 - ☞ If the surrounding noise is large, voice cannot be recognized properly. Close the vehicle windows to reduce noise.
- ✓ Small voice.
 - ☞ If voice is too small, it cannot be recognized properly. Speak into the microphone a little more loudly and naturally.
- ✓ The person uttering the voice tag is not the one who registered the it.
 - ☞ Only the voice of the person who registered the voice tag can be recognized.

Bluetooth audio source

? The Bluetooth audio player cannot be registered (pairing).

- ✓ The PIN code is fixed.
 - ☞ When a PIN code is specified in the Instruction Manual for Bluetooth Audio Player, register it with reference to <Registering PIN Code> (page 65) to register the Bluetooth audio player. If no PIN code is specified in the Instruction Manual, try "0000".

? The sound from the Bluetooth audio player is discontinuous.

- ✓ The distance between this unit and audio player is too far.
 - ☞ Move the audio player nearer to this unit.
- ✓ Another Bluetooth device is affecting the Bluetooth communication.
 - ☞ Turn off another Bluetooth device.
 - ☞ Move another Bluetooth device away from this unit.
- ✓ Another Bluetooth device or profile is used for communication.
 - ☞ The downloading of the Phone book or the SMS disconnects the sound.

Troubleshooting Guide

The messages shown below display your systems condition.

TOC Error/TOC ERROR:

- No disc has been loaded in the disc magazine.
- The CD is quite dirty. The CD is upside-down. The CD is scratched a lot.

Error 05/ERROR 05:

The disc is unreadable.

Mecha Error/Mecha ERR/Error 77/ERROR 99/ERROR 77:

The unit is malfunctioning for some reason.

- ❖ Press the reset button on the unit. If the "Mecha Error"/"Mecha ERR"/"Error 77"/"ERROR 99"/"ERROR 77" code does not disappear, consult your nearest service center.

IN (Blink):

The CD player section is not operating properly.

- ❖ Reinsert the CD. If the CD cannot be ejected or the display continues to flash even when the CD has been properly reinserted, please switch off the power and consult your nearest service center.

Protect/PROTECT (Blink):

The speaker wire has a short-circuit or touches the chassis of the vehicle, and then the protection function is activated.

- ❖ Wire or insulate the speaker cable properly and press the reset button. If the "Protect" code does not disappear, consult your nearest service center.

Unsupported File/NA FILE:

An Audio file is played with a format that this unit can't support.

Copy Protection/COPY PRO:

A copy-protected file is played.

Read Error/READ ERROR:

The file system of the connected USB device is broken.

- ❖ Copy the files and folders for the USB device again. If the error message is still displayed, initialize the USB device or use other USB devices.

No Device/NO DEVICE:

The USB device is selected as a source although no USB device is connected.

- ❖ Change the source to any source other than USB. Connect an USB device, and change the source to USB again.

N/A Device/NA DEVICE:

- An unsupported USB device is connected.
- Connection to the iPod has failed.
- ❖ Remove the USB device and then reconnect it.
- ❖ Check that the connected iPod is an iPod that is supported. See [<About Audio file> \(page 72\)](#) for information on supported iPods.
- ❖ Reset iPod/ iPhone.

No Music Data/Error 15/No Music/NO MUSIC/EROOR 15:

- The connected USB device contains no playable Audio file.
- Media was played that does not have data recorded that the unit can play.

USB Error/USB ERROR:

Some trouble may have occurred to the connected USB device.

- ❖ Remove the USB device, then cycle the power switch to ON. If the same display is repeated, use another USB device.

iPod Error/iPod ERROR:

Connection to the iPod has failed.

- ❖ Remove the USB device and then reconnect it.
- ❖ Reset iPod/ iPhone.

No Number:

- The calling party does not notify a caller ID.
- There is no phone number data.

No Data:

- There is no outgoing call list.
- There is no incoming call list.
- There is no missed call list.
- There is no phone book list.

No Entry:

The cell-phone has not been registered (pairing).

HF Disconnect/HF D-CON:

The unit cannot communicate with the cell-phone.

HF Error 07:

The memory cannot be accessed.

- ❖ Turn off the power and on again. If this message still appears, press the reset button on the control unit.

HF Error 68:

The unit cannot communicate with the cell-phone.

- ❖ Turn off the power and on again. If this message still appears, press the reset button on the control unit.

Unknown:

The Bluetooth device cannot be detected.

Device Full:

5 Bluetooth device have already been registered. No more Bluetooth device cannot be registered.

PIN Code NG:

The PIN code is wrong.

Connect NG:

The unit cannot be connected to the device.

Pairing Failed:

Pairing error.

- Err No Matching: The voice tag is wrong. Voice cannot be recognized because of an unregistered voice tag, etc.
- Too Soft: Voice is too small and cannot be recognized.
- Too Loud: Voice is too large to be recognized.
- Too Long: The word or utterance is too long to be recognized.
- No Phonebook: Data is not contained in the phone book.
- No Message: No short message in In Box.
- No Record: The voice tag is not registered in the phone book.
- Memory Full: The number of voice tags reaches the maximum number to be registered in the phone book.
- No Voice: No call.

Specifications

FM tuner section

Frequency range (50 kHz space)
: 87.5 MHz – 108.0 MHz
Usable sensitivity (S/N = 26dB)
DPX504U: 0.7 μ V/75 Ω
DPX404U/ DPX304: 1 μ V/75 Ω
Quieting Sensitivity (S/N = 46dB)
DPX504U: 1.6 μ V/75 Ω
DPX404U/ DPX304: 2.5 μ V/75 Ω
Frequency response (\pm 3.0 dB)
: 30 Hz – 15 kHz
Signal to Noise ratio (MONO)
DPX504U: 65 dB
DPX404U/ DPX304: 63 dB
Stereo separation (1 kHz)
: 40 dB

MW tuner section

Frequency range (9 kHz space)
: 531 kHz – 1611 kHz
Usable sensitivity (S/N = 20dB)
DPX504U: 25 μ V
DPX404U/ DPX304: 36 μ V

LW tuner section

Frequency range
: 153 kHz – 279 kHz
Usable sensitivity (S/N = 20dB)
DPX504U: 45 μ V
DPX404U/ DPX304: 57 μ V

CD player section

Laser diode
: GaAlAs
Digital filter (D/A)
: 8 Times Over Sampling
D/A Converter
: 24 Bit
Spindle speed
: 500 – 200 rpm (CLV)
Wow & Flutter
: Below Measurable Limit
Frequency response (\pm 1 dB)
: 10 Hz – 20 kHz
Total harmonic distortion (1 kHz)
: 0.008 %
Signal to Noise ratio (1 kHz)
: 110 dB
Dynamic range
: 93 dB
MP3 decode
: Compliant with MPEG-1/2 Audio Layer-3
WMA decode
: Compliant with Windows Media Audio
AAC decode
: AAC-LC “.m4a” files

USB Interface (DPX504U/ DPX404U)

USB Standard
: USB1.1/ 2.0 (Full speed)
Maximum Supply current
: 500 mA
File System
: FAT16/ 32
MP3 decode
: Compliant with MPEG-1/2 Audio Layer-3
WMA decode
: Compliant with Windows Media Audio
AAC decode
: AAC-LC “.m4a” files

Audio section

Maximum output power
: 50 W x 4
Output power (DIN 45324, +B=14.4V)
: 30 W x 4
Speaker Impedance
: 4 – 8 Ω
Tone action
DPX504U
BAND1 (60 Hz): \pm 9 dB
BAND2 (250 Hz): \pm 9 dB
BAND3 (1 kHz): \pm 9 dB
BAND4 (4 kHz): \pm 9 dB
BAND5 (16 kHz): \pm 9 dB
DPX404U/ DPX304
Bass : 100 Hz \pm 8 dB
Middle : 1 kHz \pm 8 dB
Treble : 12.5 kHz \pm 8 dB
Preout level / Load (CD)
DPX504U: 2500 mV/10 k Ω
DPX404U/ DPX304: 2000 mV/10 k Ω
Preout impedance
: \leq 600 Ω

Auxiliary input

Frequency response (\pm 1 dB)
: 20 Hz – 20 kHz
Input Maximum Voltage
: 1200 mV
Input Impedance
: 10 k Ω

General

Operating voltage (11 – 16V allowable)
: 14.4 V
Maximum Current consumption
: 10 A
Installation Size (W x H x D)
: 182 x 111 x 158 mm
Weight
: 1.5 kg

Specifications subject to change without notice.



Declaration of Conformity with regard to the EMC Directive 2004/108/EC

Manufacturer:

Kenwood Corporation
2967-3 Ishikawa-machi, Hachioji-shi, Tokyo, 192-8525 Japan

EU Representative's:

Kenwood Electronics Europe BV
Amsterdamseweg 37, 1422 AC UITHOORN, The Netherlands

The marking of products using lasers

**CLASS 1
LASER PRODUCT**

The label is attached to the chassis/case and says that the component uses laser beams that have been classified as Class 1. It means that the unit is utilizing laser beams that are of a weaker class. There is no danger of hazardous radiation outside the unit.

For Turkey

Bu ürün 26891 sayılı Resmi Gazete'de yayımlanan Elektrikli ve Elektronik Eşyalarda Bazı Zararlı Maddelerin Kullanımının Sınırlanmasına Dair Yönetmeliğe uygun olarak üretilmiştir.

This product complies with Directive, Number 26891 regarding "REGULATION ON THE RESTRICTION OF THE USE OF CERTAIN HAZARDOUS SUBSTANCES IN ELECTRICAL AND ELECTRONIC EQUIPMENT".

This Product is not installed by the manufacturer of a vehicle on the production line, nor by the professional importer of a vehicle into an EU Member State.

Information on Disposal of Old Electrical and Electronic Equipment and Batteries (applicable for EU countries that have adopted separate waste collection systems)



Products and batteries with the symbol (crossed-out wheeled bin) cannot be disposed as household waste. Old electrical and electronic equipment and batteries should be recycled at a facility capable of handling these items and their waste byproducts.



Contact your local authority for details in locating a recycle facility nearest to you.



Proper recycling and waste disposal will help conserve resources whilst preventing detrimental effects on our health and the environment.

Notice: The sign "Pb" below the symbol for batteries indicates that this battery contains lead.

Pb



This symbol mark indicates that Kenwood manufactured this product so as to decrease harmful influence on the environment.

- The Bluetooth word mark and logos are owned by the Bluetooth SIG, Inc. and any use of such marks by Kenwood Corporation is under license. Other trademarks and trade names are those of their respective owners.
- The "AAC" logo is a trademark of Dolby Laboratories.
- iTunes is a trademark of Apple Inc.
- "Made for iPod" and "Made for iPhone" mean that an electronic accessory has been designed to connect specifically to iPod or iPhone, respectively, and has been certified by the developer to meet Apple performance standards. Apple is not responsible for the operation of this device or its compliance with safety and regulatory standards. Please note that the use of this accessory with iPod or iPhone may affect wireless performance.
- iPhone, iPod, iPod classic, iPod nano, and iPod touch are trademarks of Apple Inc., registered in the U.S. and other countries.
- "Adobe Reader" is a trademark of Adobe Systems Incorporated.

Free Manuals Download Website

<http://myh66.com>

<http://usermanuals.us>

<http://www.somanuals.com>

<http://www.4manuals.cc>

<http://www.manual-lib.com>

<http://www.404manual.com>

<http://www.luxmanual.com>

<http://aubethermostatmanual.com>

Golf course search by state

<http://golfingnear.com>

Email search by domain

<http://emailbydomain.com>

Auto manuals search

<http://auto.somanuals.com>

TV manuals search

<http://tv.somanuals.com>