

# KENWOOD

DUAL DIN SIZED CD RECEIVER

**DPX502U**  
**DPX502UY**

---

## INSTRUCTION MANUAL

Kenwood Corporation



# Contents

---

<b>Safety precautions</b>	<b>3</b>	<b>Menu system</b>	<b>24</b>
<b>Notes</b>	<b>4</b>	Menu System	
<b>General features</b>	<b>7</b>	Security Code	
Power		Touch Sensor Tone	
Selecting the Source		Manual Clock Adjustment	
Volume		Synchronize Clock	
Attenuator		Display Illumination Control	
System Q		Dimmer	
Audio Control		Switching preout	
Adjusting the detail of Audio Control		Built-in Amp Setting	
Audio Setup		Dual Zone System Setting	
Speaker Setting		Supreme Setting	
Subwoofer Output		AMP Control	
TEL Mute		News Bulletin with Timeout Setting	
Switching Display		Local Seek	
<b>Tuner features</b>	<b>13</b>	Tuning Mode	
Tuning		AF (Alternative Frequency)	
Direct Access Tuning		Restricting RDS Region (Region Restrict Function)	
Station Preset Memory		Auto TP Seek	
Auto Memory Entry		Monaural Reception	
Preset Tuning		Auxiliary Input Display Setting	
<b>RDS features</b>	<b>15</b>	Selecting Russian Characters	
Traffic Information		Text Scroll	
Radio Text Scroll		Built-in Auxiliary input Setting	
PTY (Program Type)		Power OFF Timer	
Program Type preset		CD Read Setting	
Changing Language for PTY Function		Audio Preset Memory	
<b>CD/USB device/Audio file/External disc control features</b>	<b>18</b>	Audio Preset Recall	
Playing CD & Audio file		Firmware version display	
USB Device Connection		Demonstration mode Setting	
Playing USB (iPod) device		<b>Basic Operations of remote control</b>	<b>32</b>
Drive Search		<b>Accessories/ Installation Procedure</b>	<b>34</b>
Playing External Disc		<b>Connecting Wires to Terminals</b>	<b>35</b>
Fast Forwarding and Reversing		<b>Installation</b>	<b>37</b>
Music Search		<b>Removing the Unit</b>	<b>38</b>
Disc Search/Folder/Album Search		<b>Troubleshooting Guide</b>	<b>39</b>
Direct Music Search		<b>Specifications</b>	<b>41</b>
Direct Disc Search			
Track/File/Disc/Folder Repeat			
Scan Play			
Random Play			
Magazine Random Play			
All Random Play			
File select			
File Select 1 mode			
File Select 2 mode			
Text/Title Scroll			

## Safety precautions

---

### **⚠ WARNING**

#### **To prevent injury or fire, take the following precautions:**

- To prevent a short circuit, never put or leave any metallic objects (such as coins or metal tools) inside the unit.
- Do not watch or fix your eyes on the unit's display when you are driving for any extended period.
- Mounting and wiring this product requires skills and experience. For safety's sake, leave the mounting and wiring work to professionals.

### **⚠ CAUTION**

#### **To prevent damage to the machine, take the following precautions:**

- Make sure to ground the unit to a negative 12V DC power supply.
- Do not install the unit in a spot exposed to direct sunlight or excessive heat or humidity. Also avoid places with too much dust or the possibility of water splashing.
- When replacing a fuse, only use a new fuse with the prescribed rating. Using a fuse with the wrong rating may cause your unit to malfunction.
- Use only the screws provided or specified for installation. If you use wrong screws, you could damage the unit.

#### **Do Not Load 8 cm (3 in.) CDs in the CD slot**

If you try to load a 8 cm (3 in.) CD with its adapter into the unit, the adapter might separate from the CD and damage the unit.

#### **About CD players/disc changers connected to this unit**

Kenwood disc changers/ CD players released in 1998 or later can be connected to this unit.

Refer to the catalog or consult your Kenwood dealer for connectable models of disc changers/ CD players. Note that any Kenwood disc changers/ CD players released in 1997 or earlier and disc changers made by other makers cannot be connected to this unit.

Connecting unsupported disc changers/CD players to this unit may result in damage.

Set the "O-N" Switch to the "N" position for the applicable Kenwood disc changers/ CD players.

The functions you can use and the information that can be displayed may differ depending on the models being connected.



- You can damage both your unit and the CD changer if you connect them incorrectly.

#### **Lens Fogging**

When you turn on the car heater in cold weather, dew or condensation may form on the lens in the CD player of the unit. Called lens fogging, this condensation on the lens may not allow CDs to play. In such a situation, remove the disc and wait for the condensation to evaporate. If the unit still does not operate normally after a while, consult your Kenwood dealer.

iPod is a trademark of Apple Inc., registered in the U.S. and other countries.

The "AAC" logo is trademark of Dolby Laboratories.

## Notes

- If you experience problems during installation, consult your Kenwood dealer.
- When you purchase optional accessories, check with your Kenwood dealer to make sure that they work with your model and in your area.
- The RDS feature won't work where the service is not supported by any broadcasting station.
- The characters which can be displayed by this unit are A-Z 0-9 @ " ' ` % & \* + - = , . / \ < > [ ] ( ) ; ^ - { } ~ .
- The illustrations of the display and the panel appearing in this manual are examples used to explain more clearly how the controls are used. Therefore, what appears on the display in the illustrations may differ from what appears on the display on the actual equipment, and some of the illustrations on the display may be inapplicable.

### How to reset your unit

- If the unit fails to operate properly, press the Reset button. The unit returns to factory settings when the Reset button is pressed.
- Remove the USB device before pressing the Reset button. Pressing the Reset button with the USB device installed can damage the data contained in the USB device. For how to remove the USB device, refer to <Playing USB (iPod) device> (page 19).
- Press the reset button if the disc auto changer fails to operate correctly. Normal operation should be restored.

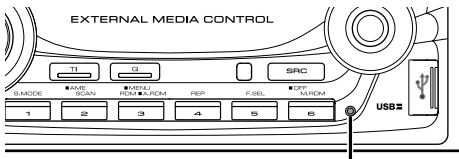

Reset button

### Cleaning the Unit

If the faceplate of this unit is stained, wipe it with a dry soft cloth such as a silicon cloth. If the faceplate is stained badly, wipe the stain off with a cloth moistened with neutral cleaner, then wipe it again with a clean soft dry cloth.



- Applying spray cleaner directly to the unit may affect its mechanical parts. Wiping the faceplate with a hard cloth or using a volatile liquid such as thinner or alcohol may scratch the surface or erase characters.

### Before using this unit for the first time

This unit is initially set on the Demonstration mode. When using this unit for the first time, cancel the <Demonstration mode Setting> (page 31).

### About KENWOOD "Music Editor" of PC application attached to DPX502U/DPX502UY

- "Music Editor" is recorded in the CD-ROM attached to this unit.
- Refer to the attached installation manual for the installation method of "Music Editor".
- Refer to the user's manual recorded in the installation CD-ROM and Help of "Music Editor" for the operation method of "Music Editor".
- The unit can play CD/ USB device created by "Music Editor".
- Information about "Music Editor" upgrade is put on the site, [www.kenwood.com](http://www.kenwood.com).

## About Audio file

### • Playable Audio file

AAC-LC (.m4a), MP3 (.mp3), WMA (.wma), WAV (.wav)

### • Playable disc media

CD-R/RW/ROM

### • Playable disc file format

ISO 9660 Level 1/2, Joliet, Romeo, Long file name.

### • Playable USB device

USB mass storage class, iPod with KCA-iP200

### • Playable USB device file system

FAT16, FAT32

Although the audio files are complied with the standards listed above, the play maybe impossible depending on the types or conditions of media or device.

### • Playing order of the Audio file

In the example of folder/file tree shown below, the files are played in the order from ① to ⑩.

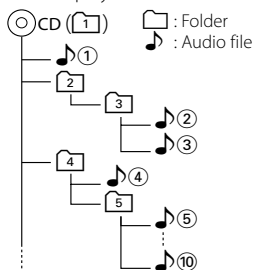

An online manual about audio files is put on the site, [www.kenwood.com/audiofile/](http://www.kenwood.com/audiofile/). On this online manual, detailed information and notes which are not written in this manual are provided. Make sure to read through the online manual as well.



- In this manual, the word "USB device" is used for flash memories and digital audio players which have USB terminals.
- The word "iPod" appearing in this manual indicates the iPod connected with the KCA-iP200 (optional accessory). The iPod connected with the KCA-iP200 can be controlled from this unit. iPods that can be connected with the KCA-iP200 are the iPod nano and the iPod with video. When an iPod is connected using a commercially available USB cable, it is handled as a mass-storage-class device.
- For the supported formats and types of USB device, refer to [www.kenwood.com/usb/](http://www.kenwood.com/usb/).

## About USB device

- Install the USB device in the place where it will not prevent you from driving your vehicle properly.
- You cannot connect a USB device via a USB hub.
- Take backups of the audio files used with this unit. The files can be erased depending on the operating conditions of the USB device. We shall have no compensation for any damage arising out of erasure of the stored data.
- No USB device comes with this unit. You need to purchase a commercially available USB device.
- Do not directly connect the USB device to the USB connector on the panel. Connect it using a cable.
- Leave the cap on when not using an USB device.
- For how to play the audio files recorded in a USB device, see <CD/USB device/Audio file/External disc control features> (page 18).
- When connecting the USB device, usage of the CA-U1EX (option) is recommended. Normal playback is not guaranteed when a cable other than the USB compatible cable is used. Connecting a cable whose total length is longer than 5 m can result in abnormal playback.

## About DAB Tuner control

Refer to [A] group on the Instruction manual of DAB Tuner KTC-9090DAB (optional accessory) for the control method of DAB Tuner function. However, the following control methods of the function for this unit may be differed from the Instruction manual; therefore, refer to the following supplemental instruction.

### <Auto Ensemble Memory Entry>

1. Select the preset band for Auto Ensemble Memory Entry.
2. Press the [AME] button for at least 2 seconds. Open Auto Ensemble Memory Entry. After storing in the memory finishes, the number of the pre-set buttons and the ensemble label are displayed.

### <Searching by programme type and language> and <Languages to be displayed> in <Programme Type (PTY) Function>

At the operation to press [DISP] button, use [TI] button instead.

### <Automatic Switching DAB priority>

This function cannot be used.

## Notes

### Handling CDs

- Do not touch the recording surface of the CD.
- Do not stick tape etc. on the CD, or use a CD with tape stuck on it.
- Do not use disc type accessories.
- Clean from the center of the disc and move outward.
- When removing CDs from this unit, pull them out horizontally.
- If the CD center hole or outside rim has burrs, use the CD only after removing the burrs with a ballpoint pen etc.

### CDs that cannot be used

- CDs that are not round cannot be used.

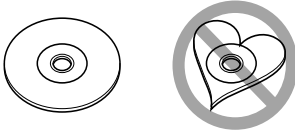

- CDs with coloring on the recording surface or CDs that are dirty cannot be used.
- This unit can only play the CDs with 

This unit may not correctly play discs which do not have the mark.

- You cannot play a CD-R or CD-RW that has not been finalized. (For the finalization process refer to your CD-R/CD-RW writing software, and your CD-R/CD-RW recorder instruction manual.)

This Product is not installed by the manufacturer of a vehicle on the production line, nor by the professional importer of a vehicle into an EU Member State.

### Information on Disposal of Old Electrical and Electronic Equipment (applicable for EU countries that have adopted separate waste collection systems)



Products with the symbol (crossed-out wheeled bin) cannot be disposed as household waste.

Old electrical and electronic equipment should be recycled at a facility capable of handling these items and their waste byproducts. Contact your local authority for details in locating a recycle facility nearest to you. Proper recycling and waste disposal will help conserve resources whilst preventing detrimental effects on our health and the environment.

### The marking of products using lasers (Except for some areas)

**CLASS 1  
LASER PRODUCT**

The label is attached to the chassis/case and says that the component uses laser beams that have been classified as Class 1. It means that the unit is utilizing laser beams that are of a weaker class. There is no danger of hazardous radiation outside the unit.

## General features

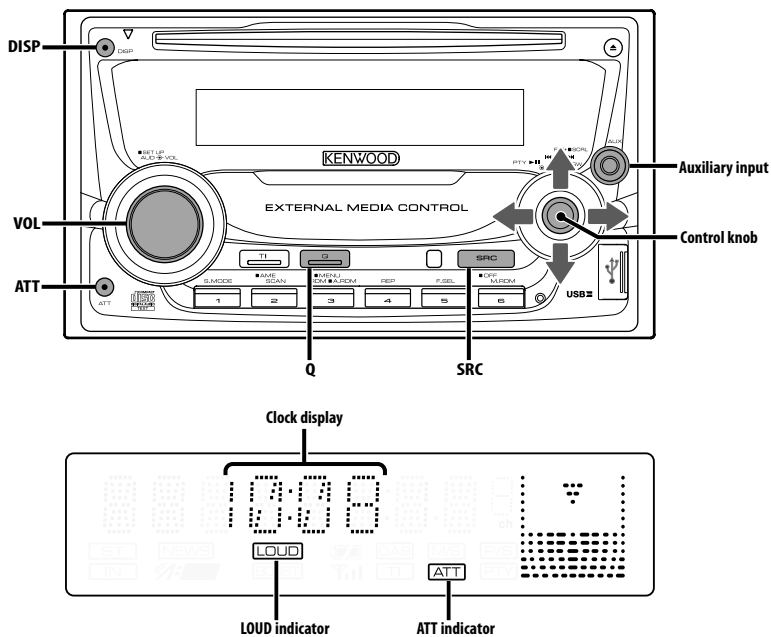

## Power

### Turning ON the Power

Press the [SRC] button.



- When the power is ON, the <Security Code> (page 25) is displayed as "CODE ON" or "CODE OFF".

### Turning OFF the Power

Press the [SRC] button for at least 1 second.

## Selecting the Source

Press the [SRC] button.

Source required	Display
Tuner	"TUNER"
USB device (iPod)	"USB" ("iPod")
CD	"CD"
External disc (Optional accessory)	"CD CH"
Auxiliary input*	"AUX"
Auxiliary input (Optional accessory)	"AUX EXT"
Standby (Illumination only mode)	"STANDBY"

- \* An equipment such as a portable audio player can be connected to the auxiliary input terminal using a commercially available mini-plug (3.5Ø).



- This unit automatically turns full power OFF after 20 minutes lapses in Standby mode in order to save the vehicle's battery. The time until full power OFF can be set in <Power OFF Timer> (page 30).
- When connection of the iPod is recognized, the source display changes from "USB" to "iPod".
- USB (iPod) source is recognized as CD source on the connected unit.
- Use the mini-plug which is stereo type and does not have any resistance.

# General features

## Volume

### Increasing Volume

Turn the [VOL] knob clockwise.

### Decreasing Volume

Turn the [VOL] knob counterclockwise.

## Attenuator

Turning the volume down quickly.

### Press the [ATT] button.

Each time you press the button, the Attenuator turns ON and OFF.

When the Attenuator is ON, the "ATT" indicator blinks.

## System Q

Selecting the best sound setting preset for different types of music.

### 1 Select the source to set

Press the [SRC] button.

### 2 Select the Sound type

Press the [Q] button.

When you press the button once, the current sound setting is displayed.

Each time you press the button, the sound setting alternates.

Sound setting	Display
User memory	"USER"
Rock	"ROCK"
Pops	"POPS"
Easy	"EASY"
Top 40	"TOP40"
Jazz	"JAZZ"
Natural	"NATURAL"



- User memory: The values set on the <Audio Control> (page 8).
- Change each setting value with the <Speaker Setting> (page 10).  
First, select the speaker type with the Speaker setting.

## Audio Control

### 1 Select the source to adjust

Press the [SRC] button.

### 2 Enter Audio Control mode

Press the [VOL] knob.

### 3 Select the Basic Audio item to adjust

Press the [VOL] knob.

Each time you press the knob, the item to be adjusted alternates between the items shown in the table below.

### 4 Adjust the Basic Audio item

Turn the [VOL] knob.

Adjustment Item	Display	Range
Rear Volume	"R-VOL"	0 — 35
Subwoofer level	"SW L"	-15 — +15
Bass level*	"BAS L"	-8 — +8
Middle level*	"MID L"	-8 — +8
Treble level*	"TRE L"	-8 — +8
Balance	"BAL"	Left 15 — Right 15
Fader	"FAD"	Rear 15 — Front 15

*Exit Audio Control mode (Volume control mode)*

\* You can adjust these items in detail. Refer to <Adjusting the detail of Audio Control> (Page9).

\* Source tone memory: Puts the set up value in the memory per source. (Detail Audio item is included)

### 5 Exit Audio Control mode

Press any button.

Press a button other than the [VOL] knob and [ATT] button.



## Adjusting the detail of Audio Control

Among the Basic Audio items, you can adjust the Bass level, Middle level, and Treble level in detail.

### 1 Select the Basic Audio item

Select the desired item to be set in detail from followings;

- Bass level
- Middle level
- Treble level

For how to select Basic Audio items, see <Audio Control> (page 8).

### 2 Enter Detail adjustment mode of Audio Control

Press the [VOL] knob for at least 1 second.

### 3 Select the Detail Audio item to adjust

Press the [VOL] knob.

Each time you press the knob, the item to be adjusted alternates between the items shown in the table below.

### 4 Adjust the Detail Audio item

Turn the [VOL] knob.

#### Bass level

Adjustment Item	Display	Range
Bass Center Frequency	"BAS F"	40/50/60/70/80/100/ 120/150 Hz
Bass Q Factor	"BAS Q"	1.00/1.25/1.50/2.00
Bass Extend	"B EX"	OFF/ON

#### Middle level

Adjustment Item	Display	Range
Middle Center Frequency	"MID F"	0.5/1.0/1.5/2.0 kHz
Middle Q Factor	"MID Q"	1.0/2.0

#### Treble level

Adjustment Item	Display	Range
Treble Center Frequency	"TRE"	10.0/12.5/15.0/17.5 kHz

### 5 Exit the Detail Audio Control mode

Press the [VOL] knob for at least 1 second.



- When you set the Bass Extend to ON, low frequency response is extended by 20%.
- You can exit the Audio Control mode at anytime by pressing any button except for [VOL] knob and [ATT] button.

# General features

## Audio Setup

Setting the Sound system, such as Cross over Network.

### 1 Select the source to adjust

Press the [SRC] button.

### 2 Enter Audio Setup mode

Press the [VOL] knob for at least 1 second.

### 3 Select the Audio Setup item to adjust

Press the [VOL] knob.

Each time you press the knob, the item to be adjusted alternates between the items shown in the table below.

### 4 Setup the Audio item

Turn the [VOL] knob.

Adjustment Item	Display	Range
Front High Pass Filter	"HPF"	Through/40/60/80/100/120/150/180/220 Hz
Rear High Pass Filter	"HPR"	Through/40/60/80/100/120/150/180/220 Hz
Low Pass Filter	"LPF"	50/60/80/100/120/Through Hz
Subwoofer Phase	"PHAS"	Reverse (180°)/ Normal (0°)
Volume offset	"V-OFF"	-8 — ±0 (AUX: -8 — +8)
Loudness	"LOUD"	OFF/ON
Dual Zone System	"2ZON"	OFF/ON



- Volume offset: Sets each source's volume as a difference from the basic volume.
- Loudness: Compensates for low and high tones during low volume. (Only the low tone is compensated for when the tuner is selected as a source.)
- Dual Zone System  
Main source and sub source (Auxiliary input) output Front channel and Rear channel separately.
  - Set up the channel of sub source by <Dual Zone System Setting> (page 27).
  - Select Main source by [SRC] button.
  - Adjust the volume of Front channel by [VOL] knob.
  - Adjust the volume of Rear channel by <Audio Control> (page 8).
  - The Audio Control has no effect on sub source.
- You can use the Dual Zone System with the internal auxiliary input.

### 5 Exit Audio Setup mode

Press the [VOL] knob for at least 1 second.

## Speaker Setting

Fine-tuning so that the System Q value is optimal when setting the speaker type.

### 1 Enter Standby

Press the [SRC] button.

Select the "STANDBY" display.

### 2 Enter Speaker Setting mode

Press the [VOL] knob.

### 3 Select the Speaker type

Turn the [VOL] knob.

Each time you turn the knob, the setting alternates between the settings shown in the table below.

Speaker type	Display
OFF	"SP OFF"
For 5 & 4 in. speaker	"SP 5/4"
For 6 & 6x9 in. speaker	"SP 6*9/6"
For the OEM speaker	"SP OEM"

### 4 Exit Speaker Setting mode

Press the [VOL] knob.

## Subwoofer Output

Turning the Subwoofer output ON or OFF.

### Push the Control knob toward down for at least 2 seconds.

Each time you push the knob, Subwoofer output switches ON and OFF.  
When it is ON, "SW ON" is displayed.

---

## TEL Mute

---

The audio system automatically mutes when a call comes in.

### ***When a call comes in***

"CALL" is displayed.

The audio system pauses.

### ***Listening to the audio during a call***

**Press the [SRC] button.**

The "CALL" display disappears and the audio system comes back ON.

### ***When the call ends***

**Hang up the phone.**

The "CALL" display disappears and the audio system comes back ON.



- To use the TEL Mute feature, you need to hook up the MUTE wire to your telephone using a commercial telephone accessory. Refer to <Connecting Wires to Terminals> (page 35).

# General features

## Switching Display

Changing the information displayed.

**Press the [DISP] button.**

Each time the button is pressed the display switches as shown below.

### In Tuner source

Information	Display
Program Service name or Frequency (FM)	"FREQ/PS"
Radio text, Program Service name or Frequency (FM)	"R-TEXT"
Frequency (MW, LW)	"FREQ"
Clock	"CLOCK"

### In CD & External disc source

Information	Display
Disc title	"D-TITLE"
Track title	"T-TITLE"
Track number & Play time	"P-TIME"
Clock	"CLOCK"

### In Audio file source

Information	Display
Music title & Artist name	"TITLE"
Album name & Artist name	"ALBUM"
Folder name*	"FOLDER"
File name	"FILE"
Play time & Music number	"P-TIME"
Clock	"CLOCK"

### In Standby/ Auxiliary input source

Information	Display
Source name	"SRC NAME"
Clock	"CLOCK"



- When LX-AMP is connected, the item setup by the Display mode of LX-AMP is displayed.
- When the music number exceeds 1000, only the last 3 digits of its number are displayed.
- When you select the clock display, the display setting of each source will be changed to the clock display.
- Music title, Artist name, and Album name cannot be displayed in WAV file.
- If the selected display item does not have any information, alternative information is displayed.

- \* When playing music from iPod or music edited by "Music Editor", the folder name display may show something different such as playlist or artist name depending on the music selection procedure.

## Tuner features

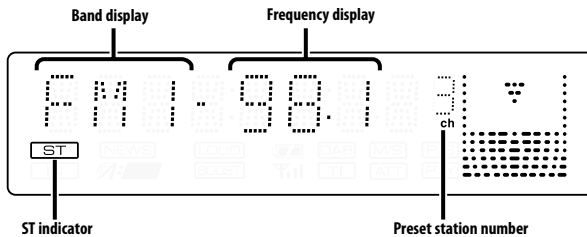
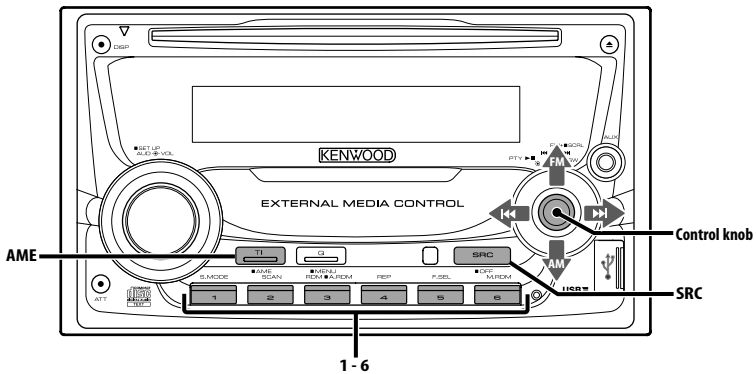

## Tuning

Selecting the station.

### 1 Select tuner source

Press the [SRC] button.

Select the "TUNER" display.

### 2 Select the band

Push the Control knob towards [FM] or [AM].

Each time you push the knob toward [FM], it switches between the FM1, FM2, and FM3 bands.

### 3 Tune up or down band

Push the Control knob towards [◀◀] or [▶▶].



- During reception of stereo stations the "ST" indicator is ON.

# Tuner features

---

Function of remote control

## Direct Access Tuning

---

Entering the frequency and tuning.

### 1 Select the band

Press the [FM] or [AM] button.

### 2 Enter Direct Access Tuning mode

Press the [DIRECT] button on the remote control.

"----" is displayed.

### 3 Enter the frequency

Press the number buttons on the remote control.

Example:

Desired frequency	Press button
92.1 MHz (FM)	[0], [9], [2], [1]
810 kHz (AM)	[0], [8], [1], [0]

## Cancelling Direct Access Tuning

Press the [DIRECT] button on the remote control.



- You can enter the FM band frequency in steps of a minimum of 0.1 MHz.

## Station Preset Memory

---

Putting a station in the memory.

### 1 Select the band

Push the Control knob towards [FM] or [AM].

### 2 Select the frequency to put in the memory

Push the Control knob towards [◀◀] or [▶▶].

### 3 Put the frequency in the memory

Press the desired [1] — [6] button for at least 2 seconds.

The preset number display blinks 1 time.

On each band, 1 station can be put in the memory on each [1] — [6] button.

## Auto Memory Entry

---

Putting stations with good reception in the memory automatically.

### 1 Select the band for Auto Memory Entry

Push the Control knob towards [FM] or [AM].

### 2 Open Auto Memory Entry

Press the [AME] button for at least 2 seconds.

"A-MEMORY" is displayed.

When 6 stations that can be received are put in the memory Auto Memory Entry closes.



- When the <AF (Alternative Frequency)> (page 28) is ON, only RDS stations are put in the memory.
- When Auto Memory Entry is done in the FM2 band, the RDS stations preset in the FM1 band are not put in the memory.  
Likewise, when Auto Memory Entry is done in the FM3 band, RDS stations preset in FM1 or FM2 are not put in the memory.

## Preset Tuning

---

Recalling the stations in the memory.

### 1 Select the band

Push the Control knob towards [FM] or [AM].

### 2 Recall the station

Press the desired [1] — [6] button.

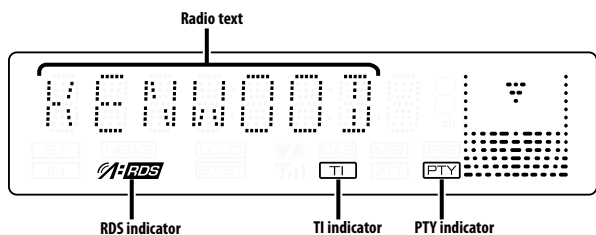
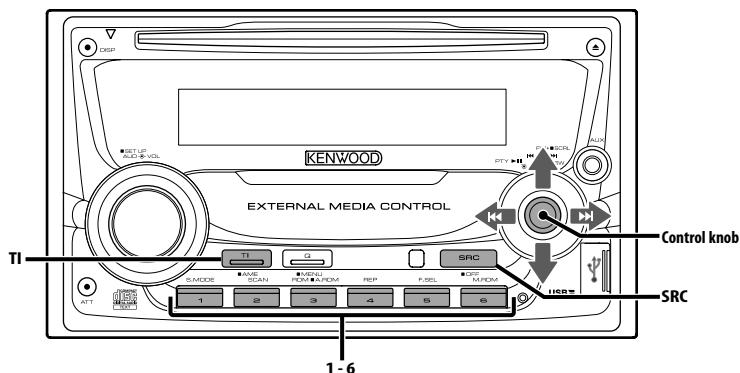

## Traffic Information

Changing to traffic information automatically when a traffic bulletin starts even when you are not listening to the radio.

### Press the [TI] button.

Each time you press the button, the Traffic information function turns ON and OFF. When traffic information is ON, "TI" indicator is ON. When a traffic information station is not being received the "TI" indicator blinks. When a traffic bulletin starts, "TRAFFIC" is displayed and the audio changes to traffic information.



- During reception of an AM station when the Traffic Information function is turned ON, the frequency changes to an FM station.
- During reception of traffic information the adjusted volume is automatically remembered, and the next time the audio changes to traffic information, the volume automatically becomes the remembered volume.

## Receiving other traffic information stations

Push the Control knob towards [◀◀] or [▶▶].



- Traffic information can be switched when it is on the Tuner Source. However, you cannot switch the Traffic information during reception of the Traffic bulletin switched from the source other than the Tuner.

## Radio Text Scroll

Scrolling the displayed radio text.

Push the Control knob toward up for at least 2 seconds.



- When the <Display Illumination Control> (page 26) is set to OFF, the display may black out while scrolling.

## PTY (Program Type)

Selecting the Program Type and searching for a station.

### 1 Enter PTY mode

**Press the Control knob.**

During PTY mode the "PTY" indicator is ON.



- This function cannot be used during a traffic bulletin or AM reception.

### 2 Select the Program Type

**Push the Control knob towards up or down.**

Each time you push the knob, the Program Type alternates between program types shown in the table below.

No.	Program Type	Display
1.	Speech	"SPEECH"
2.	Music	"MUSIC"
3.	News	"NEWS"
4.	Current Affairs	"AFFAIRS"
5.	Information	"INFO"
6.	Sport	"SPORT"
7.	Education	"EDUCATE"
8.	Drama	"DRAMA"
9.	Culture	"CULTURE"
10.	Science	"SCIENCE"
11.	Varied	"VARIED"
12.	Pop Music	"POP M"
13.	Rock Music	"ROCK M"
14.	Easy Listening Music	"EASY M"
15.	Light Classical	"LIGHT M"
16.	Serious Classical	"CLASSICS"
17.	Other Music	"OTHER M"
18.	Weather	"WEATHER"
19.	Finance	"FINANCE"
20.	Children's programs	"CHILDREN"
21.	Social Affairs	"SOCIAL"
22.	Religion	"RELIGION"
23.	Phone In	"PHONE IN"
24.	Travel	"TRAVEL"
25.	Leisure	"LEISURE"
26.	Jazz Music	"JAZZ"
27.	Country Music	"COUNTRY"
28.	National Music	"NATION M"
29.	Oldies Music	"OLDIES"
30.	Folk Music	"FOLK M"
31.	Documentary	"DOCUMENT"



- Speech and Music include the Program type shown below.  
Music: No.12 — 17, 26 — 30  
Speech: No.3 — 11, 18 — 25, 31
- You can put the Program Type in the [1] — [6] button memory and for quick recall. Refer to the <Program Type preset> (page 16).
- You can change the display language. Refer to <Changing Language for PTY Function> (page 17).

### 3 Search for the selected Program Type station

**Push the Control knob towards [◀◀] or [▶▶].**

When you want to search for other stations, push [◀◀] or [▶▶] of the Control knob again.



- When the selected Program Type is not found, "NO PTY" is displayed. Select another Program Type.

### 4 Exit PTY mode

**Press the Control knob.**

## Program Type preset

Putting the Program Type in the Preset button memory and quick recall.

### Presetting the Program Type

#### 1 Select the Program Type to preset

Refer to <PTY (Program Type)> (page 16).

#### 2 Preset the Program Type

**Press the desired [1] — [6] button for at least 2 seconds.**

### Recalling the preset Program Type

#### 1 Enter PTY mode

Refer to <PTY (Program Type)> (page 16).

#### 2 Recall the Program Type

**Press the desired [1] — [6] button.**



---

## **Changing Language for PTY Function**

Selecting the Program Type display language.

### **1 Enter PTY mode**

Refer to <PTY (Program Type)> (page 16).

### **2 Enter Changing Language mode**

Press the [TI] button.

### **3 Select the language**

**Push the Control knob towards up or down.**

Each time you push the knob, the language alternates between the languages shown in the table below.

<b>Language</b>	<b>Display</b>
English	"ENGLISH"
French	"FRENCH"
Swedish	"SWEDISH"
German	"GERMAN"

### **4 Exit Changing Language mode**

Press the [TI] button.

# CD/USB device/Audio file/External disc control features

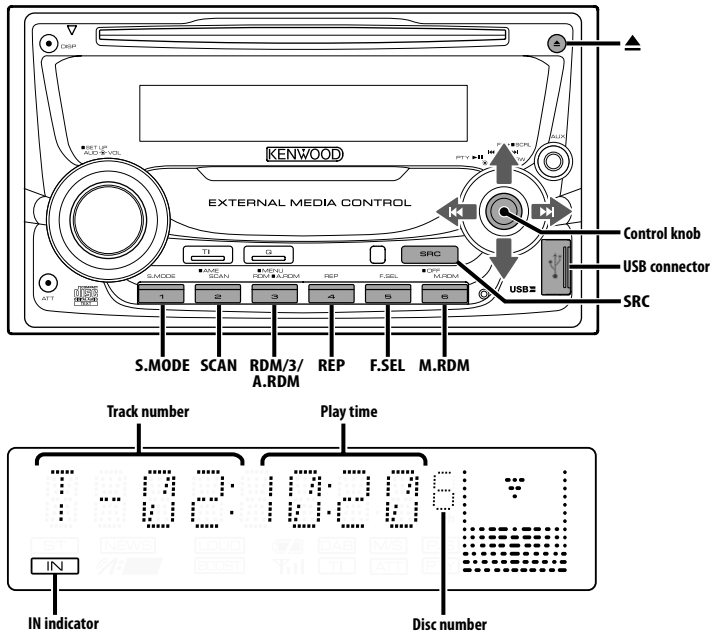

## Playing CD & Audio file

### When a disc is inserted

Press the [SRC] button.

Select the "CD" display.



- When a CD is inserted, the "IN" indicator is ON.

### Pause and play

Press the Control knob.

Each time you press the knob, the audio pauses or plays.

### Eject the CD

Press the [▲] button.



- For the audio files and discs you can play with this unit, refer to <About Audio file> (page 5).
- You can play the file made by KENWOOD Music Editor by the same operation.
- You can eject the disc for 10 minutes after switching off the engine.

## USB Device Connection

- 1 Remove the cap and connect the USB cable.
- 2 Connect the USB device to the unit using the USB cable.

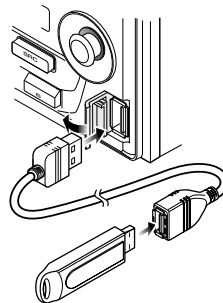

- When connecting the USB device, usage of the CA-U1EX (option) is recommended.

## Playing USB (iPod) device

### **When the USB device is not connected**

#### **Connect the USB device**

Playback of the file contained in the USB device starts.

### **When the USB device is connected**

#### **Select USB source**

##### **Press the [SRC] button.**

Select the "USB" (or "iPod") display.



- For the audio files that can be played with this unit and the devices that can be connected to this unit, refer to <About Audio file> (page 5).
- The word "iPod" appearing in this manual indicates the iPod connected with the KCA-iP200 (optional accessory). Refer to <About Audio file> (page 5).
- If you start playback after connecting the iPod, the music that has been played by the iPod is played first. In this case, "RESUMING" is displayed without displaying a folder name, etc. Changing the browse item will display a correct title, etc.
- When the iPod is connected to this unit, "KENWOOD" or "✓" is displayed on the iPod to indicate that you cannot operate the iPod.
- When the USB device is connected to this unit, it can be charged up provided that this unit is powered.
- When the Multi Card Reader is used, refer to <Drive Search> (page 19).
- After you stopped playing a file contained in the USB device, you can restart playing the file from the point where you stopped its playback. Even after removing the USB device, you can restart playing the file from the point where you stopped its playback as long as the files contained in the USB device are all the same.
- Be sure to insert the USB device connector as far as it will go.
- You can play the file made by KENWOOD Music Editor by the same operation.

### **Pause and play**

#### **Press the Control knob.**

Each time you press the knob, the audio pauses or plays.

### **Removing the USB device**

#### **1 Set the remove mode as the USB source**

**Press the [▲] button for at least 2 seconds.**

"REMOVE" display blinks.

#### **2 Remove the USB device.**

## Drive Search

Selecting the device inserted in the Multi Card Reader.

#### **1 Put the playback to pause**

**Press the [S.MODE] button.**

#### **2 Select a device**

**Push the Control knob towards up or down.**

#### **3 Restart playback**

**Press the [S.MODE] button.**



- This unit is compliant with Multi Card Readers with a maximum of 4 slots.
- If a device is inserted during connection of the Multi Card Reader, it is not recognized. Select the Remove mode with reference to <Playing USB (iPod) device> (page 19), remove the Card Reader, and then insert the memory.

# CD/USB device/Audio file/External disc control features

## Playing External Disc

Playing discs set in the optional accessory disc player connected to this unit.

**Press the [SRC] button.**

Select the display for the disc player you want.

**Display examples:**

Display	Disc player
"CD CH"	CD changer
"MD CH"	MD changer

## Pause and play

**Press the Control knob.**

Each time you press the knob, the audio pauses or plays.



- Disc 10 is displayed as "0".
- The functions that can be used and the information that can be displayed will differ depending on the external disc players being connected.

## Fast Forwarding and Reversing

### Fast Forwarding

**Hold down toward [▶▶] with the Control knob.**

Release to resume the playback.

### Reversing

**Hold down toward [◀◀] with the Control knob.**

Release to resume the playback.



- There is no sound while the Audio file is being searched.
- The accurate play time is not displayed during fast forwarding or reversing of the Audio file.

## Music Search

Switching between music contained in the disc or folder being played now.

**Push the Control knob towards [◀◀] or [▶▶].**

*Function of disc changer/ Audio file*

## Disc Search/Folder/Album Search

Switching between folders/albums contained in the disc in the disc changer, media, or device being played now.

**Push the Control knob towards up or down.**

*Function of remote control*

## Direct Music Search

Doing Music Search by entering the music number.

### 1 Enter the music number

**Press the number buttons on the remote control.**



- You can select Direct music Search up to 999.

### 2 Do music Search

**Press the [◀◀] or [▶▶] button.**

### Cancelling Direct Music Search

**Press the [▶II] button.**



- This function is not available on iPod and the music edited by "Music Editor".

*Function of disc changers with remote control*

## Direct Disc Search

Doing Disc Search by entering the disc number.

### 1 Enter the disc number

**Press the number buttons on the remote control.**

### 2 Do Disc Search

**Press the [+ ] or [- ] button.**

### Cancelling Direct Disc Search

**Press the [▶II] button.**



- Input "0" to select disc 10.

## Track/File/Disc/Folder Repeat

Replaying the music, disc in the Disc changer or Audio file folder you are listening to.

**Press the [REP] button.**

Each time you press the button, the Repeat Play alternates between the modes shown in the tables below.

### In CD & External disc source

Repeat play	Display
Track Repeat	"TRAC REP"
Disc Repeat (In Disc Changer)	"DISC REP"
OFF	"REP OFF"

### In Audio file source

Repeat play	Display
File Repeat	"FILE REP"
Folder Repeat*	"FOLD REP"
OFF	"REP OFF"



- \* This function is not available on iPod and the music edited by "Music Editor".

## Scan Play

Playing the first part of each music on the disc or Audio file folder you are listening to and searching for the music you want to hear.

### 1 Start Scan Play

**Press the [SCAN] button.**

"TRAC SCN"/"FILE SCN"/"SCAN ON" is displayed.

### 2 Release it when the music you want to listen to is played

**Press the [SCAN] button.**



- This function is not available on iPod and the music edited by "Music Editor".

## Random Play

Play all the music on the disc or Audio file folder in random order.

**Press the [RDM] button.**

Each time you press the button, Random Play turns ON or OFF.

When the Random mode is ON, "DISC RDM"/"FOLD RDM"/"RDM ON" is displayed.



- When you push the Control knob toward [▶▶], the next selected music starts.

### Function of disc changer

## Magazine Random Play

Play the music on all the discs in the disc changer in random order.

**Press the [M.RDM] button.**

Each time you press the button, the Magazine Random Play turns ON or OFF.

When the Magazine Random mode is ON, "MGZN RDM" is displayed.



- When you push the Control knob toward [▶▶], the next selected music starts.

# CD/USB device/Audio file/External disc control features

## Function of Audio file

### All Random Play

Playing randomly from all of the Audio files recorded in the media.

Press the [A.RDM] button for at least 1 second.

When the random mode is ON, "ALL RDM" is displayed.

### Cancelling the All Random Play

Press the [A.RDM] button.



- When you push the Control knob toward [▶▶], the next selected music starts.
- This function is not available on iPod and the music edited by "Music Editor".

## Function of iPod, "Music Editor" file

### File select

Selecting the music you want to listen to from the device or media being played now.

#### 1 Enter File Select mode

Press the [F.SEL] button.

Select the "F-SEL" display.

#### 2 Search for a music

Select the category item using the Control knob.

Operation type	Operation
Movement between items	Push the Control knob towards right or left.
Selection of item	Press the Control knob.
Return to previous item	Push the Control knob for at least 1 second.
Return to first item	Press the [3] button.

Names of all the music are displayed in "SONGS" in the audio file.

Selecting a music will play it from the beginning.

### Cancelling File Select

Press the [F.SEL] button.

## Function of non-iPod and non-"Music Editor" file

### File Select 1 mode

Select the target folder by tracing the hierarchical levels of folders. This is convenient when managing audio files by folder.

#### 1 Enter File Select 1 mode

Press the [F.SEL] button.

Select the "F-SEL1" display.

Folder name display

Displays the current folder name.

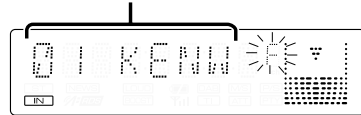

#### 2 Select the folder

Operation type	Operation
Movement between folders	Push the Control knob towards right or left.
Selection of folder	Push the Control knob towards up.
Return to previous folder	Push the Control knob towards down.
Return to root folder	Press the [3] button.

Select the folder containing the music you want to listen to.

#### 3 Determine the folder

Press the Control knob.

The music in the determined folder are displayed.

#### 4 Select the music you want to listen to

Operation type	Operation
Movement between music	Push the Control knob towards right or left.
Return to folder selection step	Press the Control knob for at least 1 second.
Return to root folder	Press the [3] button.

#### 5 Play the selected music

Press the Control knob.

### Scrolling the file/folder name display

Push the Control knob toward up for at least 2 seconds.

### Cancelling File Select 1

Press the [F.SEL] button twice.

Function of non-iPod and non-"Music Editor" file

## File Select 2 mode

Select the target folder within the folders containing audio files. The folder which contains playable audio files is only displayed.

### 1 Enter File Select 2 mode

Press the [F.SEL] button twice.

Select the "F-SEL2" display.

**Folder name display**

Displays the current folder name.

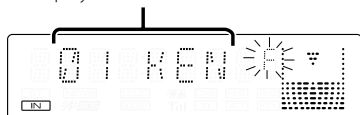

### 2 Select the folder

Push the Control knob towards right or left.

Each time you push the knob, the folders containing audio files are displayed one after another.

### Check the name of upper level folder

Push the Control knob towards up.

Each time you push the knob towards up, the folder just above the current folder is displayed. Each time you push the knob towards down, the folder just below the current folder is displayed. "M" is displayed while the upper level folder is displayed.

### 3 Determine the folder

Press the Control knob.

The music in the determined folder are displayed.

### 4 Select the music you want to listen to

Operation type	Operation
Movement between music	Push the Control knob towards right or left.
Return to folder selection step	Press the Control knob for at least 1 second.

### 5 Play the selected music

Press the Control knob.

### Scrolling the file/folder name display

Push the Control knob toward up for at least 2 seconds.

### Cancelling File Select 2

Press the [F.SEL] button.

## Text/Title Scroll

Scrolling the displayed CD text, Audio file text, or MD title.

**Push the Control knob toward up for at least 2 seconds.**



- When the <Display Illumination Control> (page 26) is set to OFF, the display may black out while scrolling.

# Menu system

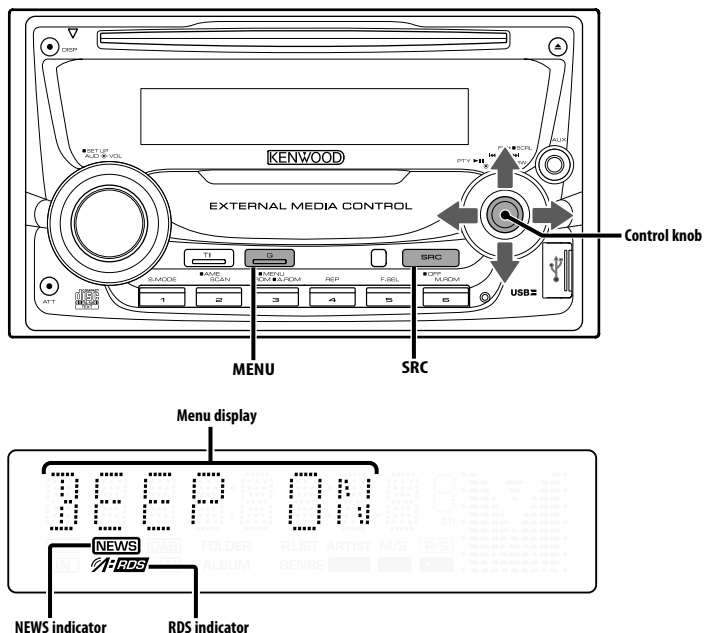

## Menu System

Setting beep sound during operation, etc. functions.

The Menu system basic operation method is explained here. The reference for the Menu items and their setting content is after this operation explanation.

### 1 Enter Menu mode

Press the [MENU] button for at least 1 second.

"MENU" is displayed.

### 2 Select the menu item

Push the Control knob towards up or down.

Example: When you want to set the beep sound select the "BEEP" display.

### 3 Set the menu item

Push the Control knob towards right or left.

Example: When you select "BEEP", each time you push the knob it alternates between "BEEP ON" or "BEEP OFF". Select 1 of them as the setting.

You can continue by returning to step 2 and setting other items.

### 4 Exit Menu mode

Press the [MENU] button.



- When other items those applicable to the basic operation method above are displayed, their setting content chart is entered. (Normally the setting listed at the top of the chart is the original setting.) Also, the explanation for items that are not applicable (<Manual Clock Adjustment> etc.) are entered step by step.



In Standby mode

## Security Code

Activating the Security Code disables the usage of audio unit by someone else. Once the Security Code is activated, the entry of authorized Security Code is required to turn on the audio unit when it is removed from the vehicle. Indication of this Security Code activation prevents your precious audio unit from stealing.



- When you activate the Security Code function, it cannot be released.

Note, your Security Code is the 4 digit number entered in your "Car Audio Passport" in this package.

### 1 Enter Standby

Press the [SRC] button.

Select the "STANDBY" display.

### 2 Enter Menu mode

Press the [MENU] button for at least 1 second.

When "MENU" is displayed, "CODE SET" is also displayed.

### 3 Enter Security Code mode

Press the Control knob for at least 1 second.

When "ENTER" is displayed, "CODE" is also displayed.

### 4 Select the digits to enter

Push the Control knob towards right or left.

### 5 Select the Security Code numbers

Push the Control knob towards up or down.

### 6 Repeat step 4 and 5, and complete the Security Code.

### 7 Confirm the Security Code

Press the Control knob for at least 3 seconds.

When "RE-ENTER" is displayed, "CODE" is also displayed.

### 8 Do the step 4 through 7 step operation, and reenter the security code.

"APPROVED" is displayed.

The Security Code function activates.



- If you enter a Code different from your Security Code, you have to start over from step 4.

### 9 Exit Security Code mode

Press the [MENU] button.

## Resetting the Security Code function when the audio unit is first used after removed from the battery power source or the Reset button is pressed

### 1 Turn the power ON.

### 2 Do the step 4 through 7 step operation, and reenter the security code.

"APPROVED" is displayed.

Now, you can use the unit.



- If an incorrect code is entered, "WAITING" is displayed, and the input prohibition periods shown in the table below is generated.

After the input prohibition time lapses, "CODE" is displayed, and you can reenter the code.

Number of times the incorrect code was input	Input prohibited time
1	—
2	5 minutes
3	1 hour
4	24 hours

In Standby mode

## Touch Sensor Tone

Setting the operation check sound (beep sound) ON/OFF.

Display	Setting
"BEEP ON"	Beep is heard.
"BEEP OFF"	Beep canceled.

# Menu system

In Standby mode

## Manual Clock Adjustment



- You can do this adjustment when the <Synchronize Clock> (page 26) is set as OFF.

### 1 Select Clock Adjustment mode

Push the Control knob towards up or down.

Select the "CLK ADJ" display.

### 2 Enter Clock Adjust mode

Press the Control knob for at least 1 second.

The clock display blinks.

### 3 Adjust the hours

Push the Control knob towards up or down.

**Adjust the minutes**

Push the Control knob towards right or left.

### 4 Exit Clock adjustment mode

Press the [MENU] button.

In Standby mode

## Synchronize Clock

Synchronizing the RDS station time data and this unit's clock.

Display	Setting
"SYNC ON"	Synchronizes the time.
"SYNC OFF"	Adjust the time manually.



- It takes 3 to 4 minutes to synchronize the clock.

## Display Illumination Control

This function turns off the display when you perform no operation for 5 seconds. This function is effective when you are driving at night.

Display	Setting
"DISP ON"	Keeps the display on.
"DISP OFF"	Turns off the display when you perform no operation for 5 seconds.



- Set the Display Illumination Control when the <Demonstration mode Setting> (page 31) is set to OFF.
- When the display is off, pressing any key will turn on the display.
- When the display is off, you cannot perform any operation except for the following:
  - Volume
  - Attenuator
  - Selecting the source
  - Ejecting the disc
  - Turning off the power
  - USB remove mode
- During function control, such as the Menu System, the display stays on.

In Standby mode

## Dimmer

Dimming this unit's display automatically when the vehicle light switch is turned ON.

Display	Setting
"DIM AUTO"	The display dims.
"DIM OFF"	The display doesn't dim.

In Standby mode

## Switching preout

Alternating the preout between the rear and subwoofer. (With the subwoofer the sound outputs without being effected by fader control.)

Display	Setting
"SWPRE R"	Rear preout.
"SWPRE SW"	Subwoofer preout.

*In Standby mode*

## **Built-in Amp Setting**

Controlling the built-in amplifier.  
Turning OFF this control enhances the preout quality.

Display	Setting
"AMP ON"	The built-in amplifier activates.
"AMP OFF"	The built-in amplifier deactivates.

*Other than Standby mode/  
When the Dual Zone System is ON*

## **Dual Zone System Setting**

Setting the Front channel and Rear channel sound in the Dual Zone System.

Display	Setting
"ZONE2 R"	Sub source (Auxiliary input source) is to be rear channel.
"ZONE2 F"	Sub source (Auxiliary input source) is to be front channel.

*In Audio file source*

## **Supreme Setting**

When AAC, MP3 or WMA files encoded at a low bit rate (less than 96kbps (fs=44.1k, 48kHz)) are played, this function restores their high frequency region to approach the sound quality of equivalents of these files encoded at a high bit rate. Processing is optimized for the compression format used (AAC, MP3, or WMA), and adjustment is made for the bit rate used.

Display	Setting
"SPRM ON"	Plays sound using the Supreme function.
"SPRM OFF"	Plays the original sound stored in the audio file.



- The sound effect may be imperceptible depending on the relationship between the audio file format and setting.
- This function is not available on the iPod.

*When LX AMP unit connecting*

## **AMP Control**

You can control the LX AMP connected to the unit.

### **1 Select AMP Control mode**

**Push the Control knob towards up or down.**

Select the "AMP CTRL" display.

### **2 Enter AMP Control mode**

**Press the Control knob for at least 1 second.**

### **3 Select the AMP Control item for adjustment**

**Push the Control knob towards up or down.**



- For the details on the AMP Control item, see the Instruction manual attached to the LX AMP.

### **4 Adjust the AMP Control item**

**Push the Control knob towards right or left.**

### **5 Exit AMP Control mode**

**Press the [MENU] button.**



- You cannot use the LX AMP operation during standby mode.

# Menu system

Other than Standby mode

## News Bulletin with Timeout Setting

The tuner automatically changes when a news bulletin starts even if the radio is not being listened to. Also, you can set the time interval when interruption is prohibited.

### Display and Setting

"NEWS OFF"

"NEWS 00M"

⋮

"NEWS 90M"

When you set "NEWS 00M" — "NEWS 90M", the News Bulletin Interrupt function is ON.

When the News Bulletin is ON, the "NEWS" indicator is ON.

When the news bulletin starts, "NEWS" is displayed, and the tuner changes to the news bulletin.



- If you choose the "20M" setting, further news bulletins will not be received for 20 minutes once the first news bulletin is received.
- The news bulletin volume is the same level that was set for <Traffic Information> (page 15).
- This news bulletin function is only available if the desired station sends PTY-code for news bulletin or belongs to <Enhanced Other Network>-Network sending PTY-code for news bulletin.
- When the News Bulletin Interrupt function is ON, the tuner changes to an FM station.

In Tuner mode

## Local Seek

Only stations whose reception is good are searched in auto seek tuning.

### Display

"LO.S OFF"

"LO.S ON"

### Setting

The local seek function is OFF.

The local seek function is ON.

In Tuner mode

## Tuning Mode

Sets the tuning mode.

Tuning mode	Display	Operation
Auto seek	"AUTO 1"	Automatic search for a station.
Preset station seek	"AUTO 2"	Search in order of the stations in the Preset memory.
Manual	"MANUAL"	Normal manual tuning control.

## AF (Alternative Frequency)

When the reception is poor, automatically alternate to another frequency broadcasting the same program in the same RDS network with better reception.

Display	Setting
"AF ON"	The AF function is ON.
"AF OFF"	The AF function is OFF.

When the AF function is ON, the "RDS" indicator is ON.



- When no other stations with stronger reception are available for the same program in the RDS network, you may hear the incoming broadcast in bits and snatches. Turn OFF the AF function in such a case.

## Restricting RDS Region (Region Restrict Function)

You can choose whether or not to restrict the RDS channels, received with the AF function for a particular network, to a specific region.

Display	Setting
"REG ON"	The Region Restrict Function is ON.
"REG OFF"	The Region Restrict Function is OFF.



- If AF function is not restricted to the specified region and network, the AF function sets up to search the station with good reception in the same RDS network.

## Auto TP Seek

When the TI function is ON and the reception is poor while listening to a traffic information station, another traffic information station with better reception will be searched for automatically.

Display	Setting
"ATPS ON"	The Auto TP Seek Function is ON.
"ATPS OFF"	The Auto TP Seek Function is OFF.

*In FM reception*

## Monaural Reception

You can reduce the noise when stereo broadcasts are received as monaural.

Display	Setting
"MONO OFF"	The monaural reception is OFF.
"MONO ON"	The monaural reception is ON.

## Auxiliary Input Display Setting

Selecting the display when changing to Auxiliary input source.

### 1 Select Auxiliary input source

Press the [SRC] button.

Select the "AUX"/"AUX EXT" display.

### 2 Enter Menu mode

Press the [MENU] button for at least 1 second.

"MENU" is displayed.

### 3 Select Auxiliary input display setting mode

Push the Control knob towards up or down.

Select the "NAME SET" display.

### 4 Enter Auxiliary input display setting mode

Press the Control knob for at least 1 second.

The presently selected Auxiliary input display is displayed.

### 5 Select the Auxiliary input display

Push the Control knob towards right or left.

Each time you push the knob, the display alternates as listed below.

- "AUX"/"AUX EXT"
- "DVD"
- "PORTABLE"

- "GAME"
- "VIDEO"
- "TV"

## 6 Exit Auxiliary input display setting mode

Press the [MENU] button.



- When operation stops for 10 seconds, the name at that time is registered, and the Auxiliary input display setting mode closes.
- You can only set the Auxiliary input display when the built-in auxiliary input or the auxiliary input of optional KCA-S220A is used.

*Function of DPX502UY*

*In Standby mode*

## Selecting Russian Characters

Setting up the display of Russian characters and undistinguishable English characters.

Display	Setting
"RUS ON"	Displays texts using Russian characters.
"RUS OFF"	Displays texts using European characters.



- Texts displayed using Russian characters are as follows.
  - Folder name/ File name/ Music title/ Artist name/ Album name
  - CD text (internal CD source)
- Texts cannot distinguish upper case and lower case in Russian characters.

А	Б	В	Г	Д	Е	Ж	З	И	Й	К	Л	М	Н	О	П
а	б	в	г	д	е	ж	з	и	й	к	л	м	н	о	п
Р	С	Т	У	Ф	Х	Ц	Ч	Ш	Щ	Ъ	Ы	Ь	Э	Ю	Я
р	с	т	у	ф	х	ц	ч	ш	щ	ъ	ы	ь	э	ю	я

# Menu system

## Text Scroll

Setting the displayed text scroll.

Display	Setting
"SCL MANU"	Doesn't scroll.
"SCL AUTO"	Scrolls when the display changes.



- The text scrolled is listed below.
  - CD text
  - Folder name/ File name/ Music title/ Artist name/ Album name
  - MD title
  - Radio text

In Standby mode

## Built-in Auxiliary input Setting

Set the Built-in Auxiliary Input function.

Display	Setting
"AUX OFF"	When selecting the source there's no Auxiliary Input.
"AUX ON"	When selecting the source there's Auxiliary Input.

In Standby mode

## Power OFF Timer

Setting the timer to turn this unit's power OFF automatically when Standby mode continues. Using this setting can save the vehicle's battery power.

Display	Setting
"OFF -- --"	Power OFF Timer function is OFF.
"OFF 20M" (Original setting)	Turns the power OFF after 20 minutes.
"OFF 40M"	Turns the power OFF after 40 minutes.
"OFF 60M"	Turns the power OFF after 60 minutes.

In Standby mode

## CD Read Setting

When there is a problem with playing a CD with special format, this setting plays the CD by force.

Display	Setting
"CD READ1"	Play CD and Audio file.
"CD READ2"	Play CD by force.



- Some music CDs may not play even in the "CD READ2" mode.

Other than Standby mode

## Audio Preset Memory

Registering the value setup by Sound Control. The memory cannot be erased by the Reset button.

### 1 Setup Sound Control

Refer to the following operations to setup the Sound Control.

- <Audio Control> (page 8)
- <Audio Setup> (page 10)

### 2 Enter Menu mode

Press the [MENU] button for at least 1 second. "MENU" is displayed.

### 3 Select Audio Preset mode

Push the Control knob towards up or down. Select the "A-PRESET" display.

### 4 Enter Audio Preset mode

Press the Control knob for at least 1 second.

### 5 Select the Audio Preset Memory

Push the Control knob towards up or down. Select the "MEMORY" display.

### 6 Put the Audio Preset in the memory

Press the Control knob for at least 2 seconds. The "MEMORY" display blinks 1 time.

### 7 Exit Audio Preset mode

Press the [MENU] button.



- Register 1 pair of Audio Preset Memory. You cannot register by the source.
- When you press the Reset, all the sources will be the setting value which is registered.

- The following items cannot be registered.  
Volume, Balance, Fader, Loudness, Volume offset, Dual Zone System, Rear Volume

*Other than Standby mode*

## **Audio Preset Recall**

Recalling the sound setup registered by <Audio Preset Memory> (page 30).

- 1 Select the source**  
Press the [SRC] button.
- 2 Enter Menu mode**  
Press the [MENU] button for at least 1 second.  
"MENU" is displayed.
- 3 Select Audio Preset mode**  
Push the Control knob towards up or down.  
Select the "A-PRESET" display.
- 4 Enter Audio Preset mode**  
Press the Control knob for at least 1 second.
- 5 Select the Audio Preset Recall**  
Push the Control knob towards up or down.  
Select the "RECALL" display.
- 6 Recall the Audio Preset**  
Press the Control knob for at least 2 seconds.  
The "RECALL" display blinks 1 time.
- 7 Exit Audio Preset mode**  
Press the [MENU] button.



- The User memory of <System Q> (page 8) is changed to the value which was recalled.
- The source tone memory item of <Audio Control> (page 8) is changed to the value which was recalled by the selected source.

*In Standby mode*

## **Firmware version display**

Displaying the firmware version with the unit.

- 1 Select the firmware version display mode**  
Push the Control knob towards up or down.  
Select the "F/W VER" display.
- 2 Display the firmware version**  
Push the Control knob towards right or left.

*In Standby mode*

## **Demonstration mode Setting**

Sets the demonstration mode.

- 1 Select the Demonstration mode**  
Push the Control knob towards up or down.  
Select the "DEMO" display.
- 2 Set the Demonstration mode**  
Press the Control knob for at least 2 seconds.  
Each time you press the knob at least 2 seconds, the Demonstration mode alternates between the settings shown in the table below.

Display	Setting
"DEMO ON"	The Demonstration mode function is ON.
"DEMO OFF"	Exit Demonstration mode (Normal mode).

# Basic Operations of remote control

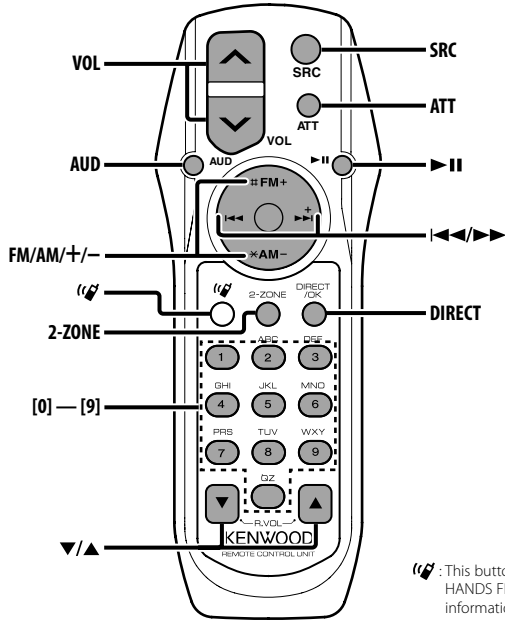

: This button is used when Kenwood Bluetooth HANDS FREE BOX is connected. For more information, refer to the instruction manual of Bluetooth HANDS FREE BOX.

## Loading and Replacing the battery

Use two "AA"/ "R6"-size batteries.  
Slide the cover while pressing downwards to remove it as illustrated.  
Insert the batteries with the + and - poles aligned properly, following the illustration inside the case.

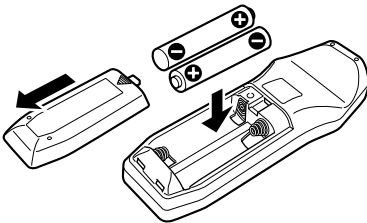

### ▲WARNING

- Store unused batteries out of the reach of children.  
Contact a doctor immediately if the battery is accidentally swallowed.



- Do not set the remote control in hot places such as on the dashboard.

## Basic operations

### [VOL] buttons

Adjusts the volume.

### [SRC] button

Each time you press the button, the source alternates.

For the source alternating order refer to <Selecting the Source> (page 7).

### [ATT] button

Turns the volume down quickly.

When the button is pressed again, the volume returns to the previous level.



## Audio Control

---

### [AUD] button

Selects the Audio item to be adjusted.

### [VOL] buttons

Adjusts the Audio item.



- Refer to <Audio Control> (page 8) for the operation method, such as the procedures for Audio control and others operations.
- The remote control can only select and adjust the Basic Audio item. Selecting and adjusting of the Detail Audio item cannot be done.

## Dual Zone System

---

### [2-ZONE] button

Each time you press the button, "2ZON" of <Audio Setup> (page 10) is turned ON or OFF.

### [▲]/ [▼] buttons

Adjusts the volume of the rear channel.  
The rear channel activates while the Dual Zone System is ON.

## In Tuner source

---

### [FM]/ [AM] buttons

Selects the band.  
Each time you press the [FM] button, the band alternates between the FM1, FM2, and FM3 bands.

### [◀◀]/ [▶▶] buttons

Tune up or down band.

### [0] — [9] buttons

Press buttons [1] — [6] to recall preset stations.

### [DIRECT] button

Enters and cancels the <Direct Access Tuning> (page 14) mode.

### [▶▶] button

Enters and cancels the <PTY (Program Type)> (page 16) mode.

## In Disc/USB source

---

### [◀◀]/ [▶▶] buttons

Going forwards and backwards between music.

### [+]/ [-] buttons

Going forwards and backwards between disc/ folders.

### [▶||] button

Each time you press the button, the music is played or paused.

### [0] — [9] buttons

When in <Direct Music Search> (page 20) and <Direct Disc Search> (page 20), enters the music/ disc number.

# Accessories/ Installation Procedure

## Accessories

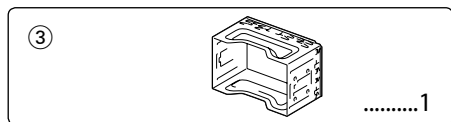
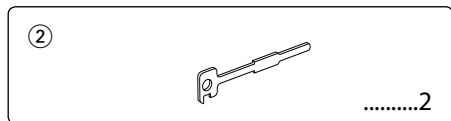
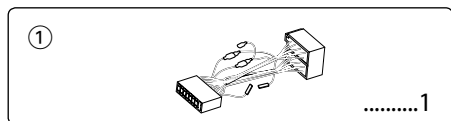

## Installation Procedure

1. To prevent short circuits, remove the key from the ignition and disconnect the ⊖ terminal of the battery.
2. Make the proper input and output wire connections for each unit.
3. Connect the wire on the wiring harness.
4. Take Connector B on the wiring harness and connect it to the speaker connector in your vehicle.
5. Take Connector A on the wiring harness and connect it to the external power connector on your vehicle.
6. Connect the wiring harness connector to the unit.
7. Install the unit in your car.
8. Reconnect the ⊖ terminal of the battery.
9. Press the reset button.



- If the power is not turned ON ("PROTECT" is displayed), the speaker wire may have a short-circuit or touched the chassis of the vehicle and the protection function may have been activated. Therefore, the speaker wire should be checked.
- If your car is not prepared for this special connection-system, consult your Kenwood dealer.
- Use a commercially available conversion connector if the connector does not fit in the vehicle connector.
- Make sure that all wire connections are securely made by inserting jacks until they lock completely.
- If your vehicle's ignition does not have an ACC position, or if the ignition wire is connected to a power source with constant voltage such as a battery wire, the power will not be linked with the ignition (i.e., it will not turn on and off along with the ignition). If you want to link the unit's power with the ignition, connect the ignition wire to a power source that can be turned on and off with the ignition key.
- If the fuse blows, first make sure that the wires have not caused a short circuit, then replace the old fuse with one with the same rating.
- Insulate unconnected wires with vinyl tape or other similar material. To prevent short circuits, also do not remove the caps on the ends of the unconnected wires or the terminals.
- Connect the speaker wires correctly to the terminals to which they correspond. The unit may receive damage or fail to work if you share the ⊖ wires and/or ground them to any metal part in the car.
- After the unit is installed, check whether the brake lamps, indicators, wipers, etc. on the car are working properly.
- If the console has a lid, make sure to install the unit so that the faceplate does not hit the lid when closing and opening.
- Mount the unit so that the mounting angle is 30° or less.

## If You Want to Connect iPod

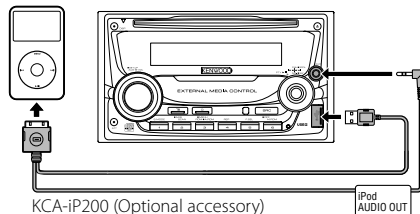

- No other optional accessory can be connected because the USB connector and the AUX input are used for iPod connection.
- Dual Zone System in <Audio Setup> (page 10) will become unavailable.

# Connecting Wires to Terminals

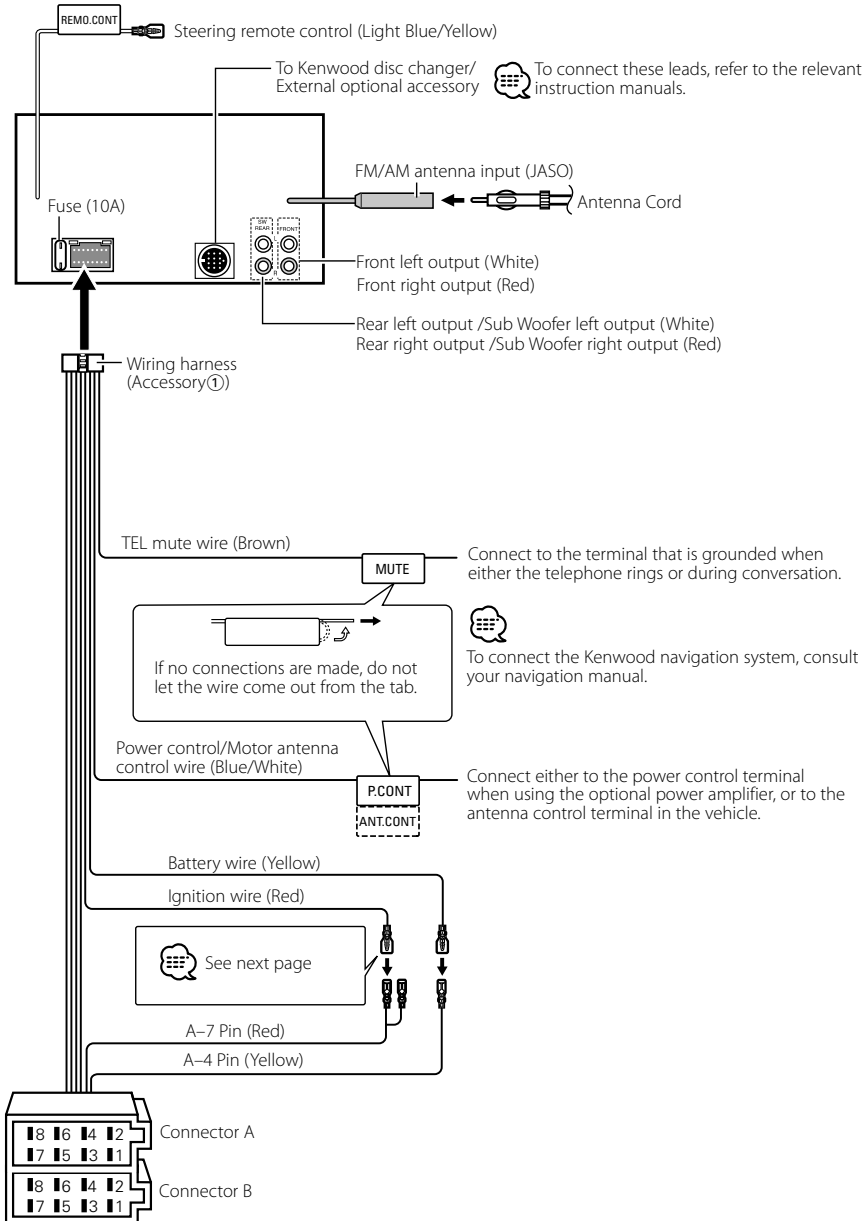

# Connecting Wires to Terminals

## Connector Function Guide

Pin Numbers for ISO Connectors	Cable Colour	Functions
<b>External Power Connector</b>		
A-4	Yellow	Battery
A-5	Blue/White	Power Control
A-6	Orange/White	Dimmer
A-7	Red	Ignition (ACC)
A-8	Black	Earth (Ground) Connection
<b>Speaker Connector</b>		
B-1	Purple	Rear Right (+)
B-2	Purple/Black	Rear Right (-)
B-3	Gray	Front Right (+)
B-4	Gray/Black	Front Right (-)
B-5	White	Front Left (+)
B-6	White/Black	Front Left (-)
B-7	Green	Rear Left (+)
B-8	Green/Black	Rear Left (-)

## ⚠ WARNING

### Connecting the ISO Connector

The pin arrangement for the ISO connectors depends on the type of vehicle you drive. Make sure to make the proper connections to prevent damage to the unit.

The default connection for the wiring harness is described in [1] below. If the ISO connector pins are set as described in [2] or [3], make the connection as illustrated.

Please be sure to reconnect the cable as shown [2] below to install this unit to the **Volkswagen** vehicles etc.

[1] (Default setting) The A-7 pin (red) of the vehicle's ISO connector is linked with the ignition, and the A-4 pin (yellow) is connected to the constant power supply.

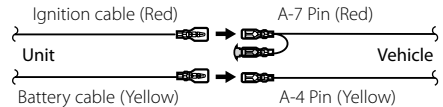

[2] The A-7 pin (red) of the vehicle's ISO connector is connected to the constant power supply, and the A-4 pin (yellow) is linked to the ignition.

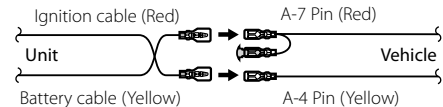

[3] The A-4 pin (yellow) of the vehicle's ISO connector is not connected to anything, while the A-7 pin (red) is connected to the constant power supply (or both the A-7 (red) and A-4 (yellow) pins are connected to the constant power supply).

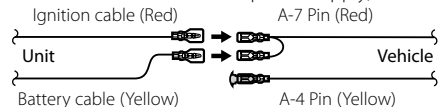

- When the connection is made as in [3] above, the unit's power will not be linked to the ignition key. For that reason, always make sure to turn off the unit's power when the ignition is turned off.

To link the unit's power to the ignition, connect the ignition cable (ACC...red) to a power source that can be turned on and off with the ignition key.

# Installation

---

## Installing the Unit

---

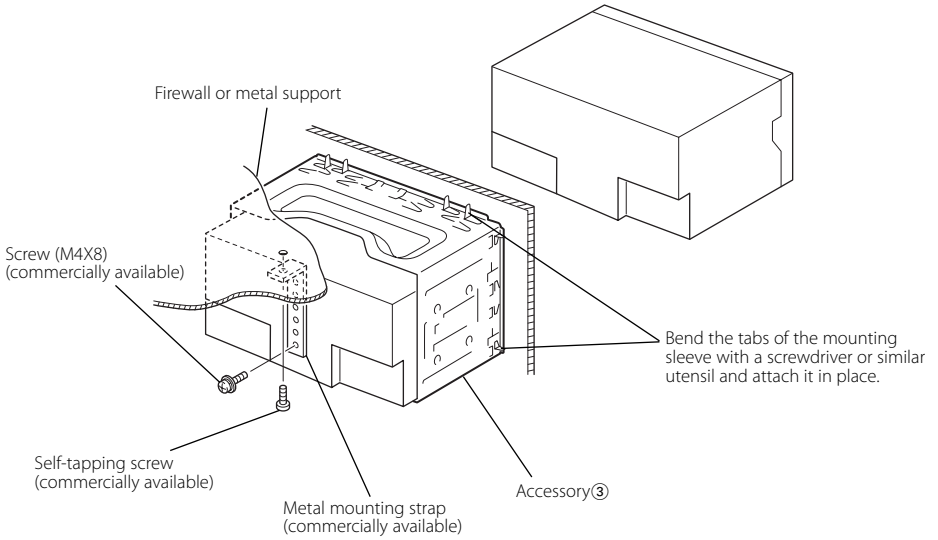

# Removing the Unit

## Removing the Hard Rubber Frame (escutcheon)

1 Engage the catch pins on the removal tool ② and remove the two locks on the lower level. Lower the frame and pull it forward as shown in the figure.

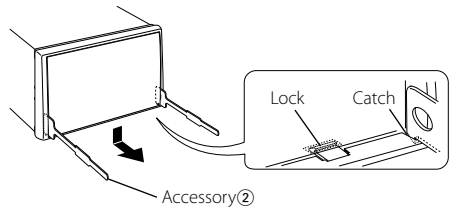

2 When the lower level is removed, remove the upper two locations.



- The frame can be removed from the top side in the same manner.

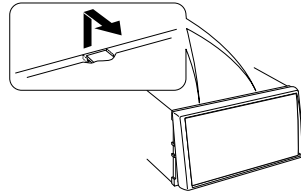

## Removing the Unit

- 1 Refer to the section <Removing the Hard Rubber Frame> and then remove the hard rubber frame.
- 2 Remove the Hex-head screw with integral washer (M4X8) on the back panel.
- 3 Insert the two removal tools ② deeply into the slots on each side, as shown.

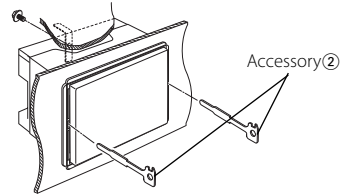

4 Lower the removal tool towards the bottom, and pull out the unit halfway while pressing towards the inside.



- Be careful to avoid injury from the catch pins on the removal tool.

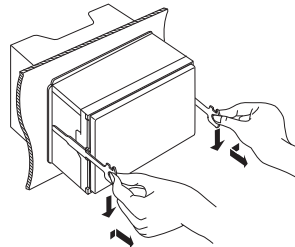

5 Pull the unit all the way out with your hands, carefully not to drop it.

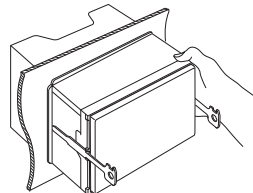

# Troubleshooting Guide

Some functions of this unit may be disabled by some settings made on this unit.

## ! Cannot switch to Aux source.

- ▶ AUX is not turned on. ☞ <Built-in Auxiliary input Setting> (page 30)
- ▶ AUX cannot be used when the KCA-iP200 is connected.

## ! • Cannot set up the subwoofer. • Cannot set up subwoofer phase. • No output from the subwoofer. • Cannot set up the low pass filter.

- ▶ Preout is not set to subwoofer. ☞ <Switching preout> (page 26)
- ▶ <Subwoofer Output> (page 10) is not set to On.
- ▶ The Dual zone function is enabled. ☞ <Audio Setup> (page 10)

## ! • Cannot set up the high pass filter. • Cannot set up the Fader.

- ▶ The Dual zone function is enabled. ☞ <Audio Setup> (page 10)

## ! Cannot set up the subwoofer phase.

- ▶ Low pass filter is set to Through. ☞ <Audio Setup> (page 10)

## ! • Cannot select the output destination of the subsource in the Dual zone. • Cannot adjust the volume of the rear speakers.

- ▶ The Dual zone function is disabled. ☞ <Audio Setup> (page 10)

## ! No Audio control effect on AUX.

- ▶ The Dual zone function is enabled. ☞ <Audio Setup> (page 10)

## ! • Cannot register a security code. • Cannot set up Display Illumination Control.

- ▶ <Demonstration mode Setting> (page 31) is not turned off.

## ! Cannot play audio files.

- ▶ <CD Read Setting> (page 30) is set to "2".

## ! Cannot File select.

- ▶ The Random play function is enabled.

What might seem to be a malfunction in your unit may just be the result of slight misoperation or miswiring. Before calling service, first check the following table for possible problems.

## General

### ? The Touch Sensor Tone doesn't sound.

- ✓ The preout jack is being used.
- ☞ The Touch Sensor Tone can't be output from the preout jack.

## Tuner source

### ? Radio reception is poor.

- ✓ The car antenna is not extended.
- ☞ Pull the antenna out all the way.
- ✓ The antenna control wire is not connected.
- ☞ Connect the wire correctly, referring to the section on <Connecting Wires to Terminals> (page 35).

## Disc source

### ? The specified disc does not play, but another one plays instead.

- ✓ The specified CD is quite dirty.
- ☞ Clean the CD.
- ✓ The disc is loaded in a different slot from that specified.
- ☞ Eject the disc magazine and check the number for the specified disc.
- ✓ The disc is severely scratched.
- ☞ Try another disc instead.

## Audio file source

### ? The sound skips when an Audio file is being played.

- ✓ The media is scratched or dirty.
- ☞ Clean the media, referring to the CD cleaning of the section on <Handling CDs> (page 6).
- ✓ The audio file is broken or not supported.
- ☞ Damaged and unsupported files are skipped.
- ✓ The recording condition is bad.
- ☞ Record the media again or use another media.

## USB device source

### ? The USB device is not detected.

- ✓ The USB connector is disconnected.
- ☞ Connect the connector of the USB device properly.

### ? The USB device does not play its audio files.

- ✓ The USB connector is disconnected.
- ☞ Connect the connector of the USB device properly.

# Troubleshooting Guide

## The messages shown below display your systems condition.

EJECT:	<ul style="list-style-type: none"><li>• No disc magazine has been loaded in the changer. The disc magazine is not completely loaded.</li><li>• No CD in the unit.</li></ul>
NO DISC:	No disc has been loaded in the disc magazine.
TOC ERR:	<ul style="list-style-type: none"><li>• No disc has been loaded in the disc magazine.</li><li>• The CD is quite dirty. The CD is upside-down. The CD is scratched a lot.</li></ul>
READ ERR:	<ul style="list-style-type: none"><li>• The number of files or folders which are stored in the connected USB device is above the limitation.</li><li>• The file system of the connected USB device is broken.</li><li>⇨ Copy the files and folders for the USB device again referring to <a href="http://www.kenwood.com/usb/">http://www.kenwood.com/usb/</a>. If the error message is still displayed, initialize the USB device or use other USB devices.</li></ul>
E-05:	The disc is unreadable.
BLANK:	Nothing has been recorded on the MD.
NO TRACK:	No tracks are recorded on the MD, although it has a title.
NO PANEL:	The faceplate of the slave unit being connected to this unit has been removed.
E-77:	<p>The unit is malfunctioning for some reason.</p> <ul style="list-style-type: none"><li>⇨ Press the reset button on the unit. If the "E-77" code does not disappear, consult your nearest service center.</li></ul>
E-99:	<p>Something is wrong with the disc magazine. Or the unit is malfunctioning for some reason.</p> <ul style="list-style-type: none"><li>⇨ Check the disc magazine. And then press the reset button on the unit. If the "E-99" code does not disappear, consult your nearest service center.</li></ul>
LOAD:	Discs are being exchanged in the Disc changer.
READING:	The unit is reading the data on the disc.
HOLD:	<p>The protective circuit in the unit activates when the temperature inside the automatic disc changer exceeds 60°C (140°F), stopping all operation.</p> <ul style="list-style-type: none"><li>⇨ Cool down the unit by opening the windows or turning on the air conditioner. As the temperature falls below 60°C (140°F), the disc will start playing again.</li></ul>

IN (Blink):	<p>The CD player section is not operating properly.</p> <ul style="list-style-type: none"><li>⇨ Reinsert the CD. If the CD cannot be ejected or the display continues to flash even when the CD has been properly reinserted, please switch off the power and consult your nearest service center.</li></ul>
PROTECT:	<p>The speaker wire has a short-circuit or touches the chassis of the vehicle, and then the protection function is activated.</p> <ul style="list-style-type: none"><li>⇨ Wire or insulate the speaker cable properly and press the reset button. If the "PROTECT" code does not disappear, consult your nearest service center.</li></ul>
NA FILE:	<p>An Audio file is played with a format that this unit can't support.</p> <ul style="list-style-type: none"><li>⇨ ----</li></ul>
COPY PRO:	<p>A copy-protected file is played.</p> <ul style="list-style-type: none"><li>⇨ ----</li></ul>
DEMO:	<p>The Demonstration mode has been selected.</p> <ul style="list-style-type: none"><li>⇨ The &lt;Demonstration mode Setting&gt; (page 31) is ON. Turn it OFF.</li></ul>
NO DVICE:	<p>The USB device is selected as a source although no USB device is connected.</p> <ul style="list-style-type: none"><li>⇨ Change the source to any source other than USB. Connect an USB device, and change the source to USB again.</li></ul>
NA DVICE:	<p>An unsupported USB device is connected.</p> <ul style="list-style-type: none"><li>⇨ For the supported USB devices, refer to &lt;<a href="http://www.kenwood.com/usb/">http://www.kenwood.com/usb/</a>&gt;.</li></ul>
NO MUSIC/E-15:	<p>The connected USB device contains no playable audio file.</p> <ul style="list-style-type: none"><li>• Media was played that doesn't have data recorded that the unit can play.</li></ul>
USB ERR:	<p>The connected USB device is rated a current capacity higher than the allowable limit.</p> <ul style="list-style-type: none"><li>⇨ Check the USB device with reference to &lt;<a href="http://www.kenwood.com/usb/">http://www.kenwood.com/usb/</a>&gt;.</li></ul> <p>Some trouble may have occurred to the connected USB device.</p> <ul style="list-style-type: none"><li>⇨ Change the source to any source other than USB. Remove the USB device.</li></ul>
iPod ERR:	<p>Connection to the iPod has failed.</p> <ul style="list-style-type: none"><li>⇨ Remove the USB device and then reconnect it.</li><li>⇨ Confirm that the software for the iPod is the latest version.</li></ul>
REMOVE:	<p>The Remove mode has been selected for the USB device. You can remove the USB device safely.</p>



# Specifications

---

Specifications subject to change without notice.

## FM tuner section

---

- Frequency range (50 kHz space)
  - : 87.5 MHz – 108.0 MHz
- Usable sensitivity (S/N = 26dB)
  - : 0.7  $\mu$ V /75  $\Omega$
- Quieting Sensitivity (S/N = 46dB)
  - : 1.6  $\mu$ V /75  $\Omega$
- Frequency response ( $\pm$ 3.0 dB)
  - : 30 Hz – 15 kHz
- Signal to Noise ratio (MONO)
  - : 65 dB
- Selectivity (DIN)( $\pm$ 400 kHz)
  - :  $\geq$  80 dB
- Stereo separation (1 kHz)
  - : 35 dB

## MW tuner section

---

- Frequency range (9 kHz space)
  - : 531 kHz – 1611 kHz
- Usable sensitivity (S/N = 20dB)
  - : 25  $\mu$ V

## LW tuner section

---

- Frequency range
  - : 153 kHz – 281 kHz
- Usable sensitivity (S/N = 20dB)
  - : 45  $\mu$ V

## CD player section

---

- Laser diode
  - : GaAlAs
- Digital filter (D/A)
  - : 8 Times Over Sampling
- D/A Converter
  - : 1 Bit
- Spindle speed
  - : 1000 – 400 rpm (CLV 2times)
- Wow & Flutter
  - : Below Measurable Limit
- Frequency response ( $\pm$ 1 dB)
  - : 10 Hz – 20 kHz
- Total harmonic distortion (1 kHz)
  - : 0.008 %
- Signal to Noise ratio (1 kHz)
  - : 105 dB
- Dynamic range
  - : 93 dB
- MP3 decode
  - : Compliant with MPEG-1/2 Audio Layer-3
- WMA decode
  - : Compliant with Windows Media Audio
- AAC decode
  - : AAC-LC ".m4a" files

- WAV signal
  - : Linear-PCM

## Audio section

---

- Maximum output power
  - : 50 W x 4
- Output power (DIN 45324, +B=14.4V)
  - : 30 W x 4
- Speaker impedance
  - : 4 - 8  $\Omega$
- Tone action
  - Bass : 100 Hz  $\pm$ 8 dB
  - Middle : 1 kHz  $\pm$ 8 dB
  - Treble : 10 kHz  $\pm$ 8 dB
- Preout level / Load (during disc play)
  - : 2500 mV/10 k $\Omega$
- Preout impedance
  - :  $\leq$  600  $\Omega$

## USB Interface

---

- USB Standard
  - : USB1.1/ 2.0
- File System
  - : FAT16/ 32
- Maximum Supply current
  - : 500 mA
- MP3 decode
  - : Compliant with MPEG-1/2 Audio Layer-3
- WMA decode
  - : Compliant with Windows Media Audio
- AAC decode
  - : AAC-LC ".m4a" files
- WAV signal
  - : Linear-PCM

## Auxiliary input

---

- Frequency response ( $\pm$ 1 dB)
  - : 20 Hz – 20 kHz
- Input Maximum Voltage
  - : 1200 mV
- Input Impedance
  - : 100 k $\Omega$

## General

---

- Operating voltage (11 – 16V allowable)
  - : 14.4 V
- Current consumption
  - : 10 A
- Installation Size (W x H x D)
  - : 182 x 112 x 160 mm
- Weight
  - : 1.60 kg





---

**KENWOOD**

## Free Manuals Download Website

<http://myh66.com>

<http://usermanuals.us>

<http://www.somanuals.com>

<http://www.4manuals.cc>

<http://www.manual-lib.com>

<http://www.404manual.com>

<http://www.luxmanual.com>

<http://aubethermostatmanual.com>

Golf course search by state

<http://golfingnear.com>

Email search by domain

<http://emailbydomain.com>

Auto manuals search

<http://auto.somanuals.com>

TV manuals search

<http://tv.somanuals.com>