

# KENWOOD

## FP190 series

---

instructions

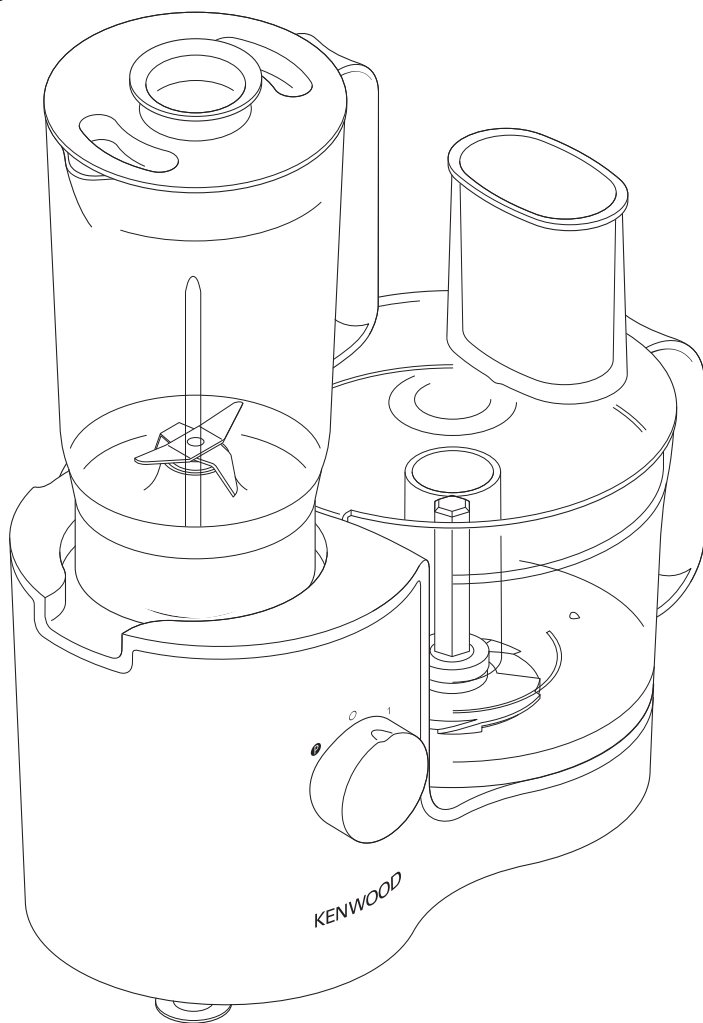

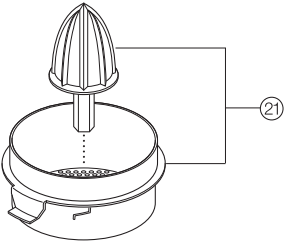
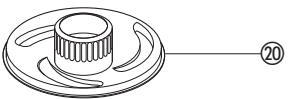
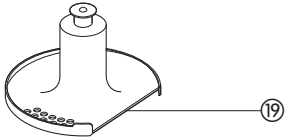
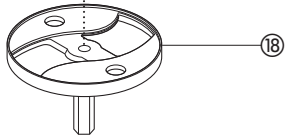
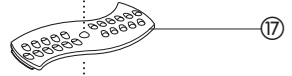
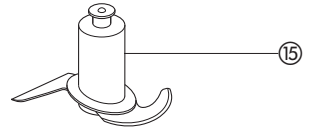
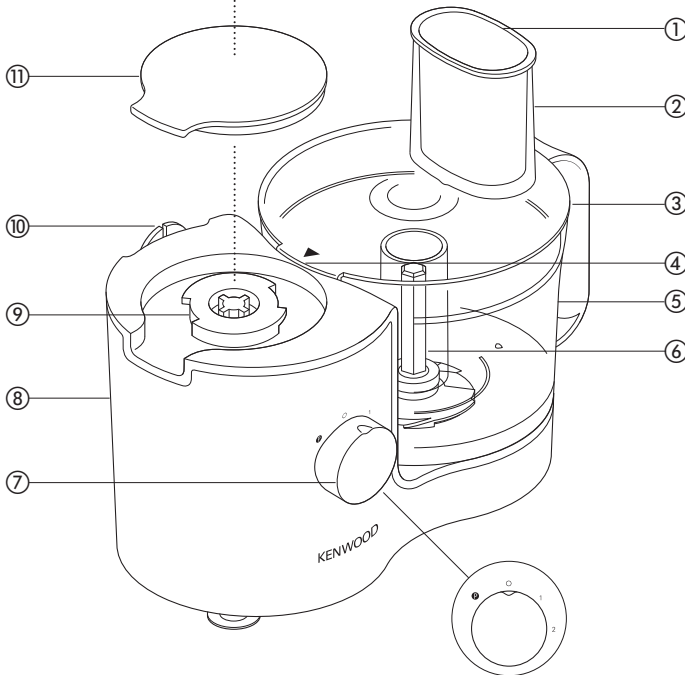
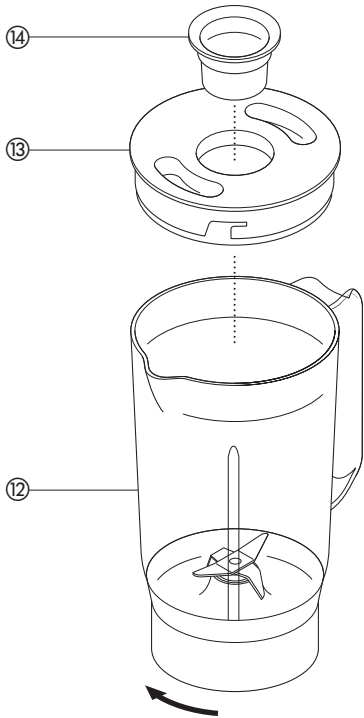

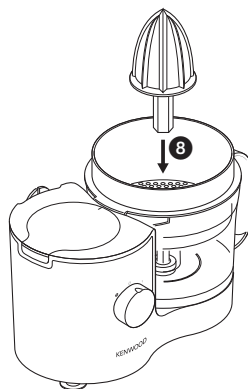
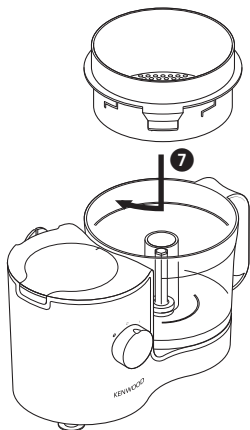
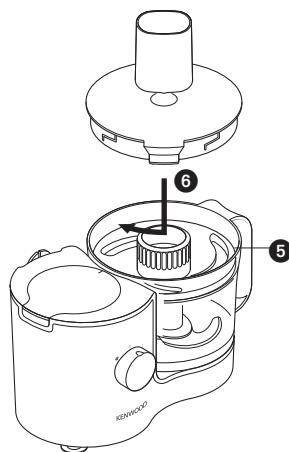
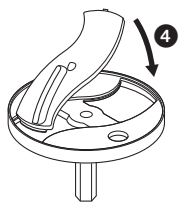
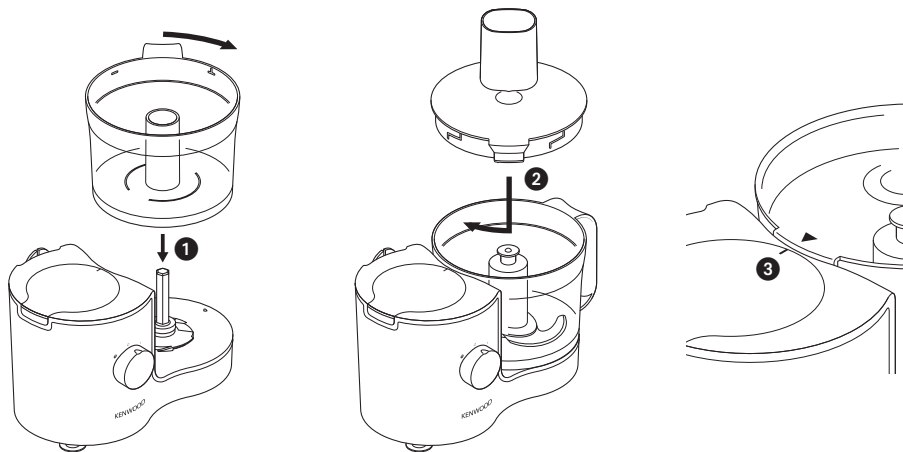

## safety

- Read these instructions carefully and retain for future reference.
- Remove all packaging and any labels.
- The blades and plates are very sharp, handle with care. **Always hold by the finger grip at the top, away from the cutting edge, both when handling and cleaning.**
- Do not lift or carry the processor by the handle - or the handle may break resulting in injury.
- Always remove the knife blade before pouring contents from the bowl.
- Keep hands and utensils out of the processor bowl and liquidiser goblet whilst connected to the power supply.
- Switch off and unplug:
  - before fitting or removing parts;
  - when not in use;
  - before cleaning.
- Never use your fingers to push food down the feed tube. Always use the pusher/s supplied.
- Before removing the lid from the bowl or liquidiser from the power unit:-
  - switch off;
  - wait until the attachment/blades have completely stopped.
- **SCALD RISK:** Hot ingredients should be allowed to cool to room temperature before blending.
- Do not use the lid to operate the processor, always use the on/off speed control.
- **This appliance will be damaged and may cause injury if the interlock mechanism is subjected to excessive force.**
- Never use an unauthorised attachment.
- Never leave the appliance unattended when it is operating.
- Never use a damaged appliance. Get it checked or repaired: see 'service & customer care'.
- Never let the power unit, cord or plug get wet.

- Don't let excess cord hang over the edge of a table or worktop or touch hot surfaces.
- Do not exceed the maximum capacities stated in the recommended speed chart.
- Children should be supervised to ensure that they do not play with the appliance.
- This appliance shall not be used by children. Keep the appliance and its cord out of reach of children.
- Appliances can be used by persons with reduced physical, sensory or mental capabilities or lack of experience and knowledge if they have been given supervision or instruction concerning use of the appliance in a safe way and if they understand the hazards involved.
- Only use the appliance for its intended domestic use. Kenwood will not accept any liability if the appliance is subject to improper use, or failure to comply with these instructions.
- Misuse of your processor/liquidiser can result in injury. Refer to the relevant section under "using the attachments" for additional safety warnings for each individual attachment.

### **liquidiser safety**

- **SCALD RISK:** Hot ingredients should be allowed to cool to room temperature before blending.
- Only operate the liquidiser with the lid in place.
- Never run the liquidiser empty.
- To ensure the long life of your liquidiser, do not run it for longer than 60 seconds.
- Smoothie recipes - never blend frozen ingredients that have formed a solid mass during freezing, break it up before adding to the goblet.

## before plugging in

- Make sure your electricity supply is the same as the one shown on the underside of your appliance.

## Important – UK only

- The wires in the cord are coloured as follows:  
Blue = Neutral, Brown = Live.
- The appliance must be protected by a 3A approved (BS1362) fuse.

## Note:

- For non-rewireable plugs the fuse cover MUST be refitted when replacing the fuse. If the fuse cover is lost then the plug must not be used until a replacement can be obtained. The correct fuse cover is identified by colour and a replacement may be obtained from your Kenwood Authorised Repairer (see Service).
- If a non-rewireable plug is cut off it must be DESTROYED IMMEDIATELY. An electric shock hazard may arise if an unwanted non-rewireable plug is inadvertently inserted into a 13A socket outlet.
- This appliance conforms to EC directive 2004/108/EC on Electromagnetic Compatibility and EC regulation no. 1935/2004 of 27/10/2004 on materials intended for contact with food.

## before using for the first time

- 1 Remove the plastic blade covers from the knife blade.  
**Take care the blades are very sharp.** These covers should be discarded as they are to protect the blade during manufacture and transit only.
- 2 Wash the parts see 'care & cleaning'

## key

### processor

- ① pusher
- ② feed tube
- ③ lid
- ④ safety interlock
- ⑤ bowl
- ⑥ food processor drive
- ⑦ speed/pulse control
- ⑧ power unit
- ⑨ liquidiser outlet/interlock
- ⑩ cord storage (at back)
- ⑪ liquidiser outlet cover

### liquidiser

- ⑫ goblet
- ⑬ lid
- ⑭ filler cap

## attachments

- ⑮ knife blade
- ⑯ slicing plate
- ⑰ shredding plate
- ⑱ plate carrier
- ⑲ whisk
- ⑳ maxi-blend canopy
- ㉑ citrus press (if supplied)

## to use your food processor

- 1 Fit the bowl onto the processor base - handle towards the back - lower and turn clockwise until it locks firmly into place ①.
- 2 Add an attachment over the food processor drive.
  - Always fit the bowl and attachment onto the processor before adding ingredients.
- 3 Fit the lid onto the bowl - feed tube towards the back of the appliance ②. Turn clockwise until the arrow on the lid aligns with the line on the power unit ③.
  - **Do not use the lid to operate the processor, always use the on/off control.**
- 4 Plug in, switch on and select a speed. (Refer to the recommended speed chart).
  - **The processor won't work if the bowl and lid are fitted incorrectly.**
  - Use the pulse (P) for short bursts. The pulse will operate for as long as the control is held in position.
- 5 Reverse the above procedure to remove the lid, attachments and bowl.
  - **Always switch off and unplug before removing the lid.**

## important

- Your processor is not suitable for crushing or grinding coffee beans, or converting granulated sugar to caster sugar.
- When adding almond essence or flavouring to mixtures avoid contact with the plastic as this may result in permanent marking.

## to use your liquidiser

- 1 Put your ingredients into the goblet.
- 2 Fit the filler cap to the lid.
- 3 Turn the lid in a clockwise direction to lock onto the goblet.
- 4 Lift off the liquidiser outlet cover ⑩.
- 5 Place the liquidiser onto the liquidiser outlet and turn to lock.
  - **important**
  - **The liquidiser attachment will work only with the processor bowl and lid in position.**

● **When using the liquidiser outlet we recommend that there are no tools in the bowl.**

6 Select a speed (refer to the recommended speed chart) or use the pulse control.

**hints**

- When making mayonnaise, put all the ingredients, except the oil, into the liquidiser. Remove the filler cap. Then, with the appliance running, add the oil slowly through the hole in the lid.
- Thick mixtures, e.g. pâtés and dips, may need scraping down. If the mixture is difficult to process, add more liquid.

- Ice crushing - operate the pulse in short bursts until crushed to the desired consistency.
- The processing of spices is not recommended as they may damage the plastic parts.
- The appliance will not work if the liquidiser is fitted incorrectly.
- To blend dry ingredients - cut into pieces, remove the filler cap, then with the appliance running, drop the pieces down one by one. Keep your hand over the opening. For best results empty regularly.
- Don't use the liquidiser as a storage container. Keep it empty before and after use.
- Never blend more than 1 litre (1½ pts) - less for frothy liquids like milkshakes.

## recommended speed chart

tool/attachment	function	speed	maximum capacities
knife blade	One stage cake mix	2	800g/1lb 2oz total weight
	Pastry - rubbing fat into flour	1 – 2	250g/9oz
	Adding water to combine pastry ingredients	2	
	Chopping/pureeing/pates	2	300g/10oz meat
	Yeasted mixes	2	340g/12oz flour weight
knife blade with maxi-blend canopy	Soups and milkshakes	1 – 2	800mls/1.3pt
whisk	egg whites	2	6
	cream	1	250mls/½pt
slicing plate/ shredding plate	Firm food items such as carrots, hard cheeses	2	–
	Softer items such as cucumbers, tomatoes	1	–
citrus press	Citrus fruits	1	–
liquidiser	All processing	2	1 litre/1½pt

## using the attachments

### knife blade

This blade is the most versatile of all the attachments. The texture you get is determined by the length of processing time. For coarser textures use the 'pulse' feature checking the consistency regularly.

**hints**

- Cut food such as meat, bread, vegetables into cubes approximately 2cm/3/4in before processing.
- Biscuits and bread should be broken into pieces and added down the feed tube whilst the appliance is running.
- When making pastry use fat straight from the fridge cut into 2cm/3/4in.cubes. Take care not to over-process.
- *Cake Making* - Sponge type cakes are best made by the 'all in one method'. A 'soft tub' margarine used straight from the refrigerator and cut into 2cm/3/4in cubes should always be used. Process until smooth.

- *Mayonnaise* - Place the egg and seasonings into the bowl and mix for a few seconds. With the machine running gradually add the oil down the feed tube in a slow steady stream.
- *Yeast dough*- Place the flour, fat and other dry ingredients into the bowl and process for a few seconds to mix. With the machine running add the liquid mixture down the feed tube and continue processing until the mixture forms a dough and becomes smooth in appearance and elastic to touch - this will take 45-60 seconds. Allow the dough to rise then re-knead for 10 seconds.

### whisk

Use for egg whites and cream only. The whisk is unsuitable for other recipes. Make sure the bowl and whisk are free from any traces of grease or egg yolk when whisking egg whites.

## slicing and shredding plates

### what the cutting plates can do.

*slicing plate* - slices carrots, potato, cabbage, cucumber, courgette, beetroot, onion.

*shredding plate* - grates cheese, carrot, potato and foods of a similar texture.

### to assemble the plate carrier

- 1 Select the desired plate and fit into the carrier with the cutting side uppermost.
- Locate one end of the plate under the rim and press the other end into position. It will only fit one way round **4**.

### using the cutting plates

#### *shredding plate*

Cut pieces of food to fit the feed tube. Fill the tube almost to the top and push down using the pusher with an even pressure whilst the machine is running. Longer shreds can be obtained by stacking pieces horizontally in the feed tube eg carrot.

#### *slicing plate*

If necessary cut food to fit the feed tube. Core foods such as apples and peppers. Pack the food in an upright position in the feed tube. The height should be slightly shorter than the feed tube. Using the pusher, push down with an even pressure whilst the machine is running.

### hints

- Use fresh ingredients.
- Don't cut food up too small. Fill the feed tube fairly full, this prevents food from slipping sideways during processing.
- When slicing or shredding: food placed upright comes out shorter than food placed horizontally.
- After using a cutting plate there will always be a small amount of waste on the plate or in the food.
- Do not allow food to build up to the underside of the plate - empty regularly.
- Push food down the feed tube using an even pressure.

## maxi blend canopy

When blending, use the maxi blend canopy in conjunction with the knife blade. It allows you to increase the liquid processing capacity of the bowl and improve the chopping performance of the blade.

- 1 Place the canopy into the bowl over the knife blade - **do not push down 5**.
- 2 Fit the lid **6**.

## citrus press (if supplied)

The citrus press is used to juice citrus fruit ie oranges, lemons, limes and grapefruits.

- 1 Fit the bowl onto the processor. Add the strainer and turn clockwise until the fin on the strainer aligns with the mark on the processor body **7**.
- 2 Attach the cone onto the drive shaft turning until it drops all the way down **8**.
- 3 Cut the fruit in half. Switch on and press the fruit onto the cone.

## care & cleaning

- Always switch off and unplug before cleaning.
- Handle blades and cutting plates with care - they are extremely sharp.
- Some foods may discolour the plastic. This is perfectly normal and won't harm the plastic or affect the flavour of your food. Rub with a cloth dipped in vegetable oil to remove the discolouration.

### power unit

- Wipe with a damp cloth, then dry. Ensure that the interlock area is clear of food debris.
- Don't immerse the power unit in water.
- Wrap excess cord around the bracket at the back of the appliance.

### liquidiser

- 1 Fill with warm water, fit the lid and filler cap, then switch on for 20-30 seconds.
- 2 Empty, then rinse. If it's still dirty, use a brush.
- 3 Wipe, then leave to air-dry.

- **Do not immerse the liquidiser base in water.**

### all other parts

- Wash by hand, then dry.
- All attachments (**except the liquidiser**) can be washed on the top rack of your dishwasher. A short low temperature programme is recommended.



## service & customer care

- If the cord is damaged it must, for safety reasons, be replaced by KENWOOD or an authorised KENWOOD repairer.

### UK

If you need help with:

- using your appliance or
  - servicing, spare parts or repairs (in or out of guarantee)
- ☎ call Kenwood customer care on 023 9239 2333. **Have your model number (e.g. FP190) and date code (5 digit code e.g. 13L35) ready.** They are on the underside of the power unit.

### ● spares and attachments

☎ call 0844 557 3653.

### ● other countries

Contact the shop where you purchased your appliance.

- Designed and engineered by Kenwood in the UK.
- Made in China.



## IMPORTANT INFORMATION FOR CORRECT DISPOSAL OF THE PRODUCT IN ACCORDANCE WITH EC DIRECTIVE 2002/96/EC.

At the end of its working life, the product must not be disposed of as urban waste.

It must be taken to a special local authority differentiated waste collection centre or to a dealer providing this service.

Disposing of a household appliance separately avoids possible negative consequences for the environment and health deriving from inappropriate disposal and enables the constituent materials to be recovered to obtain significant savings in energy and resources. As a reminder of the need to dispose of household appliances separately, the product is marked with a crossed-out wheeled dustbin.

### guarantee UK only

If your food processor goes wrong within one year from the date you bought it, we will repair it (or replace it if necessary) free of charge provided:

- it has been used in accordance with these instructions.
- you have not misused, neglected, or damaged it;
- it has not been modified (unless by KENWOOD);
- it is not second hand;
- it has not been used commercially;
- you have not fitted a plug incorrectly; and
- **you supply your receipt to show when you bought it.**

This guarantee does not affect your statutory rights.

## white bread

300g/10oz strong white plain flour  
5ml/1tsp salt  
6g/½oz lard  
15g/½oz fresh yeast or 10ml/2tsp dried active yeast  
plus 5ml/1tsp sugar  
175ml/6fl.oz warm water

### **dried active yeast**

Sprinkle the dried yeast into the warm water, add the sugar and allow to stand for approximately 10 minutes or until the mixture is frothy.

### **fresh yeast**

Crumble into the bowl with the flour.

### **other types of yeast**

Follow the manufacturers instructions.

With the knife blade in the bowl, add the flour, salt, lard (fresh yeast if used) and process for a few seconds to evenly distribute the ingredients throughout the flour. With the machine operating, quickly pour the water or yeast liquid in a steady stream through the feed tube (this should take about 10 seconds). Continue processing until the mixture forms a dough and becomes smooth in appearance and elastic to the touch, this will take about 45 seconds. Remove the dough into either a greased polythene bag or a lightly floured bowl and cover. Leave this dough in a warm place until doubled in size. Return the risen dough to the processor bowl fitted with the knife blade and re-knead for about 10 seconds. Shape the dough into a loaf or about 15 rolls and place on greased baking trays and leave until double in size. Bake at 230°C/450°F/gas mark 8 for 20-25 minutes for a loaf or 10-15 minutes for bread rolls. When the loaf or rolls are cooked they should sound hollow when tapped on the base.

## carrot and coriander soup

25g (1oz) butter  
1 onion chopped  
1 clove garlic crushed  
400g (14oz) carrot cut into  
1½ cm cubes  
cold chicken stock  
10-15ml (2-3tsp) ground coriander  
salt and pepper

- 1 Melt the butter in a pan, add the onion and garlic and fry until soft.
- 2 Place the carrot into the liquidiser, add the onion and garlic. Add sufficient stock to reach the 1L level marked on the goblet. Fit the lid and filler cap.
- 3 Blend on maximum speed for 5 seconds for a coarse soup or longer for a finer result.
- 4 Transfer the mixture to a saucepan, add the coriander and seasoning and simmer the soup for 30 to 35 minutes or until cooked.
- 5 Adjust the seasoning as necessary and add extra liquid if required.





HEAD OFFICE: Kenwood Limited, 1-3 Kenwood Business Park, New Lane, Havant, Hampshire PO9 2NH

[kenwoodworld.com](http://kenwoodworld.com)

**KENWOOD**

CREATE MORE

## Free Manuals Download Website

<http://myh66.com>

<http://usermanuals.us>

<http://www.somanuals.com>

<http://www.4manuals.cc>

<http://www.manual-lib.com>

<http://www.404manual.com>

<http://www.luxmanual.com>

<http://aubethermostatmanual.com>

Golf course search by state

<http://golfingnear.com>

Email search by domain

<http://emailbydomain.com>

Auto manuals search

<http://auto.somanuals.com>

TV manuals search

<http://tv.somanuals.com>