

# KENWOOD

## 31 Litre Stainless Steel Microwave with Grill K31GSS10

instruction manual

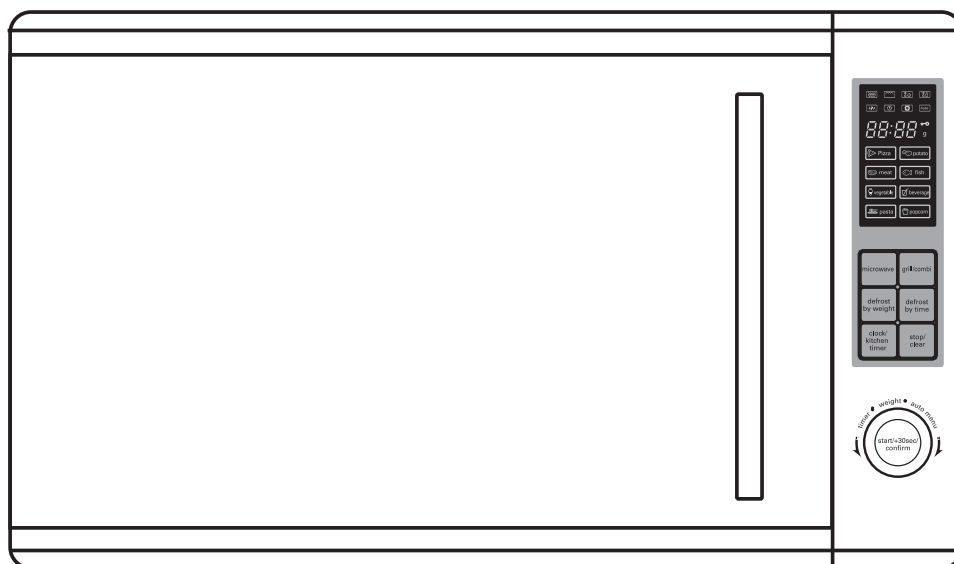



# contents

<b>unpacking</b> .....	<b>4</b>
<b>getting ready</b> .....	<b>5</b>
<b>introducing microwave cooking</b> .....	<b>6</b>
cooking with a microwave.....	6
checking your cooking utensils .....	7
using aluminium foil in your microwave .....	7
microwave heating categories .....	8
steam .....	9
condensation .....	9
<b>product overview</b> .....	<b>10</b>
the main unit .....	10
the control panel .....	10
<b>checking your microwave</b> .....	<b>11</b>
<b>clock setting</b> .....	<b>12</b>
<b>kitchen timer</b> .....	<b>13</b>
<b>setting the child lock</b> .....	<b>14</b>
<b>microwave cooking</b> .....	<b>15</b>
<b>grill or combination cooking</b> .....	<b>16</b>
<b>two-stage cooking</b> .....	<b>18</b>
<b>auto cooking</b> .....	<b>19</b>
auto menu .....	19
auto menu table .....	20
<b>defrosting</b> .....	<b>21</b>
defrost by weight.....	21
defrost by time .....	21
<b>quick start cooking</b> .....	<b>22</b>
<b>querying the cooking function</b> .....	<b>23</b>
to find out the current cooking setting .....	23
<b>cleaning your microwave</b> .....	<b>24</b>
<b>frequently asked questions</b> .....	<b>25</b>
<b>specification</b> .....	<b>26</b>
<b>safety warnings</b> .....	<b>27</b>

**Thank you** for purchasing your new Kenwood Microwave with Grill.

These operating instructions will help you use it properly and safely.

We recommend that you spend some time reading this instruction manual in order that you fully understand all the operational features it offers.

Read all the safety instructions carefully before use and keep this instruction manual for future reference.

## unpacking

Remove all packaging from the unit. Retain the packaging. If you dispose of it please do so according to local regulations.

The following items are included:

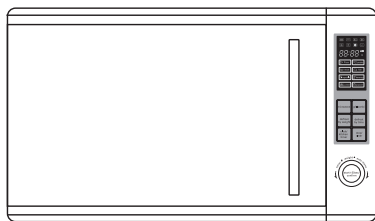

The Main Unit

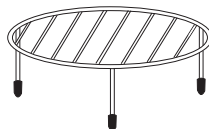

Grill Rack x 1  
P.N.: 256511700002

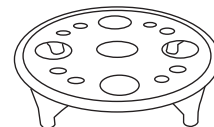

Defrost Rack x 1  
P.N.: 250900200006

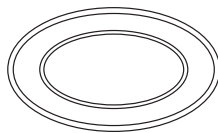

Glass Turntable Plate x 1  
P.N.: 252100500498

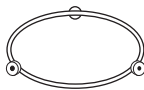

Turntable Support x 1  
P.N.: 252200200008



Instruction Manual x 1  
P.N.: 261800307398



If items are missing, or damaged please contact Partmaster (UK only).  
Tel: 0844 800 3456 for assistance.

# getting ready

This microwave is designed for domestic use. It should not be used for commercial catering.

1. After unpacking your microwave, check that it has not been damaged whilst in the box. Make sure there are no dents on the microwave, and the door closes properly. A dented or damaged microwave could allow microwave energy to escape. Make sure that you have taken all the packaging from inside the microwave. Please dispose of the plastic wrappings or bags safely and keep out of the reach of babies and young children.

2. Choose a flat work surface for your microwave away from heat sources such as radiators or fires and away from cold areas.  
You should allow a 10cm space all around the microwave and 30cm above so that warm air can escape from the vents during cooking – This microwave is not designed to be built in.

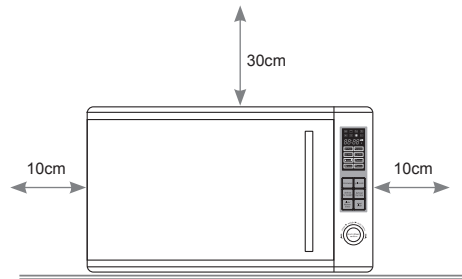

3. Plug your microwave into a standard household electrical socket. Avoid using a socket that also has an adaptor and other equipment plugged in. Do not use a multi-adaptor.

4. Put the turntable support inside the microwave and place the glass turntable plate on top of the support. The turntable support is shaped to sit securely on the spindle. You must always use the turntable plate and support whenever you use the microwave.

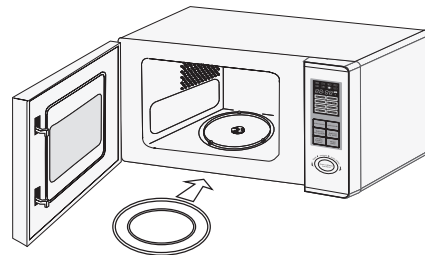

5. To protect your work surface, we recommend that you fix some non-slip cushion pads (not included) to the underside of the microwave.



Remove the turntable plate and turntable support before turning the microwave upside down.

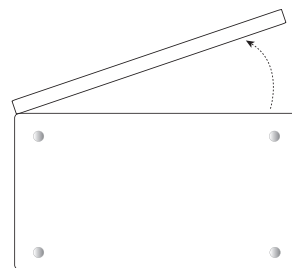

Underside View

# introducing microwave cooking

Always remember the basic safeguards you would follow when using any cooking equipment or handling hot food.

See below for basic guidelines in microwave cooking.

If you are unfamiliar with using a microwave, refer to the back of this instruction booklet for more information.

## cooking with a microwave

- Cooking with a microwave is much faster than conventional cooking and, whilst you should make sure that food is fully cooked, you should be careful not to overcook it.
- Microwave energy can heat unevenly so stirring to distribute heat is very important. Always stir from the outside, inwards.
- If you are cooking a number of individual foods at the same time, such as baked potatoes or small cakes, arrange them evenly on the turntable plate so that they cook evenly. Never stack food in your microwave.
- Turn larger foods such as meat roasts and poultry during cooking so that the top and bottom cook evenly. It is also recommended to turn pieces of meat or poultry, especially if they have not been deboned.
- Meat and poultry which is cooked for 15 minutes or more will brown lightly in it's own fat. Anything cooked for a shorter time can be brushed with a browning sauce to give an appetising colour.
- Strips of aluminium foil can be used to cover the thinner pieces of food to stop them overcooking before the thicker parts of the food have had a chance to cook. Use the aluminium foil sparingly and wrap around the food or container carefully to stop it touching the inside of the microwave which could cause sparks.
- Microwaves cook food using microwave energy that is similar to naturally occurring radio waves. Normally, these "waves" would fade as they disappeared into the atmosphere but in a microwave they are concentrated onto food causing it to heat up.
- Microwave energy can not pass through metal – so it can not escape from inside your microwave – but it can pass through materials like glass, porcelain, plastic, and paper. These are the things used to make microwave-safe cooking equipment.
- Microwave-safe cooking equipment will still get hot as the food it contains heats up.
- The microwave energy focuses on the moisture in the food causing lots of tiny vibrations. The vibrations get so great that the moisture, and the food heat up.

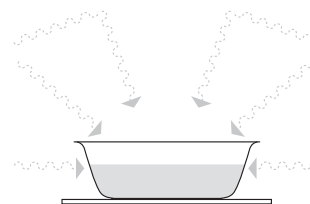

## checking your cooking utensils

Most heat-resistant, non-metallic cooking utensils are safe to use in your microwave. If you are not sure if you can use a utensil in your microwave, follow this simple test:

1. Put the utensil into the microwave next to a cup of water – use a cup that you know is microwave safe. Close the door.
2. Turn the microwave on for 30 seconds only.
3. After 30 seconds, carefully check to see if the water has warmed up. If the water has not warmed up but the utensil has, the utensil is not microwave-safe and should not be used in the microwave.
4. Do not use your hands to touch the utensil as it may already be hot.



- Never use equipment made of metal, except aluminium foil in your microwave.
  - The microwave energy can not pass through the metal so it bounces off and sparks against the inside of the microwave.
  - Stop the microwave straight away if any equipment does cause sparks.
  - Remember that some crockery has a metal trim around the edge. Even this trim can cause sparks.
  - Never use scratched, cracked or damaged glass in a microwave. Damaged glass can explode.
  - Your microwave comes with a microwave safe grill rack. If you want to use another grill rack, please carry out this test to ensure that it is microwave safe.
- 

## using aluminium foil in your microwave

It is safe to use aluminium foil in your microwave as long as you follow these safety guidelines.

As with all metals, microwave energy cannot pass through aluminium foil, but provided you keep the aluminium foil away from the side of the microwave it will not cause sparks and there will not be any damage to your microwave.

Using aluminium foil is a good way of shielding parts of food that you do not want to cook as quickly as others – perhaps where the food is narrower and would otherwise overcook.

Place the aluminium foil over the area you want to shield, taking care that the aluminium foil will not touch the sides of the microwave when the turntable plate rotates. Only use one piece of aluminium foil at a time so that you do not get sparks between the separate pieces.

Follow these guidelines when using aluminium foil in your microwave:

- Remove aluminium foil lids from containers before using in the microwave. Some lids are made of card with a aluminium foil covering – these should be removed too. Use a microwave safe transparent lid if possible.
- Stir food during cooking if the container has a lid or film cover.
- Always use the glass turntable plate.
- Use shallow containers with a large surface area. Do not use containers that are more than 1.25in (3.5cm) deep.
- Use gloves when handling hot aluminium foil containers.
- Do not completely cover food with aluminium foil. The microwave energy cannot pass through the aluminium foil so the food will not cook.
- Do not let aluminium foil touch the inside of the microwave.
- Do not use more than one piece of aluminium foil in the microwave at the same time.

## microwave heating categories

Your microwave has been tested and labelled to meet the government's voluntary agreement on the reheating of pre-cooked food.

The heating characteristics and output power levels of microwaves are usually calculated using a relatively large portion of food (a 1000 gram load, IEC 705) but many packs of pre-cooked food are sold in smaller packs, often about 350 grams.

The government, in partnership with food companies and microwave manufacturers, have set up a system of heating categories to help you choose the reheating time for pre-cooked food.

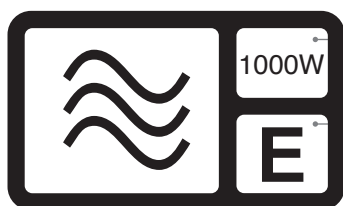

1000W is the output power of the microwave.

E is the heating category for your microwave. Check the cooking times for category E on the food's packaging to see how long it should be cooked for. Please see the below example for reference.

### to microwave:

1. Remove outer packaging.
2. Pierce film lid SEVERAL TIMES.
3. Place on a microwaveable plate.
4. Heat on full power.
5. Stir or turn halfway through heating.

	Heating Category		Wattage (IEC705)	
	B	D	650W	750W
Full power (in minutes)	2	2	2	2
Stir / Turn	Stir / Turn		Stir / Turn	
Full power (in minutes)	2	1.5	2	1.5
Standing time (in minutes)	1	1	1	1

### to microwave from frozen:

1. Remove outer packaging.
2. Pierce film lid SEVERAL TIMES.
3. Place on a microwaveable plate.
4. Heat on full power.
5. Stir or turn halfway through heating.

	Heating Category		Wattage (IEC705)	
	B	D	650W	750W
Full power (in minutes)	3	2.5	3	2.5
Stir / Turn	Stir / Turn		Stir / Turn	
Full power (in minutes)	4	3.5	4	3.5
Standing time (in minutes)	1	1	1	1



## steam

When you microwave food, steam is created as water in the food heats up and evaporates.

The steam formed during microwave cooking is entirely safe. It has to escape from the microwave to prevent pressure from building up inside the microwave. It does this through the vents on the back of the microwave and from around the door.

## condensation

As the steam cools, you may find that condensation gathers in small pools inside your microwave and on the work surface beneath the door and vents. Always dry the microwave after cooking foods with a high moisture content.

Your microwave is designed to let steam escape from the vents and around the door without microwave energy escaping. There is no danger of microwave energy escaping with the steam.

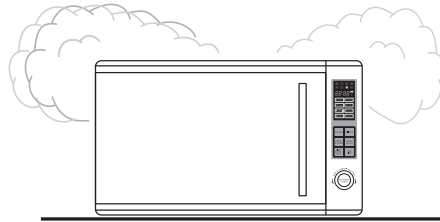

# product overview

## the main unit

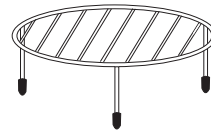
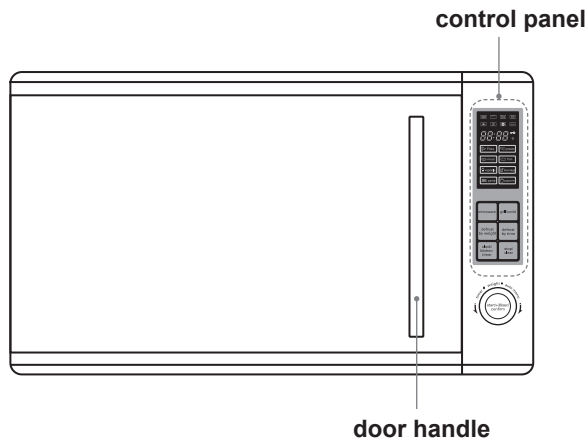

**grill rack**  
For use when grilling.

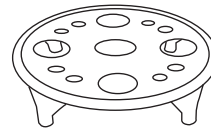

**defrost rack**  
For use when defrosting.

## the control panel

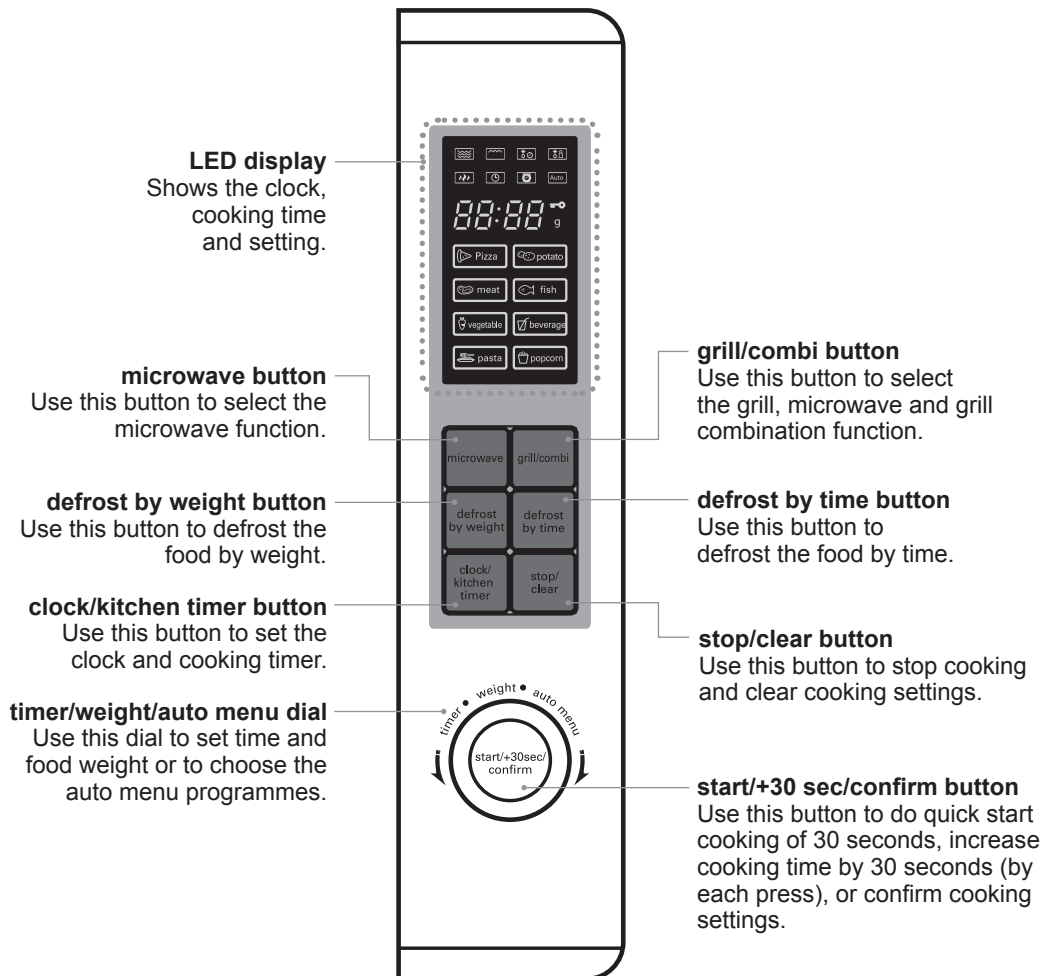

# checking your microwave

Check your microwave after unpacking.



For your safety, the microwave stops if the door is opened during cooking. Close the door and press the **start/+30sec/confirm** button to continue the cooking cycle.

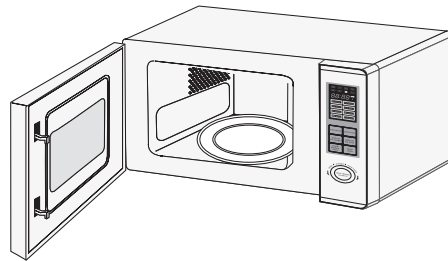

1. Pull the handle to open the door.
2. Place a cup of water on the glass turntable plate. Make sure the cup is microwave safe (it should not have any decorative metal trim).
3. Close the door.
4. Press the **stop/clear** button to clear any settings that have already been made
5. Press the **start/+30sec/confirm** button once to start a simple 30-second microwave cooking cycle and that allows you to check the operation of the microwave.
6. When the cooking cycle has finished, the water should be hot (be careful when you take the cup out of the microwave). Press the **stop/clear** button to clear any settings.

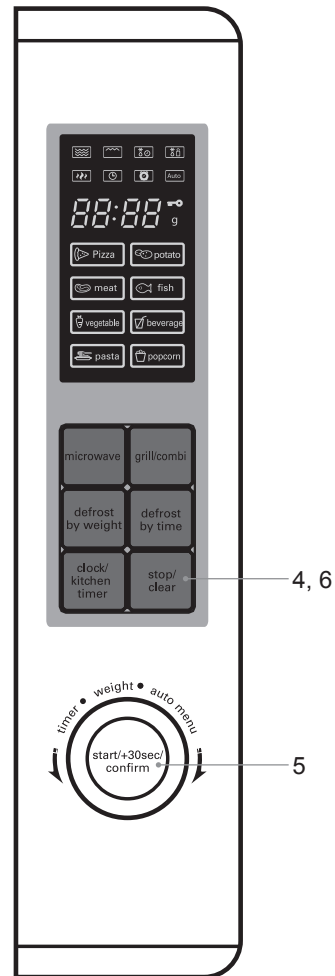

# clock setting

When the microwave is connected to the mains power, the LED display will show “0:00”, and the microwave will sound once. Please ensure that you have set the clock prior to use.

Please follow the steps below to set the clock.

1. Press the **clock/kitchen timer** button. The hour digits will flash and the clock indicator will illuminate.
2. Turn the **timer/weight/auto menu** dial to adjust the hour digits. The input time has to be within 0-23.
3. Press the **clock/kitchen timer** button and the minute digits will flash.
4. Turn the **timer/weight/auto menu** dial to adjust the minute digits, the input time has to be within 0-59.
5. Press the **clock/kitchen timer** button again to complete the clock setting.  
“:” will start flashing and the time will illuminate.



- In the process of clock setting, if the **stop/clear** button is pressed or if there is no operation within 1 minute, the microwave will go back to the previous status automatically.
- If the clock needs to be reset, please repeat steps 1 to 5.
- To find out the current time while the microwave is operating, press the **clock/kitchen timer** button. It will last for 2-3 seconds and then return to its original display.

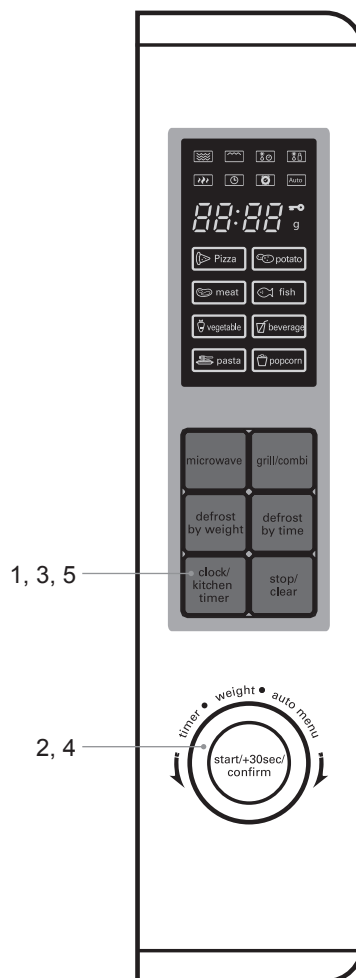

# kitchen timer

While the microwave is operating or not in use, this feature allows you to use the microwave as a timer. Please make sure the clock has been set.

For setting the **kitchen timer**, follow the steps below.

1. Press the **clock/kitchen timer** button twice. The LED display will show “00:00” and the timer indicator will illuminate.
2. Turn the **timer/weight/auto menu** dial to select the timer time.
3. Press **start/+30 sec/confirm** button to confirm the setting, the timer indicator will flash and the timer will start counting down.
4. Once the elapsed time is reached, the timer indicator will disappear from the LED display. The microwave will sound 5 times and return to its original state.
5. Press the **stop/clear** button to cancel the setting.



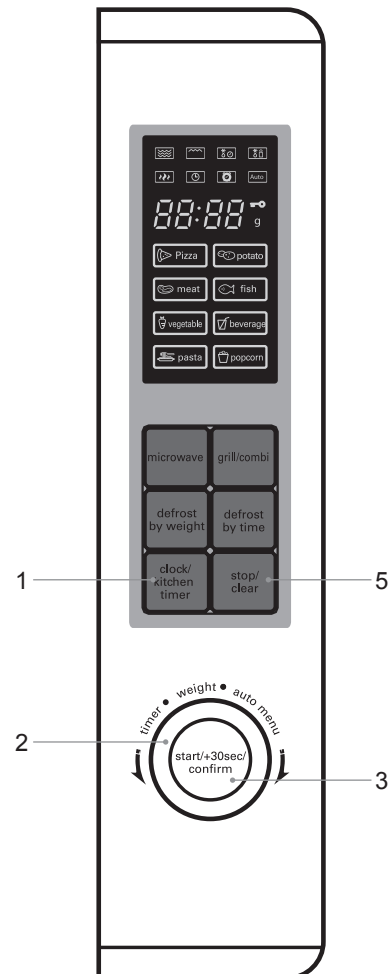

During kitchen timer, programmes cannot be set.



## setting the child lock

This feature prevents the electronic operation of the microwave by locking the operation of the control panel until you have cancelled it.

Please follow the steps below to set the child lock.

1. Press the **stop/clear** button for 3 seconds and a long tone will sound. The child lock indicator  will illuminate on the LED display to indicate that the microwave has set the child lock.
2. To release the child lock, press the **stop/clear** button again for 3 seconds and a long tone will sound. The child lock indicator  will disappear from the LED display to indicate that the microwave has released the child lock.

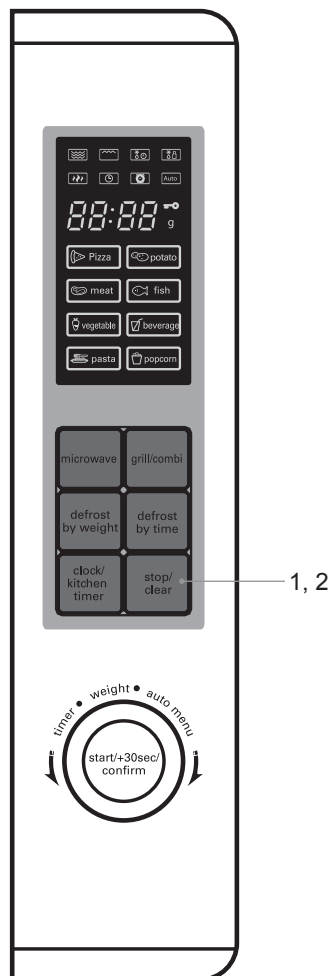

# microwave cooking

For simple **microwave cooking**, follow the steps below.

For instance: If you want to use 80% microwave power to cook for 20 minutes.

1. Press the **microwave** button once and the LED display will show “**P100**”. Press the **microwave** button repeatedly until the LED display shows “**P80**”.



Alternatively, after you press the **microwave** button once, you can turn the **timer/weight/auto menu** dial to change the power level.

2. Press the **start/+30 sec/confirm** button to confirm the microwave power level.
3. Turn the **timer/weight/auto menu** dial to adjust the cooking time until the LED display shows “**20:00**”.
4. Press the **start/+30 sec/confirm** button to confirm and start cooking.
5. Press the **stop/clear** button once to stop the cooking. Press the **stop/clear** button again to cancel the setting.

Microwave Button Control		
Order	LED Display	Microwave Power
1	P100	100%
2	P80	80%
3	P50	50%
4	P30	30%
5	P10	10%



- When removing food from the microwave, please ensure that the microwave has stopped.
- Operating the microwave without food in it can result in overheating and damage the magnetron.

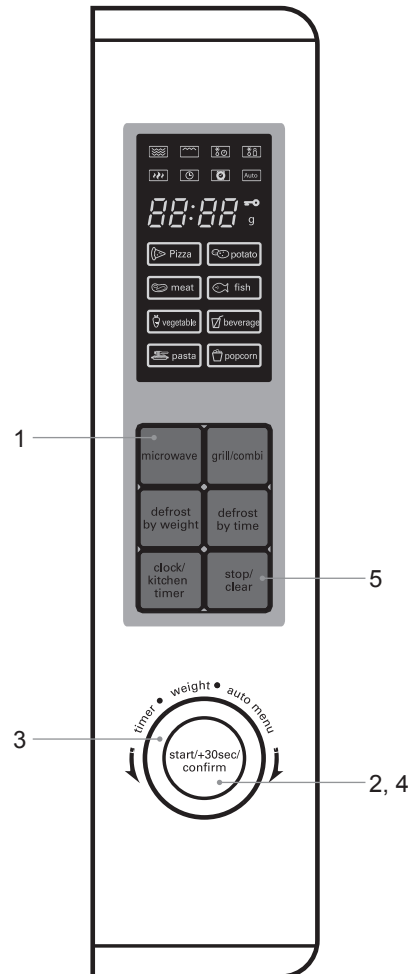

# grill or combination cooking



- During first time use of grill cooking, operate the microwave empty for at least for 20 minutes. Some smoke and/or odour may occur. This is normal and will stop.
- We recommend that you use the supplied grill rack. Place your food on the grill rack then place on top of the glass turntable plate.

For **grilling**, follow the steps below.

1. Press the **grill/combi** button once and the LED display will show “G”.
2. Press the **start/+30 sec/confirm** button to confirm the grill cooking setting.
3. Turn the **timer/weight/auto menu** dial to adjust the cooking time.
4. Press the **start/+30 sec/confirm** button to confirm and start cooking.
5. Press the **stop/clear** button once to stop the cooking. Press the **stop/clear** button again to cancel the setting.

For **combination cooking (microwave and grill)**, follow the steps below.

1. Press the **grill/combi** button repeatedly until the LED display shows “C-1” or “C-2”.



Alternatively, after you press the **grill/combi** button once, you can turn the **timer/weight/auto menu** dial until the LED display shows “C-1” or “C-2”.

2. Press the **start/+30 sec/confirm** button to confirm the cooking setting.
3. Turn the **timer/weight/auto menu** dial to adjust the cooking time.
4. Press the **start/+30 sec/confirm** button to confirm and start cooking.
5. Press the **stop/clear** button once to stop the cooking. Press the **stop/clear** button again to cancel the setting.

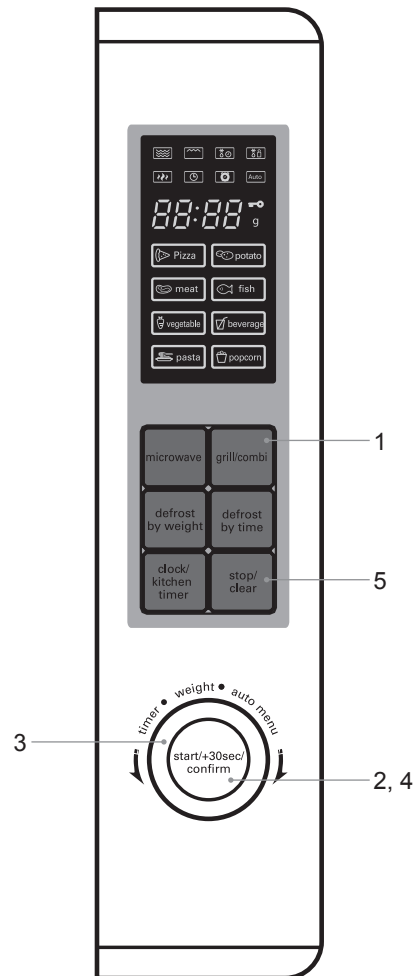



Grill/Combination Button Control (For Grill and Combination Cooking)			
Order	LED Display	Microwave Power	Grill Power
1	G	0%	100%
2	C-1	55%	45%
3	C-2	36%	64%

Please note there are only 2 modes of combination cooking and their microwave and grill powers are shown on the table above.

For instance: If you want to do 55% microwave power and 45% grill power cooking (**C-1**) for 10 minutes, please follow the steps below.

1. Press the **grill/combi** button repeatedly until the LED display shows "**C-1**".



Alternatively, after you press the **grill/combi** button once, you can turn the **timer/weight/auto menu** dial until the LED display shows "**C-1**".

2. Press the **start/+30 sec/confirm** button to confirm the cooking setting.
3. Turn the **timer/weight/auto menu** dial to adjust the cooking time until the LED display shows "**10:00**".
4. Press the **start/+30 sec/confirm** button to confirm and start cooking.
5. Press the **stop/clear** button once to stop the cooking. Press the **stop/clear** button again to cancel the setting.



In order to obtain better grilling performance for your food, please turn your food over periodically. Press the **stop/clear** button once to stop cooking and open the door. Then, turn your food over and close the door. Press the **start/+30 sec/confirm** button to continue cooking.



Do not use plastic microwave containers or covers when using grill or combination cooking.

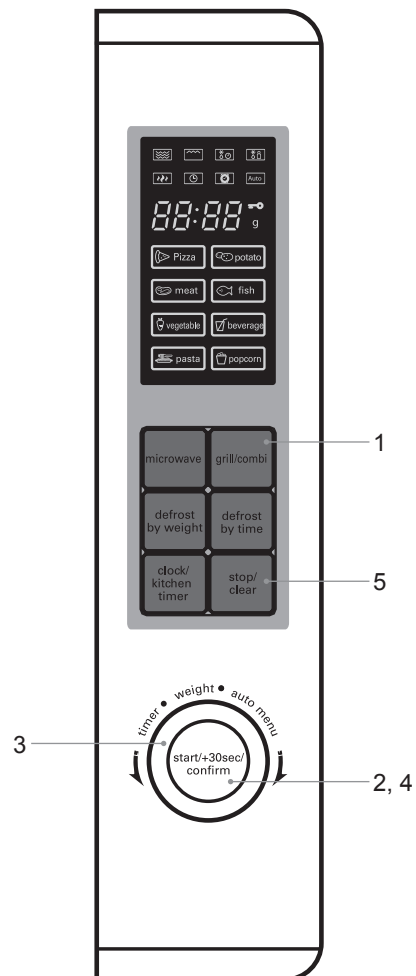

## two-stage cooking

For **two-stage cooking**, please follow the steps below.

For instance: If you want to defrost your food for 5 minutes and then to cook it with 80% microwave power for 7 minutes.

- 

You can set a maximum of 2 stages for two-stage cooking. If defrosting is among one of the stages, then it will be set as the first stage. Auto cooking and quick start cooking are not available in two-stage cooking.

1. Press the **defrost by time** button to initiate the two-stage cooking with defrost as the first stage. The LED display will show **"dEF2"**.

2. Turn the **timer/weight/auto menu** dial to adjust the defrosting time until the LED display shows **"5:00"**.

- 

Do not press the **start/+30sec/confirm** button at this stage.

3. Press the **microwave** button twice to select the 80% microwave power, and the LED display will show **"P80"**.

- 

Alternatively, after you press the **microwave** button once, you can turn the **timer/weight/auto menu** dial to change the power level.

4. Press the **start/+30 sec/confirm** button to confirm the microwave power level.

5. Turn the **timer/weight/auto menu** dial to adjust the cooking time until the LED display shows **"7:00"**.

6. Press the **start/+30 sec/confirm** button to confirm and start cooking. The microwave will sound once to indicate that it has started the defrosting count down. The microwave will sound again as it starts the microwave cooking (the second stage). Upon completion the microwave will sound five times.

7. Press the **stop/clear** button once to stop the cooking. Press the **stop/clear** button again to cancel the setting.

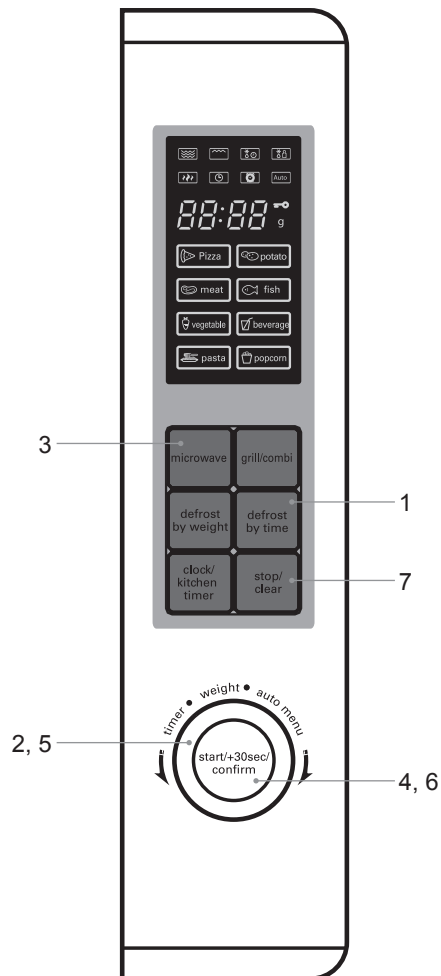

Do not use plastic microwave containers or covers when using grill or combination cooking.

# auto cooking

This feature allows you to cook most of your food based on the food category and the weight. Select the category and choose the weight of your food. For quick reference of the cooking time and the weight, please refer to the **auto menu** table.

## auto menu

1. Turn the **timer/weight/auto menu** dial clockwise to select the auto menu programme required. The LED display will show "**A-1**" to "**A-8**".
2. Press the **start/+30 sec/confirm** button to confirm.
3. Turn the **timer/weight/auto menu** dial to select the weight option for your chosen programme. Please refer to the auto menu table for information.
4. Press the **start/+30 sec/confirm** button to confirm and start cooking.
5. Press the **stop/clear** button once to stop the cooking. Press the **stop/clear** button again to cancel the setting.

For instance: If you want to cook 350g of fish using auto menu programme. Please follow the steps below.

1. Turn the **timer/weight/auto menu** dial clockwise to select the auto menu programme for fish. The LED display will show "**A-6**".
2. Press the **start/+30 sec/confirm** button to confirm.
3. Turn the **timer/weight/auto menu** dial to select the weight of your fish until the LED display shows "**350**".
4. Press the **start/+30 sec/confirm** button to confirm and start cooking.

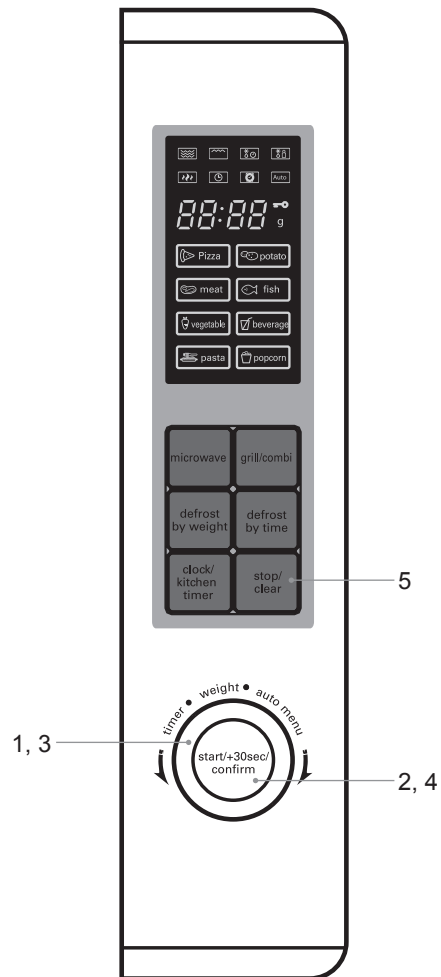



The density and thickness of food can affect its cooking time. Ensure all food is piping hot and cooked thoroughly before serving. It is essential that food is checked during and after the recommended cooking time, even if auto menu was used.

## auto menu table

Menu	Weight	Display	Cooking Time	Comments	
A-1 pizza	200g	200	1'20"	This setting is designed for re-heating cooked pizza slices (not frozen pizza).	
	400g	400	2'30"		
A-2 meat	250g	250	3'00"	Make sure food is cooked thoroughly before consuming. Additional cooking time may be required for thicker pieces of meat.	
	350g	350	4'00"		
	450g	450	5'00"		
A-3 vegetable	200g	200	2'40"	Only use suitable microwavable containers and cling film in the microwave. Ensure to check the cooking regularly to make sure the water does not boil over.	
	300g	300	3'40"		
	400g	400	4'40"		
A-4 pasta	50g	50	18'00"	50g of Pasta + 450ml of Cold Water	Only use suitable microwavable containers and cling film in the microwave. Ensure to check the cooking regularly to make sure the water does not boil over.
	100g	100	22'00"	100g of Pasta + 800ml of Cold Water	
A-5 potatoes	200g	200	4'30"	For best results, pierce the potatoes' skin before cooking. Once the potatoes are cooked, wrap them in aluminium foil for at least 5 minutes to ensure they are cooked thoroughly.	
	400g	400	8'00"		
	600g	600	11'00"		
A-6 fish	250g	250	4'00"	Make sure food is cooked thoroughly before consuming. Additional cooking time may be required for thicker pieces of fish.	
	350g	350	5'30"		
	450g	450	7'00"		
A-7 beverage	120ml	1	0'50"	Only use suitable microwavable containers and cling film in the microwave. Pierce the film with a fork before cooking.	
	240ml	2	1'40"		
	360ml	3	2'40"		
A-8 popcorn	50g	50	1'20"	For best results, we recommend using ready mix packed popcorn. Cover it with microwavable lid.	
	85g	85	2'10"		
	100g	100	2'10"		

# defrosting

This feature allows you to defrost your frozen foods simply by entering the weight or time.



We recommend that you use the supplied defrost rack. Place your frozen food on the defrost rack then place on top of the glass turntable plate.

## defrost by weight

1. Press the **defrost by weight** button and the LED display will show “**dEF1**”.
2. Turn the **timer/weight/auto menu** dial to adjust the weight of your food.
3. Press the **start/+30 sec/confirm** button to start defrosting.
4. Press the **stop/clear** button once to stop the defrosting. Press the **stop/clear** button again to cancel the setting.

## defrost by time

1. Press the **defrost by time** button and the LED display will show “**dEF2**”.
2. Turn the **timer/weight/auto menu** dial to set the defrosting leadtime.
3. Press the **start/+30 sec/confirm** button to start defrosting.
4. Press the **stop/clear** button once to stop the defrosting. Press the **stop/clear** button again to cancel the setting.

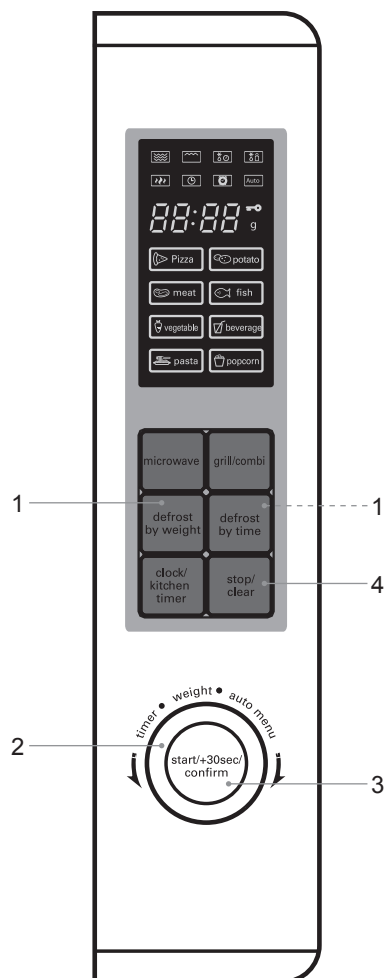

- Large items may be frozen in the centre. To ensure even thawing, turn them over from time to time and break them into smaller pieces during defrosting.
- You will need to press the **stop/clear** button once to hold the defrosting programme and open the door. After you rotate the food, you need to press the **start/+30 sec/confirm** button to restart defrosting.
- Place roasts fat-side down or whole poultry breast-side down.
- Drain liquids during defrosting as the juices from food can get hot and cook the food.

# quick start cooking

This feature allows you to quickly cook your food for 30 seconds with 100% microwave power. Please follow the steps below.

1. Press the **start/+30 sec/confirm** button to start the quick start cooking. Press the **start/+30 sec/confirm** button again to add another 30 seconds. You may increase the cooking time up to 95 minutes.



Alternatively, turn the **timer/weight/ auto menu** dial anti-clockwise to set cooking time with 100% microwave power first. Then, press the **start/+30sec/confirm** button to start cooking.

2. Press the **stop/clear** button to stop cooking. Press the **stop/clear** button again to cancel the setting.



This feature is also applicable during microwave cooking and time defrosting.

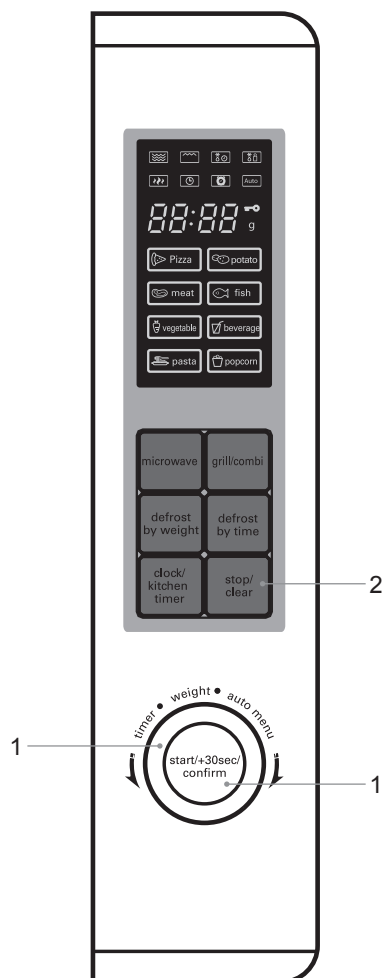

# querying the cooking function

This feature allows you to check and view the current cooking settings.

## to find out the current cooking setting

1. Press the **microwave** button or **grill/ combi.** button once and the LED display will show the current cooking setting while the microwave is in either microwave, grill or combination cooking. It will last for 3 seconds and then return to its original display.

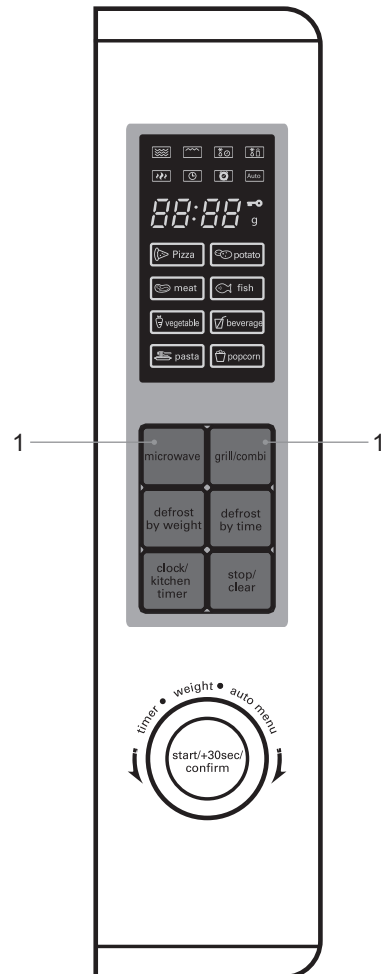

# cleaning your microwave

Cleaning your microwave each time you use it will help to prevent a build up of stubborn marks that can be difficult to clean.

Unplug your microwave from the mains and wait for it to completely cool down before cleaning.

On the right hand side wall of the cavity is the wave guide cover. Microwaves are passed through this to enable your food to cook. It is important that this wave guide cover is kept clean at all times.

Wipe it with mild detergent and water and leave to dry.

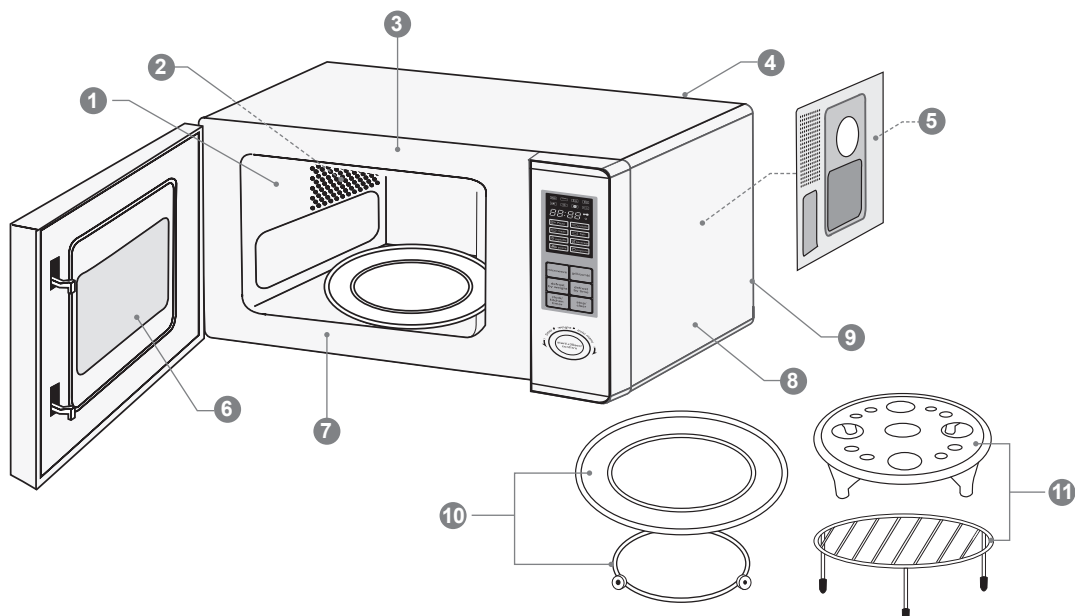

- 1 The microwave walls have a special enamel coating which makes cleaning very easy. Use a soft damp cloth to wipe off any splashes or a paper towel to mop up any spills. Wipe off grease with a damp cloth and a little detergent. Dry thoroughly. If grease is left to accumulate, it can smoke and even catch fire.
  - 2 Make sure you keep the outlet grids clean.
  - 3 Keep the front of the microwave clean so that the door can close properly.
  - 4 Be careful not to spill water into the vents.
  - 5 Do not remove the wave guide cover: It is important to keep the cover clean in the same manner as the inside of the microwave. If grease is left to accumulate, it can smoke and even catch fire.
  - 6 Keep the inside of the door clean with a damp cloth. Use warm soapy water for stubborn marks and dry thoroughly. The inside of the door has a special coating and must not be cleaned with abrasive pads or cleaning powders.
  - 7 Clean behind the door ledge.
  - 8 Use warm soapy water to clean the outside of the microwave. Do not use abrasive pads or powders that could scratch the surface.
  - 9 Unplug the microwave before cleaning the power lead and the microwave. Wipe with a damp cloth and leave to dry before plugging it back in.
  - 10 Treat the turntable plate as you would any glass plate. After you have used it for more than 15 minutes, allow it to cool down before you use it again. Do not wash the turntable plate in very hot water, this could crack it. Wash the turntable support in warm water. Do not use very hot water which could make it warp. Make sure the glass turntable plate and turntable support are dry before you put them back in the microwave.
  - 11 Wash the racks in warm water. Do not use very hot water which could make them warp.
-  Do not remove any fixed parts from the inside of your microwave during cleaning or at any other time.



## frequently asked questions

If a problem does occur, it may often be due to something very minor. The following Q & A may be able to resolve the problem.

Questions	Answers
Why doesn't the food seem to cook?	Check that: <ul style="list-style-type: none"> <li>• the cooking time has been set</li> <li>• the door is closed</li> <li>• the mains socket is not overloaded causing the fuse to blow.</li> </ul>
Why does the food seem undercooked or overcooked?	Check that: <ul style="list-style-type: none"> <li>• the correct cooking time has been set</li> <li>• the correct power setting has been used.</li> </ul>
How can I stop eggs from popping?	When you bake or poach eggs in the microwave, the yolk can sometimes pop as steam builds up inside it. You can stop the egg from popping by piercing the yolk with a toothpick before cooking. Never cook eggs that are still in their shells.
Why is it so important that I allow standing time after cooking?	With microwave cooking, many foods build up enough heat inside them to continue cooking even after they've been taken out of the microwave. Because microwave cooking works from the outside of food inwards, standing time lets you cook the centre of the food without the outside being overcooked.
Why does my microwave sometimes take longer to cook than it says in the recipe?	First check that the microwave was set just as the recipe said. Cooking times and heat settings are suggestions to help prevent overcooking but differences in the weight, size, shape and starting temperature of food will all affect how long it takes to cook – just as it does with a conventional oven. Use your judgement along with the recipe to check whether the food has been cooked properly.
Why do I get condensation on the inside of the door?	Condensation is perfectly normal, especially when you are cooking food with a high moisture content such as potatoes.
Does the microwave energy get through the window on the door?	No. The door has a special metal screen with holes in that lets you see inside but stops microwave energy from getting out.
Steam comes out of the side of the door and vents. Can microwave energy get out too?	No. The door and vents are carefully designed to let steam out during cooking but keep microwave energy in. The gaps are not big enough for microwave energy to escape.
What happens if the microwave is switched on while the microwave is empty?	The microwave will be damaged. Do not switch the microwave on when there's nothing inside the microwave. It is a good idea to keep a cup of water in the microwave just in case someone accidentally starts the microwave.
Why doesn't the microwave's light illuminate?	Open the door. If the light does not illuminate, the bulb has probably blown. Call a qualified technician – do not try to change the bulb yourself.
There are sparks inside the microwave when I use the microwave. Will this cause any damage?	Yes. Make sure that you are not using any metal utensils and that your containers don't have a metal trim. You must not use metal in your microwave when you cook (except aluminium foil).
Light is showing through the vents and door. Does this mean the microwave energy can escape?	No. It is normal for the light to be visible and is nothing to be concerned about.
Why do I get interference on my TV and radio when I use the microwave?	Microwaves use radio waves similar to those received by TVs and radios. You can lessen the interference by moving your microwave further away from the TV or radio.

## specification

<b>Model</b>	<b>K31GSS10</b>
<b>Input</b>	230 - 240V~ 50Hz
<b>Microwave Output</b>	950 - 1000 Watts
<b>Microwave Frequency</b>	2450MHz
<b>Outside Dimensions (width x deep x height)</b>	520mm x 430mm x 335mm
<b>Power consumption</b>	
<b>Microwave Input</b>	1550 - 1650 Watts
<b>Grill Input</b>	1000 - 1100 Watts

Complies with EC directives 2004/108/EC and 2006/95/EC.

We continually strive to improve our products. Features and specifications may change without prior notice.

# safety warnings

## general safety

- Switch off and unplug before fitting or removing tools/attachments, after use and before cleaning.
- Keep your fingers away from moving parts and fitted attachments.
- Never use a damaged appliance.
- Never operate the appliance when it is empty.
- Keep the mains cable out of reach from children.
- Keep the unit, mains cable and plug away from water.
- Never exceed the maximum capacities.
- When using an attachment, read the accompanying safety instructions.
- Take care when lifting this appliance as it is heavy.
- You should always have your appliance checked by a qualified technician if it has been dropped or damaged to ensure it is safe to use.
- This appliance is not intended for use by persons (including children) with reduced physical, sensory or mental capabilities, or lack of experience and knowledge, unless they have been given supervision or instruction concerning the use of the appliance by a person responsible for their safety.
- Children should be supervised to ensure that they do not play with the appliance.
- Only use the appliance for its intended domestic use.

## maintenance of your microwave

**warning** : It is hazardous for anyone other than a qualified technician to carry out any service or repair operation which involves the removal of a cover that gives protection against exposure to microwave energy.

**warning** : If the door or door seals are damaged, the microwave must not be operated until it has been repaired by a qualified technician.

- If smoke is observed, switch off or unplug the microwave and keep the door closed in order to stifle any flames.
- If the mains cable is damaged, it must be replaced by a service agent or a qualified technician.
- If you have a pacemaker, please contact your doctor before using a microwave.

## microwave use

- This microwave is not intended for commercial use.
- It should never be used for drying clothes or for other non-food purposes.
- The appliance is not intended to be operated by means of an external timer or separate remote-control system.
- The microwave should not be left unattended when in use.
- The temperature of accessible surfaces may be high when the microwave is operating.
- To prevent high moisture content gathering inside the microwave cavity, open the door immediately after the cooking function has stopped to allow steam to escape.
- Only use utensils that are suitable for microwave use.
- Care should be taken when using paper, plastic, wooden or other combustible materials in the microwave as they can catch fire.
- Oil & fat for deep frying should not be heated in the microwave.
- Only use cling film designed for microwave use and take extra care when removing the film to avoid steam burns.
- Only heat popcorn that has been designed for microwave use.

## cooking use

- As the power of different microwaves can vary considerably, care must be taken when first using this microwave as it may cook faster than expected.
- Do not leave the microwave unattended during use.
- Take care when cooking food with a high sugar or fat content, such as Christmas pudding or fruitcake. The sugar or fat can overheat and in some cases catch fire.

**warning** : Only allow children to use the microwave without supervision when adequate instructions have given so that the child is able to use the microwave in a safe way and understands the hazards of improper use; DO NOT assume that because a child has mastered one cooking skill he/she can cook everything without close supervision. The microwave MUST NOT be treated nor used like a toy.

## fire!

In the event of fire:

- Keep the microwave door closed.
- Turn off the power.
- Unplug the microwave from the mains power.

## first aid

Treat scalding by:

- Quickly placing the scald under cold running water for at least 10 minutes.
- Cover with a clean dry dressing. Do not use creams, oils or lotions.

## cleaning your microwave

The microwave should be cleaned regularly and food deposits removed. Failure to maintain the microwave in a clean condition can affect the life of the microwave and possibly result in a hazardous situation. (See cleaning your microwave)

## do not use these in your microwave

- Metal objects are not to be used in the microwave. These include:
  - Metal cooking utensils.
  - Metal plates or trays
  - Wine twist ties
  - Crockery with metal trims
  - Meat thermometer
- Never use equipment made of metal, except aluminium foil in your microwave. The microwave energy cannot pass through the metal so it bounces off and sparks against the inside of the microwave.
- Stop the microwave straight away if any equipment is causing sparks.
- Remember that some crockery has a metal trim around the edge. Even this trim can cause sparks.

## containers

**warning** : Pressure will build up in sealed containers and can cause them to explode. Therefore, do not use the following in your microwave:

- Sealed containers
  - Sealed jars
  - Nuts
  - Capped bottles
  - Hard-boiled eggs
  - Vacuum containers
  - Eggs in their shells
- Always pierce the skin of fruit and vegetables, such as potatoes.
  - Never use scratched, cracked or damaged glass in a microwave. Damaged glass can explode.
  - When heating food in plastic or paper containers, keep an eye on the microwave due to the possibility of ignition.

## delayed boiling

Liquids heated in a microwave can boil up when removing them from the microwave.

Take the following precautions :

- Always stir liquids, before and after cooking.
- Allow them to stand.
- Use containers that are wider at the top than at the bottom.

## preparing food for babies

Extra care must be taken when preparing food or drink for babies and small children.

- Always test the food or liquid temperature before feeding it to the baby.
- When using a baby bottle, ensure the teat is removed before heating.
- When warming milk, ensure the bottle is shaken.



### caution!

### hot surface

During cooking the outer surface will become hot. Do not touch the outer casing of the microwave. Care should be taken not to store any items on top of your microwave.



### earthing instructions

**warning: THIS APPLIANCE MUST BE EARTHED.**

- This appliance is equipped with a mains cable having an earthed plug.
- The plug must be plugged into an appropriate mains socket that is installed and earthed in accordance with all local standards and requirements.

### warning!

- Improper connection of the appliance-earthing conductor can result in a risk of an electric shock.
- Check with a qualified electrician or service representative if you are in doubt whether the appliance is properly earthed.
- Never modify the plug provided with the appliance.
- If the plug does not fit properly in the mains socket, have a qualified electrician install a proper mains socket.
- The appliance is not intended to be operated by means of an external timer or separate remote-control system.





NOTE: If you require a replacement for any of the items listed below, please quote their corresponding part numbers:

Replacement Part	Part Number
Grill Rack	256511700002
Defrost Rack	250900200006
Glass Turntable Plate	252100500498
Turntable Support	252200200008



Visit [Partmaster.co.uk](http://Partmaster.co.uk) today for the easiest way to buy electrical spares and accessories. With over 1 million spares and accessories available we can deliver direct to your door the very next day. Visit [www.partmaster.co.uk](http://www.partmaster.co.uk) or call 0844 800 3456 (UK customers only) Calls charged at National Rate.



This symbol on the product or in the instructions means that your electrical and electronic equipment should be disposed at the end of its life separately from your household waste. There are separate collection systems for recycling in the EU.

For more information, please contact the local authority or your retailer where you purchased the product.



DSG Retail Limited is responsible for after sales service.  
If you have a query about the product please contact our product support line 0844 561 6263 (Currys).

DSG Retail Ltd • Maylands Avenue • Hemel Hempstead • Herts • HP2 7TG • England

[kenwoodworld.com](http://kenwoodworld.com)

**KENWOOD**  
CREATE MORE

(P.N.: 261800307398)



## Free Manuals Download Website

<http://myh66.com>

<http://usermanuals.us>

<http://www.somanuals.com>

<http://www.4manuals.cc>

<http://www.manual-lib.com>

<http://www.404manual.com>

<http://www.luxmanual.com>

<http://aubethermostatmanual.com>

Golf course search by state

<http://golfingnear.com>

Email search by domain

<http://emailbydomain.com>

Auto manuals search

<http://auto.somanuals.com>

TV manuals search

<http://tv.somanuals.com>