

KENWOOD

KDC-X896 KDC-BT852HD KDC-X496 KDC-452U KMR-550U

CD-RECEIVER

Quick Start Guide

AMPLI-TUNER LECTEUR DE CD

Guide de démarrage rapide

REPRODUCTOR DE DISCOS COMPACTOS RECEPTOR DE FM/AM

Guía de inicio rápido

JVC KENWOOD Corporation

Take the time to read through this instruction manual.

Familiarity with installation and operation procedures will help you obtain the best performance from your new CD-Receiver.

For your records

Record the serial number, found on the back of the unit, in the spaces designated on the warranty card, and in the space provided below. Refer to the model and serial numbers whenever you call upon your Kenwood dealer for information or service on the product.

Model KDC-X896/ KDC-BT852HD/ KDC-X496/ KDC-452U/ KMR-550U Serial number _____

US Residence Only

Register Online

Register your Kenwood product at www.Kenwoodusa.com

Contents

About the Quick Start Guide.....	2
Before use	3
Preparations	4
Basic operations.....	5
Playing music (CD/USB/iPod).....	6
Listening to the Pandora® Internet radio	7
Listening to the radio/HD Radio™ tuner/ SiriusXM™ Satellite Tuner.....	8
Hands-free phoning	9
Installation	10
Before installation	10
Connecting wires to terminals.....	12
Installing/Removing the unit.....	14
Installing the Microphone unit	15
Appendix	15

About the Quick Start Guide

This Quick Start Guide explains the basic functions of this unit. For functions that are not explained here, refer to the relevant Instruction manual which can be downloaded at <http://manual.kenwood.com/edition/im344>.

To refer to Instruction manual, a PC loaded with Microsoft® Windows XP/Vista/7 or Mac OS X® 10.4 or later is required in addition to Adobe® Reader™ 7.1 or Adobe® Acrobat® 7.1 or later.

The Instruction manual is subject to change for modification of specifications and so forth. Be sure to download the latest edition of the Instruction manual for reference.

The illustrations of the display and panel appearing in this manual are examples used to explain more clearly how the controls are used. Therefore, what appears on the display in the illustrations may differ from what appears on the display on the actual equipment, and some of the images on the display may be inapplicable.

⚠ CAUTION

- Keep battery out of reach of children and in original package until ready to use. Dispose of used batteries promptly. If swallowed, contact a physician immediately.
- Do not leave the battery near fire or under direct sunlight. A fire, explosion or excessive heat generation may result.
- Do not set the remote control in hot places such as on the dashboard.
- The Lithium battery is in danger of explosion if replaced incorrectly. Replace it only with the same or equivalent type.

Before use

⚠ WARNING

To prevent injuries or a fire, take the following precautions:

- Stop the car before operating the unit.
- To prevent a short circuit, never put or leave any metallic objects (such as coins or metal tools) inside the unit.

⚠ CAUTION

- Adjust the volume so that you can hear sound outside the car. Driving with the volume adjusted to a too high level may cause an accident.
- Wipe off the dirt on the panel with a dry silicon or soft cloth. Failure to observe this precaution may result in damage to the monitor or unit.

Cleaning the connector

The unit may not function properly if the connector between the unit and faceplate are dirty. Detach the faceplate and clean the connector with a cotton swab gently, being careful not to damage the connector.

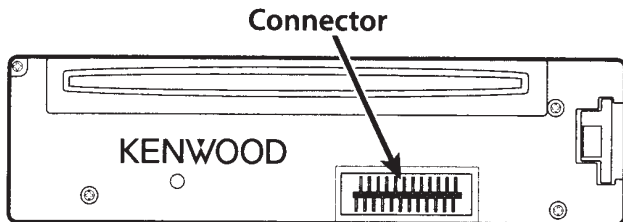

Condensation

When the car is air-conditioned, moisture may collect on the laser lens. This may cause disc read errors. In this case, remove the disc and wait for the moisture to evaporate.

Notes

- If you experience problems during installation, consult your Kenwood dealer.
- When you purchase optional accessories, check with your Kenwood dealer to make sure that they can work with your model and in your area.
- Characters that conform to ISO 8859-1 can be displayed.

About the discs used with this unit

- This unit can only play the CDs with



- The following discs cannot be used:
 - A disc that is not round
 - A disc with coloring on the recording surface or a disc that is dirty
 - A recordable/rewritable disc that has not been finalized (For the finalization process, refer to the instruction manual that came with your disc writing software or your disc recorder.)
 - An 8 cm (3 inch) disc (An attempt to insert using an adapter can cause malfunction.)

Handling discs

- Do not touch the recording surface of the disc.
- Do not stick tape etc. on the disc, or use a disc with tape stuck on it.
- Do not use any accessories for the disc.
- Do not use any solvents to clean discs. Use a dry silicon or soft cloth.
- Clean the disk by moving the cloth outward from the center of the disc.
- When removing a disc from this unit, pull it out horizontally.
- If the center hole or outside rim of a disc has burrs, remove them before inserting a disc.

How to reset your unit

If the unit fails to operate properly, press the Reset button. The unit returns to the factory settings when the Reset button is pressed.

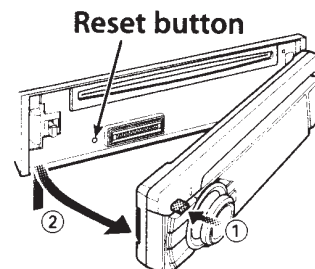

Preparations

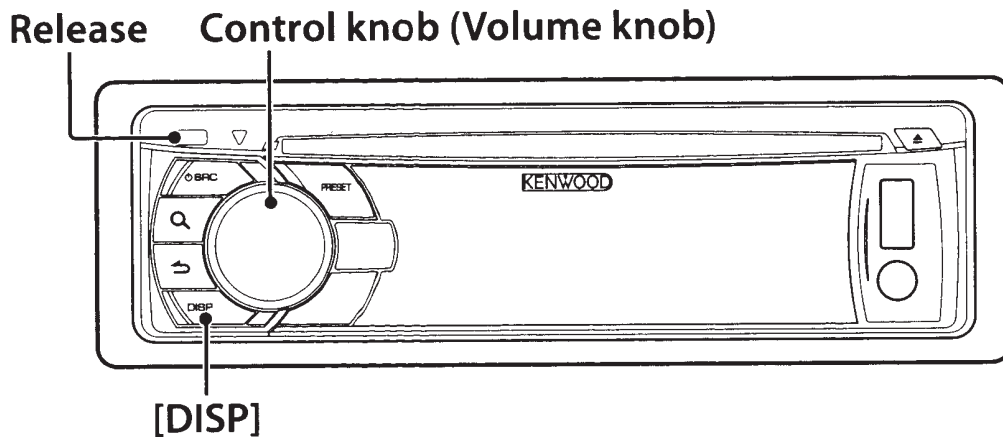

Exiting the Demonstration mode

Turn off the Demonstration mode when you use the unit for the first time after installation. (KDC-X896/ KDC-BT852HD/ KDC-X496/ KDC-452U only)

- 1 Press the **Control knob** to quit the Demonstration mode when the message "To cancel DEMO Press the volume knob" is displayed (approx. 15 seconds).
- 2 Turn the **Control knob** and press it when "YES" is displayed. The Demonstration mode can also be canceled in the Function Setting mode. Refer to <Demonstration mode setting> (page 36) in Instruction manual

Adjusting the clock

- 1 Press the **[DISP]** button several times to display the clock.
- 2 Press and hold **[DISP]** button.
- 3 Turn the **Control knob** to adjust the hour, and then press the **Control knob**.
- 4 Turn the **Control knob** to adjust the minute, and then press the **Control knob**.

Detaching/ Reattaching the faceplate

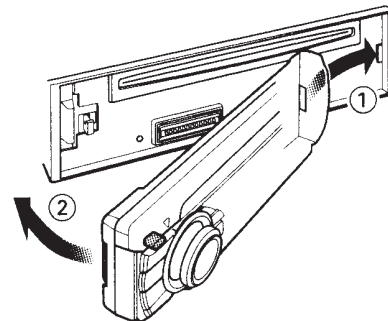
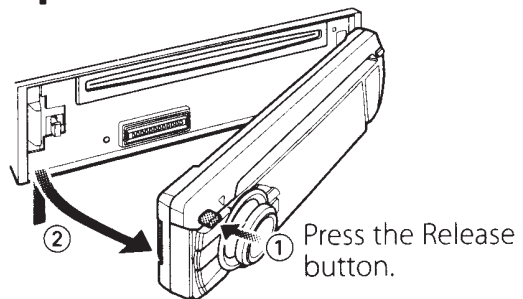

- Remove the faceplate at once after pressing the Release button; otherwise it can fall down due to vibration.
- The faceplate is a precision component of the unit and can be damaged by shocks or jolts.
- Keep the faceplate in its case while detached.
- Do not place the faceplate (and case) in areas exposed to direct sunlight, excessive heat or humidity. Also avoid places with too much dust or the possibility of water splashing.

Basic operations

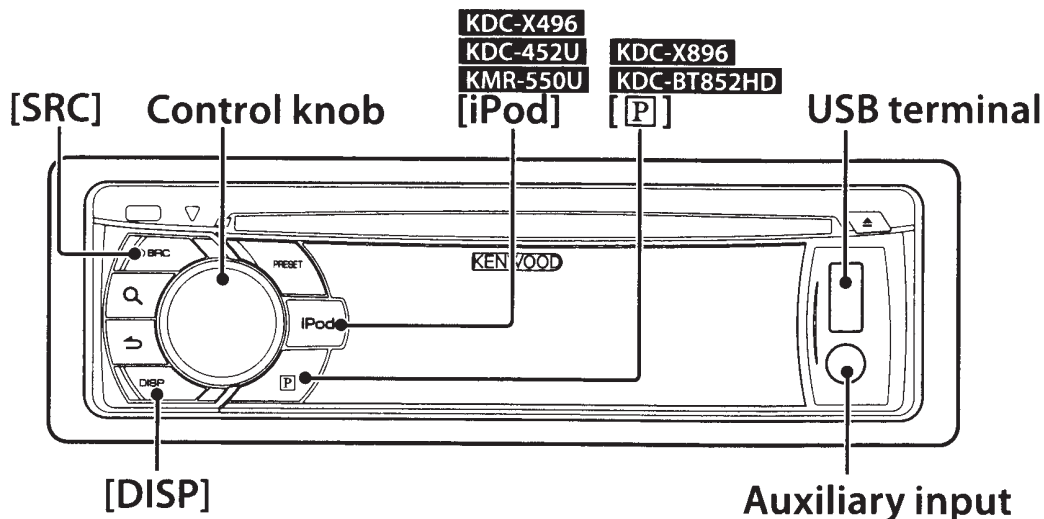

Power

Turn the power on by pressing the **[SRC]** button.
Press and hold **[SRC]** button to turn the power off.

Source selection

Pressing the **[SRC]** button repeatedly switches among sources.

Source	Display
Standby	"STANDBY"
SiriusXM (optional accessory)	"SiriusXM"
HD Radio™ tuner (KDC-X896/ KDC-BT852HD)/ Tuner (KDC-X496/ KDC-452U/ KMR-550U)	"HD RADIO"/ "TUNER"
Bluetooth audio (Function of KDC-X896/ KDC-BT852HD)	"BT AUDIO"
USB or iPod	"USB" or "iPod"
Pandora® Internet radio (Function of iPhone®)	"Pandora"
CD	"CD"
Auxiliary Input	"AUX"

The source "iPod", "CD", and "Pandora" can be selected when it is ready to play.

KDC-X896 **KDC-BT852HD**

Press the **[P]** button to switch the source to Pandora Internet radio.

KDC-X496 **KDC-452U** **KMR-550U**

Press the **[iPod]** button to switch the source to iPod.

Volume

Turn the **Control knob** to adjust the sound volume.

USB terminal

A USB device or iPod can be connected. The CA-U1EX or KCA-iP102 (optional accessories) is recommended to connect a USB device or iPod.

Auxiliary input

A portable audio device can be connected with a stereo mini-plug (3.5 mm ø).

Display selection

Pressing the **[DISP]** button repeatedly switches among 5 (KDC-X896/ KDC-BT852HD/ KDC-X496/ KDC-452U)/ 4 (KMR-550U) types of display. You can select the information to be displayed. Refer to <Display settings> (page 28) in Instruction manual.

Display scroll

Keep the **[DISP]** button pressed down to scroll through the CD or audio file text display.

Playing music (CD/USB/iPod)

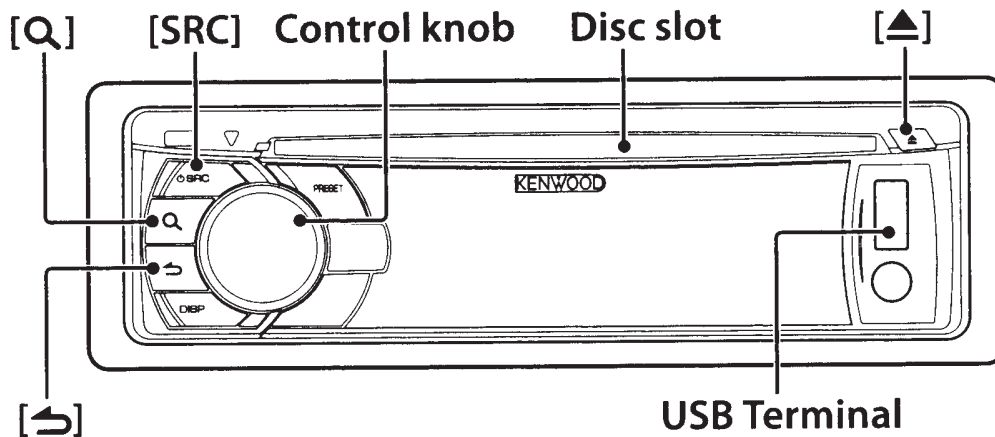

Playing a disc

Insert a disc in the **Disc slot**.
When it is inserted, the source is switched automatically and playback starts.

Playing a USB device/ iPod

Connect a USB device or iPod to the **USB terminal**.
When it is connected, the source is switched automatically and playback starts.
(USB terminal maximum supply current: DC 5 V \equiv 1 A)

Selecting an audio file folder

Push the **Control knob** upward or downward to select a folder.

Selecting a song

Push the **Control knob** rightward or leftward to select a song (track or file).

Fast-forwarding or fast-backwarding a song

Push and hold the **Control knob** rightward or leftward to fast-forward or fast-backward the song (track or file).

Pause and play

Press the [**↵**] button to interrupt or resume playing a song (track or file).

Music search

You can search for the song you want to play.

- 1 Press the [**Q**] button.
- 2 Search for a song.

Operation type	Operation
Movement between items	Turn the Control knob .
Selection of item	Press the Control knob .
Return to previous item	Press the [↵] button.

To cancel music search in audio files or iPod, Press and hold [**↵**] button.

Removing disc

Press the [**▲**] button to eject a disc.

Removing USB device/ iPod

Press the [**SRC**] button to switch the source to a device other than USB, iPod, and Pandora Internet radio, and then remove the USB device.

Data contained in the USB device/ iPod may be damaged if you remove it when it is used as the active source.

Listening to the Pandora® Internet radio

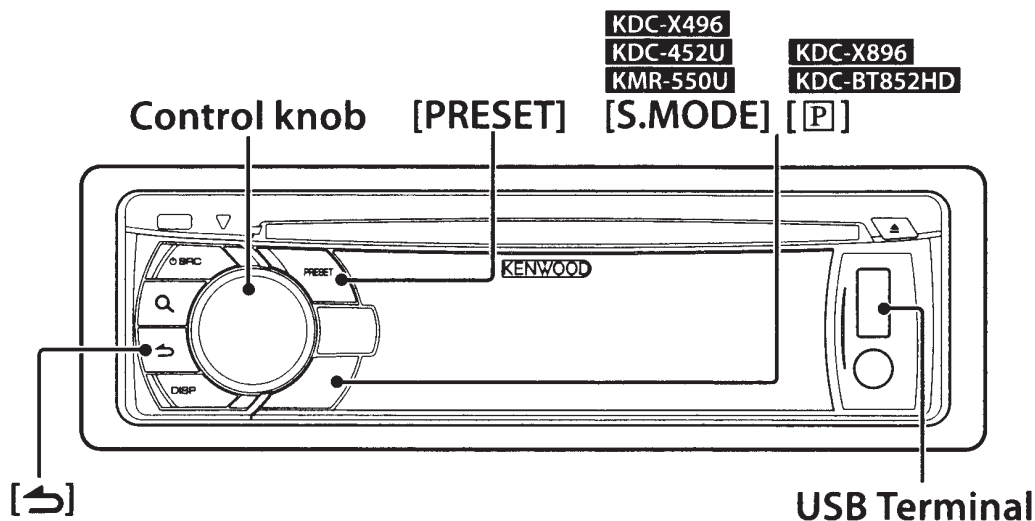

Listening to the Pandora® Internet radio

Install the Pandora Internet radio application in your iPhone (or Bluetooth device).

Connect your iPhone to this unit using a KCA-iP102 (optional accessory), and then select the Pandora Internet radio source. The application starts automatically, allowing you to listen to the Pandora Internet radio.

If no iPhone is connected, connecting a Bluetooth device to this unit using A2DP also allows you to listen to the Pandora Internet radio. (KDC-X896, KDC-BT852HD only)

When a Bluetooth device is connected or the iOS version is earlier than 4.0, start the Internet radio application before selecting the Pandora Internet radio source.

Thumbs up

Press and hold **[PRESET]** button.

Thumbs down

KDC-X896 **KDC-BT852HD**

Press and hold **[P]** button.

KDC-X496 **KDC-452U** **KMR-550U**

Press and hold **[S.MODE]** button.

Song skip

Push the **Control knob** rightward.

Pause and play

Press the **[↔]** button to interrupt or resume playing a song.

Listening to the radio/HD Radio™ tuner/ SiriusXM™ Satellite Tuner

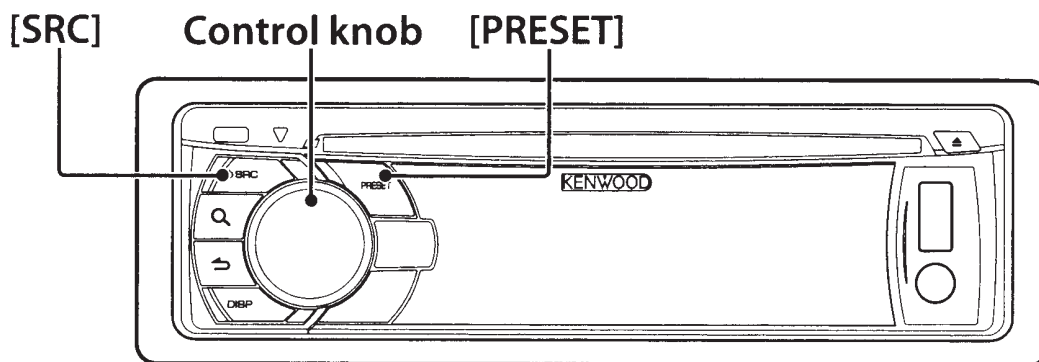

Selecting a tuner source

Press the **[SRC]** button to select “HD RADIO”/“TUNER” or “SiriusXM” (optional accessory).

Selecting a band (HD Radio tuner / Tuner only)

Push the **Control knob** downward to select a band (FM or AM).

Selecting a station

Push the **Control knob** leftward or rightward to select the station you want to listen to.

The tuning mode can be changed. Refer to <Tuner setting> (page 20) or <HD Radio tuner setting> (page 25) in Instruction manual

Station preset memory

- 1 Push the **Control knob** downward to select a band. (HD Radio tuner / Tuner only)
- 2 Push the **Control knob** leftward or rightward to select the station you want to save in the station preset memory.
- 3 Press the **[PRESET]** button.
Press the **[PRESET]** button again to enter the Mix Station preset mode. In this mode, different bands and tuner sources (Radio, SiriusXM, HD Radio tuner etc.) can be saved in the same preset layer, which

allows you to recall a desired station without switching between bands and/or tuner sources. Maximum of 6 stations can be preset in the Mix Station preset mode.

- 4 Turn the **Control knob** to select preset number (FM: “1” – “18”, AM: “1” – “6”, SiriusXM: “1” – “24”), and then press and hold **Control knob**.

Recalling the stations in the memory

- 1 Push the **Control knob** downward to change the band. (HD Radio tuner / Tuner only)
- 2 Press the **[PRESET]** button.
- 3 Turn the **Control knob** to select a preset number (FM: “1” – “18”, AM: “1” – “6”, SiriusXM: “1” – “24”), and then press the **Control knob**.
In the Mix Station preset mode, band names of tuner sources are displayed as follows:
FM: FM broadcast station
AM: AM broadcast station

Hands-free phoning

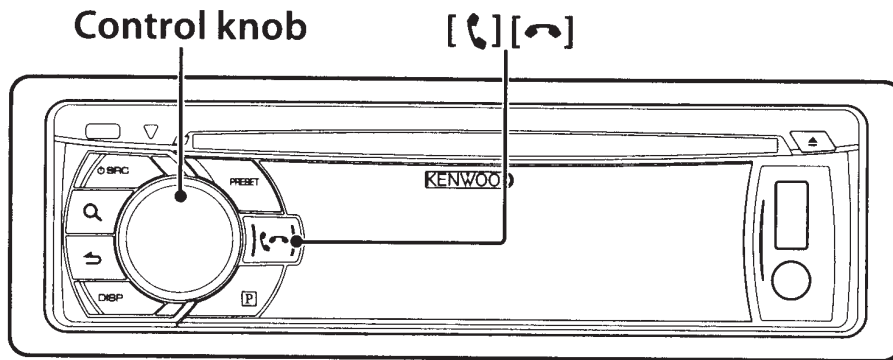

Registering a Bluetooth device

You can register your Bluetooth device in this unit.

- 1 Press and hold [☎] button.
Search for a Bluetooth device starts. It takes a while (tens of seconds or several minutes) to complete the search.
- 2 Press the **Control knob** when the model name of the Bluetooth device you want to register is displayed.
- 3 Enter the PIN code of your Bluetooth device.

Operation type	Operation
Select a number.	Turn the Control knob .
Move to the next digit.	Push the Control knob rightward.
Delete the last digit.	Push the Control knob leftward.
Transmit the PIN code.	Press the Control knob .

Connection to your Bluetooth device starts, "Pairing Success" is displayed a while later, and then the previous source is selected.

When registration of your cell-phone is completed, the phone book of the cell-phone is automatically downloaded to this unit. (If the phone book has not been downloaded to this unit, operate the cell-phone to download it.)

Dialing a number in the phone book

Dial the phone number in the phone book of your cellphone.

If the phone book has not been downloaded to this unit, operate the cellphone to download it.

- 1 Press the [☎] button.
- 2 Turn the **Control knob** and press it when "Phone Book" is displayed.
- 3 Turn the **Control knob** to select a phone number.
Push the **Control knob** rightward or leftward to select the name of the called party.

Operation type	Operation
Select a phone number.	Turn the Control knob .
Select the initial.	Push the Control knob upward or downward.
Determine the phone number.	Press the Control knob .

- 4 Press the [☎] button.

Answering a phone call

Press the [☎] button.

Disconnecting a call

Press the [↶] button.

Installation

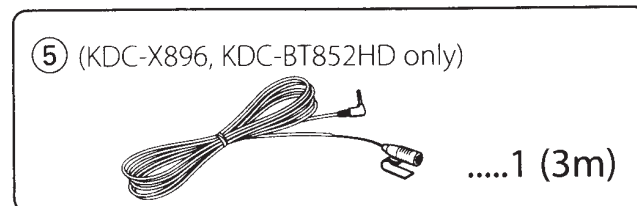
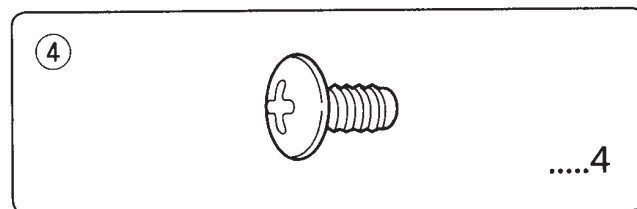
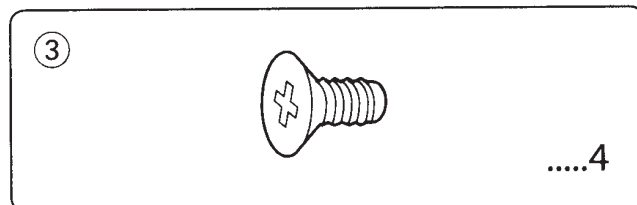
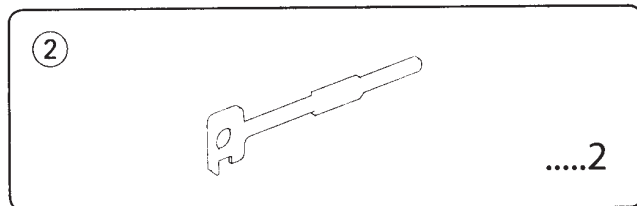
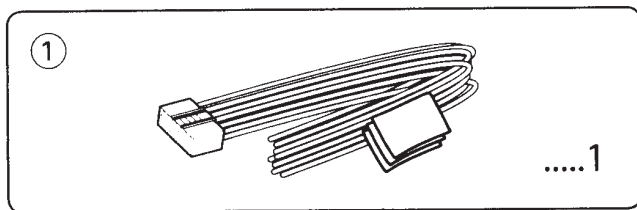

Before installation

▲ WARNING

- The unit can only be installed in a car with a 12V DC power supply, negative ground.
- If you connect the ignition wire (red) and the battery wire (yellow) to the car chassis (ground), you may cause a short circuit, that in turn may start a fire. Always connect those wires to the power source running through the fuse box.

▲ CAUTION

- Install this unit in the console of your vehicle.
- Do not touch the metal parts of this unit during and shortly after use of the unit. Metal parts such as the heat sink and enclosure become hot.
- Mounting and wiring this product requires skills and experience. For safety's sake, leave the mounting and wiring work to professionals.
- If you experience any problem during installation, consult your Kenwood dealer.
- Disconnect the battery's negative terminal before installing the unit.
- Insulate unconnected wires with vinyl tape or other similar materials. To prevent a short circuit, do not remove the caps on the ends of the unconnected wires and terminals.
- Be sure to ground this unit to the car's chassis again after mounting.
- If the fuse blows, first make sure the wires are not touching other parts to cause a short circuit, and then replace the old fuse with one with a new the same rating.
- When connecting only two speakers, connect the connectors either to both of the front output terminals or to both of the rear output terminals (do not mix front and rear terminals). For example, if you connect the ⊕ connector of the left speaker to a front output terminal, do

not connect the ⊖ connector to a rear output terminal.

- Connect the speaker wires correctly to the corresponding terminals. The unit may be damaged or fail to work if you share the ⊖ wires or ground them to any metal part in the car.
- Do not use your own screws. Use only the supplied screws. Using wrong screws, could damage the unit.
- If your car's ignition key switch does not have an ACC position, connect the ignition wires to a power source that can be turned on and off with the ignition key. If you connect the ignition wires to a constant-voltage power source, as with battery wires, the battery may die.
- If the console has a lid, make sure to install the unit so that the faceplate will not hit the lid when it is closed or opened.
- After the installing the unit, check whether the brake lamps, blinkers, wipers, etc. on the car are working properly.
- Mount the unit so that the mounting angle is 30° or less.
- Reception may become poor if there are metal objects near the Bluetooth antenna. (KDC-X896, KDC-BT852HD only)

For Good Reception

To assure good reception, note the following:

- Communicate with the cell-phone within the line-of-sight distance of 10 m (30 ft). The communication range becomes shorter depending on the surrounding environment. The communication range also becomes shorter when there is an obstacle between this unit and the cell-phone. The above maximum communication range (10 m) is not always assured.
- A broadcast station or walkie-talkie located nearby can interfere with communication due to a too strong signal.

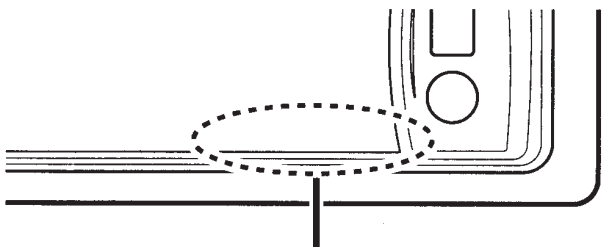

Bluetooth antenna unit

Connecting wires to terminals

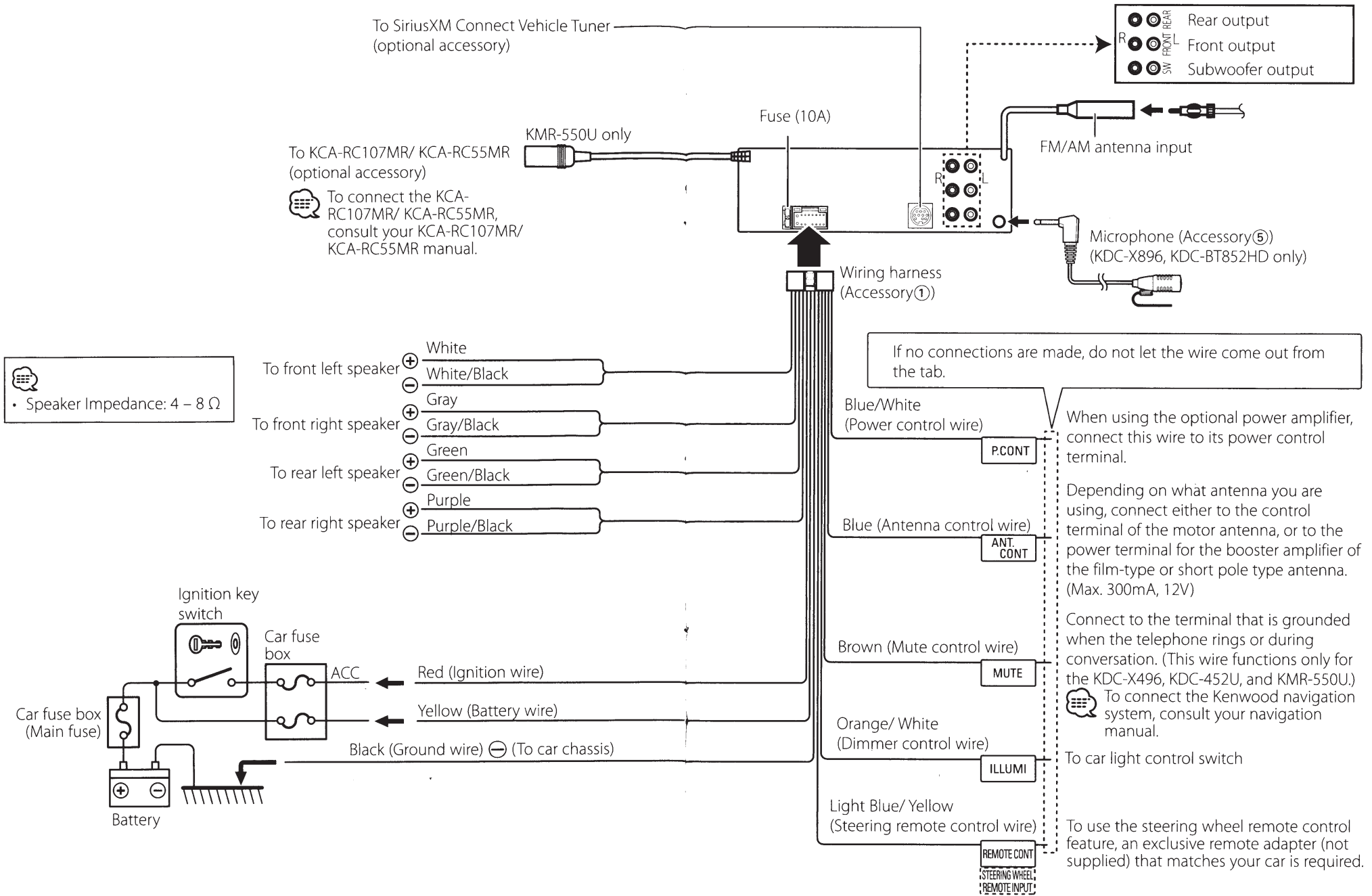

Installing/Removing the unit

Non-Japanese cars

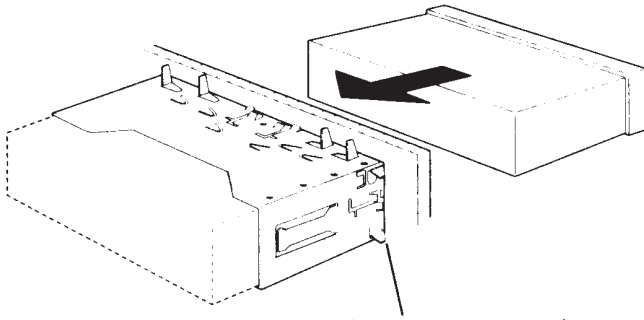

Bend the tabs of the mounting sleeve with a screwdriver or the like and attach it in place.



- Make sure that the unit is installed securely in place. If the unit is unstable, it may malfunction (for example, the sound may skip).

Japanese cars

- 1 Remove the hard rubber frame with reference to <Removing the hard rubber frame>.
- 2 Align the holes in the unit (two locations on each side) with the vehicle mounting bracket and secure the unit with the accessory screws.

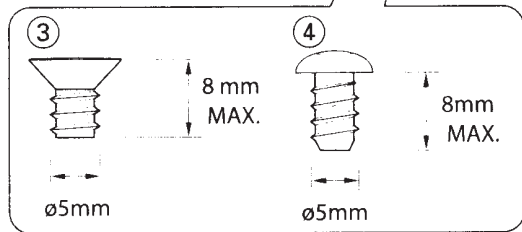
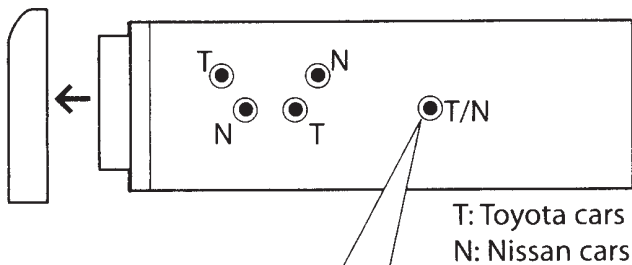

Accessory ③...For Nissan car
Accessory ④...For Toyota car

Removing the hard rubber frame

- 1 Engage the catch pins on the removal tool and release the two locks on the upper part of frame. Lift up and pull the frame forward as shown in the figure.

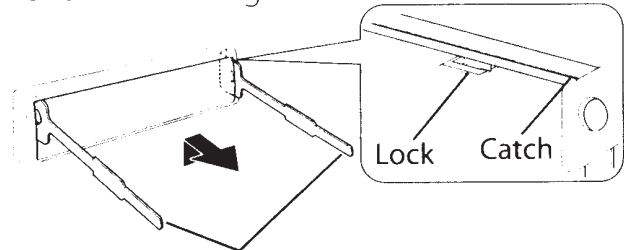

Removal tool (Accessory ②)

- 2 When the upper part of frame is removed, remove the lower part of frame.



- The frame can be removed from the bottom side in the same manner.

Removing the unit

- 1 Remove the hard rubber frame with reference to <Removing the hard rubber frame>.
- 2 Remove the faceplate.
- 3 Insert the two removal tools deeply into the slots on both sides as shown.
- 4 Lower the removal tool toward the bottom, and then pull out the unit halfway while pressing the removal tool towards the inside.

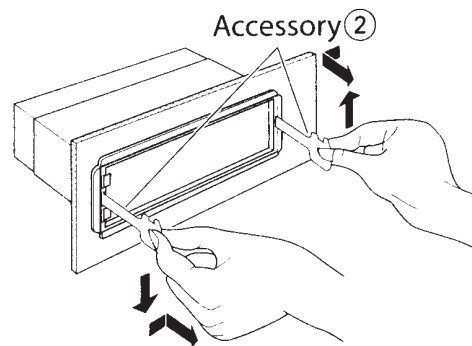

- Be careful to avoid injury from the catch pins on the removal tool.
- 5 Pull the unit all the way out with your hands, being careful not to drop it.

Installing the Microphone unit

- 1 Check the installation position of the microphone (accessory ⑤).
- 2 Remove oil and other dirt from the installation surface.
- 3 Install the microphone.
- 4 Lay the cable up to the unit with it secured at several positions using tape or the like.



- Install the microphone as far as possible from the cell-phone.

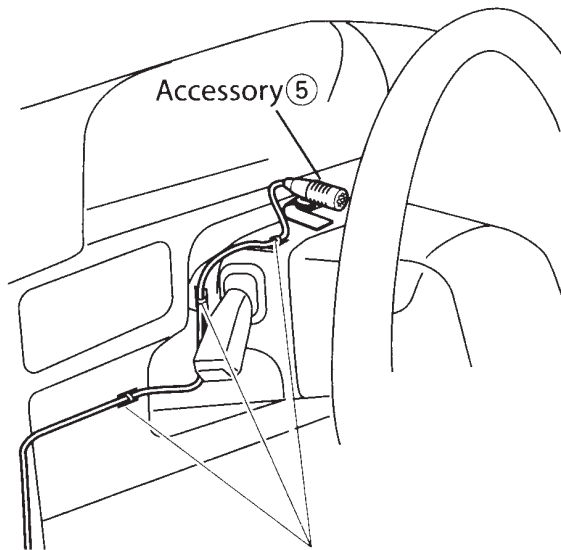

Fix a cable with a commercial item of tape.

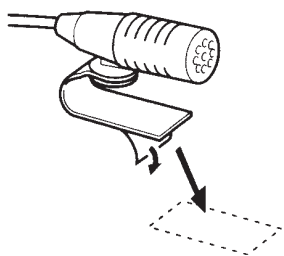

Peel off the release coated paper of double-face adhesive tape to secure the microphone on the place shown above.

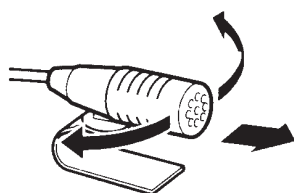

Turn the microphone toward the driver.

Appendix

About Audio file

- Playable Audio files
 - AAC-LC (.m4a), MP3 (.mp3), WMA (.wma)
- Playable disc media
 - CD-R/RW/ROM
- Playable disc file formats
 - ISO 9660 Level 1/2, Joliet, Romeo, Long file name.
- Playable USB devices
 - USB mass storage class
- Playable USB device file systems
 - FAT16, FAT32

The online manual about audio files is put on the site, www.kenwood.com/cs/ce/audiofile/.

Models of iPods/iPhones that can be connected to this unit

Made for

- iPod touch (4th generation)
- iPod touch (3rd generation)
- iPod touch (2nd generation)
- iPod touch (1st generation)
- iPod classic
- iPod with video
- iPod nano (6th generation)
- iPod nano (5th generation)
- iPod nano (4th generation)
- iPod nano (3rd generation)
- iPod nano (2nd generation)
- iPod nano (1st generation)
- iPhone 4S
- iPhone 4
- iPhone 3GS
- iPhone 3G
- iPhone

For information on the compatibility with iPod/iPhone software, visit www.kenwood.com/cs/ce/ipod/.

▲CAUTION

Use of controls or adjustments or performance of procedures other than those specified herein may result in hazardous radiation exposure. In compliance with Federal Regulations, following are reproductions of labels on, or inside the product relating to laser product safety.

JVC KENWOOD Corporation
2967-3, ISHIKAWA-MACHI,
HACHIOJI-SHI, TOKYO, JAPAN

THIS PRODUCT COMPLIES WITH DHHS RULES
21 CFR SUBCHAPTER J IN EFFECT AT DATE OF
MANUFACTURE.

Location : Top plate

FCC WARNING

This equipment may generate or use radio frequency energy. Changes or modifications to this equipment may cause harmful interference unless the modifications are expressly approved in the instruction manual. The user could lose the authority to operate this equipment if an unauthorized change or modification is made.

FCC NOTE

This equipment has been tested and found to comply with the limits for a Class B digital device, pursuant to Part 15 of the FCC Rules. These limits are designed to provide reasonable protection against harmful interference in a residential installation. This equipment may cause harmful interference to radio communications, if it is not installed and used in accordance with the instructions. However, there is no guarantee that interference will not occur in a particular installation. If this equipment does cause harmful interference to radio or television reception, which can be determined by turning the equipment off and on, the user is encouraged to try to correct the interference by one or more of the following measures:

- Reorient or relocate the receiving antenna.
- Increase the separation between the equipment and receiver.
- Connect the equipment into an outlet on a circuit different from that to which the receiver is connected.
- Consult the dealer or an experienced radio/TV technician for help.

IC (Industry Canada) Notice

Operation is subject to the following two conditions:

- (1) This device may not cause interference, and
- (2) this device must accept any interference, including interference that may cause undesired operation of the device.

The term "IC:" before the certification/registration number only signifies that the Industry Canada technical specification were met.

Note de IC (Industrie Canada)

"L'utilisation de ce dispositif est autorisée seulement aux conditions suivantes :

- (1) il ne doit pas produire de brouillage et
- (2) l'utilisateur du dispositif doit être prêt à accepter tout brouillage radioélectrique reçu, même si ce brouillage est susceptible de compromettre le fonctionnement du dispositif"

L'expression "IC:" avant le numéro d'homologation/enregistrement signifie seulement que les spécifications techniques d'Industrie Canada ont été respectées.

▲CAUTION

This equipment complies with FCC/IC radiation exposure limits set forth for an uncontrolled environment and meets the FCC radio frequency (RF) Exposure Guidelines in Supplement C to OET65 and RSS-102 of the IC radio frequency (RF) Exposure rules. This equipment has very low levels of RF energy that it deemed to comply without maximum permissive exposure evaluation (MPE). But it is desirable that it should be installed and operated keeping the radiator at least 20cm or more away from person's body (excluding extremities: hands, wrists, feet and ankles).

Under Industry Canada regulations, this radio transmitter may only operate using an antenna of a type and maximum (or lesser) gain approved for the transmitter by Industry Canada. To reduce potential radio interference to other users, the antenna type and its gain should be so chosen that the equivalent isotropically radiated power (e.i.r.p.) is not more than that necessary for successful communication.

▲ATTENTION

Cet équipement est conforme aux limites d'exposition aux rayonnements énoncées pour un environnement non contrôlé et respecte les règles d'exposition aux fréquences radioélectriques (RF) CNR-102 de l'IC. Cet équipement émet une énergie RF très faible qui est considérée conforme sans évaluation de l'exposition maximale autorisée. Cependant, cet équipement doit être installé et utilisé en gardant une distance de 20 cm ou plus entre le dispositif rayonnant et le corps (à l'exception des extrémités : mains, poignets, pieds et chevilles).

Conformément à la réglementation d'Industrie Canada, le présent émetteur radio peut fonctionner avec une antenne d'un type et d'un gain maximal (ou inférieur) approuvé pour l'émetteur par Industrie Canada. Dans le but de réduire les risques de brouillage radioélectrique à l'intention des autres utilisateurs, il faut choisir le type d'antenne et son gain de sorte que la puissance isotrope rayonnée équivalente (p.i.r.e.) ne dépasse pas l'intensité nécessaire à l'établissement d'une communication satisfaisante.

- Contains Transmitter Module
FCC ID : RKXFC6000S
- Contains Transmitter Module
IC: 5119A-FC6000S

Requirements Pandora® internet radio:

Requirements for listening to the Pandora® internet radio are as follows:

iPhone or iPod touch

- Use an Apple iPhone or iPod touch running under iOS3 or later.
- Install the latest version of the Pandora® application on your iPhone. (Search for "Pandora" in the Apple iTunes App Store to find and install the most current version.)
- Create an account with Pandora®. (If you are not already a registered user, an account can be established at www.pandora.com.)
- Internet connection by 3G, EDGE, or WiFi.
- iPhone connected to this unit with a KCA-iP102.

Android™

- Visit the Android marketplace and search for Pandora to install.
- Bluetooth must be built in and the following profiles must be supported.
 - SPP (Serial Port Profile)
 - A2DP (Advanced Audio Distribution Profile)

BlackBerry®

- Visit www.pandora.com from the built in browser to download the Pandora application.
- Bluetooth must be built in and the following profiles must be supported.
 - SPP (Serial Port Profile)
 - A2DP (Advanced Audio Distribution Profile)

NOTE

- In the application on your device, log in and create an account with Pandora. (If you are not already a registered user, an account can also be created at www.pandora.com.)
- Internet connection by 3G, EDGE, or WiFi.
- Pandora® is available only in the U.S.
- Because Pandora® is a third-party service, the specifications are subject to change without prior notice. Accordingly, compatibility may be impaired or some or all of the services may become unavailable.
- Some functions of Pandora® cannot be operated from this unit.
- For issues using the application, please contact Pandora® at pandora-support@pandora.com

CALIFORNIA, USA

This product contains a CR Coin Cell Lithium

Battery which contains

Perchlorate Material – special handling may apply.

See www.dtsc.ca.gov/hazardouswaste/perchlorate

- The Bluetooth word mark and logos are owned by the Bluetooth SIG, Inc. and any use of such marks by JVC KENWOOD Corporation is under license. Other trademarks and trade names are those of their respective owners.
- The "AAC" logo is a trademark of Dolby Laboratories.
- "Made for iPod" and "Made for iPhone" mean that an electronic accessory has been designed to connect specifically to iPod or iPhone, respectively, and has been certified by the developer to meet Apple performance standards. Apple is not responsible for the operation of this device or its compliance with safety and regulatory standards. Please note that the use of this accessory with iPod or iPhone may affect wireless performance.
- iPhone, iPod, iPod classic, iPod nano, and iPod touch are trademarks of Apple Inc., registered in the U.S. and other countries.
- Sirius, XM and all related marks and logos are trademarks of Sirius XM Radio Inc. All rights reserved.
- HD Radio Technology manufactured under license from iBiquity Digital Corporation. U.S. and Foreign Patents. HD Radio™ and the HD, HD Radio, and "Arc" logos are proprietary trademarks of iBiquity Digital Corp.
- Adobe, Acrobat and Reader are either registered trademarks or trademarks of Adobe Systems Incorporated in the United States and/or other countries.
- PANDORA, the PANDORA logo, and the Pandora trade dress are trademarks or registered trademarks of Pandora Media, Inc., used with permission.
- Android is a trademark of Google Inc.
- BlackBerry®, RIM®, Research In Motion® and related trademarks, names and logos are the property of Research In Motion Limited and are registered and/or used in the U.S. and countries around the world. Used under license from Research In Motion Limited.

HD Radio®

This HD Radio receiver enables:

PSD)

HD2/HD3)

Digital Sound)

iTunes® Tagging)

SiriusXM
READY

Bluetooth®



Made for



iPod



iPhone



Designed for

**Windows
Media™**

works with

PANDORA®
internet radio

KDC-X896 KDC-BT852HD KDC-X496 KDC-452U KMR-550U

CD-RECEIVER INSTRUCTION MANUAL

JVC KENWOOD Corporation

Before reading this manual, click the button below to check the latest edition and the modified pages.

[Check the latest edition](#)

Take the time to read through this instruction manual.

Familiarity with installation and operation procedures will help you obtain the best performance from your new CD-receiver.

For your records

Record the serial number, found on the back of the unit, in the spaces designated on the warranty card, and in the space provided below. Refer to the model and serial numbers whenever you call upon your Kenwood dealer for information or service on the product.

Model KDC-X896/ KDC-BT852HD/ KDC-X496/ KDC-452U/ KMR-550U Serial number _____

US Residence Only

Register Online

Register your Kenwood product at www.Kenwoodusa.com

How to read this manual

Function setting procedure

For the procedure for selecting a setting item in the Function setting mode, see the following example:

Example: Adjusting the contrast of the display

1 Enter the Function setting mode

Press and hold the Control knob.

"Function" is displayed.

2 Select the Contrast function item

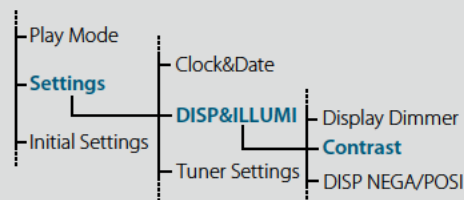

Turn the Control knob to select "Settings", and then press the Control knob.

Next, turn the Control knob to select "DISP&ILLUMI", and then press the Control knob.

Finally, turn the Control knob to select "Contrast", and then press the Control knob.

In this manual, the above operational procedure is described as follows:

2 Select the Contrast function item

Select the following items using the Control knob. **Refer**

"Settings" > "DISP&ILLUMI" > "Contrast"

Press the [↶] button to return to the previous item.



- Clicking **Refer** near the description of an operational procedure displays this page, allowing you to confirm how to use the Control knob.

3 Set the Contrast function

Turn the Control knob to select a value (1 - 30), and then press the Control knob.

The previous item is displayed.

4 Exit the Function setting mode

Press and hold the [↶] button.

About the notation "Contents"

Clicking "Contents" shown at the upper left of each page allows you to jump to the contents page.

Contents

Before use	4	General operation	32	SiriusXM Vehicle Connect Tuner Control (optional tuner and service required)	60
Component names	6	Adjusting the clock		Before use	
Audio adjustments	8	Adjusting the date		Basic operations	
Audio control		Dual clock display		Category and channel search	
Audio preset memory		Clock & date display type setting		Channel preset memory	
Audio preset recall		Auxiliary input display setting		Preset tuning	
iPod control operation	10	Muting the audio upon reception of a phone call		Channel scan	
Music search		Initial settings		Direct access tuning	
Alphabet search		Demonstration mode setting		Seek mode setting	
Related search		Registering a Bluetooth device	38	iTunes tagging	
Direct search		About registration of a Bluetooth device		Parental Lock setting	
Skip search		Simple Bluetooth device registration		Clearing the Parental Lock setting	
Skip search ratio setting		Registering a Bluetooth device by operating it		Setting Parental Lock for Mature contents	
Playback mode		Registering a Bluetooth device by operating this unit		Parental Lock pass code setting	
Pandora® internet radio control	14	Registering a special Bluetooth device		Content alert	
Listening to the Pandora® internet radio		Simple Bluetooth device selection		Content alert setting	
Basic operations		Selecting the Bluetooth device you wish to connect		Editing a Content alert item	
Station search		Deleting a registered Bluetooth device		Delete a Content alert item	
Bookmark registration		Bluetooth device registration test		Instant Replay	
Search and new station registration		Operation for hands-free phoning	44	Channel skip setting	
Deletion of station		Receiving a call		Clearing the channel skip setting	
Pandora source control		Calling a number in the phone book		SiriusXM tuner setting	
Music disc/Audio file (CD or USB) operation	18	Dialing a number		Remote control (Optional accessory) setup	72
Music search		Calling a number in the call log		Registering a remote control ID	
Skip search		Speed dialing (Preset dial)		Delete the remote control ID	
Playback mode		Registering in the preset dial number list		Basic operation of remote control	74
Direct music search		During a call		General control	
Tuner operation	20	Call waiting		On Tuner source	
Auto memory		Clearing the disconnection message		On HD Radio tuner source	
Tuner setting		Making a call by voice dialing		On CD/Audio file source	
Direct access tuning		Display of phone number types (categories)		On iPod source	
PTY (Program Type)		Bluetooth audio device operation	50	On Pandora internet radio source	
Program Type presetting		Before use		On SiriusXM tuner source	
HD Radio™ tuner control	24	Basic operations		Hands-free phone control	
Auto memory		Playback mode		Appendix	76
iTunes tagging		Switching between Bluetooth devices		Troubleshooting guide	78
HD Radio tuner setting		Bluetooth setup	52	Specifications	82
Direct access tuning		Registering the PIN code			
Display settings	28	Downloading the phone book			
Selecting a display type		Displaying the firmware version			
Selecting a text display		Bluetooth detail setting			
Information display setting		SMS (Short Message Service)	56		
Illumination color selection		Displaying the SMS			
Display & Illumination setting		Downloading the SMS			
		SMS reply setting			
		Return message setting			
		Creating an original message			

Before use

Before using the KDC-X896, KDC-BT852HD, KDC-X496, or KDC-452U for the first time

This unit is factory-set to operate in the Demonstration mode initially.

When using this unit for the first time, cancel the Demonstration mode. Refer to [<Exiting the Demonstration mode>](#) (page 4) in Quick Start Guide.

▲ WARNING

To prevent injuries or a fire, take the following precautions:

- Stop the car before operating the unit.
- To prevent a short circuit, never put or leave any metallic objects (such as coins or metal tools) inside the unit.

▲ CAUTION

- Adjust the volume so that you can hear the sound outside the car. Driving with the volume too high may cause an accident.
- Wipe off the dirt on the panel with a dry silicon or soft cloth.
- Failure to observe this precaution may result in damage to the monitor or unit.

Cleaning the connector

The unit may not function properly if the connectors between the unit and faceplate are dirty. Detach the faceplate and clean the connector with a cotton swab gently, being careful not to damage the connector.

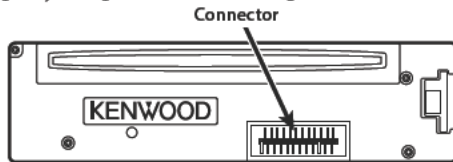

Condensation

When the car is air-conditioned, moisture may collect on the laser lens. This may cause disc read errors. In this case, remove the disc and wait for the moisture to evaporate.

Notes

- If you experience problems during installation, consult your Kenwood dealer.
- When you purchase optional accessories, check with your Kenwood dealer to make sure that they can work with your model and in your area.
- Characters that conform to ISO 8859-1 can be displayed.
- The illustrations of the display and panel appearing in this manual are examples used to explain more clearly how the controls are used. Therefore, what appears on the display in the illustrations may differ from what appears on the display on the actual equipment, and some of the images on the display may be inapplicable.

About the discs used with this unit

- This unit can only play the CDs with
- The following discs cannot be used:
 - A disc that is not round
 - A disc with coloring on the recording surface or a disc that is dirty
 - A recordable/rewritable disc that has not been finalized (For the finalization process, refer to the instruction manual that came with your disc writing software or your disc recorder.)
 - An 8 cm (3 inch) disc (An attempt to insert using an adapter can cause malfunction.)

Handling discs

- Do not touch the recording surface of the disc.
- Do not stick tape etc. on the disc, or use a disc with tape stuck on it.
- Do not use any accessories for the disc.
- Do not use any solvents to clean discs. Use a dry silicon or soft cloth.
- Clean the disc by moving the cloth outward from the center of the disc.
- When removing a disc from this unit, pull it out horizontally.
- If the center hole or outside rim of a disc has burrs, remove them before inserting a disc.

How to reset your unit

If the unit fails to operate properly, press the Reset button. The unit returns to the factory settings when the Reset button is pressed.

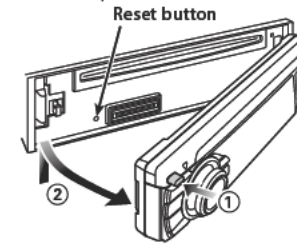

About the remote controls of KMR-550U

A maximum of 2 remote controls (KCA-RC107MR or KCA-RC55MR; optional accessory) can be used with the KMR-550U. For details on how to use the remote control, refer to the operation manual attached to it. When using the remote control with this unit, you should register the remote control ID. For details, refer to [<Registering a remote control ID>](#) (page 72).

Component names

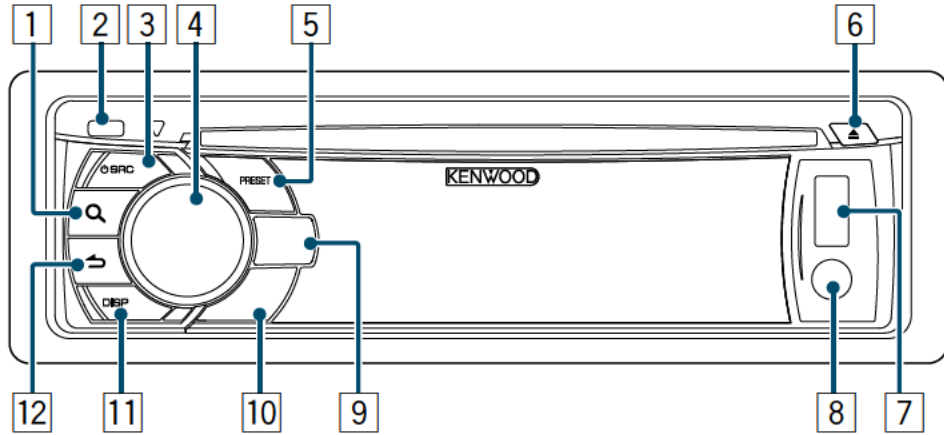

- 1 [Q] button
- 2 Release button
- 3 [SRC] button
- 4 Control knob
- 5 [PRESET] button
- 6 [▲] button
- 7 USB terminal
- 8 Auxiliary input
- 9 **KDC-X896** **KDC-BT852HD**
[☎][📶] button
KDC-X496 **KDC-452U** **KMR-550U**
[iPod] button
- 10 **KDC-X896** **KDC-BT852HD**
[P] button
KDC-X496 **KDC-452U** **KMR-550U**
[S.MODE] button
- 11 [DISP] button
- 12 [➡] button

Audio adjustments

Audio control

You can adjust the following audio control items;

Display	Audio setting item	Range
"SubWoofer Level"	Subwoofer level	-15 — +15 (dB)
"Bass Level"	Bass level	-8 — +8 (dB)
"Middle Level"	Middle level	-8 — +8 (dB)
"Treble Level"	Treble level	-8 — +8 (dB)
"Equalizer PRO"*		
"Bass Adjust"		
"Bass Center FRQ"	Bass Center Frequency	60/ 80/ 100/ 200 (Hz)
"Bass Level"	Bass level	-8 — +8 (dB)
"Bass Q Factor"	Bass Q Factor	1.00/ 1.25/ 1.50/ 2.00
"Bass EXT"	Bass Extend	OFF/ ON
"Middle Adjust"		
"Middle Center FRQ"	Middle Center Frequency	0.5/ 1.0/ 1.5/ 2.5 (kHz)
"Middle Level"	Middle level	-8 — +8 (dB)
"Middle Q Factor"	Middle Q Factor	0.75/ 1.00/ 1.25
"Treble Adjust"		
"Treble Center FRQ"	Treble Center Frequency	10.0/ 12.5/ 15.0/ 17.5 kHz
"Treble Level"	Treble level	-8 — +8 (dB)
"Preset Equalizer"	Preset Equalizer curve	"Rock"/"Pops"/"Easy"/ "Top40"/"Jazz"/ "Powerful"/"Natural"/ "User"*
"Bass Boost"	Bass Boost	"Level1"/"Level2"/ "Level3"/"OFF"
"Loudness"	Loudness	"Level1"/"Level2"/ "OFF"
"Balance"	Balance	Left 15 — Right 15
"Fader"	Fader	Rear 15 — Front 15
"SubWoofer"	Subwoofer output	OFF/ ON
"Detailed Settings"		
"HPF"	High Pass Filter	Through/ 100/ 120/ 150 (Hz)
"LPF SubWoofer"	Low Pass Filter	85/ 120/ 160/ Through (Hz)
"SubWoofer Phase"	Subwoofer Phase	Reverse (180°)/ Normal (0°)
"Supreme"	Supreme setting	ON/ OFF
"Audio Preset"	Audio Preset memory†	Recall/ Memory
"Volume Offset"	Volume offset	-8 — ±0 (dB) (AUX: -8 — +8)

*Function of KDC-X896/ KDC-X496.

†Refer to <Audio preset memory> (page 9), <Audio preset recall> (page 9).

User: The customized Bass, Middle, and Treble settings are effective.



- You can set Bass, Middle, and Treble levels for each source. About Supreme Technology to extrapolate and supplement with proprietary algorithm, the high-frequency range that is cut off when encoding at low bit rate (less than 128Kbps, Sampling frequency is 44.1kHz). Supplementing is optimized by a compression format (AAC, MP3 or WMA) and processed according to bit rate. The effect is negligible with music that is encoded at high bit rate or variable bit rate or music that has a minimal high frequency range.

- Select the source to adjust**
Press the [SRC] button.
- Enter the Audio control mode**
Press the Control knob.
- Select the audio item subject to adjustment**
Turn the Control knob to select the audio item subject to adjustment and then press the Control knob.
Press the [↵] button to return to the previous item.
- Adjust the value set for the selected audio item**
Turn the Control knob to display the value to adjust, and then press the Control knob.
The previous item is displayed.
- Exit the Audio control mode**
Press and hold the [↵] button.

Audio preset memory

You can register the values set the Audio control items.

- Set the audio control items**
Refer to <Audio control> (page 8).
- Enter the Audio control mode**
Press the Control knob.
- Select the Audio preset memory mode**
Select the following items using the Control knob. **Refer**
"Detailed Settings" > "Audio Preset"
- Select the Audio preset memory**
Turn the Control knob to select "Memory", and then press the Control knob.
- Determine the selection**
Turn the Control knob to select "YES", and then press the Control knob.
"Memory Completed" is displayed.
- Exit the Audio Control mode**
Press and hold the [↵] button.



- Register a pair of Audio preset memories. You cannot register them by source.
- When you press the [Reset] button, audio control values of all sources will be set to the values registered here.
- The following Audio control items can be registered.
"Bass Center FRQ"*, "Bass Level", "Bass Q Factor"*, "Bass EXT"*, "Middle Center FRQ"*, "Middle Level", "Middle Q Factor"*, "Treble Center FRQ"*, "Treble Level", "SubWoofer Level", "HPF", "LPF SubWoofer", "SubWoofer Phase"
*KDC-X896, KDC-X496 only

Audio preset recall

You can recall the Audio control items registered to the <Audio preset memory> (page 9).

- Select a source**
Press the [SRC] button.
- Enter the Audio control mode**
Press the Control knob.
- Select the Audio preset memory mode**
Select the following items using the Control knob. **Refer**
"Detailed Settings" > "Audio Preset"
- Select the Audio preset recall**
Turn the Control knob to select "Recall", and then press the Control knob.
- Determine the selection**
Turn the Control knob to select "YES", and then press the Control knob.
"Recall Completed" is displayed.
- Exit the Audio Control mode**
Press and hold the [↵] button.

iPod control operation

For the basic operations to play iPod contents, refer to the Quick Start Guide.

Music search

You can search for the song you want to play.

- 1 Enter the Music search mode**
Press the [Q] button.
"MUSICSEARCH" is displayed.

2 Search for a song

Operation type	Operation
Movement between items	Turn the Control knob.
Move to the Alphabet search mode	Press and hold the [Q] button. Refer to <Alphabet search> (page 10).
Selection of item	Press the Control knob.
Return to previous item	Press the [↵] button.
Return to Top menu	Push and hold the Control knob leftward.

Canceling the Music search mode

Press and hold the [↵] button.



- If no characters included in a song name can be displayed, the browse item name and digits are displayed.

Items	Display	Items	Display
Playlists	"PLIST****"	Podcasts	"PDC****"
Artists	"ART****"	Genres	"GEN****"
Albums	"ALB****"	Composers	"COM****"
Songs	"PRGM****"		

Alphabet search

You can select an alphabetic character from the list in the browse item (artist, album, etc.) currently selected.

- 1 Enter the Music search mode**
Press the [Q] button.
"MUSICSEARCH" is displayed.
- 2 Enter the Search select mode**
KDC-X896 | KDC-BT852HD
Press the [Q] button.
KDC-X496 | KDC-452U | KMR-550U
Press the [S.MODE] button.
- 3 Select the Alphabet search mode**
Turn the Control knob to select "Alphabet Search", and then press the Control knob.

4 Search for characters

Operation type	Operation
Selection of characters	Turn the Control knob.
Determination of the selected characters.	Press the Control knob.

Return to the Music search mode.

Canceling the Alphabet search mode

Press and hold the [↵] button.



- Turning the Control knob fast in the Music search mode allows you to enter the alphabet search mode.
- The time of Alphabet search may become long depending on the number of items (songs) in iPod.
- To search for a character other than A to Z and 1, enter "**".
- If the first character string begins with an article "a", "an", or "the" in the alphabet search mode, it is searched for in defiance of the article.

Related search

You can browse for music of the same artist or genre as the one being played.

- 1 Enter the Search select mode**
KDC-X896 | KDC-BT852HD
Press and hold the [Q] button.
KDC-X496 | KDC-452U | KMR-550U
Press the [S.MODE] button.
- 2 Select the Related search mode**
Turn the Control knob to select "Related Search", and then press the Control knob.
- 3 Select a desired brows item**
Turn the Control knob to select a browse item, and then press the Control knob.

Display	Browse item
"Search Artist"	Displays the album of the same artist.
"Search Album"	Displays music in the album in which the one being played is included.
"Search Genre"	Displays the artist of the same genre.
"Search Composer"	Displays the album including music created by the same composer.

4 Search for music

Operation type	Operation
Movement between items	Turn the Control knob.
Selection of item	Press the Control knob.
Return to previous item	Press the [↵] button.

Canceling the Related search mode

Press and hold the [↵] button.



- Related search cannot be performed during Podcast playback.
- When the music being played has no information on the browse item or no music was found, "Not Found" is displayed.

Direct search

You can search for music by selecting a browse item and an alphabetic character(s).

- 1 Enter the Music search mode**
Press the [Q] button.
"MUSICSEARCH" is displayed.
- 2 Enter the Search select mode**
KDC-X896 | KDC-BT852HD
Press the [Q] button.
KDC-X496 | KDC-452U | KMR-550U
Press the [S MODE] button.
- 3 Select Direct search mode**
Turn the Control knob to select "Direct Search", and then press the Control knob.
- 4 Select a browse item**
Turn the Control knob to select browse item, and then press the Control knob.

Display	Browse item
"PLAYLISTS"	Playlists
"ARTISTS"	Artists
"ALBUMS"	Albums
"SONGS"	Songs
"PODCASTS"	Podcasts
"GENRES"	Genres
"COMPOSERS"	Composers

- 5 Select the character(s) to be searched for**
Turn the Control knob to select a character(s), and then press the Control knob.
You can select up to three characters.
 - 6 Search for music**
Turn the Control knob to select "DONE", and then press the Control knob.
A search result list is displayed.
 - 7 Select the music**
Turn the Control knob to select music, and then press the Control knob.
- Canceling the Direct search mode**
Press and hold the [↵] button.

iPod control operation

Skip search

You can search for a song by skipping songs at the set skip search ratio (the ratio of the number of songs to skip to the total number of songs in the selected list)

1 Enter the Music search mode

Press the [Q] button.
"MUSICSEARCH" is displayed.

2 Enter the Search select mode

KDC-X896 **KDC-BT852HD**
Press the [Q] button.
KDC-X496 **KDC-452U** **KMR-550U**
Press the [S MODE] button.

3 Select Skip search mode

Turn the Control knob to select "Skip Search", and then press the Control knob.

4 Search for music

Operation type	Operation
Movement between items	Turn the Control knob.
Skip Search	Push the Control knob upward or downward.
Selection of item	Press the Control knob.
Setting of skip search ratio	Push the Control knob rightward or leftward.

Canceling the Music search mode

Press and hold the [↵] button.



- The skip search ratio is set to 0.5% as default. Refer to <Skip search ratio setting> (page 12).
- Press and hold the Control knob to skip songs at 10% regardless of the setting.

Skip search ratio setting

You can change the ratio of skip performed as mentioned in <Skip search> (page 12).

1 Select the iPod source

Press the [SRC] button.
Select the "iPod" display.

2 Enter the Function setting mode

Press and hold the Control knob.

3 Select the Skip search ratio item

Select the following items using the Control knob. **Refer**
"Settings" > "Skip Search"

4 Set a Skip search ratio

Turn the Control knob to select a ratio ("0.5%", "1%", "5%", or "10%"), and then press the Control knob.

5 Exit the Function setting mode

Press and hold the [↵] button.

Playback mode

You can select a playback mode, such as Random play and Repeat play.

1 Select the iPod source

Press the [SRC] button.
Select the "iPod" display.

2 Enter the Function setting mode

Press and hold the Control knob.

3 Select the Play mode

Turn the Control knob to select "Play Mode", and then press the Control knob.

4 Select a desired playback mode function

Turn the Control knob to select playback mode function, and then press the Control knob.

Display	Description
"Play Mode"	
"APP & iPod Mode"	When set to "ON", allows you to operate the iPod with the control on the iPod. "ON" / "OFF"
"Folder Random"	When set to "ON", plays the songs in the folder randomly. (Music only) "ON" / "OFF"
"All Random"	When set to "ON", plays all songs in the iPod randomly. (Music only) "ON" / "OFF"
"File Repeat"	When set to "ON", plays the song repeatedly. "ON" / "OFF"

(_ : Factory setting)

5 Determine the selection

Press the Control knob.
The previous item is displayed.

6 Exit the Function setting mode

Press and hold the [↵] button.



- When "APP & iPod Mode" is set to "ON", this unit can control only the "Pause and play", "Selecting a song", and "Fast Forward or Fast Backward of the Song" functions.

Pandora® internet radio control

Listening to the Pandora® internet radio

You can listen to the Pandora® internet radio on this unit by controlling the application installed in the iPhone or Bluetooth device.

1 Connect your iPhone/Bluetooth device to this unit

Use the KCA-iP102 (optional accessory) to connect the iPhone to this unit.

If no iPhone is connected, connect a Bluetooth device using A2DP. (KDC-X896/ KDC-BT852HD only)

Make sure that the home screen is displayed on the iPhone.

Make sure that the Pandora internet radio application has started on the Bluetooth device.

2 Select the Pandora source

KDC-X896 | KDC-BT852HD

Press the [P] button.

KDC-X496 | KDC-452U | KMR-550U

Press the [SRC] button.

Select the "Pandora"/"P" display.

On the iPhone, the Pandora internet radio application starts automatically.



- If your iPhone is connected using a KCA-iP102, you cannot listen to the Pandora Internet radio via a Bluetooth device.
- For how to register the Bluetooth device, refer to <Registering a Bluetooth device> (page 38).
- If the version of the OS of the connected iPhone is earlier than 4.0, start the Pandora internet radio application before selecting the Pandora source.

Basic operations

Pause and Play

Press the [↔] button to interrupt or resume playback.

Thumbs up

Press and hold the [PRESET] button.

"👍" is displayed.

Thumbs down

KDC-X896 | KDC-BT852HD

Press and hold the [P] button.

KDC-X496 | KDC-452U | KMR-550U

Press and hold the [S.MODE] button.

"👎" is displayed.

The current song is skipped

Song skip

Push the Control knob rightward.

If the skip count limit specified by Pandora is exceeded, "No skips remaining" is displayed.

Station search

You can select the station you want to listen to from your station list.

1 Select the Pandora source

KDC-X896 | KDC-BT852HD

Press the [P] button.

KDC-X496 | KDC-452U | KMR-550U

Press the [SRC] button.

Select the "Pandora"/"P" display.

2 Enter the Station List mode

Press the [Q] button.

"Station List" is displayed.

3 Select a sort type

Turn the Control knob to select "A-Z" (stations are displayed in alphabetical order) or "By Date" (stations are displayed in date order), and then press the Control knob.

A station list is displayed.

4 Select a desired station

Turn the Control knob to select your desired station, and then press the Control knob.



- The 🎵 indicator is displayed for the station you are listening to.

Bookmark registration

You can register the current song information or artist information in Bookmark.

1 Select the Pandora source

KDC-X896 | KDC-BT852HD

Press the [P] button.

KDC-X496 | KDC-452U | KMR-550U

Press the [SRC] button.

Select the "Pandora"/"P" display.

2 Enter the Function setting mode

Press and hold the Control knob.

3 Select the Bookmarks item

Turn the Control knob to select "Bookmarks", and then press the Control knob.

4 Select an information type

Turn the Control knob to select "Bookmark Song" (to register song information) or "Bookmark Artist" (to register artist information), and then press the Control knob. "Adding bookmark" is displayed. The information about the song you are listening to now is added to the bookmark.



- This unit allows you to bookmark songs and/or artists in your personalized Pandora® account. The bookmarks will not be available for review on the unit but will be available in your Pandora® account.

Pandora® internet radio control

Search and new station registration

You can search for a desired station by specifying its character. You can register the displayed station as a new station in your station list.

1 Select the Pandora source

KDC-X896 **KDC-BT852HD**

Press the [**P**] button.

KDC-X496 **KDC-452U** **KMR-550U**

Press the [SRC] button.

Select the "Pandora"/"P" display.

2 Enter the Function setting mode

Press and hold the Control knob.

3 Select the New Stations item

Turn the Control knob to select "New Stations", and then press the Control knob.

4 Select the character to be searched for

Operation type	Operation
Selection of characters	Turn the Control knob.
Determination of the selected characters.	Press the Control knob.
Select the column	Push the Control knob rightward or leftward.

Up to 5 characters can be entered.

5 Start station search

Turn the Control knob to select "DONE", and then press the Control knob.

Station search starts.

6 Select a desired station

Turn the Control knob to select a station, and then press the Control knob.

The broadcast from the selected station is received and the station is registered in the station list.

Canceling the Function setting mode

Press and hold the [**↵**] button.

Deletion of station

You can delete registered station information from your station list.

1 Select the Pandora source

KDC-X896 **KDC-BT852HD**

Press the [**P**] button.

KDC-X496 **KDC-452U** **KMR-550U**

Press the [SRC] button.

Select the "Pandora"/"P" display.

2 Enter the Function setting mode

Press and hold the Control knob.

3 Select the Station delete item

Turn the Control knob to select "Station Delete", and then press the Control knob.

4 Select a sort type

Turn the Control knob to select "A-Z" (stations are displayed in alphabetical order) or "By Date" (stations are displayed in date order), and then press the Control knob.

A station list is displayed.

5 Select the station to delete

Turn the Control knob to select a station, and then press the Control knob.

6 Determine the selection

Turn the Control knob to select "YES", and then press the Control knob.

"Completed" is displayed.

Canceling the Function setting mode

Press and hold the [**↵**] button.

Pandora source control

You can turn on/off the Pandora source.

1 Select the Standby

Press the [SRC] button.

Select the "STANDBY" display.

2 Enter the Function setting mode

Press and hold the Control knob.

3 Select the Pandora source control item

Select the following items using the Control knob. [Refer](#)

"Initial Settings" > "Pandora Source"

4 Select a Pandora source control method

Turn the Control knob to select a control method, and then press the Control knob.

Display	Description
"ON"	Turns on the Pandora source.
"OFF"	Turns off the Pandora source.

5 Exit the Function setting mode

Press and hold the [**↵**] button.

Music disc/Audio file (CD or USB) operation

For the basic operations to play Music disc/Audio file contents, refer to the Quick Start Guide.

Music search

You can select the music you want to listen to from the device or media being played now.

1 Enter the Music search mode

Press the [Q] button.

"MUSICSEARCH" is displayed.

2 Search for music

Audio file

Operation type	Operation
Movement between folders/files	Turn the Control knob.
Selection of folder/file	Press the Control knob.
Return to previous folder	Press the [↵] button.
Return to root folder	Push and hold the Control knob leftward.
Cancellation of Music search mode	Press and hold the [↵] button.

🎵 indicator: Audio file

📁 indicator: Folder

CD source

Operation type	Operation
Movement between track	Turn the Control knob.
Selection of track	Press the Control knob.
Return to first track	Push and hold the Control knob leftward.
Cancellation of Music search mode	Press the [↵] button.

Music Editor media

Skip search

You can search for a song by skipping songs at the set skip search ratio (the ratio of the number of songs to skip to the total number of songs in the selected list).

1 Enter the Music search mode

Press the [Q] button.

"MUSICSEARCH" is displayed.

2 Enter the Search select mode

Press the [Q] button.

3 Select the Skip search mode

Turn the Control knob to select "Skip Search", and then press the Control knob.

4 Search for music

Operation type	Operation
Movement between items	Turn the Control knob.
Skip search	Push the Control knob upward or downward.
Selection of item	Press the Control knob.
Setting of skip search ratio	Push the Control knob rightward or leftward.

Canceling the Music search mode

Press and hold the [↵] button.



- The skip search ratio is set to 0.5% as default. Refer to <Skip search ratio setting> (page 12).
- Press and hold the Control knob to skip songs at 10% regardless of the setting.

Playback mode

You can select a playback mode, such as Random play and Repeat play.

1 Select the CD/ USB source

Press the [SRC] button.

Select the "CD" or "USB" display.

2 Enter the Function setting mode

Press and hold the Control knob.

3 Select the Playback function mode

Turn the Control knob to select "Play Mode", and then press the Control knob.

4 Select a desired playback mode

Turn the Control knob to select a playback mode, and then press the Control knob.

Display	Description
"Play Mode"	
"Track Scan" (CD)/ "File Scan" (Audio file)	When set to "ON", plays the intros of the songs in the CD/folder successively. "ON" / "OFF"
"Disc Random" (CD)/ "Folder Random" (Audio file)	When set to "ON", plays the songs in the CD/folder randomly. "ON" / "OFF"
"All Random" (Audio file)	When set to "ON", plays all songs in the disc/USB randomly. "ON" / "OFF"
"Track Repeat" (CD)/ "File Repeat" (Audio file)	When set to "ON", plays the selected song repeatedly. "ON" / "OFF"
"Folder Repeat" (Audio file)	When set to "ON", plays the songs in the folder repeatedly. "ON" / "OFF"

(_ : Factory setting)

5 Exit the Function setting mode

Press and hold the [↵] button.

Function of KDC-X896/ KDC-BT852HD/ KDC-X496/ KDC-452U with remote control

Direct music search

You can search for music by entering the track number.

1 Enter the Direct Music search mode

Press the [DIRECT] button on the remote control.

"- -" is displayed.

2 Enter the music number

Press the number buttons on the remote control.

3 Search for music

Press the [◀◀] or [▶▶] button on the remote control.

Canceling the Direct music search mode

Press the [↵] button on the remote control.

Tuner operation

For the basic operations to listen to the radio, refer to the Quick Start Guide.

Auto memory

You can register 18 (FM)/ 6 (AM) stations with good reception automatically.

- 1 Select the Tuner source**
Press the [SRC] button.
Select the "TUNER" display.
- 2 Enter the Function setting mode**
Press and hold the Control knob.
- 3 Select the Auto memory function item**
Select the following items using the Control knob. **Refer**
"Settings" > "Auto Memory"
- 4 Start storing stations in the Auto memory mode**
Turn the Control knob to select "YES", and then press the Control knob.
When 18 (FM)/ 6 (AM) stations that can be received are stored in the memory, the process in this mode is completed.

Tuner setting

You can set up the tuner.

- 1 Select the Tuner source**
Press the [SRC] button.
Select the "TUNER" display.
- 2 Enter the Function setting mode**
Press and hold the Control knob.
- 3 Select the Settings item**
Turn the Control knob to select "Settings", and then press the Control knob.
- 4 Select a desired Tuner setting item**
Turn the Control knob to select Tuner setting item, and then press the Control knob.

Display	Description
"Settings"	
"Seek Mode"	Sets the tuning mode. Auto1: Automatic search for a station. Auto2: Search in order of the stations in the preset memory. Manual: Normal manual tuning.
"MONO"	You can reduce the noise when stereo broadcasts are received as monaural. "ON" / "OFF"
"TI"	Switches to the traffic information automatically when the traffic bulletin starts. "ON" / "OFF"

(_ : Factory setting)

- 5 Select a setting and determine it**
Turn the Control knob to select a desired tuner setting, and then press the Control knob.
The previous item is displayed.
- 6 Exit the Function setting mode**
Press and hold the [↵] button.

Function of KDC-X896/ KDC-BT852HD/ KDC-X496/ KDC-452U with remote control

Direct access tuning

You can search for a station directly by entering frequency.

- 1 Enter the Direct access tuning mode**
Press the [DIRECT] button on the remote control.
"----" is displayed.

- 2 Enter the frequency**
Press the number buttons on the remote control.
Example:

Desired frequency	Press the following buttons
92.1 MHz (FM)	[9], [2], [1]
810 kHz (AM)	[8], [1], [0]

- 3 Search for the frequency**
Press the [◀◀] or [▶▶] button on the remote control.

Canceling Direct access tuning mode

Press the [↵] button on the remote control.

Tuner operation

PTY (Program Type)

You can search for a station by selecting a Program Type.

Program Type	Display	Program Type	Display
Speech	"Speech"	Classical	"Classical"
Music	"Music"	R & B	"R & B"
News	"News"	Soft R & B	"Soft R&B"
Information	"Inform"	Language	"Language"
Sports	"Sports"	Religious Music	"Rel Musc"
Talk	"Talk"	Religious Talk	"Rel Talk"
Rock	"Rock"	Personality	"Persnlty"
Classic Rock	"Cls Rock"	Public	"Public"
Adult Hits	"Adlt Hit"	College	"College"
Soft Rock	"Soft Rck"	Spanish Talk	"Habl Esp"
Top 40	"Top 40"	Spanish Music	"Musc Esp"
Country	"Country"	Hip-Hop	"Hip hop"
Oldies	"Oldies"	Weather	"Weather"
Soft	"Soft"		
Nostalgia	"Nostalga"		
Jazz	"Jazz"		

- Speech and music include the following types of programs.
Speech: Program type indicated by white letters
Music: Program type indicated by black letters

- 1 Enter the PTY mode**
Press the [Q] button.
- 2 Select a Program Type**
Turn the Control knob.
- 3 Search for the station broadcasting the selected Program Type station**
Push the Control knob rightward or leftward.
- 4 Exit the PTY mode**
Press the [↵] button.



- This function cannot be used during reception of a traffic bulletin or AM broadcast.
- When the selected Program Type is not found, "No PTY" is displayed. Select another Program Type.

Program Type presetting

You can store a Program Type in the Preset button memory and recall it quickly.

- 1 Select the Program Type to preset**
Refer to <PTY (Program Type)> (page 22).
- 2 Enter the Program Type preset mode**
Press the [PRESET] button.
- 3 Select a number and store it in the memory**
Turn the Control knob to select a memory number ("1" – "6"), and then press and hold the Control knob.

Canceling the Preset memory mode
Press the [↵] button.

Recalling a preset Program Type

- 1 Enter the PTY mode**
Press the [Q] button.
- 2 Enter the Preset memory mode**
Press the [PRESET] button.
- 3 Select the number you want to recall from the memory**
Turn the Control knob to select a recall number ("1" – "6"), and then press the Control knob.

HD Radio™ tuner control

For the basic operations to listen to the HD Radio tuner, refer to the Quick Start Guide.



PSD

- Program Service Data: Contributes to the superior user experience of HD Radio Technology. Presents song name, artist, station IDs, HD2/HD3 Channel Guide, and other relevant data streams.

HD2/HD3

- Adjacent to traditional main stations are extra local FM channels. These HD2/HD3 Channels provide new, original music as well as deep cuts into traditional genre.

Digital Sound

- Digital, CD-quality sound. HD Radio Technology enables local radio stations to broadcast a clean digital signal. AM sounds like today's FM and FM sounds like a CD.

iTunes® Tagging

- iTunes® Tagging provides you the opportunity to discover a wide range of content and the means to "tag" that content for later review and purchase from the iTunes® Store.

Auto memory

You can automatically store 18 (FM)/ 6 (AM) stations with good reception in the memory.

- 1 Select the Tuner source**
Press the [SRC] button.
Select the "HD RADIO" display.
- 2 Enter the Function setting mode**
Press and hold the Control knob.
- 3 Select the Auto memory mode**
Select the following items using the Control knob. [Refer](#)
"Settings" > "Auto Memory"
- 4 Start storing stations in the Auto memory mode**
Turn the Control knob to select "YES"; and then press the Control knob.
When 18 (FM)/ 6 (AM) stations that can be received are stored in the memory, the process in the Auto memory is completed.

iTunes tagging

You can store the tag of the information about the song being received, and send it to the connected iPod. You can easily find the song on the iTunes Store according to the tag sent to the iPod.

- 1 Store the song information tag**
Press and hold the [PRESET] button.
"TAG" will be indicated on the display when song information can be registered.
"TAG Storing" is indicated on the display while a tag is being stored in this unit. "TAG Stored" is indicated on the display after the tag has been stored.
When your iPod is connected to this unit, "TAG Transferred" is indicated on the display and the tag is sent to the iPod.



- The song corresponding to the tag sent to the iPod is indicated in the playlist of the synchronized iTunes or iPod. By clicking your desired song in the playlist, you can easily find it on the iTunes Store and buy it from the iTunes Store.
- A total of fifty song information tags can be stored in this unit including the song information tags stored by the SiriusXM tuner function mentioned in <iTunes tagging> (page 64). When a tag has been sent to the iPod, the tag stored in this unit is cleared.
- Select "ON" for "Tagging" as mentioned in <HD Radio tuner setting> (page 25) when using this function.
- The memory usage can be checked by selecting the "TAG Memory" setting mentioned in <HD Radio tuner setting> (page 25).

HD Radio tuner setting

You can set the HD Radio tuner-related items.

- 1 Enter the Function setting mode**
Press and hold the Control knob.
- 2 Select the Setting mode**
Turn the Control knob to select "Settings", and then press the Control knob.
- 3 Select a desired HD Radio tuner setting item**
Turn the Control knob to select a HD Radio tuner setting item, and then press the Control knob.

Display	Description
"Settings"	
"Seek Mode"	Sets the HD Radio tuning mode. Auto1: Automatic search for a station. Auto2: Search in order of the stations in the preset memory. Manual: Normal manual tuning control.
"Receive mode"	Sets the HD Radio receive mode. Auto: Automatically tunes to an analog broadcast when there is no digital broadcast. Digital: Digital broadcasts only. Analog: Analog broadcasts only.
"TAG Memory"	Displays the tag memory usage of the HD Radio tuner and SiriusXM tuner. Up to 50 tags can be registered in this unit.
"Tagging"	Turns ON / OFF the iTunes tag memory function of HD Radio tuner. "ON" / "OFF"

(_ : Factory setting)

- 4 Select a setting and determine**
Turn the Control knob to select a desired setting, and then press the Control knob.
The previous item is displayed.
- 5 Exit the Function setting mode**
Press and hold the [↵] button.

HD Radio™ tuner control

Function of remote control

Direct access tuning

You can tune to a station directly by entering its frequency or channel.

- 1 Enter the Direct access tuning mode**
Press the [DIRECT] button on the remote control.

"----" is displayed.

- 2 Select a direct access tuning method**
Press the [DIRECT] button on the remote control.

Pressing the [DIRECT] button each time switches among direct access tuning methods as follows.

Tuning method	Display
Frequency	"----"
Channel	"HD --"
Canceling Direct Access Tuning	—

- 3 Enter the frequency or channel**
Press the number buttons on the remote control.

Example of frequency input:

Desired frequency	Press button
92.1 MHz (FM)	[9], [2], [1]
810 kHz (AM)	[8], [1], [0]

- 4 Do Direct access tuning**
Press the [◀◀] or [▶▶] button on the remote control.

Canceling the Direct access tuning mode

Press the [↶] button on the remote control.

Display settings

Selecting a display type

Shown below are examples of display types.

Display type	Display information
Type A	Displays 3 lines of text.
Type B	Displays 2 line of text.
Type C	Displays the clock.
Type D	Displays the Motion graphics.
Type E*	Turn off the display and key illumination. (5 seconds after completion of operation)

*Function of KDC-X896, KDC-BT852HD, KDC-X496, KDC-452U

- 1 Enter the Function setting mode**
Press and hold the Control knob.
- 2 Select the Display type select item**
Select the following items using the Control knob. **Refer**
"Settings" > "DISP&ILLUMI" > "Display Select" > "Type Select"
- 3 Select the display type**
Turn the Control knob to select a display type, and then press the Control knob.
- 4 Exit the Function setting mode**
Press and hold the [↵] button.

Selecting a text display

You can change the information displayed on each of the following sources:

On Audio file/ iPod source

Information	Display
Song title*	"Song Title"
Album name*	"Album Name"
Artist name*	"Artist Name"
Title and Artist name**	"Title/Artist"
Album and Artist name**	"Album/Artist"
Folder name	"Folder Name"
File name	"File Name"
Play time	"P-Time"
Clock	"Clock"
Date	"Date"
Blank	"Blank"

On Pandora source

Information	Display
Song title	"Song Title"
Artist name	"Artist Name"
Album name	"Album Name"
Title and Artist name**	"Title/Artist"
Album and Artist name**	"Album/Artist"
Station name	"Station Name"
Play time	"P-Time"
Clock	"Clock"
Date	"Date"
Blank	"Blank"

On CD source

Information	Display
Disc title	"Disc Title"
Track title	"Track Title"
Play time	"P-Time"
Clock	"Clock"
Date	"Date"
Blank	"Blank"

Function of KDC-X896, KDC-BT852HD

On HD Radio tuner source

Information	Display
Frequency	"Frequency"
Station name	"Station Name"
Artist name*	"Artist Name"
Song title*	"Song Title"
Album name*	"Album Name"
Artist name and Song title**	"Artist/Title"
Artist name and Album name**	"Artist/Album"
Clock	"Clock"
Date	"Date"
Blank	"Blank"

Function of KDC-X496, KDC-452U, KMR-550U

On Tuner source

Information	Display
Frequency & Program Service name (FM)	"Frequency/PS"
Song title (FM)*	"Song Title"
Artist name (FM)*	"Artist Name"
Title & Artist name (FM)**	"Title/Artist"
Station name (FM)	"Station Name"
Radio text + (FM)	"Radio Text +"
Radio text (FM)	"Radio Text"
Frequency (AM)	"Frequency"
Clock	"Clock"
Date	"Date"
Blank	"Blank"

Function of KDC-X896, KDC-BT852HD

On Bluetooth audio source

Information	Display
Source name	"Source Name"
Song title*	"Song Title"
Album name*	"Album Name"
Artist name*	"Artist Name"
Song title and Artist name**	"Title/Artist"
Album name and Artist name**	"Album/Artist"
Clock	"Clock"
Date	"Date"
Blank	"Blank"

On Standby/ Auxiliary input source

Information	Display
Source name (AUX only)	"Source Name"
Clock	"Clock"
Date	"Date"
Blank	"Blank"

On SiriusXM (Optional accessory) source

Information	Display
Channel number	"Channel Number"
Channel name	"Channel Name"
Artist name*	"Artist Name"
Song title*	"Song Title"
Content information*	"Content Info"
Artist name/Song title/Content information**	"Art/Song/Info"
Category name	"Category Name"
Clock	"Clock"
Date	"Date"
Blank	"Blank"

*Display type A only

**Display type B only

- 1 Enter the Function setting mode**
Press and hold the Control knob.
- 2 Select the Text select item**
Select the following items using the Control knob. **Refer**
"Settings" > "DISP&ILLUMI" > "Display Select" > "Text Select"
- 3 Select the text display part**
Push the Control knob upward or downward.
The selected text display part blinks.
- 4 Determine the selection**
Turn the Control knob.
- 5 Exit the Function setting mode**
Press and hold the [↵] button.



- If the selected display item does not have any information, alternative information is displayed.
- Setting is available when the display type is A or B which allows text display. Refer to [Selecting a display type](#) (page 28).
- Some items cannot be selected depending on the display type and row.
- If you select "Folder name" while playing music on the iPod, names will be displayed depending on the currently selected browsing items.
- If you select the APP & iPod Control mode while playing music on the iPod, "APP & iPod Mode" is displayed.
- If all characters cannot be displayed while music is played on the iPod, the file number in the list is displayed.

Information	Display
Music title	"TITLE****"
Folder name	"FLD****"
File name	"FILE****"

Display settings

Information display setting

You can set the side and graphic parts of the display.

1 Enter the Function setting mode

Press and hold the Control knob.

2 Select the Display select item

Select the following items using the Control knob. **Refer**
 "Settings" > "DISP&ILLUMI" > "Display Select"

3 Select a desired Information display setting item

Turn the Control knob to select a display setting item, and then press the Control knob.

Display	Description
"Display Select"	
"Side Select"	Sets the side part display for Type A, B, and D. 1 / 2 / 3 (Type A, B only)
"Graphic Select"	Sets the Type C clock display. 1 / 2
"Status"	Sets the status display (ON/OFF indicator for each function) for Type A and B. "ON" / "OFF"

(_ : Factory setting)

4 Select a setting and determine it

Turn the Control knob to select a desired setting, and then press the Control knob.

The previous item is displayed.

5 Exit the Function setting mode

Press and hold the [↵] button.

Function of KDC-X896/ KDC-BT852HD/ KDC-X496/ KDC-452U

Illumination color selection

You can select the illumination color of the panel.

1 Enter the Function setting mode

Press and hold the Control knob.

2 Select the Color select item

Select the following items using the Control knob. **Refer**
 "Settings" > "DISP&ILLUMI" > "Color Select"

3 Select the part for which you want to set the illumination color

Display	Part
"Color Select"	
"Color SEL All"	All
"Color SEL Display"	Display
"Color SEL Key"	Button
"Color SEL USB&AUX"	USB terminal and Auxiliary input

Turn the Control knob to select a part, and then press the Control knob.

4 Select an illumination color

Turn the Control knob to select a color, and then press the Control knob.

Select a color from "Variable Scan"/ "Color1" — "Color24".

Adjusting the RGB values

In this step, you can also create your original color during the selection from "Color1" — "Color24". The color you created can be called by selecting "User".

1. Press and hold the Control knob.

Enter the Detail color adjustment mode.

2. Set the color.

Operation type	Operation
To select the color to adjust (Red, Green, or Blue)	Push the Control knob rightward or leftward.
To adjust color (Range: 0 – 9)	Turn the Control knob.

3. Press the Control knob.

Exit the Detail color adjustment mode.

5 Exit the Function setting mode

Press and hold the [↵] button.

Display & Illumination setting

You can set the display and illumination.

1 Enter the Function setting mode

Press and hold the Control knob.

2 Select the Display & Illumination setting item

Select the following items using the Control knob. **Refer**
 "Settings" > "DISP&ILLUMI"

3 Select a desired Display & Illumination setting item

Turn the Control knob to select a Display & Illumination setting item, and then press the Control knob.

Display	Description
"DISP&ILLUMI"	
"DISP ILLUMI OFF"	When "Type E" (Display off) is selected in <Selecting a display type> (page 28), sets whether to turn off the display only or both the display and key illumination. "DISP&ILLUMI" / "DISP"
"Display Dimmer"	Dims the display part in conjunction with the Light switch of the vehicle. "Auto": Dims the display in conjunction with the Light switch of the vehicle. "Manual1": Dims the display constantly. "Manual2": Dims the display darker than that in the Manual1 mode. "OFF": Does not dim the display.
"Contrast"	Sets the display contrast. "1" – "10" – "30"
"DISP NEGA/POSI"	Switches the panel display between positive and negative modes. "NEGA1": Displays the text in the negative mode. "NEGA2": When the interior light is off, the text is displayed in the negative mode; when the interior light is on, the text is displayed in the positive mode. "POSI1": Displays the text in the positive mode. "POSI2": When the interior light is off, the text is displayed in the positive mode; when the interior light is on, the text is displayed in the negative mode.
"Text Scroll"	Sets the method of scrolling to view hidden texts. "Auto": Scrolls. "Once": Scrolls once. "OFF": Does not scroll.

"BT DVC Status"	You can display the connection status, signal strength, and battery level. [BT] : Battery level of cell-phone. [S] : Signal strength of cell-phone. (Function of KDC-X896/ KDC-BT852HD)
"ILLUMI Dimmer"	Reduces the key illumination brightness. "Auto": Dims the illumination in conjunction with the Light switch of the vehicle. "Manual1": Dims the illumination constantly. "Manual2": Dims the illumination darker than that in the Manual1 mode. "OFF": Does not dim the illumination.
"ILLUMI Effect"	Sets whether the key illumination is changed in conjunction with the key operation. "ON" / "OFF"

(_ : Factory setting)

4 Determine the Display & Illumination setting

Turn the Control knob to select a desired setting, and then press the Control knob.

The previous item is displayed.

5 Exit the Function setting mode

Press and hold the [↵] button.

General operation

Adjusting the clock

- 1 Enter the Function setting mode**
Press and hold the Control knob.
- 2 Select the Clock Adjust item**
Select the following items using the Control knob. **Refer**
"Settings" > "Clock&Date" > "Clock Adjust"
- 3 Set the hour**
Turn the Control knob to adjust the hour, and then press the Control knob.
- 4 Set the minute**
Turn the Control knob to adjust the minute, and then press the Control knob.
- 5 Exit the Function setting mode**
Press and hold the [**↵**] button.



- For adjustment during summer time, refer to "Summer Time" in <Clock & date display type setting> (page 33).

Adjusting the date

- 1 Enter the Function setting mode**
Press and hold the Control knob.
- 2 Select the Date Adjust item**
Select the following items using the Control knob. **Refer**
"Settings" > "Clock&Date" > "Date Adjust"
- 3 Set the year**
Turn the Control knob to adjust the year, and then press the Control knob.
- 4 Set the month**
Turn the Control knob to adjust the month, and then press the Control knob.
- 5 Set the day**
Turn the Control knob to adjust the day, and then press the Control knob.
- 6 Exit the Function setting mode**
Press and hold the [**↵**] button.

Dual clock display

You can set the time for two different cities.

- 1 Enter the Function setting mode**
Press and hold the Control knob.
- 2 Select the City Select item**
Select the following items using the Control knob. **Refer**
"Settings" > "Clock&Date" > "City Select"
- 3 Select the clock display part**
Push the Control knob upward or downward.
- 4 Select home and sub cities**
Turn the Control knob.
- 5 Determine the home and sub cities**
Press the Control knob.
- 6 Exit the Function setting mode**
Press and hold the [**↵**] button.



- For adjustment of home time, refer to <Adjusting the clock> (page 32).
- The time of the sub city is automatically derived from the home time.
When the summer time system is are different between home and sub cities, adjustment can be done by referring to the description of "Sub Clock Adjust" in <Clock & date display type setting> (page 33).

Clock & date display type setting

You can set the display type of the clock and calendar.

- 1 Enter the Function setting mode**
Press and hold the Control knob.
- 2 Select the Clock & Date setting item**
Select the following items using the Control knob. **Refer**
"Settings" > "Clock&Date"
- 3 Select the desired Clock & Date setting item**
Turn the Control knob to select Clock & Date display setting item, and then press the Control knob.

Display	Description
"Clock&Date"	
"Time Synchronized"	Synchronizes this unit's clock with the radio data system station's time data. "ON" / "OFF"
"Summer Time"	Advances the clock one hour when set to ON. "ON" / "OFF"
"Sub Clock Adjust"	Adjusts the time difference caused by summer time. "-1h" / "0h" / "+1h"
"Date Mode"	Sets the date display mode. 7 types

(__ : Factory setting)

- 4 Select a setting and determine it**
Turn the Control knob to select desired setting, and then press the Control knob.
The previous item is displayed.
- 5 Exit the Function setting mode**
Press and hold the [**↵**] button.

General operation

Auxiliary input display setting

You can set the display when switched the AUX source.

- 1 Select the AUX source**
Press the [SRC] button.
Select the "AUX" display.
- 2 Enter the Function setting mode**
Press and hold the Control knob.
- 3 Select the AUX name set item**
Select the following items using the Control knob. **Refer**
"Settings" > "AUX Name Set"
- 4 Select the display connected as an AUX source and determine it**
Turn the Control knob to select the Auxiliary input display, and then press the Control knob.
Select "AUX", "DVD", "PORTABLE", "GAME", "VIDEO", or "TV".
- 5 Exit the Function setting mode**
Press and hold the [↵] button.

Function of KDC-X496, KDC-452U, KMR-550U

Muting the audio upon reception of a phone call

The audio system automatically mutes when it receives an incoming call.

When a call comes in
"CALL" is displayed.
The audio system pauses.

Listening to the audio during a call
Press the [SRC] button.
The "CALL" display disappears and the audio system comes back ON.

When the call ends
Hang up the phone.
The "CALL" display disappears and the audio system comes back ON.



- To use the TEL Mute feature, you need to hook up the MUTE wire to your telephone using a commercial telephone accessory. Refer to <Connecting wires to terminals> (page 12) in Quick start guide.

Initial settings

You can configure initial settings of this unit.

- 1 Select the Standby**
Press the [SRC] button.
Select the "STANDBY" display.
- 2 Enter the Function setting mode**
Press and hold the Control knob.
- 3 Select the Initial settings item**
Turn the Control knob to select "Initial Settings", and then press the Control knob.
- 4 Select a desired Initial setting item**
Turn the Control knob to select an Initial setting item, and then press the Control knob.

Display	Description
"Initial Settings"	
"SRC Select"	Select "2" to change the source selection method. Press the [SRC] button, turn the Control knob to select the source, and then press the Control knob to determine it. 1 / 2
"Key Beep"	Setting the operation check sound (beep sound) ON/OFF. "ON" / "OFF"
"Function Language"	Changes the display language of items displayed in the Function setting mode. "English" / "Français" / "Español"
"Built-in AUX"	Sets whether to display AUX during source selection. "ON" / "OFF"
"CD Read"	Sets the method for reading CD. When unable to play a special format CD, set this setting to "2" to force playing. Note that some music CDs may be unplayable even when set to "2". In addition, audio files cannot be played when set to "2". Normally, keep this set to "1". 1: Automatically distinguishes between the audio file disc and music CD when playing a disc. 2: Forces playing as a music CD.
"Built-in AMP"	Selecting "OFF" turns off the built-in amplifier. Turning off the built-in amplifier improves the quality of the sound from Preout. "ON" / "OFF"
"Speaker Select"	Sets the speaker type so that the System Q value is optimal. "OEM": OFF "5/4inch": For 5 & 4 in. speaker "6x9/6inch": For 6 & 6x9 in. speaker "O.E.M.": For the OEM speaker

"F/W Update"	Upgrades the firmware. Selecting "YES" and then pressing the Control knob starts upgrading the firmware. For how to update the firmware, access our web site. http://www.kenwood.com/cs/ce/
--------------	--

(_ : Factory setting)

- 5 Select an Initial setting and determine it**
Turn the Control knob to select desired setting, and then press the Control knob.
The previous item is displayed.
- 6 Exit the Function setting mode**
Press and hold the [↵] button.

General operation

Demonstration mode setting

You can turn on/off the demonstration mode.

1 Enter the Function setting mode

Press and hold the Control knob.

2 Select the Demonstration mode item

Turn the Control knob to select "DEMO Mode", and then press the Control knob.

3 Select a setting and determine it

Turn the Control knob to select a desired setting ("ON" or "OFF"), and then press the Control knob.

Exit the Function setting mode.

Registering a Bluetooth device

About registration of a Bluetooth device

If your Bluetooth device is not yet registered, register (pair) it by referring to <Simple Bluetooth device registration> (page 38), <Registering a Bluetooth device by operating it> (page 39), or <Registering a Bluetooth device by operating this unit> (page 39).



- For details on the Bluetooth cell-phone with the hands-free function, see <About the Bluetooth module> (page 77).
- If there are 5 Bluetooth devices registered, you cannot register a new Bluetooth device.
- When any error code is displayed while the pairing is in progress, refer to <Troubleshooting guide> (page 78).

Simple Bluetooth device registration

You can register a Bluetooth device using a simple procedure.

1 Enter the Bluetooth mode

Press and hold the [] button.

If your Bluetooth device is not yet registered, search for a Bluetooth device starts with "Searching" displayed.

Pairing with a new Bluetooth device

Turn the Control knob to select "Device Search", and then press the Control knob.

Search for a Bluetooth device starts with "Searching" displayed.

2 Select the Bluetooth device you wish to register

Turn the Control knob to select the Bluetooth device name, and then press the Control knob.

3 Input the PIN code

Operation type	Operation
Selection of the numbers	Turn the Control knob.
Movement to the next digit	Push the Control knob rightward.
Deletion of the last digit	Push the Control knob leftward.
Transmission of PIN code	Press the Control knob.

Pairing completes with "HF Connect" or "Audio Connect" displayed.

Registering a Bluetooth device by operating it

You can register a Bluetooth device using its registration function.

1 Turn on this unit

Press the [SRC] button.

2 Start registering a unit by operating the Bluetooth device

By operating the Bluetooth device, register the hands-free unit (pairing). Select "KENWOOD BT CD/R-6P1" from the list of connected units.

3 Enter the PIN code

Input the PIN code registered as mentioned in <Registering the PIN code> (page 52).

Check that registration is complete on the Bluetooth device.

4 By operating the Bluetooth device, start hands-free connection.

Registering a Bluetooth device by operating this unit

You can register a Bluetooth device using the registration function of this unit.

1 Enter the Bluetooth mode

Press the [] button.

"BT MODE" is displayed.

2 Enter the Function setting mode

Press and hold the Control knob.

3 Select a Bluetooth device registration item

Select the following items using the Control knob. [Refer](#)

"Settings" > "Pairing" > "Device Registration"

Search for the Bluetooth device.

When search is completed, "Finished" is displayed.

4 Select the Bluetooth device you wish to register

Turn the Control knob to select the Bluetooth device, and then press the Control knob.

5 Input the PIN code

Operation type	Operation
Selection of number	Turn the Control knob.
Movement to the next digit	Push the Control knob rightward.
Deletion of the last digit	Push the Control knob leftward.
Transmission of PIN code	Press the Control knob.

If "Pairing Success" is displayed, registration is complete.

6 Return to the device list

Press the Control knob.

7 Exit the Bluetooth mode

Press the [SRC] button.



- This unit allows up to eight digits to be input for a PIN code. If a PIN code cannot be input from this unit, it can be input from the Bluetooth device.
- If the error message appears even though the PIN code is correct, try the procedure mentioned in <Registering a special Bluetooth device> (page 40).

Registering a Bluetooth device

Registering a special Bluetooth device

You can register a special device that cannot be registered normally (pairing).

1 Enter the Bluetooth mode

Press the [] button.
"BT MODE" is displayed.

2 Enter the Function setting mode

Press and hold the Control knob.

3 Select a Special device registration item

Select the following items using the Control knob. [Refer](#)
"Settings" > "Pairing" > "SPCL Device Select"

4 Select the Bluetooth device you wish to register

Turn the Control knob to select the Bluetooth device, and then press the Control knob.
If "Completed" is displayed, registration is completed.

5 Register the selected Bluetooth device

Go through the procedure mentioned in [<Registering a Bluetooth device> \(page 38\)](#) and complete the registration (pairing).

Canceling the Bluetooth mode

Press the [SRC] button.



- If the device name is not in the list, select "Other Phones".

Simple Bluetooth device selection

If Bluetooth devices have been registered but none of them is connected, you can select a Bluetooth device using a simple procedure.

1 Enter the Bluetooth mode

Press and hold the [] button.

2 Select the Bluetooth device you wish to connect

Turn the Control knob to select the Bluetooth device name, and then press the Control knob.

3 Select a connection profile

Turn the Control knob to select Profile, and then press the Control knob.

Pairing completes with "HF Connect" or "Audio Connect" displayed.

"A": Bluetooth device registered using A2DP (Advanced Audio Distribution Profile)

"H": Bluetooth device registered using HFP (Hands Free Profile).

Selecting the Bluetooth device you wish to connect

When two or more Bluetooth devices have already been registered, you need to select the Bluetooth device you wish to use.

1 Enter the Bluetooth mode

Press the [] button.
"BT MODE" is displayed.

2 Enter the Function setting mode

Press and hold the Control knob.

3 Select a Bluetooth device selection item

Select the following items using the Control knob. [Refer](#)
"Settings" > "Pairing" > "Phone Selection" (to select the cell-phone) or "Audio Selection" (to select the audio player)
"(name)" is displayed.

4 Select a desired Bluetooth device

Turn the Control knob to select a Bluetooth device, and then press the Control knob.
*(name)' or '-(name)' is displayed.
"*": The selected Bluetooth device is busy.
"-": The selected Bluetooth device is on standby.
" " (blank): The Bluetooth device is deselected.

5 Exit the Bluetooth mode

Press the [SRC] button.



- If a cell-phone is already selected, deselect it, and then select a different one.
- If you cannot select a device using the audio player, connect the device with the audio player.

Simple Bluetooth device deletion

You can delete a registered Bluetooth device using a simple procedure.

1 Enter the Bluetooth mode

Press and hold the [] button.

2 Select the Bluetooth device you wish to delete

Turn the Control knob to select a Bluetooth device, and then press and hold the Control knob.

3 Determine the selection

Turn the Control knob to select "YES", and then press the Control knob.
"Completed" is displayed.

Registering a Bluetooth device

Deleting a registered Bluetooth device

You can delete a registered Bluetooth device.

1 Enter the Bluetooth mode

Press the [] button.

"BT MODE" is displayed.

2 Enter the Function setting mode

Press and hold the Control knob.

3 Select a Bluetooth device deletion item

Select the following items using the Control knob. [Refer](#)

"Settings" > "Pairing" > "Device Delete"

Device names are displayed.

4 Select the Bluetooth device you wish to delete

Turn the Control knob to select a Bluetooth device, and then press the Control knob.

5 Determine the selection

Turn the Control knob to select "YES", and then press the Control knob.

"Completed" is displayed.

6 Exit the Bluetooth mode

Press the [SRC] button.



- When a registered cell-phone is deleted, its phone Book, log, and SMS are also deleted.

Bluetooth device registration test

You can check whether a Bluetooth device can be registered by operating this unit.

1 Enter the Bluetooth mode

Press and hold the [] button.

Search for a Bluetooth device starts with "Searching" displayed.

2 Select the Bluetooth device to test

Turn the Control knob to select the Bluetooth device name.

3 Enter the Connectivity test mode

Press and hold the Control knob.

"BT Test Mode" is displayed.

4 Input the PIN code

Input the PIN code of Bluetooth device if it has been changed from default.

Operation type	Operation
Selection of numbers	Turn the Control knob.
Movement to the next digit	Push the Control knob rightward.
Delete the last digit	Push the Control knob leftward.
Transmit the PIN code	Press the Control knob.

When pairing is completed successfully, a connection test starts automatically.

When the connection test is completed, test results are displayed on a function basis ("OK": Enabled; "NG": Disabled).

Display	Description
"Pairing"	Registration in this unit
"HF Connect"	Hands-free phoning
"AUD Connect"	Audio playback
"PB Download"	Audio playback

5 Exit the Connectivity test mode

Press the Control knob.

Operation for hands-free phoning

Receiving a call

You can answer a phone call

Press the [] button.



- The following operations disconnect the line:
 - Inserting a CD.
 - Connecting a USB device.
- The name of the calling party is displayed if it has already been registered in the phone Book.

Rejecting an incoming call

Press the [] button.

Calling a number in the phone book

1 Enter the Bluetooth mode

Press the [] button.

"BT MODE" is displayed.

2 Select the Name search mode

Turn the Control knob to select "Phone Book", and then press the Control knob.

3 Search for a number/name in the phone book

Operation type	Operation
Selection of phone number	Turn the Control knob.
Selection of name	Push the Control knob rightward or leftward.
Selection of initial	Push the Control knob upward or downward.
Determination of phone number	Press the Control knob.

4 Make a call

Press the [] button.



- If the phone book has not yet been downloaded automatically, download it according to [<Downloading the phone book> \(page 52\)](#).
- Pressing the [DISP] button each time switches between name and phone number.
- During search, a non-accent character such as "u" is searched for instead of an accent character such as "ü".

Dialing a number

1 Enter the Bluetooth mode

Press the [] button.

"BT MODE" is displayed.

2 Select the Number dial mode

Turn the Control knob to select "Number Dial", and then press the Control knob.

3 Enter a phone number

Turn the Control knob to select a number, and then push the Control knob rightward.

4 Make a call

Press the [] button.

To erase the entered phone number digit by digit:

Push the Control knob leftward.



- You can input a maximum of 32 digits.

Calling a number in the call log

1 Enter the Bluetooth mode

Press the [] button.

"BT MODE" is displayed.

2 Select the Call log mode

Turn the Control knob to select "Incoming Calls", "Outgoing Calls", or "Missed Calls", and then press the Control knob.

"Incoming Calls": Incoming calls

"Outgoing Calls": Outgoing calls

"Missed Calls": Missed calls

3 Select a name or phone number

Turn the Control knob.

4 Make a call



Press the [] button.



- Pressing the [DISP] button each time switches between the name and phone number.
- The outgoing call list, incoming call list, and missed call list, are the lists of calls originated from and received by this unit. They are not the ones stored in the cell-phone memory.

Operation for hands-free phoning

Speed dialing (Preset dial)

- 1 Enter the Bluetooth mode**
Press the [] button.
"BT MODE" is displayed.
- 2 Select the Preset dial mode**
Turn the Control knob to select "Preset Call", and then press the Control knob.
- 3 Select the number you want to recall from the memory**
Turn the Control knob to select a recall number ("P1" – "P6"), and then press the Control knob.
- 4 Make a call**
Press the [] button.



- You need to register the preset dial number. Refer to [<Registering in the preset dial number list>](#) (page 46).

Registering in the preset dial number list

- 1 Enter the phone number you wish to register**
Enter the phone number with reference to the following:
Dialing a number/ Calling a number in the call log/
Calling a number in the phone book
- 2 Enter the Preset memory mode**
Press the [PRESET] button.
- 3 Select a number and store it in the memory**
Turn the Control knob to select memory number ("P1" – "P6"), and then press and hold the Control knob.

Canceling the Preset memory mode

- Press the [] button.

During a call

Disconnecting a call

- Press the [SRC] button.

Switching to the Private mode

- Push the Control knob rightward or leftward.
Pressing this knob each time switches between the private talk mode ("PRIVATE") and hands-free talk mode.



- Depending on the type of your cell-phone, switching to the private talk mode may select the source that was used before commencing the hands-free connection. If this happens, the source cannot be switched back to the hands-free talk mode by operating this unit. Operate your cell-phone to return to the hands-free talk mode.

Adjusting the voice volume during a call

- Turn the Control knob.

Call waiting

Answering another incoming call with the current call suspended

- Press the [] button.

Answering another incoming call after terminating the current call

- Press the [SRC] button.

Continuing the current call

- 1 Press the Control knob.**
- 2 Turn the Control knob to select "Reject", and then press the Control knob.**

Answering the waiting call after terminating the current call

- Press the [] button.

Switching between the current call and waiting call

- Press the Control knob.
Pressing this knob each time switches between the calling parties.

Operation for hands-free phoning

Clearing the disconnection message

Press the [] button.
 "HF Disconnect" disappears.





Making a call by voice dialing

You can make a voice call using the voice recognition function of the cell-phone.

- 1 Enter the Bluetooth mode**
 Press the [] button.
 "BT MODE" is displayed.
- 2 Enter the Voice tag mode**
 Turn the Control knob to select "Voice Tag", and then press the Control knob.
- 3 Have the cell-phone recognize your spoken word**
 Pronounce the name registered in the cell-phone.
 The recognized phone number (name) is displayed.
- 4 Make a call**
 Press the Control knob.

Display of phone number types (categories)

The category items in the phone book are displayed as follows:

Display	Information
"General" / 	General
"Home" / 	Home
"Office" / 	Office
"Mobile" / 	Mobile
"Other" / 	Other

Bluetooth audio device operation

Before use

- You need to register your Bluetooth audio player before using it with this unit. For more details, see <Registering a Bluetooth device> (page 38).
- You need to select the Bluetooth audio player you wish to connect. Refer to <Selecting the Bluetooth device you wish to connect> (page 41).

Basic operations

Selecting a Bluetooth audio source

Press the [SRC] button.
Select the "BT AUDIO" display.

Pause and play

Press the [⏮] button.

Music search

Push the Control knob rightward or leftward.

Fast forward or Fast backward of the song

Push and hold the Control knob rightward or leftward



- All or some of the operations above cannot be performed if the Bluetooth audio player is not ready for remote control.
- Switching between Bluetooth audio sources does not start or stop playback automatically. Perform the operation for starting or stopping playback.
- Some audio players cannot be controlled remotely or reconnected after Bluetooth disconnection. Operate the main unit of the audio player to connect a Bluetooth device.

Playback mode

You can select a playback mode, such as Random play and Repeat play.

1 Select the Bluetooth audio source

Press the [SRC] button.
Select the "BT AUDIO" display.

2 Enter the Function setting mode

Press and hold the Control knob.

3 Select the Play function mode

Turn the Control knob to select "Play Mode", and then press the Control knob.

4 Select a desired playback mode

Turn the Control knob to select a playback mode, and then press the Control knob.

Display	Description
"Play Mode"	
"Random"	When set to "ON", plays the songs randomly. "ON" / "OFF"
"File Repeat"	When set to "ON", plays the select songs repeatedly. "ON" / "OFF"

(_ : Factory setting)

5 Determine the selection

Press the Control knob.
The previous item is displayed.

6 Exit the Function setting mode

Press and hold the [⏮] button.



- The available playback functions differ depending on the type of the connected Bluetooth audio player.

Switching between Bluetooth devices

When two Bluetooth devices are connected, you can select the Bluetooth device you want to use.

1 Select the Bluetooth audio source

Press the [SRC] button.
Select the "BT AUDIO" display.

2 Select a Bluetooth device

Press the [PRESET] button.
"Device Priority" is displayed and the currently selected device name is displayed.

Bluetooth setup

Registering the PIN code

By operating the Bluetooth device, specify the PIN code necessary for registering this unit.

1 Enter the Bluetooth mode

Press the [] button.

"BT MODE" is displayed.

2 Enter the Function setting mode

Press and hold the Control knob.

3 Select the PIN code edit item

Select the following items using the Control knob. [Refer](#)

"Settings" > "Detailed Settings" >

"PIN Code Edit"

4 Input the PIN code

Operation type	Operation
Selection of numbers	Turn the Control knob.
Movement to the next digit	Push the Control knob rightward.
Deletion of the last digit	Push the Control knob leftward.
Transmission of PIN code	Press the Control knob.

If "Completed" is displayed, registration is complete.

5 Exit the Bluetooth mode

Press the [SRC] button.



- By default, "0000" is specified.
- A PIN code can be specified with up to eight digits.

Downloading the phone book

You can download the phone book data from the cell-phone to this unit so that you can use the phone book of this unit.

Downloading automatically

If the cell-phone supports a phone book synchronization function, the phone book is downloaded automatically after Bluetooth connection.



- Setting on the cell-phone may be required.
- If no phone book data is found in the unit even after "Completed" is displayed, your cell-phone may not support a phone book data automatic downloading function. In this case, try downloading manually.

Downloading from the cell-phone manually

1 Operate the cell-phone to end the hands-free connection.

2 Operate the cell-phone to send the phone book data to this unit

By operating the cell-phone, download the phone book data to this unit.

- During downloading:
"Downloading" is displayed.
- After completion of downloading:
"Completed" is displayed.

3 Operate the cell-phone to start the hands-free connection.

Clearing the downloading completion message

Press any button.



- Up to 600 phone numbers can be registered for each registered cell-phone.
- Up to 32 digits can be registered for each phone number along with up to 50* characters representing a name. (* 50: Number of alphabetical characters. Fewer characters can be input depending on the type of characters.)
- To cancel downloading of the phone book data, operate the cell-phone.

Displaying the firmware version

You can view the version of the firmware of this unit.

1 Enter the Bluetooth mode

Press the [] button.

"BT MODE" is displayed.

2 Enter the Function setting mode

Press and hold the Control knob.

3 Select the Bluetooth firmware update item

Select the following items using the Control knob. [Refer](#)

"Settings" > "Detailed Settings" >

"BT F/W Update"

The firmware version appears.

4 Exit the Bluetooth mode

Press the [SRC] button.



- For how to update the firmware, access our web site. www.kenwood.com/bt/information/

Bluetooth setup

Bluetooth detail setting

You can configure the initial settings of this unit.

1 Enter the Bluetooth mode

Press the [**Bluetooth**] button.

"BT MODE" is displayed.

2 Enter the Function setting mode

Press and hold the Control knob.

3 Select the Detailed Settings item

Select the following items using the Control knob. **Refer**

"Settings" > "Detailed Settings"

4 Select a desired Bluetooth detail setting item

Turn the Control knob to select a Bluetooth detail setting item, and then press the Control knob.

Display	Description
"Detailed Settings"	
"Auto Answer"	Automatically answers a call after lapse of the preset time interval. "OFF": Does not answer the phone call automatically. "0SEC": Automatically answers the phone call at once. "1SEC" – "8SEC" – "99SEC": Automatically answers the phone call after lapse of 1 – 99 seconds.
"Auto Reconnect"	When set to "ON", starts re-pairing with the registered Bluetooth device automatically when it becomes unpaired. "ON" / "OFF"
"Bluetooth HF/ Audio"	Specifies the output speakers for hands-free voice communication and Bluetooth audio sound. "Front": Outputs sound from the front speakers. "All": Outputs sound from the front and rear speakers.
"Call Beep"	Sets whether to output a beep from the speaker when a call comes in. "ON": Outputs a beep. "OFF": Does not output a beep.
"MIC Gain"	Adjusts the sensitivity of the microphone for telephone call or adjusts the voice of the caller. "1" – "20" – "30"
"NR Level"	Reduces the noise generated by the surrounding environment without changing the microphone volume or adjusts the voice of the caller when it is not clear. Setting to a positive (+) value enhances the noise reduction effect. "-1" – "0" – "+1"

"Echo Cancel Level"	Sets the echo cancellation level. "-1" – "0" – "+1"
---------------------	--

(0 : Factory setting)

5 Select a Bluetooth detail setting value and determine it

Turn the Control knob to select desired setting, and then press the Control knob.

The previous item is displayed.

6 Exit the Function setting mode

Press and hold the [**Bluetooth**] button.

SMS (Short Message Service)

Displaying the SMS

You can view the SMS received by the cell-phone on the display of this unit.

A newly received message is displayed.



- To prevent car accidents, the driver should not read the SMS while driving.

When a new message arrives

"SMS Received" is displayed.

The display disappears with any operation.

Displaying the SMS

1 Enter the Bluetooth mode

Press the [] button.

"BT MODE" is displayed.

2 Select the SMS inbox display mode

Turn the Control knob to select "SMS Inbox", and then press the Control knob.

3 Select a message

Turn the Control knob.

Pressing the [DISP] button each time switches between the display of the telephone number or name and the display of the message reception date.

4 Display the text

Press the Control knob.

Turn the Control knob to scroll through the message.

Press the Control knob to return to the message list screen.

5 Exit the Bluetooth mode

Press the [SRC] button.



- The unopened message is displayed at the beginning of the list. Other messages are displayed in the order of reception.
- The SMS that is received when the cell-phone is not linked with Bluetooth cannot be displayed. You need to download it.
- The received short message(s) cannot be displayed during downloading a new SMS.

Downloading the SMS

Download the short message (SMS) received by the cell-phone so that it can be read on this unit.

1 Enter the Bluetooth mode

Press the [] button.

"BT MODE" is displayed.

2 Enter the Function setting mode

Press and hold the Control knob.

3 Select the SMS download item

Select the following items using the Control knob. [Refer](#)

"Settings" > "SMS" > "SMS Download"

4 Start downloading

Press the Control knob.

"SMS Downloading" is displayed.

When the downloading is completed, "Completed" is displayed.

5 Exit the Bluetooth mode

Press the [SRC] button.



- The cell-phone must be able to transmit the SMS using Bluetooth. Setting on the cell-phone may be required. If the cell-phone does not support an SMS function, the SMS download item is not displayed in the Function control mode.
- When the SMS is downloaded from the cell-phone, the unopened messages in the cell-phone are opened.
- Up to 149 already read and unread short messages can be downloaded respectively.
- "SMS" does not appear in the Function setting item when a SMS supporting device is not connected.

SMS reply setting

You can select a method to reply to the received SMS.

1 Enter the Bluetooth mode

Press the [] button.

"BT MODE" is displayed.

2 Enter the Function setting mode

Press and hold the Control knob.

3 Select the SMS Reply item

Select the following items using the Control knob. [Refer](#)

"Settings" > "SMS" > "SMS Reply"

4 Select a desired Reply setting

Reply setting	Display	Operation
Auto	"Auto"	Replies to the received SMS automatically.
Manual	"Manual"	Sets whether to reply to the received SMS.
OFF	"OFF"	Does not reply to the received SMS.

Turn the Control knob to select Reply setting, and then press the Control knob.

5 Exit the Function setting mode

Press and hold the [] button.



- Set the reply message according to [Return message setting](#) (page 57).
- When "Auto" is selected, a reply is made only to the SMS from the phone whose phone number has been registered in the phone book. If an SMS is received from the phone whose phone number has not been registered in the phone book, you can reply to it in the same manner as you selected "Manual".
- When an SMS is received with "Manual" selected, "SMS Reply" is displayed. Selecting "Yes" sends the reply. Selecting "No" cancels the reply. Selecting "Yes" allows you to select a message (language).
- If sending of a reply message fails, "Send Error" is displayed. While "SMS Resend" is still displayed on the display, selecting "Yes" resends the reply. Selecting "No" cancels the reply.
- "SMS" does not appear in the Function setting item when a SMS supporting device is not connected.

Return message setting

You can select a return message (language).

1 Enter the Bluetooth mode

Press the [] button.

"BT MODE" is displayed.

2 Enter the Function setting mode

Press and hold the Control knob.

3 Select the SMS Message select item

Select the following items using the Control knob. [Refer](#)

"Settings" > "SMS" > "SMS Message"

4 Select a desired message (language)

Turn the Control knob to select a message (language), and then press the Control knob.

5 Exit the Function setting mode

Press and hold the [] button.



- If you select "User" from the message, the previously created original message will be sent. Refer to [Creating an original message](#) (page 58).
- "SMS" does not appear in the Function setting item when a SMS supporting device is not connected.

SMS (Short Message Service)

Creating an original message

You can create an original return message.

1 Enter the Bluetooth mode

Press the [] button.

"BT MODE" is displayed.

2 Enter the Function setting mode

Press and hold the Control knob.

3 Select the SMS Message select item

Select the following items using the Control knob. [Refer](#)



knob. [Refer](#)

"Settings" > "SMS" > "SMS Message"

4 Select the SMS message edit mode

Turn the Control knob to select "User", and then press the Control knob.

5 Create a message

Operation type	Operation
Selection of characters	Turn the Control knob.
Selection of column	Push the Control knob rightward or leftward.
Selection of character type	Press the [DISP] button.
Deletion of character	Press the [] button.
Deletion of all characters.	Press and hold the [] button

6 Determine the selection

Press the Control knob.

7 Exit the Function setting mode

Press and hold the [] button.



- "SMS" does not appear in the Function setting item when a SMS supporting device is not connected.

SiriusXM Vehicle Connect Tuner Control (optional tuner and service required)

Before use

- SiriusXM Satellite Radio operation requires the connection of the optional SiriusXM-Connect Vehicle Tuner (sold separately) and service. To activate the SiriusXM Vehicle Connect tuner, you will need the Radio ID.
- **Make a note of your Radio ID**
For each SiriusXM Vehicle Connect tuner, peculiar Radio ID is assigned. To confirm your Radio ID, tune to channel 0. The letters I, O, S and F are not used in any Radio ID.
- **How to activate your SiriusXM Service**
Go to www.siriusxm.com/activatenow or call 1-866-635-2349 to activate your SiriusXM Vehicle Connect Tuner.

Basic operations

Selecting SiriusXM Radio source

Press the [SRC] button.
Select the "SiriusXM" display.



- The radio may take a little time to start after you select the SiriusXM Radio source.
- If the signal reception fails, "No Signal" appears.

Selecting a channel

Push the Control knob rightward or leftward.

Category and channel search

You can select the channel and category you want to receive.

1 Enter the Category and Channel search mode

Press the [Q] button.
"Category Search" is displayed.

2 Select a category

Turn the Control knob to select a category, and then press the Control knob.

3 Select a channel

Turn the Control knob to select a channel, and then press the Control knob.

Canceling the Category and Channel search mode

Press and hold the [↵] button.



- You cannot search for a channel until the category information is acquired.

Channel preset memory

You can store a channel in the memory.

1 Select the channel to preset

Push the Control knob rightward or leftward

2 Enter the Preset memory mode

Press the [PRESET] button.

3 Select a number and store it in the memory

Turn the Control knob to select a memory number ("1" – "24"), and then press and hold the Control knob.

Canceling the Preset memory mode

Press the [↵] button.



- If you press the [PRESET] button twice in step 2, the Mix Station preset mode is selected with "Mixed Preset List" displayed.
In this mode, different bands and tuner sources (Radio, SiriusXM, HD Radio tuner etc.) can be saved in the same preset layer, which allows you to recall the desired station without switching between bands or tuner sources. A maximum of six stations can be preset in the Mix Station preset mode.
Once the Mix Station preset mode is set, you can enter the same mode by just pressing the [PRESET] button once in step 2.
Pressing the [PRESET] button twice allows you to return to the normal Station preset mode.

SiriusXM Vehicle Connect Tuner Control (optional tuner and service required)

Preset tuning

Recalling a channel from the memory.

- 1 Enter the Preset memory mode**
Press the [PRESET] button.
- 2 Select the number you want to recall from the memory**
Turn the Control knob to select a recall number ("1" – "24"), and then press the Control knob.
The memory number and channel name are displayed.

Canceling Preset tuning

Press the [↩] button.

Channel scan

You can scan for receivable channels for 10 seconds.

- 1 Start Channel Scan**
Press and hold the [Q] button.
- 2 Release it when the channel you want to listen to is received**
Press and hold the [Q] button.

Function of remote control

Direct access tuning

You can search for a channel directly by entering its number.

- 1 Enter the Direct access tuning mode**
Press the [DIRECT] button on the remote control.
- 2 Enter a channel number**
Press the number buttons on the remote control.
- 3 Search for the channel**
Press the [◀◀] or [▶▶] button on the remote control.

Canceling the Direct access tuning mode

Press the [↩] button on the remote control.



- If you operate no button for 10 seconds, the Direct Access Tuning mode is automatically canceled.

Seek mode setting

You can select a tuning mode of the radio.

- 1 Select the SiriusXM Radio source**
Press the [SRC] button.
Select the "SiriusXM" display.
- 2 Enter the Function setting mode**
Press and hold the Control knob.
- 3 Select the Seek mode item**
Select the following items using the Control knob. [Refer](#) "Settings" > "Seek Mode".
- 4 Select a desired Seek mode**

Display	Operation
"Channel"	Normal manual seeking.
"Preset"	Searches in order of the channels in the preset memory.

Turn the Control knob to select Seek mode, and then press the Control knob.

- 5 Exit the Function setting mode**
Press and hold the [↩] button.

SiriusXM Vehicle Connect Tuner Control (optional tuner and service required)

iTunes tagging

You can store the tag of the information about the song being received, and send it to the connected iPod. You can easily find the song on the iTunes Store according to the tag sent to the iPod.

1 Store the song information tag

Press and hold the [PRESET] button.

"TAG" will be indicated on the display when song information can be registered.

"TAG Storing" is indicated on the display while a tag is being stored in this unit. "TAG Stored" is indicated on the display after a tag is stored.

When your iPod is connected to this unit, "TAG Transferred" is shown on the display and a tag is sent to the iPod.



- The song corresponding to the tag sent to the iPod is indicated in the playlist ("Tagged") of the synchronized iTunes.

By clicking your desired song in the playlist, you can easily find it on the iTunes Store and buy it from the iTunes Store.

- A total of fifty song information tags can be stored in this unit including the song information tags stored by the function of the HD Radio tuner function mentioned in <iTunes tagging> (page 25).

When a tag has been sent to the iPod, the tag stored in this unit is cleared.

- Select "ON" for "Tagging" as mentioned in <SiriusXM tuner setting> (page 71) when using this function.
- The memory usage can be checked by selecting the "TAG Memory" setting mentioned in <SiriusXM tuner setting> (page 71).

Parental Lock setting

You can turn on/off Parental Lock for each channel.

1 Select the SiriusXM Radio source

Press the [SRC] button.

Select the "SiriusXM" display.

2 Enter the Function setting mode

Press and hold the Control knob.

3 Select the Parental Lock item

Select the following items using the Control knob. Refer

"Settings" > "Parental Lock"

4 Enter the pass code

Operation type	Operation
Selection of numbers.	Turn the Control knob.
Determination of the selected numbers.	Press the Control knob.
Selection of column	Push the Control knob rightward or leftward.
Deletion of all numbers	Push and hold the Control knob leftward.



- The pass code is set to "0000" as default. For how to change the pass code, refer to <Parental Lock pass code setting> (page 66).

5 Select the Lock channel edit item

Turn the Control knob to select "Lock CH Edit", and then press the Control knob.

A category list is displayed.

6 Select the category of the channel subject to Parent Lock setting

Turn the Control knob to select a category, and then press the Control knob.

The list of the channels in the selected category is displayed.

7 Set Parental Lock

Turn the Control knob to select a channel, and then press the Control knob.

Parental Lock for the selected channel is turned on and off alternately each time you press the Control knob.

"*" is indicated for the selected channel.

"M" is indicated for the Mature content channel.

8 Exit the Function setting mode

Press and hold the [↵] button.



- If a channel for which Parental Lock is turned on is selected, a pass code input screen appears. Programs on the selected channel can be received only when the input pass code is correct.

Clearing the Parental Lock setting

You can clear the Parent Lock setting for each channel.

1 Select the SiriusXM Radio source

Press the [SRC] button.

Select the "SiriusXM" display.

2 Enter the Function setting mode

Press and hold the Control knob.

3 Select the Parental Lock item

Select the following items using the Control knob. Refer

"Settings" > "Parental Lock"

4 Enter the pass code

Operation type	Operation
Selection of numbers.	Turn the Control knob.
Determination of the selected numbers.	Press the Control knob.
Selection of column	Push the Control knob rightward or leftward.
Deletion of all numbers	Push and hold the Control knob leftward.



- The pass code is set to "0000" as default.

5 Select the Lock channel clear item

Turn the Control knob to select "Lock CH All Clear", and then press the Control knob.

6 Clear the Parent Lock setting

Turn the Control knob to select "Yes", and then press the Control knob.

"Completed" is displayed.

7 Exit the Function setting mode

Press and hold the [↵] button.

SiriusXM Vehicle Connect Tuner Control (optional tuner and service required)

Setting Parental Lock for Mature content

You can turn on/off Parental Lock for the adult channel.

- 1 Select the SiriusXM Radio source**
Press the [SRC] button.
Select the "SiriusXM" display.
- 2 Enter the Function setting mode**
Press and hold the Control knob.
- 3 Select the Parental Lock item**
Select the following items using the Control knob. [Refer](#)
"Settings" > "Parental Lock"

4 Enter the pass code

Operation type	Operation
Selection of numbers.	Turn the Control knob.
Determination of the selected numbers.	Press the Control knob.
Selection of column	Push the Control knob rightward or leftward.
Deletion of all numbers	Push and hold the Control knob leftward.



- The pass code is set to "0000" as default.

- 5 Select the Mature channel setting item**
Turn the Control knob to select "Mature Set, and then press the Control knob.
- 6 Turn on the Mature setting**
Turn the Control knob to select "ON" and then press the Control knob.
Selecting "OFF" and pressing the Control knob will turn off the Mature setting.
- 7 Exit the Function setting mode**
Press and hold the [↵] button.



- If a Mature channel is selected with the Mature setting turned on, the pass code input screen appears. Programs on the selected channel can be received only when the pass code is correct.

Parental Lock pass code setting

You can set a new pass code for Parental Lock setting.

- 1 Select the SiriusXM Radio source**
Press the [SRC] button.
Select the "SiriusXM" display.
- 2 Enter the Function setting mode**
Press and hold the Control knob.
- 3 Select the Parental Lock item**
Select the following items using the Control knob. [Refer](#)
"Settings" > "Parental Lock"

4 Enter the pass code

Operation type	Operation
Selection of numbers.	Turn the Control knob.
Determination of the selected numbers.	Press the Control knob.
Selection of column	Push the Control knob rightward or leftward.
Deletion of all numbers	Push and hold the Control knob leftward.



- The pass code is set to "0000" as default.

- 5 Select the Pass code set item**
Turn the Control knob to select "Passcode Set", and then press the Control knob.
"Enter new code" is displayed.
- 6 Enter a new pass code (first time)**
Enter a new pass code in the same manner as in step 4.
- 7 Enter the new pass code again (second time)**
Enter the same pass code as that entered in step 6.
The old pass code is changed to the new one and "Completed" is displayed.
- 8 Exit the Function setting mode**
Press and hold the [↵] button.

Content alert

When the broadcast of the song by the registered artist or the broadcast of the registered song starts, a message appears to allow you to switch the current source to the desired channel, even though the receiving source is other than SiriusXM Radio.

Registering content

- 1 Receive the content you wish to register**
- 2 Select the Content registration mode**
Push the Control knob upward.
- 3 Register the content**
Turn the Control knob to select a content type ("Store Artist?" or "Store Song?"), and then press the Control knob.
"Artist Stored" or "Song Stored" is displayed.



- You can register a total of 50 types of content including both artists and songs.

When a Content alert occurs

- 1 A content alert message is displayed**
When multiple content alerts occur, a content name is displayed one after another. The previous content name can be displayed and selected by the operation in step 3.
A content alert message is displayed for five seconds from the last content alert.
The following switching operation to your desired content can be performed while the message is being displayed.
- 2 Start selecting a content**
Press the Control knob.
- 3 Select your desired content of which content alerts are occurring**
Turn the Control knob to select the content, and then press the Control knob.
The current source switches to the channel that is broadcasting the selected content.



- The Content alert message is not displayed, when operating in various modes: Bluetooth mode (<Operation for hands-free phoning> (page 44)), Audio Control mode (<Audio control> (page 8)), Function setting mode (<Function setting procedure> (page 1)), etc.
- A Content alert occurred can be selected from "My Music" category <Category and channel search> (page 61).

Canceling Content alert mode

Press the [↵] button.

SiriusXM Vehicle Connect Tuner Control (optional tuner and service required)

Content alert setting

You can turn on/off the content alert function.

- 1 Select the SiriusXM Radio source**
Press the [SRC] button.
Select the "SiriusXM" display.
- 2 Enter the Function setting mode**
Press and hold the Control knob.
- 3 Select the Content alert set item**
Select the following items using the Control knob. **Refer**
"Settings" > "Content alert" > "Alert Set"
- 4 Turn on or off the Content alert function**
Turn the Control knob to select "ON" or "OFF", and then press the Control knob.
- 5 Exit the Function setting mode**
Press and hold the [↵] button.

Editing a Content alert item

You can enable or disable the registered content alert item individually.

- 1 Select the SiriusXM Radio source**
Press the [SRC] button.
Select the "SiriusXM" display.
- 2 Enter the Function setting mode**
Press and hold the Control knob.
- 3 Select the Content alert edit item**
Select the following items using the Control knob. **Refer**
"Settings" > "Content alert" > "Alert Item Edit"
- 4 Select a content type**
Turn the Control knob to select "Song" or "Artist", and then press the Control knob.
- 5 Select or deselect the selected Content alert item**
Turn the Control knob to select a Content alert item, and then press the Control knob.
The selected Content alert item is selected and deselected alternately each time you press the Control knob.
"*" is indicated for the selected item name.
- 6 Exit the Function setting mode**
Press and hold the [↵] button.

Delete a Content alert item

You can delete the registered Content alert item.

- 1 Select the SiriusXM Radio source**
Press the [SRC] button.
Select the "SiriusXM" display.
- 2 Enter the Function setting mode**
Press and hold the Control knob.
- 3 Select the Content alert delete item**
Select the following items using the Control knob. **Refer**
"Settings" > "Content alert" > "Alert Item Delete"
- 4 Select a content type**
Turn the Control knob to select "Song Delete", "Artist Delete" or "All Delete", and then press the Control knob.
Selecting "All Delete" allows you to delete all Content alert items together. Proceed to step 6.
- 5 Select the Content alert item you wish to delete**
Turn the Control knob to select Content alert item, and then press the Control knob.
- 6 Determine the selection**
Turn the Control knob to select "YES", and then press the Control knob.
"Completed" is displayed.
- 7 Exit the Function setting mode**
Press and hold the [↵] button.

Instant Replay

You can replay last 30 minutes of current channel.

- 1 Enter Instant Replay mode**
Push the Control knob downward.
"Instant Replay" is displayed and play pauses.
The "IR" indicator stays lit during instant replay.
- 2 Start Instant Replay**
Press the [↵] button.
The songs are replayed starting with the song played 30 minutes ago.
During instant replay, you can perform the following operations:

Operation type	Operation
Pause and play	Press the [↵] button.
Music search	Push the Control knob rightward or leftward.
Fast forward or Fast backward	Push and hold the Control knob rightward or leftward

- 3 Exit Instant Replay mode**
Push the Control knob downward.
"Live" is displayed, and then the on-air song is received.
-  Recorded data of the previously received channel is cleared immediately when a different channel is received.

SiriusXM Vehicle Connect Tuner Control (optional tuner and service required)

Channel skip setting

You can register the channel you wish to skip.

- 1 Select the SiriusXM Radio source**
Press the [SRC] button.
Select the "SiriusXM" display.
- 2 Enter the Function setting mode**
Press and hold the Control knob.
- 3 Select the Channel skip setting item**
Select the following items using the Control knob. **Refer**
"Settings" > "Channel Skip" > "Skip CH Edit"
- 4 Select the category of the channel you wish to skip**
Turn the Control knob to select a category, and then press the Control knob.
- 5 Select the channel you wish to skip**
Turn the Control knob to select a channel, and then press the Control knob.
The selected channel skip setting is turned on and off alternately each time you press the Control knob.
"*" is indicated for the selected item name.
- 6 Exit the Function setting mode**
Press and hold the [**↵**] button.

Clearing the channel skip setting

You can clear the skip setting for all the selected channels together.

- 1 Select the SiriusXM Radio source**
Press the [SRC] button.
Select the "SiriusXM" display.
- 2 Enter the Function setting mode**
Press and hold the Control knob.
- 3 Select the Channel skip delete item**
Select the following items using the Control knob. **Refer**
"Settings" > "Channel Skip" > "Skip CH Clear"
- 4 Clear the channel skip setting**
Turn the Control knob to select "YES", and then press the Control knob.
"Completed" is displayed.
- 5 Exit the Function setting mode**
Press and hold the [**↵**] button.

SiriusXM tuner setting

You can set the SiriusXM tuner related items.

- 1 Enter the Function setting mode**
Press and hold the Control knob.
- 2 Select the Setting mode**
Turn the Control knob to select "Settings", and then press the Control knob.
- 3 Select a desired SiriusXM tuner setting item**
Turn the Control knob to select a SiriusXM tuner setting item, and then press the Control knob.

Display	Description
"Settings"	
"TAG Memory"	Displays the tag memory usage of the HD Radio tuner and SiriusXM tuner. Up to 50 tags can be registered in this unit.
"Tagging"	Turns on/off the iTunes tag memory function of SiriusXM tuner. "ON" / "OFF"
"Signal Level"	Displays the received signal strength of the SiriusXM tuner.
"IR Buffer Usage"	Displays the memory usage for the function mentioned in Instant Replay (page 69). "0%" – "100%"

(_ : Factory setting)

- 4 Select a setting and determine it**
Turn the Control knob to select a desired setting, and then press the Control knob.
The previous item is displayed.
- 5 Exit the Function setting mode**
Press and hold the [**↵**] button.

Remote control (Optional accessory) setup

Registering a remote control ID

When connecting the remote control KCA-RC107/ KCA-RC55MR (Optional accessory) to this unit, you should register the ID for KCA-RC107/ KCA-RC55MR.

1 Select the Standby

Press the [SRC] button.
Select the "STANDBY" display.

2 Enter the Function setting mode

Press and hold the Control knob.

3 Select the Remote ID Set item

Select the following items using the Control knob. [Refer](#)
"Initial Settings" > "Remote Settings" > "Remote ID Set"

A remote control ID list is displayed. "Yes" indicates that this ID is already registered. "No" indicates that this ID is available.

4 Enable registration of the remote control ID

Press the Control knob.
"Registering..." is displayed.

5 Register the remote control ID

For KCA-RC107/ KCA-RC55MR, press the [ENTER] or [SRC] button.

Button	Remote control ID
[ENTER]	Registers ID1.
[SRC]	Registers ID2.

"ID#Set:Completed" is displayed.

6 Exit the Function setting mode

Press and hold the [↵] button.



- When removing the KCA-RC107/ KCA-RC55MR, delete the registered remote control ID as mentioned in [<Delete the remote control ID>](#) (page 72).

Delete the remote control ID

You can delete the ID registered for the remote control KCA-RC107/ KCA-RC55MR (optional accessory).

1 Select the Standby

Press the [SRC] button.
Select the "STANDBY" display.

2 Enter the Function setting mode

Press and hold the Control knob.

3 Select the Remote ID Delete item

Select the following items using the Control knob. [Refer](#)
"Initial Settings" > "Remote Settings" > "Remote ID Delete"

List of the IDs registered for remote controls is displayed.

4 Select the remote control ID to delete

Turn the Control knob to select a remote control ID, and then press the Control knob.
"Remote ID Delete" is displayed.

5 Determine the selection

Turn the Control knob to select "YES", and then press the Control knob.
"Remote ID Delete:Completed" is displayed.

6 Exit the Function setting mode

Press and hold the [↵] button.

Basic operation of remote control

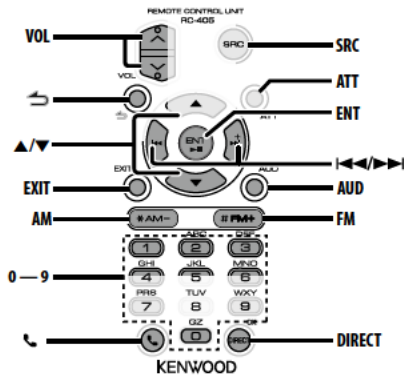

Preparing the remote control unit

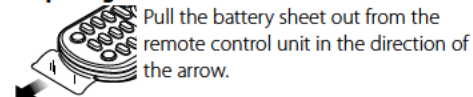

Changing the battery of the remote control unit

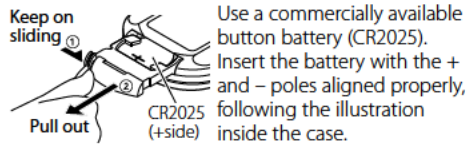

Use a commercially available button battery (CR2025). Insert the battery with the + and - poles aligned properly, following the illustration inside the case.

General control

- Volume control: [VOL]
- Source selection: [SRC]
- Volume reduction: [ATT]
When the button is pressed again, the volume returns to the previous level.
- Return to previous item: [↶]
- Exit from mode: [EXIT]
- Selection of item: [▲]/[▼]
- Determination: [ENT]
- Enter Audio Control mode: [AUD]

On Tuner source

- Band selection: [FM]/[AM]
- Station selection: [◀◀]/[▶▶]
- Recall preset stations: [0] - [9] → [ENT]

On HD Radio tuner source

- Band selection: [FM]/[AM]
- Station selection: [◀◀]/[▶▶]
- Recall preset stations: [0] - [9] → [ENT]

On CD/Audio file source

- Music selection: [◀◀]/[▶▶]
- Folder selection: [FM]/[AM]
- Pause/Play: [ENT]
- Enter the Music search mode: [▲]/[▼]
- Movement between folders/files during Music search mode: [▲]/[▼]
- Return to previous folder: [↶]

On iPod source

- Enter Music search mode: [▲]/[▼]
- Movement between items during Music search mode: [▲]/[▼]
- Return to previous item: [↶]
- Pause/Play: [ENT]

On Pandora internet radio source

- Music selection: [▶▶]
- Pause/Play: [ENT]
- Enter the station list mode: [▲]/[▼]
Select item: [▲]/[▼]
Exit the station list mode: [↶]

On SiriusXM tuner source

- Channel selection: [◀◀]/[▶▶]
- Recall preset stations: [0] - [9] → [ENT]

Hands-free phone control

Making a call

- Enter Bluetooth mode: [☎]
- Select a dialing method: [▲]/[▼] → [ENT]
- Number dial input:
Input a digit: [0] - [9]
Input "+": [▶▶]
Input "#": [FM]
Input **: [AM]
Clear the entered phone number: [◀◀]
- Make a call: [DIRECT]

Receiving a call

- Answer the call: [☎]

Call waiting

- Answer another incoming call with the current call suspended: [☎]

During a call

- End the call: [SRC]

CAUTION

- Keep battery out of reach of children and in original package until ready to use. Dispose of used batteries promptly. If swallowed, contact a physician immediately.
- Do not leave the battery near fire or under direct sunlight. A fire, explosion or excessive heat generation may result.
- Do not set the remote control in hot places such as on the dashboard.
- The Lithium battery is in danger of explosion if replaced incorrectly. Replace only with the same or equivalent type.

Appendix

About the Audio file

- **Playable Audio files**
AAC-LC (.m4a), MP3 (.mp3), WMA (.wma)
- **Playable disc media**
CD-R/RW/ROM
- **Playable disc file formats**
ISO 9660 Level 1/2, Joliet, Romeo, Long file name.
- **Playable USB devices**
USB mass storage class
- **Playable USB device file systems**
FAT16, FAT32

Even if the audio files comply with the standards listed above, playback may be impossible depending on the type or condition of the medium or device.

- **Playback order of the Audio files**
In the example of folder/file tree shown below, files are played in the order of number from ① to ⑩.

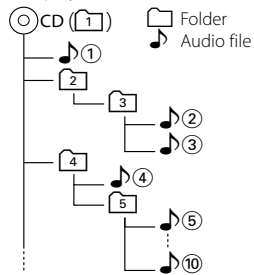

For the online manual describing audio files, visit www.kenwood.com/cs/ce/audiofile/. In this online manual, detailed information and notes which are not provided in this manual are provided. Make sure to read through the online manual as well.



- In this manual, the term "USB device" indicates a flash memory or digital audio player which has a USB terminal.

About the USB device

- When the USB device is connected to this unit, it is charged when this unit is powered.
- Install the USB device in the place where it will not prevent you from driving your vehicle properly.
- You cannot connect a USB device via a USB hub or multi card reader.
- Save backups of the audio files used with this unit. The files can be erased depending on the operating condition of the USB device.
We shall not be liable for any damage arising out of erasure of the stored data.
- No USB device comes with this unit. You need to purchase a commercially available USB device.
- When connecting the USB device, use of the

- CA-U1EX (option) is recommended.
- Normal playback is not guaranteed when a cable other than the USB compatible cable is used.
Connecting a cable whose total length is longer than 4 m can result in abnormal playback.

Models of iPods/iPhones that can be connected to this unit

Made for

- iPod nano (6th generation)
- iPod nano (4th generation)
- iPod nano (2nd generation)
- iPod with video
- iPod touch (4th generation)
- iPod touch (2nd generation)
- iPhone 4S
- iPhone 3GS
- iPhone
- iPod nano (5th generation)
- iPod nano (3rd generation)
- iPod nano (1st generation)
- iPod classic
- iPod touch (3rd generation)
- iPod touch (1st generation)
- iPhone 4
- iPhone 3G

- For information on the compatibility with iPod/iPhone software, visit www.kenwood.com/cs/ce/ipod/.
- Types of available control vary depending on the type of connected iPod. Visit www.kenwood.com/cs/ce/ipod/ for further details.
- The word "iPod" appearing in this manual indicates the iPod or the iPhone connected with the iPod connection cable (optional accessory).
- Refer to the web site for connectable iPods and iPod connection cables.
www.kenwood.com/cs/ce/ipod/



- If you start playback after connecting the iPod, the music that was playing on the iPod is played first. In this case, "RESUMING" is displayed without displaying a folder name, etc. Changing the browse item will display a correct title, etc.
- You cannot operate the iPod if "KENWOOD" or "✓" is displayed on the iPod.

About "KENWOOD Music Editor"

- This unit supports the PC application "KENWOOD Music Editor Light ver1.1" or later.
- When you use the audio file with database information added by the "KENWOOD Music Editor Light ver1.1", you can search for a file by title, album or artist name using the function mentioned in <Music search> (page 18).
- In the Instruction manual, the term "Music Editor media" indicates the device that contains audio files with database information added with KENWOOD Music Editor.
- "KENWOOD Music Editor Light ver1.1" is available from the following web site:
www.kenwood.com/cs/ce/
- For further information on "KENWOOD Music Editor Light ver1.1", refer to the site above or the application help.

Requirements Pandora® internet radio

Requirements for listening to the Pandora® internet radio are as follows:

iPhone or iPod touch

- Use an Apple iPhone or iPod touch running under iOS3 or later.
- Search for "Pandora" in the Apple iTunes App Store to find and install the most current version of the Pandora® application on your device.
- iPhone/iPod touch connected to this unit with a KCA-iP102.

Android™

- Visit the Andoid marketplace and search for Pandora to install.
- Bluetooth must be built in and the following profiles must be supported.
 - SPP (Serial Port Profile)
 - A2DP (Advanced Audio Distribution Profile)

BlackBerry®

- Visit www.pandora.com from the built in browser to download the Pandora application.
- Bluetooth must be built in and the following profiles must be supported.
 - SPP (Serial Port Profile)
 - A2DP (Advanced Audio Distribution Profile)



- In the application on your device, log in and create an account with Pandora.
(If you are not already a registered user, an account can also be created at www.pandora.com.)
- Internet connection by 3G, EDGE, or WiFi.
- Pandora® is available only in the U.S.
- Because Pandora® is a third-party service, the specifications

are subject to change without prior notice. Accordingly, compatibility may be impaired or some or all of the services may become unavailable.

- Some functions of Pandora® cannot be operated from this unit.
- For issues using the application, please contact Pandora® at pandora-support@pandora.com

About the SiriusXM tuner (Optional accessory)

This unit supports SXM Ready Vehicle Connect Tuners. Refer to the instruction manual for the SiriusXM tuner.

Function of KDC-X896, KDC-BT852HD

About the Bluetooth module

This unit conforms to the following Bluetooth specifications:

Version	Bluetooth Ver. 3.0 Certified
Profile	HFP (Hands Free Profile) HSP (Headset Profile) SPP (Serial Port Profile) A2DP (Advanced Audio Distribution Profile) AVRCP (Audio/Video Remote Control Profile) PBAP (Phonebook Access Profile) OPP (Object Push Profile)

For the cell-phones verified for compatibility, access the following URL:

<http://www.kenwood.com/cs/ce/bt/>



- The units supporting the Bluetooth function have been certified for conformity with the Bluetooth Standard following the procedure prescribed by Bluetooth SIG. However, it may be impossible for such units to communicate with your cell-phone depending on its type.
- HFP is a profile used to make a hands-free call.
- OPP is a profile used to transfer data such as a phone book between units.

Troubleshooting guide

Some functions of this unit may be disabled by some settings made on this unit.

- !** • **Cannot set up display.**
 - ▶ The demonstration mode is not turned off as mentioned in <Demonstration mode setting> (page 36).

- !** • **Cannot set the "Text Select", "Side Select", or "Status" setting for the "Display Select" item.**
 - ▶ A display type is not selected as mentioned in <Selecting a display type> (page 28).

- !** • **Cannot set up the subwoofer.**
 - **Cannot set up the low pass filter.**
 - **No output from the subwoofer.**
 - ▶ "SubWoofers" is not set to ON as mentioned in <Audio control> (page 8).

- !** • **Cannot set up the subwoofer phase.**
 - ▶ "LPF SubWoofers" is set to "Through" as mentioned in <Audio control> (page 8).

What might seem to be a malfunction in your unit may just be the result of a slight operation error or a wiring error. Before calling for service, first check the following table for possible problems.

General

- ?** **The key beep does not sound**
 - ✓ The Preout jack is in use.
 - ✎ The key beep cannot be output from the Preout jack.

- ?** • **Sound cannot be heard.**
 - **The unit does not turn on.**
 - **Information shown on the display is incorrect.**
 - ✓ The connectors are dirty.
 - ✎ Clean the connectors. Refer to <Cleaning the connector> (page 4).

Tuner source

- ?** **Radio reception is poor.**
 - ✓ The car antenna is not extended.
 - ✎ Pull the antenna out all the way.

Disc source

- ?** **The specified disc does not play, but another one plays instead.**
 - ✓ The specified CD is quite dirty.
 - ✎ Clean the CD with reference to <Handling discs> (page 4).
 - ✓ The disc is severely scratched.
 - ✎ Try another disc instead.

Audio file source

- ?** **The sound skips when an Audio file is being played.**
 - ✓ The media is scratched or dirty.
 - ✎ Clean the media with reference to <Handling discs> (page 4).
 - ✓ The recording condition is bad.
 - ✎ Play the media again or use another media.

Troubleshooting guide

The messages shown below indicates your system condition.

“TOC Error”

- The CD is quite dirty. The CD is upside-down. The CD is scratched a lot.
- The disc is unreadable.

“IN” (blink)

- The CD player section is not operating properly.
 - ⇨ Reinsert the CD. If the CD cannot be ejected or the display continues to blink even when the CD has been properly reinserted, please switch off the power and consult your nearest service center.

“Protect” (blink)

- The speaker wire has short-circuited or touched the chassis of the vehicle, and then the protection function has been activated.
 - ⇨ Lay or insulate the speaker cable properly and press the Reset button. If “Protect” does not disappear, consult your nearest service center.

“NA File”

- An Audio file is played in a format that is not supported by this unit.

“Copy PRO”

- A copy-protected file is played.

“Read Error”

- The file system of the connected USB device is broken.
 - ⇨ Copy the files and folders for the USB device again. If “Read Error” is still displayed, initialize the USB device or use another USB device.

“No Device”

- A USB device is selected as a source although no USB device is connected.
 - ⇨ Change the source to any source other than the USB device. Connect an USB device, and change the source to the USB device again.

“N/A Device”

- An unsupported USB device is connected.
- Connection to the iPod has failed.
 - ⇨ Check that the connected iPod is supported. See [<About the Audio file> \(page 76\)](#) for information on supported iPods.

“No Music Data”

- The connected USB device contains no playable audio file.
- A medium that does not have playable data has been played.

“iPod Error”

- Connection to the iPod has failed.
 - ⇨ Remove the USB device and then reconnect it.
 - ⇨ Reset iPod/ iPhone.

“No Number”

- The calling party does not notify a caller ID.
- There is no phone number data.

“No Data”

- There is no outgoing call list.
- There is no incoming call list.
- There is no missed call list.
- There is no phone book list.

“No Entry”

- The cell-phone has not been registered (pairing).

“HF Disconnect”

- The unit cannot communicate with the cell-phone.

“AUD Disconnect”

- The unit cannot communicate with the Bluetooth audio player.

“HF Error 07”

- The memory cannot be accessed.
 - ⇨ Cycle the power switch. If this message still appears, press the Reset button on the control unit.

“HF Error 68”

- The unit cannot communicate with the cell-phone.
 - ⇨ Cycle the power switch. If this message still appears, press the Reset button on the control unit.

“HF Error 89”

- Update of the firmware has failed.
 - ⇨ Retry update of the firmware.

“Unknown”

- The Bluetooth device cannot be detected.

“Device Full”

- 5 Bluetooth device have already been registered. No more Bluetooth devices is registered.

“PIN Code NG”

- The PIN code is wrong.

“Connect NG”

- The unit cannot be connected to the device.

“Pairing Failed”

- Pairing error.

“N/A Voice Tag”

- No voice tags are registered in your cell-phone.

“No Phonebook”

- Data is not contained in the phone book.

“No Message”

- No short message in In Box.

“Send Error”

- SMS could not be sent.

“Memory Full”

- The tag memory of HD Radio tuner and SiriusXM tuner is FULL.

“iPod Full”

- The iPod memory is FULL.

“No TAG Function”

- An iPod which does not support the tag memory has been connected.

“Pandora Error 01”

- Registration in Bookmark has failed.

“Pandora Error 02”

- Deletion of the station has failed.

“Pandora Error 03”

- Registration of the station has failed.

“Pandora Error 04”

- The number of registered stations has reached the upper limit.
 - ⇨ Retry after deleting an unnecessary station.

“Pandora Error 05”

- Registration of Thumbs Up/Down has failed.

“Pandora Error 06”

- Keyword search has failed.

“No Station”

- There is no receivable station.

“No skips remaining”

- No more skips are allowed now.
 - ⇨ Retry after a while.

“Check Device”

- Any device ready for Pandora internet radio reception is not connected to this unit.

“No Support”

- The connected Bluetooth device does not support a voice recognition function.

“No Active Device”

- Any Bluetooth device supporting a voice recognition function is not connected.

SiriusXM Advisory Messages

“Check Tuner”

- A SiriusXM tuner is not connected to this unit.
 - ⇨ Check that the connected SiriusXM tuner is connected.

“Subscription Updated - Press Enter to Continue”

- The SiriusXM subscription has been renewed.
 - ⇨ Pressing the Control knob will clear the error message.

“Ch Unavailable”

- The currently selected channel is unavailable.

“Chan Unsub”

- The currently selected channel is not subscribed to.

“Incorrect Code”

- The entered pass code is incorrect.

“Check Antenna”

- No antenna is connected to the SiriusXM tuner.
 - ⇨ Check that an antenna is connected to the SiriusXM tuner.

“No Signal”

- No SiriusXM radio signal is received.
 - ⇨ Check that an antenna is connected to the SiriusXM tuner.

“Alert Memory Full”

- The number of Alert content has reached the upper limit.
 - ⇨ Retry after deleting unnecessary Alert content.

“Song Stored”

- The song you attempted to register as Alert content has already been registered.

“Artist Stored”

- The artist you attempted to register as Alert content has already been registered.

“Art/Sng Unavail”

- The content currently being received cannot be registered as a content alert item regardless of whether its artist or song name is stored.

Specifications

FM tuner section (KDC-X496/ KDC-452U/ KMR-550U)

- Frequency range (200 kHz step)
: 87.9 MHz – 107.9 MHz
- Usable sensitivity (S/N = 30dB)
: 9.3dBf (0.8 μ V/75 Ω)
- Quieting Sensitivity (S/N = 46dB)
: 15.2 dBf (1.6 μ V/75 Ω)
- Frequency response (\pm 3 dB)
: 30 Hz – 15 kHz
- Signal to Noise ratio (MONO)
: 70 dB (\pm 400 kHz)
- Stereo separation
: 40 dB (1 kHz)

Digital FM tuner section (KDC-X896/ KDC-BT852HD)

- Frequency range (200 kHz step)
: 87.9 MHz – 107.9 MHz
- Frequency response (\pm 3 dB)
: 20 Hz – 20 kHz
- Signal to Noise ratio (STEREO)
: 70 dB

AM tuner section (KDC-X496/ KDC-452U/ KMR-550U)

- Frequency range (10 kHz step)
: 530 kHz – 1700 kHz
- Usable sensitivity (S/N = 20dB)
: 28 dB μ (25 μ V)

Digital AM tuner section (KDC-X896/ KDC-BT852HD)

- Frequency range (10 kHz step)
: 530 kHz – 1700 kHz
- Frequency response (\pm 3 dB)
: 40 Hz – 15 kHz
- Signal to Noise ratio (STEREO)
: 70 dB

CD player section

- Laser diode
: GaAlAs
- Digital filter (D/A)
: 8 Times Over Sampling
- D/A Converter
: 24 Bit
- Spindle speed (Audio files)
: 500 – 200 rpm (CLV)
- Wow & Flutter
: Below Measurable Limit
- Frequency response (\pm 1 dB)
: 10 Hz – 20 kHz
- Total harmonic distortion (1 kHz)
KDC-X896/ KDC-X496 : 0.008 %
KDC-BT852HD/ KDC-452U/ KMR-550U : 0.010 %
- Signal to Noise ratio (1 kHz)
KDC-X896/ KDC-X496 : 110 dB
KDC-BT852HD/ KDC-452U/ KMR-550U : 105 dB
- Dynamic range
: 93 dB
- MP3 decode
: Compliant with MPEG-1/2 Audio Layer-3
- WMA decode
: Compliant with Windows Media Audio
- AAC decode
: AAC-LC “.m4a” files

USB interface

- USB Standard
: USB1.1/ 2.0 (Full speed)
- File System
: FAT16/ 32
- Maximum Supply current
: DC 5 V \pm 1 A
- MP3 decode
: Compliant with MPEG-1/2 Audio Layer-3
- WMA decode
: Compliant with Windows Media Audio
- AAC decode
: AAC-LC “.m4a” files

Audio section

- Maximum output power
: 50 W x 4
- Full Bandwidth Power (at less than 1% THD)
: 22 W x 4
- Speaker Impedance
: 4 – 8 Ω
- Tone action
Bass : 100 Hz \pm 8 dB
Middle : 1 kHz \pm 8 dB
Treble : 12.5 kHz \pm 8 dB
- Preout level/ Load (CD)
KDC-X896/ KDC-X496 : 4000 mV/10 k Ω
KDC-BT852HD/ KDC-452U/ KMR-550U
: 2500 mV/10 k Ω
- Preout impedance
: \leq 600 Ω

Bluetooth section (KDC-X896/ KDC-BT852HD)

- Version
: Bluetooth Ver. 3.0 Certified
- Frequency range
: 2.402 – 2.480 GHz
- Output Power
: +4dBm (MAX), 0dBm (AVE) Power Class 2
- Maximum Communication range
: Line of sight approx.10m (32.8 ft)
- Profiles
: HFP (Hands Free Profile)
: HSP (Headset Profile)
: SPP (Serial Port Profile)
: A2DP (Advanced Audio Distribution Profile)
: AVRCP (Audio/Video Remote Control Profile)
: PBAP (Phonebook Access Profile)
: OPP (Object Push Profile)

Auxiliary input

- Frequency response (\pm 3 dB)
: 20 Hz – 20 kHz
- Input Maximum Voltage
: 1200 mV
- Input Impedance
: 10 k Ω

General

- Operating voltage
KDC-X896/ KDC-BT852HD
: 14.4 V (10.5 – 16V allowable)
KDC-X496/ KDC-452U/ KMR-550U
: 14.4 V (11 – 16V allowable)
- Maximum Current consumption
: 10 A
- Installation Size (W x H x D)
: 182 x 53 x 160 mm
7-3/16 x 2-1/16 x 6-5/16 inch
- Weight
: 2.9 lbs (1.3 kg)

▲CAUTION

Use of controls or adjustments or performance of procedures other than those specified herein may result in hazardous radiation exposure. In compliance with Federal Regulations, following are reproductions of labels on, or inside the product relating to laser product safety.

JVC KENWOOD Corporation
2967-3, ISHIKAWA-MACHI,
HACHIOJI-SHI, TOKYO, JAPAN

THIS PRODUCT COMPLIES WITH DHHS RULES
21 CFR SUBCHAPTER J IN EFFECT AT DATE OF
MANUFACTURE.

Location : Top plate

FCC WARNING

This equipment may generate or use radio frequency energy. Changes or modifications to this equipment may cause harmful interference unless the modifications are expressly approved in the instruction manual. The user could lose the authority to operate this equipment if an unauthorized change or modification is made.

FCC NOTE

This equipment has been tested and found to comply with the limits for a Class B digital device, pursuant to Part 15 of the FCC Rules. These limits are designed to provide reasonable protection against harmful interference in a residential installation. This equipment may cause harmful interference to radio communications, if it is not installed and used in accordance with the instructions. However, there is no guarantee that interference will not occur in a particular installation. If this equipment does cause harmful interference to radio or television reception, which can be determined by turning the equipment off and on, the user is encouraged to try to correct the interference by one or more of the following measures:

- Reorient or relocate the receiving antenna.
- Increase the separation between the equipment and receiver.
- Connect the equipment into an outlet on a circuit different from that to which the receiver is connected.
- Consult the dealer or an experienced radio/TV technician for help.

IC (Industry Canada) Notice

Operation is subject to the following two conditions:
(1)This device may not cause interference, and
(2)this device must accept any interference, including interference that may cause undesired operation of the device.

The term "IC: " before the certification/ registration number only signifies that the Industry Canada technical specification were met.

▲CAUTION

This equipment complies with FCC/IC radiation exposure limits set forth for an uncontrolled environment and meets the FCC radio frequency (RF) Exposure Guidelines in Supplement C to OET65 and RSS-102 of the IC radio frequency (RF) Exposure rules. This equipment has very low levels of RF energy that it deemed to comply without maximum permissive exposure evaluation (MPE). But it is desirable that it should be installed and operated keeping the radiator at least 20cm or more away from person's body (excluding extremities: hands, wrists, feet and ankles).

Under Industry Canada regulations, this radio transmitter may only operate using an antenna of a type and maximum (or lesser) gain approved for the transmitter by Industry Canada. To reduce potential radio interference to other users, the antenna type and its gain should be so chosen that the equivalent isotropically radiated power (e.i.r.p.) is not more than that necessary for successful communication.

- Contains Transmitter Module
FCC ID : RKXFC6000S
- Contains Transmitter Module
IC: 5119A-FC6000S

CALIFORNIA, USA

This product contains a CR Coin Cell Lithium Battery which contains

Perchlorate Material – special handling may apply.
See www.dtsc.ca.gov/hazardouswaste/perchlorate

- The Bluetooth word mark and logos are owned by the Bluetooth SIG, Inc. and any use of such marks by JVC KENWOOD Corporation is under license. Other trademarks and trade names are those of their respective owners.
- The "AAC" logo is a trademark of Dolby Laboratories.
- iTunes is a trademark of Apple Inc.
- "Made for iPod" and "Made for iPhone" mean that an electronic accessory has been designed to connect specifically to iPod or iPhone, respectively, and has been certified by the developer to meet Apple performance standards. Apple is not responsible for the operation of this device or its compliance with safety and regulatory standards. Please note that the use of this accessory with iPod or iPhone may affect wireless performance.
- iPhone, iPod, iPod classic, iPod nano, and iPod touch are trademarks of Apple Inc., registered in the U.S. and other countries.
- Sirius, XM and all related marks and logos are trademarks of Sirius XM Radio Inc. All rights reserved.
- HD Radio Technology manufactured under license from iBiquity Digital Corporation. U.S. and Foreign Patents. HD Radio™ and the HD, HD Radio, and "Arc" logos are proprietary trademarks of iBiquity Digital Corp.
- PANDORA, the PANDORA logo, and the Pandora trade dress are trademarks or registered trademarks of Pandora Media, Inc., used with permission.
- Android is a trademark of Google Inc.
- BlackBerry®, RIM®, Research In Motion® and related trademarks, names and logos are the property of Research In Motion Limited and are registered and/or used in the U.S. and countries around the world. Used under license from Research In Motion Limited.

(((SiriusXM)))
READY



KENWOOD

HD Radio®

This HD Radio receiver enables:

PSD

HD2/HD3

Digital Sound

iTunes® Tagging

MILITARY

Units purchased through the U.S.A. military exchange service overseas may be serviced under warranty in the continental U.S.A., subject to the following conditions.

- 1) The original warranty is in effect.
- 2) Proof of purchase is provided to the servicer.

WARRANTY FOR MILITARY MARKET

Kenwood corporation is proud of the quality and workmanship of its audio equipment. This unit has been properly designed, tested and inspected before it was shipped to you. If properly installed and operated in accordance with instructions furnished, it should give you an optimum reliable performance.

WARRANTY PERIOD

This product is warranted for a period of (1) year from the date of the original purchase.

SCOPE OF WARRANTY

Except as specified below, this warranty covers all defects in materials and workmanship of the Kenwood brand products.

During the warranty period, any authorized Kenwood Service Center in the military market listed in the back of this warranty card will provide you free-of-charge both parts and labor required to correct any defect in materials or workmanship.

The following are not covered by this warranty.

1. Voltage conversions.
2. Periodic check-ups which do not disclose any defect covered by the warranty.
3. Cabinets, grilles, other exterior finishes, belts, tape heads, and other non-durable parts and accessories.
4. Units on which the serial number has been effaced, modified or removed.
5. Installation and/or removal charges.
6. Damaged magnetic tapes.
7. House call charges for any repairs.
8. Shipping or delivery charges to or from an authorized Kenwood Service Center.
9. This warranty will not cover any failure that is due to any of the following conditions in accordance with the visual inspection of the authorized Kenwood Service Center:

- * Improper maintenance or repair, including the installation of parts or accessories that do not conform to the quality and specifications of the original parts.
- * Misuse, abuse, neglect, unauthorized product modification or failure to follow instructions contained in the Owner's Manual.
- * Accidental or intentional damages.
- * Repairs or attempted repairs by an unauthorized agency. (All repairs must be performed at an authorized Kenwood Service Center.)
- * Damages or deteriorations caused during shipment (Claims must be presented to the carrier).
- * Damages or deteriorations resulting from removal and/or replacement.

PURCHASER'S RESPONSIBILITIES

As the purchaser of a new Kenwood brand product, you are requested to do the following in order to obtain Kenwood warranty service.

1. Retain your sales slip or other evidence of purchase for proving your eligibility for requesting Kenwood warranty service.
2. Make your unit available to an authorized Kenwood Service Center in the military market for inspection and approved warranty service, or ship your unit in its original carton box or equivalent, fully insured and shipping charges prepaid, to the authorized Kenwood Service Center.

LIMITATION OF IMPLIED WARRANTIES

Any and all implied warranties, including warranties of merchantability and fitness for a particular purpose, shall be limited in duration to the length of this warranty.

EXCLUSION OF CERTAIN DAMAGES

KENWOOD's liability for any defective product is limited to the repair or replacement of said product, at our option, and shall not include damages of any kind, whether incidental, consequential or otherwise, except to the extent prohibited by applicable law.

KENWOOD AUTHORIZED SERVICE CENTERS IN MILITARY MARKET

JAPAN:

Yokota
Kenwood Rep.; c/o
Yokota BX, JAAX AAFES-PAC,
APO San Francisco 96328

Zama

Kenwood Rep.; c/o
Zama PX, JAAX AAFES-PAC,
APO San Francisco 96343

Misawa

Kenwood Rep.; c/o
Misawa BX, JAAX AAFES-PAC,
APO San Francisco 96519

Yokosuka

Kenwood Rep.; c/o
A-33, Yokosuka NEX No. 260-010
FPO Seattle 98760

Atsugi

Kenwood Rep.; c/o
Atsugi NEX No. 260-020 FPO Seattle
98767

Iwakuni

Kenwood Rep.; c/o
Marine Corps Exchange, Marine Corps
Air Station,
FPO Seattle 98764

Sasebo

Sasebo NEX;
Navy Exchange 260-040
F.A. Box 115 FPO Seattle 98766

Okinawa

Kenwood Rep.; c/o
OWAX, AAFES-PAC, APO San Francisco
96230

KOREA:

Kenwood Rep.; c/o
KOAX Repair Shop, AAFES-PAC
DD-Camp Market, APO San Francisco
96488

GUAM:

Kenwood Rep.; c/o
Guam NEX No. 230-010,
FPO San Francisco 96630
Kenwood Rep.; c/o
GUAX, AAFES-PAC, APO San Francisco
96334

U.S.A.:

Hawaii
Kenwood Factory Service
99-994 Iwaena St., Aiea, Hawaii 96701

Alaska

Vista Radio TV;
861 East Loop Road, Anchorage, Alaska
99501
Anchorage Commercial Electronics, Inc.;
1450 East 9th Ave., Anchorage, Alaska
99501

In The Continental U.S.A.

For Nearest Authorized Service Center,
Tel: 1-800-536-9663

Kenwood Service U.S.A.

Kenwood Factory Service;
P.O. Box 22745, 2201 East Dominguez
Street,
Long Beach, California 90801-5745
Tel: (310) 639-5300

EUROPE:

Please inquire at the military resale
outlets where you bought your Kenwood
products, or
KENWOOD ELECTRONICS
DEUTSCHLAND GMBH:
Rembrücker-Str. 15, 63150 Heusenstamm,
Germany
Tel.: 49-06104-69010

KENWOOD

Warranty Card

Identification du produit
Modelo do aparelho e numero de série
Model number & serial number

Revendeur & cachet
Nome da loja e carimbo
Dealer & stamp

Date d'achat
Data da compra
Purchase date

Nom & adresse du client
Nome e endereço do cliente
Name & address of customer

Attention:

This card and receipt (or invoice) are necessary to purchase a new panel in case of theft or damage.

Attention:

Vous aurez besoin de cette carte et du reçu (ou de la facture) pour acheter un nouveau panneau en cas de vol ou d'endommagement.

Atenção:

Em caso de dano ou perda do painel frontal, este Certificado de Garantia e a Nota Fiscal de compra serão requisitados para a aquisição de um novo painel.

Dear Customer,

Thank you for purchasing this Kenwood product. As mentioned in the pages of this booklet, our warranty is only valid in the countries listed. If your country is not listed please contact your retailer for information on warranty procedure, or write to:

JVC KENWOOD Customer Information Center

3-12, Moriyacho, Kanagawa-ku, Yokohama-shi, Kanagawa 221-0022, Japan

U.S.A.	KENWOOD USA CORPORATION
<p>This warranty will be honored only in the U.S.A.</p>	
<p>WHO IS PROTECTED</p> <p>This warranty is enforceable only by the original purchaser.</p>	
<p>WHAT WE WILL PAY FOR</p> <p>We will pay for all labor and material expenses for covered items. Payment of shipping charges is discussed in the next section of this warranty.</p>	
<p>HOW TO OBTAIN WARRANTY SERVICE</p> <p>If your KENWOOD product ever needs service:</p> <ol style="list-style-type: none"> 1. Take or ship it to any KENWOOD Authorized Service Center in the U.S.A. along with a complete description of the problem, (if you are uncertain as to whether a Service Center is authorized, please call 1-800-KENWOOD for the nearest Service Center. 1-800-536-9663). 2. Although you must pay any shipping charges if it is necessary to ship the product for warranty service, we will pay the return shipping charges if the repairs are covered by the warranty within the United States. 3. Whenever your units are taken or sent for warranty service, you must include a copy of the original dated sales receipt as proof of warranty coverage. 	
<p>LIMITATION OF IMPLIED WARRANTIES</p> <p>ALL IMPLIED WARRANTIES, INCLUDING WARRANTIES OF MERCHANTABILITY AND FITNESS FOR A PARTICULAR PURPOSE, ARE LIMITED IN DURATION TO THE LENGTH OF THIS WARRANTY.</p>	
<p>EXCLUSION OF DAMAGES</p> <p>KENWOOD'S LIABILITY FOR ANY DEFECTIVE PRODUCT IS LIMITED TO THE REPAIR OR REPLACEMENT OF THE PRODUCT AT OUR OPTION. KENWOOD SHALL NOT BE LIABLE FOR:</p> <ol style="list-style-type: none"> 1. INSTALLATION OR REMOVAL CHARGES, DAMAGE TO OTHER PROPERTY CAUSED BY ANY DEFECTS IN KENWOOD CAR STEREO COMPONENTS, DAMAGES BASED UPON INCONVENIENCE, LOSS OF USE OF THE PRODUCT, OR 2. ANY OTHER DAMAGES, WHETHER INCIDENTAL, CONSEQUENTIAL OR OTHERWISE. <p>SOME STATES DO NOT ALLOW LIMITATIONS ON HOW LONG AN IMPLIED WARRANTY LASTS AND/OR DO NOT ALLOW THE EXCLUSION OR LIMITATION OF INCIDENTAL OR CONSEQUENTIAL DAMAGES, SO THE ABOVE LIMITATIONS AND EXCLUSIONS MAY NOT APPLY TO YOU.</p>	
<p>This warranty gives you specific legal rights, and you may also have other rights which vary from state to state.</p>	
<p>If a problem develops during or after the Limited Warranty Period, or if you have any questions regarding the operation of the product, you should contact your KENWOOD Authorized Dealer or Authorized Service Center. If the problem or your question is not handled to your satisfaction, please contact our Customer Relations Department at the address listed below:</p>	
<p>KENWOOD USA CORPORATION P.O. Box 22745, 2201 East Dominguez Street, Long Beach, CA 90801-5745 Tel: (310) 639-5300</p>	

BRASIL	JVC KENWOOD DO BRASIL COMERCIO DE ELECTRONICOS LTDA.
<p>O fabricante garante o produto identificado na Nota Fiscal de venda ao consumidor contra qualquer defeito de fabricação ou de matéria-prima durante o período de garantia. Esta garantia é válida no território brasileiro, condicionado ao uso correto do aparelho conforme o manual de instruções.</p>	
<p>PERÍODO DE GARANTIA</p> <p>Este produto é garantido pelo prazo de 01 (um) ano, incluindo o período estabelecido por lei, a partir da data de aquisição, comprovada mediante a apresentação da respectiva Nota Fiscal de venda ao consumidor final.</p> <p>Eventuais reparos realizados no produto durante o período de garantia não implicam na dilatação do seu prazo.</p>	
<p>EXCLUSÃO DA GARANTIA</p> <p>(a) Produtos com o número de série ou certificado de garantia rasurados, adulterados ou ilegíveis;</p> <p>(b) Defeitos resultantes de acidentes (quedas, batidas e etc), uso em desacordo com o manual de instruções, má utilização, ligação à fonte de tensão diferente da especificada no Manual de Instruções, modificações não autorizadas;</p> <p>(c) Danos causados por agentes da natureza (Ex: Chuvas, raios, maresia, enchentes e etc);</p> <p>(d) Defeitos ou danos em decorrência de consertos realizados por pessoas não autorizadas;</p> <p>(e) Defeitos ou danos resultantes do uso de peças ou dispositivos não conformes às especificações da Kenwood;</p> <p>(f) Danos ou deteriorações aos acabamentos externos, partes cosméticas, cabos, adaptadores, antenas, fitas, cabeças gravadoras, CDs ou danos causados por pilhas defeituosas ou com vazamento;</p> <p>(g) Defeitos ou danos devido ao transporte (reclamações devem ser feitas junto à empresa transportadora);</p> <p>(h) Qualquer outra causa que não esteja relacionada a defeitos de matéria-prima e de fabricação;</p> <p>(i) Danos causados por tentativa de roubo ou furto;</p> <p>(j) Danos causados por uso de CDs de má qualidade.</p>	
<p>CONCERTO EM GARANTIA</p> <p>É indispensável a apresentação deste Certificado de Garantia devidamente preenchido, acompanhado da respectiva Nota Fiscal de compra do produto.</p>	
<p>O QUE NÃO É COBERTO PELA GARANTIA</p> <p>Instalação e remoção do produto, despesas de frete, seguro e embalagem são de responsabilidade do proprietário.</p>	
<p>JVC KENWOOD DO BRASIL COMERCIO DE ELECTRONICOS LTDA. Tel: 0800-7717270 www.kenwood.com.br</p>	

CANADA	KENWOOD ELECTRONICS CANADA INC.
<p>KENWOOD WARRANTY</p> <p>KENWOOD ELECTRONICS CANADA INC. (hereinafter called "KENWOOD"), gives the following written warranty to the original customer of each new Kenwood product distributed in Canada by KENWOOD and purchased from a dealer authorized by KENWOOD.</p>	
<p>KENWOOD warrants that each new Kenwood product, under normal use, is free from any defects, subject to the terms and conditions set forth below. If a defect should occur within the warranty period, repairs will be made free of charge for parts and labour when such defects are determined by KENWOOD or its' authorized service centres to be attributable to faulty materials or workmanship at time of manufacture. Please contact KENWOOD to confirm if a dealer or service centre is authorized by KENWOOD.</p>	
<p>WARRANTY PERIOD</p> <p>This Kenwood product is warranted for parts and labour for a period of one (1) year from the date of original purchase, lease or rental, except for products which are used in a professional or commercial application, which are warranted for a period of ninety (90) days for parts and labour and are subject to the terms and conditions of the warranty.</p>	
<p>WARRANTY EXCLUSIONS</p> <p>This warranty excludes:</p> <ol style="list-style-type: none"> (a) Products purchased in a foreign country or purchased in Canada and taken to a foreign country. (b) Products purchased from a dealer not authorized by KENWOOD. (c) Products with the serial number defaced, altered or missing. (d) Periodic check-ups which do not disclose any defects covered by this warranty. 	
<p>(e) Defects resulting from disaster, accident, abuse, misuse, lightning, power surges, neglect or lack of periodic maintenance, unauthorized modification or failure to follow instructions in the owner's manual.</p> <p>(f) Defects or damage as a result of repairs performed by a person or party not authorized by KENWOOD.</p> <p>(g) Defects resulting from the use of parts or devices that do not conform to KENWOOD specifications.</p> <p>(h) Damage or deterioration occurring to any exterior finishes, cosmetic parts, tape heads, adaptors, antennas, cables, tapes, discs or faults or damage caused by defective or leaking batteries.</p> <p>(i) Defects or damage occurring during shipping (claims should be presented to the shipping company).</p> <p>(j) Product voltage and/or line frequency conversions.</p> <p>(k) Product installation or removal charges.</p>	
<p>TO OBTAIN WARRANTY SERVICE</p> <p>Should your Kenwood product require warranty service, deliver it to any authorized KENWOOD service centre and present the original copy of your bill of sale and this warranty card as proof of warranty, or send your product fully insured and freight prepaid to the nearest authorized KENWOOD service centre. To avoid possible shipping damage, make sure the product is properly packed. Include a copy of your original bill of sale and this warranty card as proof of warranty along with your name, home and /or work telephone number(s), a complete return address and a detailed description of the fault(s). Products repaired within warranty will be returned freight prepaid to destinations within Canada. The customer is responsible for all freight and related costs for the return of product(s) to destinations outside Canada.</p>	
<p>ENTIRE WARRANTY</p> <p>This warranty constitutes the entire written warranty given by KENWOOD. No person, party, dealer or service centre or their agents or employees are authorized to extend or enlarge this warranty on behalf of KENWOOD by any written or verbal statement or advertisement or promotion, including any extended warranty program or plan that may be offered by the dealer or service centre, unless approved in writing by KENWOOD.</p>	
<p>DISCLAIMER</p> <p>KENWOOD disclaims any responsibility for loss of time or use of the product or any other indirect, incidental or consequential damage to other products or goods, inconvenience or commercial loss.</p>	
<p>NOTICE TO CONSUMER</p> <p>The provisions contained in this written warranty are not intended to limit, modify, take away, disclaim or exclude any warranties or rights you may have which are set forth in any applicable provincial or federal laws or legislation.</p>	
<p>IMPORTANT</p> <p>This warranty card by itself is not considered by KENWOOD as a valid proof of purchase. When applying for warranty repairs, you must present the original copy of your bill of sale and this warranty card as proof of warranty, so we recommend that they be kept in a safe place, should they be required in the future.</p>	
<p>KENWOOD ELECTRONICS CANADA INC. 6070 Kestrel Road, Mississauga, Ontario, Canada L5T 1S8 Tel.: (905) 670-7211 Fax: (905) 670-7248</p>	

GARANTIE KENWOOD	L'ENTIERE GARANTIE
<p>KENWOOD ELECTRONICS CANADA INC. (ci-après appelée "KENWOOD"), donne par écrit la garantie suivante à l'acheteur original de chaque nouveau produit Kenwood distribué au Canada par KENWOOD et acheté à un concessionnaire autorisé par KENWOOD.</p>	
<p>KENWOOD garantit, sous réserve des termes et des conditions énoncés ci-dessous, que chaque nouveau produit Kenwood, dans des conditions d'emploi normales, est exempt de tous défauts. Si l'un défaut se produit pendant la période de garantie, KENWOOD s'engage à assumer le coût des pièces défectueuses et de la main-d'œuvre nécessaires pour effectuer les réparations pourvu que de tels défauts sont attribuables à des pièces défectueuses employées lors de la fabrication du produit Kenwood ou à la main-d'œuvre tel qu'établi par KENWOOD ou par l'un de ses centres de service autorisés. Appelez KENWOOD pour vérifier si un concessionnaire ou un centre de service est autorisé par KENWOOD.</p>	
<p>PÉRIODE DE GARANTIE</p> <p>Les pièces et la main-d'œuvre nécessaires pour la réparation des produits Kenwood sont garanties pendant la période d'un (1) an à compter de la date d'achat, de bail ou de location originale, sauf dans les cas où les produits Kenwood sont employés dans un but professionnel ou commercial, où la garantie des pièces et de la main-d'œuvre demeure en vigueur pendant une période de quatre-vingt-dix (90) jours sous réserve des termes et des conditions de la garantie.</p>	
<p>EXCLUSIONS DE GARANTIE</p> <p>Cette garantie ne couvre pas:</p> <ol style="list-style-type: none"> (a) les produits achetés à l'étranger ou achetés au Canada et transportés à l'étranger; (b) les produits achetés à un concessionnaire non autorisé par KENWOOD; (c) les produits dont le numéro de série manque, a été effacé ou modifié; (d) les services d'entretien périodiques qui n'indiquent aucun défaut couvert par cette garantie; 	
<p>(e) les défauts causés par les désastres, les accidents, les abus, les emplois incorrects, les éclairs, les surtensions de courant, les manques de soins ou d'entretiens périodiques, les modifications non autorisées ou les manques de respect du mode d'emploi;</p> <p>(f) les défauts ou les dommages causés lors de réparations effectuées par une personne ou par une partie non autorisée par KENWOOD;</p> <p>(g) les défauts causés par l'emploi de pièces ou de dispositifs qui ne se conforment pas aux exigences de KENWOOD;</p> <p>(h) les finitions extérieures, les pièces cosmétiques, les têtes de bandes, les adaptateurs, les antennes, les câbles, les bandes, les disques endommagés ou déperis, ni les défauts ou dommages causés par des piles défectueuses ou qui fuient;</p> <p>(i) les défauts ou dommages qui se produisent pendant l'expédition des produits Kenwood (On devrait déposer de telles réclamations auprès des compagnies de transport);</p> <p>(j) les conversions de tension et/ou de fréquence du produit;</p> <p>(k) les frais d'installation ou d'enlèvement du produit.</p>	
<p>COMMENT OBTENIR DU SERVICE SOUS GARANTIE</p> <p>Au cas où un service sous garantie de votre produit Kenwood s'avère nécessaire, veuillez livrer le produit à l'importe quel centre de service KENWOOD et présenter la copie originale du contrat de vente et cette carte de garantie en tant que preuve de garantie ou veuillez faire parvenir votre produit assuré et port payé au centre de service KENWOOD autorisé le plus proche. Pour éviter toutes possibilités de dommages pendant le transport, veuillez bien emballer le produit. Veuillez inclure une copie du contrat de vente original et cette carte de garantie en tant que preuve de garantie aussi bien que votre nom, numéros de téléphone au poste de travail et/ou au domicile, votre adresse et une description détaillée des défauts. Les produits sous garantie réparés seront retournés port payé aux destinations à l'intérieur du Canada. Le consommateur sera responsable de tous frais de transport et d'autres frais qui s'y rapportent pour faire expédier les produits à destinations à l'extérieur du Canada.</p>	
<p>RENONCIATION</p> <p>KENWOOD renonce à toutes responsabilités de perte de temps, d'emploi du produit, de tous dommages indirects ou accessoires causés à d'autres produits ou biens, de tous inconforts ou de toutes pertes commerciales.</p>	
<p>AVIS AUX CONSOMMATEURS</p> <p>Les stipulations contenues dans la présente garantie écrite n'ont pas pour but de limiter, de modifier, de diminuer, de rejeter ni d'exclure d'autres garanties ni droits énoncés dans n'importe quelles lois ou législations provinciales ou fédérales.</p>	
<p>IMPORTANT</p> <p>KENWOOD ne considère pas cette garantie toute seule comme étant une preuve d'achat valide. Lorsqu'on demande du service sous garantie, il faudra présenter la copie originale du contrat de vente aussi bien que cette carte de garantie en tant que preuve de garantie. On recommande de les conserver dans un lieu sûr au cas où elles s'avèreraient nécessaires à l'avenir.</p>	
<p>KENWOOD ELECTRONICS CANADA INC. 6070 Kestrel Road, Mississauga, Ontario, Canada L5T 1S8 Téléphone: (905) 670-7211 Télécopieur: (905) 670-7248</p>	

Free Manuals Download Website

<http://myh66.com>

<http://usermanuals.us>

<http://www.somanuals.com>

<http://www.4manuals.cc>

<http://www.manual-lib.com>

<http://www.404manual.com>

<http://www.luxmanual.com>

<http://aubethermostatmanual.com>

Golf course search by state

<http://golfingnear.com>

Email search by domain

<http://emailbydomain.com>

Auto manuals search

<http://auto.somanuals.com>

TV manuals search

<http://tv.somanuals.com>