

KENWOOD

KDS-P100

DIGITAL SIGNAL PROCESSOR
INSTRUCTION MANUAL

PROCESSEUR DE SIGNAL NUMERIQUE
MODE D'EMPLOI

DIGITAL SIGNAL PROCESSOR
BEDIENUNGSANLEITUNG

KENWOOD CORPORATION

Take the time to read through this instruction manual. Familiarity with installation and operation procedures will help you obtain the best performance from your new digital signal processor.

For your records

Record the serial number, found on the back of the unit, in the spaces designated on the warranty card, and in the space provided below. Refer to the model and serial numbers whenever you call upon your KENWOOD dealer for information or service on the product.

Model KDS-P100 Serial number _____

SAFETY PRECAUTIONS

▲ WARNING

Observe the following instructions to prevent fires and personal injury.

- When the Power supply lead or Ground lead are extended, use a 0.75 mm² (AWG 18) or larger automotive grade cable which will withstand friction and heat to safe guard against fires occurring as a result of short-circuiting.
- Make sure that metal objects, particularly needles or coins do not get into the unit to prevent short-circuiting and fires.
- If smoke comes out of the unit or a strange smell is present, disconnect the unit immediately and consult your KENWOOD dealer. Continued use under these circumstances could cause a fire, as well as damage the unit permanently.

▲ CAUTION

Heed the following instructions to keep the unit in proper working order.

- The unit should be connected to a 12 V DC power supply with a minus ground connection.
- Do not open enclosures, such as the front panel, top or bottom covers.
- Do not place the unit, where it will be exposed to direct sunlight or near heating devices.
- Do not dash water on the unit.
- Do not place the unit in areas of excessive dust, high humidity or on unstable surfaces.

NOTE

- If you have difficulty in installing the set in your car, please contact your KENWOOD dealer.
- If your set malfunctions or operates abnormally, first press the Reset button. If the malfunction persists, leave the set as it is and please call your KENWOOD dealer.



Reset button

- Always use a four-speaker system (front and rear) with this unit, to enjoy the DSP effects.

Cleaning

1. Turn the power off, before cleaning the unit.
2. Wipe the front panel and other exterior surfaces of the unit with a soft dry cloth or a soft cloth lightly moistened with a neutral detergent.

▲ CAUTION

- Do not use abrasive pads, thinner or benzene (or other volatile solvents) to clean the unit as this may remove indicator characters.

FCC WARNING

This equipment may generate or use radio frequency energy. Changes or modifications to this equipment may cause harmful interference unless the modifications are expressly approved in the instruction manual. The user can lose the authority to operate this equipment if an unauthorized changes or modification are made.

TABLE OF CONTENTS

	Page
■ Introduction	
DIGITAL SIGNAL PROCESSOR	4
SPECIAL FEATURES	5
■ Your new Digital signal processor	
VOLUME CONTROL	6
HALL SIMULATION	7
DIGITAL EQUALIZER	8
POSITION CONTROL	10
■ DSP memory function	
KBS (KENWOOD Built-in Sound)	12
DSP MEMORY	13
■ DSP adjustment functions	
HALL SIMULATION ADJUSTMENT	14
DIGITAL EQUALIZER ADJUSTMENT	16
POSITION CONTROL FINE-ADJUSTMENT	18
■ Other features	
SUB-WOOFER SYSTEM	20
BALANCE/FADER CONTROL	22
SELECTABLE ILLUMINATION	24
■ Installation	
ACCESSORIES	25
PROCEDURE	26
CONNECTION	27
INSTALLATION	28
■ TROUBLESHOOTING GUIDE	29
■ SPECIFICATIONS	30

DIGITAL SIGNAL PROCESSOR

The DSP (Digital Signal Processor) simulates the acoustic effects of a concert hall, etc. based on digital control of the components of sound.

The components of sound we hear can be divided into the "direct sound" which attains our ears directly from the source such as a musical instrument, and into the "reverberation sound" which attains our ears after reflections on the walls, ceiling and floor. The reverberation sound includes sound reflected several times as well as sound reflected only once. The level of the sound is decreased every time it is reflected by an object.

The sound decrease caused by several reflections is referred to as the "reverberation level", and the difference in time between the moment the direct sound arrives and the moment the reverberation sound arrives is referred to as the "delay time".

■ How to enjoy the effect of DSP

The basic way to enjoy the effects of DSP is to select the hall simulation and digital equalizer effects according to the genre of music played. For example, the following selections may provide the music with the feeling of presence easily.

- To play rock music:
Hall simulation Set to Dance hall.
Digital equalizer Set to Loudness.
- To play classical music:
Hall simulation Set to Concert.
Digital equalizer Set to Classic.

The hall simulation and digital equalizer effects can be selected freely, without caring the names given to them. For example, the following selections will expand the way you can enjoy the DSP.

- To enjoy music in an ambience of a large listening room, not in the narrow compartment of a car:
Hall simulation Set to Jazz club.
Digital equalizer Set to Live house.
- To play music as a background music to create a suitable atmosphere of your conversations:
Hall simulation Set to Concert.
Digital equalizer Set to Pops.

Try various combinations and find those which meet your listening conditions and taste best. In addition, the digital sound processing allows to attenuate the vocal in music (Vocal Cut) and play the instrumental only.

- **Hall simulation (P. 7)**
This feature simulates the acoustic effects of a concert hall, etc., by controlling the components of sound which are the reverberation level and delay time.
- **Digital equalizer (P. 8)**
This unit incorporates an equalizer system based on digital processing. Six kinds of equalizer curves are preset in memory for use in accordance with the genre of music.
- **Position control (P. 10)**
This feature allows to adjust the hall simulation effects according to the listener's position.
- **KBS (KENWOOD Built-in Sound) (P. 12)**
KENWOOD has programmed three combinations of the hall simulation, digital equalizer and position control settings, suited for different genres of music, and stored them in preset memory. This feature allows to set the hall simulation, digital equalizer and position control without time-consuming adjustments.
- **DSP memory (P. 13)**
You can also combine the desired hall simulation, digital equalizer and position control settings and store them in memory. Once stored in memory, these combinations of the hall simulation, digital equalizer and position control settings can be recalled by one-touch operation.
- **Hall simulation adjustment (P. 14)**
This feature allows to adjust the two factor of hall simulation, the reverberation level and delay time.
- **Digital equalizer adjustment (P. 16)**
This feature allows to form digital equalizer curves based on the adjustments of frequency bands centered around 40, 100, 250, 585, 1.25 k, 5 k and 16 kHz. The adjustment range is between -12 and +12 dB for each band.
- **Position control fine-adjustment (P. 18)**
After the position control has been set, this feature fine-adjusts the setting to compensate for the position difference of each vehicle.
- **Sub-woofer system (P. 20)**
This unit incorporates the sub-woofer output. The sub-woofer system allows the adjustments of the output level and the cut-off frequency.
- **Selectable illumination (P. 24)**
The color of the illumination can be switched between green and orange.
- **Automatic illumination**
Keeping connected the Automatic illumination control lead, during the power is OFF, turning ON the car's light control the illumination light up.



VOLUME CONTROL

Turning this knob clockwise, increases the volume, and turning counterclockwise, decreases.

➔ The set volume is displayed in decibels for 5 seconds.

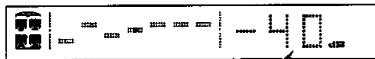

Volume dB display

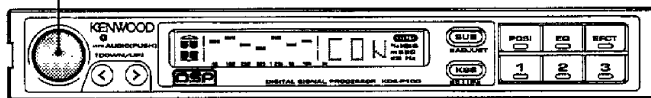

NOTE

- To adjust the volume, use the volume controller knob of this unit and do not use the center unit (cassette receiver, etc.). Increase the volume of the center unit below the point of distortion and do not change the volume. Do not control the volume on the center unit, for this may cause noise. Also do not attempt to control the volume with the remote control unit supplied with the center unit, for this results in changing the volume setting of the center unit.

HALL SIMULATION

Press the Effect button to change the hall simulation position in this order: Concert, Stadium, Church, Jazz club, Dance hall, Surround, Vocal cut, and OFF.

➔ The selected hall simulation name is displayed.

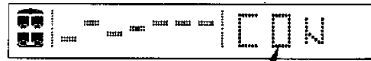

Hall simulation name display



Hall simulation name Hall simulation display	Position and effect	Reverberation level (%)	Delay time (ms)
Concert CON	Gives sense of live performance in a large hall, turns car interior into large acoustic space. Use also to listen to any source as background music.	50	30
Stadium STA	Fills the space with the uninhibited sound a stadium-sized hall.	75	60
Church CHU	Reproduces the sound quality of a traditional European church. Ideal for classical music played by small ensembles.	25	80
Jazz club CLB	Gives a sense of a live performance in an intimate jazz club. Provides listening room acoustics, for a sense of somewhat greater space.	25	15
Dance hall Dnc	Provides good harmonics and the strong beat of the hot dance hall sound.	50	30
Surround SUR	Wraps the listener in sound.	—	—
Vocal cut V-C	Blanks cut the vocals for orchestra-only effect.	—	—
OFF OFF	The through position, for reproduction without added effects.	—	—

NOTE

- When radio reception is poor, you may hear noise if you select the Surround, Vocal cut position; we advise choosing another position.
- The full Vocal cut effect may not be available, depending upon the quality of the recording or the way in which it was made.

DIGITAL EQUALIZER

Press the Equalizer button to change the mode in this order: Pops, Loudness, Vocal, Live house, Classic, and OFF (Flat).

➔ The selected equalizer curve is recalled, and the equalizer curve name is displayed for 5 seconds.

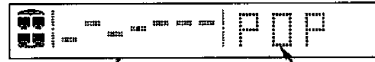

Equalizer curve display

Equalizer curve name display



■ EQUALIZER CURVES

The following preset digital equalizer curves are available. Pick the one you prefer; the name are suggestions only.

1. POPS

Adds modulations to instrumental and vocal music.

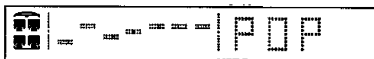

2. LOUDNESS

Reproduces a crisp sound by enhancing the high and low frequencies. Effective when listening at a low volume.

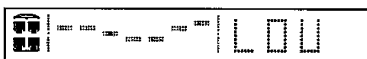

3. VOCAL

Emphasizes the human vocal range, intensifies the vocal coloration for greater immediacy.



4. LIVE HOUSE

Reproduces a life-performance feel and the distinctive sound of each instrument in a small ensemble.

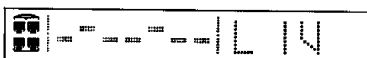

5. CLASSIC

Ideal for reproducing full orchestral sound; pyramidal structure with contrabass as base.

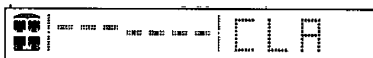

6. OFF (Flat)

No equalizer effect, for the natural sound.

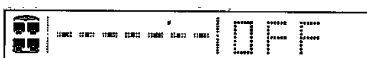

POSITION CONTROL

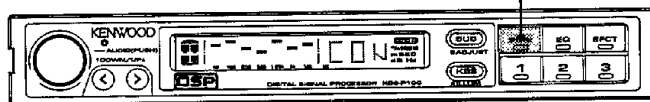
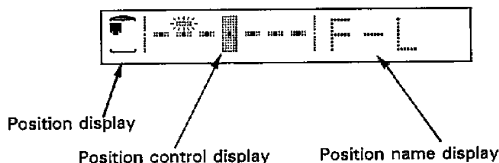

Press the Position button to change the mode in this order:
Front left, Front right, Front, Rear and All.

➔ The display changed according to the selected position.
(The position control indicator and the position name display are displayed for 5 seconds.)

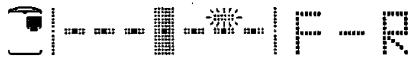

NOTE

- The position control adjusts the DSP effect, not volume.
- When the position control is set, the balance control is reset to the center position.

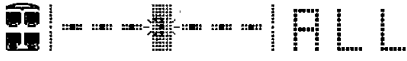
Position	Position display
Front left	
Front right	
Front	
Rear	
All	



KBS (KENWOOD Built-in Sound)

1

Briefly press the KBS button.
➔ The KBS indicator lights up.

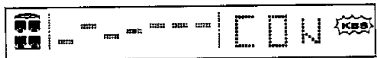

TO RELEASE

Press the KBS button.
➔ The KBS indicator disappears
and the KBS feature is
cancelled.



2

Press one of preset memory buttons 1 to 3.
➔ The hall simulation, digital equalizer and position control settings stored under the button is recalled.

Preset button 1
Hall simulation...Concert
Digital equalizer...Pops
Position control...Front left

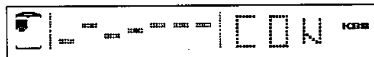

Preset button 2
Hall simulation...Church
Digital equalizer...Classic
Position control...Front

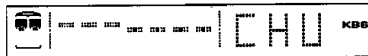

Preset button 3
Hall simulation...OFF
Digital equalizer...Flat
Position control...All

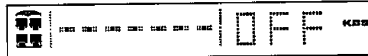

DSP MEMORY

1

Adjust the hall simulation, digital equalizer and position control to make the combination to be stored in memory.

2

Press one of memory buttons 1 to 3 and hold it for more than 2 seconds.
→ A beep sound is generated when the combination has been stored under the pressed button.



3

By repeating steps 1 and 2, up to three combinations of DSP settings can be stored under memory buttons 1 to 3.

4 TO RECALL

Briefly press the Memory button.
→ The stored DSP settings is recalled.

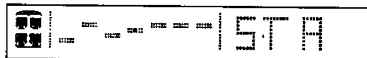

NOTE

- The contents of the hall simulation adjustment and position control fine-adjustment at the moment of the DSP memory storage operation are also stored.

HALL SIMULATION ADJUSTMENT

1

Select the hall simulation to be adjusted.

➔ The selected hall simulation name is displayed.



3 TO ADJUST REVERBERATION LEVEL

- To decrease the reverberation level:

Turn the Audio controlled counterclockwise.

The level can be decreased in 25% step down to 0%.

➔ The adjusted reverberation level is displayed.



Reverberation level

2

Press the Effect button for more than 1 second.

➔ The DSP adjustment mode is initiated.

3 TO ADJUST DELAY TIME

- To shorten the delay time:

Press the < button.

The time can be decreased in 5 ms step down to 0 ms.

➔ The adjusted delay time is displayed.

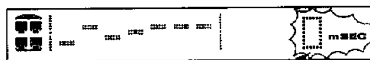

Delay time

NOTE

- The adjusted contents are automatically stored in memory so the adjusted values are recalled when the hall simulation is recalled the next time.
- The hall simulation adjustment is not possible with OFF, Surround, and Vocal Cut.

- **To increase the reverberation level:**

Turn the Audio controlled clockwise.
The level can be increased in 25% step up to 100%.
➔ The adjusted reverberation level is displayed.

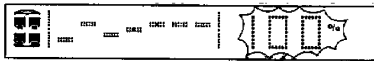

Reverberation level

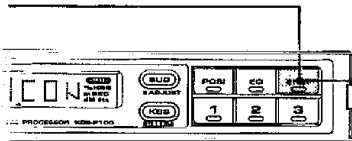

TO RELEASE

Press and hold the Effect button for more than 1 second or perform no operation for 5 seconds.
➔ The DSP adjustment mode is terminated.

- **To lengthen the delay time:**

Press the > button.
The time can be increased in 5 ms step up to 100 ms.
➔ The adjusted delay time is displayed.

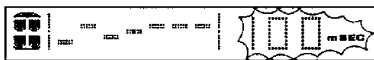

Delay time

DIGITAL EQUALIZER ADJUSTMENT

1

Press the Equalizer button for more than 1 second.

➔ The digital equalizer adjustment mode is initiated.

3 TO DECREASE LEVEL

Turn the Audio control counterclockwise while the band to be adjusted is shown in inverted display.

The level of the band can be decreased down to -12 dB.

➔ The level indicator moves downward.

2

Select the frequency band to be adjusted with the < and > buttons.

Press the < button to shift the band toward the left, or press the > button to shift it toward the right.

➔ The adjustable band is displayed in inverted display for 5 seconds.

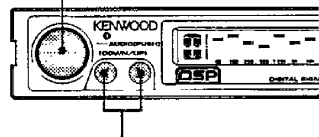
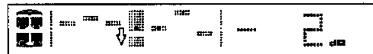

NOTE

- The adjusted contents are cleared when another digital equalizer curve is recalled.

3 TO INCREASE LEVEL

Turn the Audio control clockwise while the band to be adjusted is shown in inverted display. The level of the band can be increased up to +12 dB.
➔ The level indicator moves upward.

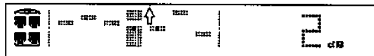

4

Adjust all frequency bands by repeating steps 2 and 3 for each of them.

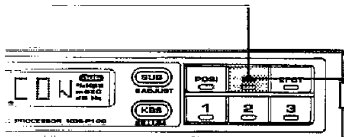

TO RELEASE

Press and hold the Equalizer button for more than 1 second or perform no operation for 5 seconds.
➔ The digital equalizer adjustment mode is terminated.

POSITION CONTROL FINE-ADJUSTMENT

1

Select a position as described on page 10.

3

Turn the Audio control so that you can feel the hall simulation effect best.

Turning the control clockwise fine-adjusts the listening position in order of: front ⇒ right ⇒ rear ⇒ left ⇒ center.

Turning the control counterclockwise reverses this order.

➔ The fine-adjustment direction is displayed according to the Audio control position.

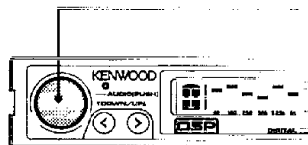

2

Press the Position button for more than 1 second.

➔ The position indicator blinks, indicating the position control adjustment mode.



NOTE

- The fine-adjustment is not possible if the position control is set to "All".
- When the position control fine-adjustment is started, the balance control is reset to the center position.
- The fine-adjusted contents are automatically stored in memory so the fine-adjusted position is recalled the next time.

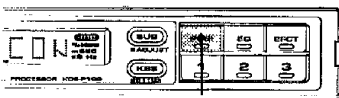
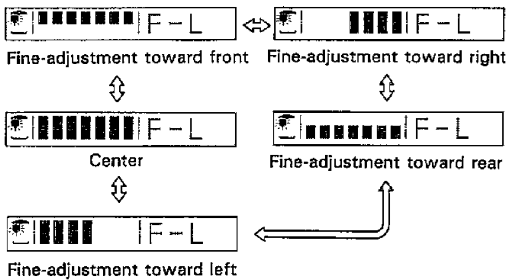

TO RELEASE

Press and hold the Position button for more than 1 second or perform no operation for 5 seconds.

- ➔ The position control fine-adjustment mode is terminated.

SUB-WOOFER SYSTEM

1

- Press the Sub-woofer button.
➔ The sub-woofer indicator lights up and the sub-woofer signal is output.

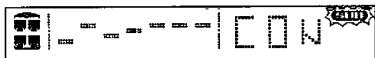

■ Adjustment

1

- Press and hold the Sub-woofer button for more than 1 second.
➔ The sub-woofer indicator blinks, indicating the sub-woofer adjustment mode.

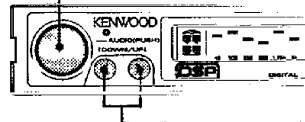
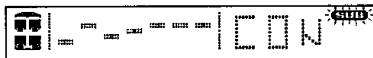

TO RELEASE

- Press the Sub-woofer button.
➔ The sub-woofer indicator is extinguished and the sub-woofer output is turned off.

TO RELEASE ADJUSTMENT

- Press the Sub-woofer button.
➔ The sub-woofer adjustment mode is terminated.

NOTE

- The sub-woofer adjustment is possible while the sub-woofer system is ON.

2 TO ADJUST OUTPUT LEVEL

- **To decrease output level:**

Turn the Audio controlled counterclockwise.
The level can be decreased in 2 dB step down to $-\infty$ dB.
→ The adjusted output level is displayed.

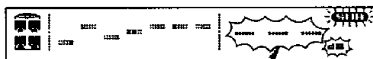

Output level

- **To increase output level:**

Turn the Audio controlled clockwise.
The level can be increased in 2 dB step up to +10 dB.
→ The adjusted output level is displayed.

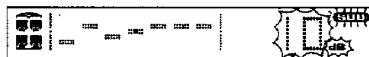

Output level

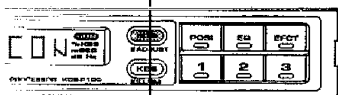

2 TO ADJUST CUT-OFF FREQUENCY

- **To decrease the cut-off frequency:**

Press the < button.
The frequency can be adjusted in 3 steps of 50, 80 and 120 Hz.
→ The adjusted frequency is displayed.

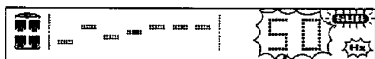

Cut off frequency

- **To increase the cut-off frequency:**

Press the > button.
The frequency can be adjusted in 3 steps of 50, 80 and 120 Hz.
→ The adjusted frequency is displayed.

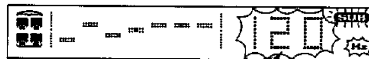

Cut off frequency

BALANCE/FADER CONTROL

1

Briefly press the Audio button will enable the Balance/Fader control. Unless it is pressed, Volume and it becomes possible to adjust in the order of Balance and Fader and back to Volume if briefly press every time.

2

Adjustment will be made by the Audio controller respectively. For operations and display, refer to the following table.







TO RELEASE

If the Audio button is pressed for more than 1 second or if no operation is performed within 5 seconds, the unit returns to the volume adjustment mode.

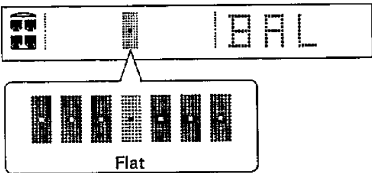
NOTE

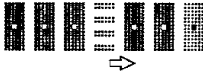
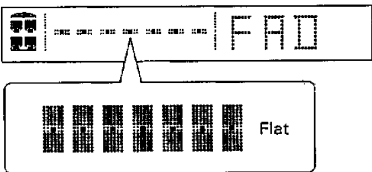
- If you set the position to other than "All" after adjusting the balance, the result will be skewed.

Display	Operation of Audio controller	
	Turn counterclockwise	Turn clockwise
<p>Adjust the Balance of the right and left channels</p> 	<p>The left sound will be emphasized.</p> 	<p>The right sound will be emphasized.</p> 
<p>Adjust the Balance of front and rear channels</p> 	<p>The front sound will be emphasized.</p> 	<p>The rear sound will be emphasized.</p> 









SELECTABLE ILLUMINATION

Every time the Illumination button is pressed for more than 1 second, it will switch over between the colors of green and orange.

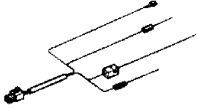

ACCESSORIES

Part name	External View	Number of units
Panel frame		1
Side bracket		2
Bracket		2
Power connection cord		1
Tapping screw ($\phi 4 \times 16$)		4
Flat head screw (M4 \times 6)		2
Washer assembly screw (M4 \times 8)		3

11

PROCEDURE

- ① Before installation and wiring, remove the ⊖ terminal of the battery to prevent short-circuiting.
- ② Connect the input and output cords of the system. (⇨ P. 27)
- ③ Connect the Ground lead (Black) to the metal chassis of the car. (⇨ P. 27)
- ④ Connect the Power supply lead (Yellow). (⇨ P. 27)
- ⑤ Install the unit in the car. (⇨ P. 28)
- ⑥ Connect the negative ⊖ terminal of the disconnected battery.
- ⑦ After installation, surely press the Reset button.

INSTALL

▲ CAUTION

- A short-circuit may be the cause of blown fuse. A short-circuit is a serious problem that can lead to a fire. Check the wiring and rewire if any wires are short-circuited. After this (or if no short-circuits are found), replace the fuse with one having the same capacity (see indication in fuse box).
- Make sure that unconnected wires and connectors are not in contact with the live chassis (ground) of the car to prevent noise and current from entering the system which can cause it to malfunction or damage the unit. For the same reason, caps on connectors that are not used should not be removed.

CONNECTION

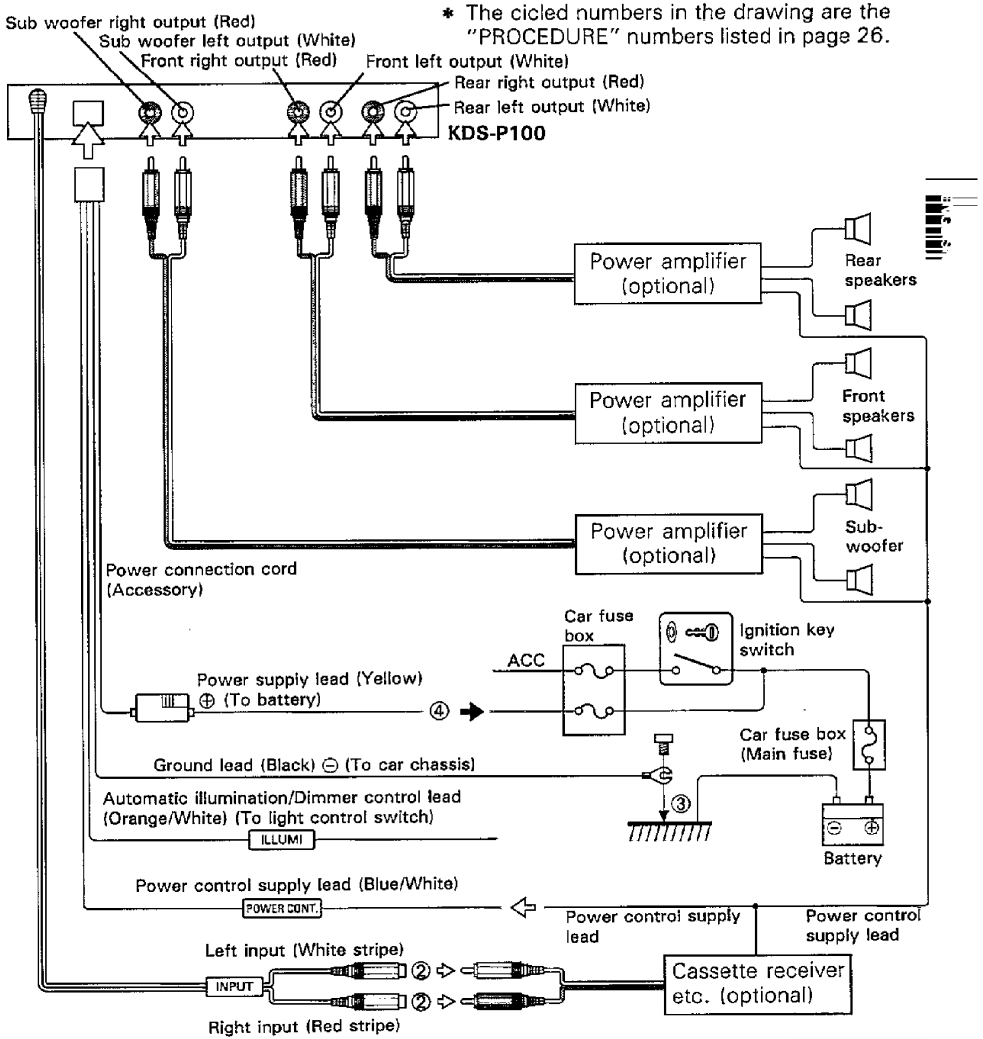

NOTE

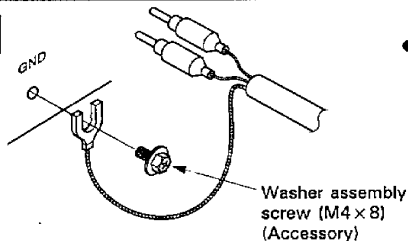

- If the RCA extension cable (optional) is provided with a GND wire, then, fix it into the threaded hole for GND on the rear of the main unit.

INSTALLATION

- When installing in the car, choose the best position with regard to overall safety of the system and ease of operation.
- As installation fixtures, use only the accessories supplied.

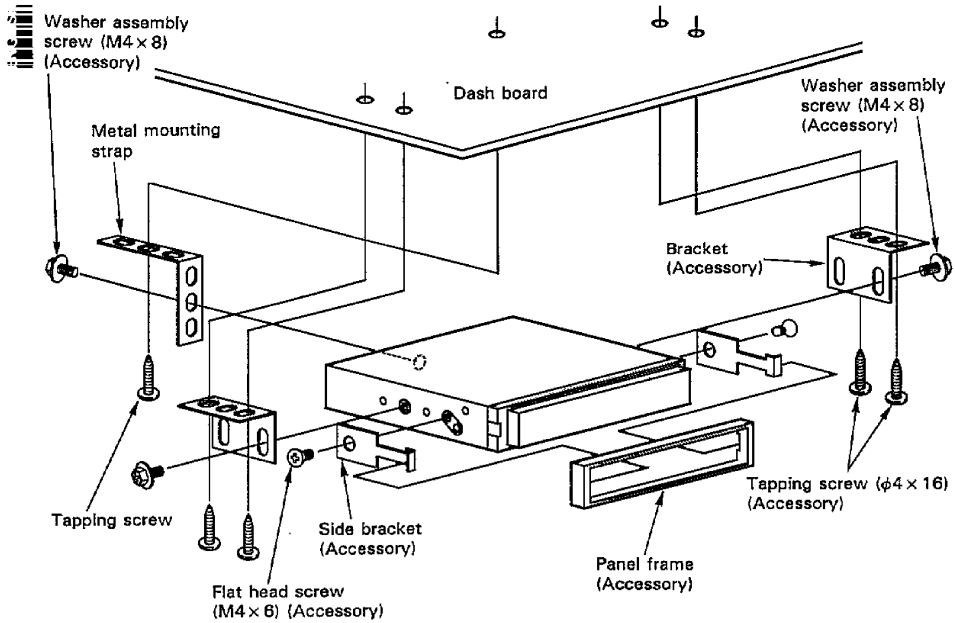

TROUBLESHOOTING GUIDE

What often appears to be a malfunction is often due to user error in operation or connection. When trouble occurs with your unit, please check the following before calling for service.

Symptom	Cause	Remedy
No power.	<ol style="list-style-type: none"> 1. The power is off on the center unit. 2. The center unit is set all mode stand by. 3. The power cord fuse has blown. 	<ol style="list-style-type: none"> 1. Turn the center unit on. 2. End all mode stand by on the center unit. 3. Check for a short in the power cord, then replace the fuse.
No sound.	<ol style="list-style-type: none"> 1. The speaker cord, system power, input, or output cords are not connected properly. 2. The volume level of the center unit is low. 3. The fader or balance adjustment is skewed to one side. 	<ol style="list-style-type: none"> 1. Follow the instructions in this manual and connect correctly. 2. Increase the volume of the center unit. 3. Reset the fader or balance adjustment.
No DSP effect.	<ol style="list-style-type: none"> 1. You have a 2-speaker system. 2. The front and rear output are reversed. 3. The left and right speakers are reversed. 4. The speaker's plus (+) and minus (-) are reversed. 5. The fader or balance adjustment is skewed. 	<ol style="list-style-type: none"> 1. Install a 4-speaker system (front and rear). 2. Follow the instructions to connect correctly. 3. Follow the instructions to connect correctly. 4. Follow the instructions to connect correctly. 5. Set the fader and balance to the center position.
Memory is wiped out when the engine stops.	The Power supply lead is not connected.	Follow the instructions to connect correctly.

111111

SPECIFICATIONS

DSP Section

A/D converter	64 times over sampling, $\Delta\Sigma$ modulation
D/A converter	1 Bit, 192 time over sampling $\Delta\Sigma$ modulation
Equalizer center frequency.....	40 Hz, 100 Hz, 250 Hz, 585 Hz, 1.25 kHz, 5 kHz, 16 kHz
Equalizer range.....	- 12 ~ + 12 dB
Frequency response.....	20 Hz ~ 20 kHz (± 1 dB)
Total harmonic distortion	0.005% (1 kHz)
Signal-to-noise ratio	100 dB
Dynamic range	96 dB

Audio Section

Input impedance	10 k Ω
Preout level	1.0 V

General

Operating voltage	14.4 V (11 ~ 16 V)
Current consumption (MAX)	0.9 A
Installation size (W x H x D).....	178 x 25 x 140 mm (7 x 1 x 5-1/2 in.)
Weight	0.9 kg (2.0 lb)

KENWOOD

Free Manuals Download Website

<http://myh66.com>

<http://usermanuals.us>

<http://www.somanuals.com>

<http://www.4manuals.cc>

<http://www.manual-lib.com>

<http://www.404manual.com>

<http://www.luxmanual.com>

<http://aubethermostatmanual.com>

Golf course search by state

<http://golfingnear.com>

Email search by domain

<http://emailbydomain.com>

Auto manuals search

<http://auto.somanuals.com>

TV manuals search

<http://tv.somanuals.com>