

KENWOOD

e X c e l o n

KFC-XW1100DVC
KFC-XW1300DVC

SUBWOOFER
INSTRUCTION MANUAL

KENWOOD CORPORATION

380563

IMPORTANT SAFEGUARDS

 **Caution : Read this page carefully for your safety.**

1. Suffocation — After taking the unit out of the polyethylene bag, be sure to dispose of the polyethylene bag out of the reach of children. Otherwise, they may play with the bag, which could cause a hazard of suffocation.



2. Power supply voltage — Connect the illumination lamp-equipped speakers to DC 12V, negative ground.

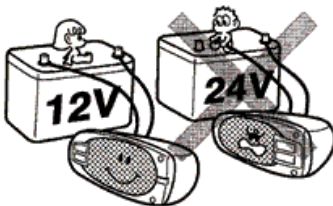

3. Water and moisture — Do not install the speakers in locations which may be subject to water or moisture.

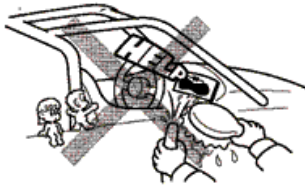

4. Dust and unstable locations — Do not install the speakers in unstable locations or locations subject to dust.



5. Modification — Do not attempt to open or modify the unit, for this could cause fire hazard or malfunction.

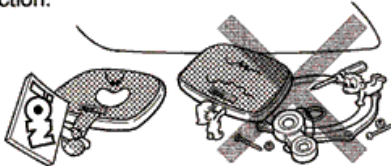

6. Cleaning — Do not use gasoline, naphtha, or any type of solvent to clean the speakers. Clean by wiping with a soft, dry cloth.

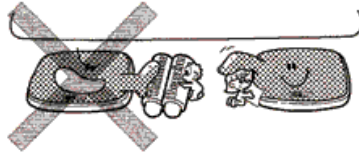

7. Abnormal smell — In the event the unit generates smoke or abnormal smell, immediately switch the power OFF. After this, please contact your dealer or nearest service station as soon as possible.

POWER OFF!



8. Ventilation hole — Do not insert your finger into the ventilation holes on the back plate of speaker, for this could hurt your finger by VC coil bobbin.

9. Heat — Do not touch the speaker while in use. The surface of speaker becomes very hot when it plays and you could get burned.

Do not install this speaker near the fuel tank, for the heat could cause fire hazard.

10. Fuse — Do not use the fuse with a different value except 25A, for it could damage the speaker.

Note:

Observe the following cautions to prevent damage to the speakers.

- You cannot input the same power as "peak power" continually.
- When the volume is set too high, the sound may be distorted or abnormal. Reduce the volume promptly when such a sound is heard.
- While the listening volume is set to a high level, do not load or eject a disc or cassette tape or operate the selector and-power switches of the amplifier.

Greeting

Dear Customer,

Congratulations on your choice of a Kenwood Subwoofer. Kenwood is known world-wide for producing some of the most advanced car audio products on the market, and our new Subwoofer is the result of the latest research in speaker technology. Installed properly, your Subwoofer will have unparalleled low frequency response for your system.

You can install your Subwoofer in a sealed or ported enclosure with excellent results. Your choice will depend on the kind of bass sound you like best. On pages 6-7, we show you the different kinds of bass sound that you'll get from different sizes and styles of enclosures.

Design Features

- PBO Tornado Cone- this 2-piece cone design uses PBO advanced fiber and a Tornado shape to insure high rigidity and minimal distortion
- Cast Aluminum Basket- this 2-piece anti-resonant design improves sound quality and helps power handling
- Multi-Bias Magnetic Circuit- Two separate magnetic circuits centered within the woofer improve linearity and accuracy of cone travel
- Upper and Lower Dampers- Two dampers are used for linearity and accuracy of cone travel
- Large One Piece Surround and Gasket- Reduces vibrations of the basket thus reducing noise
- Large 2-piece Magnet – provides greater control for accurate bass
- Vented Pole Piece with Heat Sink Fins- This design allows maximum heat dissipation resulting in increased power handling
- Long throw Voice Coil- Improves linearity of movement and allows higher output while minimizing distortion
- Gold Plated Dual Banana Terminals- Allow for large gauge speaker wire and maximum signal transmission using Screw connections or banana connectors

Specifications

	KFC-XW1100DVC	KFC-XW1300DVC
Subwoofer	290mm(11") PBO CONE TYPE	346mm(13") PBO CONE TYPE
Nominal Impedance	3Ω + 3Ω	3Ω + 3Ω
Peak Input Power	1600W	2000W
Rated Input Power	400W + 400W	500W + 500W
Sensitivity	79 dB/W at 1 m	82 dB/W at 1 m
Free Air Resonance	36 Hz	30 Hz
Frequency Response	20Hz~1kHz	17Hz~1kHz

	KFC-XW1100DVC	KFC-XW1300DVC
Dimensions		
Diameter	290.6mm(11.4")	346mm(13.6")
Depth	238.6mm(9.4")	268.7mm(10.6")
Mounting Depth	217mm(8.5")	246mm(9.7")
Net Weight	11.5kg	18kg
Supplied Parts	Screw ø 6-30×8 Gasket Tape×1	Screw ø 6-30×8 Gasket Tape×1

Building the Enclosure

1. Select the type and size of the enclosure of your choice from the performance charts on pages 6-7.
2. Determine the internal length, width, and depth of the enclosure. Caution: Make sure the mounting depth of the subwoofer fits into the dimensions of your enclosure and make sure the box fits in the desired position in your vehicle. KENWOOD recommends a cubic shape, however same length sides cause resonance due to standing waves so it's better to slightly change the lengths.

$$\text{Internal Enclosure Volume (cu.ft)} = \frac{\text{Height (inch)} \times \text{Width (inch)} \times \text{Depth (inch)}}{1728}$$

3. Cut wood, taking into account the thickness of the material being used. We recommend using MDF (Medium Density Fiberboard) or HDP (High Density Particleboard). We also recommend using a table saw for straight cuts to prevent air leakage once assembled.
4. Assemble enclosure. Use glue when assembling the sides of the enclosure.
5. Cut hole(s) in the baffle board. Use a template to make the subwoofer hole the appropriate size.
6. Seal enclosure using silicon or siliconized caulk on the internal seams.
7. Bring speaker cables into enclosure through rear of enclosure. Make sure to seal the speaker cable hole or terminal cup.
8. Stuff damping material such as dacron or fiberglass inside the enclosure.
9. Use 2 or 3 layer MDF and bracings (See Fig.1) for reinforcing speaker box for best performance if possible. Use 21mm (3/4 inch) thick Medium Density Fiberboard (MDF) or High Density Particleboard.

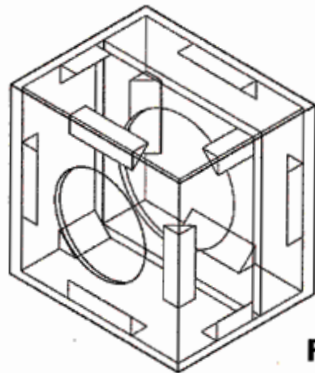

Fig. 1

Installation

1. Attach the included gasket tape to the back of the speaker flange as shown in Fig.2 so that the flange is completely covered.
2. Attach the speaker cables to the speaker terminals by the method of your choice.
3. Complete installation by installing subwoofer into enclosure with the provided screws.

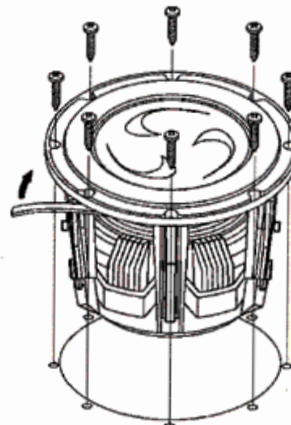

Fig. 2

System Connections

First, check the power of the amplifier. If the power of amplifier is higher than the subwoofer's rated input power, increase the number of subwoofers so that the power per subwoofer is lower than the rated input power, or lower the sensitivity of the amplifier. Supplying power greater than the rated input power of the subwoofer will cause noise and/or breakage. Also, if using multiple subwoofers, be careful about the total impedance. Change the connecting pattern of the speakers according to the capable impedance of the amplifier.

KFC-XW1100-DVC/KFC-XW1300-DVC

■ Series Wiring

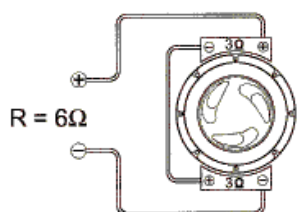

$$R = 3 + 3 = 6\Omega$$

Fig. 3

■ Parallel Wiring

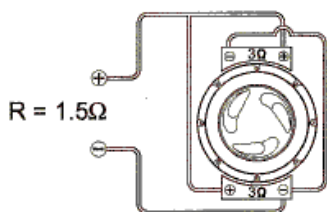

$$R = \frac{1}{\frac{1}{3} + \frac{1}{3}} = 1.5\Omega$$

Fig. 4

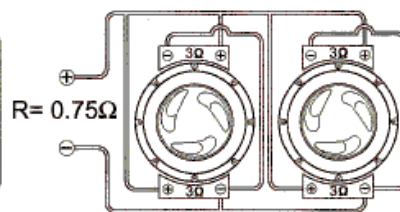

$$R = \frac{1}{\frac{1}{3} + \frac{1}{3} + \frac{1}{3} + \frac{1}{3}} = 0.75\Omega$$

■ Series-Parallel Wiring

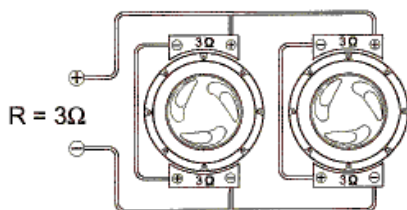

$$R = \frac{1}{\frac{1}{6} + \frac{1}{6}} = 3\Omega$$

Fig. 5

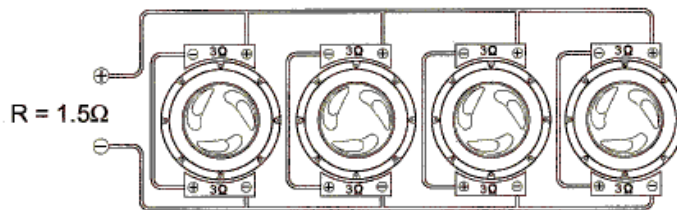

$$R = \frac{1}{\frac{1}{6} + \frac{1}{6} + \frac{1}{6} + \frac{1}{6}} = 1.5\Omega$$

Fig. 6

Use a crossover network of your choice with an appropriate cutoff frequency.

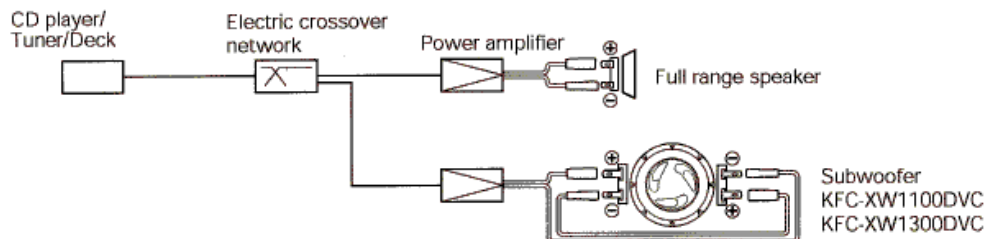
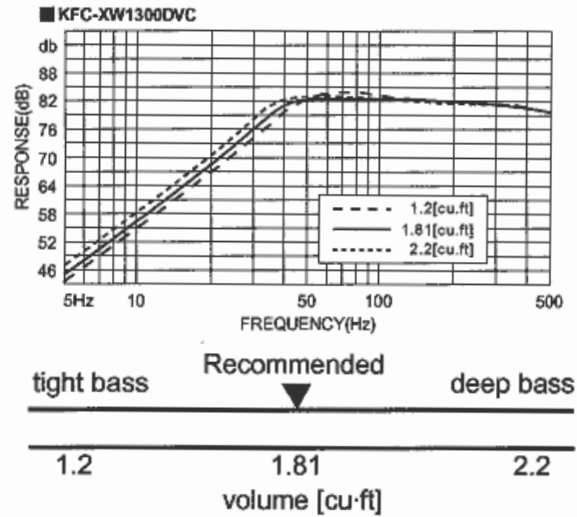
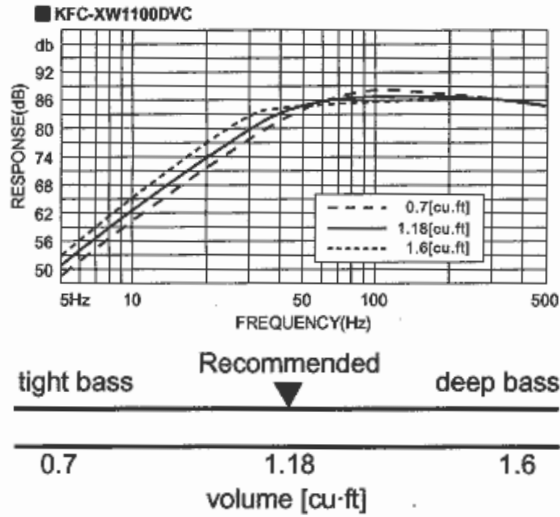
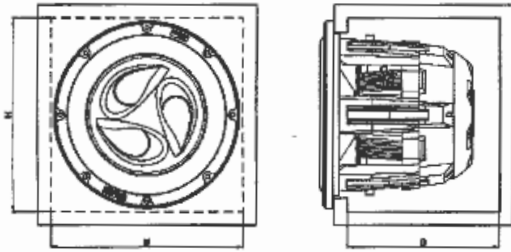

Fig. 7

Recommended Enclosures (including woofer displacement)

■ SEALED



■ PORTED

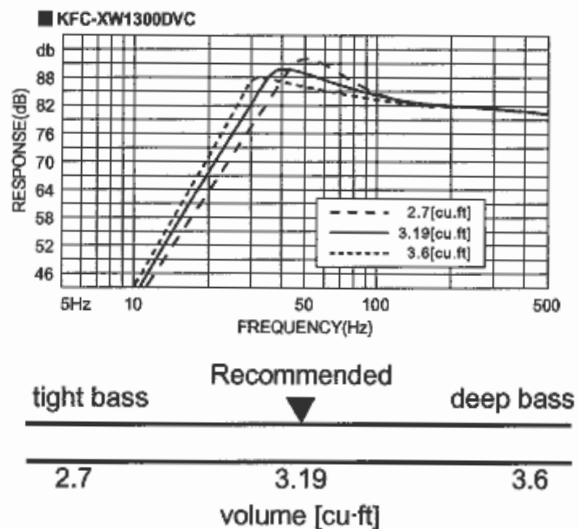
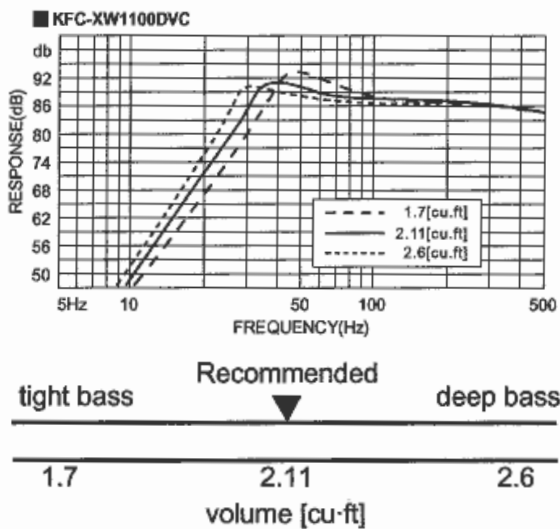
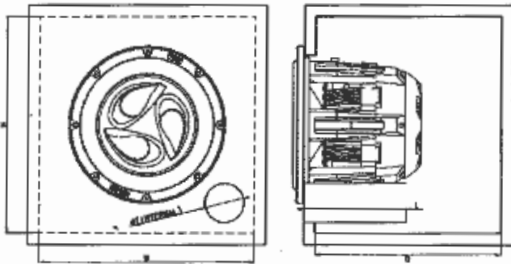

Recommended Enclosures (including woofer displacement)

*W, H, DInternal Dimensions

MODEL NAME	VOLUME	W	H	D	MOUNTING HOLE	PORT DIAMETER D	PORT LENGTH L	DISPLACEMENT
KFC-XW1100DVC	1.18	350(13.78")	350(13.78")	273(10.75")	269.5(10.61")	SEALED	SEALED	0.24
	2.11	450(17.71")	400(15.75")	332(13.07")		φ 102(4.0")	160(6.3")	
KFC-XW1300DVC	1.81	400(15.75")	400(15.75")	320(12.6")	323(12.72")	SEALED	SEALED	0.46
	3.19	600(23.62")	450(17.71")	335(13.19")		φ 102(4.0")	178(7.0")	
UNIT	cu · ft	mm (in.)						cu · ft

Use 21 mm (3/4 inch) thick Medium Density Fiberboard (MDF) or High Density Particleboard.

Dimensions

■ KFC-XW1100DVC

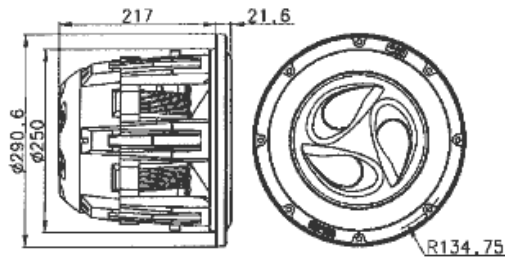

■ KFC-XW1300DVC

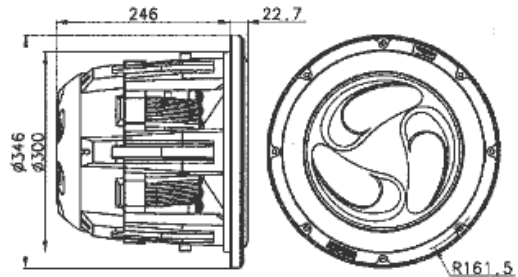

Technical Specifications

	SIGN	KFC-XW1100DVC	KFC-XW1300DVC	UNIT
Nominal Impedance	Z	3+3	3+3	ohms
DC Resistance	Re	2.6+2.6	2.6+2.6	ohms
Voice Coil Inductance	Levc	0.7	0.7	mH
Piston Area	Sd	0.0374	0.0570	Sq.m
Force Factor	BL	14.5	22	T.m
Volume Acoustic Compliance	Vas	22	55	liter
		0.777	1.945	cu.ft
Moving Mass	Mms	200	270	g
Resonant Frequency	Fs	36	30	Hz
Mechanical Q Factor	Qms	4.06	4.03	
Electrical Q Factor	Qes	1.00	0.52	
Total Q Factor	Qts	0.81	0.46	
Peak Excursion	Xmax	14	13	mm
Peak Power Handling		1,600	2,000	W
RMS Power Handling		400+400	500+500	W
Sensitivity (1 W/1 m)		79	82	dB
Displacement		6.9	13	CC
		0.24	0.46	cu-ft
Mounting Depth		217 (8-1/2)	246 (9-22/32)	mm (in.)
Weight of Magnet	M	3,100 (109)	4,960 (175)	g (oz.)
Voice Coil Diameter	d	65 (2-9/16)	80 (3-5/32)	mm (in.)

KENWOOD

Free Manuals Download Website

<http://myh66.com>

<http://usermanuals.us>

<http://www.somanuals.com>

<http://www.4manuals.cc>

<http://www.manual-lib.com>

<http://www.404manual.com>

<http://www.luxmanual.com>

<http://aubethermostatmanual.com>

Golf course search by state

<http://golfingnear.com>

Email search by domain

<http://emailbydomain.com>

Auto manuals search

<http://auto.somanuals.com>

TV manuals search

<http://tv.somanuals.com>