

KENWOOD

ADVANCED INTEGRATION A/V CONTROLLER

KOS-V500

INSTRUCTION MANUAL

Kenwood Corporation



Contents

How to read this manual	4
Safety precautions	6
Notes	7

USB Device Control	18
Functions when Displaying the Easy Control Panel	18
Functions while Displaying the Control Screen	18
USB List	19
Folder Select	20

Music Disc Listening	21
Functions When Displaying the Easy Control Panel	21
Functions While Displaying the Control Screen	22
Set Disc Name	22
Disc Select	23
Direct Search	23

Radio Listening	24
Functions When Displaying the Easy Control Panel	24
Functions While Displaying the Control Screen	24
Seek Mode	25
Auto Memory	26
Manual Memory	26
Preset Select	27
Radio Text	27
Direct Search	28
Traffic Information	28
Search for Program Type	29

iPod Control	30
Connecting an iPod	30
Functions when Displaying the Easy Control Panel	30
Functions while Displaying the Control Screen	31
iPod List	32

Basic Operations	10
-------------------------	-----------

TV Watching	34
Functions During TV Screen	34
Functions When Displaying the Easy Control Panel	34
Functions While Displaying the Control Screen	35
Seek Mode	35
Auto Memory	36
Manual Memory	36
Preset Select	37
Set Station Name	37

Video Watching	38
Functions When Displaying the Easy Control Panel	38
Functions While Displaying the Control Screen	38

DAB Tuner Control	39
Functions When Displaying the Easy Control Panel	39
Functions While Displaying the Control Screen	39
Seek Mode	40
Auto Ensemble Memory	41
Service Preset Memory	41
Service Select	42
Language Filter Setting	42
Search for Program Type	43
DAB Announcement	43

Source Select	44
Displaying the Control Screen	44

External Device Power Supply Control	45
External Device Power Supply Control	45

Muting Audio Volume upon Reception of Phone call 46

Muting Audio Volume upon Reception of Phone Call 46

Character Entry 47

How To Use the Character Entry screen 47

Screen Control 48

Screen Control 48

Hands Free Unit Control 49

Control Screen Function 49
When Called 50
When Dialing 50
Quick Dialing 51
Calling by Phone Book 51
Redialing 53
Setting up the Hands-Free Phone 54
Selecting a Hands-Free Phone 54
Deleting the Hands-Free Phone 55

Setup Menu 56

Setup Menu 56
Audio Setup 56
Crossover Network Setup 57
iPod Setup 57
Software Information 57
System Setup 58
AV Interface Setup 58
User Interface 60
Entering background 62
Background Delete 62
Background Select 63
Touch panel Adjustment 63
Clock Setup 64
Monitor Setup 64
Security Code Setup 66
TV Setup 67
RDS Setup 68
DAB Setup 68
Announcement Select 69
AMP Control 69
Setup Memory 70
EXT SW Setup 72

Audio Control 74

Audio Control menu 74
Audio Control 74
Equalizer Control 75
Tone setup 76
Zone Control 76

Help? Troubleshooting 78**Help? Error 79****Accessories 80****Installation Procedure 81****Connection 82****Connecting Wires to Terminals 84****System Connection 85****Optional Accessory Connection 86****Installation 88****Specifications 90**

How to read this manual

This manual uses illustrations to explain its operations.

The displays and panels shown in this manual are examples used to provide clear explanations of the operations. For this reason, they may be different from the actual displays or panels used, or some display patterns may be different.

▼ : Continues to the next line.
● : Ends here.

Short Press

Press the button, denoted by .

Continue to the next page

The instruction continues to the next page. Make sure to flip the page for the rest of the instruction.

Seek mode

Sets a station selection.

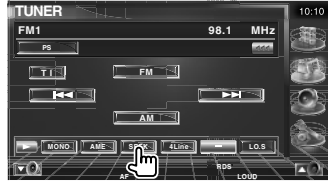

The mode is switched in following order each time you touch the button.

Display	Setting
"AUTO1"	Tunes in a station with good reception automatically.
"AUTO2"	Tunes in stations in memory one after another.
"MANU"	Switches to the next frequency manually.

Manual Memory

Stores the current receiving station in memory.

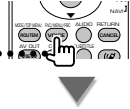

1 Select a station you wish to store in

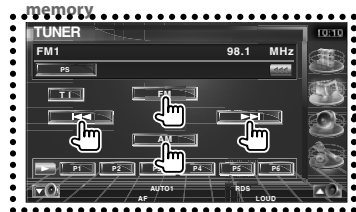

2 Store in memory



Next page ▶

The above operation example with the mark differs from the actual operation.

Remote controller operation

Some functions can only be used from a remote controller. In this case, the operation using the remote controller is described, showing a  mark.

The characters below indicate a remote controller mode switch setting.

If the optional monitor, KOS-L702 is connected to this unit, you can operate this unit by simply touching the buttons on the screen.

Change in the screen

With each operation, the screen changes in the order shown here.

Selecting a screen item

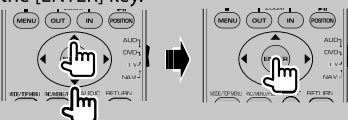

Select and choose an item on the screen.

Selects the item denoted by  using the cursor keys and confirms the selection with the [ENTER] key.



If KOS-L702 is connected, you can press the button on the screen.

Press 1 second or more

Press the button, denoted by  , for 1 second or more (2-3 seconds).

Indicates to press and hold down the button until operation starts or the screen changes. The left example indicates to press the button for 1 second.

Press it approximately for the seconds shown in the clock.

Other marks



Important precautions are described to prevent injuries etc.



Special instructions, supplementary explanations, limitations, and reference pages are described.



General precautions and reference pages are shown on the item.



The initial value of each setup is shown.

Safety precautions

▲WARNING

To prevent injury or fire, take the following precautions:

- To prevent a short circuit, never put or leave any metallic objects (such as coins or metal tools) inside the unit.
- Do not watch or fix your eyes on the unit's display when you are driving for any extended period.
- Mounting and wiring this product requires skills and experience. For safety's sake, leave the mounting and wiring work to professionals.

▲CAUTION

To prevent damage to the machine, take the following precautions:

- Make sure to ground the unit to a negative 12V DC power supply.
- Do not install the unit in a spot exposed to direct sunlight or excessive heat or humidity. Also avoid places with too much dust or the possibility of water splashing.
- When replacing a fuse, only use a new fuse with the prescribed rating. Using a fuse with the wrong rating may cause your unit to malfunction.
- Do not use your own screws. Use only the screws provided. If you use the wrong screws, you could damage the unit.

About disc changers connected to this unit

Kenwood disc changers released in 1998 or later can be connected to this unit.

Refer to the catalog or consult your Kenwood dealer for connectable models of disc changers.

Note that any Kenwood disc changers released in 1997 or earlier and disc changers made by other makers cannot be connected to this unit.

Connecting unsupported disc changers to this unit may result in damage.

Set the "O-N" Switch to the "N" position for the applicable Kenwood disc changers.

The functions you can use and the information that can be displayed may differ depending on the models being connected.



- You can damage both your unit and the CD changer if you connect them incorrectly.

Notes

- If you experience problems during installation, consult your Kenwood dealer.
- When you purchase optional accessories, check with your Kenwood dealer to make sure that they work with your model and in your area.
- The characters conforming to ISO 8859-1 character set can be displayed.
- The RDS or RBDS feature won't work where the service is not supported by any broadcasting station.
- The illustrations of the display and the panel appearing in this manual are examples used to explain more clearly how the controls are used. Therefore, what appears on the display in the illustrations may differ from what appears on the display on the actual equipment, and some of the illustrations on the display may be inapplicable.

How to reset your unit

- If the unit fails to operate properly, press the Reset button. The unit returns to factory settings when the Reset button is pressed.
- Remove the USB device before pressing the Reset button. Pressing the Reset button with the USB device installed can damage the data contained in the USB device. For how to remove the USB device, refer to <Playing a USB device> (page 12).
- Press the reset button if the disc auto changer fails to operate correctly. Normal operation should be restored.

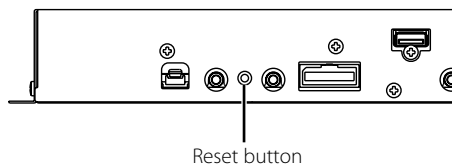

TV tuner that can be connected to this unit

- KTC-V500E
- KTC-V300E
- KTC-D500E

Navigation units that can be connected to this unit

- KNA-G520/G420
- KNA-DV3200
- KNA-DV2200

About iPod that can be connected to this unit

You can control an iPod from this unit by connecting an iPod (commercial product) with Dock connector using an optional accessory iPod connection cable (KCA-iP300V).

The following iPods can be controlled from this unit.

Controllable iPod	Software version
iPod nano	iPod nano software 1.2
iPod nano second generation	iPod nano software 1.1.1
iPod with video	iPod software 1.2

You must update your iPod software if its version is less than the above.

The iPod software version is displayed in the "Version" field by pressing the iPod MENU button and then selecting "Setting", "About". The latest iPod software updater can be downloaded from the Apple Inc. web site.

The character set supported by this unit is ISO 8859-1. Characters that cannot be displayed correctly appear as "?".

By connecting your iPod to this unit with an optional accessory iPod connection cable (KCA-iP300V), you can supply power to your iPod as well as charge it while playing music. However, the power of this unit must be on.

About Audio files

- **Playable Audio file**
AAC-LC (.m4a), MP3 (.mp3), WMA (.wma)
- **Playable AAC file**
"m4a" file encoded by AAC-LC format.
Transfer bit rate: 16–320 kbps
Sampling frequency: 16 – 48 kHz
- **Playable MP3 file**
MPEG 1/2 Audio Layer 3 file
Transfer bit rate: 8-320 kbps
Sampling frequency: 8 – 48 kHz
- **Playable WMA file**
The file in accordance with Windows Media Audio (Except for the file for Windows Media Player 9 or after which applies the new functions)
Transfer bit rate: 48 –192 kbps
Sampling frequency: 32, 44.1, 48 kHz
- **Limitation of structure for the file and the folder**
Maximum number of files per playlist: 7000
- **Playable USB device**
USB mass storage class, iPod with KCA-iP300V
- **Playable USB device file system**
FAT16, FAT32
- **About the Connection of the USB device**
If an extension cable is needed for USB device connection, usage of the CA-U1EX (option) is recommended.
Normal playback is not guaranteed when a cable other than the USB compatible cable is used.
Connecting a cable whose total length is longer than 5 m can result in abnormal playback.

Although the audio files are complied with the standards listed above, the play maybe impossible depending on the types or conditions of media or device.

Playing order of the Audio file

In the example of folder/file tree shown below, the files are played in the order from ① to ⑩.

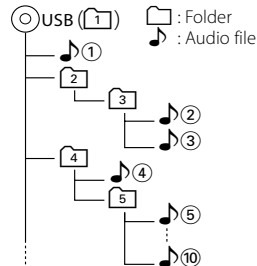

Audio files are played in the order the files are written. You can specify the order of playback by numbering files in a folder and writing them by folder.



- In this manual, the word "USB device" is used for flash memories and digital audio players which work as mass-storage-class devices.
- "iPod" in this manual refers to iPod connected with KCA-iP300V (Optional accessory). iPod connected with KCA-iP300V can be controlled from this unit. iPods that can be connected to KCA-iP300V are iPod nano and iPod with video. If you connect an iPod with commercially available USB cable, it is treated as a mass storage class device.
- For the supported formats and types of USB device, refer to www.kenwood.com/usb/.
- Attach the correct extension for the Audio file (AAC: ".M4A", MP3: ".MP3", WMA: ".WMA")
- Do not attach the extensions to files other than the Audio file. If the extension is attached, the file, which is not the Audio file, will play and outputs a loud noise, causing damage to the speaker.
- The files with copy protection cannot be played.
- The unit may not be compatible with upgrade of compression format standard and additional specifications.
- File/Folder name is the number of the characters including the extensions.
- This unit can display the following versions of MP3 ID3 tag: version 1.0/ 1.1/ 2.2/ 2.3
- AAC ID3 Tag cannot be displayed.
- Contact the sales agent as to whether your USB device conforms to the USB mass storage class specs.
- Using an unsupported USB device can result in abnormal playback or display of the audio file.
Even if you use the USB device conforming to the above specs, audio files cannot be played normally depending on the type or condition of the USB device.
- Do not leave the USB device in the vehicle for a long time. It can deform or damage due to direct sunlight, high temperature, etc.

About Picture files

Acceptable picture files

- Format: JPEG
- Baseline format:
Up to a maximum of 8192(W) × 7680(H) pixels
- Progressive format:
Up to a maximum of 1600(W) × 1200(H) pixels



- Enlarges and reduces images up to the size shown above to fit to the screen.
- The picture files with information attached (such as Exif) may not be displayed or operated (e.g.: rotation display) properly.

Extensions

Picture files must have one of the following extensions:

jpg, jpeg, jpe

About USB device

- Install the USB device in the place where it will not prevent you from driving your vehicle properly.
- You cannot connect a USB device via a USB hub.
- Take backups of the audio files used with this unit. The files can be erased depending on the operating conditions of the USB device. We shall have no compensation for any damage arising out of erasure of the stored data.
- No USB device comes with this unit. You need to purchase a commercially available USB device.

System start up setting

You need to go through the setup for AN-IN, Inner AMP, and Tuner source when the unit is installed or the reset button is pressed.

1 Start system start up



2 Setup each item



Set up by referring to <AV Interface Setup> (page 58).



Set up by referring to <System Setup> (page 58).

3 Returns to the original screen



Basic Operation

Turning ON the Power

Turn on the car ignition key.

Turning OFF the Power

Turn off the car ignition key.



- When KOS-L702 is connected to this unit, the power switch of KOS-L702 can also be used.

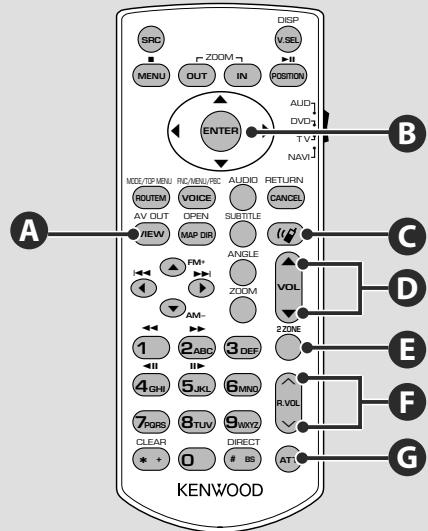

Common operations (AUD mode)

B

Cursor key

Moves the cursor when displaying menu.

ENTER

Enters options.

D

Adjusts the volume

G

Attenuates the volume

Press it again to cancel muting.

A

Switches AV OUT source

Switches the source that is output at the AV OUTPUT terminal when it is pressed.

F

Rear volume control

Adjusts volume at rear when the Dual Zone function is ON.

E

Switches the Dual Zone function ON and OFF.

C

Hands-free communication

Enters the dialing method selection mode. When a call comes in, it answers the call.



- Put the Remote Controller in a place where it will not move during braking or other operations. A dangerous situation could result, if the Remote Controller falls down and gets wedged under the pedals while driving.
- Do not place the battery near an open flame or heat source. This may cause the battery to explode.
- Do not recharge, short, break up or heat the battery or place it in an open fire. Such actions may cause the battery to leak fluid. If spilled fluid comes in contact with your eyes or on clothing, immediately rinse with water and consult a physician.
- Place the battery out of reach of children. In the unlikely event that a child swallows the battery, immediately consult a physician.

Battery installation

Use two "AAA"/"R03"-size batteries.
Slide the cover while pressing downwards to remove it as illustrated.
Insert the batteries with the + and – poles aligned properly, following the illustration inside the case.

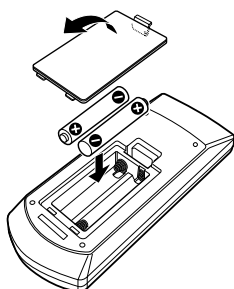

- If the Remote Controller operates only over shorter distances or does not operate at all, it is possible that the batteries are depleted. In such instances, replace the both batteries with new ones.

Remote Controller mode switch

The functions operated from the remote controller differ depending on the position of the mode switch.

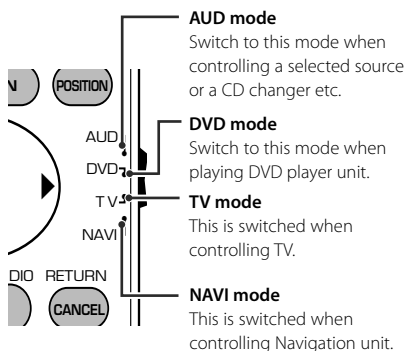

- The position of the remote control mode switch is indicated in the title of each mode, e.g., "(AUD mode)".
- When controlling a player that is not integrated in the unit, select "AUD" mode.

Basic Operations

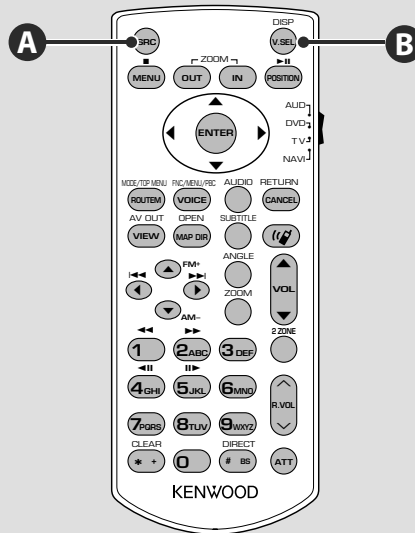

Common operations (AUD mode)

Playing a USB device

When connecting a USB device, playback starts automatically.

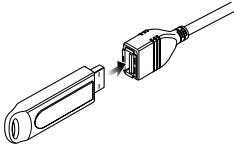

Removing the USB device

Press  on the USB control screen to enter the USB suspend mode, and then remove the USB device. Refer to <USB Device Control> (page 18).



- Removing the USB device before entering the USB suspend mode may result in damaging the data in the USB device.



- If the USB source is selected when a USB device is not connected, "No Device" is displayed.
- When the playback is stopped and then restarted, the playback will start from the point where it was stopped at the last time. Even if the USB is removed and connected again, the playback will start from the last stopped point unless the contents in the USB device is changed.
- Make sure that the USB device is connected firmly.

B

Switches the video source

The video source switches in the following order each time you press the button.

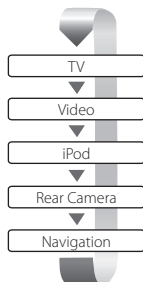

When you press the button again, the previous video display comes back on.



- The Rear view camera video is displayed when the vehicle's gear is in "Reverse".
- Set the "NAVIGATION" of the <AV Interface Setup> (page 58) to "RGB"/"AV-IN" to display the Navigation video.

A

Switches the audio source

The audio source is switched in the following order each time you press the button.

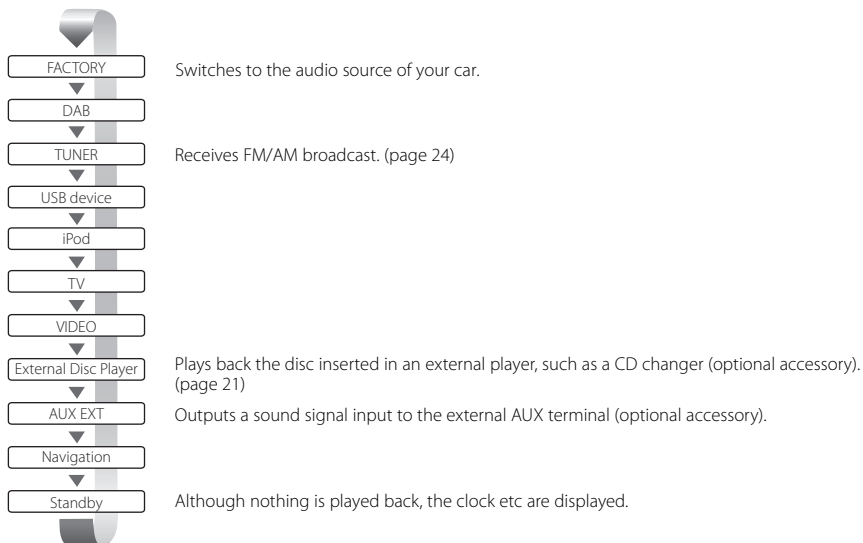

- You cannot switch to a source that is not connected or inserted.
- It is necessary to set "NAVIGATION Source" of <AV Interface Setup> (page 58) to "On" to add Navigation as an audio source that can be selected with the [SRC] key.

Next page ►

Basic Operations

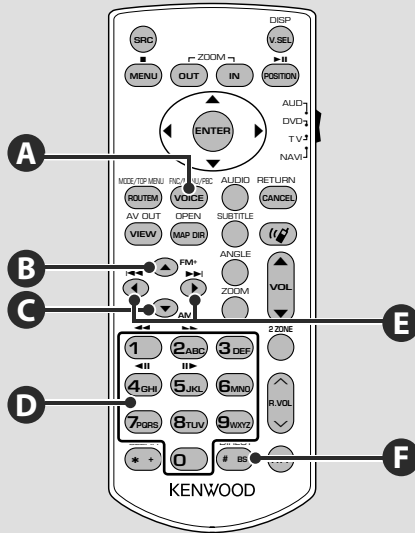

Common operations (AUD mode)

A

Switches the function screen

The function control screen switches in the following order each time you press the button.

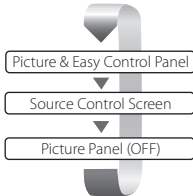

The following buttons are always displayed on the source control screen.



- 1 Displays the Source Select screen. (page 44)
- 2 Returns to the Source Control screen.
- 3 Displays the Audio Control Menu screen. (page 74)
- 4 Displays the SETUP Menu screen. (page 56)
- 5 Adjusts the Volume.
- 6 Clock display



- Touch  displayed at bottom right of various screens to return to the original screen.

Audio files (AUD mode)

B C

Folder search

Selects the folder to be played.

E

Track search and file search

Selects the track or file to be played.

Radio (AUD mode)

B C

Band switching

Switches to bands received by the unit.

E

Station selection

Switches to broadcast stations received by the unit.

D F

Direct tuning

After pressing this key, use the numeric keypad to specify the broadcast station you wish to receive.

Example: 92.1MHz (FM)



Example: 810kHz (AM)



D

Numeric keypad

- To use preset tuning, press the number of a programmed broadcast station. ((1) – (6MHz))
- Press the direct tuning key first, then specify the frequency of the station to receive.

TV (TV mode)

B

Switching Band/Video

Switches between the station of the TV band to receive and video input.

E

Channel Selection

Selects the TV channel to be received.

D F

Direct tuning

Press this key first, and then specify the station to receive with the numeric keypad.

Example: In case of Channel 6 (2-digit)



D

Numeric keypad

- The number of the memorized station is selected. ((1) – (6MHz))
- Press the direct tuning key first, then specify the channel of the station to receive.

Basic Operations

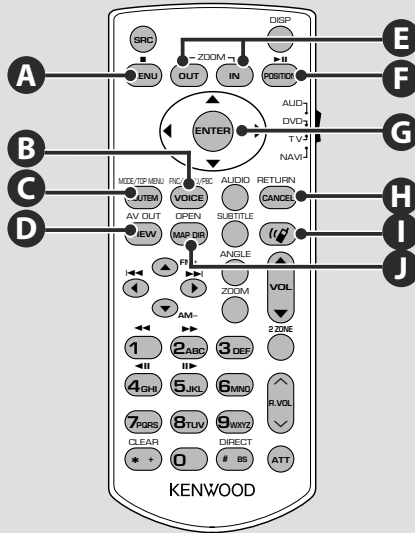

NAVI (NAVI mode)

G

Joystick

Scrolls the map, or moves the cursor.

C

ROUTEM

Displays Route Option menu.

G

ENTER

Performs the selected function.

D

VIEW

Switches between 2D and 3D map displays.

E

ZOOM

Zooms in or out the navigation map.

B

VOICE

Plays Voice guidance.

A

MENU

Displays Main menu.

J

MAP DIR

Switches between the heading up navigation and north up navigation map displays.

H

CANCEL

Displays previous screen.

F

POSITION

Displays the current position.

I

Hands-free communication

Enters the dialing method selection mode.

When a call comes in, it answers the call.

USB Device Control

You can control and listen to songs in your USB device by simply connecting it to the USB connector of this unit.



- For the connection of a USB device, refer to <Basic Operations> (page 12).

Functions when Displaying the Easy Control Panel

Displays a floating control panel in the screen.



- 1 Switches the source.
- 2 Selects a folder.
(Only in Folder Select mode)
- 3 Selects a file.
- 4 Plays or pause.
- 5 Display the Screen Control screen. (see <Screen Control> (page 48))
- 6 Displays the external device control screen. See <External Device Power Supply Control> (page 45).



- The Easy Control Panel display is hidden when you touch a central area of the monitor.

Functions while displaying the Control Screen

Switches to control screen to use various playback functions.

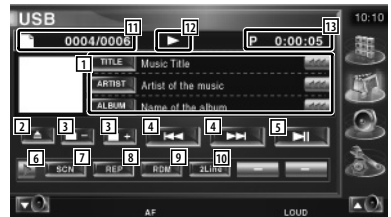
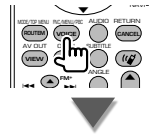
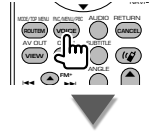

- 1 Music information display
Selects Folder Name, File Name, Title, Artist Name, or Album Name.
When is appeared, the text display is scrolled by pressing it.
- 2 Removes the USB device.
When "No Device" is shown, the USB device can be removed safely.
If you wish to play it again while the USB device is connected, press it again.

- 3 Selects a folder. (Only in Folder Select Mode)*
- 4 Selects a file.
- 5 Plays or pauses.
- 6 Switches the button display.
- 7 Starts or stops Scan Play (that plays the beginning of each music one after the other).
- 8 Repeats to play (the present music).
- 9 Starts or stops Random Play (to play music in random order). (Only in Folder Select Mode)*
- 10 Switches the number of lines displayed in the Information Display.
- 11 Track (Music) Number Display
- 12 Play Mode Display
- 13 Play Time Display



- 14 Repeats to play the music or data of the present folder. (Only in Folder Select Mode)



- 15 Displays the folder list. Refer to <Folder Select> (page 20).
- 16 Displays the list of category. Refer to <USB List> (page 19).
- 17 Displays information screen of music being played.
- 18 Displays the external device control screen. See <External Device Power Supply Control> (page 45).



* Disable during play list mode.

USB List

Lists and searches music contained in the USB device.

1 Display the Category List

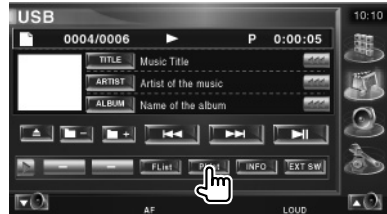

2 Select a category



- 1 Returns to the original screen.

3 Select music



- 2 Switches to the lower level of the category.
- 3 Lists all the music in the selected category.
- 4 Moves to the upper level of the category.
- 5 Moves to the top category.
- 6 Displays the currently playing category. (Only in Category Mode)
- 7 Returns to the original screen.

Folder Select

Searches folders and Audio files stored in the USB device according to hierarchy.

1 Start Folder Select

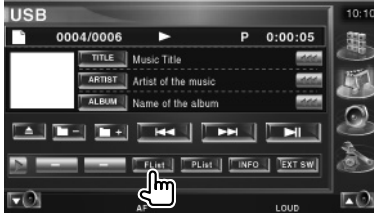

2 Selects a song

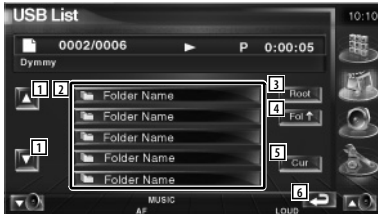

- 1 Scrolls the list.
- 2 Lists folders and Audio files
Folder opens when touched, and the Audio file is played.
- 3 Moves to the top hierarchy level.
- 4 Moves up a hierarchy level.
- 5 Displays the currently playing file.
- 6 Returns to the original screen.

Music Disc Listening

You can recall various control screens during Disc Changer playback.

Functions When Displaying the Easy Control Panel

Displays a floating control panel in the screen.

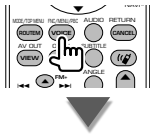

During playback on disc changer



- 1 Switches the source.
- 2 Selects a disc.
- 3 Selects a music.
When you continue to touch button:
Fast Forwards or Fast Backwards.
- 4 Plays or pauses.
- 5 Displays the Screen Control screen.
(page 48 for the <Screen Control>)
- 6 Displays the external device control screen. See <External Device Power Supply Control> (page 45).



- The Easy Control Panel is hidden when you touch a central part of the monitor.

Functions While Displaying the Control Screen

During playback on disc changer

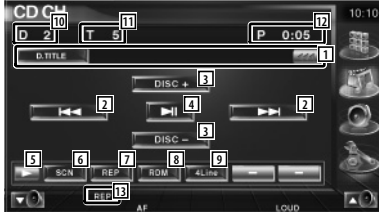

- 1 Music information display
Selects the Disc Name (see <Set Disc Name>, page 22) or Track Text mode for text display.
When is appeared, the text display is scrolled by pressing it.
- 2 Selects a track.
Starts Fast Forward or Fast Backward when it is held down.
- 3 Selects a disc.
- 4 Plays or pauses.
- 5 Switches the button display.
- 6 Starts or stops Scan Play (that plays the beginning of each music one after the other).
- 7 Repeats to play (the present music).
- 8 Starts or stops Random Play (to play music in random order).
- 9 Switches the number of lines displayed in the Information Display.
- 10 Disc Number Display
- 11 Track Number Display
- 12 Play Time Display
- 13 Function Indicator



- 14 Repeats to play a disc (the present disc).
- 15 Starts or stops Magazine Random Play (to play songs of the disc changer in random order).



- 16 Sets a name to the disc being played. (page 22)
- 17 Displays a list of discs in the Disc changer and allows you to select the disc to listen. See <Disc Select> (page 23).
- 18 Displays the external device control screen. See <External Device Power Supply Control> (page 45).



- The functions that can be used and the information that can be displayed will differ depending on the models being connected.
- The information shown will be different depending on the Disc Changer being used.

Set Disc Name

Assigns a name to a CD.

1 Play a CD you wish to name

2 Start Name set



3 Enter the name

See <Character Entry> (page 47) for information on how to enter a name.

4 End Name set



Disc Select

Displays a list of discs in the Disc changer and allows you to select the disc to listen.

1 Start Direct Select



2 Select a Disc



- 1 Scrolls the list.
- 2 Lists the discs. Plays when touched.
- 3 Switches the list name to Disc name or Disc Text.
- 4 Returns to the original screen.

Direct Search

Searches for a disc or a track when its number is entered.

During play on an external in disc changer

1 Enter a disc or track number

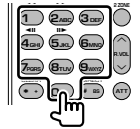

2 Search

When searching for a track:

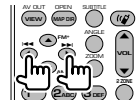

When searching for a disc:

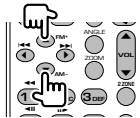

- The operation ends automatically if you do not operate within 10 seconds.

Radio Listening

Various control screens appear in the Tuner Source mode.



- For the basic method of receiver button operations, refer to <Basic Operations> (page 10).
- Set the remote controller mode switch to "AUD" mode before starting operation, refer to <Remote Controller mode switch> (page 11).

Functions When Displaying the Easy Control Panel

Displays a floating control panel in the screen.

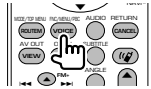

- 1 Switches the source.
- 2 Switches the band (to AM or FM1/2/3).
- 3 Tunes in a station.
- 4 Switches the Seek Mode.
- 5 Displays the Screen Control screen.
- 6 Displays the external device control screen. See <External Device Power Supply Control> (page 45).



- The Easy Control Panel is hidden when you touch a central part of the monitor.

Functions While Displaying the Control Screen

Switch to control screen to use various functions.

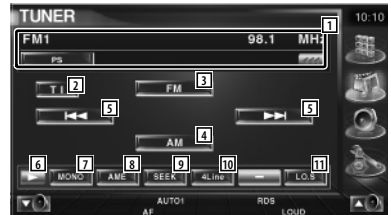

- 1 Radio station information display.
Selects the Program Service Name, Title, Artist name, Station Name, Category Name 1/2, or Radio Text.
- 2 Turns the Traffic Information function On or Off.
See <Traffic Information>, (page 28).
- 3 Switches to the FM1/2/3 band.
- 4 Switches to the AM band.
- 5 Tunes in a station.
Use the <Seek Mode> (page 25) to change the frequency switching.

- 6 Switches the button display.
- 7 Selects the Monaural reception mode. (Only when receiving the FM broadcast)
- 8 Selects the Auto Memory mode. (Refer to page 26 for the <Auto Memory>)
- 9 Switches the Seek Mode. (Refer to page 25 for the <Seek Mode>)
- 10 Switches the number of lines displayed in the Information Display.
- 11 Turns the Local Seek function On or Off.



- 12 When P1 to P6 buttons appear, you can recall the stations on memory. For memory of broadcasting stations, refer to <Auto Memory> (page 26) or <Manual Memory> (page 26).



- 13 Searches station by program type. See <Search for Program Type> (page 29).
- 14 Lists and selects memorized station. See <Preset Select> (page 27).
- 15 Displays Radio Text screen. See <Radio Text> (page 27).
- 16 Displays the external device control screen. See <External Device Power Supply Control> (page 45).

Seek Mode

Sets a station selection.



The mode is switched in following order each time you touch the button.

Display	Setting
"AUTO1"	Tunes in a station with good reception automatically.
"AUTO2"	Tunes in stations in memory one after another.
"MANU"	Switches to the next frequency manually.

Auto Memory

Stores stations with good reception in memory automatically.

1 Select a band you wish to store in memory

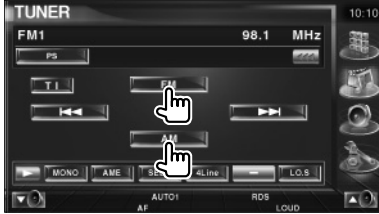

2 Select the Auto Memory mode



3 Start Auto Memory



Touch or .

Auto Memory terminates when 6 stations are stored or when all stations are tuned in.



- The operation ends automatically if you do not operate within 10 seconds.

Manual Memory

Stores the current receiving station in memory.

1 Select a station you wish to store in memory

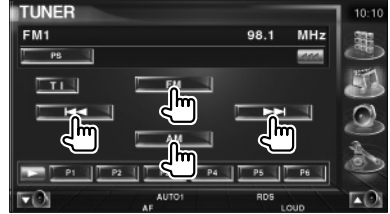

2 Store in memory



Continue to touch until the memory number appears.



: Press for # seconds.

Preset Select

Lists and selects memorized station.

1 Start Preset Select



2 Selects a station

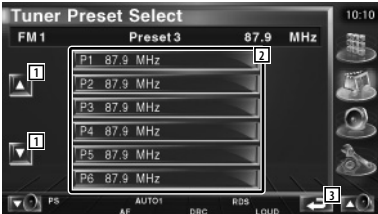

- 1 Scrolls the list.
- 2 Memorized stations are displayed. Touch to tune in.
- 3 Returns to the original screen.

Radio Text

You can display the radio text. (Only when receiving the FM broadcast)

1 Select a station

2 Display the radio text

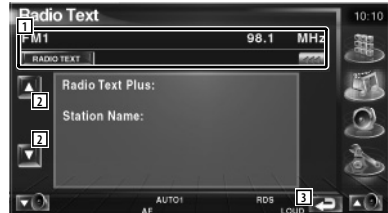

- 1 Select the Program Service Name, Title & Artist name, Station Name, Category1/2, or Radio Text for text display.
When  is appeared, the text display is scrolled by pressing it.
- 2 Scrolls the Radio text plus display.
- 3 Returns to the original screen.



Direct Search

Tunes in a station when its frequency is entered.

1 Select a band

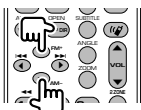

2 Select the Direct Search mode



3 Enter frequency

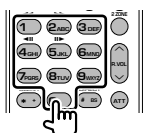

When you enter frequency, signal reception starts.

Example: When you receive FM 92.1 MHz



Example: When you receive AM 810 kHz



- The operation ends automatically if you do not operate within 10 seconds.

Traffic Information

When a traffic bulletin starts, any source is switched to the traffic information and it is displayed automatically.

1 Set the Traffic information mode



When the traffic bulletin starts...

The Traffic Information screen appears automatically.

Traffic Information screen



- It is necessary to have Traffic Information function set to On in order to have the Traffic Information screen appear automatically.
- During reception of traffic information the adjusted volume is automatically remembered, and the next time it switches to traffic information it's automatically the remembered volume.

Search for Program Type

A program is tuned when you set its program type. (Only when receiving the FM broadcast)

1 Enter Program Type mode



2 Select a Program Type



- 1 Program Type is displayed. Touch to select a Program Type.
- 2 Scrolls the Program Type list.
- 3 Search for the program type.
It is displayed when the Program type is selected.
- 4 Returns to the original screen.

3 Searches station of the selected Program Type



iPod Control

You can control and listen to songs in your iPod by connecting iPod with video or iPod nano to this unit with KCA-iP300V (optional accessory). You can also display video contents on this unit when connecting an iPod with video.

Connecting an iPod

Connect an iPod to this unit.

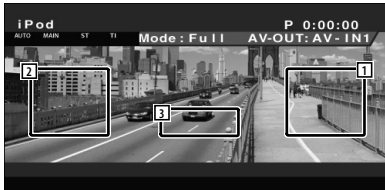
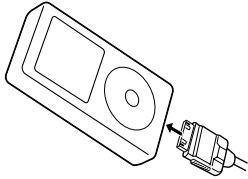

- 1 Forward music/video search area
Select the next music/video.
- 2 Backward music/video search area
Select the previous music/video.
- 3 Information display button area
The information is display for 5 seconds.



- Remove all accessories such as headphone before connecting an iPod. You may not be able to control the iPod if you connect it with accessories attached.
- When you connect an iPod to this unit, playback starts from the song you were playing on the iPod itself (Resume Function).
- If the played song is not a video content, "No iPod Video Signal" is displayed on the video screen.
- While connecting an iPod, "KENWOOD" appears on the iPod and the iPod's control is disabled.

Functions when Displaying the Easy Control Panel

Displays a floating control panel in the screen.



- 1 Switches the source.
- 2 Fast Forward or Fast Backward.
- 3 Music/Video Search.
- 4 Plays or pause.
- 5 Display the Screen Control screen. (Refer to <Screen Control> (page 48))
- 6 Displays the external device control screen. See <External Device Power Supply Control> (page 45).



- The Easy Control Panel display is hidden when you touch a central area of the monitor.

Functions while displaying the Control Screen

Switches to control screen to use various playback functions.

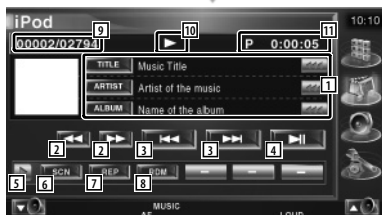

- 1 Music/Video Information Display
Selects the Title, Artist Name, Album Name or iPod Name.
When  is appeared, the text display is scrolled by pressing it.
- 2 Fast Forward or Fast Backward.
- 3 Select Music/Video.
- 4 Plays or pause.
- 5 Switches the button display.

- 6 Starts or stops Scan Play (that plays the beginning of each music or video one after the other).
- 7 Repeats to play (the preset files or data).
- 8 Starts or stops Random play.*
- 9 Total number of music in the iPod and the music number display
- 10 Play Mode Display
- 11 Play Time Display



- 12 Starts or stops Album Random Play (plays randomly from current album).*



- 13 Display the list of music category.
See <iPod List> (page 32).
- 14 Display the list of video category.
See <iPod List> (page 32).
- 15 Displays the previous music/video list.
See <iPod List> (page 32).
- 16 Displays information screen of music/video being played.
- 17 Displays the external device control screen. See <External Device Power Supply Control> (page 45).



* Disable when video is being played.

iPod List

Lists and searches music/video contained in the iPod.

1 Display the iPod List



2 Select music/video



- 1 Switches list page.
- 2 Categories and music are listed.
Touch a category name to move its lower level. If music title is displayed, the music is played by touching it.
If  is touched, all the music in its category is played.
- 3 Returns to previous category.
- 4 Moves to the top category.
- 5 Displays the currently playing category.

TV Watching

Various control screens appear in the TV Source mode. (You can only operate TV with the optional accessory TV Tuner connected.)

Functions During TV Screen

Basic functions are available even when the TV screen is displayed.

Display the TV screen

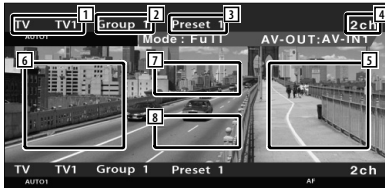
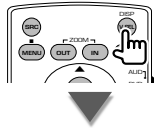

- 1 TV Band Number Display
- 2 TV Area Group Display
Refer to <TV Setup> (page 67).
- 3 Memory Number Display
- 4 Channel Number Display
- 5 Channel Up Area
Increase the channel.
- 6 Channel Down Area
Decrease the channel.
- 7 Band Switch Area
Switches to TV1 or TV2.
- 8 Information Display Button Area



- For TV picture selection and receiver button operations, see <Basic operations> (page 10).
- The information display is cleared automatically after approximately 5 seconds. Also, the information can be displayed automatically when it is updated.

Functions When Displaying the Easy Control Panel

Displays a floating control panel in the screen.

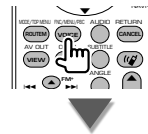

- 1 Switches the source.
- 2 Switches the TV band (to TV1 or TV2).
- 3 Select a channel.
Use the <Seek mode> (page 35) to change the channel tuning sequence.
- 4 Switches the Seek mode.
(page 35 for the <Seek mode>)
- 5 Displays the Screen Control screen.
(page 48 for the <Screen Control>)
- 6 Displays the external device control screen.
See <External Device Power Supply Control> (page 45).



- The Easy Control Panel display is hidden when you touch a central area of the monitor.

Functions While Displaying the Control Screen

Switches to control screen to use various playback functions.



- 1 Channel information display
- 2 Switches to TV1 or TV2.
- 3 Select a channel.
Use the <Seek Mode> (page 35) to change the channel tuning sequence.
- 4 Switches the button display.
- 5 Selects the Auto Memory mode.
Refer to <Auto Memory> (page 36).
- 6 Switches the Seek Mode.
Refer to <Seek Mode> (page 35).

- 7 Indicates current Seek Mode.
- 8 TV Area Group Display
Refer to <TV Setup> (page 67).
- 9 Memory Number Display
- 10 Channel Number Display



- 11 When **P1** to **P6** buttons appear, you can recall channels on memory.
For memory of broadcasting stations, see <Auto Memory> (page 36) or <Manual Memory> (page 36).



- 12 Sets a name to the tuned station. (page 37)
- 13 Lists and selects memorized station. See <Preset Select> (page 37).
- 14 Displays the external device control screen. See <External Device Power Supply Control> (page 45).

Seek Mode

Sets a station selection.

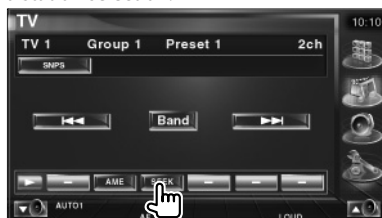

The mode is switched in following order each time you touch the button.

Display	Setting
"AUTO1"	Tunes in a station with good reception automatically.
"AUTO2"	Tunes in stations in memory one after another.
"MANU"	Switches to the next frequency manually.

Auto Memory

Stores stations with good reception in memory automatically.

1 Select a band you wish to store in memory



2 Select the Auto Memory mode



3 Start Auto Memory



Auto Memory terminates when 6 stations are stored or when all stations are tuned in.



- The operation ends automatically if you do not operate within 10 seconds.

Manual memory

Stores the current receiving channel in memory.

1 Select a station you wish to store in memory



2 Store in memory



Continue to touch until the memory number appears.

Preset Select

Lists and selects memorized station.

1 Start Preset Select



2 Selects a station

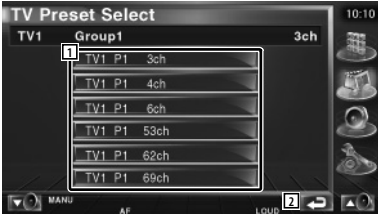

- 1 Memorized stations are displayed. Touch to tune in.
- 2 Returns to the original screen.

Set Station Name

Assigns a name to a station.

1 Select a station you wish to name

2 Start Name set



3 Enter the name

See <Character Entry> (page 47) for information on how to enter a name.

4 End Name set



- You can enter characters only after you have applied the parking brake.

Video Watching

Functions When Displaying the Easy Control Panel

Displays a floating control panel in the screen.

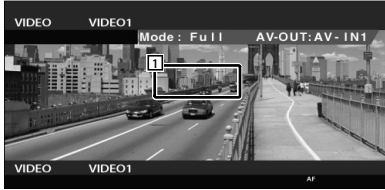

- 1 Video switch Area
Switches to Video1/Video2.

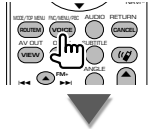

- 2 Switches the source.
- 3 Displays the external device control screen. See <External Device Power Supply Control> (page 45)
- 4 Displays the Screen Control screen. (page 48 for the <Screen Control>)
- 5 Switches to Video1.
- 6 Switches to Video2.



- The Easy Control Panel display is hidden when you touch a central area of the monitor.

Functions While Displaying the Control Screen



- 1 Switches to Video1.
- 2 Switches to Video2.
- 3 Displays the external device control screen. See <External Device Power Supply Control> (page 45)

DAB Tuner Control

Various control screens appear in the DAB Tuner source mode. (with the optional accessory DAB tuner connected only)

Functions When Displaying the Easy Control Panel

Displays a floating control panel in the screen.

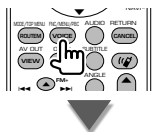

- 1 Switches the source.
- 2 Switches the band (to DAB1/2/3).
- 3 Selects a service.
- 4 Selects the Ensemble.
- 5 Switches the Seek Mode.
(See page 40 for the <Seek Mode>)
- 6 Displays the Screen Control screen.
(page 48 for the <Screen Control>)
- 7 Displays the external device control screen. See <External Device Power Supply Control> (page 45)



- The Easy Control Panel display is hidden when you touch a central area of the monitor.

Functions While Displaying the Control Screen

Switches to control screen to use various functions.

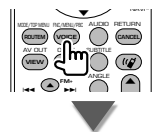
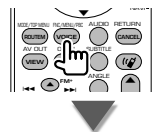

- 1 Displays information concerning music being played.
Changes the display between Ensemble label, PTY label, Component label, Region label, and Audio quality.
When  is appeared, the text display is scrolled by pressing it.
- 2 Switches the band (to DAB1/2/3).
- 3 Selects a service.
- 4 Selects the Ensemble.
- 5 Switches the button display.

Next page ►

- 6 Selects the primary or secondary operation.
- 7 Selects the Auto memory mode. (page 41 for the <Auto Ensemble memory>)
- 8 Switches the Seek Mode. (page 40 for the <Seek Mode>)
- 9 Switches the number of lines displayed in the Information Display.
- 10 Indicates current Seek Mode.



- 11 When **P1** to **P6** buttons appear, you can recall a service from memory.



- 12 You can set the menu language. See <Language Filter Setting> (page 42)
- 13 Searches station by specifying program type. See <Search for Program Type> (page 43).
- 14 You can list and select services. See <Service Select> (page 42).
- 15 Displays DAB information.
- 16 Displays the external device control screen. See <External Device Power Supply Control> (page 45).

Seek Mode

Sets a station selection mode.



The mode is switched in following order each time you touch the button.

Display	Setting
"AUTO1"	Tunes in a ensemble with good reception automatically.
"AUTO2"	Tunes in service in memory one after another.
"MANU"	Switches to the next channel manually.

Auto Ensemble Memory

An ensemble with good reception is stored in memory automatically.

1 Select a band you wish to store in memory



2 Select the Auto Memory mode



3 Start Auto Memory



Touch  or .

Auto Memory terminates when 6 stations are stored or when all stations are tuned in.

Service Preset Memory

The current receiving service is stored in memory.

1 Select a service you wish to store in memory



2 Store in memory



Continue to touch until the memory number appears.

Service Select

Listing and selecting service in the current ensemble.

1 Start Service Select



2 Select a service

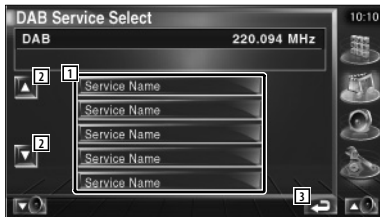

- 1 Selects a service.
Tunes in the touched service.
- 2 Scrolls the service list.
- 3 Returns to the original screen.

3 Search the service



Language Filter Setting

Setting the menu language.

1 Start Language Filter Setting



2 Select a language



- 1 Language display
- 2 Switches language list.
- 3 Returns to the original screen.

3 Search the language



Search for Program Type

Specifying program type and searching service.

1 Start Program Type mode



2 Select Program Type



- 1 Program Type display
- 2 Switches Program Type.
- 3 4 5 are displayed and you can switch the language. Touching once more erases 4 5 and then you can switch the program type.
- 4 Language display
- 5 Switches language list.
- 6 Returns to the original screen.

3 Searches service of the selected Program Type



DAB Announcement

When the Announcement you have turned on starts, any source is switched to the Announcement automatically.

When the announcement starts...

The Announcement screen appears automatically.

Announcement screen



Source Select

The source you wish to listen to can be selected quickly.

Displaying the Control Screen

1 Display control screen

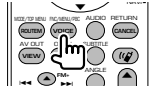

Press several times until the Control Screen appears.

2 Display source select screen

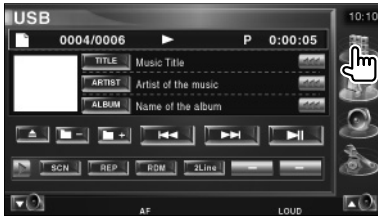

3 Select a source



- 1 Switches to the selected source.
- 2 Scrolls the source display.
- 3 Displays the external device control screen. See <External Device Power Supply Control> (page 45).
- 4 Switches the skin. (3 types)
- 5 Displays the Hands-Free Control screen. See <Hands Free Unit Control> (page 49).



- The displayed source depends on the type of device connected. In addition, you cannot press the button of currently unavailable source.

External Device Power Supply Control

Controlling the external device power supply.

External Device Power Supply Control

Controlling the external device power supply.

1 Displays the EXT SW Control screen



[EXT SW] appears when the control screen of each source or Easy control panel is displayed.

2 Controls the external device power supply

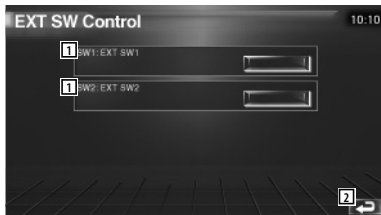

- 1 You can turn on or off the external device power supply.
- 2 Returns to the original screen.



- You must connect a commercially available relay unit in order to use this function.
Connect the external device to be controlled to that relay unit.
- Refer to <EXT SW Setup> (page 72) for information on setting the power on or off specification.

Muting Audio Volume upon Reception of Phone call

Muting Audio Volume upon Reception of Phone Call

When the telephone is called, the system is paused automatically.

When the telephone is called...

The Phone Call ("CALL") screen appears, and system is paused.

Phone Call ("CALL") screen

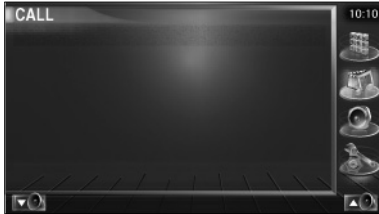

If you want to continue to listen to the audio source during phone call...



The system resumes audio play during the phone call.

When the call ends...

Hang up the phone.

The system resumes playing automatically.



- To use the TEL Mute feature, you need to hook up the MUTE wire to your telephone using a commercial telephone accessory. Refer to <Connection> (page82).

Character Entry

How To Use the Character Entry Screen

When you select the Set Disc Name mode or others, the following screen appears for character entry.

Character Entry screen



1 Shifts the cursor.

2 Enters a space.

If you erase a character, locate the cursor on it and touch this button.

3 Enters characters.

4 Scrolls up or down the character button display.

5 Exits the Character Entry mode and returns to the previous screen.



- You can enter characters only after you have applied the parking brake.

Screen Control

Screen Control

Setting the monitor screen.

1 Display Easy control panel



2 Display the Screen Control screen



3 Adjust the picture quality

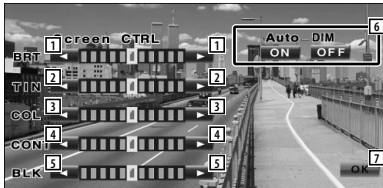

- 1 Brightness Control
Disabled if Auto Dimmer is On.
- 2 Tint Control
Displayed for an NTSC system image on TV, Video, iPod or Rear View Camera.
- 3 Color Control
Displayed on the TV, Video, iPod or Rear View Camera screen only.
- 4 Contrast Control
- 5 Black Level Adjustment
- 6 Auto Dimmer Setup
When turned "On", the display is dimmed automatically when the ambient becomes dark.
- 7 Returns to the previous screen.



- The Screen Control screen is displayed only when you have applied the parking brake.
- The picture quality can be set for each source.
- You can set image quality of screens such as menu from <Monitor Setup> (page 64) of the <Setup Menu>.

Hands Free Unit Control



- You need to register your cell-phone to your Bluetooth Hands Free Box beforehand. Make sure to read the instruction manual of the Bluetooth Hands Free Box as well.

Control Screen Function

Displaying the control screen and using various functions.

1 Display the control screen



Press several times until the Control Screen appears.

2 Display the source select screen



1 Displays the status of connection with the cell-phone.

White: The cell-phone is connected.

Orange: The cell-phone is not connected, or it is outside the service range.

3 Display the Hands-Free Control screen

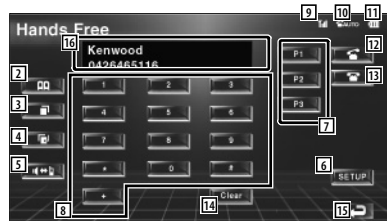

- Displays the Search for Phone Book screen. (See <Calling by Phone Book>, page 51)
- Displays the Out Going Calls screen. (See <Redialing>, page 53)
- Displays the Incoming Calls screen. (See <Redialing>, page 53)
- Switches between the private and hands-free modes (only when a call in progress).
- Displays the Hands-Free Set Up screen. (See <Setting up the Hands-Free Phone>, page 54)
- Enter three phone numbers for quick dialing. (See <Quick Dialing>, page 51)
- Enters a phone number. (See <When Dialing>, page 50)
- Displays the signal strength.*
The more the number of bar segments, the stronger the signal.
- Displays the present Auto Answering status
When Auto Answering is on: AUTO
When Auto Answering is off:
- Displays the battery drain of the cell-phone.*
The more the number of bar segments, the higher the battery level.
- Starts the call.
- Ends the call.
Clears the phone number being entered.
- Clears the entered phone number.
- Returns to the previous screen.
- Displays the calling and called phone numbers.

If you have registered a phone number in the Phone Book, the destination person name is displayed.

Next page ►



- While your car is moving, some functions are disabled for safety's sake. The buttons associated with the disabled functions become ineffective if pressed.
- When the Hands-Free Control screen appears, the name of the connected cell-phone is displayed for 5 seconds.
- * Since the number of steps of the control unit is different from that of the cell-phone, the statuses displayed on the control unit may discord from those displayed on the cell-phone. No status is displayed if information about it cannot be obtained.
- Setting the cell-phone in the private mode can disable the hands-free function.

When Called

When you receive a call, you can use the hands-free phone.

1 Respond to a call

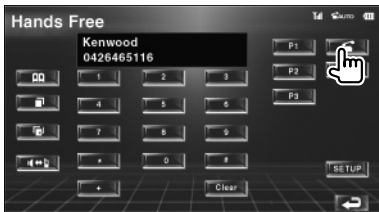

When a call arrives, the Hands-Free Control screen appears automatically.

2 End the call

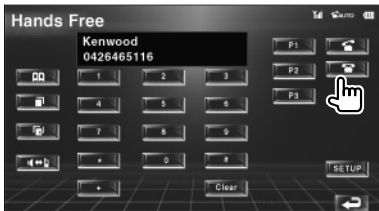

The previous screen reappears.

When Dialing

Make a call by entering a phone number.

1 Enter a phone number

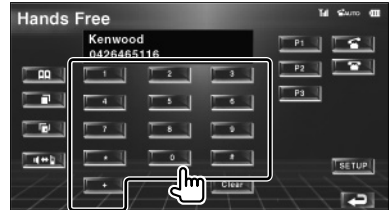

2 Make a call



You can start talking when the destination responds.



- To clear your incorrect entry, touch **Clear**.

3 End the call

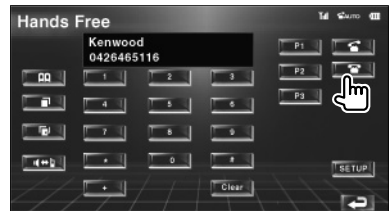

The previous screen reappears.



- You can input max 32 digits.



Quick Dialing

You can register up to 3 phone numbers for quick dialing.

To register a phone number:

1 Display a phone number you wish to register

See the <Calling by Phone Book> (page 51), <Redialing> (page 53) and <When Dialing> (page 50).

2 Register the phone number

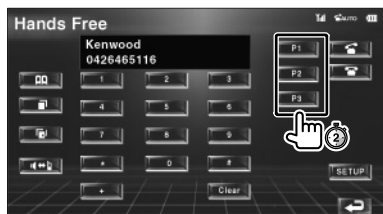

Continue to touch more than 2 seconds.

To call a phone number from memory:

1 Recall the phone number

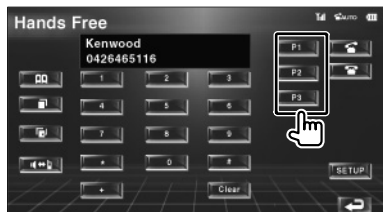

2 Make a call

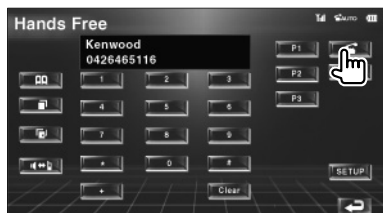

- Only the phone numbers can be registered for Quick Dialing. Therefore, the destination subscriber name and others are not displayed during dialing.

Calling by Phone Book

You can call a person using his/her phone number that you have registered in the Phone Book.

1 Display the Phone Book screen

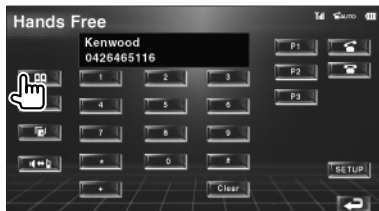

The Initial Input screen appears.



Initial Input screen

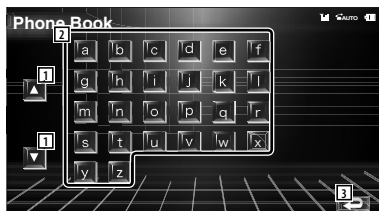

- 1 Scrolls the character array display.
- 2 Displays the Phone Book beginning with the name whose first character you have touched.
- 3 Returns to the Hands-Free Control screen.

2 Select the initial character of a person name in memory

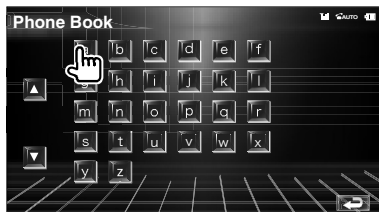

The Phone Book List screen appears.



Phone Book List screen

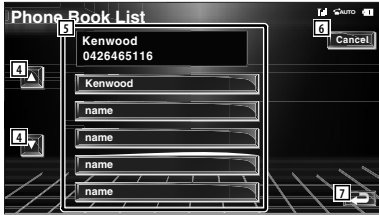

- 4 Scrolls the list.
- 5 Enters the destination name.
- 6 Cancels the operations.
- 7 Returns to the Hands-Free Control screen.

3 Select a destination you wish to call



4 Confirm the destination

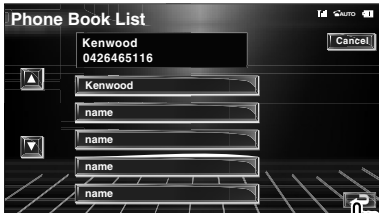

The Hands-Free Control screen appears again. The selected destination data is displayed.

5 Make a call



You can start talking when the destination responds.

6 End the call

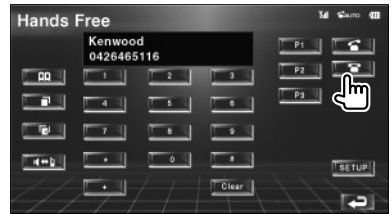

The previous screen reappears.



- To use the Phone Book, it must have been downloaded from the cell-phone. For more details, see the instruction manual of your bluetooth Hands Free Box and your cell phone.
- Up to 20 characters can be displayed for each name in the Phone Book.
- Initials including no corresponding name will not be displayed.
- During search, a non-accent character such as "u" is searched for instead of an accent character such as "ü".

Redialing

You can redial, one of the last 10 phone numbers that you have called or received.

1 Display the Search for Outgoing Calls or Incoming Calls screen

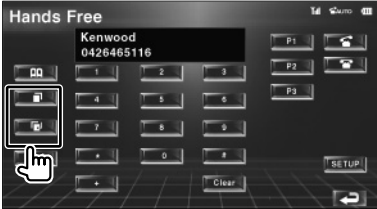

 : Outgoing Calls

 : Incoming Calls

The Outgoing Calls or Incoming Calls list screen appears.

Out Going Calls or Incoming Calls screen



1 Scrolls the list.

2 Enters the destination name.

3 Switches the Redial List between 5 numbers display and single number display.

4 Enters the destination data and returns to the Hands-Free Control screen.

5 Returns to the Hands-Free Control screen.

2 Select a destination you wish to call



3 Confirm the destination

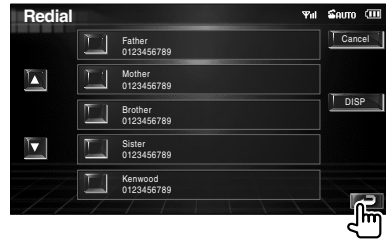

The Hands-Free Control screen appears again. The selected destination data is displayed.

4 Make a call



You can start talking when the destination responds.

5 End the call



The previous screen reappears.



- The Outgoing Calls list screen or Incoming Calls list screen shows the list of the calls originated from or received at this unit. They are not the ones stored in the cell-phone memory.

Setting up the Hands-Free Phone

The Hands-Free system can be set as follows.

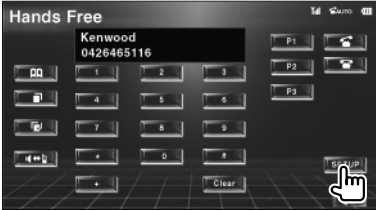

Hands-Free Set Up screen

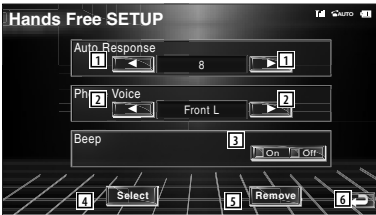

- 1 Sets an automatic response time after call termination. (📎 "8")
 "Off": This function can not use.
 "0-99": Sets to calling ring time (second).
- 2 Sets a ringing tone output position.
 (📎 "Front-R")
 "Front-L": Outputs the tone from the front left-hand side speaker.
 "Front-R": Outputs the tone from the front right-hand side speaker.
 "Front All": Outputs the tone from the both front speakers.
- 3 Sets the beep of the incoming call.
 (📎 "On")
 "On": Beep is heard.
 "Off": Beep is canceled.
- 4 Displays the Phone Select screen.
- 5 Displays the Phone Delete screen.
- 6 Returns to the Hands-Free Control screen.



- Either the time interval for automatic answer set on this unit or the time interval set on the cell-phone, whichever is shorter, takes effect.
- Select the speaker which is further from the microphone in order to prevent howling or echoes.

Selecting a Hands-Free Phone

You can choose the Hands-Free phone from the list.

1 Display the Hands-Free Set Up screen

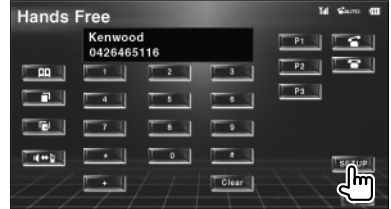

2 Display the Phone Select list



Phone Select screen



- 1 Selects the cell-phone to be used as a hands-free phone.
- 2 Returns to the Hands-Free Set Up screen.

3 Select a Hands-Free phone you wish to use



Deleting the Hands-Free Phone

You can cancel a registration of Hands-Free phone.



- The Phone Book, outgoing call list, and incoming call list are deleted together with the deleted Hands-Free phone.

1 Display the Hands-Free Set Up screen



2 Display the Phone Delete list

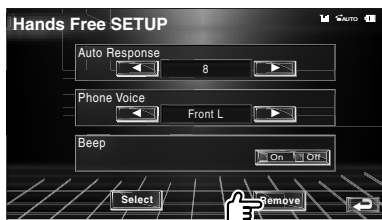

Phone Delete screen

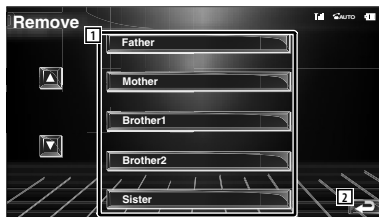

- 1 Selects the cell-phone to be deleted from the list.
- 2 Returns to the Hands-Free Set Up screen.

3 Select a Hands-Free phone you wish to delete



Setup Menu

You can set up various receiver parameters.

Setup Menu

Displays the Setup Menu to set various functions.

1 Display the control screen



Press several times until the control screen appears.

2 Display the setup Menu



3 Select the setup item

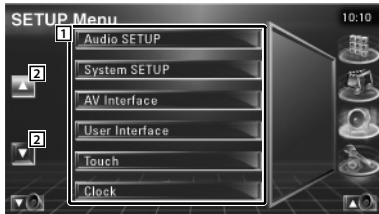

- 1 The selected setup screen appears.
- 2 Scrolls the setup menu.

Audio Setup

You can setup a speaker network, etc.

1 Display the Audio SETUP screen

Touch [Audio SETUP] in the SETUP Menu (page 56).



- [Audio SETUP] cannot be selected when no source is selected.

2 Setup each item

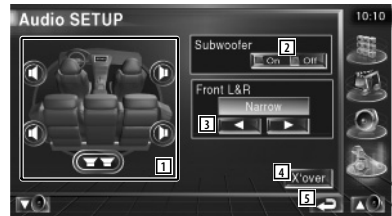

- 1 Selects the speaker to set the crossover. See <Crossover Network Setup> (page 57).
- 2 Sets the availability of subwoofers.
- 3 Selects the type of front speakers.
"Standard": Setup for general diameter speakers
"Narrow": Setup for small diameter speakers
"Middle": Setup for middle diameter speakers
"Wide": Setup for large diameter speakers
- 4 Switches to the crossover setup screen. See <Crossover Network Setup> (page 57).
- 5 Returns to the original screen.

Crossover Network Setup

You can set a crossover frequency of speakers.

1 Select the speaker to set the crossover

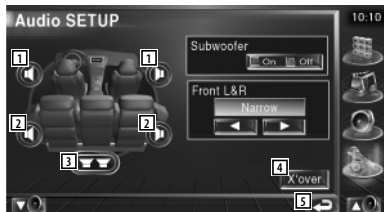

- 1 Sets the High Pass Filter of the front speaker.
- 2 Sets the High Pass Filter of the rear speaker.
- 3 Sets the Low Pass Filter of the sub woofer.
- 4 Switches to the crossover setup screen.
- 5 Returns to the original screen.

2 Display the Crossover setup screen



3 Set the crossover



- 6 Sets the cross over frequency.
- 7 Sets the sub woofer phase. (Only when "Subwoofer" is set to "On" in Audio setup and "L PF SUB FREQ" is set to other than "Through")
- 8 Returns to the original screen.

iPod Setup

Performs setup when using iPod.

1 Display the iPod SETUP screen

Touch [iPod SETUP] in the SETUP Menu (page 56).

2 Setup each item



- 1 Sets the Audiobook playback speed.
- 2 Sets Wide Screen on or off.
- 3 Returns to the original screen.



- "Wide Screen" cannot be set while the iPod is connected.

Software Information

Checks the software version of this unit.

1 Display the Software Information screen

Touch [Software Information] in the SETUP Menu (page 56).



- 1 Displays the software version.
- 2 Returns to the original screen.

System Setup

You can set up the system parameters.

1 Display the System SETUP screen

Touch [System SETUP] in the SETUP Menu (page 56).

2 Setup each item

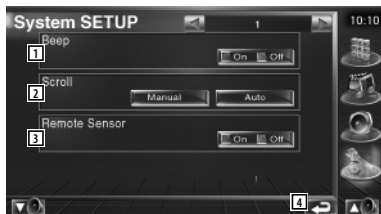

- 1 Turns the key touch tone On or Off. (On)
- 2 Allows scrolling of text display on the Source Control screen. (Manual)
"Auto": Scrolls the screen automatically.
"Manual": Allows you to scroll the screen manually.
- 3 Selects a remote control signal. (On)
When turned "Off", the remote control of TV reception is rejected.
- 4 Returns to the original screen.



- 5 Controlling the built-in amplifier.* (On)
"On": Uses the built-in amplifier.
"Off": Uses the optional amplifier connected to this unit.
- 6 Sets the tuner source.* (On)
"On": Uses the built-in tuner to receive a radio station.
"Off": Uses the tuner of your vehicle to receive a radio station.
- 7 Returns to the original screen.



- * In order to receive a radio station with the built-in tuner, you need to connect an antenna cord. Refer to <Connection> (page 82).
- * Setting can be made only in standby mode.

AV Interface Setup

You can set audio and visual (AV) interface parameters.

1 Display the AV Interface screen

Touch [AV Interface] in the SETUP Menu (page 56).

2 Setup each item



- 1 Sets a name to be displayed when you select a system that is connected via the AV INPUT1 port. (VIDEO1)



- If you have set the navigation system connection to "AV-IN", the display is fixed to "NAV1".
- 2 Sets an image display of the system that is connected via the AV INPUT2 port. (Off)
"Off": When the image source is switched, an image entered via the AV INPUT2 port is displayed.
"On": When an image signal is entered via the AV INPUT2 port, this image is displayed.
 - 3 Sets a name to be displayed when you select an image of the system that is connected via the AV INPUT2 port. (VIDEO2)

- 4 Selects a navigation system connection.
 RGB
 "RGB": Allows the Kenwood's Navigation System to connect via its interface cable.
 "AV-IN": Allows a third-party navigation system to connect via the AV INPUT1 port.
 "Off": Must be used if no navigation system is connected. (The navigation display is cancelled when the AV source is switched)
- 5 Returns to the original screen.



- 6 Selects an AV source to be output at the AV OUTPUT port. AV-IN1
- 7 Sets a method to switch to the rear view camera video display. Off
 "On": Switches to the rear view camera video display when engaging the shift knob of car to "Reverse".
 "Off": Switches to the the rear view camera video display when engaging the shift knob of car to "Reverse" and then pressing the [V.SEL] switch several times.
- 8 You can flip the left and right of the rear view camera video display. Set to "Reverse" and the the rear view will be displayed left and right in mirror image on the screen. Off



- 9 Selects speakers used for voice guidance of the navigation system. F-Left
 "F-Left": Uses the front left side speaker for voice guidance.
 "F-Right": Uses the front right side speaker for voice guidance.
 "Front All": Uses both front speakers for voice guidance.
- 10 Adjusts the volume for voice guidance of the navigation system. 21
- 11 Mutes the volume during voice guidance of the navigation system. On
 When turned "On", the volume level drops for voice guidance.
- 12 Sets a selecting method of audio source from the Navigation system. Off
 "On": Allows you to select the audio source input from the Navigation system interface by pressing [SRC] or selecting it on Source Select screen.
 "Off": The audio source cannot be selected using [SRC] or on Source Select screen.

User Interface

You can set up user interface parameters.

1 Display the User Interface screen

Touch [User Interface] in the SETUP Menu (page 56).

2 Setup each item



- 1 Selects the background to display.
"Change": Displays images entered into this unit. Refer to <Background Select> (page 63).
- 2 Enables entering or deleting of background images into of from this unit.
Press to enter the USB suspend mode, and then remove the USB device.
"Memory": Enables entering of background images.
Refer to <Entering Background> (page 62).
"Delete": Enables deleting of background image entered into this unit.
Refer to <Background Delete> (page 62).
- 3 Sets whether to display the target when touching the panel.
- 4 Sets the display method of the unrecognized characters.
"On": Displays in the Russian character.
"Off": Displays in the European character.
- 5 Returns to the original screen.



- 6 Sets an on-screen display of the iPod Playback screen. (Auto)
"Auto": Information is displayed for 5 seconds when updated.
"Manual": Information is displayed when you touch on the screen.
- 7 Sets an on-screen display of the navigation screen. (Off)
"Auto": Information is displayed for 5 seconds when updated.
"Off": Information is not displayed.
- 8 Sets an on-screen display of the video1 playback screen. (Auto)
"Auto": Information is displayed for 5 seconds when updated.
"Manual": Information is displayed when you touch on the screen.
- 9 Sets an on-screen display of the video2 playback screen. (Auto)
"Auto": Information is displayed for 5 seconds when updated.
"Manual": Information is displayed when you touch on the screen.
- 10 Returns to the original screen.



- 11 Sets an on-screen display of the TV screen.
( Auto) (with the optional accessory TV tuner connected only)

"Auto": Information is displayed for 5 seconds when updated.

"Manual": Information is displayed when you touch on the screen.

- 12 Returns to the original screen.



- 13 Sets whether to display animation when switching screens. ( On)

- 14 Sets whether to display the name of the



buttons on the right side of the menu screen.

( Off)

- 15 Returns to the original screen.

Entering Background

Loads images for background.

- 1 Connect the device which has the image to load

- 2 Display the User Interface screen



- 3 Select the image to load

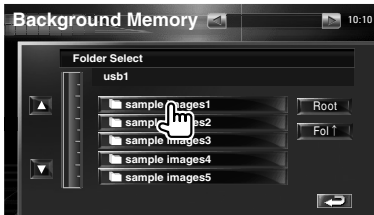

- 1 Returns to Media Select screen.
- 2 Returns to the previous folder.
- 3 Scrolls the list.

- 4 Load the image



- 4 Rotates the image.
- 5 Returns to the Picture Select screen.



- Refer to <About Picture files> (page 9) for readable image specifications.
- Up to 3 images can be loaded.
- This operation is not possible when USB is selected as the source.

Background Delete

Deletes the background image.

- 1 Display Delete Image Select screen



- 2 Select the image to be deleted

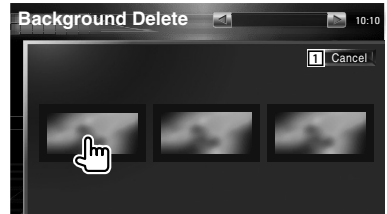

- 1 Returns to the original screen.

- 3 Delete the image

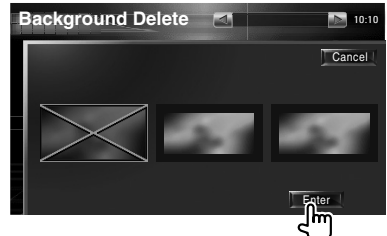

- 4 Confirm

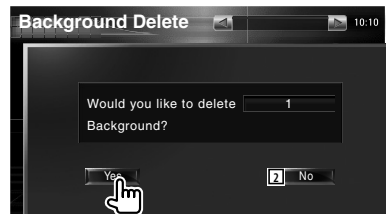

- 2 Returns to the Picture Select screen.

Background Select

Selects a image for background.

1 Select Background Select screen



2 Select a image for background

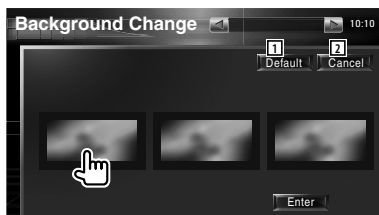

- 1 Returns to the initial background.
- 2 Returns to the original screen.

3 Set the image as the background

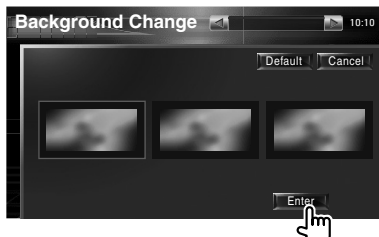

Touch panel Adjustment

You can adjust the touch panel operations.

1 Display the Touch panel Adjustment screen

Touch [Touch] in the SETUP Menu (page 56).

2 Starts Touch panel setup



- 1 Returns to the original screen.

3 Adjusts the Touch panel



Follow the instruction on the screen and touch the center of .

- 2 Cancels the adjustment and returns to the Touch Panel Adjust screen.
- 3 Resets to the initial status.

Clock Setup

You can adjust the clock time.

1 Display the Clock Setup screen

Touch [Clock] in the SETUP Menu (page 56).

2 Setup the Clock



- 1 Clock time display
- 2 Adjusts hours.
- 3 Adjusts minutes.
- 4 Sets "00" minute.
Setup examples: 3:00~3:29 → 3:00
3:30~3:59 → 4:00
- 5 Sets the clock time in synchronization with the time data sent from the RDS station. (On)
When turned "On", the synchronized mode starts and the clock cannot be adjusted manually.
- 6 Returns to the original screen.

3 Adjust the clock time



Monitor Setup

You can adjust the position, picture quality and the screen mode of the monitor.

1 Displaying the Monitor SETUP screen

Touch [Monitor SETUP] in the SETUP Menu (page 56).

2 Setup each item

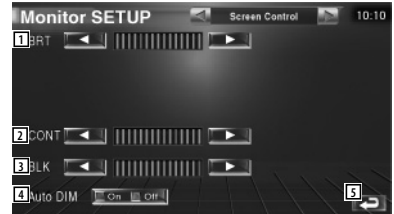

- 1 Brightness Control
Disabled if Auto Dimmer is On.
- 2 Contrast Control
- 3 Black Level Adjustment
- 4 Auto Dimmer Setup
When turned "On", the display is dimmed automatically when the ambient becomes dark.
- 5 Returns to the original screen.



- 6 Selects a screen mode of the iPod Video playback screen.
You can select any of the following screen mode.
"Full", "Just", "Zoom", "Normal"
- 7 Selects a screen mode of the VIDEO1 playback screen.
You can select any of the following screen mode.
"Full", "Just", "Zoom", "Normal"

- 8 Selects a screen mode of the VIDEO2 playback screen.
You can select any of the following screen mode.

"Full", "Just", "Zoom", "Normal"

- 9 Returns to the original screen.



- 10 Selects a screen mode of the rear view camera (R-CAM) screen.
You can select any of the following screen mode.

"Full", "Just", "Zoom", "Normal"

- 11 Selects a screen mode of the TV screen.
You can select any of the following screen mode.

"Full", "Just", "Zoom", "Normal"

- 12 Returns to the original screen.



- When you select the Menu, Easy Control screen, or Navigation, the display is shown in the full-size display mode automatically. The screen mode of these displays cannot be changed.
- The picture quality can be set for each source.

Full picture mode (Full)

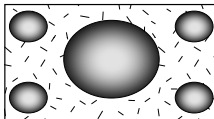

Zoom picture mode (Zoom)

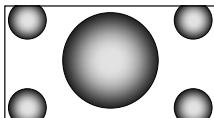

Justify picture mode (Just)

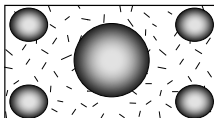

Normal picture mode (Normal)

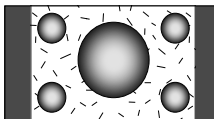

Security Code Setup

You can set a security code to protect your receiver system against theft.



- When the Security Code function is activated it cannot be released.
Note, your Security Code is the 4 digit number entered in your "Car Audio Passport" in this package.

1 Display the Security Code Setup screen

Touch [Security] in the SETUP Menu (page 56).



- Displays the Security code input screen.
- Returns to the original screen.

2 Start Security Code setup



- If you have already completed the code registration, cannot touch **Set**.

3 Enter a security Code

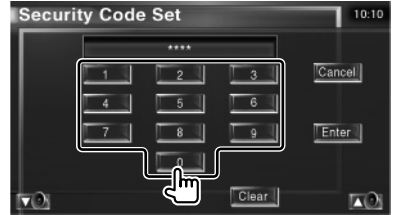

Input four-digit number.

4 Register your security code



5 Reenter the security code

Reenter the same security code as that you have entered in Step 3 for confirmation.



- If you enter a different security code, the screen returns to Step 3 (for the first code entry).

6 Register the security code again



Now, your security code is registered. If you press the Reset button or if you disconnect your receiver from the battery after the code registration, you need to enter the registered security code.

If you have pressed the Reset button or if you have disconnected the Receiver from battery...

1 Enter the correct security code

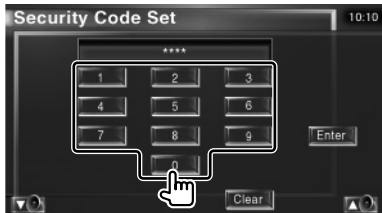

You must enter the same security code as that you have entered in Step 3.

2 Enter the security code



Now, you can use your Receiver.



- If you enter an incorrect security code, you cannot use your Receiver for a while.

Incorrect entry count	Receiver inoperable time
1	-
2	5 minutes
3	1 hour
4 or more	24 hours

TV Setup

The TV signal receiving areas can be set. (with the optional accessory TV Tuner connected only)

1 Displaying TV SETUP screen

Touch [TV SETUP] in the SETUP Menu (page 56).

2 Setting up TV



- 1 Sets the present TV1 receiving area.
- 2 Returns to the original screen.



- 3 Sets the present TV2 receiving area.
- 4 Returns to the original screen.

RDS Setup

The related RDS parameters can be set.

1 Display RDS SETUP screen

Touch [RDS SETUP] in the SETUP Menu (page 56).

2 Setting up RDS

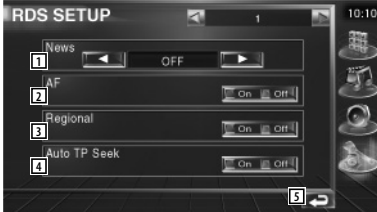

- 1 Sets a news bulletin interrupt time.
- 2 Turns the Alternative Frequency function On or Off. (☑ On)
- 3 Turns the Region Restriction function On or Off. (☑ On)
- 4 Turns the Auto TP Seek function On or Off. (☑ On)
- 5 Returns to the original screen.



- 6 Selects a display language for the PTY function.
- 7 Returns to the original screen.

DAB Setup

You can set the DAB reception. (only with the optional accessory DAB Tuner connected)

1 Display the DAB Setup screen

Touch [DAB Set Up] in the SETUP Menu (page 56).

2 Setting up DAB



- 1 Turns the DAB Priority On or Off.
- 2 Turns the Dynamic Range Control function On or Off.
- 3 Turns the Regional Announcement function On or Off.
- 4 Sets a program type to be selected automatically when the receiving ensemble starts.
- 5 Returns to the original screen.



- 6 Displays the Announcement Selection screen. (page 69)

Announcement Select

You can set various announcement reception parameters.

1 Display the Announcement screen

See <DAB Setup> (page 68).

2 Set the announcement parameters



1 Turns the Announcement Reception function On or Off.

2 Returns to the original screen.

AMP Control

Sets the power amp connected via the LX bus. (with the optional accessory LX Power Amp connected only)

1 Displaying the Amp Control screen

Touch [Amp Control] in the SETUP Menu (page 56).

2 Setting up Amp Control

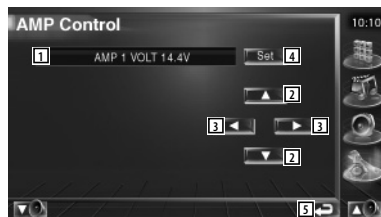

1 Setup option and value display

2 Select a setup option.

3 Selects a set value.

4 Enters the set value.

5 Returns to the original screen.



- For the model name of amp you can control from the system, see the amp's catalog.
- For the options and values you can change and for the amp's operation when changed, see the amp's instruction manual.

Setup Memory

Audio Set Up and AV Interface settings can be memorized. The memorized settings can be recalled at any time. For example, even when the settings are cleared due to replacement of the battery, the settings can be restored.

1 Display the SETUP Memory screen

Touch [SETUP Memory] in the SETUP Menu (page 56).

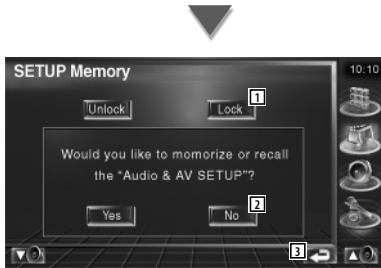

- 1 Locks the Audio Set Up and AV Interface settings. When **Lock** is selected, you cannot set the Audio Set Up and AV Interface settings.
- 2 Memorizes or recalls the settings. To cancel the function, touch **No**. To cancel memorization, touch **No**. The Setup Menu screen appears again.
- 3 Returns to the original screen.

2 Start Set Up Memory

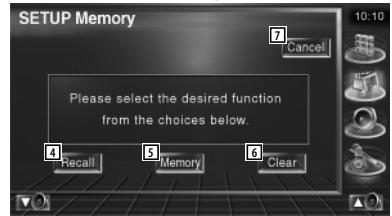
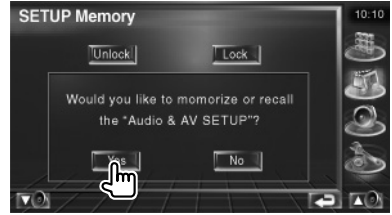

- 4 Recalls the memorized settings.
- 5 Memorizes the current Audio Set Up and AV Interface settings.
- 6 Clears the currently memorized settings.
- 7 Returns to Set Up Memory screen.

3 Memorize or recall the settings

When memorizing the Audio Set Up and AV Interface settings:

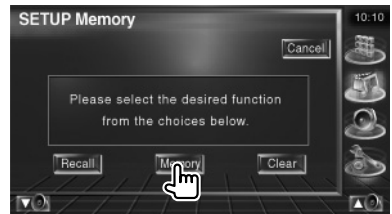

If settings have already been memorized, a confirmation message appears. Touch **Yes**. To cancel memorization, touch **No**.

When recalling the memorized settings:

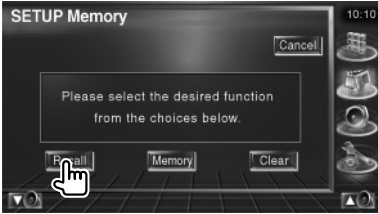

Touching the screen displays a confirmation message. Touch **Yes**. To cancel recalling, touch **No**.

When clearing the currently memorized settings:



Touching the screen displays a confirmation message. Touch **Yes**. To cancel clearing, touch **No**.

4 Quit memorization/recalling of settings



EXT SW Setup

Setting up power specification of the external device for which the power is controlled from this unit.

1 Display the EXT SW SETUP screen

Touch [Ext SW SETUP] in the SETUP Menu (page 56).

2 Perform EXT SW Setup

Setting EXT SW Control 1 (EXT SW1)

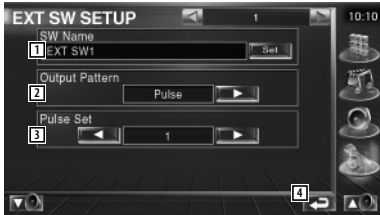

- 1 Sets the name of the external device. See <Character Entry> (page 47) for information on how to enter the name.
- 2 Sets the power signal output mode. (EXT SW1: Pulse, EXT SW2: Level)
Pulse: Generates a single power signal pulse.



Level: Continues output of high power signal.

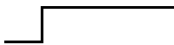

Sets to turn output on/off each time the button on the EXT SW Control screen is pressed.

- 3 Sets the Pulse signal output time. Outputs 500ms when "1" is set. Increases by 200ms with each step. Up to 100 steps can be set.
- 4 Returns to the original screen.



Setting EXT SW Control 2 (EXT SW2)

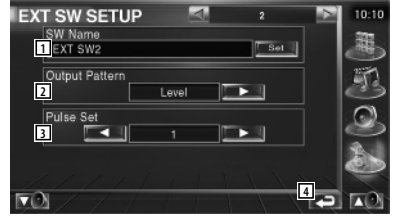

The setup method is the same as "EXT SW1".

Audio Control

Audio Control Menu

Displays the Audio Control menu to set the sound effect function of this unit.

1 Display the control screen



Press several times until the control screen appears.

2 Display the Audio Control menu

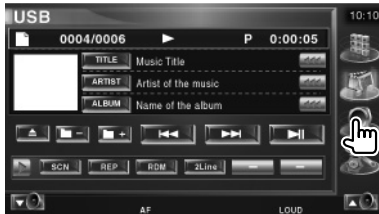

3 Select the Audio Control item

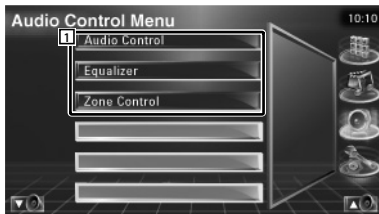

1 Switches to the selected Audio Control screen.

Audio Control

You can adjust the front/rear and right/left audio balance.

1 Display Audio Control



Touch [Audio Control] in the Audio Control Menu (page 74).

2 Display the Audio Control screen



- 1 Adjusts the right and left volume balance.
- 2 Adjusts the front and rear volume balance.
- 3 Turns the Loudness control function On or Off.
If turned "On", high and low tones are automatically enhanced during low volume.
- 4 Displays the present source information.
The stream (Dolby Digital, dts, Linear PCM, MPEG or MP3/WMA), input channels (front or rear channels) are displayed.
- 5 Returns to the original screen.



- 6 Adjusts the bass boost of the B.M.S power amplifier (optional accessory).
- 7 Sets the center frequency of bass boost you have set for "AMP Bass".
If you set the center frequency to "Low", it will be dropped approximately 20% to 30%.
- 8 Adjusts the subwoofer volume.
- 9 Adjusts the volume of the present source based on the difference level of original volume.
- 10 Returns to the original screen.



- If you have increased the volume first, then reduced the volume using the "Vol. Offset", the sound generated if you suddenly switch to another source may be extremely loud.
- You may not set some models of power amp boost to "+18". See the catalog or instruction manual of power amplifier.

Equalizer Control

You can set up the equalizer.

1 Display Equalizer Control



Touch [Equalizer] in the Audio Control Menu (page 74).

2 Display the Equalizer screen



- 1 Selects an equalizer curve type.
You can select any of the following equalizer curves.
 - "Natural"
 - "Rock"
 - "Pops"
 - "Easy"
 - "Top40"
 - "Jazz"
- 2 Selects items to be adjusted for tone curve setup.
If turned "Off", only Level can be setup for tone curves.
- 3 Displays the Tone curve setup screen. (page 76)
- 4 Returns to the original screen.

Tone Setup

You can set a Tone curve.

1 Display the Tone screen



See <Equalizer Control> (page 75).

2 Set the Tone



- 1 Bass adjustment items are displayed.
- 2 Middle adjustment items are displayed.
- 3 Treble adjustment items are displayed.
- 4 Bass DC Extend settings (Only when Bass is selected)
If turned "On", it extends the bass center frequency to the low register by approximately 20%.
- 5 Tone curve becomes flat.
- 6 Sets the Center frequency.
- 7 Sets the level.
- 8 Sets the Q factor. (Only Bass and Middle can be set)
- 9 Returns to the original screen.

Zone Control

You can set the front and rear audio source.

1 Display Zone Control



Touch [Zone Control] in the Audio Control Menu (page 74).



2 Set the Zone Control

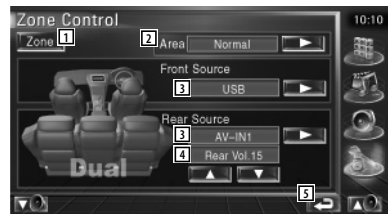

- 1 Turns the Zone Function (that sets different source sounds for front and rear speakers) On or Off.
- 2 Switches the front and rear audio sources. (This button appears when the Zone function is On.)
Use "Reverse" to change over the front and rear audio sources.
- 3 Sets the front and rear audio source separately. (This button appears when the Zone function is On.)



- When the rear speaker sound is switched, the audio source that is output at the AV OUTPUT terminal is also switched to the same source.
However, if you have set the "Area" to "Reverse", the audio source that is output at the AV OUTPUT terminal is switched depending on the front sound source.
 - 4 Adjusts the volume of the rear channel.
(This button appears when the Zone function is On.)
 - 5 Returns to the original screen.



- There are following limitations when zone function is set to "On".
 - There is no output from the subwoofer.
 - <Audio Setup> (page 56) and <Equalizer Control> (page 75) are not available.

Help? Troubleshooting

Some functions of this unit may be disabled by some settings made on this unit.

- !** • **Cannot set up the subwoofer.**
 - **Cannot set up subwoofer phase.**
 - **No output from the subwoofer.**
 - **Cannot set up the low pass filter.**
 - **Cannot set up the high pass filter.**
 - ▶ Subwoofer is not set to On. [☞] <Audio Setup> (page 56)
 - ▶ The Dual zone function is enabled. [☞] <Zone Control> (page 76)
-

- !** **Cannot set up the subwoofer phase.**
 - ▶ Subwoofer is not set to On. [☞] <Audio Setup> (page 56)
 - ▶ Low pass filter is set to Through. [☞] <Crossover Network Setup> (page 57)
-

- !** • **Cannot select the output destination of the subsource in the Dual zone.**
 - **Cannot adjust the volume of the rear speakers.**
 - ▶ The Dual zone function is disabled. [☞] <Zone Control> (page 76)
-

- !** **Cannot Folder select.**
 - ▶ The Scan play or Random play function is enabled.
-

- !** • **Cannot set up the equalizer.**
 - **Cannot set up the crossover network.**
 - ▶ The Dual zone function is enabled. [☞] <Zone Control> (page 76)
-

What might seem to be a malfunction in your unit may just be the result of slight misoperation or miswiring. Before calling service, first check the following table for possible problems.

General

- ?** **The Touch Sensor Tone doesn't sound.**
 - ✓ The preout jack is being used.
 - [☞] The Touch Sensor Tone can't be output from the preout jack.
-

Tuner source

- ?** **Radio reception is poor.**
 - ✓ The car antenna is not extended.
 - [☞] Pull the antenna out all the way.
 - ✓ The antenna control wire is not connected.
 - [☞] Connect the wire correctly, referring to the section on <Connection> (page 82).
-

Audio file source

- ?** **The sound skips when an Audio file is being played.**
 - ✓ The recording condition is bad.
 - [☞] Record the media again or use another media.
-

When the unit fails to operate correctly, the cause of the failure appears on the display.

Protect :

Protective circuit has been activated because a speaker cord has shorted or it has come in contact with the car chassis.

- ➔ Wire or insulate the speaker cord as appropriate and then push the Reset button.

Hot Error :

When the internal temperature of this unit rises to 60°C or more, the protection circuit is activated and you may not be able to operate the unit. At such times this message will appear.

- ➔ Use the unit again after reducing the temperature inside the vehicle.

Hold Error :

Activation of the protective circuit when the temperature inside the disc changer is higher than 60 degrees Celsius stops the disc changer from operating. At such times this message will appear.

- ➔ Use when the temperature at the site where the disc changer has been fitted has dropped.

Error 07-67:

The unit is not operating correctly due to some reason or other.

- ➔ Push the unit's Reset button. If the "Error 07-67" message does not disappear, see your nearest Kenwood dealer.

No Device (USB device)/Disconnected (iPod):

The USB device/iPod is selected as a source although no USB device/iPod is connected.

- ➔ Change the source to any source other than USB/iPod. Connect an USB device/iPod, and change the source to USB/iPod again.

No Music:

The connected USB device contains no playable audio file.

Media was played that doesn't have data recorded that the unit can play.

USB Device Error!:

The connected USB device is rated a current capacity higher than the allowable limit. .

- ➔ Check the USB device.
Some trouble may have occurred to the connected USB device.
- ➔ Change the source to any source other than USB. Remove the USB device.

Authorization Error:

Connection to the iPod has failed.

- ➔ Remove the iPod and then reconnect it. The unit does not support the iPod.
- ➔ Refer to <About iPod that can be supported to this unit> (page 7).

Update your iPod:

The iPod's software is an older version which the unit can support.

- ➔ Confirm that the software for the iPod is the latest version. Refer to <About iPod that can be supported to this unit> (page 7).

EXT SW: Error:

Connection to the external device has failed.









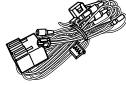
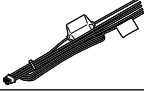
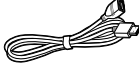

- ➔ Remove the external device and then reconnect it.
- ➔ Turn off the power or ACC and turn it back on.

You can connect only one iPod:

More than one iPod are connected to this unit.

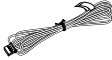
- ➔ Disconnect all the iPods, and then reconnect only one.

Accessories

Accessories	
①	 1
②	 1
③	 1
④	 1
⑤	 1
⑥	 1
⑦	 4
⑧	 1
⑨	 1
⑩	 1
⑩	 1
⑫	 1

Installation Procedure

Installation Procedure

1. To prevent short circuits, remove the key from the ignition and disconnect the ⊖ terminal of the battery.
2. Make the proper input and output wire connections for each unit.
3. Connect the wire on the wiring harness.
4. Take Connector B on the wiring harness and connect it to the speaker connector in your vehicle.
5. Take Connector A on the wiring harness and connect it to the external power connector on your vehicle.
6. Connect the wiring harness connector to the unit.
7. Install the unit in your car.
8. Reconnect the ⊖ terminal of the battery.
9. Press the reset button.



- If the power is not turned ON (or it is ON, but will be OFF immediately), the speaker wire may have a short-circuit or touched the chassis of the vehicle and the protection function may have been activated. Therefore, the speaker wire should be checked.
- If your car is not prepared for this special connection-system, consult your Kenwood dealer.
- Only use antenna conversion adapters (ISO-JASO) when the antenna cord has an ISO plug.
- Make sure that all wire connections are securely made by inserting jacks until they lock completely.
- If your vehicle's ignition does not have an ACC position, or if the ignition wire is connected to a power source with constant voltage such as a battery wire, the power will not be linked with the ignition (i.e., it will not turn on and off along with the ignition). If you want to link the unit's power with the ignition, connect the ignition wire to a power source that can be turned on and off with the ignition key.
- If the fuse blows, first make sure that the wires have not caused a short circuit, then replace the old fuse with one with the same rating.
- Insulate unconnected wires with vinyl tape or other similar material. To prevent short circuits, also do not remove the caps on the ends of the unconnected wires or the terminals.
- Connect the speaker wires correctly to the terminals to which they correspond. The unit may receive damage or fail to work if you share the ⊖ wires and/or ground them to any metal part in the car.
- After the unit is installed, check whether the brake lamps, indicators, wipers, etc. on the car are working properly.

- If the console has a lid, make sure to install the unit so that the faceplate does not hit the lid when closing and opening.
- Mount the unit so that the mounting angle is 30° or less.

Connection

Antenna cord is used when receiving a radio station with the built-in tuner. In this case, set "TUNER source" in <System Setup> (page 58) to "On".

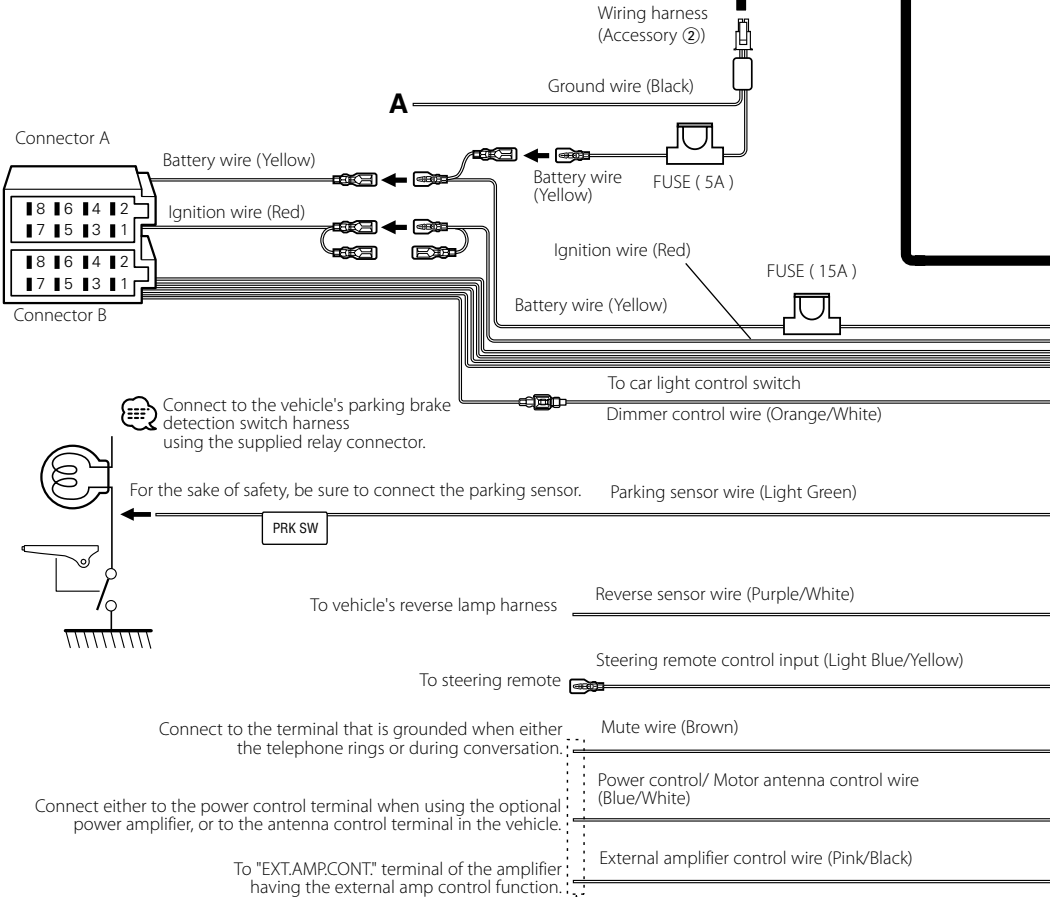
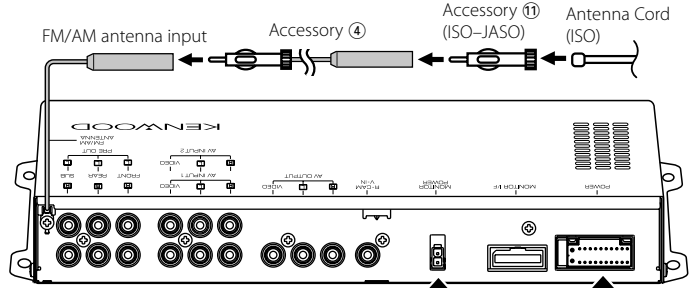

If no connections are made, do not let the cable come out from the tab.

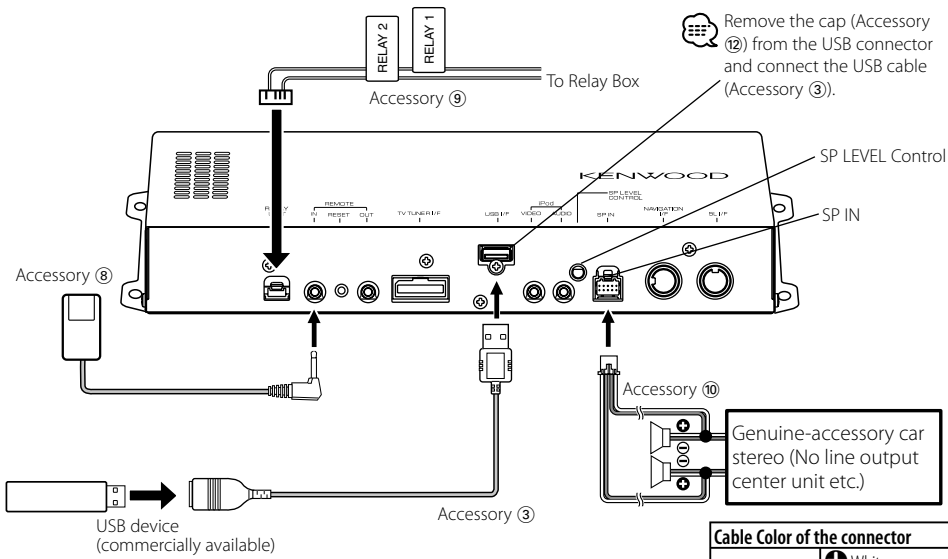

USB device
(commercially available)

Genuine-accessory car stereo (No line output center unit etc.)

Cable Color of the connector	
Left	⊕ White
	⊖ White/Black
Right	⊕ Gray
	⊖ Gray/Black

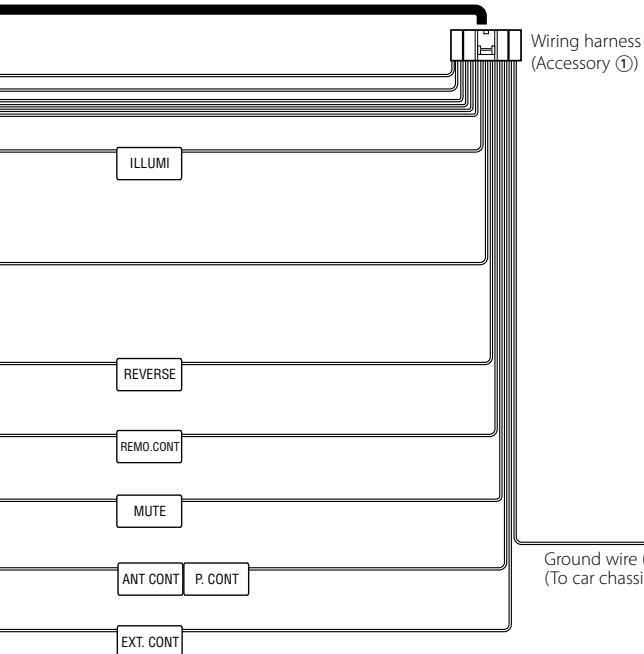

Wiring harness
(Accessory 1)

Ground wire (Black) ⊖
(To car chassis)

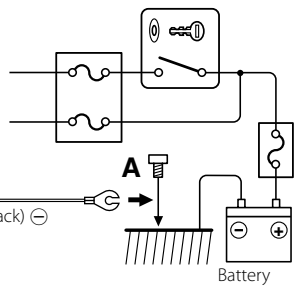

⚠ If you connect the ignition wire (red) and the battery wire (yellow) to the car chassis (ground), you may cause a short circuit, that in turn may start a fire. Always connect those wires to the power source running through the fuse box.

Connecting Wires to Terminals

Connector Function Guide		
Pin Numbers for ISO Connectors	Cable Colour	Functions
External Power Connector		
A-4	Yellow	Battery
A-5	Blue/White	Power Control
A-6	Orange/White	Dimmer
A-7	Red	Ignition (ACC)
A-8	Black	Earth (Ground) Connection
Speaker Connector		
B-1	Purple	Rear Right (+)
B-2	Purple/Black	Rear Right (-)
B-3	Gray	Front Right (+)
B-4	Gray/Black	Front Right (-)
B-5	White	Front Left (+)
B-6	White/Black	Front Left (-)
B-7	Green	Rear Left (+)
B-8	Green/Black	Rear Left (-)

⚠ WARNING

Connecting the ISO Connector

The pin arrangement for the ISO connectors depends on the type of vehicle you drive. Make sure to make the proper connections to prevent damage to the unit.

The default connection for the wiring harness is described in **1** below. If the ISO connector pins are set as described in **2** or **3**, make the connection as illustrated.

Please be sure to reconnect the cable as shown **2** below to install this unit to the **Volkswagen** vehicles etc.

1 (Default setting) The A-7 pin (red) of the vehicle's ISO connector is linked with the ignition, and the A-4 pin (yellow) is connected to the constant power supply.

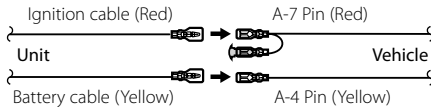

2 The A-7 pin (red) of the vehicle's ISO connector is connected to the constant power supply, and the A-4 pin (yellow) is linked to the ignition.

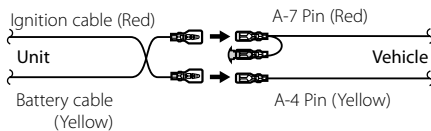

3 The A-4 pin (yellow) of the vehicle's ISO connector is not connected to anything, while the A-7 pin (red) is connected to the constant power supply (or both the A-7 (red) and A-4 (yellow) pins are connected to the constant power supply).

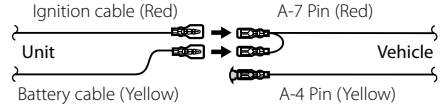

When the connection is made as in **3** above, the unit's power will not be linked to the ignition key. For that reason, always make sure to turn off the unit's power when the ignition is turned off.

To link the unit's power to the ignition, connect the ignition cable (ACC...red) to a power source that can be turned on and off with the ignition key.

System Connection

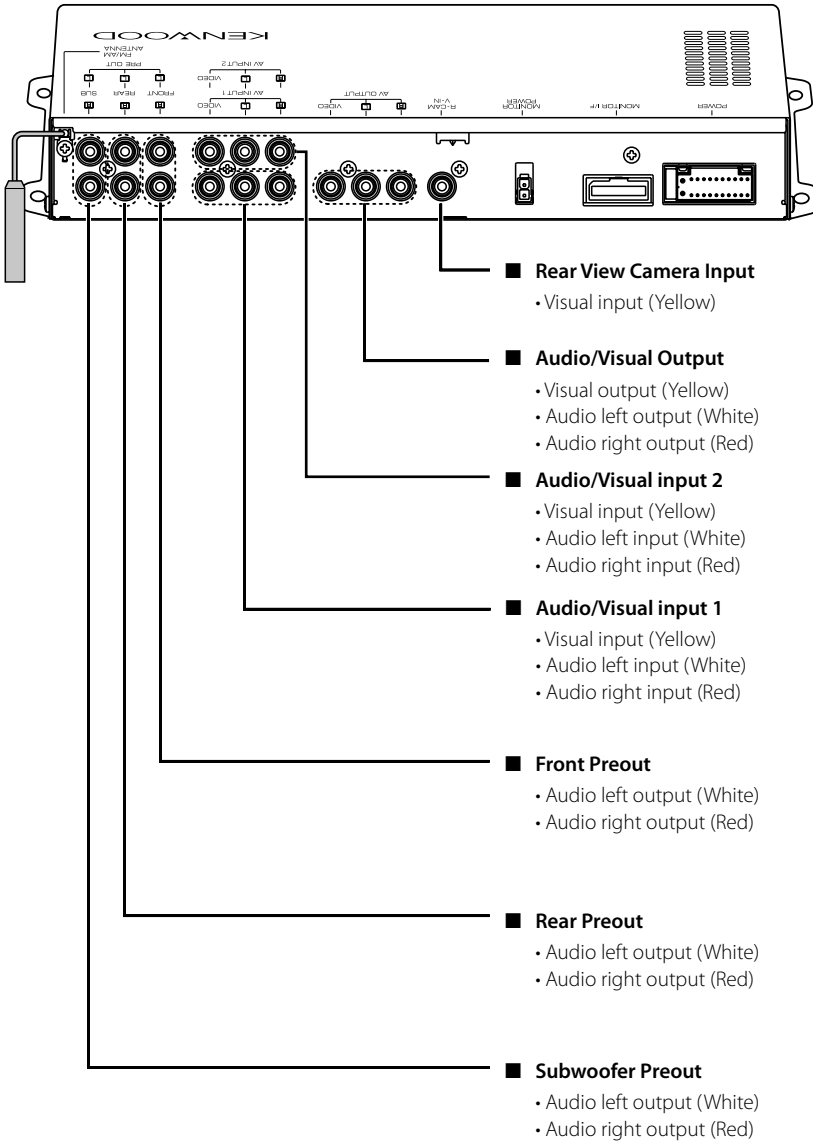

Optional Accessory Connection

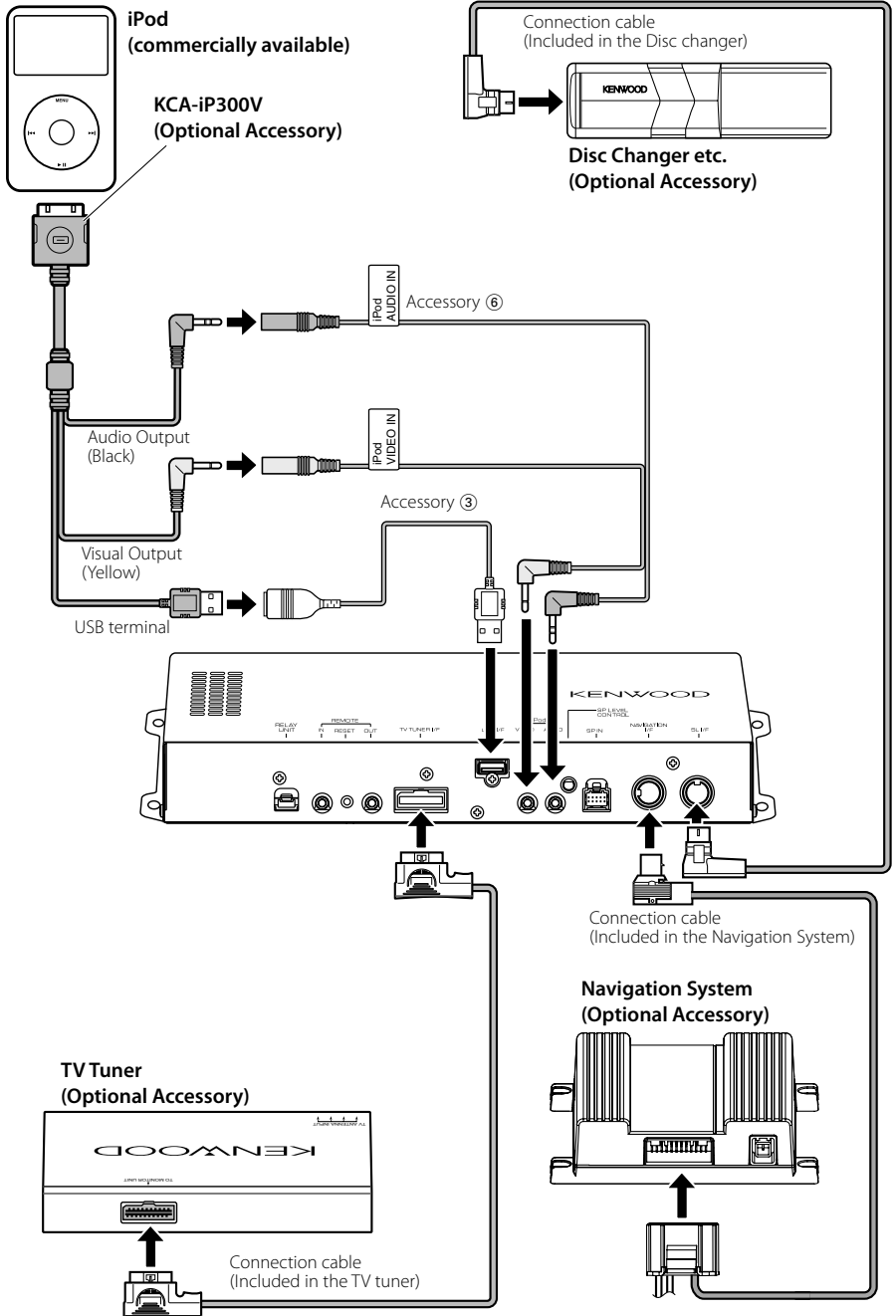

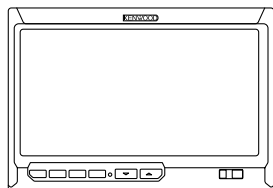

KOS-L702
(Optional Accessory)

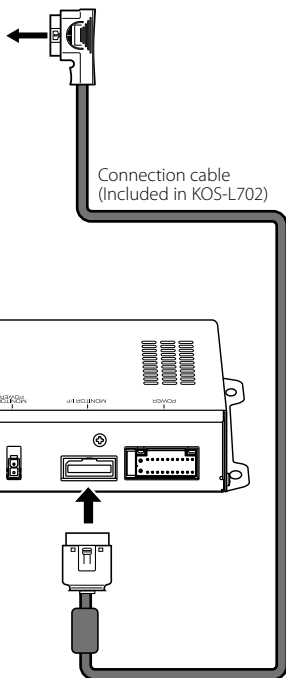

Connection cable
(Included in KOS-L702)

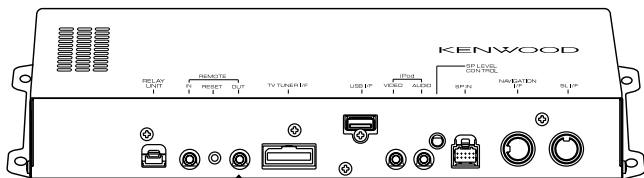
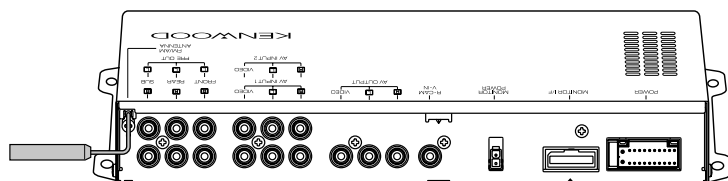

Accessory ⑤

DVD Player etc. (Optional Accessory)

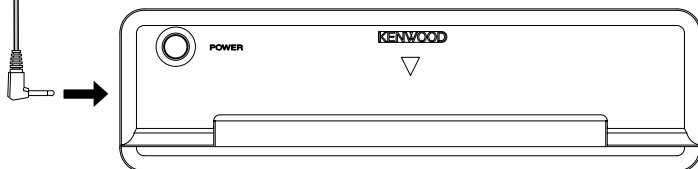

Installation

Installation for Remote control sensor

- 1 Wipe off the installation location with a cleaning cloth.
- 2 Secure the Remote control sensor (Accessory ⑧) in the specified place with the double-sided adhesive tape.

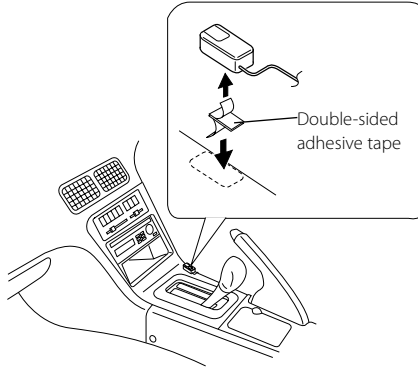

- Install the Remote control sensor on a flat surface. If it is installed on a curved surface, the tape adhesion may weaken and the controller may come off.
- Do not install the Remote control sensor in places (such as on the dashboard) where it is exposed to direct sunlight and the temperature becomes high. Otherwise, the Remote control sensor will become deformed and unusable.
- Install the Remote control sensor in places that do not obstruct driving. Install the Remote control sensor temporarily and verify that the handle, shift knob, and side brake can be operated smoothly.

Installation for A/V controller Unit

Use Tapping screws (Accessory ⑦) to fix A/V controller Unit onto an audio board or another.

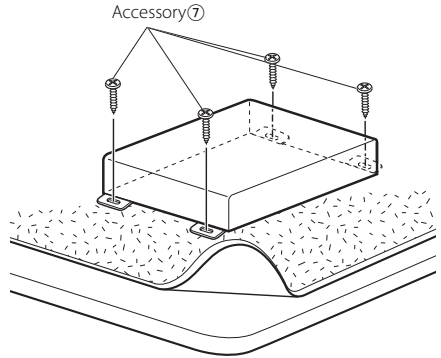

Specifications

USB interface section

USB Standard

: USB1.1/ 2.0

File System

: FAT16/ 32

Maximum Supply current

: 500 mA

D/A Converter

: 24 bit

Decoder

: MP3/ WMA/AAC

FM tuner section

Frequency range (50 kHz space)

: 87.5 MHz – 108.0 MHz

Usable sensitivity (S/N = 26dB)

: 0.7 μ V /75 Ω

Quieting Sensitivity (S/N = 46dB)

: 1.6 μ V /75 Ω

Frequency response (\pm 3.0 dB)

: 30 Hz – 15 kHz

S/N Ratio (MONO)

: 65 dB

Selectivity (DIN)(\pm 400 kHz)

: \geq 80 dB

Stereo separation (1 kHz)

: 35 dB

LW tuner section

Frequency range

: 153 kHz – 281 kHz

Usable sensitivity (S/N = 20dB)

: 45 μ V

MW tuner section

Frequency range (9 kHz space)

: 531 kHz – 1611 kHz

Usable sensitivity (S/N = 20dB)

: 25 μ V

Video section

Color system of external video input
: NTSC/PAL

External video input level (RCA jacks)
: 1V_{p-p}/75Ω

External audio max input level (RCA jacks)
: 2V/25kΩ

Analog RGB input (NAVI)(TV-SECAM)
: 0.7V_{p-p}/75Ω

Video output level (RCA jacks)
: 1V_{p-p}/75Ω

Audio output level (RCA jacks)
: 1.2V/10kΩ

Audio section

Maximum power (Front&Rear)
: 50 W × 4

Full Bandwidth Power (Front&Rear)
(DIN45324, +B=14.4V)
: 30 W × 4

Preout Level
: 2V/10 kΩ

Preout Impedance
: ≤ 600 Ω

Speaker Impedance
: 4 – 8 Ω

Tone action

Bass : 100 Hz ± 8 dB

Middle : 1 kHz ± 8 dB

Treble : 10 kHz ± 8 dB

External SW

Maximum Power Supply Current
: 500mA

General

Operating voltage
: 14.4 V (11 – 16 V allowable)

Current Consumption
: 15 A

Installation Size (W × H × D)
: 319.2mm×41.0mm×232.0mm

Operational Temperature Range
: -10 °C – +60 °C

Storage Temperature Range
: -20 °C – +85 °C

Weight
: 2.0 kg

This Product is not installed by the manufacturer of a vehicle on the production line, nor by the professional importer of a vehicle into an EU Member State.

Information on Disposal of Old Electrical and Electronic Equipment (applicable for EU countries that have adopted separate waste collection systems)



Products with the symbol (crossed-out wheeled bin) cannot be disposed of as household waste. Old electrical and electronic equipment should be recycled at a facility capable of handling these items and their waste byproducts. Contact your local authority for details in locating a recycle facility nearest to you. Proper recycling and waste disposal will help conserve resources whilst preventing detrimental effects on our health and the environment.

Apple, the Apple logo, and iPod are trademarks of Apple Inc., registered in the U.S. and other countries.

The "AAC" logo is trademark of Dolby Laboratories.

Free Manuals Download Website

<http://myh66.com>

<http://usermanuals.us>

<http://www.somanuals.com>

<http://www.4manuals.cc>

<http://www.manual-lib.com>

<http://www.404manual.com>

<http://www.luxmanual.com>

<http://aubethermostatmanual.com>

Golf course search by state

<http://golfingnear.com>

Email search by domain

<http://emailbydomain.com>

Auto manuals search

<http://auto.somanuals.com>

TV manuals search

<http://tv.somanuals.com>