



FM /AM RECEIVER

# KR-A5060 KR-A4060

## INSTRUCTION MANUAL

KENWOOD CORPORATION

This manual contains instructions for two models.

### For your records

Record the serial number, found on the back of the unit, in the spaces designated on the warranty card, and in the space provided below. Refer to the model and serial numbers whenever you call upon your dealer for information or service on this product.

Model \_\_\_\_\_ Serial Number \_\_\_\_\_

### Unpacking

Unpack the unit carefully and make sure that all accessories are put aside so they will not be lost. Examine the unit for any possibility of shipping damage. If your unit is damaged or fails to operate, notify your dealer immediately. If your unit was shipped to you directly, notify the shipping company without delay. Only the consignee (the person or company receiving the unit) can file a claim against the carrier for shipping damage.

We recommend that you retain the original carton and packing materials for use should you transport or ship the unit in the future.

### Accessories

FM indoor antenna ..... (1)	AM loop antenna ..... (1)	Loop antenna stand ..... (1)
Remote control unit ..... (1)	Batteries (R6/AA) ..... (2)	

## Contents

Caution : Read the pages marked **⚠** carefully to ensure safe operation.

<b>Before applying power</b>	⚠ Safety precautions .....	2
	⚠ Before applying power .....	2
<b>IMPORTANT SAFEGUARDS</b>	.....	3
<b>System connection</b>	.....	6
<b>Controls and indicators</b>	.....	11
<b>Operation of remote control unit</b>	.....	13
<b>Playing music</b>	.....	14
<b>Sound adjustment functions</b>	.....	15
<b>Recording</b>	.....	17
	Recording .....	17
	Copying tape (Tape dubbing) .....	17
<b>Broadcast Reception</b>	.....	18
	Receiving broadcast station .....	18
	Receiving radio station by specifying its frequency .....	19
	Storing radio stations in mamory (Station preset) .....	20
<b>In case of difficulty</b>	.....	21
<b>Specifications</b>	.....	22

# Before applying power

**⚠ Caution : Read this page carefully to ensure safe operation.**

2





## Before applying power

Units are designed for operation as follows.

U.S.A., Mexico and Canada ..... 120 V only  
Australia ..... 240 V only

## Safety precautions

**WARNING :** TO PREVENT FIRE OR ELECTRIC SHOCK, DO NOT EXPOSE THIS APPLIANCE TO RAIN OR MOISTURE.

	<b>CAUTION</b> RISK OF ELECTRIC SHOCK DO NOT OPEN		CAUTION: TO REDUCE THE RISK OF ELECTRIC SHOCK, DO NOT REMOVE COVER (OR BACK). NO USER-SERVICEABLE PARTS INSIDE, REFER SERVICING TO QUALIFIED SERVICE PERSONNEL.
	THE LIGHTNING FLASH WITH ARROWHEAD SYMBOL, WITHIN AN EQUILATERAL TRIANGLE, IS INTENDED TO ALERT THE USER TO THE PRESENCE OF UNINSULATED "DANGEROUS VOLTAGE" WITHIN THE PRODUCT'S ENCLOSURE THAT MAY BE OF SUFFICIENT MAGNITUDE TO CONSTITUTE A RISK OF ELECTRIC SHOCK TO PERSONS.		
	THE EXCLAMATION POINT WITHIN AN EQUILATERAL TRIANGLE IS INTENDED TO ALERT THE USER TO THE PRESENCE OF IMPORTANT OPERATING AND MAINTENANCE (SERVICING) INSTRUCTIONS IN THE LITERATURE ACCOMPANYING THE APPLIANCE.		

### For the U.S.A.

#### FCC WARNING

This equipment may generate or use radio frequency energy. Changes or modifications to this equipment may cause harmful interference unless the modifications are expressly approved in the instruction manual. The user could lose the authority to operate this equipment if an unauthorized change or modification is made.

#### NOTE:

This equipment has been tested and found to comply with the limits for a Class B digital device, pursuant to Part 15 of the FCC Rules. These limits are designed to provide reasonable protection against harmful interference in a residential installation. This equipment may cause harmful interference to radio communications, if it is not installed and used in accordance with the instructions. However, there is no guarantee that interference will not occur in a particular installation. If this equipment does cause harmful interference to radio or television reception, which can be determined by turning the equipment off and on, the user is encouraged to try to correct the interference by one or more of the following measures:

- Reorient or relocate the receiving antenna.
- Increase the separation between the equipment and receiver.
- Connect the equipment into an outlet on a circuit different from that to which the receiver is connected.
- Consult the dealer or an experienced radio / TV technician for help.

### For the U.S.A.

#### Note to CATV system installer:

This reminder is provided to call the CATV system installer's attention to Article 820-40 of the NEC that provides guidelines for proper grounding and, in particular, specifies that the cable ground shall be connected to the grounding system of the building, as close to the point of cable entry as practical.

# IMPORTANT SAFEGUARDS

⚠ Caution: Read this page carefully to ensure safe operation.

Please read all of the safety and operating instructions before operating this appliance. Adhere to all warnings on the appliance and in the instruction manual. Follow all the safety and operating instructions. These safety and operating instructions should be retained for future reference.

- 1. Power sources** – The appliance should be connected to a power supply only of the type described in the instruction manual or as marked on the appliance. If you are not sure of the type of power supply to your home, consult your appliance dealer or local power company. For appliances intended to operate from battery power, or other sources, refer to the instruction manual.
- 2. Power-cord protection** – Power-supply cords should be routed so that they are not likely to be walked on or pinched by items placed upon or against them, paying particular attention to cords at plugs, convenience receptacles, and the point where they exit from the appliance.

Never pull or stretch the cord.

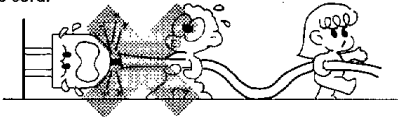

- 3. CAUTION – Polarization** – This appliance may be equipped with a polarized alternating-current line plug (a plug having one blade wider than the other). This plug will fit into the power outlet only one way. This is a safety feature. If you are unable to insert the plug fully into the outlet, try reversing the plug. If the plug should still fail to fit, contact your electrician to replace your obsolete outlet. Do not defeat the safety purpose of the polarized plug.

- 4. Ventilation** – Slots and openings in the cabinet are provided for ventilation and to ensure reliable operation of the appliance and to protect it from overheating, and these openings must not be blocked or covered. The appliance should be situated so that its location or position does not interfere with its proper ventilation.

To maintain good ventilation, do not put records or a table-cloth on the appliance. Place the appliance at least 10 cm away from the walls.

Do not use the appliance on a bed, sofa, rug or similar surface that may block the ventilation openings. This appliance should not be placed in a built-in installation such as a bookcase or rack unless proper ventilation is provided or the manufacturer's instructions have been adhered to.

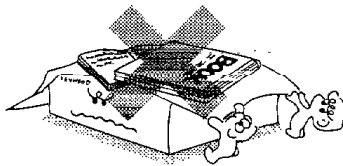

- 5. Water and moisture** – The appliance should not be used near water - for example, near a bathtub, washbowl, kitchen sink, laundry tub, in a wet basement, or near a swimming pool, etc.

- 6. Temperature** – The appliance may not function properly if used at extremely low, or freezing temperatures. The ideal ambient temperature is above +5°C (41°F).

- 7. Heat** – The appliance should be situated away from heat sources such as radiators, heat registers, stoves, or other appliances (including amplifiers) that produce heat.

- 8. Electric shock** – Care should be taken so that objects do not fall and liquid is not spilled into the enclosure through openings. If a metal object, such as a hair pin or a needle, comes into contact with the inside of this appliance, a dangerous electric shock may result. For families with children, never permit children to put anything, especially metal, inside this appliance.

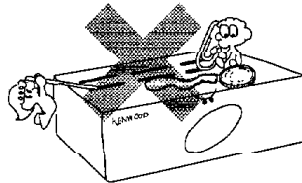

- 9. Enclosure removal** – Never remove the enclosure. If the internal parts are touched accidentally, a serious electric shock might occur.

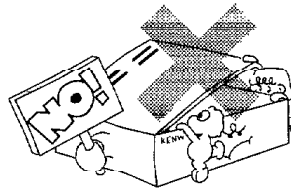

- 10. Magnetic fields** – Keep the appliance away from sources of magnetic fields such as TV sets, speaker systems, radios, motorized toys or magnetized objects.

- 11. Cleaning** – Unplug this appliance from the wall outlet before cleaning. Do not use volatile solvents such as alcohol, paint thinner, gasoline, or benzene, etc. to clean the cabinet. Use a clean dry cloth.

- 12. Accessories** – Do not place this appliance on an unstable cart, stand, tripod, bracket, or table. The appliance may fall, causing serious injury to a child or adult, and serious damage to the appliance. Use only with a cart, stand, tripod, bracket, or table recommended by the manufacturer, or sold with the appliance. Any mounting of the appliance should follow the manufacturer's instructions, and should use a mounting accessory recommended by the manufacturer. An appliance and cart combination should be moved with care. Quick stops, excessive force, and uneven surfaces may cause the appliance and cart combination to overturn.



4

**13. Lightning** – For added protection for this appliance during a lightning storm, or when it is left unattended and unused for long periods of time, unplug it from the wall outlet and disconnect the antenna or cable system. This will prevent damage to the appliance due to lightning and power-line surges.

**14. Abnormal smell** – If an abnormal smell or smoke is detected, immediately turn the power OFF and unplug the appliance from the wall outlet. Contact your dealer or nearest service center.

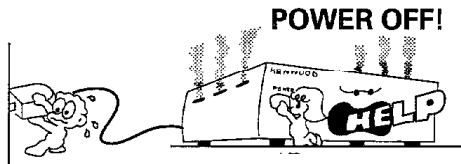

**15. Damage requiring service** – The appliance should be serviced by qualified service personnel when:

- A. The power-supply cord or the plug has been damaged.
- B. Objects have fallen, or liquid has been spilled into the appliance.
- C. The appliance has been exposed to rain or water.
- D. The appliance does not appear to operate normally by following the instruction manual. Adjust only those controls that are covered by the instruction manual as an improper adjustment of other controls may result in damage and will often require extensive work by a qualified technician to restore the appliance to its normal operation.
- E. The appliance has been dropped, or the enclosure damaged.
- F. The appliance exhibits a marked change in performance.

**16. Servicing** – The user should not attempt to service the appliance beyond that described in the instruction manual. All other servicing should be referred to qualified service personnel.

**17. Outdoor antenna grounding** – If an outside antenna is connected to the appliance, be sure the antenna system is grounded so as to provide some protection against voltage surges and built up static charges. Article 810 of the National Electrical Code ANSI/NFPA 70, provides information with respect to proper grounding of the mast and supporting structure, grounding of the lead-in wire to an antenna discharge unit, size of grounding conductors, location of antenna discharge unit, connection to grounding electrodes, and requirements for the grounding electrode. See Figure.

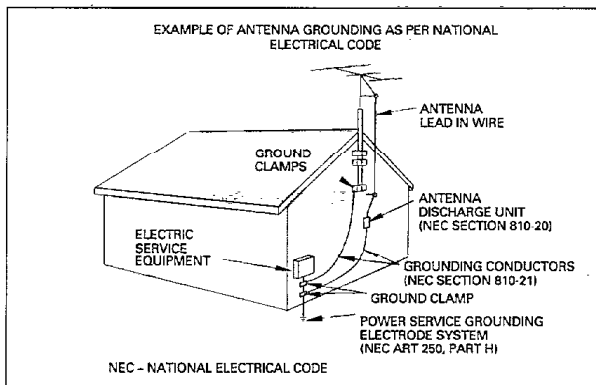

**18. Power lines** – An outside antenna system should not be located in the vicinity of overhead power lines or other electric light or power circuits, or where it can fall into such power lines or circuits. When installing an outside antenna system, extreme care should be taken to keep from touching such power lines or circuits as contact with them might be fatal.

**19. AC outlets** – Do not connect other audio equipment with a power consumption larger than that specified to the AC outlet on the rear panel. Never connect other electrical appliances, such as an iron or toaster, to it to prevent fire or electric shock.

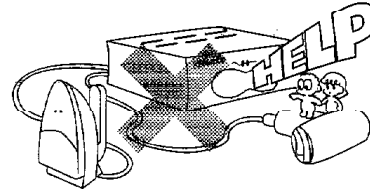

**20. Overloading** – Do not overload wall outlets, extension cords, or integral convenience receptacles as this can result in a risk of fire or electric shock.

**21. Attachment** – Do not use attachments not recommended by the appliance manufacturer as they may cause hazards.

**22. Replacement parts** – When replacement parts are required, be sure the service technician has used replacement parts specified by the manufacturer or have the same characteristics as the original parts. Unauthorized substitutions may result in fire, electric shock, or other hazards.

**23. Safety check** – Upon completion of any service or repairs to this appliance, ask the service technician to perform safety checks to determine that the appliance is in proper operating condition.

**Notes:**

- 1. Item 3 is not required except for grounded or polarized equipment.
- 2. Item 17 and 18 are not required except for units provided with antenna terminals.
- 3. Item 17 complies with UL in the U.S.A.



# System connection (KR-A5060)

6

Make connection as shown below. When connecting the related system components, refer also to the instruction manuals of the related components.  
Do not plug in the power lead until all connections are completed.

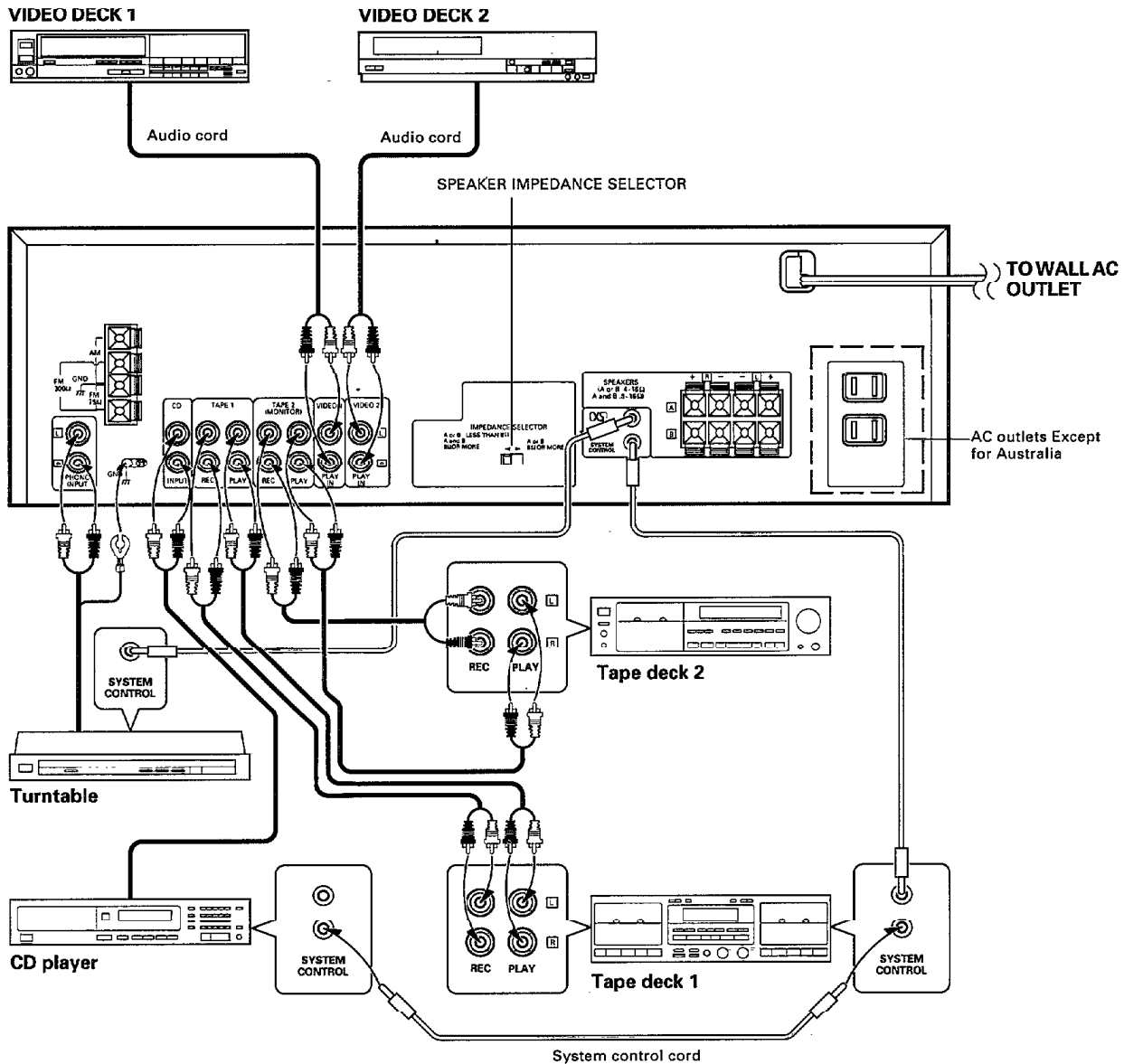

## Automatic operation

When this unit is connected to KENWOOD system components such as a cassette deck and CD player through system control cords and the input source is selected with the INPUT SELECTOR, the selected component starts to play automatically. Inversely, playing a component automatically selects that source as the input to this unit. The automatic operation also occurs when the provided remote control is used.

### Notes



1. Connect all cords firmly. If connections are loose, there could be loss of sound or noise produced.
2. When plugging and unplugging connection cords, be sure to first remove the power cord from the AC outlet. Plugging / unplugging connection cords without removal of the power cord can cause malfunctions or damage to the unit.
3. Do not connect up a power source which is larger than that indicated on the socket at the rear of the unit.
4. Insert the system control plugs completely into the jacks.
5. If the system control cords or audio cords are not connected properly, the remote control or automatic operation between system components will not work properly.

# Connection of speakers (KR-A5060)

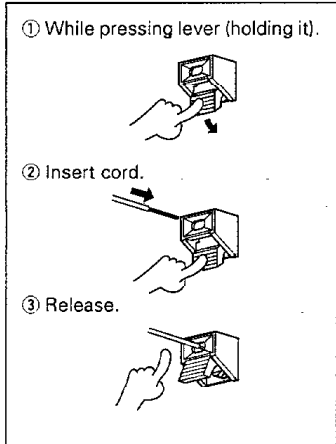

- Never short-circuit the + and - speaker cords.
- If the left and right speakers are connected inversely or if the speaker cords are connected with reversed polarity, the sound becomes unnatural with ambiguous acoustic image positioning. Be sure to connect the speakers and speaker cords correctly.

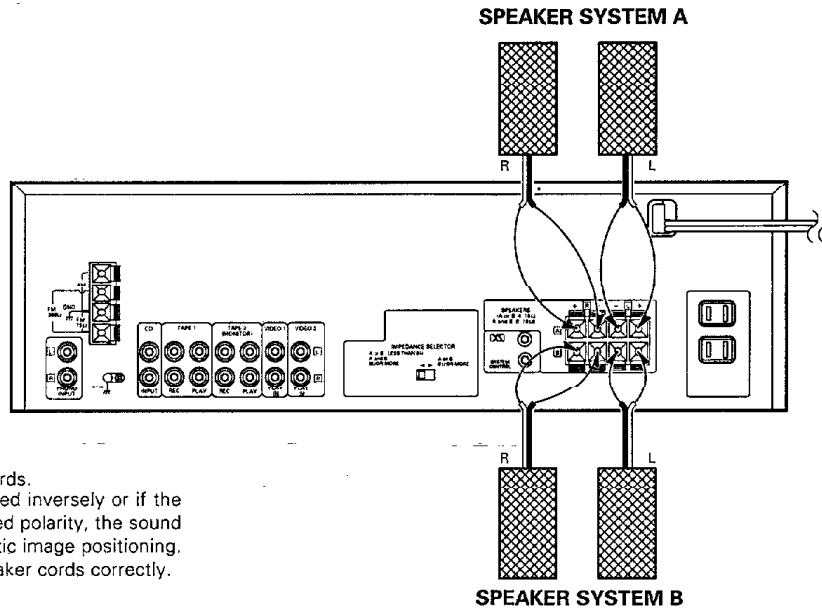

**Speaker IMPEDANCE SELECTOR CAUTION :** During operation of the speaker IMPEDANCE SELECTOR, set the POWER switch to OFF. Set the IMPEDANCE SELECTOR switch on the rear panel according to the impedance of the speakers used.

Front speaker impedance	Selector position
A or B speakers 4Ω – 6Ω A and B speakers 8Ω – 16Ω	
A or B speakers 8Ω – 16Ω	

- It is not possible to use both A and B speaker systems if speakers have impedances from 4 ohms to 6 ohms.

# System connection (KR-A4060)

8

Make connection as shown below. When connecting the related system components, refer also to the instruction manuals of the related components.  
Do not plug in the power lead until all connections are completed.

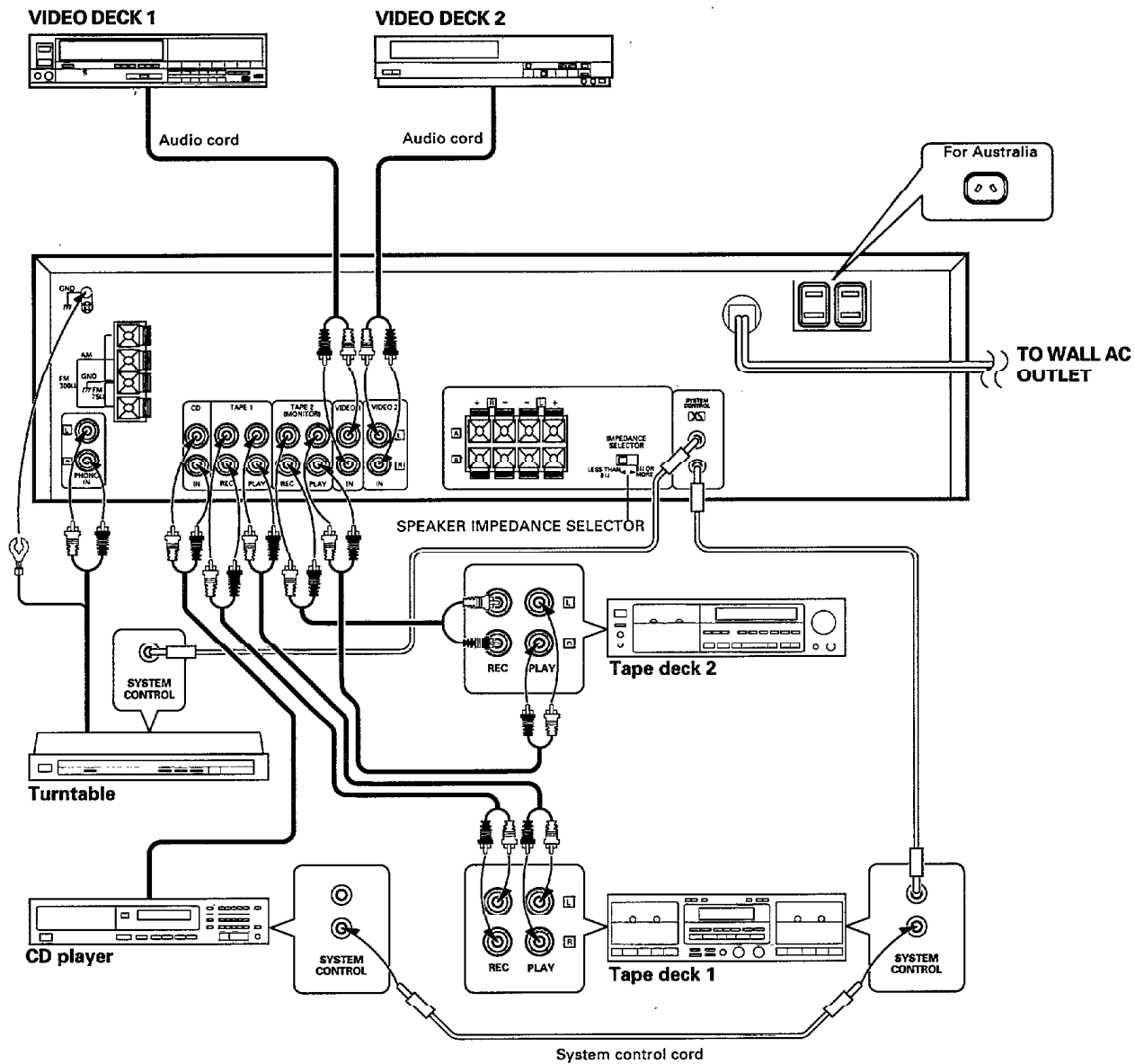

## Automatic operation

When this unit is connected to KENWOOD system components such as a cassette deck and CD player through system control cords and the input source is selected with the INPUT SELECTOR, the selected component starts to play automatically. Inversely, playing a component automatically selects that source as the input to this unit. The automatic operation also occurs when the provided remote control is used.

### Notes



1. Connect all cords firmly. If connections are loose, there could be loss of sound or noise produced.
2. When plugging and unplugging connection cords, be sure to first remove the power cord from the AC outlet. Plugging / unplugging connection cords without removal of the power cord can cause malfunctions or damage to the unit.
3. Do not connect up a power source which is larger than that indicated on the socket at the rear of the unit.
4. Insert the system control plugs completely into the jacks.
5. If the system control cords or audio cords are not connected properly, the remote control or automatic operation between system components will not work properly.



# Connection of speakers (KR-A4060)

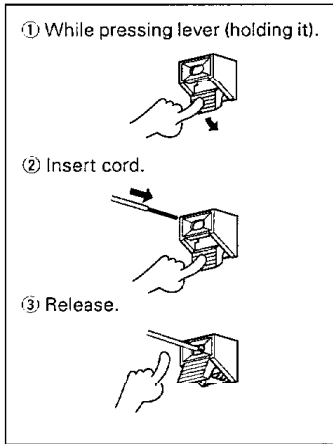

- Never short-circuit the + and - speaker cords.
- If the left and right speakers are connected inversely or if the speaker cords are connected with reversed polarity, the sound becomes unnatural with ambiguous acoustic image positioning. Be sure to connect the speakers and speaker cords correctly.

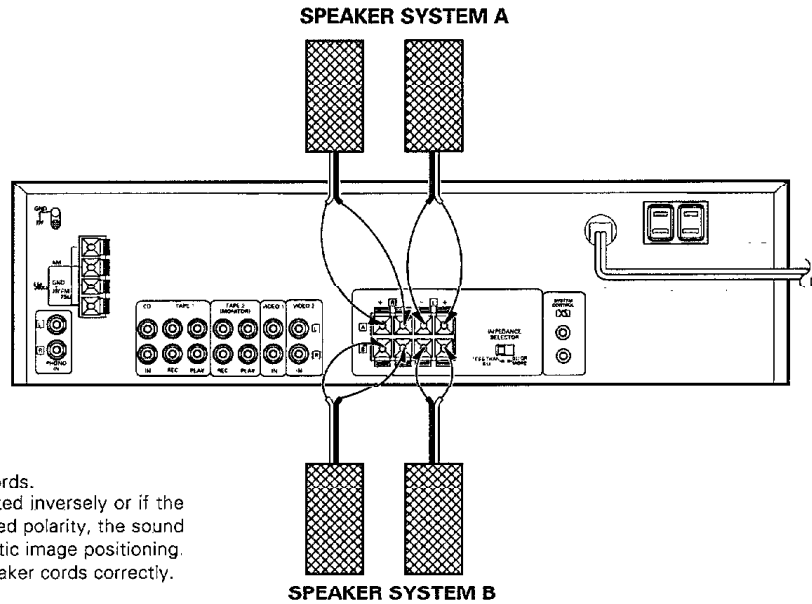

**Speaker IMPEDANCE SELECTOR CAUTION :** During operation of the speaker IMPEDANCE SELECTOR, set the POWER switch to OFF. Set the IMPEDANCE SELECTOR switch on the rear panel according to the impedance of the front speakers used.

Front speaker impedance	Selector position.
A or B speakers 4Ω - 6Ω	
A or B speakers 8Ω - 16Ω A and B speakers 8Ω - 16Ω	

- It is not possible to use both A and B speaker systems if speakers have impedances from 4 ohms to 6 ohms.

**Connection method to each antenna terminal**

- ① While pressing lever (holding it).    ② Insert cord.    ③ Release.

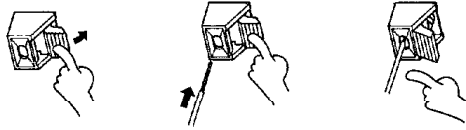

## Connection of AM antenna

**AM loop antenna connection**

The supplied antenna is for indoor use. Place it as far as possible from the main system, TV set, speaker cords and power cord, and set it to a direction which provides the best reception.

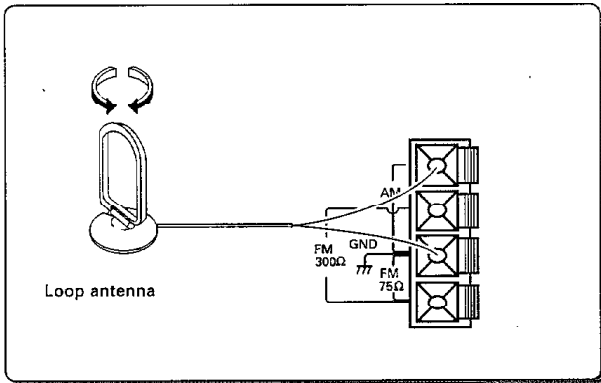
**AM outdoor antenna connection**

If the reception is poor when the AM loop antenna is used, distribute a vinyl-coated wire of more than 6 meters outdoors, without disconnecting the loop antenna.

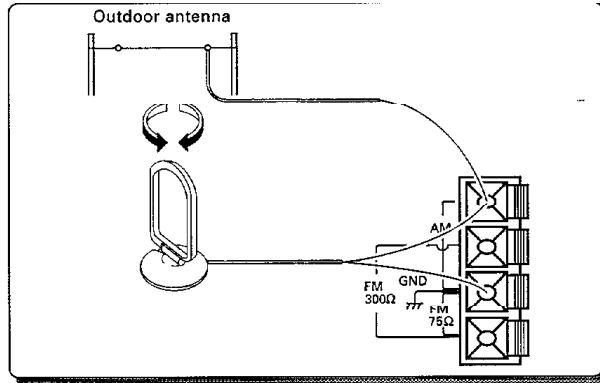

## Connection of FM antenna

**FM indoor antenna connection**

The supplied antenna is for indoor use. For stable reception, remove the indoor antenna after installing an outdoor antenna as soon as possible.

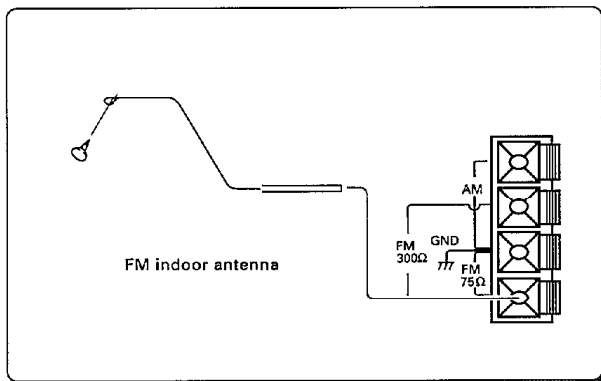
**Connection of FM outdoor antenna**

Lead the 75Ω coaxial cable connected to the FM outdoor antenna into the room and connect it to the FM 75Ω terminal.

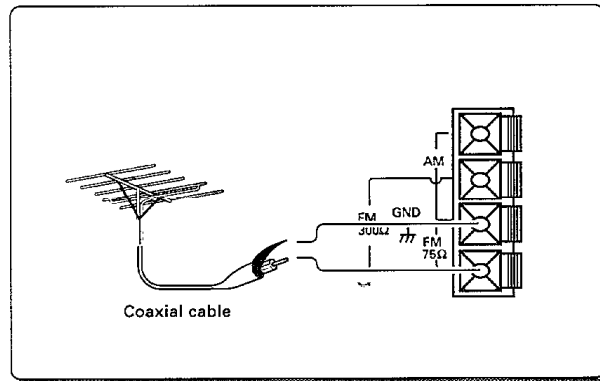

# Controls and indicators

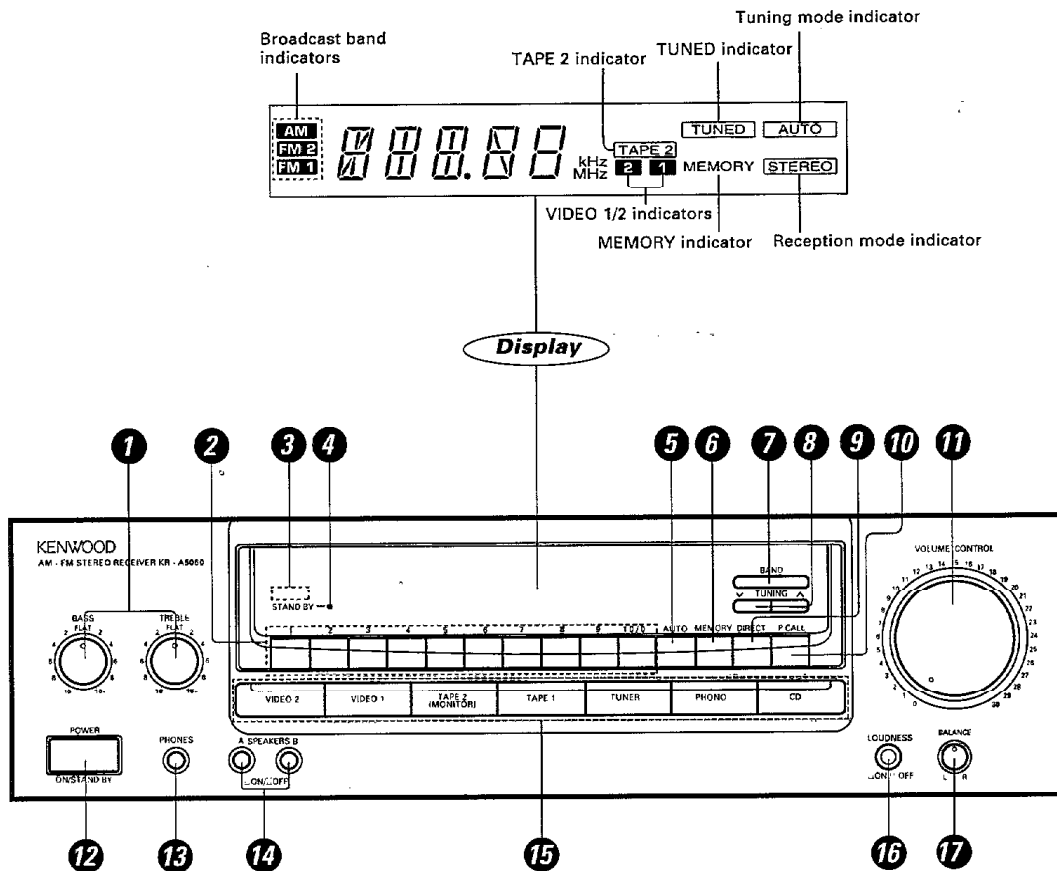

- 1** TONE control knobs
- 2** Numeric keys
- 3** Remote control sensor
- 4** STAND BY indicator
- 5** AUTO key  
Press to select the auto tuning mode.
- 6** MEMORY key  
Press to preset a station in the memory.
- 7** BAND key  
Press to switch the broadcast band.
- 8** TUNING key  
Press to tune broadcast stations
- 9** DIRECT key  
Press for direct station tuning based on numerical input.

- 10** P.CALL key  
Press to recall a preset station.
- 11** VOLUME CONTROL knob
- 12** POWER key
- 13** PHONES jack  
Used for headphone listening.
- 14** SPEAKERS A/B switches  
Press to select the A and/or D speaker systems.
- 15** INPUT SELECTOR keys  
Turn to select the input sources.
- 16** LOUDNESS switch  
Press to enhance low frequencies.
- 17** BALANCE control knob  
Turn to adjust the volume balance between left and right.

## STANDY BY mode of POWER switch

When the power cord of this system is plugged into an AC outlet, the STAND BY indicator lights up regardless of the ON/OFF setting of the POWER switch. This indicates that a small amount of current is being supplied to the unit to back up the memory contents. This mode is referred to as the Stand By mode. While the STAND BY indicator is lit, the power of the system can be switched ON/OFF from the remote control unit.

## Remote control unit

The remote control unit provided with the receiver can also control KENWOOD cassette decks, and CD player connected to the receiver through system control cords. For details of the controllable functions, refer to the instruction manuals of these components.

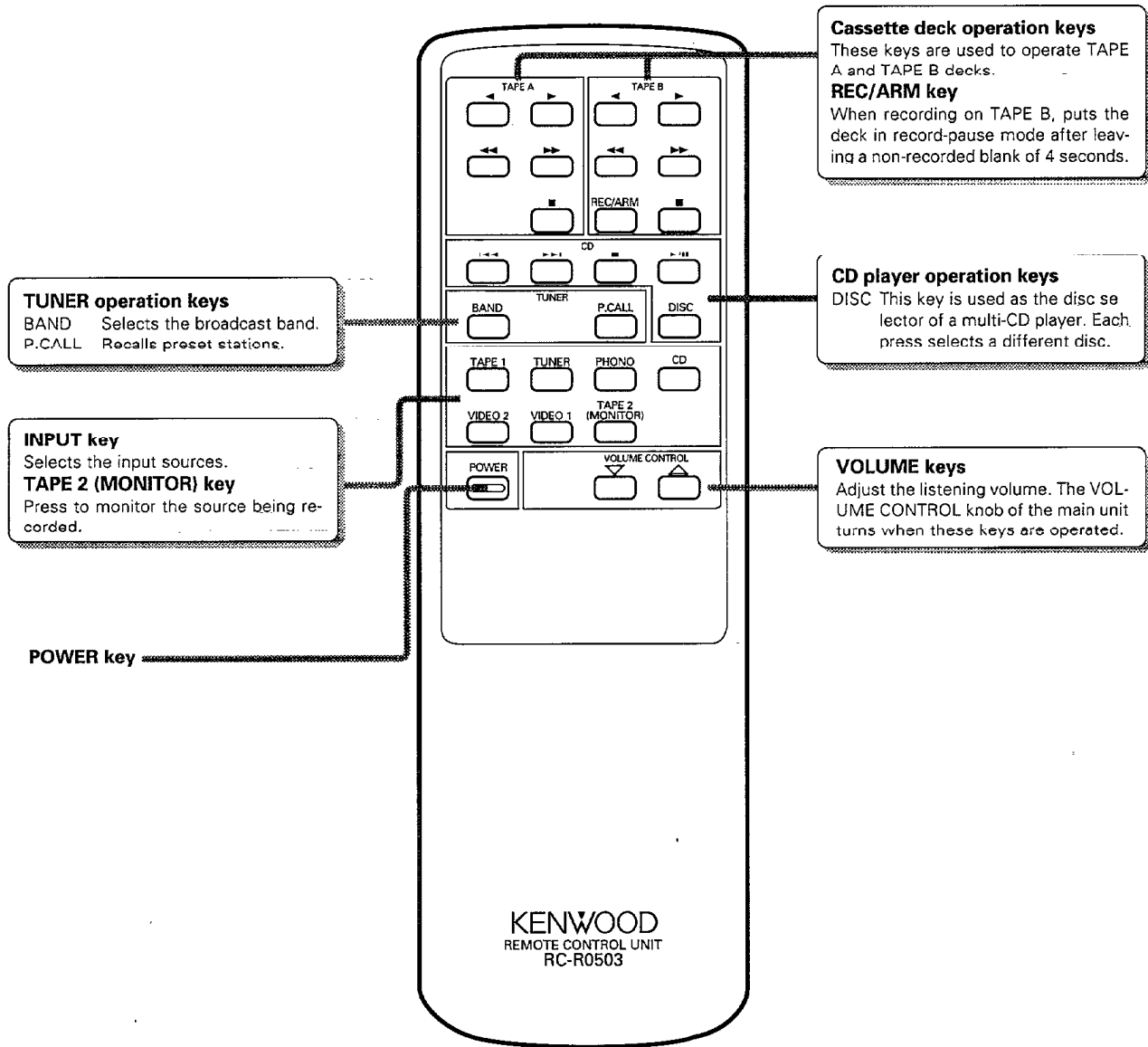

Model: RC-R0503  
Infrared ray system

# Operation of remote control unit

## Loading batteries



**1** Remove the cover.

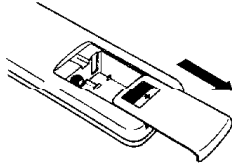

**2** Insert batteries.

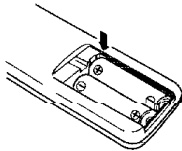

**3** Close the cover.

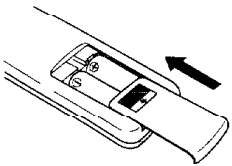

- Insert two AA-size (R6 / SUM-3) batteries as indicated by the polarity marking.

## Operation procedure

Plug the power cord of the system into an AC wall outlet, and press the **POWER** key on the remote control unit to turn the power on.

When the power is turned on, press the key of the source component to be operated.

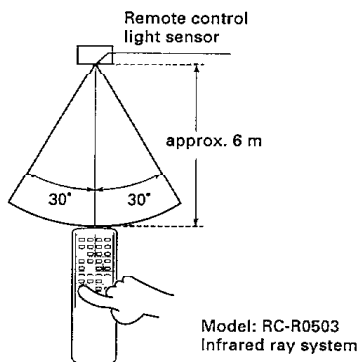

- Components connected via the system control cords, such as the CD player, can also be remote-controlled. In this case, please read the instruction manual supplied with your components.
- When two operation keys on the remote control unit are pressed successively, press each key securely reserving an interval of more than 1 second for each press.

### Notes



1. The supplied batteries are intended for use in operation checks. Therefore, their lives may be shorter than ordinary batteries.
2. When the remote-controllable distance gets shorter than before, replace both batteries with new ones.
3. Malfunction may occur if direct sunlight or the light of a high-frequency lighting fluorescent lamp enters the remote control light sensor. In such a case, change the system installation position to prevent the malfunction.

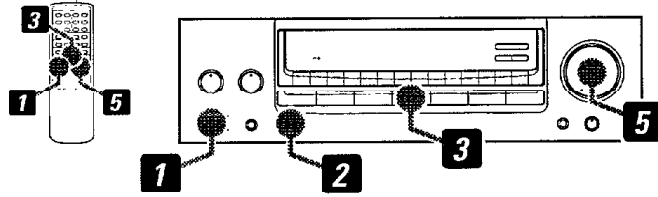

## 1 Turn the power ON.



## 2 Select the SPEAKERS switch setting.



## 3 Select the input source.

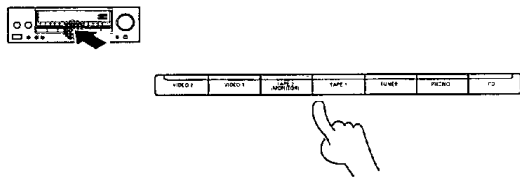

## 4 Play the selected source.

## 5 Adjust the volume.

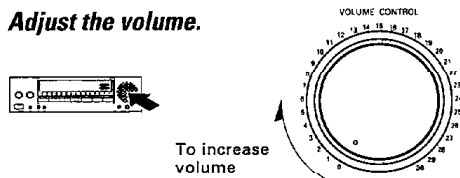

### A, B OFF

Sound is not output from the speakers. Use this setting for listening through headphones, etc.

### A ON

Sound is output from the speakers connected to the SPEAKERS A terminals on the rear panel.

### B ON

Sound is output from the speakers connected to the SPEAKERS B terminals on the rear panel.

### A, B ON

Sound is output from the speakers connected to the SPEAKERS A and B terminals on the rear panel.

- If the cassette deck(s), CD player and/or turntable is connected through system control cords, the component of the selected input source starts to play automatically.

The selected source is displayed.

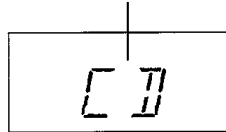

- The selected input source is held in memory for about 3 days even after the power cord is unplugged from the mains outlet.

- The sound of input source cannot be listened to while TAPE 2 is ON.
- When the volume is adjusted from the remote control unit, the VOLUME CONTROL knob rotates.

# Sound adjustment functions



## Adjusting the tone

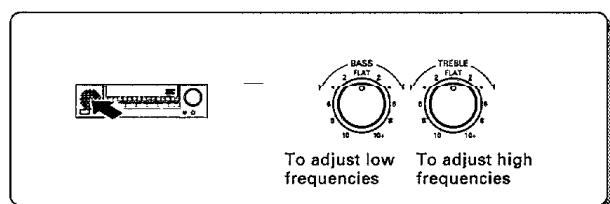

## Adjusting the left/right sound balance

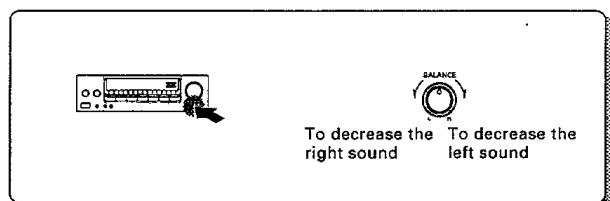

## Using the LOUDNESS switch

When listening at a low volume, the loudness function allows to compensate the low frequencies which human ears have difficulty in hearing at a low volume.

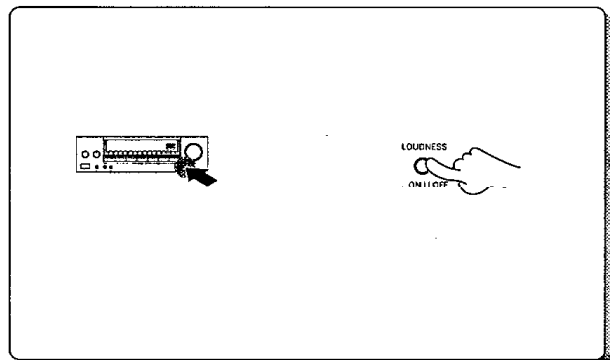

**To cancel the loudness function**  
Press the switch again.



**To listen through headphones**

① Set both of the **SPEAKERS** switches to **OFF**.



② Plug headphones.



③ Adjust the volume.



To increase volume

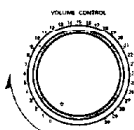

Main unit





# Recording

## To record a music source

① Select the source to be recorded.

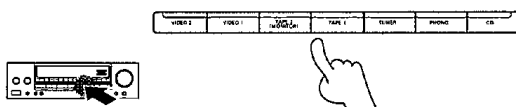



Select an input source other than TAPE 1.

② Put the cassette deck in record-pause mode.

③ Play the source and start recording.

## Copying tape (Tape dubbing TAPE 2 → TAPE 1)

① Press the TAPE 2 key.

② Select a source other than TAPE 1.



③ Play cassette deck 2 and start recording on cassette deck 1.

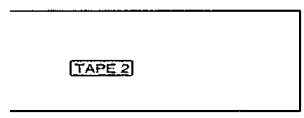

- For copying a tape using a double cassette deck, read the instruction manual of the double cassette deck.

## Copying tape (Tape dubbing TAPE 1 → TAPE 2)

Play the cassette deck connected to the TAPE 1 jacks and start recording of the cassette deck connected to the TAPE 2 jacks.

## Synchro recording

By connecting this unit to a CD player or turntable manufactured by KENWOOD through a system control cord, the CD or analog disc sound can be recorded with a simple operation on the cassette deck(s). Select the music source to be recorded with the INPUT SELECTOR and put the cassette deck in record-pause mode. With this condition, press the play key of the CD player or turntable to start recording at the same time as the source component starts to play.

# Broadcast reception

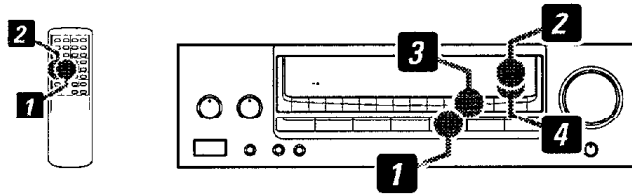

## Receiving broadcast station

### 1 Select the TUNER input.



Frequency display

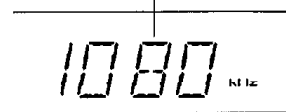

- The last frequency tuned before is displayed.

### 2 Select the broadcast band.



Each press switches the band as follows:

- ① FM 1
- ② FM 2
- ③ AM

AM or FM indicator

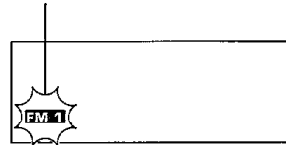

### 3 Select the tuning method.



Each press switches the tuning method as follows:

- ① AUTO lit (auto tuning)
- ② AUTO not lit (manual tuning)



- Usually, set the switch to AUTO (auto tuning).

Select manual tuning when noise interferes due to weak radio wave. (The stereo broadcasting is received in monaural during manual tuning.)

### 4 Select a station.

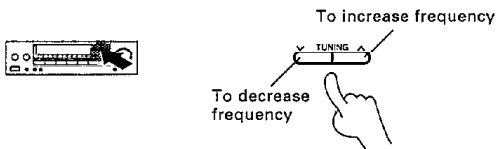

Frequency display

"TUNED" lights up when a station is turned.

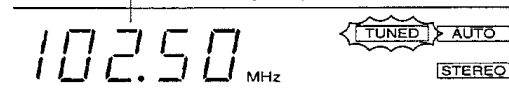

Auto tuning: The next station found is tuned automatically.  
Manual tuning: Press repeatedly or hold until a station is tuned.

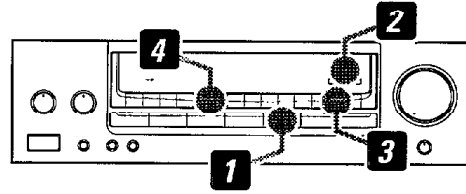
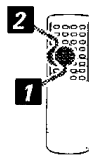

## Receiving radio station by specifying its frequency

### 1 Select the TUNER input.

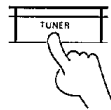
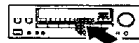

Frequency display

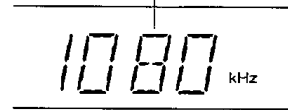

### 2 Select the broadcast band.

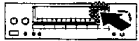

Each press switches the band as follows:

- (1) FM 1
- (2) FM 2
- (3) AM

AM or FM indicator

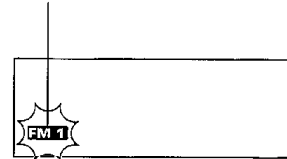

### 3 Specify the frequency.

Press the DIRECT key.

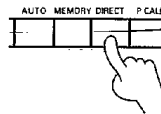

Press the numeric keys according to the frequency to be tuned as shown below.

For U.S.A and Mexico models.  
 AM 810 kHz ..... 8, 1  
 AM 1260 kHz ..... 1, 2, 6  
 FM 90 MHz ..... 9, 0, 0  
 FM 102.5 MHz ..... 1, 0, 2, 5

For Australia models.  
 AM 810 kHz ..... 8, 1, 0  
 AM 1260 kHz ..... 1, 2, 6, 0  
 FM 90 MHz ..... 9, 0, 0, 0  
 FM 102.5 MHz ..... 1, 0, 2, 5, 0

### 4

Enter the frequency of the desired station.

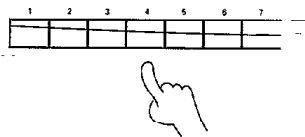

Frequency display

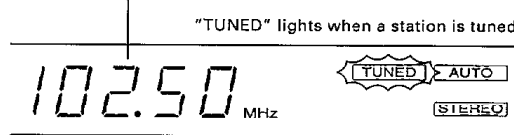

● If you commit a mistake, repeat step 3 again.

**Preparation**



- Tune the station to be stored in memory.

## Storing radio stations in memory (Station preset)

**1 Press the MEMORY key during receiving a station.**

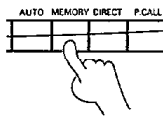

Lights up (for 5 sec.)

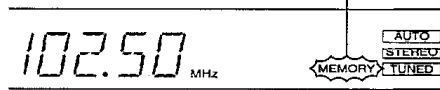

**Proceed to step 2 within 5 sec.** (If more than 5 sec. have elapsed, press the MEMORY key again.)

**2 Select one of the preset numbers from 1 to 10.**

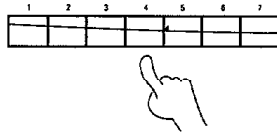

- Up to 10 stations can be preset for each broadcast band.
- Repeat steps 1 and 2 for each of the stations to be stored in memory.
- If a station is stored in a preset number which already stores a station memory under it, the previous memory is replaced by the new memory content.
- Once the memory content has been preset, it is held for about 3 days even after the power cord is unplugged from the mains outlet.

## Receiving a preset station

**Press the preset number of the desired station.**

① Select the broadcast band.

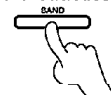

②

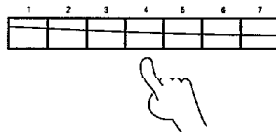

Each press switches the band as follows:

- ① FM 1
- ② FM 2
- ③ AM

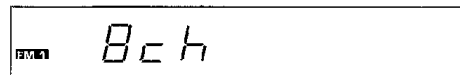

## Receiving all preset stations in order

① Select the broadcast band.

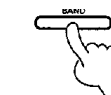

② Press the P.CALL key.

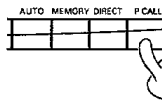

Each press switches the band as follows:

- ① FM 1
- ② FM 2
- ③ AM

- Preset stations are received in the following order.  
In FM band: (FM 1) 1→2...9→10→(FM 2)1→2...9→10→(FM 1)1...  
In AM band: (AM) 1→2...9→10→1→2...
- To stop preset call operation, press the **P.CALL** key again. The preset station receives when the key is pressed will continue to be received.

# ***In case of difficulty***

## **Remote control unit**

Symptom	Cause	Remedy
Remote control operation is not possible.	<ul style="list-style-type: none"> <li>● Batteries are exhausted.</li> <li>● The audio cords and system control cords are not connected properly.</li> <li>● The remote control unit is too far away from the main system, controlling angle is too large, or there is an obstacle in between.</li> <li>● The source component to be operated does not contain the tape(s) or CD.</li> <li>● An attempt is made to play a tape which is being recorded in the cassette deck.</li> </ul>	<ul style="list-style-type: none"> <li>● Replace with new batteries. → P. 13</li> <li>● Connect properly referring to "System connection". → P. 6</li> <li>● Operate the remote control unit within the controllable range.</li> <li>● Place the tape(s) or CD in the source component to be played.</li> <li>● Wait until the recording is completed.</li> </ul>

## **Amplifier**

Symptom	Cause	Remedy
Sound is not output.	<ul style="list-style-type: none"> <li>● The speaker cords are disconnected.</li> <li>● The VOLUME is set to the minimum position.</li> <li>● The SPEAKERS switches are set to OFF.</li> <li>● The TAPE 2 key is set to ON.</li> </ul>	<ul style="list-style-type: none"> <li>● Connect them properly referring to "System connection".</li> <li>● Adjust the volume to a proper level.</li> <li>● Set the SPEAKERS switch(es) to ON.</li> <li>● Set the TAPE 2 key to OFF.</li> </ul>
Sound is not output from one of the speakers.	<ul style="list-style-type: none"> <li>● The speaker cord is disconnected.</li> <li>● The BALANCE control is set to an extreme position.</li> </ul>	<ul style="list-style-type: none"> <li>● Connect it properly referring "System connection".</li> <li>● Adjust the Left/Right balance.</li> </ul>
A hum noise is generated when PHONO input selector key is pressed.	<ul style="list-style-type: none"> <li>● The audio cord from the turntable is not inserted securely into the PHONO jacks.</li> <li>● The turntable is not grounded.</li> </ul>	<ul style="list-style-type: none"> <li>● Insert the audio cord plugs securely into the PHONO jacks.</li> <li>● Connect the grounding wire to the GND terminal on the rear panel.</li> </ul>

## **Tuner**

Symptom	Cause	Remedy
Radio stations cannot be received.	<ul style="list-style-type: none"> <li>● No antenna is connected.</li> <li>● The broadcast band is not set properly.</li> <li>● The frequency of the desired station is not tuned</li> </ul>	<ul style="list-style-type: none"> <li>● Connect an antenna.</li> <li>● Set the broadcast band properly.</li> <li>● Tune the frequency of the desired station. → P. 18</li> </ul>
Interference.	<ul style="list-style-type: none"> <li>● Noise due to ignition noise of an automobile.</li> <li>● Noise due to an influence from an electric appliance.</li> <li>● Noise due to a nearby TV set.</li> </ul>	<ul style="list-style-type: none"> <li>● Install the outdoor antenna apart from the road.</li> <li>● Turn off the power of the appliance.</li> <li>● Install the system more apart from the TV set.</li> </ul>
A station which was preset cannot be received by pressing the corresponding numeric key.	<ul style="list-style-type: none"> <li>● The preset station belongs to a frequency that cannot be received.</li> <li>● The preset memory was cleared because the power cord had been unplugged for a long period of time.</li> </ul>	<ul style="list-style-type: none"> <li>● Preset a station with a receivable frequency.</li> <li>● Preset the station again.</li> </ul>

### **Speaker protection circuitry**

If the speaker cords are short-circuited, the speaker protection circuitry is activated and the sound is muted. If this occurs, switch the POWER key to OFF, remove the short-circuit from the speaker cords, and switch the POWER key to ON again. Normal operation will resume.

### **Notes**



1. This system is microprocessor-controlled, so malfunction may occur due to external noise or interference noise. In such a case, unplug the power cord, plug it and turn power on again.
2. Do not use contact cleaners because it could cause a malfunction. Be specially careful against contact cleaners containing oil, for they may deform the plastic components.

## KR-A5060

### Audio section

#### Rated power output at the STEREO operation

100 watts per channel minimum RMS, both channels driven at 8  $\Omega$ , from 20 Hz to 20,000 Hz with no more than 0.09% total harmonic distortions. (FTC)

Total harmonic distortion (1 kHz, 8 $\Omega$ )	.....0.03% at 50 W
Signal to noise ratio (IHF A)	
PHONO (MM)	..... 73 dB
CD, TAPE, VIDEO	..... 100 dB
Input sensitivity / impedance	
PHONO (MM)	..... 2.5 mV / 47 k $\Omega$
CD, TAPE, VIDEO	..... 200 mV / 47 k $\Omega$
Tone controls	
BASS	..... $\pm 10$ dB (at 100 Hz)
TREBLE	..... $\pm 10$ dB (at 10 kHz)
Loudness control at - 30 dB level	..... + 8 dB (100 Hz)

### FM Tuner section

Tuning frequency range	..... 87.5 MHz~108 MHz
Usable sensitivity (IHF)	..... 13.2 dBf (1.2 $\mu$ V at 75 $\Omega$ )
50 dB quieting sensitivity	
STEREO	..... 41.2 dBf (32 $\mu$ V at 75 $\Omega$ )
Total harmonic distortion at 1 kHz	
MONO	..... 0.6%
STEREO	..... 0.7%
Signal to noise ratio at 65 dBf (IHF)	
MONO	..... 75 dB
STEREO	..... 68 dB
Selectivity (IHF $\pm 400$ kHz)	..... 50 dB
Stereo separation (IHF at 1 kHz)	..... 40 dB
Frequency response	..... 30 Hz~15 kHz, +0.5 dB, - 3.0 dB

### AM Tuner section

Tuning frequency range	..... 530 kHz~1,700 kHz
Usable sensitivity	..... 12 $\mu$ V / (500 $\mu$ V / m)
Total harmonic distortion	..... 0.7 %
Signal to noise ratio	..... 48 dB
Selectivity	..... 30 dB

### General

Power consumption	..... 3 A
AC outlet	
SWITCHED	..... 2: (total 150 W, 1.2 A max.)
Dimensions	..... W: 440 mm (17-5/16")
	..... H: 133 mm (5-1/4")
	..... D: 379 mm (14-15/16")
Weight (net)	..... 8.8 kg (19.4 lb)

## KR-A4060

### Audio section

#### Rated power output at the STEREO operation

80 watts per channel minimum RMS, both channels driven at 8  $\Omega$ , from 20 Hz to 20,000 Hz with no more than 0.09% total harmonic distortions. (FTC)

Total harmonic distortion (1 kHz, 8 $\Omega$ )	.....0.03% at 40 W
Signal to noise ratio (IHF A)	
PHONO (MM)	..... 70 dB
CD, TAPE, VIDEO	..... 100 dB
Input sensitivity / impedance	
PHONO (MM)	..... 2.5 mV / 47 k $\Omega$
CD, TAPE, VIDEO	..... 200 mV / 47 k $\Omega$
Tone controls	
BASS	..... $\pm 10$ dB (at 100 Hz)
TREBLE	..... $\pm 10$ dB (at 10 kHz)
Loudness control at - 30 dB level	..... + 8 dB (100 Hz)

### FM Tuner section

Tuning frequency range	..... 87.5 MHz~108 MHz
Usable sensitivity (IHF)	..... 13.2 dBf (1.2 $\mu$ V at 75 $\Omega$ )
50 dB quieting sensitivity	
STEREO	..... 41.2 dBf (32 $\mu$ V at 75 $\Omega$ )
Total harmonic distortion at 1 kHz	
MONO	..... 0.6%
STEREO	..... 0.7%
Signal to noise ratio at 65 dBf (IHF)	
MONO	..... 75 dB
STEREO	..... 68 dB
Selectivity (IHF $\pm 400$ kHz)	..... 50 dB
Stereo separation (IHF at 1 kHz)	..... 40 dB
Frequency response	..... 30 Hz~15 kHz, +0.5 dB, - 3.0 dB

### AM Tuner section

Tuning frequency range	..... 530 kHz~1,700 kHz
Usable sensitivity	..... 12 $\mu$ V / (500 $\mu$ V / m)
Total harmonic distortion	..... 0.7 %
Signal to noise ratio	..... 48 dB
Selectivity	..... 30 dB

### General

Power consumption	..... 2.2 A
AC outlet	
SWITCHED	..... 2: (total 150 W, 1.2 A max.)
Dimensions	..... W: 440 mm (17-5/16")
	..... H: 133 mm (5-1/4")
	..... D: 329 mm (12-15/16")
Weight (net)	..... 8.1 kg (17.9 lb)

Note



KENWOOD follows a policy of continuous advancements in development. For this reason specifications may be changed without notice.

## KR-A5060

### Audio section

Rated power output  
(EIAJ) 1 kHz, 10 % THD at 8 Ω ..... 130 W + 130 W  
(IHF '66) from 20 Hz to 20 kHz,  
0.09% T.H.D., at 8 Ω ..... 100 W + 100 W  
Total harmonic distortion (1 kHz, 8 Ω) 0.03% at 50 W  
Signal to noise ratio (IHF'66)  
PHONO (MM) ..... 73 dB  
CD, TAPE, VIDEO ..... 100 dB  
Input sensitivity / impedance  
PHONO (MM) ..... 2.5 mV / 47 kΩ  
CD, TAPE, VIDEO ..... 200 mV / 47kΩ  
Tone controls  
BASS ..... ±10 dB (at 100 Hz)  
TREBLE ..... ±10 dB (at 10 kHz)  
Loudness control at - 30 dB level ..... + 8 dB (100 Hz)

### FM Tuner section

Tuning frequency range ..... 87.5 MHz~108 MHz  
Usable sensitivity (IIF) ..... 13.2 dBf (1.2 μV at 75 Ω)  
50 dB quieting sensitivity  
STEREO ..... 41.2 dBf (32 μV at 75 Ω)  
Total harmonic distortion at 1 kHz  
MONO ..... 0.6 %  
STEREO ..... 0.7 %  
Signal to noise ratio at 65 dBf (IHF)  
MONO ..... 75 dB  
STEREO ..... 68 dB  
Selectivity (IHF ± 400 kHz) ..... 50 dB  
Stereo separation (IHF at 1 kHz) ..... 40 dB  
Frequency response ..... 30 Hz ~ 15 kHz, + 0.5 dB, - 3.0 dB

### AM Tuner section

Tuning frequency range ..... 531 kHz ~ 1,602 kHz  
Usable sensitivity ..... 12 μV / (500 μV / m)  
Total harmonic distortion ..... 0.7 %  
Signal to noise ratio ..... 48 dB  
Selectivity ..... 30 dB

### General

Power consumption ..... 230 W  
Dimensions ..... W: 440 mm  
H: 133 mm  
D: 379 mm  
Weight (net) ..... 8.8 kg

## KR-A4060

### Audio section

Rated power output  
(EIAJ) 1 kHz, 10 % THD at 8 Ω ..... 95 W + 95 W  
(IHF '66) from 20 Hz to 20 kHz,  
0.09% T.H.D., at 8 Ω ..... 85 W + 85 W  
Total harmonic distortion (1 kHz, 8 Ω) 0.03% at 40 W  
Signal to noise ratio (IHF'66)  
PHONO (MM) ..... 70 dB  
CD, TAPE, VIDEO ..... 100 dB  
Input sensitivity / impedance  
PHONO (MM) ..... 2.5 mV / 47 kΩ  
CD, TAPE, VIDEO ..... 200 mV / 47kΩ  
Tone controls  
BASS ..... ±10 dB (at 100 Hz)  
TREBLE ..... ±10 dB (at 10 kHz)  
Loudness control at - 30 dB level ..... + 8 dB (100 Hz)

### FM Tuner section

Tuning frequency range ..... 87.5 MHz~108 MHz  
Usable sensitivity (IHF) ..... 13.2 dBf (1.2 μV at 75 Ω)  
50 dB quieting sensitivity  
STEREO ..... 41.2 dBf (32 μV at 75 Ω)  
Total harmonic distortion at 1 kHz  
MONO ..... 0.6 %  
STEREO ..... 0.7 %  
Signal to noise ratio at 65 dBf (IHF)  
MONO ..... 75 dB  
STEREO ..... 68 dB  
Selectivity (IHF ± 400 kHz) ..... 50 dB  
Stereo separation (IHF at 1 kHz) ..... 40 dB  
Frequency response ..... 30 Hz ~ 15 kHz, + 0.5 dB, - 3.0 dB

### AM Tuner section

Tuning frequency range ..... 531 kHz ~ 1,602 kHz  
Usable sensitivity ..... 12 μV / (500 μV / m)  
Total harmonic distortion ..... 0.7 %  
Signal to noise ratio ..... 48 dB  
Selectivity ..... 30 dB

### General

Power consumption ..... 190 W  
AC outlet  
SWITCHED ..... 1: (200 W max.)  
Dimensions ..... W: 440 mm  
H: 133 mm  
D: 329 mm  
Weight (net) ..... 8.1 kg

#### Note



KENWOOD follows a policy of continuous advancements in development. For this reason specifications may be changed without notice.

KENWOOD



## Free Manuals Download Website

<http://myh66.com>

<http://usermanuals.us>

<http://www.somanuals.com>

<http://www.4manuals.cc>

<http://www.manual-lib.com>

<http://www.404manual.com>

<http://www.luxmanual.com>

<http://aubethermostatmanual.com>

Golf course search by state

<http://golfingnear.com>

Email search by domain

<http://emailbydomain.com>

Auto manuals search

<http://auto.somanuals.com>

TV manuals search

<http://tv.somanuals.com>