

# KENWOOD

**KRC-409**

**KRC-309S**

CASSETTE RECEIVER

## **INSTRUCTION MANUAL**

AMPLI-TUNER-LECTEUR DE CASSETTE

## **MODE D'EMPLOI**

RADIO CASSETE

## **MANUAL DE INSTRUCCIONES**

RADIO CASSETE

## **MANUAL DE INSTRUÇÕES**

KENWOOD CORPORATION

**Take the time to read through this instruction manual.**

**Familiarity with installation and operation procedures will help you obtain the best performance from your new cassette-receiver.**

### **For your records**

Record the serial number, found on the back of the unit, in the spaces designated on the warranty card, and in the space provided below. Refer to the model and serial numbers whenever you call upon your KENWOOD dealer for information or service on the product.

Model KRC-409/309S Serial number \_\_\_\_\_

## Contents

### **Safety precautions.....3**

#### **General features**

Power.....	5
Volume.....	5
Switching Modes.....	6
Attenuator.....	6
Loudness.....	6
System Q.....	6
Audio Control Setting.....	7
Mobile Preset.....	8
Clock display.....	8
Adjusting Time.....	8
Disabled System Indicator (DSI).....	8
Theft Deterrent Faceplate.....	8

#### **Tuner features**

Tuning.....	10
Station Preset Memory.....	10
Auto Memory Entry.....	10
Clean Reception System Circuit (CRSC).....	11

#### **Cassette player features**

Playing Cassette Tapes.....	12
Fast Forwarding and Rewinding Cassette Tapes.....	12
Using Dolby B Noise Reduction.....	12
Switching Tape Types.....	12
Blank Skip.....	12
Tape Advance.....	13
Music Repeat.....	13

#### **External disc control features**

Playing Disc mode.....	14
Fast Forwarding and Reversing Disc Play.....	14
Track Search.....	14
Disc Search.....	14
Track / Disc Repeat.....	15
Track Scan.....	15
Random Play.....	15
Magazine Random Play.....	16

### **Installation**

Accessories.....	17
Installation Procedure.....	17
Connecting Wires to Terminals.....	18
Installation.....	19

### **Troubleshooting Guide .....22**

### **Specifications .....26**

## ***Safety precautions***

### **▲WARNING**

#### ***To prevent injury or fire, take the following precautions:***

- Insert the unit all the way in until it is fully locked in place. Otherwise it may fall out of place when jolted.
- When extending the ignition, battery, or ground wires, make sure to use automotive-grade wires or other wires with a 0.75mm<sup>2</sup> (AWG18) or more to prevent wire deterioration and damage to the wire coating.
- To prevent a short circuit, never put or leave any metallic objects (such as coins or metal tools) inside the unit.
- If the unit starts to emit smoke or strange smells, turn off the power immediately and consult your Kenwood dealer.
- Make sure not to get your fingers caught between the faceplate and the unit.
- Be careful not to drop the unit or subject it to strong shock.  
The unit may break or crack because it contains glass parts.
- Do not touch the liquid crystal fluid if the LCD is damaged or broken due to shock. The liquid crystal fluid may be dangerous to your health or even fatal.  
If the liquid crystal fluid from the LCD contacts your body or clothing, wash it off with soap immediately.

### **▲CAUTION**

#### ***To prevent damage to the machine, take the following precautions:***

- Make sure to ground the unit to a negative 12V DC power supply.
- Do not open the top or bottom covers of the unit.
- Do not install the unit in a spot exposed to direct sunlight or excessive heat or humidity. Also avoid places with too much dust or the possibility of water splashing.
- Do not set the removed faceplate or the faceplate case in areas exposed to direct sunlight, excessive heat or humidity. Also avoid places with too much dust or the possibility of water splashing.
- To prevent deterioration, do not touch the terminals of the unit or faceplate with your fingers.
- Do not subject the faceplate to excessive shock, as it is a piece of precision equipment.
- When replacing a fuse, only use a new one with the prescribed rating. Using a fuse with the wrong rating may cause your unit to malfunction.
- To prevent a short circuit when replacing a fuse, first disconnect the wiring harness.
- Do not place any object between the faceplate and the unit.
- Do not use your own screws. Use only the screws provided. If you use the wrong screws, you could damage the unit.

### **IMPORTANT INFORMATION**

#### ***About the disc changer to be connected:***

To connect a disc changer having the "O-N" switch to this unit, set the "O-N" switch to "N".

To connect a disc changer having no "O-N" switch to this unit, the converter cord CA-DS100 and/or switching adapter KCA-S210A are required as options.

If a model with no "O-N" switch is connected, some unavailable functions and information that cannot be displayed are generated, such as the DNPS, DNPP, Magazine random play, and CD Text display. Note that none of the KDC-C100, KDC-C302, C205, C705, and non-Kenwood CD changers can be connected.

### **▲CAUTION**

***You can damage both your unit and the CD changer if you connect them incorrectly.***

*Manufactured under license from Dolby Laboratories.  
"Dolby" and the double-D symbol are trademarks of Dolby Laboratories.*

## Safety precautions

### NOTE

- If you experience problems during installation, consult your Kenwood dealer.
- If the unit does not seem to be working right, try pressing the reset button first. If that does not solve the problem, consult your Kenwood dealer.

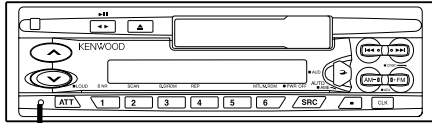

Reset button

- Characters in the LCD may become difficult to read in temperatures below 41 °F (5 °C).
- The illustrations of the display and the panel appearing in this manual are examples used to explain more clearly how the controls are used. Therefore, what appears on the display in the illustrations may differ from what appears on the display on the actual equipment, and some of the illustrations on the display may represent something impossible in actual operation.
- The functions that can be used and the information that can be displayed will differ depending on the external disc players being connected.

### Cleaning the Faceplate Terminals

If the terminals on the unit or faceplate get dirty, wipe them with a dry, soft cloth.

### Cleaning the Unit

If the faceplate of this unit is stained, wipe it with a dry soft cloth such as a silicon cloth. If the faceplate is stained badly, wipe the stain off with a cloth moistened with neutral cleaner, then wipe neutral detergent off.

### CAUTION

Applying spray cleaner directly to the unit may affect its mechanical parts. Wiping the faceplate with a hard cloth or using a volatile liquid such as thinner or alcohol may scratch the surface or erases characters.

### FCC WARNING

This equipment may generate or use radio frequency energy. Changes or modifications to this equipment may cause harmful interference unless the modifications are expressly approved in the instruction manual. The user could lose the authority to operate this equipment if an unauthorized change or modification is made.

### Cleaning the Tape Head

After you have listened to many cassettes over a long period of time, magnetic powder from the tapes and dust accumulates on the tape head, causing noise and a deterioration in sound quality. Clean the tape head using a cleaning tape or cleaning kit designed for use in car audio systems.

### Handling Cassette Tapes

- Do not play a cassette whose tape has gone slack. In such a case, wind it tight using a pencil or the like in one of the spools. Playing slack cassette tapes can result in the tape tangling around the capstan and/or pinch rollers, causing trouble.
- Do not play a deformed cassette or one whose label is starting to come off, as it can cause the unit to malfunction.
- Do not leave tapes in hot places, such as on dashboards and other spots exposed to direct sunlight, or near heater outlets. They can deform the cassette.
- Avoid using extremely long cassette tapes, such as 100-minute-long tapes. Such tapes are very thin, and can tangle easily around the pinch rollers or other parts inside the unit, causing unit failure.
- Remove a cassette tape from the unit when not listening to it for a while. If you leave a tape in the unit too long, it may stick to the tape head and cause unit malfunction.

## General features

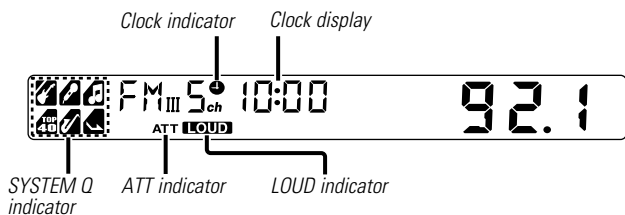
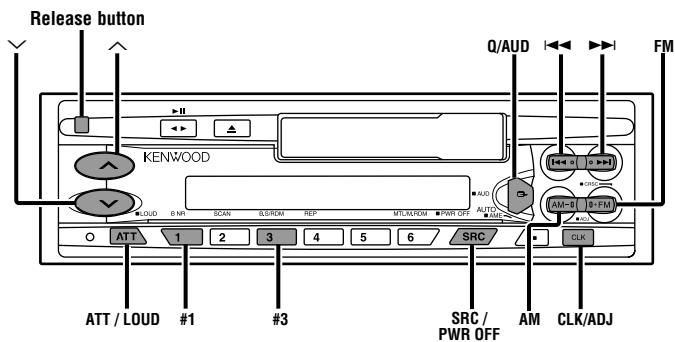

## Power

### Turning on the power:

Press the SRC (source) button.

### NOTE

Turn the power on before carrying out the following procedures.

### Turning off the power:

Press the PWR OFF button for at least one second.

## Volume

### Increasing Volume:

Press the  $\wedge$  button to turn up the volume.

### Decreasing Volume:

Press the  $\vee$  button to turn down the volume.

## General features

### Switching Modes

#### Switching Modes:

Each time you press the SRC (source) button, the mode switches as follows:

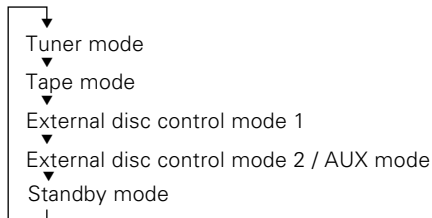

#### Selecting standby mode:

Press the SRC button repeatedly and switch to "OFF" . When "OFF" is displayed, the standby mode is activated. The standby mode turns all functions off while leaving the power to the unit on. Use this mode when you want to have the display illuminated but don't want to listen to anything.

#### NOTE

- The mode switches to the next mode from any mode which cannot be used.
- The external disc control mode will differ depending on the unit that is connected.
- To enable the selection of External disc control mode 2/AUX mode, you should connect optional switching adapter KCA-S210A (which allows you to select both External disc control mode 2 and AUX mode) or CD changer (KDC-CPS87, KDC-CX87, KDC-CPS85, KDC-CX85, KDC-CPS82 or KDC-CX82) or switching adapter CA-C1AX (which allows you to select AUX mode only).  
During the AUX mode, "AVin" will show in the display. When the CA-C1AX is being used, the AUX Mode will replace the External Disc Control Mode.

### Attenuator

This function allows you to turn down the volume quickly.

#### Turning Attenuator On/Off:

Press the ATT button to switch the attenuator on and off. When the attenuator is on, the ATT indicator blinks. When the attenuator is off, the volume returns to the original level.

#### NOTE

Turning the volume up, or turning it all the way down deactivates the attenuator function.

### Loudness

This function amplifies low and high tones when the volume is turned down.

The LOUD indicator lights up when the loudness function is on.

#### Turning Loudness On/Off:

Press the LOUD button for at least one second to switch the loudness on and off.

### System Q

You can recall the best audio setting preset for different types of the music.

#### Switching the Preset Sound Setting:

Each time you press the Q button, the preset sound setting switches as follows:

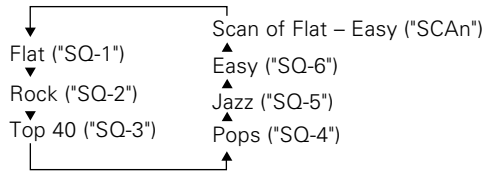

As you proceed, each indicator would go on.

**NOTE**

The System Q function changes the values of the following sound quality parameters:

Bass center frequency, bass level, bass quality factor, bass extend, middle center frequency, middle level, middle quality factor, treble center frequency, and treble level.

Note that some of these parameters cannot be controlled by the audio control setting feature.

Their setting values are different depending on the setting of the mobile preset plan mode.

### Audio Control Setting

Adjust various parameters of sound quality.

**1** Press the AUD button for at least one second to enter the control mode.

**2 Selecting mode**

Press either the FM or AM button.

Each time the button is pressed, the adjustment mode will change as follows:

Pressing the FM button advances the display, and pressing the AM button reverses it.

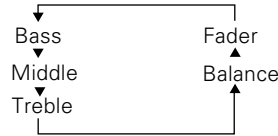

**NOTE** Source tone memory

Each source (tape, CD, MD, FM, AM and disc changer) has its own memory in which to store the bass, middle, and treble tone settings.

The settings made for a particular source are recalled automatically whenever you use that source (for example, FM mode uses the tone settings made for FM, AM for AM, etc.).

**3 Adjust each mode**

Press the ◀◀/▶▶ button.

Look at the table to adjust the mode being displayed.

Adjustment mode (Display)	Operation of Audio control button	
	◀◀ button	▶▶ button
Bass ("BAS")	Bass decreased.	Bass increased.
Middle("MID")	Middle decreased.	Middle increased.
Treble("TRE")	Treble decreased.	Treble increased.
Balance("BL")	Left channel emphasized.	Right channel emphasized.
Fader ("FD")	Rear channel increased.	Front channel increased.

**4** Press the AUD to end the control mode.

**NOTE**

Determining the parameters in the audio control setting would clear all the adjustments made in the System Q and they are replaced with the values in the audio control setting.

## General features

### Mobile Preset

This function allows you to adjust the setting that is recalled with the System Q, according to types of speakers.

- 1 Press the SRC button repeatedly to select the standby mode. "OFF" is displayed when the standby mode is selected.
- 2 Press the Q button to enter the mobile preset plan mode.
- 3 Press either the ◀◀ or ▶▶ button to select the type of speaker. The setting switches as follows.  
Off ("SP-F") / For the OEM speaker ("SP-O") / For 6/6x9 in. speaker ("SP-6") / For 5/4 in. speaker ("SP-5")
- 4 Press the Q button to end the mobile preset plan mode.

#### NOTE

When you change the setting of type of speaker, the bass, middle, and treble tone settings are returned to original levels.

### Clock display

#### Changing the Clock Display:

Press the CLK button to switch the clock display on and off.

#### NOTE

The clock indicator lights while the clock is displayed.

### Adjusting Time

Adjust the time.

- 1 When the clock is not displayed, first press the CLK button to display the clock.
- 2 Press the ADJ button for at least two seconds to enter the clock adjustment mode. The clock display will blink.
- 3 • Adjusting the hours  
Press the FM button to advance the hours, or press the AM

button to make the hours go back.

- Adjusting the minutes  
Press the ▶▶ button to advance the minutes, or press the ◀◀ button to make the minutes go back.

- 4 Press the CLK button to end the clock adjustment mode.

### Disabled System Indicator (DSI)

A red indicator will blink on the unit after the faceplate is removed, warning potential thieves. The factory default for this function is ON.

#### Turning Disabled System Indicator On/Off:

- 1 Turn the power of the unit off.
- 2 While pressing buttons #1 and #3 at the same time, press the SRC button.

Repeat steps 1 and 2 above to turn DSI back on.

### Theft Deterrent Faceplate

The faceplate of the unit can be detached and taken with you, helping to deter theft.

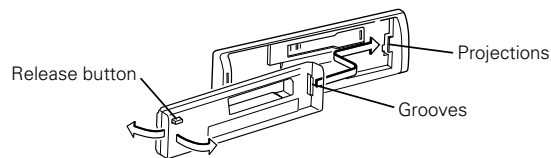

#### Removing the Faceplate:

Press the release button.

The faceplate is unlocked, allowing you to detach it.



## Tuner features

### NOTE

- The faceplate is a precision piece of equipment and can be damaged by shocks or jolts. For that reason, keep the faceplate in its special storage case while detached.
- Do not expose the faceplate or its storage case to direct sunlight or excessive heat or humidity. Also avoid places with too much dust or the possibility of water splashing.

### Reattaching the Faceplate:

- 1 Align the projections on the unit with the grooves on the faceplate.
- 2 Push the faceplate in until it clicks.  
The faceplate is locked in place, allowing you to use the unit.

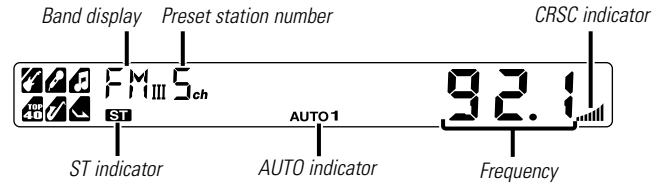
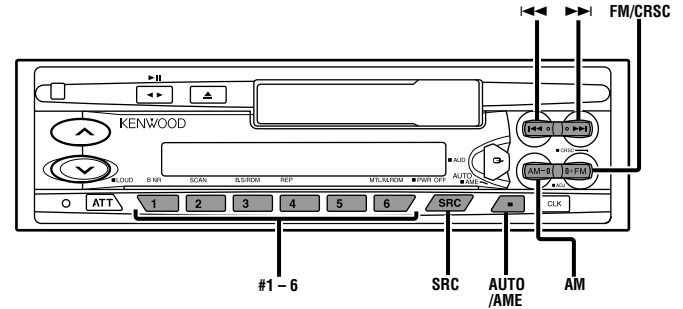

## Tuner features

### Tuning

You can choose from three tuning modes: auto seek, preset station seek, and manual. The AUTO 1 indicator lights up when auto seek tuning is selected, and the AUTO 2 indicator lights when preset station seek tuning is selected.

#### Selecting Tuning Mode:

Press the AUTO button.

Each time you press the AUTO button, the mode switches as follows.

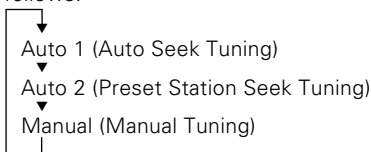

#### Tuning:

- 1 Press the SRC (source) button repeatedly to select the tuner mode. "TUnE" is displayed when the tuner mode has been selected.
- 2 Press either the FM or AM button to select the band. Each time you press the FM button, the band switches between the FM1, FM2 and FM3 (which are used for groups of preset stations). Press the AM button to select the AM band.
- 3
  - Auto Seek Tuning  
Press the ►► button to seek higher frequencies. Press the ◀◀ button to seek lower frequencies.
  - Preset station seek tuning  
Press the ►► button to move to the next preset station (i.e., the one with the next highest number), and the ◀◀ button to move to the last preset station (i.e., the one with the next lowest number).
  - Manual Tuning  
Press the ►► button to increase the frequency by one step. Press the ◀◀ button to decrease the frequency by one step.

#### NOTE

The ST indicator lights up when stereo broadcasts are being

received.

### Station Preset Memory

Store the frequency of a station. You can then recall that station with a single touch of a button.

- 1 Select the band/station that you want to have stored.
- 2 Press the button (#1-6) that you want to use for the station, for at least two seconds. The button number blinks once in the display to indicate that the data has been stored.

#### Recalling a Preset Station:

Press the preset station button (#1-6) for the desired station. The number of the recalled station is displayed.

#### NOTE

You can store six stations in each of the FM1, FM2, FM3, and AM bands.

### Auto Memory Entry

You can automatically store all the receivable frequencies in the band currently being listened to, and then recall them with the touch of a button later. This function is especially useful when you are travelling and do not know what stations are available. Up to six frequencies can be stored this way.

- 1 Select the band for auto memory entry.
- 2 Press the AME button for at least two seconds to start auto memory entry. The numbers of the preset station buttons are shown in order. When all the stations in a certain band are stored in the preset memory, the auto memory entry stops. The tuner then plays the last station received.

#### Recalling a Preset Station:

Press the preset station button (#1-6) for the desired station.  
The number of the recalled station is displayed.

### Clean Reception System Circuit (CRSC)

Temporarily have reception switched from stereo to mono to reduce multi-path noise when listening to the FM station. The factory default for this function is ON.

#### Turning CRSC On/Off:

Press the CRSC button for at least one second to turn the function on/off.

The CRSC indicator lights up when CRSC is on.

#### NOTE

Strong electrical fields (such as from power lines) may cause unstable sound quality when CRSC is turned on. In such a situation, turn it off.

### Cassette player features

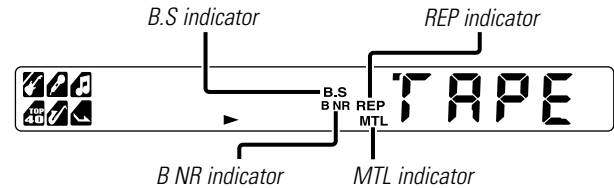
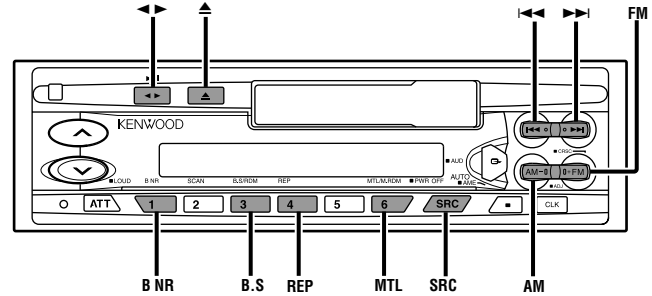

## Cassette player features

### Playing Cassette Tapes

#### Loading and Playing Cassettes:

Load a cassette with the tape exposed on the right.  
The tape starts playing automatically.

#### Playing Cassettes Already Loaded:

Press the SRC (source) button repeatedly to select the tape mode. "TAPE" is displayed when the tape mode has been selected.

#### Listening to the other side:

Press the ◀▶ button.  
Tape play switches to the other side.

#### Stopping and Ejecting Cassettes:

Press the ▲ button.  
The tape stops playing and the cassette ejects.

#### NOTE

Remove a cassette from the unit when not listening to it for a while. If you leave it in the unit too long, the tape may stick to the tape head and cause unit malfunction.

### Fast Forwarding and Rewinding Cassette Tapes

#### Fast Forwarding Tapes:

Press the FM button.

#### Rewinding Tapes:

Press the AM button.

#### Canceling:

Press the ◀▶ button.  
Normal tape play will begin.

### Using Dolby B Noise Reduction

Listen to tapes recorded using Dolby B NR.

#### Turning Dolby B Noise Reduction On/Off:

Press the B NR button to switch Dolby B NR on and off.  
The B NR indicator lights up when it is turned on.

*Function of the KRC-409*

### Switching Tape Types

Select type of tape being played.

#### Switching Tape Types:

Press the MTL (Metal) button to switch the metal tape indicator on and off and to select the tape type.  
Turn the MTL indicator off for normal tape (Type I) playback.  
Turn the MTL indicator on for the following tape types:  
CrO<sub>2</sub> (Type II) FeCr (Type III) Metal (Type IV)  
Selecting the wrong tape type may cause sound quality to suffer.

### Blank Skip

Automatically fast forward to the beginning of the next track when long blank spaces (10 seconds or more) are detected, continuing tape playback.

#### Turning Blank Skip On/Off:

Press the B.S button to switch blank skip on and off.  
The B.S indicator lights up when blank skip is turned on.

#### NOTE

- If the blank space contains much noise, the blank skip function may not work right.
- Sections recorded at low levels may trigger the blank skip function if they last for 10 seconds or more.

## External disc control features

### Tape Advance

Rewinds to the beginning of the track currently being listened to (or fast forwards to the beginning of the next track), continuing tape playback.

#### **Rewinding tape to the beginning of current track:**

Press the **I◀◀** button, and the tape will rewind to the beginning of the current track and automatically start playing again.

#### **To advance to the beginning of the next track:**

Press the **▶▶I** button, and the tape will advance to the beginning of the next track and automatically start playing again.

#### **NOTE**

Tape advance "knows" where a track begins by detecting the blank space preceding it (the space between tracks). However, when the blank space lasts for less than four seconds or contains noise, this function may not operate correctly. Furthermore, sections that are recorded at low levels may trigger the function if they last for four seconds or more.

### Music Repeat

Repeatedly plays the track currently being listened to.

#### **Turning Music Repeat On/Off:**

Press the **REP** button to switch music repeat on/off. The **REP** indicator lights up when music repeat is turned on.

#### **Canceling Music Repeat:**

Press either the **REP** or **◀▶** button.

#### **NOTE**

Music repeat "knows" where a track begins by detecting the blank space preceding it (the space between tracks). However, when the blank space lasts for less than four seconds or contains noise, this function may not operate correctly. Furthermore, sections that are recorded at low levels may trigger the function if they last for four seconds or more.

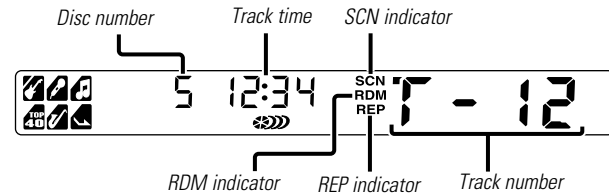
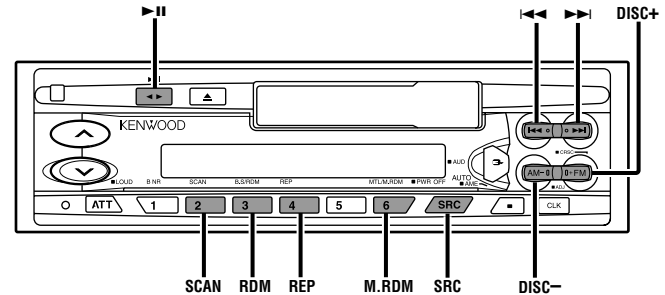

## External disc control features

### Playing Disc mode

This function permits the connection of optional players and the playing of discs.

#### Playing Discs:

Press the SRC button repeatedly to select the external disc control mode.  
The disc will start playing.

#### NOTE

The external disc control mode will differ, depending on the unit that is connected.

Mode Display Examples

- "CD" ...when a CD player is connected
- "DISC" ...when a disc changer is connected
- "CH-1" , "CH-2" ...when two disc changers are connected

#### Pausing and Restarting Disc Play:

Press the **▶||** button to make the disc pause.  
Press the same button again to start play again.

#### NOTE

- When one disc has finished playing its last track, the next disc in the changer starts playing. When the last disc in the changer has finished, the player returns to the first disc and starts playing it.
- Disc #10 is displayed as "0".

### Fast Forwarding and Reversing Disc Play

#### Fast Forwarding Disc Play:

Hold down on the **▶▶** button.  
Release your finger to play the disc at that point.

#### Reversing Disc Play:

Hold down on the **◀◀** button.  
Release your finger to play the disc at the point.

#### NOTE

You cannot use reverse play between tracks depending on the model being connected. Instead, the reverse play function is

anceled when it reaches the beginning of a track, at which point normal play will automatically resume.

### Track Search

Search forward or backward through the tracks on the disc until you reach the one that you want to listen to.

#### Making a Reverse Track Search:

Press the **◀◀** button to display the desired track number.  
Press once to search back to the beginning of the current track, twice to search back to the beginning of the previous track, and so forth.  
Play starts at the beginning of the displayed track number.

#### NOTE (For disc changers)

Pressing the **◀◀** button while listening to track 1 will only search back to the beginning of that track. The reverse search is not "recycled" to the last track on the disc.

#### Making a Forward Track Search:

Press the **▶▶** button to display the desired track number.  
Press once to fast forward to the next track, twice to fast forward to the track after that, and so forth.  
Play starts at the beginning of the displayed track number.

#### NOTE (For disc changers)

You cannot make a forward track search when listening to the last track on a disc.

### Disc Search

(Function of disc changers)

Search forward or backward through the discs in a disc changer.

#### Making a Reverse Disc Search:

Press the **DISC-** button to display the desired disc number.  
Each time the button is pressed, the displayed disc number decreases by one.

Play starts at the beginning of the displayed disc.

### **Making a Forward Disc Search:**

Press the DISC+ button to display the desired disc number. Each time the button is pressed, the displayed disc number increases by one.

Play starts at the beginning of the displayed disc.

#### **NOTE**

"LOAD" is displayed when discs are being exchanged on the disc changer.

## **Track / Disc Repeat**

Repeat playing the track or the disc currently being listened to.

### **Turning Repeat Play On/Off:**

Press the REP button to switch repeat track/disc play on and off as follows:

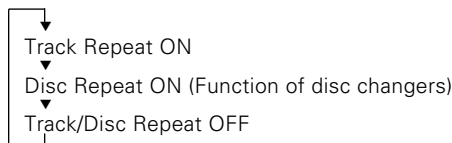

The REP indicator lights up when repeat play is turned on.  
The track number blinks in the display when track repeat is on.  
The disc number blinks in the display when disc repeat is on.

#### **NOTE**

Repeat play is canceled when you eject the disc.

## **Track Scan**

Successively play the beginning of each track on a disc until you find the track that you want to listen to.

### **Starting the Track Scan:**

Press the SCAN button. The SCN indicator lights up and the first 10 seconds of each track will be played, in order. The track number currently being heard blinks in the display.

### **Stopping to Listen to the Track Being Scanned:**

Press the ►|| or SCAN button again to stop the scan and keep on listening to a track normally.

#### **NOTE**

- The track scan function is canceled when you eject the disc.
- The track scan function only scans each track on a disc once.

## **Random Play**

Play all the tracks on the current disc in random order.

- 1 Press the RDM button to switch random play on and off. The RDM indicator lights up when random play is turned on. The track number will change over and over in the display as the next track is being selected. When the track has been selected, play will begin. The selected track number blinks in the display as it is being played.

#### **NOTE** (For disc changers)

When all the tracks on a certain disc have been played using random play, the next disc on the changer will start playing using the same function.

- 2 To change the track being heard, press the ►►| button. Another track will be selected and played.

#### **NOTE**

Random play is canceled when you eject the disc.

## ***External disc control features***

### **Magazine Random Play** *(Function of disc changers)*

Play the tracks on all the discs in the disc changer in random order.





- 1 Press the M.RDM button to switch magazine random play on and off.  
The RDM indicator lights up when magazine random play is turned on.  
The disc and track numbers will change over and over in the display as the next track is being selected.  
When the disc/track has been selected, play will begin.  
The selected disc/track number blinks in the display as it is being played.
- 2 To change the track being heard, press the ►► button.  
Another disc/track will be selected and played.

#### **NOTE**

- Magazine random play is canceled when you eject the disc.
- The time needed for random selection depends on the number of discs loaded in the disc magazine.

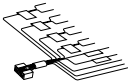
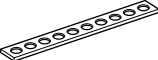

## Accessories

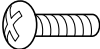
	External view	Number of items
①		.....1
②		.....1
③		.....2
④		.....1
⑤		.....4
⑥		.....4
⑦		.....1

### ▲CAUTION

The use of any accessories except for those provided might result in damage to the unit. Make sure only to use the accessories shipped with the unit, as shown above.

## Installation Procedure

1. To prevent a short circuit, remove the key from the ignition and disconnect the ⊖ battery.
2. Make the proper input and output wire connections for each unit.
3. Connect the speaker wires of the wiring harness.
4. Connect the wiring harness wires in the following order: ground, battery, ignition.
5. Connect the wiring harness connector to the unit.
6. Install the unit in your car.
7. Reconnect the ⊖ battery.
8. Press the reset button.

### ▲CAUTION

- If your car's ignition does not have an ACC position, connect the ignition wires to a power source that can be turned on and off with the ignition key. If you connect the ignition wire to a power source with a constant voltage supply, as with battery wires, the battery may die.
- If the console has a lid, make sure to install the unit so that the faceplate will not hit the lid when closing and opening.
- If the fuse blows, first make sure the wires aren't touching to cause a short circuit, then replace the old fuse with one with the same rating.
- Do not let unconnected wires or terminals touch metal on the car or anything else conducting electricity. To prevent a short circuit, do not remove the caps on the ends of the unconnected wires or the terminals.
- Connect the speaker wires correctly to the terminals to which they correspond. The unit may be damaged or fail to work if you share the ⊖ wires or ground them to any metal part in the car.
- After the unit is installed, check whether the brake lamps, blinkers, wipers, etc. on the car are working properly.
- Insulate unconnected wires with vinyl tape or other similar material.
- Some disc changers need conversion cords for connection. See the section on "Safety Precautions" for details.

# Connecting Wires to Terminals

KENWOOD disc changer control input

**NOTE**

To connect the Disc changer, consult your Disc changer manual.

Rear left output (White)      Front left output (White) (KRC-409 only)

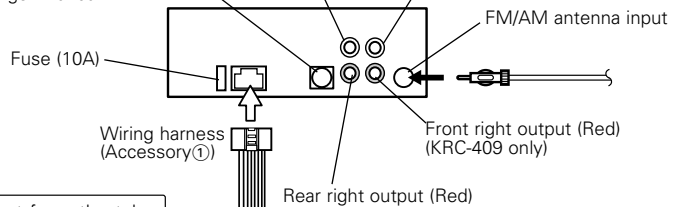

If no connections are made, do not let the wire come out from the tab.

Connect either to the power control terminal when using the optional power amplifier, or to the antenna control terminal in the vehicle.

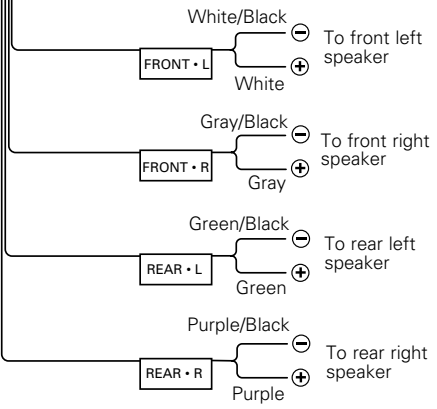
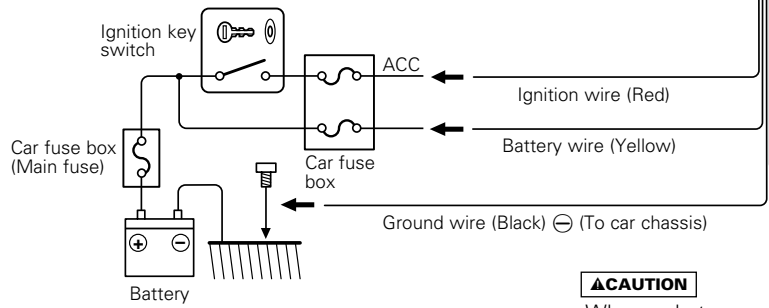
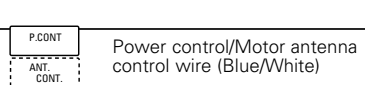

**▲WARNING**

If you connect the ignition wire (red) and the battery wire (yellow) to the car chassis (ground), you may cause a short circuit, that in turn may start a fire. Always connect those wires to the power source running through the fuse box.

**▲CAUTION**

When only two speakers are being connected to the system, connect the connectors either to both the front output terminals or to both the rear output terminals (do not mix front and rear). For example, if you connect the ⊕ connector of the left speaker to a front output terminal, do not connect the ⊖ connector to a rear output terminal.

## ■ Installation

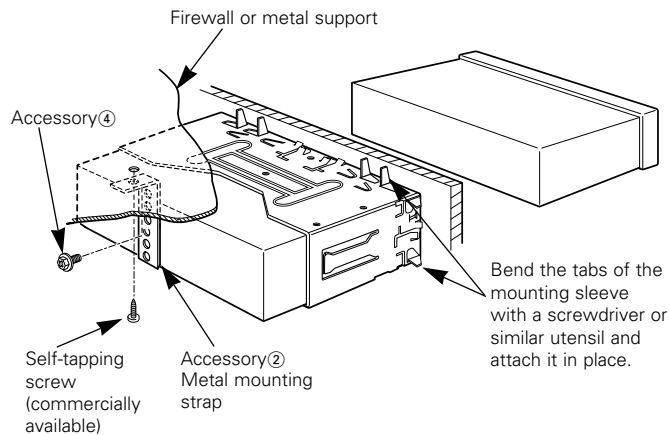

### NOTE

Make sure that the unit is installed securely in place. If the unit is unstable, it may malfunction (for example, the sound may skip).

## ■ Installing in Japanese-Made Cars

- 1 Refer to the section “Removing the hard rubber frame (P. 20)” and then remove the hard rubber frame.
- 2 Align the holes in the unit (two locations on each side) with the vehicle mounting bracket and secure the unit with the accessory screws.

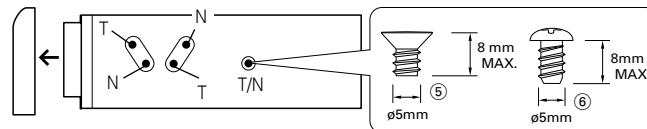

### CAUTION

- During installation, do not use any screws except for those provided. The use of different screws might result in damage to the main unit.
- Damage may occur if a screwdriver or similar tool is used with excessive force during the installations.

## ■ Removing the hard rubber frame

- 1 Engage the catch pins on the removal tool and remove the two locks on the lower level.  
Lower the frame and pull it forward as shown in the figure.

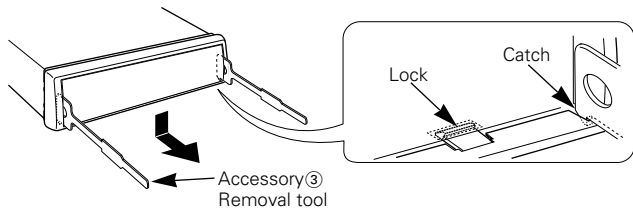

- 2 When the lower level is removed, remove the upper two locations.

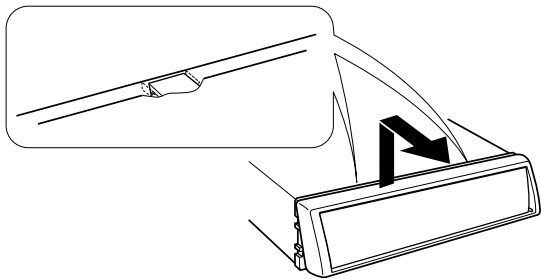

### NOTE

The frame can be removed from the top side in the same manner.

## ■ Removing the Unit

- 1 Refer to the section “Removing the hard rubber frame” and then remove the hard rubber frame.
- 2 Remove the Hex-head screw with integral washer (M4x8) on the back panel.
- 3 Insert the two removal tools deeply into the slots on each side, as shown.

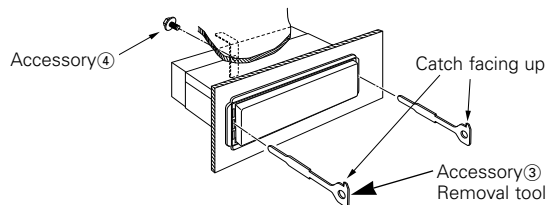

- 4 Lower the removal tool toward the bottom, and pull out the unit halfway whilst pressing towards the inside.

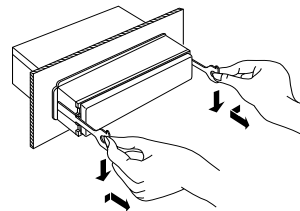

### CAUTION

Be careful to avoid injury from the catch pins on the removal tool.

- 5 Pull the unit all the way out with your hands, being careful not to drop it.

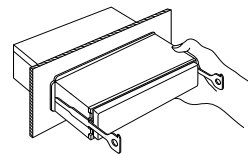

## Installation

### ■ *Screwing the Faceplate on the Unit*

If you want to fasten the faceplate to the main unit so that it does not fall off, screw in the provided screw ( $\varnothing 4 \times 16$  mm) in the hole shown below.

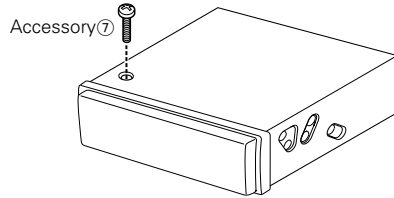

#### **▲CAUTION**

Never insert the tap-tite screw ( $\varnothing 4 \times 16$  mm) in any other screw hole than the one specified. If you screw it in another hole, it will contact and may cause damage to the mechanical parts inside the unit.

## Troubleshooting Guide

What might seem to be a malfunction in your unit may just be the result of slight misoperation or miswiring. Before calling service, first check the following table for possible problems.

PROBLEM	POSSIBLE CAUSE	SOLUTION
The power does not turn on.	The fuse has blown.	After checking for short circuits in the wires, replace the fuse with one with the same rating.
No sound can be heard, or the volume is low.	Attenuator is turned on.	Turn off Attenuator.
	The fader or balance settings are set all the way to one side.	Reset the fader or balance settings.
	The input/output wires or wiring harness are connected incorrectly.	Reconnect the input/output wires or the wiring harness correctly. See the section on "Connecting Wires to Terminals".
The tape does not go in. / No sound can be heard even though the tape display is made.	The cassette tape is bad.	Try playing another cassette tape. If works fine, the first tape was bad.
	The car ignition was turned off during tape eject; or the tape was pulled out during loading, switching the mode to tape mode even though no tape is in.	Press the Eject button.
Nothing happens when the buttons are pressed.	The computer chip in the unit is not functioning normally.	Press the reset button on the unit (see p. 4).
The sound quality is poor or distorted.	The tape head is dirty.	Clean the tape head, referring to the section on "Cleaning the tape head" (see p. 4).
	One of the speaker wires is being pinched by a screw in the car.	Check the speaker wiring.
	The speakers are not wired correctly.	Reconnect the speaker wires so that each output terminal is connected to a different speaker.
Radio reception is poor.	The car antenna is not extended.	Pull the antenna out all the way.
	The antenna control wire is not connected.	Connect the wire correctly, referring to the section on "Connecting Wires to Terminals".
The memory is erased when the ignition is turned off.	The battery wire has not been connected to the proper terminal.	Connect the wire correctly, referring to the section on "Connecting Wires to Terminals".
	The ignition and battery wire are incorrectly connected.	Connect the wire correctly, referring to the section on "Connecting Wires to Terminals".

## Troubleshooting Guide

PROBLEM	POSSIBLE CAUSE	SOLUTION
Can't remove tape.	The cause is that more than 10 minutes has elapsed since the vehicle ACC switch was turned OFF.	The tape can only be removed within 10 minutes of the ACC switch being turned OFF. If more than 10 minutes has elapsed, turn the ACC switch ON again and press the Eject button.
Free switching of the sound quality.	The system Q function is set on Scan mode.	Refer to the "System Q" page and switch it to a function other than Scan mode.(see p. 6).

### If the following situations, consult your nearest service center:

- Even though the disc changer is connected, the Disc Changer Mode is not on, with "AVin" showing in the display during the Changer Mode.
- Even though no device (KCA-S210A, CA-C1AX, KDC-CPS87, KDC-CX87, KDC-CPS85, KDC-CX85, KDC-CPS82 or KDC-CX82) is connected, the AUX Mode is entered when switching modes.

## CD/MD/External disc control mode

PROBLEM	POSSIBLE CAUSE	SOLUTION
The disc control mode cannot be selected.	No wire has been connected to the disc changer input terminal on the unit.	Connect the wire to the disc changer input terminal on the unit.
The specified disc does not play, but another one plays instead.	The specified CD is quite dirty.	Clean the CD.
	The CD is upside-down.	Load the CD with the labeled side up.
	The disc is loaded in a different slot from that specified.	Eject the disc magazine and check the number for the specified disc.
	The disc is severely scratched.	Try another disc instead.
The sound skips.	Something is touching the disc changer.	Remove whatever is touching it.
	The CD is scratched or dirty.	If skipping happens at the same place when the car is stopped, something with the CD is wrong. Clean the CD.
The display shows that the changer is being played, but no sound can be heard.	The computer chip in the unit is not functioning normally.	Press the reset button on the unit (see p. 4).
The specified track will not play.	Random play or magazine random play has been selected.	Turn off random play or magazine random play.
Track repeat, disc repeat, track scan, random play, and magazine random play start by themselves.	The setting is not canceled.	The settings for these functions remain on until the setting to off or the disc ejected, even if the power is turned off or the source changed.
Cannot play CD-R or CD-RW	Finalization processing is not being conducted for CD-R/CD-RW.	Conduct finalization processing with CD recorder.
	A non-compatible CD changer is being used to play the CD-R/CD-RW.	Use a CD changer compatible with CD-R/CD-RW to play.



## Troubleshooting Guide

**The following messages are displayed when certain problems are occurring in your system. Take the recommended actions.**

- E-01      No disc magazine has been loaded in the changer. The disc magazine is not completely loaded.  
⇒ Load the disc magazine properly.  
No CD in the unit.  
⇒ Insert the CD.
- E-02      No disc has been loaded in the disc magazine.  
⇒ Load a disc into the disc magazine.
- E-04      No disc has been loaded in the disc magazine.  
⇒ Load a disc into the disc magazine.  
The CD is quite dirty. The CD is upside-down. The CD is scratched a lot.  
⇒ Clean the CD and load it correctly.
- E-10      Nothing has been recorded on the MD.
- E-11      No tracks are recorded on the MD, although it has a title.
- E-30      The faceplate of the slave unit being connected to this unit has been removed.  
⇒ Replace it.
- E-77      The unit is malfunctioning for some reason.  
⇒ Press the reset button on the unit. If the "E- 77" code does not disappear, consult your nearest service center.
- E-99      Something is wrong with the disc magazine. Or the unit is malfunctioning for some reason.  
⇒ Check the disc magazine. And then press the reset button on the unit. If the "E- 99" code does not disappear, consult your nearest service center.
- E-0d      The protective circuit in the unit activates when the temperature inside the automatic disc changer exceeds 60°C (140°F), stopping all operation.  
⇒ Cool down the unit by opening the windows or turning on the air conditioner. As the temperature falls below 60°C (140°F), the disc will start playing again.
- ◀▶      If this indicator continues blinking, it is possible that the tape has become jammed or tangled.  
⇒ Contact the Kenwood dealer if the cassette tape cannot be ejected.

## Specifications

### Specifications subject to change without notice.

#### FM tuner section

Frequency range (200 kHz space) .....	87.9 MHz – 107.9 MHz
Usable sensitivity (S/N = 30dB) .....	9.3 dBf (0.8 $\mu$ V/75 $\Omega$ )
Quieting Sensitivity (S/N = 50dB) .....	15.2 dBf (1.6 $\mu$ V/75 $\Omega$ )
Frequency response ( $\pm$ 3 dB) .....	30 Hz – 15 kHz
Signal to Noise ratio (MONO) .....	70 dB
Selectivity ( $\pm$ 400 kHz) .....	$\geq$ 80 dB
Stereo separation (1 kHz) .....	40 dB

#### AM tuner section

Frequency range (10 kHz space) .....	530 kHz – 1700 kHz
Usable sensitivity (S/N = 20dB) .....	28 dB $\mu$ (25 $\mu$ V)

#### Cassette player section

Tape Speed .....	4.76 cm/sec.
Wow & Flutter (WRMS) .....	0.08 %
Frequency response ( $\pm$ 3 dB)	
KRC-409 (70 $\mu$ s) .....	30 Hz – 18 kHz
KRC-309S (120 $\mu$ s) .....	30 Hz – 14 kHz
Separation (1 kHz) .....	43 dB
Signal to Noise ratio	
KRC-409	
Dolby NR OFF .....	57 dB
Dolby B NR ON .....	65 dB
KRC-309S	
Dolby NR OFF .....	54 dB
Dolby B NR ON .....	63 dB

#### Audio section

Maximum output power .....	45 W x 4
Full Bandwidth Power (at less than 1% THD) .....	22 W x 4
Tone action	
Bass : .....	100 Hz $\pm$ 10 dB
Middle : .....	1 kHz $\pm$ 10 dB
Treble : .....	10 kHz $\pm$ 10 dB
Preout level / Load (during disc play) .....	1800 mV / 10 k $\Omega$
Preout impedance .....	$\leq$ 600 $\Omega$

#### General

Operating voltage (11 – 16V allowable) .....	14.4 V
Current consumption .....	10 A
Installation Size (W x H x D) .....	182 x 53 x 152 mm (7-3/16 x 2-1/16 x 6 in.)
Weight .....	2.9 lbs (1.3 kg)

KENWOOD

## Free Manuals Download Website

<http://myh66.com>

<http://usermanuals.us>

<http://www.somanuals.com>

<http://www.4manuals.cc>

<http://www.manual-lib.com>

<http://www.404manual.com>

<http://www.luxmanual.com>

<http://aubethermostatmanual.com>

Golf course search by state

<http://golfingnear.com>

Email search by domain

<http://emailbydomain.com>

Auto manuals search

<http://auto.somanuals.com>

TV manuals search

<http://tv.somanuals.com>