

# KENWOOD

AUDIO VIDEO SURROUND RECEIVER

VR-407

VR-406

VR-405

VR-414

KRF-V7030D

KRF-V6030D

KRF-V5030D

KRF-V4530D

---

## INSTRUCTION MANUAL

KENWOOD CORPORATION

**This instruction manual is used to describe multiple models listed above. Model availability and features (functions) may differ depending on the country and sales area.**

### ***About the supplied remote control (RC-R0609)...***

Compared to standard remote controls, the remote control supplied with this receiver has several operation modes. These modes enable the remote control to control other audio/video components. In order to effectively use the remote control it is important to read the operating instructions and obtain a proper understanding of the remote control and how to switch its operation modes (etc.).

Using the remote control without completely understanding its design and how to switch the operation modes may result in incorrect operations.

## Before applying the power

**Caution:** Read this page carefully to ensure safe operation.

2

Units are designed for operation as follows.

U.S.A. and Canada .....	AC 120 V only
Australia .....	AC 240 V only
China and Russia .....	AC 220 V only
*Other countries .....	AC 110-120 / 220-240 V switchable

### \* AC voltage selection

The AC voltage selector switch on the rear panel is set to the voltage that prevails in the area to which the unit is shipped. Before connecting the power cord to your AC outlet, make sure that the setting position of this switch matches your line voltage. If not, it must be set to your voltage in accordance with the following direction.

#### AC voltage selector switch

Move switch lever to match your line voltage with a small screwdriver or other pointed tool.

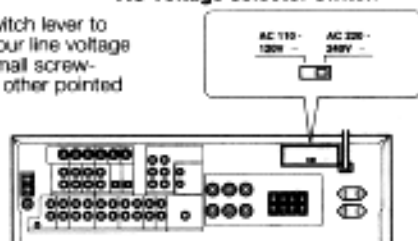

Note:

Our warranty does not cover damage caused by excessive line voltage due to improper setting of the AC voltage selector switch.

## Safety precautions

### WARNING :

TO PREVENT FIRE OR ELECTRIC SHOCK, DO NOT EXPOSE THIS APPLIANCE TO RAIN OR MOISTURE.



#### CAUTION

RISK OF ELECTRIC SHOCK  
DO NOT OPEN



CAUTION: TO REDUCE THE RISK OF ELECTRIC SHOCK, DO NOT REMOVE COVER (OR BACK). NO USER-SERVICEABLE PARTS INSIDE, REFER SERVICING TO QUALIFIED SERVICE PERSONNEL.



THE LIGHTNING FLASH WITH ARROWHEAD SYMBOL, WITHIN AN EQUILATERAL TRIANGLE, IS INTENDED TO ALERT THE USER TO THE PRESENCE OF UNINSULATED "DANGEROUS VOLTAGE" WITHIN THE PRODUCT'S ENCLOSURE THAT MAY BE OF SUFFICIENT MAGNITUDE TO CONSTITUTE A RISK OF ELECTRIC SHOCK TO PERSONS.



THE EXCLAMATION POINT WITHIN AN EQUILATERAL TRIANGLE IS INTENDED TO ALERT THE USER TO THE PRESENCE OF IMPORTANT OPERATING AND MAINTENANCE (SERVICING) INSTRUCTIONS IN THE LITERATURE ACCOMPANYING THE APPLIANCE.

## Unpacking

Unpack the unit carefully and make sure that all accessories are put aside so they will not be lost.

Examine the unit for any possibility of shipping damage. If your unit is damaged or fails to operate, notify your dealer immediately. If your unit was shipped to you directly, notify the shipping company without delay. Only the consignee (the person or company receiving the unit) can file a claim against the carrier for shipping damage.

We recommend that you retain the original carton and packing materials for use should you transport or ship the unit in the future.

Keep this manual handy for future reference.

### Accessories

FM indoor antenna (1)



AM loop antenna (1)



For VR-407, VR-406, KRF-V7030D, and KRF-V6030D

Remote control unit (1)  
RC-R0609



Batteries (R6/AA) (2)



For VR-405, VR-414, KRF-V5030D, and KRF-V4530D

Remote control unit (1)  
RC-R0509



Batteries (R6/AA) (2)



\*AC plug adaptor (1)



\*Use to adapt the plug on the power cord to the shape of the wall outlet. (Accessory only for regions where use is necessary.)

### Microcomputer malfunction

If operation is not possible or an erroneous display appears, even though all connections have been made properly, reset the microcomputer referring to "In case of difficulty".

-28-

## For the U.S.A.

**FCC WARNING**

This equipment may generate or use radio frequency energy. Changes or modifications to this equipment may cause harmful interference unless the modifications are expressly approved in the instruction manual. The user could lose the authority to operate this equipment if an unauthorized change or modification is made.

**NOTE:**

This equipment has been tested and found to comply with the limits for a Class B digital device, pursuant to Part 15 of the FCC Rules. These limits are designed to provide reasonable protection against harmful interference in a residential installation. This equipment may cause harmful interference to radio communications, if it is not installed and used in accordance with the instructions. However, there is no guarantee that interference will not occur in a particular installation. If this equipment does cause harmful interference to radio or television reception, which can be determined by turning the equipment off and on, the user is encouraged to try to correct the interference by one or more of the following measures:

- Reorient or relocate the receiving antenna.
- Increase the separation between the equipment and receiver.
- Connect the equipment into an outlet on a circuit different from that to which the receiver is connected.
- Consult the dealer or an experienced radio / TV technician for help.

## For the U.S.A.

**Note to CATV system installer:**

This reminder is provided to call the CATV system installer's attention to Article 820-40 of the NEC that provides guidelines for proper grounding and, in particular, specifies that the cable ground shall be connected to the grounding system of the building, as close to the point of cable entry as practical.



As an ENERGY STAR® Partner, Kenwood Corporation has determined that this products meets the ENERGY STAR® guidelines for energy efficiency.

This product can save energy. Saving energy reduces air pollution and lowers utility bills.

**Maintenance of the unit**

When the front panel or case becomes dirty, wipe with a soft, dry cloth. Do not use thinner, benzene, alcohol, etc. for these agents may cause discoloration.

**In regard to contact cleaner**

Do not use contact cleaners because it could cause a malfunction. Be specially careful not to use contact cleaners containing oil, for they may deform the plastic component.

**Contents**

Caution : Read the pages marked carefully to ensure safe operation.

<b>Preparations</b>	<b>Before applying the power</b> ..... 2
	Safety precautions ..... 2
	Unpacking ..... 2
	How to use this manual ..... 4
	Special features ..... 4
	<b>Names and functions of parts</b> ..... 5
	<b>Setting up the system</b> ..... 8
	Connecting audio components ..... 8
	Connecting video components ..... 9
	Connecting a DVD player (6-channel input) (VR-407/406/KRF-V7030D/V6030D/V5030D/V4530D only) ..... 9
	Digital connections ..... 10
	Connecting to the AUX IN jacks (VR-407/KRF-V7030D only) ..... 11
	Connecting the antennas ..... 11
	Connecting the system control ..... 12
	Connecting the speakers ..... 13
	Channel space switching ..... 14
	Preparing the remote control ..... 14
	<b>Preparing for surround sound</b> ..... 15
	Speaker settings ..... 15
	<b>Normal playback</b> ..... 16
	Preparing for playback ..... 16
	Listening to a source component ..... 17
	Adjusting the sound ..... 17
	<b>Recording</b> ..... 18
	Recording audio (analog sources) ..... 18
	Recording video ..... 19
	Recording audio (digital sources) ..... 19
	<b>Listening to radio broadcasts</b> ..... 20
	Tuning radio stations ..... 20
	Presetting radio stations manually ..... 20
	Receiving preset stations ..... 20
	Receiving preset stations in order (P.CALL) ..... 21
	<b>Ambience effects</b> ..... 22
	Surround modes ..... 22
	Surround play ..... 23
	DVD 6-channel playback (VR-407/406/KRF-V7030D/V6030D/V5030D/V4530D only) ..... 24
	Convenient functions ..... 25
<b>Other</b>	<b>In case of difficulty</b> ..... 26
	<b>Specifications</b> ..... 27
<b>Remote Control (Separate booklet)</b>	<b>Quick start guide</b> ..... 1
	<b>Getting the most from your remote control</b> ..... 3
	<b>Setup code chart</b> ..... 4
	<b>In case of difficulty</b> ..... 5
	<b>Remote operation of other components</b> .... 6

3

Preparations

Operations

Other

Remote Control

## How to use this manual

The manual covers the VR-407, VR-406, VR-405, VR-414, KRF-V7030D, KRF-V6030D, KRF-V5030D, and KRF-V4530D. Items such as functions, number of jacks, and remote control details differ somewhat between these models. To confirm the functions available on the model you have purchased, refer to the table below.

Model name	Remote Control	Terminal		
		Speaker out	VIDEO 3 jacks	Front input
VR-407 KRF-V7030D	RC-R0609	2 systems (A, B)	Equipped	Equipped
VR-406 KRF-V6030D	RC-R0609	2 systems (A, B)	Not equipped	Not equipped
VR-405/414 KRF-V5030D/ V4530D	RC-R0509	1 system	Not equipped	Not equipped

This manual is divided into four sections, Preparations, Operations, Other, and Remote Control.

### Preparations

Shows you how to connect your audio and video components to the receiver and prepare the surround processor.

We've tried to make setting up your system as easy as possible. However, since this receiver works with all of your audio and video components, connecting the system can be fairly complex.

### Operations

Shows you how to operate the various functions available from the receiver.

### Other

Shows you additional information such as "in case of difficulty" (troubleshooting) and "Specifications".

### Remote Control (Separate booklet) (VR-407/VR-406/KRF-V7030D/KRF-V6030D only)

Includes the "Quick Start Guide," which shows you how to operate other components using the remote control, as well as a detailed explanation of all remote control operations. Once you have registered your components with the proper setup codes, you'll be able to operate both this receiver and your other AV components (TV, VCR, DVD player, LD player, CD player, etc.) using the remote control supplied with this receiver.

### Memory back up function

Please note that the following items will be deleted from the unit's memory if the power cord is disconnected from the AC outlet for approximately 3 days.

- Power mode.
- Input selector settings.
- Device preset.
- Picture output.
- Speaker ON/OFF.
- Volume level.
- BASS, TREBLE, INPUT level.
- Subwoofer ON/OFF.
- Dimmer level.
- Monitor ON/OFF.
- MD/TAPE settings.
- 6CH/2CH input setting.
- Listen mode setting.
- Speaker settings.
- Input mode setting.
- Midnight mode setting.
- Broadcast band.
- Frequency setting.
- Preset stations.
- Tuning mode.

## Special features

### True home theater sound

This receiver incorporates a wide variety of surround modes to bring you maximum enjoyment from your video software. Select a surround mode according to your equipment or the software you are going to play and enjoy! 

### Dolby Pro Logic & Dolby 3 Stereo

This surround system reproduces theater-like surround sound from video software marked  (DOLBY SURROUND).

The PRO LOGIC mode uses the built-in adaptive matrix circuit to steer the Left, Center, Right and Surround channel audio signals.

The 3 STEREO mode will redirect the Surround signal to the front left and right speakers when only the front and center speakers are used.

### Dolby Digital (AC-3)

The DOLBY DIGITAL (AC-3) mode lets you enjoy full digital surround from software processed in the Dolby Digital (AC-3) format. Dolby Digital (AC-3) provides up to 5.1 channels of independent digital audio for better sound quality and more powerful presence than conventional Dolby Surround.

### DTS (VR-407/KRF-V7030D only)

DTS (Digital Theater System) is a 5.1 channel digital audio format that provides five full-spectrum channels and one low-frequency (subwoofer) channel for unprecedented clarity, optimum channel separation and a (wide) dynamic range.

In the DTS mode, the 5.1 channel digital input from a DTS CD, LD or DVD disc (carrying the "DTS" marking) can be played in Digital Surround.

Important:

When a DTS disc is played on a CD, LD or DVD player, noise may be output from the analog output. It is recommended that you connect the digital output of the player to the digital input of this unit.

### DVD 6-channel input (VR-407/406/KRF-V7030D/V6030D/V5030D only)

If you own a DVD player equipped with 6-channel output, this receiver allows you to obtain the full surround sound impact of DVD source material featuring multi-channel encoding. Since the source signals are digital and each channel is input independently, the resulting ambience is far superior to what can be achieved with conventional surround sound systems.

### Universal IR (InfraRed) remote control (VR-407/406/KRF-V7030D/V6030D only)

In addition to the basic receiver, the remote control supplied with this receiver can also operate almost all of your remote controllable audio and video components. Just follow the simple setup procedure to register the components you have connected.

# Names and functions of parts

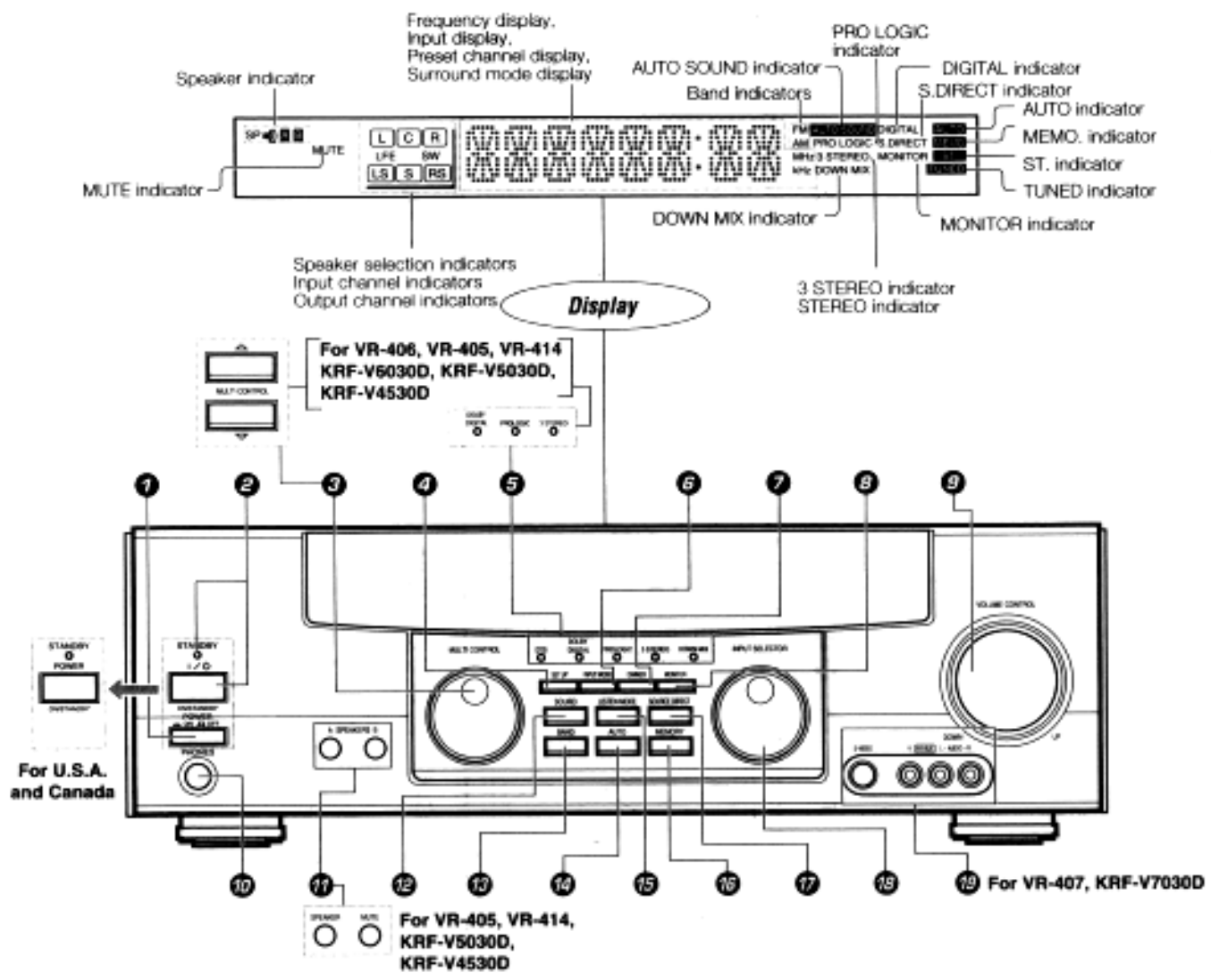

- 1 **POWER key** (Except for U.S.A. and Canada) - [15]  
Use to turn the main power ON/OFF.
- 2 **POWER key** (For U.S.A. and Canada) - [15]  
Use to turn the power ON/OFF.
- 3 **STANDBY indicator** - [15]
- 4 **ON/STANDBY (I/O) key** (Except for U.S.A. and Canada) - [15]  
Use to switch the power ON/STANDBY when the POWER is turned ON.
- 5 **STANDBY indicator** - [15]
- 6 **MULTI CONTROL knob** (For VR-407/KRF-V7030D) - [15]  
Used to make a variety of settings.
- 7 **MULTI CONTROL keys** (For VR-406/405/414/KRF-V5030D/V5030D/V4530D) - [15]  
Used to make a variety of settings.
- 8 **SET UP key** - [15]  
Use to select the surround sound settings.
- 9 **Surround indicators** - [15]
  - **DTS indicator** (For VR-407/KRF-V7030D) - [15]  
Lights when the receiver is in the DTS mode.
- 10 **DOLBY DIGITAL indicator** - [15]  
Lights when the receiver is in the Dolby Digital mode.
- 11 **PROLOGIC indicator** - [15]  
Lights when the receiver is in the PROLOGIC mode.
- 12 **3 STEREO indicator** - [15]  
Lights when the receiver is in the 3 STEREO mode.
- 13 **DOWN MIX indicator** (For VR-407/KRF-V7030D) - [15]  
Lights when the receiver is in the DOWN MIX mode.
- 14 **INPUT MODE key** - [15]  
Use to switch between the digital and analog inputs.
- 15 **DIMMER key** - [15] - [15]  
Use to adjust the brightness of the display.
- 16 **MONITOR key** - [15]  
Use to select the REC MODE.
- 17 **MONITOR key** - [15]  
Use to monitor the source that is connected to the MONITOR jack.
- 18 **VOLUME CONTROL knob** - [15]  
Use for headphone listening.
- 19 **PHONES jack** - [15]
- 20 **SPEAKERS A/B keys** (For VR-407/406/KRF-V7030D/V6030D) - [15]  
Use to turn the A/B speakers ON/OFF.
- 21 **SPEAKER key** (For VR-405/414/KRF-V5030D/V4530D) - [15]  
Use to turn the speaker ON/OFF.
- 22 **MUTE key** (For VR-405/414/KRF-V5030D/V4530D) - [15]  
Use to temporarily mute the sound.
- 23 **SOUND key** - [15]  
Use to adjust the sound quality and ambience effects.
- 24 **BAND key** - [15]  
Use to select the broadcast band.
- 25 **AUTO key** - [15]  
Use to select the auto tuning mode.
- 26 **LISTEN MODE key** - [15]  
Use to select the listening mode.
- 27 **MEMORY key** - [15]  
Use to store radio stations in the preset memory.
- 28 **SOURCE DIRECT key** - [15]  
Use to pass the source material direct to the amplifier.
- 29 **INPUT SELECTOR knob** - [15]  
Use to select the input sources.
- 30 **AUX IN S VIDEO/VIDEO/AUDIO L/R jacks** (For VR-407/KRF-V7030D) - [15]

## Standby mode

While the standby indicator of the unit is lit, a small amount of current is flowing into the unit's internal circuitry to back up the memory. This condition is referred to as the standby mode of the unit. While the unit is in the standby mode, it can be turned ON from the remote control unit.

## Remote control unit (RC-R0609) (VR-407/406/KRF-V7030D/V6030D)

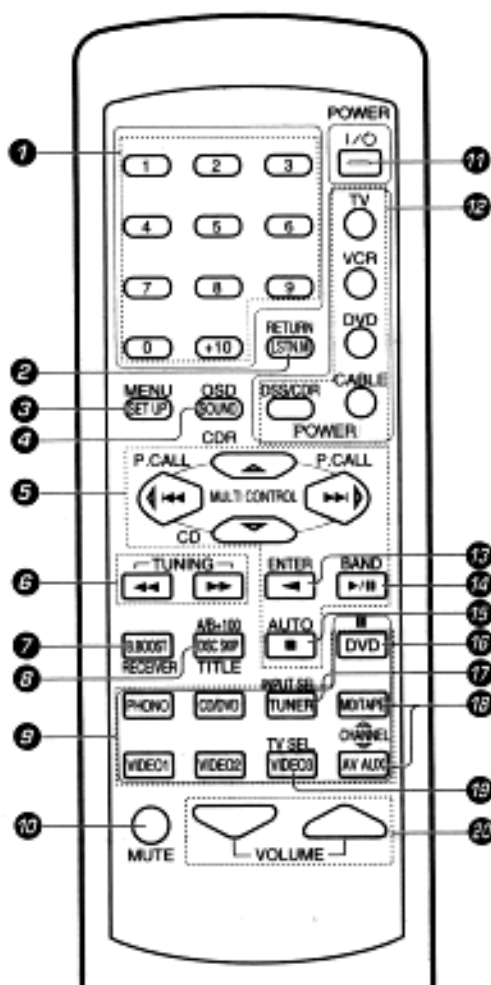

Page references such as "RC-11" indicate pages in the remote control operation manual (Separate booklet).

There are some cases in which keys (or knobs) that have the same function on the receiver and on the remote control have different names. In the instructions of this manual, if the names of corresponding keys (or knobs) on the receiver and remote control are different, the name of the remote control key is indicated in parentheses.

- ① **Numeric keys** RC-11  
Provide functions identical to those of the original remote control supplied with the component you are controlling.
- ② **LSTN.M key** RC-20  
Use to select the listening mode.
- RETURN key** RC-17  
Use to operate other components.
- ③ **SET UP key** RC-21  
Use to select the surround sound settings.
- MENU key** RC-22  
Use to operate other components.
- ④ **SOUND key** RC-28  
Use to adjust the sound quality and ambience effects.
- OSD key** RC-27  
Use to operate other components.
- ⑤ **MULTI CONTROL keys** RC-15  
Used to make a variety of settings. Use to operate other components.
- P.CALL <V> keys** RC-21  
If tuner is selected as the input source, these keys function as P.CALL keys.
- ◀<V>> keys** RC-14  
If CD or MD is selected as the input source, these keys function as search keys.
- ⑥ **TUNING <V> keys** RC-12  
Use to operate the tuner or selected component.

- ⑦ **B. BOOST key** RC-12  
Use to select the maximum adjustment setting for the low frequency range.
- RECEIVER key**  
Use to return to the operation of the receiver.
- ⑧ **DISC SKIP key** RC-14  
If CD is selected as the input source, this key functions as the multi-CD player disc skip key.
- A/B key** RC-14  
If TAPE is selected as the input source, this [A and B] of a double cassette deck.
- +100 key**  
Use to select the disc number with the multi-CD player.
- TITLE key** RC-22  
Use to operate other components.
- ⑨ **INPUT SELECTOR keys (DVD, PHONO, CD/DVD, TUNER, MD/TAPE, VIDEO1, VIDEO2, VIDEO3, AV AUX)** RC-12  
Selects the inputs and sets the remote control to operate the component registered at the respective input.
- ⑩ **MUTE key** RC-18  
Use to temporarily mute the sound.
- ⑪ **POWER key** RC-18  
Use to turn the receiver on and off.
- ⑫ **POWER key (TV, VCR, DVD, DSS/CDR, CABLE)** RC-11  
Use to turn the other components on and off.

- ⑬ **ENTER key** RC-16  
Use to operate other components.
- ◀ key**  
If tape is selected as the input source, this key functions as the play key for side B of the cassette (the side facing away from the front of the deck).
- ⑭ **BAND key** RC-20  
Use to select the broadcast band.
- ▶/|| key** RC-14  
If CD is selected as the input source, this key functions as the play/pause key. If MD is selected as the input source, this key functions as the play key.
- ⑮ **AUTO key** RC-20  
Use to select the auto tuning mode.
- key** RC-14  
If CD or MD is selected as the input source, this key functions as the stop key.
- ⑯ **|| key** RC-14  
Use to operate other components.
- ⑰ **INPUT SEL. key** RC-14  
Use to operate other components.
- ⑱ **CHANNEL Δ/V keys** RC-22  
Use to select the channel.
- ⑲ **TV SEL. key** RC-22  
Use to operate other components.
- ⑳ **VOLUME keys** RC-12  
Use to adjust the receiver volume.

## Remote control unit (RC-R0509) (VR-405/414/KRF-V5030D/V4530D)

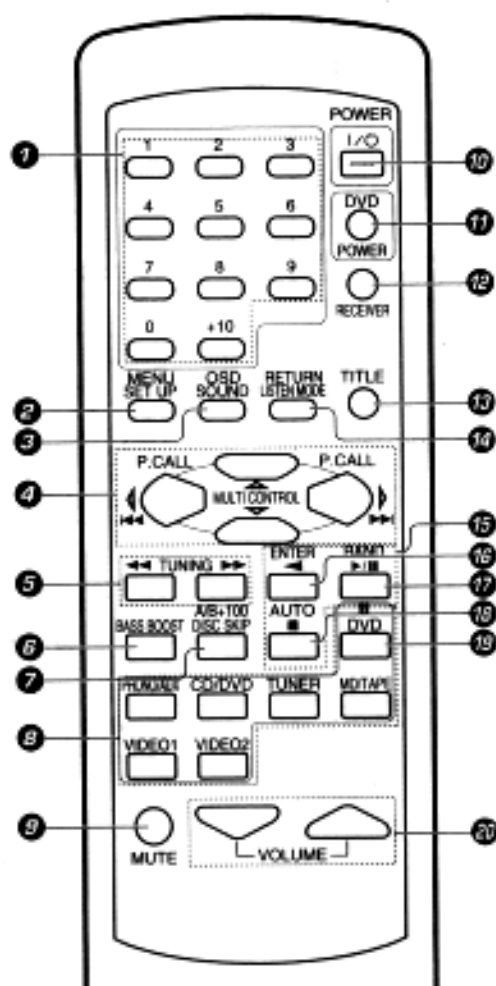

- 1 Numeric keys** - [20]  
If CD or MD is selected as the input source, these keys function as numeric keys. If tuner is selected as the input source, these keys are used to call up station presets.
- 2 SET UP key** - [19]  
Use to select the surround sound settings.
- MENU key**  
Use to operate other components.
- 3 SOUND key** - [21]  
Use to adjust the sound quality and ambience effects.
- OSD key**  
Use to operate other components.
- 4 MULTI CONTROL keys** - [15]  
Used to make a variety of settings.
- P.CALL </b> keys** - [14]  
If tuner is selected as the input source, these keys function as P.CALL keys.
- </b> keys**  
If CD or MD is selected as the input source, these keys function as search keys.
- 5 TUNING </b> keys**  
If tuner is selected as the input source, these keys function as tuning keys.
- 6 BASS BOOST key** - [18]  
Use to select the maximum adjustment setting for the low frequency range.
- 7 DISC SKIP key**  
If CD is selected as the input source, this key functions as the multi-CD player disc skip key.
- A/B key**  
If TAPE is selected as the input source, this (A and B) of a double cassette deck.
- +100 key**  
Use to select the disc number with the multi-CD player.
- 8 INPUT SELECTOR keys (DVD, PHONO/AUX, CD/DVD, TUNER, MD/TAPE, VIDEO1, VIDEO2)** - [17]  
Selects the inputs and sets the remote control to operate the component registered at the respective input.
- 9 MUTE key** - [16]  
Use to temporarily mute the sound.
- 10 POWER key** - [12]  
Use to turn the receiver on and off.
- 11 DVD key**  
Used to operate DVD player.  
For details, refer to the instruction manual of your DVD player.
- 12 RECEIVER key**  
Use to return to the operation of the receiver.
- 13 TITLE key**  
Use to operate other components.
- 14 LISTEN MODE key** - [13]  
Use to select the listening mode.
- RETURN key**  
Use to operate other components.
- 15 Component operation keys RC-[1]**  
Use these keys to operate other components with system control connections to the receiver.
- </b> key**  
If tape is selected as the input source, this key functions as the play key for side B of the cassette (the side facing away from the front of the deck).
- </b> key**  
If CD is selected as the input source, this key functions as the play/pause key.  
If MD is selected as the input source, this key functions as the play key.
- </b> key**  
If CD or MD is selected as the input source, this key functions as the stop key.
- 16 ENTER key**  
Use to operate other components.
- 17 BAND key** - [20]  
If tuner is selected as the input source, this key functions as the band selector key.
- 18 AUTO key** - [20]  
If tuner is selected as the input source, this key functions as the AUTO key.
- 19 </b> key**  
Use to operate other components.
- 20 VOLUME keys** - [20]  
Use to adjust the receiver volume.

## Setting up the system

Make connections as shown below.

When connecting the related system components, be sure to also refer to the instruction manuals supplied with the components you are connecting.

Do not connect the power cord to a wall outlet until all connections are completed.

### DTS disclaimer clause

DTS Digital Surround™ is a discrete 5.1 channel digital audio format available on CD, LD, and DVD software which consequently cannot be decoded and played back inside most CD, LD, or DVD players. For this reason, when DTS-encoded software is played back through the analog outputs of the CD, LD, or DVD player, excessive noise will be exhibited. To avoid possible damage to the audio system, proper precautions should be taken by the consumer if the analog outputs are connected directly to an amplification system. To enjoy DTS Digital Surround™ playback, an external 5.1 channel DTS Digital Surround™ decoder system must be connected to the digital output (S/P DIF, AES/EBU, or TosLink) of the CD, LD or DVD player.

The only audio product models incorporating the DTS Digital Surround decoder are the VR-407 and KRF-V7030D.

### VIDEO 2/MONITOR jacks (for VR-406/405/414/KRF-V6030D/V5030D/V4530D)

The receiver's VIDEO 2/MONITOR jacks can be used in two different ways. Make the appropriate setting for the component connected to the jack when the receiver is turned on.

#### Use as a VIDEO 2 jack

You can connect a video deck or the like to these jacks and perform video playback and recording. The initial factory setting is "VIDEO 2".

#### Use as a MONITOR jack

You can connect a cassette deck or the like to these jacks and make use of the deck's monitoring function during recording. Alternately, you can connect a graphic equalizer to these jacks to apply compensation to the music signal.

To use the VIDEO 2/MONITOR jacks as MONITOR jacks, hold down the MONITOR key of the main unit for more two seconds so that the indication shown below appears.

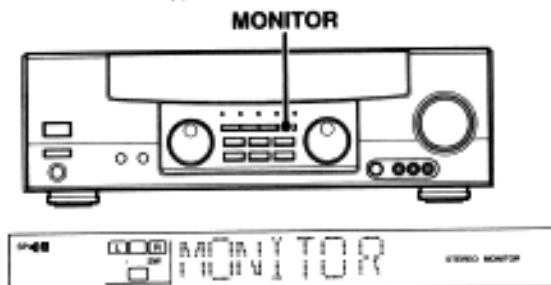

- At the same time the setting is switched to "MONITOR," the audio input source switches to tuner and the video input source switches to VIDEO 1.
- To switch the setting back to "VIDEO 2," once again hold down the MONITOR key for two seconds or more.

### Notes

1. Be sure to insert all connection cords securely. If their connections are imperfect, the sound may not be produced or noise may interfere.
2. Be sure to remove the power cord from the AC outlet before plugging or unplugging any connection cords. Plugging/unplugging connection cords without disconnecting the power cord can cause malfunctions and may damage the unit.
3. Do not connect power cords from components whose power consumption is larger than what is indicated on the AC outlet at the rear of this unit.

### Analog connections

Audio connections are made using RCA pin cords. These cables transfer stereo audio signal in an "analog" form. This means the audio signal corresponds to the actual audio of two channels. These cables usually have 2 plugs each end, one red for the right channel and one white for the left channel. These cables are usually packaged with the source unit, or are available at your local electronics retailer.

## Connecting audio components

### Shape of AC outlets

U.S.A. and Canada	
Australia	
Other countries	

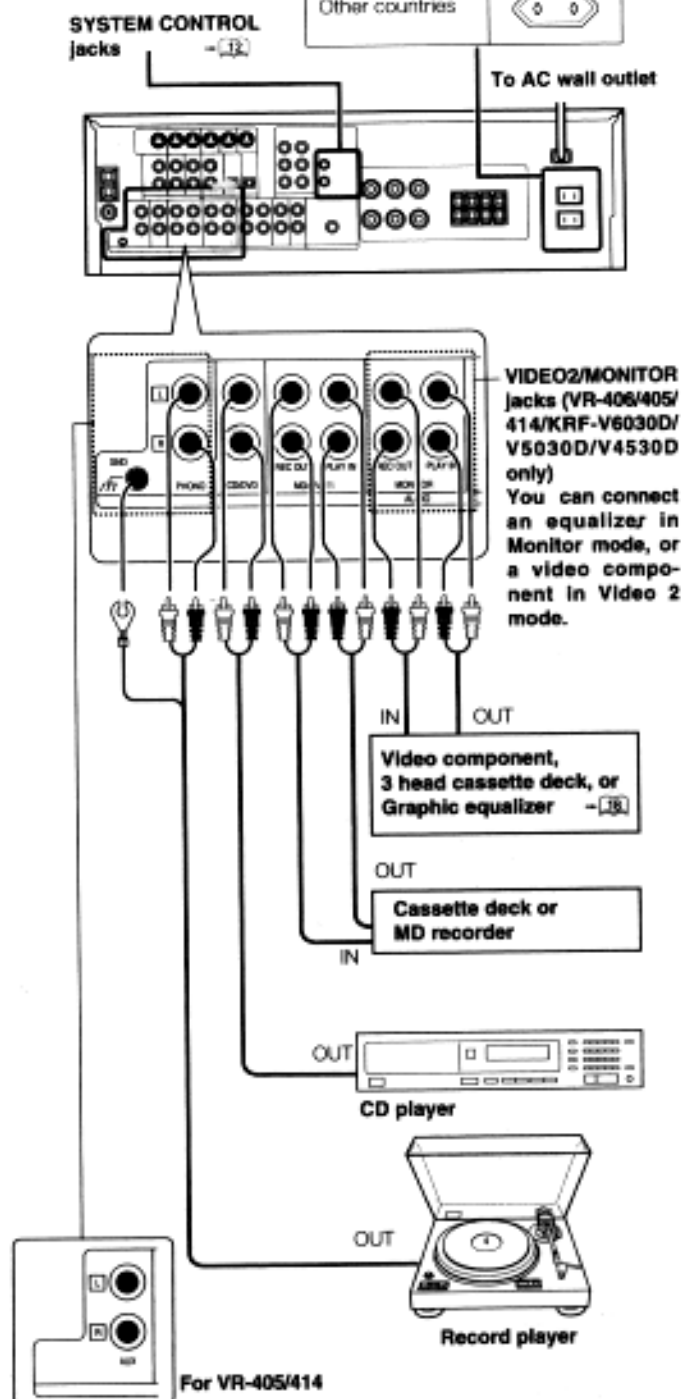

When you connect the video component to the VIDEO 2/MONITOR jacks, connect the video cord (yellow RCA pin cords) of the connected component to the VIDEO 2 IN jack (VR-406/405/414/KRF-V6030D/V5030D/V4530D only).



## Connecting video components

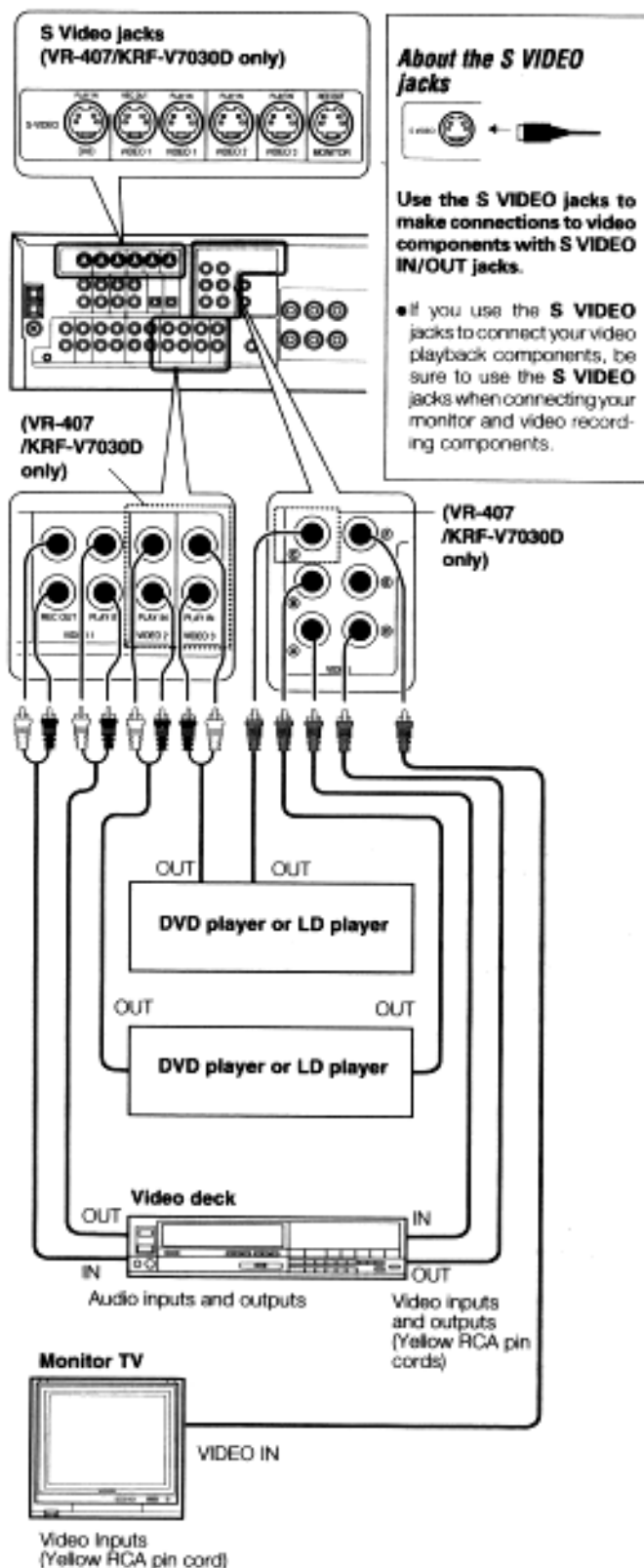

**A video component with digital audio outputs should be connected to the VIDEO2 or VIDEO3 (VR-407/KRF-V7030D only) jacks.**

## Connecting a DVD player (6-channel input) (VR-407/406/KRF-V7030D/V6030D/V5030D/V4530D only)

If you have connected a DVD player to the receiver with digital connection, be sure to read the "Input mode settings" section on the following page carefully.

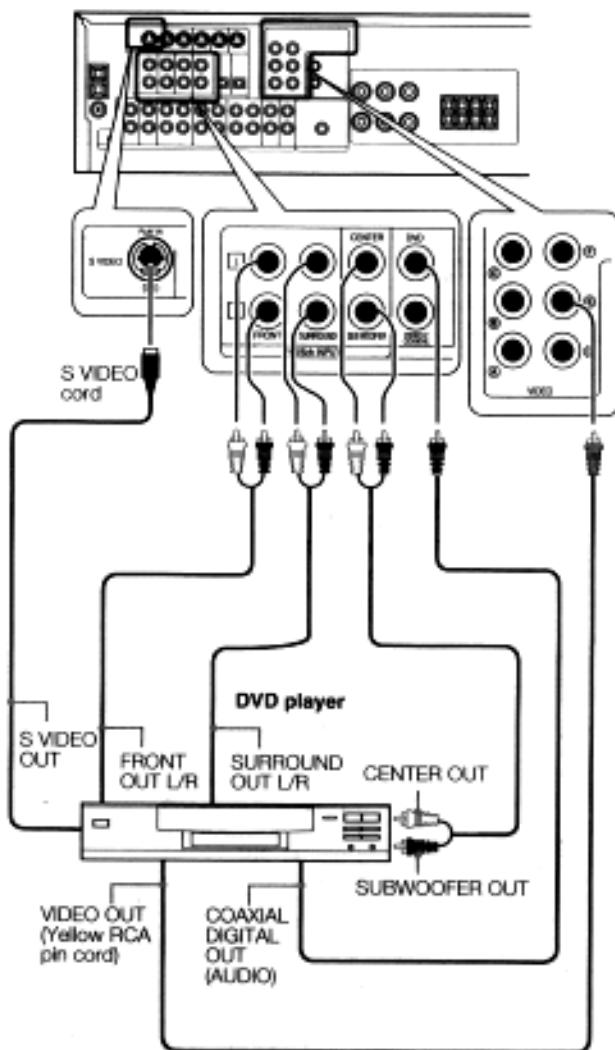

To switch the speakers off, press the MUTE key.

### CAUTION (Except for U.S.A. and Canada)

Be sure to adhere followings. Or proper ventilation will be blocked causing damage or fire hazard.

- Install the VR-407/406/405/414/KRF-V7030D/V6030D/V5030D/V4530D on the top of the system.
- Do not place any objects impairing heat radiation onto the top of unit.
- Leave a space around the unit (from the largest outside dimension including projection) equal or greater than, shown below.

Top panel : 50 cm      Side panel : 10 cm      Back panel : 10 cm

### CAUTION (For U.S.A. and Canada)

Be sure to adhere followings. Or proper ventilation will be blocked causing damage or fire hazard.

- Install the VR-407/406/405/414/KRF-V7030D/V6030D/V5030D/V4530D on the top of the system.
- Do not place any objects impairing heat radiation onto the top of unit.

## Digital connections

The digital in jacks can accept DTS, Dolby Digital (AC-3), or PCM signals. Connect components capable of outputting DTS, Dolby Digital (AC-3), or standard PCM (CD) format digital signals.

If you have connected any digital components to the receiver, be sure to read the "Input mode settings" section on this page carefully.

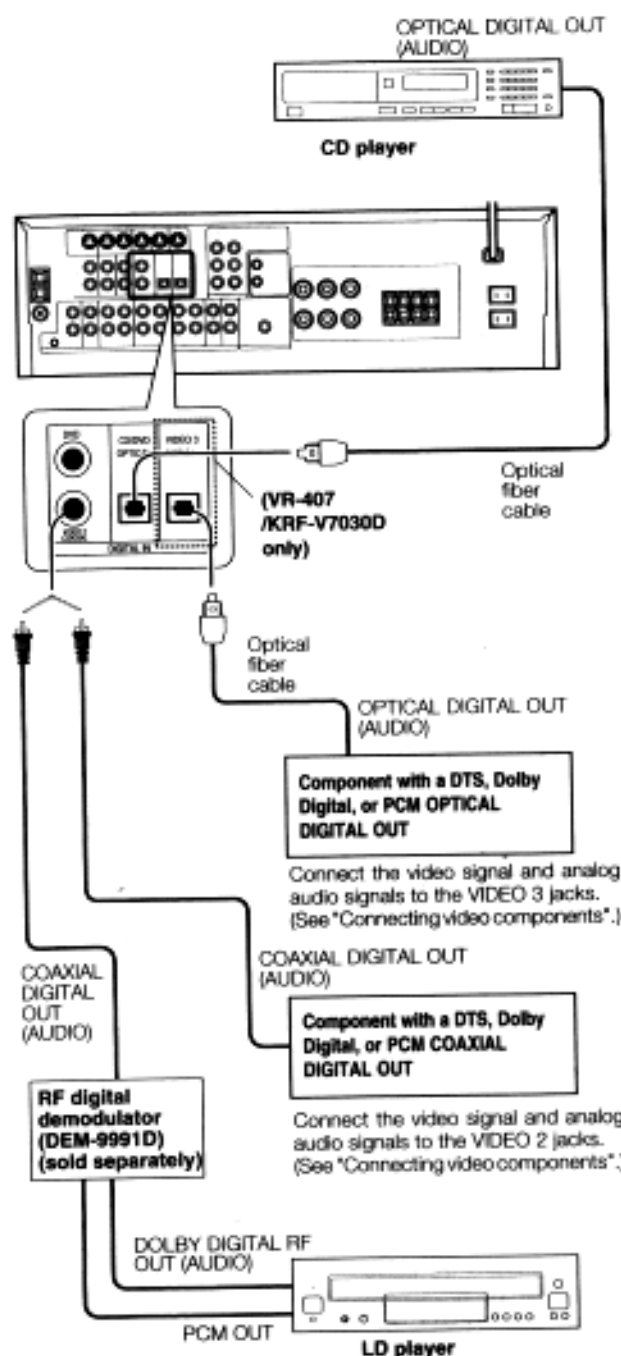

To connect an LD player with a DIGITAL RF OUT, connect the LD player to the KENWOOD RF digital demodulator (DEM-9991D). Next, connect the DIGITAL OUT jacks of the demodulator to the DIGITAL IN jacks of the receiver.

Connect the video signal and analog audio signals to the VIDEO 2 or VIDEO 3 (VR-407/KRF-V7030D only) jacks. (See "Connecting video components".)

## Input mode settings

**CD, DVD, VIDEO2 and VIDEO3** (VR-407/KRF-V7030D only) inputs each include jacks for digital audio input and analog audio input. You must select beforehand which type of input is to be used for each connected component.

**The initial factory setting is to use the digital audio signal for playback (CD, DVD, VIDEO2, VIDEO3).**

To use the analog audio input for playback instead (if, for example, you have connected a VCR to the VIDEO2 or VIDEO3 input), you must set the input mode for the corresponding input to the analog mode. After completing connections and turning on the receiver, follow the steps below.

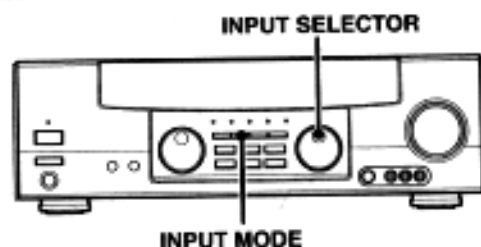

- Use the **INPUT SELECTOR** knob to select **CD, DVD, VIDEO2, or VIDEO3**.
- Press the **INPUT MODE** key.

Each press switches the setting as follows:

**In DTS play mode (VR-407/KRF-V7030D only)**

- D-AUTO** (digital input, auto sound)
- D-MANUAL** (digital input, manual sound)

**In DVD play mode**

- D-AUTO** (digital input, auto sound)
- D-MANUAL** (digital input, manual sound)
- 6CH INPT** (DVD 6CH input)
- ANALOG** (analog input, manual sound)

**In other mode than DTS or DVD play mode**

- D-AUTO** (digital input, auto sound)
- D-MANUAL** (digital input, manual sound)
- ANALOG** (analog input, manual sound)

### Digital input:

Select this setting to play digital signals from a DVD, CD, or LD player.

### Analog input:

Select this setting to play analog signals from a cassette deck, VCR, or turntable.

### Auto sound:

In the auto sound mode (**AUTO SOUND** indicator lights), the receiver selects the listening mode automatically during playback to match the type of input signal (Dolby Digital, PCM, DTS) and the speaker setting. The initial factory setting is auto sound on.

To keep the receiver set to the currently selected listening mode, use the **INPUT MODE** key to select "**D-MANUAL**" (manual sound). However, even when this setting is selected, there may be cases in which the listening mode is selected automatically to match a Dolby Digital source signal depending on the combination of listening mode and source signal.

## Connecting to the AUX IN jacks (VR-407/KRF-V7030D only)

The **AUX IN** jacks are convenient for connection of video components such as a camcorders and video games.

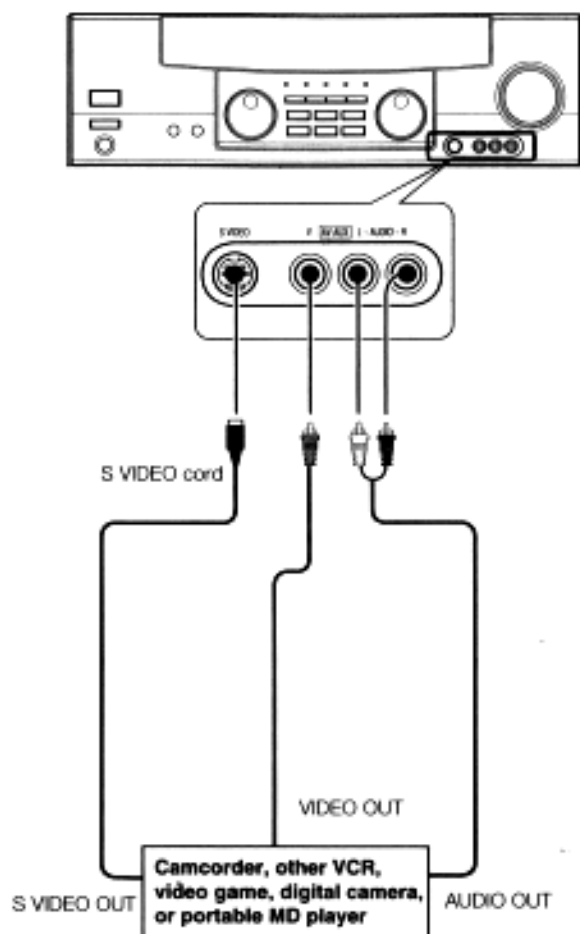

- To select the source connected to the AUX IN jacks, select AV AUX by using the INPUT SELECTOR knob. 
- When you connect the audio source such as the MD player, you do not need to connect the video cable.
- When you connect the unit and the component with the S VIDEO cord, you can get better picture quality.

## Connecting the antennas

### AM loop antenna

The supplied loop antenna is for use indoors. Place it as far as possible from the receiver, TV set, speaker cords and power cord, and adjust the direction for best reception.

#### AM antenna terminal connections

- 1 Push lever.
- 2 Insert cord.
- 3 Return lever.



### FM indoor antenna

The supplied indoor antenna is for temporary use only. For stable signal reception we recommend using an outdoor antenna. Disconnect the indoor antenna when you connect one outdoors.

### FM outdoor antenna

Lead the 75Ω coaxial cable connected to the FM outdoor antenna into the room and connect it to the FM 75Ω terminal.

#### FM antenna terminal connections

- Insert cord.

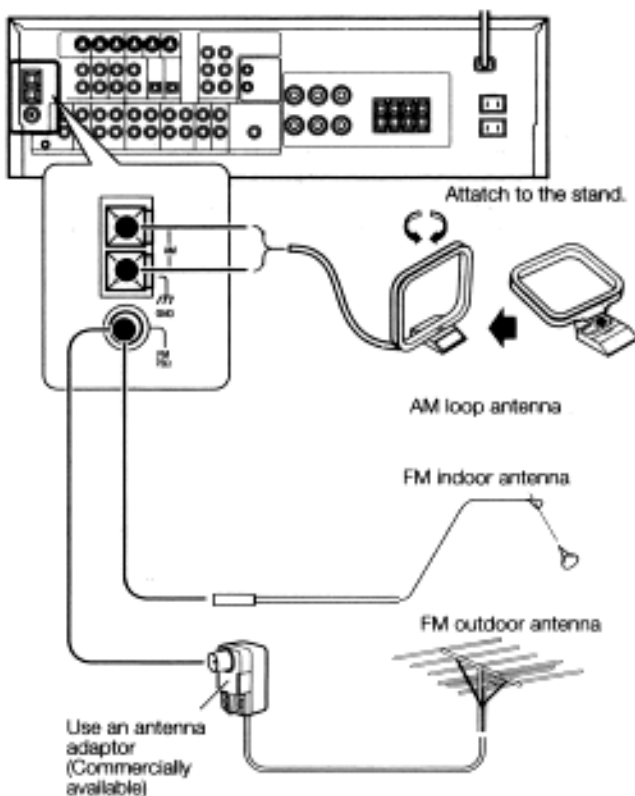

## Connecting the system control

Connecting system control cords after connecting a KENWOOD audio component system lets you take advantage of convenient system control operations.

This unit is compatible only with the [SL16] mode. The system control operation is not available if the unit is connected in the [XS8], [XS], or [XR] connection mode.

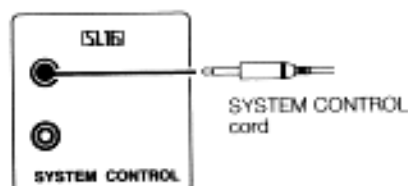

### EXAMPLE: [SL16] mode connections

The underlined portion represents the setting of the system control mode.

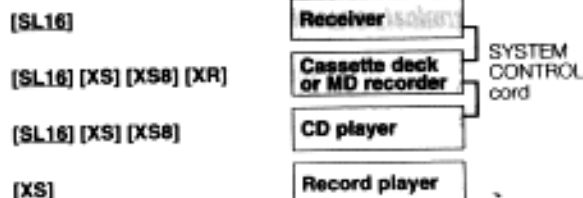

This unit does not support the [XS 8] mode.

- In order to take advantage of the system control operations, the components must be connected to the correct jacks. To use a CD player it must be connected to the CD jacks. To use a cassette deck (or MD recorder) it must be connected to the MD/TAPE jacks. When using more than one CD player (etc.) only the one connected to the specified jacks may be connected for system control.
- Some CD players and cassette decks are not compatible with the [SL16] system control mode. Do not make system connections with equipment that is not [SL16] compatible.
- Some MD players are not system control compatible. You cannot make system control connections to this kind of equipment.

### Notes

1. [SL16] equipment cannot be combined with [XR], [XS], and [XS8] equipment for system operations. If your equipment consists of this kind of combination, please do not connect any system control cords. Even without system control cords, normal operations can be carried out without effecting performance.
2. Do not connect system control cords to any components other than those specified by KENWOOD. It may cause a malfunction and damage your equipment.
3. Be sure the system control plugs are inserted all the way in to the system control terminals.

Do not connect a system control cord to a cassette deck connected to the VIDEO2/MONITOR jacks.

### SYSTEM CONTROL OPERATIONS

#### Remote Control

Lets you operate this unit with the system remote supplied with the receiver.

#### Automatic Operation

When you start playback from a source component, the input selector on this unit switches to that component automatically.

#### Synchronized Recording

Lets you synchronize recording with the start of playback when recording from CD, MD or analog discs.

### Registering setup codes for KENWOOD audio components (VR-407/406/KRF-V7830D/V6030D only)

- Once you finish making the system connections, be sure to register the appropriate setup code for each component. RC-[ ]
- If you own remote controllable KENWOOD audio components that are not compatible with system control, registering the setup code enables you to control those components using the remote control supplied with this unit (without connecting system control cords). To register setup codes for your remote controllable KENWOOD audio components, see "Registering setup codes for other components". RC-[ ]

## Connecting the speakers

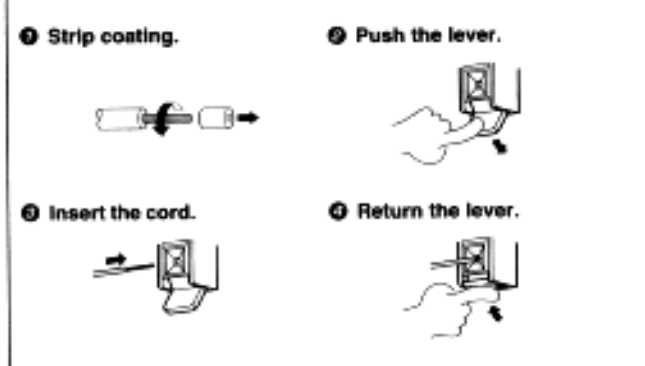
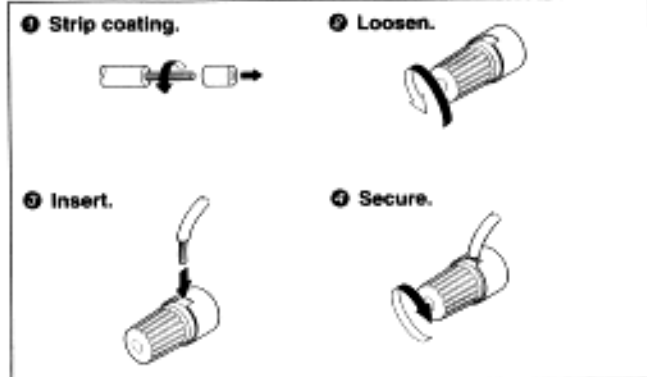

### Connection of banana plugs (For U.S.A. and Canada)

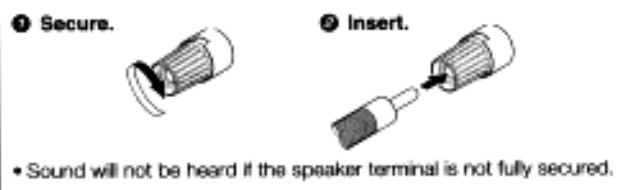

- Never short circuit the + and - speaker cords.
- If the left and right speakers are connected inversely or the speaker cords are connected with reversed polarity, the sound will be unnatural with ambiguous acoustic imaging. Be sure to connect the speakers correctly.

### Speaker impedance

After confirming the speaker impedance indications printed on the rear panel of the receiver, connect speakers with matching impedance ratings. Using speakers with a rated impedance other than that indicated on the rear panel of the receiver could result in malfunctions or damage to the speakers or receiver.

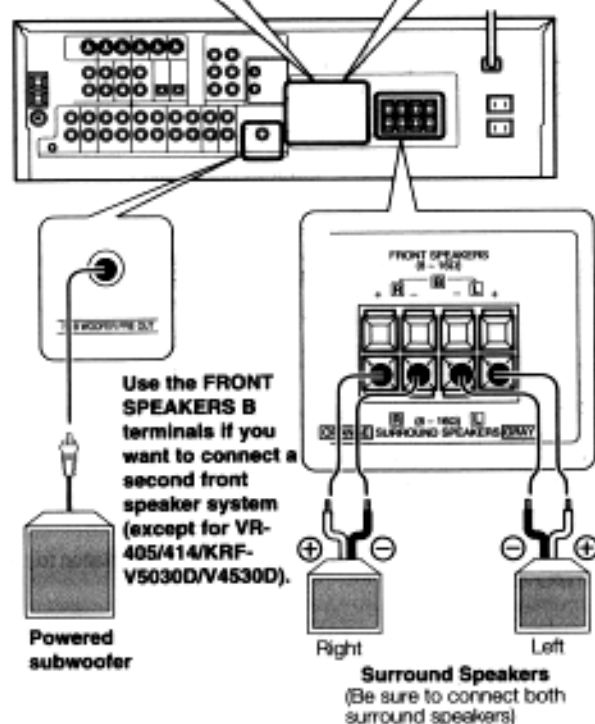
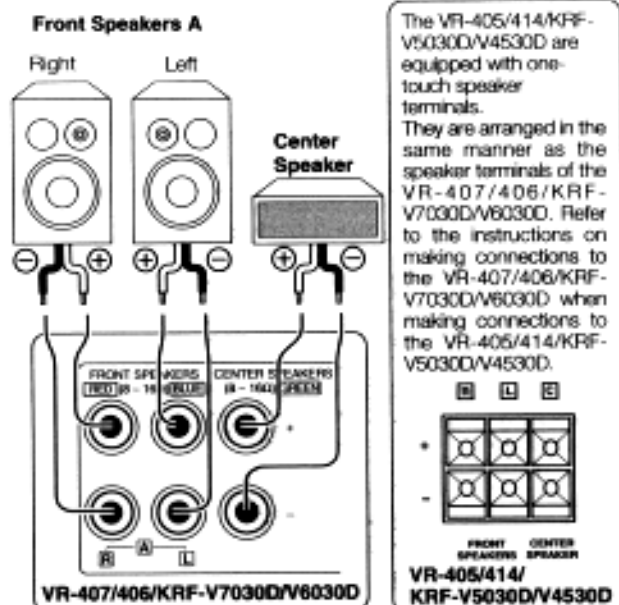

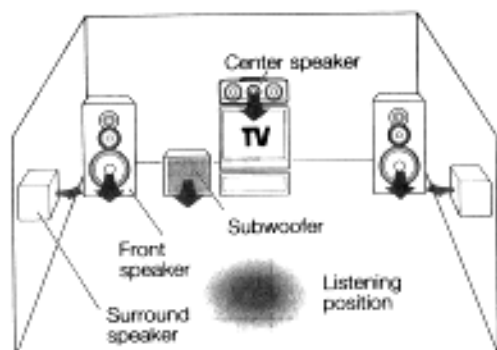
**Speaker placement**

**Front speakers:** Place to the front left and right of the listening position. Front speakers are required for all surround modes.

**Center speaker:** Place front and center. This speaker stabilizes the sound image and helps recreate sound motion. Be sure to connect a center speaker when using the Dolby 3 Stereo mode.

**Surround speakers:** Place to the direct left and right, or slightly behind, the listening position at even heights, approximately 1 meter above the ears of the listeners. These speakers recreate sound motion and atmosphere. Required for surround playback.

**Subwoofer:** Reproduces powerful deep bass sounds.

- Although the ideal surround system consists of all the speakers listed above, if you don't have a center speaker or a subwoofer, you can divide those signals between the available speakers in the speaker settings steps to obtain the best possible surround reproduction from the speakers you have available.

- [5]

**Channel space switching***(Except for the USA, Canada, UK, Europe, and Australia)*

The space between radio channels has been set to the one that prevails in the area to which the system is shipped. However, if the current channel space setting does not match the setting in the area where the system is to be used, for instance when you move from area 1 or area 2 shown in the following table or vice versa, proper reception of AM/FM broadcasts cannot be expected. In this case, change the channel space setting in accordance with your area by referring to the following table.

Area	CHANNEL Space Frequency
1 USA, Canada and South American countries	FM: 100 kHz AM: 10 kHz
2 Other countries	FM: 50 kHz AM: 9 kHz

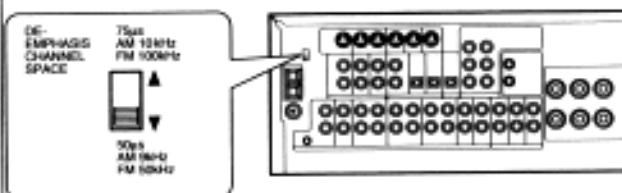

Move switch lever to match your area with a small screwdriver or other pointed tool.

**Preparing the remote control****Loading the batteries**

❶ Remove the cover.



❷ Insert the batteries.

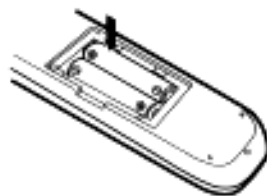

❸ Close the cover.



- Insert two AA-size (R6) batteries as indicated by the polarity markings.

**Operation**

When the **STANDBY** indicator is lit, the power turns ON when you press the **POWER** key on the remote control. When the power comes ON, press the key you want to operate.

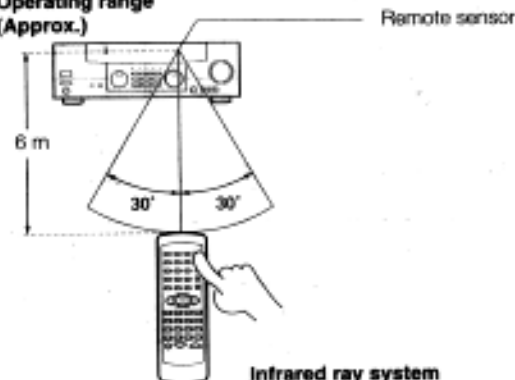
**Operating range (Approx.)****Infrared ray system**

- When pressing more than one remote control key successively, press the keys securely by leaving an interval of 1 second or more between keys.

**Notes**

- The supplied batteries may have shorter lives than ordinary batteries due to use during operation checks.
- When the remote-controllable distance gets shorter than before, replace both batteries with new ones.
- Placing the remote sensor in direct sunlight, or in direct light from a high frequency fluorescent lamp may cause a malfunction. In such a case, change the location of the system installation to prevent malfunction.

## Speaker settings

To enable you to obtain optimum enjoyment from the receiver's listening modes, make sure to complete the speaker settings (subwoofer, front, center, and surround speakers) as described below.

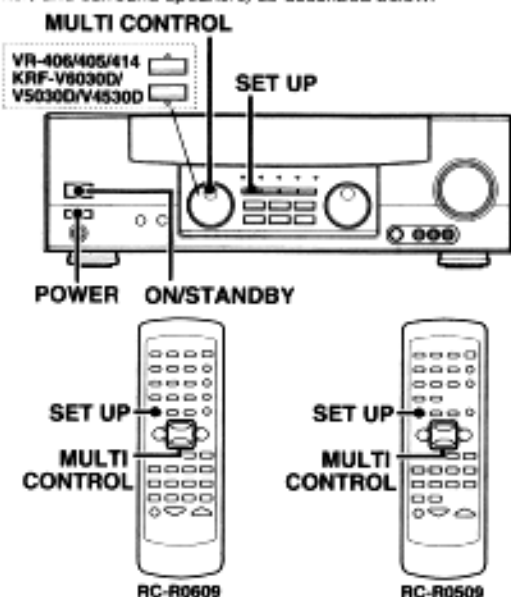

**1** Turn on the power to this receiver by pressing **POWER** (and **ON/STANDBY**) key(s).

**2** Select a speaker system.

**1** Press the **SET UP** key to make the subwoofer setting indication (**SUBW**) appear.

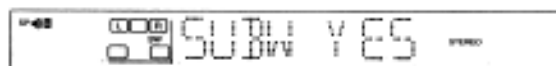

**2** Use the **MULTI CONTROL** to select the appropriate subwoofer setting.

- ① **SUBW YES**: A subwoofer is connected to the receiver.
- ② **SUBW NO**: No subwoofer is connected to the receiver.

• When the setting "SUBW NO" is selected, the front speakers automatically are set to "Large" and the procedure skips to step **3**.

**3** Press the **SET UP** key to accept the setting.

• The front speakers setting indication (**FRNT**) appears.

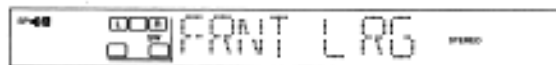

**4** Use the **MULTI CONTROL** to select the appropriate front speakers setting.

- ① **FRNT NML** (normal): Average size front speakers are connected to the receiver.
- ② **FRNT LRG** (large): Large front speakers are connected to the receiver.

**5** Press the **SET UP** key to accept the setting.

• The center speaker setting indication (**CNTR**) appears.

**6** Use the **MULTI CONTROL** to select the appropriate center speaker setting.

If you selected "LRG" as the front speakers setting.

- ① **CNTR LRG** (large): A large center speaker is connected to the receiver.
- ② **CNTR NML** (normal): An average size center speaker is connected to the receiver.
- ③ **CNTR NO**: No center speaker is connected to the receiver.

If you selected "NML" as the front speakers setting.

- ① **CNTR YES**: A center speaker is connected to the receiver.
- ② **CNTR NO**: No center speaker is connected to the receiver.

**7** Press the **SET UP** key to accept the setting.

• The surround speaker setting indication (**SURR**) appears.

**8** Use the **MULTI CONTROL** to select the appropriate surround speaker setting.

If you selected "LRG" as the center speaker setting.

- ① **SURR LRG** (large): Large surround speakers are connected to the receiver.
- ② **SURR NML** (normal): Average size surround speakers are connected to the receiver.
- ③ **SURR NO**: No surround speakers are connected to the receiver.

If you selected other than "LRG" as the center speaker setting.

- ① **SURR YES**: Surround speakers are connected to the receiver.
- ② **SURR NO**: No surround speakers are connected to the receiver.

**9** Press the **SET UP** key to accept the setting.

• The receiver enters the speaker volume level adjustment mode.  
• In steps **2** and **3**, indications appear only for the selected channels of the speakers that require adjusting.

**3** Adjust the volume levels for the speakers.

Sit in your normal listening position and listen to the test tone. Adjust the volume levels for the speakers until all speakers seem to be equally loud.

**1** Use the **MULTI CONTROL** to adjust the volume when the test tone is being output from the speaker channel to be adjusted.

The channel indication blinks while the test tone is being output.

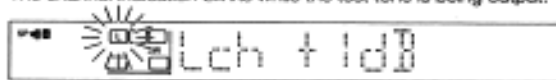

The test tone issues from the speakers for 2 seconds at a time in the following sequence:

**Lch** → **Cch** → **Rch** → **RS** → **LS** → **SW** → **Lch**

• If you change the volume level settings for the speakers while listening to music, the settings referred to on this page are also changed.

• If the speaker setting selects are changed, the speaker level settings are reset.

**2** Press the **SET UP** key.

• The receiver enters the mode for inputting the distance to the speakers.

## 4 Input the distance to the speakers.

- 1 Measure the distance from the listening position to each of the speakers.

Jot down the distance to each of the speakers.

Distance to front speakers: \_\_\_\_\_ feet (meters)  
 Distance to center speaker: \_\_\_\_\_ feet (meters)  
 Distance to surround speakers: \_\_\_\_\_ feet (meters)

- 2 Use the MULTI CONTROL to select the distance to the front speakers.

The speaker indicator to be adjusted blinks.

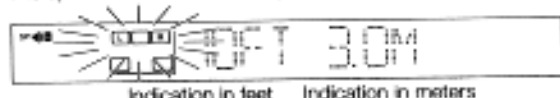

- The allowable setting range is 1 to 30 feet (0.3 to 9.0 m), adjustable in 1 foot (0.3 m) increments.

- 3 Press the SET UP key.
- 4 Repeat steps 2 and 3 to input the distance for each of the speakers.
- 5 Setup is complete when the input indication reappears.



Display when all speakers have been selected.

- The speakers you selected appear on the display. Confirm that all the speakers have been correctly selected.

## Input level adjustment (analog sources only)

If the input level of an analog source signal is too high, adjust the input level.

- 1 Use the INPUT SELECTOR knob to select the source whose input level you want to adjust.
- You can store a separate input level for each input source. If the MONITOR function is on, you can store an input level for when MONITOR is on independently of the input levels for the input sources.
- 2 Press the SOUND key several times until the "INPUT" indication appears.
- 3 Use the MULTI CONTROL to adjust the input level.

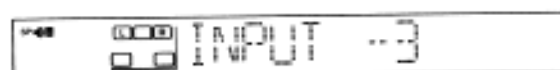

- The adjustment mode is displayed for approximately eight seconds.
- The input level may be adjusted to any one of three settings: 0, -3, and -6. (The initial setting is 0.)

- 4 Press the SOUND key to return to the input indication.

## Preparing for playback

Some preparatory steps are needed before starting playback.

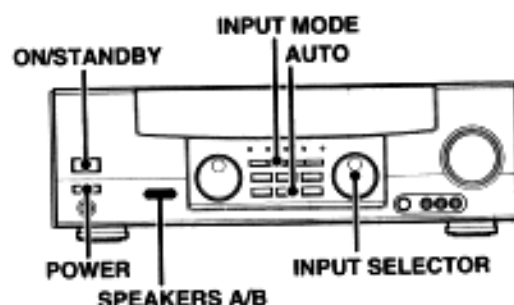

## Selecting the input mode

If you have selected a component connected to the CD, DVD, VIDEO2, or VIDEO3 (VR-407/KRF-V7030D only) jacks, make sure that the input mode setting is correct for the type of audio signal to be used.

## Selecting MD/TAPE

Select the source name corresponding to the component connected to the MD/TAPE jacks. The initial factory setting is "TAPE". To change the source name associated with the MD/TAPE jacks to "MD," follow the steps below:

- Use the INPUT SELECTOR knob to select "MD/TAPE".
- Hold down the AUTO key for more than 2 seconds.
  - The source indication changes to "MD".
  - To return to the original indication, repeat the above procedure.
  - You also will need to change the name input to the remote control to "MD".

## Selecting the speaker system (except for VR-405/414/KRF-V5030D/V4530D)

Press the SPEAKERS A or B key to select the speaker system to be used.

- A ON** : Sound from the speakers connected to the SPEAKERS A terminals on the rear panel.
- B ON** : Sound from the speakers connected to the SPEAKERS B terminals on the rear panel.
- A+B ON** : Sound from both the speakers connected to the SPEAKERS A and B terminals on the rear panel.
- A+B OFF** : No sound from the speakers. Use this setting when listening with headphones for stereo sound and virtual surround in all playback modes.

The indicator for the speakers you want to use should be lit.

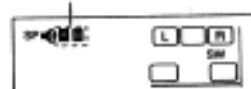

VR-407/406/  
KRF-V7030D/V6030D

The speaker indicator lights.

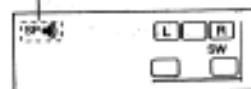

VR-405/414/  
KRF-V5030D/V4530D

- Activating a surround mode or selecting "DVD/6ch" as the input source causes speaker system A to be selected automatically.

On the VR-405/414/KRF-V5030D/V4530D, press the SPEAKER key to switch the speakers on and off.

## Turning on the receiver

- Turn on the power to the related components.
- Turn on the power to this receiver by pressing POWER (and ON/STANDBY) key(s).



## Listening to a source component

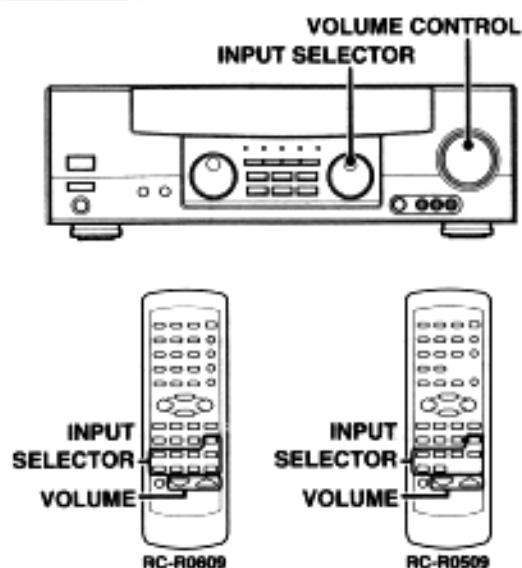

- 1 Use the **INPUT SELECTOR** to select the source you want to listen to.

The input sources change as shown below:

Selecting a source using the **INPUT SELECTOR** knob

VR-407/KRF-V7030D

- ① "PHONO"
- ② TUNER
- ③ "CD/DVD"
- ④ "TAPE" or "MD"
- ⑤ "VIDEO1"
- ⑥ "VIDEO2"
- ⑦ "VIDEO3"
- ⑧ "DVD/6ch"
- ⑨ "AV AUX"

VR-406/405/414/KRF-V6030D/V5030D/V4530D

- ① "PHONO" (VR-406/KRF-V6030D/V5030D/V4530D)  
or
- ① "AUX" (VR-405/414)
- ② TUNER
- ③ "CD/DVD"
- ④ "TAPE" or "MD"
- ⑤ "VIDEO1"
- ⑥ "VIDEO2"
- ⑦ "DVD/6ch" (VR-406/KRF-V6030D/V5030D only)

- 2 Start playback from the selected source.

- 3 Use the **VOLUME CONTROL** knob (**VOLUME** keys) to adjust the volume.

### Selecting VIDEO 2/MONITOR (except for VR-407/KRF-V7030D)

Depending on the component connected to the **VIDEO 2/MONITOR** jacks, select either the "VIDEO 2" setting or the "MONITOR" setting, as appropriate.

## Adjusting the sound

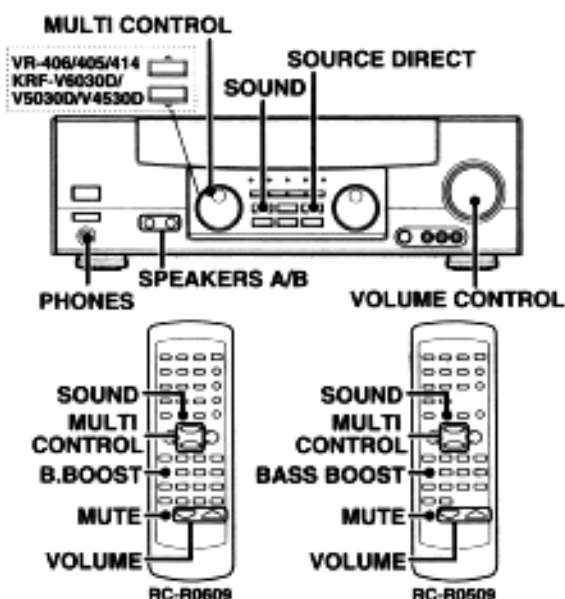

### Adjusting the tone

You can adjust the sound quality when the receiver is in the PCM stereo and analog stereo mode.

- 1 Press the **SOUND** key to select the tone mode to be adjusted.

**BASS:** Select this to adjust the low frequency range.

(Press the **SOUND** key once.)

**TREB:** Select this to adjust the high frequency range.

(Press the **SOUND** key twice.)

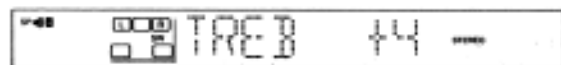

- 2 Use the **MULTI CONTROL** to adjust the sound quality.

- The bass and treble levels are adjustable from -10 to +10 in 2 step increments.
- The adjustment item is displayed for approximately 8 seconds.

### Once-touch low frequency emphasis (bass boost)

You can adjust the sound quality when the receiver is in the PCM stereo and analog stereo mode.

Press the **B. BOOST (BASS BOOST)** key.

- Press the key once to select the maximum (+10) low frequency emphasis setting.
- This key does not function when the receiver is in the sound quality or ambience effects adjustment mode.

### Switching back to the previous setting

Press the **B. BOOST (BASS BOOST)** key again.

**Muting the sound**

The **MUTE** key lets you mute the sound of the speakers.

Press the **MUTE** key.



Blinks

**To cancel**

Press the **MUTE** key again so that the "MUTE" indicator goes off.

- Muting can also be canceled by adjusting the volume.

**SOURCE DIRECT playback (analog sources only)**

Use this function to pass the source material direct to the amplifier, bypassing any audio processing.

Press the **SOURCE DIRECT** key.



- When you press the **LISTEN MODE**, **SOUND**, or **SET UP** keys, or switch to another input source, **SOURCE DIRECT** playback will be canceled.

**To cancel**

Press the **SOURCE DIRECT** key again.

- If **SOURCE DIRECT** playback was activated when using a surround mode, cancelling it reactivates the previous surround mode.

**Listening with headphones****1 (VR-407/406/KRF-V7030D/V6030D)**

Press the **SPEAKERS A** or **B** key so that the speaker indicator goes off.

**(VR-405/414/KRF-V5030D/V4530D)**

Press the **SPEAKER** key so that the speaker indicator goes off.

Make sure the **SPEAKERS** indicators are turned off.

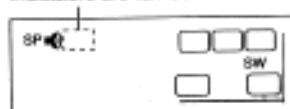

VR-407/406/  
KRF-V7030D/V6030D

Make sure the **SPEAKER** indicators are turned off.

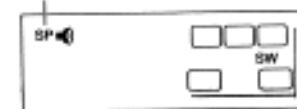

VR-405/414/  
KRF-V5030D/V4530D

- If you turn off all of the speakers when in the surround mode, the mode is cancelled as well, resulting in stereo playback.
- The speakers do not switch off during the **6CH INPUT** mode. Select the other input mode.

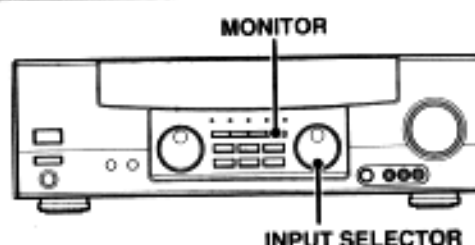
**2 Connect headphones to the PHONES jack.****3 Use the VOLUME CONTROL (VOLUME) to adjust the volume.****Recording****Recording audio (analog sources)****Recording a music source**

When recording a music source, switch the **VIDEO2/MONITOR** setting to "MONITOR" (VR-406/405/414/KRF-V6030D/V5030D/V4530D only).

- Use the **INPUT SELECTOR** knob to select the source (other than "TAPE") you want to record.
- Set the cassette deck to record.
- Start playback, then start recording.

**Recording tapes or MD**

When recording a music source, switch the **VIDEO2/MONITOR** setting to "MONITOR" (VR-406/405/414/KRF-V6030D/V5030D/V4530D only).

**MONITOR → MD/TAPE recording**

- Press the **MONITOR** key.

STEREO MONITOR

- Use the **INPUT SELECTOR** knob to select a source other than "MD/TAPE."
- Start playback on the cassette deck connected to the **MONITOR** jacks and start recording on the cassette deck connected to the **MD/TAPE** jacks.

**MD/TAPE → MONITOR recording**

- Use the **INPUT SELECTOR** knob to select "MD/TAPE."
- Start playback on the cassette deck connected to the **MD/TAPE** jacks and start recording on the cassette deck connected to the **MONITOR** jacks.

- To copy tapes using a double cassette deck, refer to the instruction manual of the double cassette deck.

**MONITOR function (analog sources only)**

You can connect a cassette deck or graphic equalizer to the **VIDEO2/MONITOR** jacks of the receiver. If a graphic equalizer is connected, the **MONITOR** key should be left in the on position. Alternately, if a cassette deck equipped with a 3-head system is connected to the **VIDEO2/MONITOR** jacks, you will be able to monitor the just-recorded signal while making recordings on the cassette deck. By switching the **MONITOR** key on and off, you can compare the sound of the source signal and the just-recorded signal. For more information, refer to the instruction manual of the connected component.

## Recording video

- Use the **INPUT SELECTOR** to select the video source (other than "VIDEO1") you want to record.
- Set the video deck connected to **VIDEO 1** to record.
  - Select the **REC MODE** to record a digital input source.
- Start playback, then start recording.
  - With certain video software, recording may not be normal due to the copy guard condition. - [28]

## Recording audio (digital sources)

Switch on the **REC MODE** to record a digital input source. Usually use the **A-REC MODE** to record audio input sources. When the digital mode changes during recording in the **A-REC MODE**, the audio may be interrupted momentarily. To record the audio from the beginning of the digital mode change, use the **M-REC MODE**. With a model that is not compatible with DTS, no audio is reproduced even when the DTS signals are input.

## Recording music in A-REC MODE

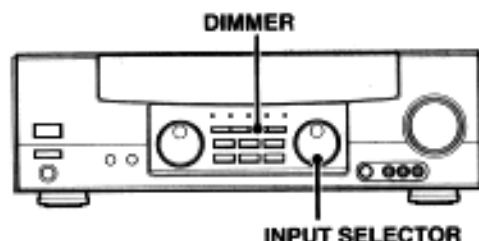

- Use the **INPUT SELECTOR** to select the source (CD, DVD, VIDEO2, or VIDEO3) you want to record.
- Set the cassette deck to record.
- Press and hold the **DIMMER** key for more than 2 seconds to select the **A-REC MODE**.
  - The mode changes every 2 seconds as shown below.

- ① **REC MODE off** : The digital input record mode is switched off.
- ② **A-REC MODE** : The digital input signals (DTS, Dolby Digital, or PCM) are identified automatically and converted into stereo signals that are ready for recording.
- ③ **M-REC MODE** : The input signal type at the moment this mode is selected is held throughout this mode.

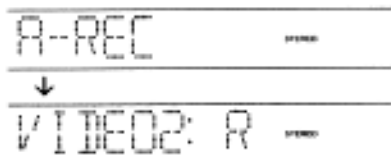

- Start playback, then start recording.
  - If the audio reproduction stops in the middle due to change in the input signals, etc., press the **DIMMER** key.

## Recording music in M-REC MODE

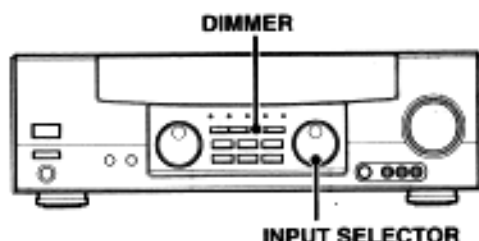

- Use the input selector to select the source (CD, DVD, VIDEO2, or VIDEO3) you want to record.
- Set the cassette deck to record.
- Play the source to be recorded.
- Press and hold the **DIMMER** key for more than 2 seconds to select the **M-REC MODE**. The mode changes every 2 seconds as shown below.

- ① **REC MODE off** : The digital input record mode is switched off.
- ② **A-REC MODE** : The digital input signals (DTS, Dolby Digital or PCM) are identified automatically and converted into stereo signals that are ready for recording.
- ③ **M-REC MODE** : The input signal type at the moment this mode is selected is held throughout this mode.

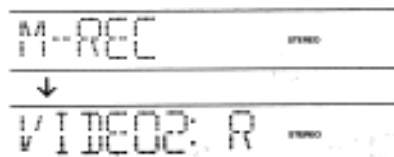

- Play the source from the beginning and start recording.
  - If the audio reproduction stops in the middle due to change in the input signals, etc., press the **DIMMER** key.

# Listening to radio broadcasts

The receiver can store up to 40 stations in the memory and recall them by one-touch operation.

## Tuning radio stations

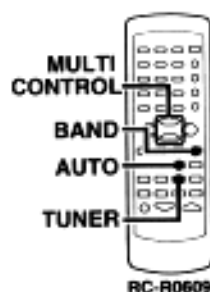
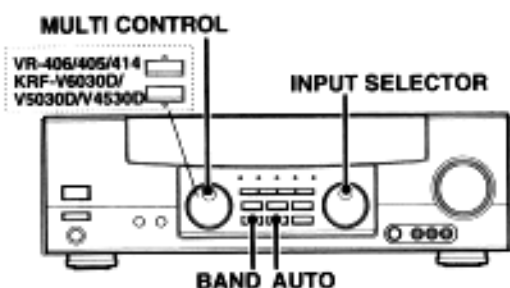

**1** Use the **INPUT SELECTOR** or **TUNER** key to select the tuner.

**2** Use the **BAND** key to select the desired broadcast band.

Each press switches the band as follows:

- ① FM
- ② AM



**3** Use the **AUTO** key to select the desired tuning method.

Each press switches the tuning method as follows:

- ① **AUTO** lit (auto tuning)
- ② **AUTO** not lit (manual tuning)

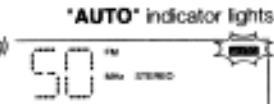

• Normally, set to "AUTO" (auto tuning). If the radio waves are weak and there is a lot of interference, switch to manual tuning. (With manual tuning, stereo broadcasts will be received in monaural.)

**4** Use the **MULTI CONTROL** to select the station.



- Auto tuning** : The next station is tuned automatically.
- Manual tuning** : Turn the knob (press the key) to select the desired station.

## Presetting radio stations manually

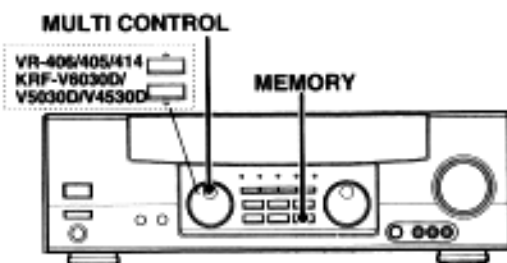

**1** Tune to the station you want to store.

**2** Press the **MEMORY** key while receiving the station.

Blinks for 5 seconds

Lights for 5 seconds



Proceed to step **3** within 5 seconds. (If more than 5 seconds elapse, press the **MEMORY** key again).

**3** Use the **MULTI CONTROL** to select one of the station presets (1 - 40).

**4** Press the **MEMORY** key to accept the setting.

- Repeat steps **1**, **2**, **3**, and **4** to store as many stations as necessary.
- If you store a station at a previously used preset, the old station will be replaced by the new one.

## Receiving preset stations



**1** Press **TUNER** to select the tuner as the source.

**2** Enter the number of the preset you want to receive (up to "40").

Press the numeric keys in the following order:

- For "15", press ..... **+10**, **5**
- For "20", press ..... **+10**, **+10**, **0**

• If you make a mistake entering a two digit number, press the **+10** key several times to return to the original display and start again.

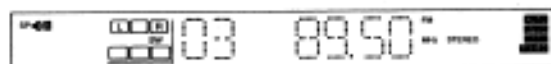

## Receiving preset stations in order (P.CALL)

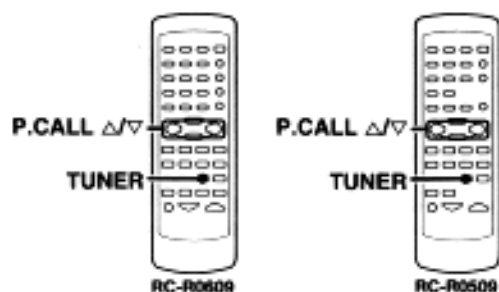

**1** Press **TUNER** to select the tuner as the source.

**2** Use the **P.CALL** key to select the desired station.

- Each time you press the key, another preset station is received in order.

Pressing the **P.CALL** ( $\Delta$ ) key does the following:

01→02→03→ ..... 38→39→40→01→02→03→

Pressing the **P.CALL** ( $\nabla$ ) key does the following:

01←02←03← ..... 38←39←40←01←02←03←

Holding down the key, lets you skip through the presets, receiving each for 0.5 seconds a piece.

This receiver is equipped with listening modes that allow you to enjoy an enhanced sonic ambience with a variety of video sources.

In order to obtain the optimum effect from the surround modes, make sure to input the proper speaker settings beforehand.

- [15]

## Surround modes

### DTS (VR-407/KRF-V7030D only)

The DTS multi-channel audio format is available on CD, LD and DVD software. DTS is a strictly digital format and can not be decoded inside most CD, LD or DVD players. For this reason, if you attempt to listen to DTS encoded software through the analog output of your new CD, LD or DVD player, you will experience digital noise in most cases. This noise can be quite loud if the analog output is connected directly to a high power amplification system. Proper measures for playing the digital output as described below should be taken to avoid this situation. To enjoy DTS Digital Surround playback, an external 5.1 channel DTS Digital Surround decoder system or an amplifier with a built-in DTS Digital Surround decoder must be connected to the digital output (S/P DIF, AES/EBU or TosLink) of a CD, LD or DVD player. VR-407 and KRF-V7030D are incorporate the DTS decoder.

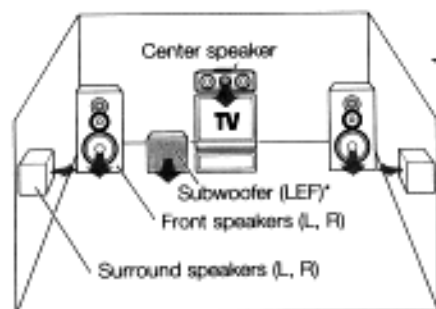

\* Optional in this mode.

\* LFE = Low Frequency Effects. This channel delivers separate non-directional bass signals to the subwoofer for more dynamic deep bass sound effects.

DTS has a .1 or LFE channel.

The indication "LFE" appears in the display when a signal is being input for this channel.

Manufactured under license from Dolby Laboratories. "Dolby", "Pro Logic" and the double-D symbol are trademarks of Dolby Laboratories. Confidential Unpublished Works. ©1992-1997 Dolby Laboratories. All rights reserved.

Manufactured under license from Digital Theater Systems, Inc. US Pat. No. 5,451,942 and other worldwide patents issued and pending.

"DTS" and "DTS Digital Surround" are trademarks of Digital Theater Systems, Inc.

© 1996 Digital Theater Systems, Inc. All rights reserved.



### Dolby Digital (AC-3)

The Dolby Digital (AC-3) surround format lets you enjoy up to 5.1 channels of digital surround sound from Dolby Digital (AC-3) program sources (such as Laserdisc or DVD software marked ). Compared with previous Dolby surround, Dolby Digital (AC-3) provides even better sound quality, greater spatial accuracy, and improved dynamic range.

#### Note

Although a full set of speakers (front left, right, and center, surround left and right, and a subwoofer) is required for true 5.1 channel Dolby Digital (AC-3) surround sound, this receiver lets you enjoy Dolby Digital (AC-3) (and Dolby Surround) program sources, even if you connect only the front speakers. ("Speaker placement")

- [14]

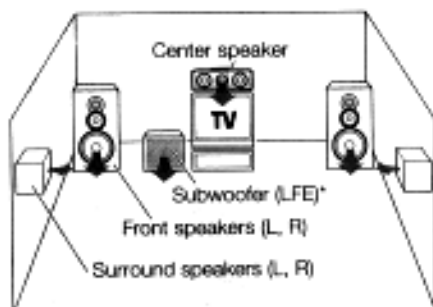

\* LFE = Low Frequency Effects. This channel delivers separate non-directional bass signals to the subwoofer for more dynamic deep bass sound effects.

Although only Dolby Digital (AC-3) soundtracks incorporate a separate low frequency channel, connecting a subwoofer will also improve deep bass performance in the other surround modes.

The indication "LFE" appears in the display when a signal is being input for this channel.

### Dolby Pro Logic

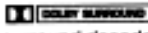
Dolby Pro Logic is a specially encoded 2 channel surround format designed to provide theater-like surround sound from Dolby Surround encoded sources (such as video and Laserdisc software marked ).

This receiver is equipped with a Dolby Pro Logic surround decoder to let you enjoy the wide variety of currently available Dolby Surround home video software.

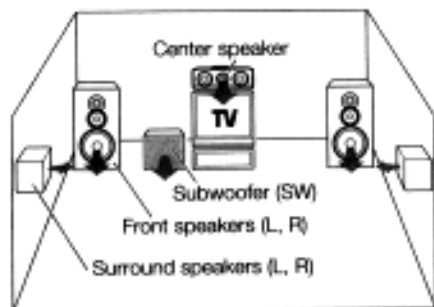

**Dolby 3 Stereo**

Dolby 3 Stereo is available for systems that do not have surround speakers. When in the Dolby 3 Stereo mode, the surround information is redirected to the front left and right speakers. This mode is designed for use with Dolby Surround program sources, but can also improve sound field unity for programs that are not Dolby Surround encoded. Dialog positioning and sound image definition, however, may not be as accurate when used with programs that are not Dolby Surround encoded.

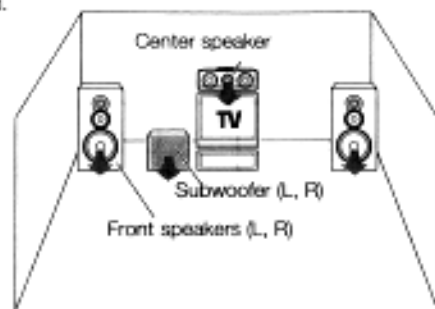
**DVD 6-channel mode**

Using a DVD player or the like equipped with six (5.1) output channels and the receiver, you can enjoy multi-channel encoded DVD source material in all its splendor. Since the source signals are digital and each channel is input independently, the resulting sound quality, sense of spaciousness, and dynamic range are superb.

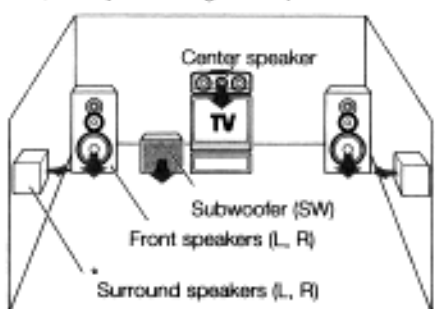

\* LFE = Low Frequency Effects. This channel delivers separate non-directional bass signals to the subwoofer for more dynamic deep bass sound effects.

The indication "LFE" appears in the display when a signal is being input for this channel.

**Surround Play**

The DTS compatible models can reproduce a CD, DVD, or LD carrying the DTS mark. (VR-407 and KRF-V7030D only)

DOLBY DIGITAL can be used when playing DVD or LD software bearing the mark and DOLBY DIGITAL (AC-3) format digital broadcasts (etc.). DOLBY PRO LOGIC and DOLBY 3 STEREO can be used when playing video, DVD, or LD software bearing the mark.

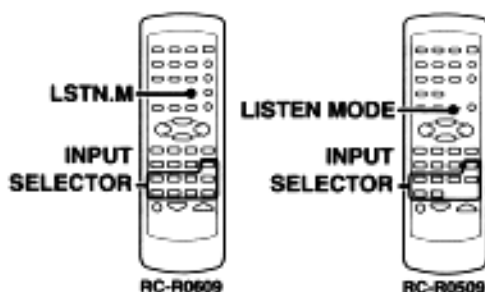
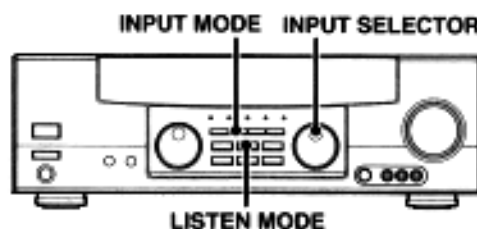
**Preparations**

- Turn ON related components.
- Complete "Preparing for surround sound" (speaker settings). - [16]
- Use the **INPUT SELECTOR** to select the component you wish to play back with surround sound.
- Use the **INPUT MODE** key to select the input mode (analog or digital) for the source you wish to play back. - [16]
- Noise will be produced when a DTS source is played by selecting the analog input.

**1 Start playing the video software.****2 Press the LISTEN MODE (LSTN.M) key to select the listening mode.**

The listening mode settings are stored separately for each input. If the input mode is set to digital auto ("AUTO SOUND" lights), the receiver selects the optimal listening mode automatically based on the type of input signal and the speaker settings.

Each press of the LISTEN MODE (LSTN.M) key switches the setting as listed below.

The listening mode settings are different depending on the type of input signal.

**When the DOLBY DIGITAL signal is input:**

(The DOLBY DIGITAL, PROLOGIC, or 3 STEREO indicator lights up.)

- ① **DOLBY DIGITAL**: DOLBY DIGITAL surround
- ② **PRO LOGIC**: PRO LOGIC surround
- ③ **3 STEREO**: 3-STEREO surround
- ④ **STEREO**: Normal stereo playback

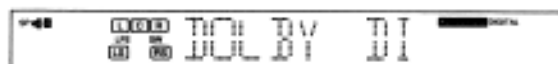
**When you select DOLBY DIGITAL**

**When the DTS signal is input: (VR-407/KRF-V7030D only)**  
(The DTS indicator lights up.)

- ① **DTS:** DTS surround
- ② **STEREO:** Normal stereo playback

**When the analog signal or the digital signal except for the DOLBY DIGITAL or DTS signal is input:**

- ① **PRO LOGIC:** PRO LOGIC surround (The PRO LOGIC indicator lights up.)
- ② **3 STEREO:** 3-STEREO surround (The 3 STEREO indicator lights up.)
- ③ **STEREO:** Normal stereo playback

- If a Dolby Digital signal having more channels than the maximum number of playback channels available using the receiver's current settings is input, the **DOWN MIX** indicator on the front panel lights up and downmixing is performed to match the number of available channels.

### 3 Adjust the volume.

#### Notes

- Depending on the type of the signal or speaker setting, some listening modes cannot be selected.
- When playback is started, the sound may be cut or interrupted before the input source is confirmed as Dolby Digital.
- To enjoy Dolby Digital (AC-3) surround (as well as all the other listening modes) from a single component, be sure to use a Dolby Digital (AC-3) compatible source component. Connect the Dolby Digital (AC-3) compatible source component's Dolby Digital (AC-3) format digital audio signal to one of the **DIGITAL INPUT** jacks on the back of the receiver. Connect the normal audio signal correctly to the respective component's **AUDIO** jacks. - [8] - [9] - [10]

## DVD 6-channel playback (VR-407/406/KRF-V7030D/V6030D/V5030D/V4530D only)

Using a DVD player or the like equipped with six (5.1) output channels and the receiver, you can enjoy surround sound playback. When you try to play a disc other than Dolby Digital (AC-3) such as DTS CD, no sound is produced or, noise may be heard. To avoid this situation, make sure that you connect the component to the receiver's DVD 6CH. INPUT jacks through a surround processor which can decode the surround signal you want to listen to. Connecting a DVD player which can decode the surround signal itself is also acceptable.

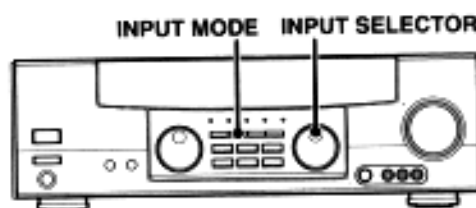

#### Preparations

- Connect your DVD player to the DVD 6ch jacks of the receiver.
- Turn on all other components that will be used.
- Complete "Preparing for surround sound". - [5]

#### 1 Select "DVD/6ch" as the input source.

- If speaker system B is on when "DVD/6ch" is selected as the input source, it switches off and speaker system A turns on automatically.

#### 2 Select "6CH INPT" by pressing the INPUT MODE key.

#### 3 Start playback of the DVD software.

#### 4 Adjust the volume.

- It is not possible individually to adjust the volume level or sound quality (**SET UP, SOUND**) of the separate channels when the receiver is in the DVD 6ch mode. Adjust the volume with the controls of the DVD player. For the powered subwoofer, you can adjust the volume of the subwoofer using the subwoofer's own volume control.



## Convenient functions

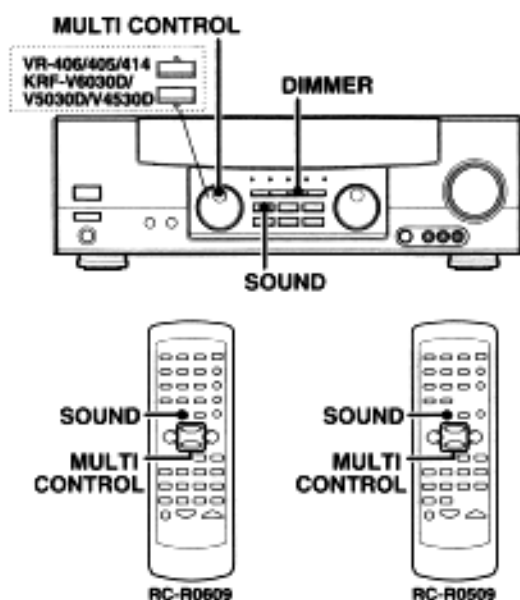

### Adjusting the sound

You can make further adjustments to the sound while listening to playback in the surround mode.

- 1 Press the **SOUND** key to select the item you want to adjust.

Each press switches the selection as listed below.  
Note that some items are not displayed in certain modes.

- |   |       |
|---|-------|
| ① <b>BASS</b> (low frequency range sound quality adjustment)  | - [7] |
| ② <b>TREB</b> (high frequency range sound quality adjustment) | - [7] |
| ③ <b>Cch</b> (center speaker level adjustment)                |       |
| ④ <b>RS</b> (right surround speaker level adjustment)         |       |
| ⑤ <b>LS</b> (left surround speaker level adjustment)          |       |
| ⑥ <b>SW</b> (subwoofer level adjustment)                      |       |
| ⑦ <b>INPUT</b> (input level adjustment)                       | - [3] |
| ⑧ <b>NIGHT</b> (midnight mode on/off)                         | - [2] |

- 2 Use the **MULTI CONTROL** to adjust the setting as desired.

- The adjustment item is displayed for approximately 8 seconds.

### Midnight mode (Dolby Digital (AC-3) mode only)

When watching movies at night you might not be able to raise the volume as loud as normal. Midnight mode compresses the dynamic range of previously specified parts of the Dolby Digital (AC-3) sound track (like scenes with sudden increases in volume) to minimize the difference in volume between the specified and non-specified parts. This makes it easy to hear all of the sound track, even when listening at low volumes.

- 1 Press the **SOUND** key several times until "NIGHT" is displayed.
- This can be selected only if CD/DVD, VIDEO2 or VIDEO3 is selected as the source and the listen mode is set to "DOLBY DIGITAL."

- 2 Use the **MULTI CONTROL** to select the on or off setting.

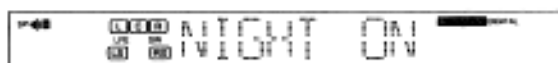

- The adjustment item is displayed for approximately 8 seconds.
- Some Dolby Digital (AC-3) software may not be compatible with the Midnight mode.

### Display dimmer adjustment

The dimmer function lets you select the brightness of the receiver's display. You might find this useful if you darken your room to watch movies or listen to music.

Each time you press the **DIMMER** key, the display brightness changes among the three available settings. Select the brightness level you find most pleasing.

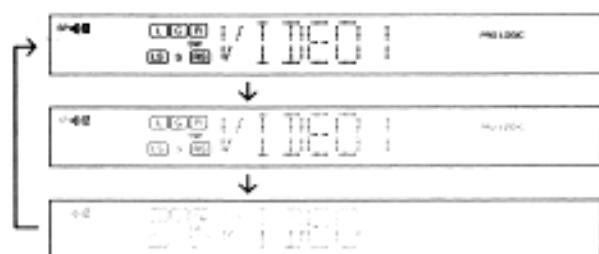

### 96kHz LPCM playback

The receiver is compatible with the 96kHz LPCM playback. To play a 96kHz DVD, set the listen mode to "STEREO."

- When "96kHz" appears in the display, press the **LISTEN MODE** key (the listen mode changes to the STEREO mode).

## Resetting the Microcomputer

If the microcomputer may malfunction (unit cannot be operated, or shows an erroneous display) if the power cord is unplugged while the power is ON, or due to some other external factor. If this happens, execute the following procedure to reset the microcomputer and return the unit to its normal operating condition.

- Please note that resetting the microcomputer will clear the contents of the memory and returns the unit to the state it was in when it left the factory.

### For U.S.A. and Canada

Unplug the power cord from the wall outlet, then plug it back in while holding down the POWER key.

### For other countries

With the power cord plugged in, turn the POWER key OFF. Then, while holding down the ON/STANDBY key, press POWER.

## Amplifier

Symptom	Cause	Remedy
No sound from the speakers.	<ul style="list-style-type: none"> <li>• The speaker cords are disconnected.</li> <li>• VOLUME is set to the minimum position.</li> <li>• MUTE is ON.</li> <li>• The SPEAKERS switches are set to OFF.</li> </ul>	<ul style="list-style-type: none"> <li>• Connect them properly referring to "Connecting the speakers" - [12]</li> <li>• Adjust the volume to a proper level.</li> <li>• Turn OFF the MUTE. - [31]</li> <li>• Set the SPEAKERS switch(es) to ON. - [31]</li> </ul>
The standby indicator blinks and sound is not output.	<ul style="list-style-type: none"> <li>• Speaker cords are short-circuited.</li> </ul>	<ul style="list-style-type: none"> <li>• Turn the power off, eliminate the short-circuiting, then turn on the power again. - [13]</li> </ul>
Sound is not output from one of the speakers.	<ul style="list-style-type: none"> <li>• The speaker cord is disconnected.</li> </ul>	<ul style="list-style-type: none"> <li>• Connect it properly referring to "Connecting the speakers".</li> </ul>
Sound is not output from the surround speakers and / or the center speaker, or their sound is very small.	<ul style="list-style-type: none"> <li>• The surround speaker cords and/or the center speaker cord is disconnected.</li> <li>• A surround mode has not been engaged.</li> <li>• The surround and/or center volume controls are set to the minimum level.</li> </ul>	<ul style="list-style-type: none"> <li>• Connect it properly referring to "Connecting the speakers".</li> <li>• Select a surround mode.</li> <li>• Adjust the speaker levels using the test tone. - [15]</li> </ul>
A humming noise is generated when the PHONO input selector is selected.	<ul style="list-style-type: none"> <li>• The audio cord from the turntable is not connected to the PHONO jacks.</li> <li>• The turntable is not grounded.</li> </ul>	<ul style="list-style-type: none"> <li>• Insert the audio cord plugs securely into the PHONO jacks.</li> <li>• Connect the grounding wire to the GND terminal on the rear panel.</li> </ul>
When playing a Dolby Digital (AC-3) source signal using a DVD player, the sound is cut off soon after it starts.	<ul style="list-style-type: none"> <li>• There are many possible causes for this problem, depending on the type of DVD player used.</li> </ul>	<ul style="list-style-type: none"> <li>• Set the input mode to digital manual before starting playback of the Dolby Digital source. - [32]</li> </ul>
No sound is produced during playback from a DVD player.	<ul style="list-style-type: none"> <li>• The input mode is set to digital manual.</li> </ul>	<ul style="list-style-type: none"> <li>• Press the INPUT MODE key to select to digital auto mode. - [32]</li> </ul>
A video source cannot be recorded normally.	<ul style="list-style-type: none"> <li>• The software is copy-guarded.</li> </ul>	<ul style="list-style-type: none"> <li>• Copy-guarded video software cannot be recorded.</li> </ul>
No audio is produced when a DTS source is played. (except for VR-407 and KRF-V7030D)	<ul style="list-style-type: none"> <li>• The model does not incorporate a DTS decoder.</li> </ul>	<ul style="list-style-type: none"> <li>• DTS sources cannot be reproduced with a model that does not incorporate a DTS decoder.</li> </ul>

## Tuner

Symptom	Cause	Remedy
Radio stations cannot be received.	<ul style="list-style-type: none"> <li>• No antenna is connected.</li> <li>• The broadcast band is not set properly.</li> <li>• The frequency of the desired station is not tuned.</li> </ul>	<ul style="list-style-type: none"> <li>• Connect an antenna.</li> <li>• Set the broadcast band properly.</li> <li>• Tune the frequency of the desired station. - [28]</li> </ul>
Interference.	<ul style="list-style-type: none"> <li>• Noise due to ignition noise from an automobile.</li> <li>• Noise due to interference from an electric appliance.</li> <li>• Noise due to a nearby TV set.</li> </ul>	<ul style="list-style-type: none"> <li>• Install the outdoor antenna away from the road.</li> <li>• Turn off the power to the appliance.</li> <li>• Install the receiver farther away from the TV.</li> </ul>
A station which was preset cannot be received by pressing the corresponding numeric key.	<ul style="list-style-type: none"> <li>• The preset station belongs to a frequency that cannot be received.</li> <li>• The preset memory was cleared because the power cord had been unplugged for a long period of time.</li> </ul>	<ul style="list-style-type: none"> <li>• Preset a station with a receivable frequency.</li> <li>• Preset the station again.</li> </ul>

**For U.S.A and Canada**

**AUDIO section (VR-407/406)**

Rated power output during STEREO operation

100 watts per channel minimum RMS, both channels driven, at 8 Ω from 20 Hz (VR-407), 40Hz (VR-406) to 20 kHz with no more than 0.7% total harmonic distortion. (FTC)

Effective power output during SURROUND operation

FRONT (20-20kHz/VR-407, 40-20kHz/VR-406, 0.7% T.H.D. at 8 Ω one channel driven) .....	100 W + 100 W
CENTER (20-20kHz/VR-407, 40-20kHz/VR-406, 0.7% T.H.D. at 8 Ω one channel driven) .....	100 W
SURROUND (20-20kHz/VR-407, 40-20kHz/VR-406, 0.7% T.H.D. at 8 Ω one channel driven).....	100 W + 100 W
Total harmonic distortion .....	0.055% (1 kHz, 50W, 8 Ω)
Frequency response	
CD .....	10 Hz ~ 53 kHz, +0 dB, -3.0 dB
Signal to noise ratio (IHF'66)	
PHONO (MM) .....	75 dB
CD .....	91 dB
Input sensitivity / impedance	
PHONO (MM) .....	2.5 mV / 27 kΩ
CD .....	200 mV / 47 kΩ
MONITOR IN (VR-406:VIDEO2/MONITOR) .....	200 mV / 47 kΩ
Output level / impedance	
TAPE REC .....	200 mV / 1 kΩ
MONITOR OUT (VR-406:VIDEO2/MONITOR) .....	200 mV / 1 kΩ
PRE OUT (SUBWOOFER) .....	2 V / 2.2 kΩ
Tone control	
BASS .....	±10 dB (at 100 Hz)
TREBLE .....	±10 dB (at 10 kHz)

**AUDIO section (VR-405/414)**

Rated power output during STEREO operation

80 watts (VR-405), 50watts (VR-414) per channel minimum RMS, both channels driven, at 8 Ω from 40 Hz to 20 kHz with no more than 0.7% total harmonic distortion. (FTC)

Effective power output during SURROUND operation

FRONT (40-20kHz, 0.7% T.H.D. at 8 Ω one channel driven) .....	80 W + 80 W (VR-405), 50 W + 50 W (VR-414)
CENTER (40-20kHz, 0.7% T.H.D. at 8 Ω one channel driven) .....	80 W (VR-405), 50 W (VR-414)
SURROUND (40-20kHz, 0.7% T.H.D. at 8 Ω one channel driven) .....	80 W + 80 W (VR-405), 50 W + 50 W (VR-414)
Total harmonic distortion .....	0.055% (1 kHz, 40W, 8 Ω)
Frequency response	
CD .....	10 Hz ~ 53 kHz, +0 dB, -3.0 dB
Signal to noise ratio (IHF'66)	
CD .....	91 dB
Input sensitivity / impedance	
CD .....	200 mV / 47 kΩ
MONITOR IN (VIDEO2/MONITOR) .....	200 mV / 47 kΩ
Output level / impedance	
TAPE REC .....	200 mV / 1 kΩ
MONITOR OUT (VIDEO2/MONITOR) .....	200 mV / 1 kΩ
PRE OUT (SUBWOOFER) .....	2 V / 2.2 kΩ
Tone control	
BASS .....	±10 dB (at 100 Hz)
TREBLE .....	±10 dB (at 10 kHz)

**DIGITAL AUDIO section**

Sampling frequency .....	32 kHz, 44.1 kHz, 48 kHz, 96kHz
Input level / impedance / wave length	
Optical .....	(-15 dBm ~ -21 dBm), 680 nm ±30nm
Coaxial .....	0.5 Vp-p / 75 Ω

**VIDEO section**

VIDEO inputs / outputs	
VIDEO (composite) .....	1 Vp-p / 75 Ω
S VIDEO (VR-407 only)	
(luminance signal) .....	1 Vp-p / 75 Ω
(chrominance signal) .....	0.286 Vp-p / 75 Ω

**FM tuner section**

Tuning frequency range .....	87.5 MHz ~ 108 MHz
Usable sensitivity (MONO)	
.....	1.6 μV (75 Ω) / 15.2 dBf (75 kHz DEV., SINAD 30 dB)
50dB quieting sensitivity	
STEREO .....	31.6 μV (75 Ω) / 41.2 dBf
Total harmonic distortion (1 kHz)	
MONO .....	0.6% (65 dBf input)
STEREO .....	0.7% (65 dBf input)
Signal to noise ratio (1 kHz, 75 kHz DEV.)	
MONO .....	75 dB (65 dBf input)
STEREO .....	68 dB (65 dBf input)
Stereo separation (1 kHz) .....	38 dB
Selectivity (±400 kHz) .....	70 dB
Frequency response .....	(30 Hz ~ 15kHz), +0.5 dB, -3.0 dB

**AM tuner section**

Tuning frequency range	
10 kHz step .....	530 kHz ~ 1,700 kHz
Usable sensitivity (30% mod., S/N 20 dB) .....	16 μV / (600 μV/m)
Signal to noise ratio (30% mod., 1 mV input) .....	50 dB

**GENERAL**

Power consumption (VR-414) .....	2.3 A
(VR-405) .....	2.0 A
(VR-407/406) .....	2.6 A
AC outlet	
SWITCHED .....	(total 150 W, 1.25 A max.)
Dimensions .....	W : 440 mm (17-5/16")
	H : 143 mm (5-5/8")
	D : 400 mm (15-3/4")
Weight (Net) .....	7.2 kg (15.8 lb)

**Notes**

1. KENWOOD follows a policy of continuous advancements in development. For this reason specifications may be changed without notice.
2. The full performance may not be exhibited in an extremely cold location (under a water-freezing temperature).

**For other countries**

**AUDIO section (KRF-V7030D/V6030D)**

Effective power output during STEREO operation  
 1kHz, 10% T.H.D., at 8 Ω ..... 140 W + 140 W  
 Rated power output during STEREO operation

100 watts per channel minimum RMS, both channels driven, at 8 Ω from 40 Hz (KRF-V6030D), 20Hz (KRF-V7030D) to 20 kHz with no more than 0.7% total harmonic distortion.(FTC)

Effective power output during SURROUND operation  
 FRONT (1kHz, 10% T.H.D. at 8 Ω one channel driven) ..... 140 W + 140 W  
 CENTER (1kHz, 10% T.H.D. at 8 Ω one channel driven) ..... 140 W  
 SURROUND (1kHz, 10% T.H.D. at 8 Ω one channel driven) ..... 140 W + 140 W  
 Total harmonic distortion ..... 0.055% (1 kHz, 50W, 8 Ω)  
 Frequency response  
 CD ..... 10 Hz ~ 50 kHz, +0 dB, -3.0 dB  
 Signal to noise ratio (IHF'66)  
 PHONO (MM) ..... 75 dB  
 CD ..... 91 dB  
 Input sensitivity / impedance  
 PHONO (MM) ..... 2.5 mV / 27 kΩ  
 CD ..... 200 mV / 47 kΩ  
 MONITOR IN (KRF-V6030D:VIDEO2/MONITOR) ..... 200 mV / 47 kΩ  
 Output level / impedance  
 TAPE REC ..... 200 mV / 1 kΩ  
 MONITOR OUT (KRF-V6030D:VIDEO2/MONITOR) ..... 200 mV / 1 kΩ  
 PRE OUT (SUBWOOFER) ..... 2 V / 2.2 kΩ  
 Tone control  
 BASS (For Australia and U.S-Military) ..... ±10 dB (at 100 Hz)  
 BASS (Other countries) ..... ±10 dB (at 60 Hz)  
 TREBLE ..... ±10 dB (at 10 kHz)

**AUDIO section (KRF-V5030D)**

Effective power output during STEREO operation  
 (1 kHz, 10%, 8Ω) ..... 110 W + 110 W

80 watts channel minimum RMS, both channels driven, at 8 Ω from 40 Hz to 20 kHz with no more than 0.7% total harmonic distortion. (FTC)

Effective power output during SURROUND operation  
 FRONT (1kHz, 10% T.H.D. at 8 Ω one channel driven) ..... 110 W + 110 W  
 CENTER (1kHz, 10% T.H.D. at 8 Ω one channel driven) ..... 110 W  
 SURROUND (1kHz, 10% T.H.D. at 8 Ω one channel driven) ..... 110 W + 110 W  
 Total harmonic distortion ..... 0.055% (1 kHz, 40W, 8 Ω)  
 Frequency response  
 CD ..... 10 Hz ~ 53 kHz, +0 dB, -3.0 dB  
 Signal to noise ratio (IHF'66)  
 PHONO (MM) ..... 73 dB  
 CD ..... 91 dB  
 Input sensitivity / impedance  
 PHONO (MM) ..... 2.5 mV / 27 kΩ  
 CD ..... 200 mV / 47 kΩ

MONITOR IN (VIDEO2/MONITOR) ..... 200 mV / 47 kΩ  
 Output level / impedance  
 TAPE REC ..... 200 mV / 1 kΩ  
 MONITOR OUT (VIDEO2/MONITOR) ..... 200 mV / 1 kΩ  
 PRE OUT (SUBWOOFER) ..... 2 V / 2.2 kΩ  
 Tone control  
 BASS (For Australia and U.S-Military) ..... ±10 dB (at 100 Hz)  
 BASS (Other countries) ..... ±10 dB (at 60 Hz)  
 TREBLE ..... ±10 dB (at 10 kHz)

**DIGITAL AUDIO section**

Sampling frequency ..... 32 kHz, 44.1 kHz, 48 kHz, 96kHz  
 Input level / impedance / wave length  
 Optical ..... (-15 dBm ~ -21 dBm), 660 nm ±30nm  
 Coaxial ..... 0.5 Vp-p / 75 Ω

**VIDEO section**

VIDEO inputs / outputs  
 VIDEO (composite) ..... 1 Vp-p / 75 Ω  
 S VIDEO (KRF-V7030D only)  
 (luminance signal) ..... 1 Vp-p / 75 Ω  
 (chrominance signal) ..... 0.286 Vp-p / 75 Ω

**FM tuner section**

Tuning frequency range ..... 87.5 MHz ~ 108 MHz  
 Usable sensitivity (MONO) ..... 1.6 μV (75 Ω) / 15.2 dBf (75 kHz DEV., SINAD 30 dB)  
 50dB quieting sensitivity  
 STEREO ..... 31.6 μV (75 Ω) / 41.2 dBf  
 Total harmonic distortion (1 kHz)  
 MONO ..... 0.6% (65 dBf input)  
 STEREO ..... 0.7% (65 dBf input)  
 Signal to noise ratio (1 kHz, 75 kHz DEV.)  
 MONO ..... 75 dB (65 dBf input)  
 STEREO ..... 68 dB (65 dBf input)  
 Stereo separation (1 kHz) ..... 38 dB  
 Selectivity (±400 kHz) ..... 50 dB  
 Frequency response ..... (30 Hz ~ 15kHz), +0.5 dB, -3.0 dB

**AM tuner section**

Tuning frequency range  
 9 kHz step ..... 531 kHz ~ 1,602 kHz  
 10 kHz step ..... 530 kHz ~ 1,610 kHz  
 Usable sensitivity ..... 16 μV / (600 μV/m)  
 Signal to noise ratio (30% mod. 1 mV input) ..... 50 dB

**GENERAL**

Power consumption  
 KRF-V5030D ..... 190 W  
 KRF-V7030D/V6030D ..... 250 W  
 AC outlet  
 SWITCHED ..... (total 90 W max.)  
 Dimensions ..... W : 440 mm  
 H : 143 mm  
 D : 400 mm  
 Weight (Net)(KRF-V7030D/V6030D) ..... 7.4 kg  
 (Net)(KRF-V5030D) ..... 7.2 kg

**Notes**

1. KENWOOD follows a policy of continuous advancements in development. For this reason specifications may be changed without notice.
2. The full performance may not be exhibited in an extremely cold location (under a water-freezing temperature).

# KENWOOD

**For your records**

Record the serial number, found on the back of the unit, in the spaces designated on the warranty card, and in the space provided below. Refer to the model and serial numbers whenever you call upon your dealer for information or service on this product.

Model \_\_\_\_\_ Serial Number \_\_\_\_\_

# CORRECTION/CORRECTION

VR-407/VR-406/VR-405/VR-414

KRF-V7030D/KRF-V6030D/KRF-V5030D

**Wrong**  
Remote control unite (RC-RO609)

## P2 **Step 3**

Press the **source POWER (TV, VCR, DVD, CABLE, DSS/CDR)** key to select the input you registered.

## P3 **3**

*Press the source POWER (TV, VCR, DVD, CABLE, DSS/CDR) key, and check to see that the component you want to control turns on.*

Main unit (VR-405/VR-414/KRF-V5030D)

## P7 Remote control unite (RC-RO509)

### ① Power key (DVD)

Used to operate DVD player. For details, refer to the instruction manual of your DVD player.

**Correct**

## P2 **Step 3**

Press the **source POWER (TV, VCR, DVD, CABLE, DSS/CDR)** key for more than 2 seconds to select the input you registered.

## P3 **3**

*Press the source POWER (TV, VCR, DVD, CABLE, DSS/CDR) key for more than 2 seconds, and check to see that the component you want to control turns on.*

**Erroné**  
Télécommande (RC-RO609)

## P2 **Etape 3**

Appuyez sur la touches **POWER de source (TV, VCR, DVD, CABLE, DSS/CDR)** pour sélectionner l'entrée que vous avez enregistrée.

## P3 **3**

*Appuyez sur la touches POWER de source (TV, VCR, DVD, CABLE, DSS/CDR), puis vérifiez que l'appareil que vous désirez contrôler s'allume.*

Appareil principal (VR-405/VR-414/KRF-V5030D)

## P7 Télécommande (RC-R0509)

### ① Touche Power (DVD)

Permet d'utiliser un lecteur DVD. Pour plus de détails, reportez-vous au mode d'emploi de votre lecteur DVD.

**Correct**

## P2 **Etape 3**

Appuyez sur la touches **POWER de source (TV, VCR, DVD, CABLE, DSS/CDR)** pendant plus de 2 secondes pour sélectionner l'entrée que vous avez enregistrée.

## P3 **3**

*Appuyez sur la touches POWER de source (TV, VCR, DVD, CABLE, DSS/CDR) pendant plus de 2 secondes, puis vérifiez que l'appareil que vous désirez contrôler s'allume.*

## P24 (addition)

- (VR-405/414/KRF-V5030D only)  
When you press the POWER (DVD) key and the DVD player does not turn on, press the 1 or 2 key during pressing the POWER (DVD) key.

## P24 (addition)

- (VR-405/414/KRF-V5030D uniquement)  
Si le lecteur DVD ne se met pas sous tension lorsque vous appuyez sur la touche POWER (DVD), appuyez sur la touche 1 ou 2 tout en maintenant la touche POWER (DVD) enfoncée.

**13. Lightning** – For added protection for this appliance during a lightning storm, or when it is left unattended and unused for long periods of time, unplug it from the wall outlet and disconnect the antenna or cable system. This will prevent damage to the appliance due to lightning and power-line surges.

**14. Abnormal smell** – If an abnormal smell or smoke is detected, immediately turn the power OFF and unplug the appliance from the wall outlet. Contact your dealer or nearest service center.

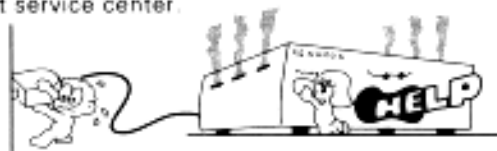

**15. Damage requiring service** – The appliance should be serviced by qualified service personnel when:

- A. The power-supply cord or the plug has been damaged.
- B. Objects have fallen, or liquid has been spilled into the appliance.
- C. The appliance has been exposed to rain or water.
- D. The appliance does not appear to operate normally by following the instruction manual. Adjust only those controls that are covered by the instruction manual as an improper adjustment of other controls may result in damage and will often require extensive work by a qualified technician to restore the appliance to its normal operation.
- E. The appliance has been dropped, or the enclosure damaged.
- F. The appliance exhibits a marked change in performance.

**16. Servicing** – The user should not attempt to service the appliance beyond that described in the instruction manual. All other servicing should be referred to qualified service personnel.

**17. Outdoor antenna grounding** – If an outside antenna is connected to the appliance, be sure the antenna system is grounded so as to provide some protection against voltage surges and built up static charges. Article 810 of the National Electrical Code (ANSI/NFPA 70), provides information with respect to proper grounding of the mast and supporting structure, grounding of the lead-in wire to an antenna discharge unit, size of grounding conductors, location of antenna discharge unit, connection to grounding electrodes, and requirements for the grounding electrode. See Figure.

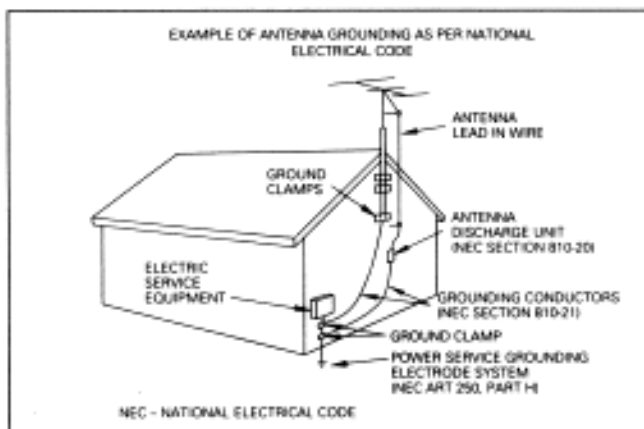

**18. Power lines** – An outside antenna system should not be located in the vicinity of overhead power lines or other electric light or power circuits, or where it can fall into such power lines or circuits. When installing an outside antenna system, extreme care should be taken to keep from touching such power lines or circuits as contact with them might be fatal.

**19. AC outlets** – Do not connect other audio equipment with a power consumption larger than that specified to the AC outlet on the rear panel. Never connect other electrical appliances, such as an iron or toaster, to it to prevent fire or electric shock.

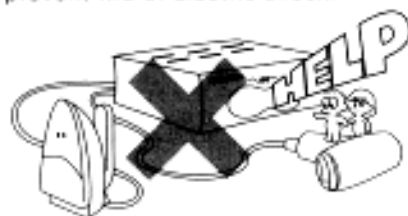

**20. Overloading** – Do not overload wall outlets, extension cords, or integral convenience receptacles as this can result in a risk of fire or electric shock.

**21. Attachment** – Do not use attachments not recommended by the appliance manufacturer as they may cause hazards.

**22. Replacement parts** – When replacement parts are required, be sure the service technician has used replacement parts specified by the manufacturer or have the same characteristics as the original parts. Unauthorized substitutions may result in fire, electric shock, or other hazards.

**23. Safety check** – Upon completion of any service or repairs to this appliance, ask the service technician to perform safety checks to determine that the appliance is in proper operating condition.

**Notes:**

1. Item 3 is not required except for grounded or polarized equipment.
2. Item 17 and 18 are not required except for units provided with antenna terminals.
3. Item 17 complies with UL in the U.S.A.

# IMPORTANT SAFEGUARDS

▲ *Caution* Read this page carefully to ensure safe operation

(En)

Please read all of the safety and operating instructions before operating this appliance. Adhere to all warnings on the appliance and in the instruction manual. Follow all the safety and operating instructions. These safety and operating instructions should be retained for future reference.

- 1. Power sources** – The appliance should be connected to a power supply only of the type described in the instruction manual or as marked on the appliance. If you are not sure of the type of power supply to your home, consult your appliance dealer or local power company. For appliances intended to operate from battery power, or other sources, refer to the instruction manual.
- 2. Power-cord protection** – Power-supply cords should be routed so that they are not likely to be walked on or pinched by items placed upon or against them, pay particular attention to cords at plugs, convenience receptacles, and the point where they exit from the appliance.

Never pull or stretch the cord.



- 3. CAUTION – Polarization** – This appliance may be equipped with a polarized alternating-current line plug (a plug having one blade wider than the other). This plug will fit into the power outlet only one way. This is a safety feature. If you are unable to insert the plug fully into the outlet, try reversing the plug. If the plug should still fail to fit, contact your electrician to replace your obsolete outlet. Do not defeat the safety purpose of the polarized plug.
- 4. Ventilation** – Slots and openings in the cabinet are provided for ventilation and to ensure reliable operation of the appliance and to protect it from overheating, and these openings must not be blocked or covered. The appliance should be situated so that its location or position does not interfere with its proper ventilation. To maintain good ventilation, do not put records or a tablecloth on the appliance. Place the appliance at least 10 cm away from the walls. Do not use the appliance on a bed, sofa, rug or similar surface that may block the ventilation openings. This appliance should not be placed in a built-in installation such as a bookcase or rack unless proper ventilation is provided or the manufacturer's instructions have been adhered to.



- 5. Water and moisture** – The appliance should not be used near water - for example, near a bathtub, washbowl, kitchen sink, laundry tub, in a wet basement, or near a swimming pool, etc.

- 6. Temperature** – The appliance may not function properly if used at extremely low, or freezing temperatures. The ideal ambient temperature is above +5°C (41°F).
- 7. Heat** – The appliance should be situated away from heat sources such as radiators, heat registers, stoves, or other appliances (including amplifiers) that produce heat.
- 8. Electric shock** – Care should be taken so that objects do not fall and liquid is not spilled into the enclosure through openings. If a metal object, such as a hair pin or a needle, comes into contact with the inside of this appliance, a dangerous electric shock may result. For families with children, never permit children to put anything, especially metal, inside this appliance.



- 9. Enclosure removal** – Never remove the enclosure. If the internal parts are touched accidentally, a serious electric shock might occur.



- 10. Magnetic fields** – Keep the appliance away from sources of magnetic fields such as TV sets, speaker systems, radios, motorized toys or magnetized objects.
- 11. Cleaning** – Unplug this appliance from the wall outlet before cleaning. Do not use volatile solvents such as alcohol, paint thinner, gasoline, or benzene, etc. to clean the cabinet. Use a clean dry cloth.
- 12. Accessories** – Do not place this appliance on an unstable cart, stand, tripod, bracket, or table. The appliance may fall, causing serious injury to a child or adult, and serious damage to the appliance. Use only with a cart, stand, tripod, bracket, or table recommended by the manufacturer, or sold with the appliance. Any mounting of the appliance should follow the manufacturer's instructions, and should use a mounting accessory recommended by the manufacturer. An appliance and cart combination should be moved with care. Quick stops, excessive force, and uneven surfaces may cause the appliance and cart combination to overturn.



## Free Manuals Download Website

<http://myh66.com>

<http://usermanuals.us>

<http://www.somanuals.com>

<http://www.4manuals.cc>

<http://www.manual-lib.com>

<http://www.404manual.com>

<http://www.luxmanual.com>

<http://aubethermostatmanual.com>

Golf course search by state

<http://golfingnear.com>

Email search by domain

<http://emailbydomain.com>

Auto manuals search

<http://auto.somanuals.com>

TV manuals search

<http://tv.somanuals.com>