

KENWOOD

144 MHz FM TRANSCEIVER

TM-261A

144 MHz FM TRANSCEIVER

TM-261EJ

430/440 MHz FM TRANSCEIVER

TM-461A

INSTRUCTION MANUAL

KENWOOD CORPORATION

© B62-0605-00(K,M,C)
09 08 07 06 05 04 03 02 01 00

THANK YOU!

We are grateful you decided to purchase this **KENWOOD** FM transceiver. This series of mobile transceivers were developed to satisfy the requirement for a compact rig that's simple to operate yet has superior performance. Users of this series will discover the transceiver's Menu Set-up method for feature configuration recently incorporated in other **KENWOOD** products.

KENWOOD believes that the compact size coupled with the reasonable cost will guarantee your satisfaction with this product.

MODELS COVERED BY THIS MANUAL

The models listed below are covered by this manual.

TM-261A: 144 MHz FM transceiver
(U.S.A./ Canada/ General market)

TM-261EJ: 144 MHz FM transceiver
(General market)

TM-461A: 440 MHz FM transceiver
(U.S.A./ Canada)

430 MHz FM transceiver
(China/ General market)

FEATURES

- Memory Indexing conveniently allows you to assign names to memory channels. Use callsigns, repeater names, cities, persons' names, etc.
- In Memory Recall mode, memory channel numbers can be displayed instead of frequencies if you choose.
- Innovative Menu Set-up method combines sophisticated features with simple operation; ergonomic design places only the most frequently-used keys on the Front Panel without losing desired features.
- Dual Tone Squelch System (DTSS) allows selective calling of specific stations.
- Programmable with a RX Tone and TX Tone separately. This enhances the optional Continuous Tone Coded Squelch System (CTCSS).

NOTICES TO THE USER

One or more of the following statements may be applicable:

FCC WARNING

This equipment generates or uses radio frequency energy. Changes or modifications to this equipment may cause harmful interference unless the modifications are expressly approved in the instruction manual. The user could lose the authority to operate this equipment if an unauthorized change or modification is made.

INFORMATION TO THE DIGITAL DEVICE USER REQUIRED BY THE FCC

This equipment has been tested and found to comply with the limits for a Class B digital device, pursuant to Part 15 of the FCC Rules. These limits are designed to provide reasonable protection against harmful interference in a residential installation.

This equipment generates, uses and can generate radio frequency energy and, if not installed and used in accordance with the instructions, may cause harmful interference to radio communications. However, there is no guarantee that the interference will not occur in a particular installation. If this equipment does cause harmful interference to radio or television reception, which can be determined by turning the equipment off and on, the user is encouraged to try to correct the interference by one or more of the following measures:

- *Reorient or relocate the receiving antenna.*
- *Increase the separation between the equipment and receiver.*
- *Connect the equipment to an outlet on a circuit different from that to which the receiver is connected.*
- *Consult the dealer for technical assistance.*

PRECAUTIONS

Please observe the following precautions to prevent fire, personal injury, and transceiver damage:

- When operating mobile, do not attempt to configure your transceiver while driving because it is simply too dangerous.
- Be aware of local laws pertaining to the use of headphones/headsets while driving on public roads. If in doubt, do not wear headphones while mobiling.
- Do not transmit with high output power for extended periods. The transceiver may overheat.
- Do not modify this transceiver unless instructed by this manual or by **KENWOOD** documentation.
- Do not expose the transceiver to long periods of direct sunlight nor place the transceiver close to heating appliances.
- Do not place the transceiver in excessively dusty areas, humid areas, nor on unstable surfaces.
- If an abnormal odor or smoke is detected coming from the transceiver, turn OFF the power immediately. Contact a **KENWOOD** service station or your dealer.
- The transceiver is designed for a 13.8 V power source. Never use a 24 V battery to power the transceiver.

CONTENTS

THANK YOU!	Inside Front Cover
MODELS COVERED BY THIS MANUAL	Inside Front Cover
FEATURES	Inside Front Cover
NOTICES TO THE USER	i
PRECAUTIONS	i
SUPPLIED ACCESSORIES	1
CONVENTIONS FOLLOWED IN THIS MANUAL	1

CHAPTER ① **PREPARATION FOR MOBILE AND FIXED STATION OPERATION**

MOBILE INSTALLATION	2
Installation Example	2
Installation Steps	2
DC POWER CABLE CONNECTION	3
Mobile Operation	3
Fixed Station Operation	4
Replacing Fuses	5
ANTENNA CONNECTION	5
ACCESSORY CONNECTIONS	6
External Speaker	6
Microphone	6

CHAPTER ② **GETTING ACQUAINTED**

FRONT PANEL	7
REAR PANEL	9
MICROPHONE	10
DISPLAY	11
BUTTON FUNCTION DISPLAY	13
Basic State Display Labels	13
Labels After Pressing [F]	13

CHAPTER ③ **OPERATING BASICS**

SWITCHING POWER ON/OFF	14
ADJUSTING VOLUME	14
ADJUSTING SQUELCH	14
SELECTING FREQUENCIES	15
Tuning Control	15
Microphone [UP]/[DWN] Buttons	15
TRANSMITTING	16
Selecting Output Power	16

CHAPTER ④ **MENU SET-UP**

MENU DESCRIPTION	17
------------------------	----

MENU ACCESS	17
MENU A CONFIGURATION	18
MENU B CONFIGURATION	19

CHAPTER ⑤ OPERATING THROUGH REPEATERS

REPEATER ACCESS	20
Selecting Offset Frequency	21
Selecting Offset Direction	22
Automatic Repeater Offset (Some TM-261A Versions Only)	22
Activating Tone Function	22
Selecting a Tone Frequency	23
REVERSE FUNCTION	23

CHAPTER ⑥ MEMORY CHANNELS

STORING DATA IN MEMORY	24
Simplex Memory Channels	25
Split Memory Channels	25
RECALLING MEMORY CHANNELS	26
ERASING MEMORY CHANNELS	26
CALL CHANNEL	27
Recalling the Call Channel	27
Changing Call Channel Contents (Simplex)	27
Changing Call Channel Contents (Split)	28
MEMORY → VFO TRANSFERS	28

INITIALIZING MEMORY	29
Partial Reset (VFO)	29
Full Reset (Memory)	29
CHANNEL DISPLAY FUNCTION	29
NAMING MEMORY CHANNELS	30
Storing a Name in Memory	30

CHAPTER ⑦ SCAN

SCAN RESUME METHODS	31
Time-Operated Scan	31
Carrier-Operated Scan	31
VFO SCAN	32
MEMORY SCAN	32
Locking Out Memory Channels	33
PROGRAM SCAN	34
Setting Scan Limits	34
Confirming Scan Limits	34
Using Program Scan	35
CALL/VFO SCAN	35
CALL/MEMORY SCAN	35

CHAPTER ⑧ CONTINUOUS TONE CODED SQUELCH SYSTEM (CTCSS)

USING CTCSS	36
Automatic Tone Frequency ID	36



CHAPTER 9 DUAL TONE SQUELCH SYSTEM (DTSS)

STORING DTSS CODES	37
Using the Tuning Control or Microphone [UP]/[DWN]	37
Using the Microphone DTMF Keypad	37
Setting a Group Code	38
USING DTSS	39
DTSS and Repeaters	39

CHAPTER 10 DUAL TONE MULTI-FREQUENCY (DTMF) FUNCTIONS

MAKING DTMF CALLS	40
STORING DTMF NUMBERS FOR THE AUTOMATIC DIALER	40
CONFIRMING STORED DTMF NUMBERS	41
TRANSMITTING STORED DTMF NUMBERS	41
AUTOPATCH (U.S.A. AND CANADA VERSIONS) .	42

CHAPTER 11 AUXILIARY FUNCTIONS

FULL RESET	43
KEYPAD DIRECT ENTRY	43
Frequency Entry	43
Memory Channel Number Entry	44
CHANGING FREQUENCY STEP SIZE	45
Changes in Displayed Frequencies	45

TIME-OUT TIMER (TOT)	46
BUSY CHANNEL LOCKOUT	46
AUTOMATIC POWER OFF (APO)	46
TRANSCEIVER LOCK	46
CONFIGURING PROGRAM FUNCTION KEYS	47
Programming Microphone [PF]	48
SWITCHING AM/FM MODE (SOME TM-261A VERSIONS ONLY)	48

CHAPTER 12 PACKET OPERATION

1200 bps OPERATION	49
--------------------------	----

CHAPTER 13 MAINTENANCE

GENERAL INFORMATION	50
SERVICE	50
SERVICE NOTE	50
CLEANING	50
TROUBLESHOOTING	51

CHAPTER 14 OPTIONAL ACCESSORIES**CHAPTER 15 INSTALLING OPTIONS**

INSTALLING THE TSU-8 CTCSS UNIT	54
---------------------------------------	----

SPECIFICATIONS**INDEX**

SUPPLIED ACCESSORIES

Accessory	Part Number	Quantity
Microphone U.S.A./Canada/ General (some): MC-53DM ¹	T91-0568-XX	1
China/ General (some): MC-45 ¹	T91-0516-XX	1
DC power cable	E30-2111-XX	1
Transceiver fuse		
TM-261A: 15 A	F51-0017-XX	1
TM-261EJ: 4 A	F51-0013-XX	1
TM-461A: 10 A	F51-0016-XX	1
Mounting bracket	J29-0628-XX	1
Mounting bracket screws	N99-0331-XX	1 set
Wrench	W01-0433-XX	1
Warranty card (U.S.A./Canada only)	—	1
Instruction manual	B62-0605-XX	1

¹ The MC-53DM and MC-45 microphones are sold as optional accessories also {page 53}.

CONVENTIONS FOLLOWED IN THIS MANUAL

The writing conventions described below have been followed to simplify instructions and avoid unnecessary repetition.

ATTENTION: Most procedures require that you press an appropriate key in each step within approximately 10 seconds, or the previous mode will be restored.

Instruction	What to do
Press [KEY].	Press and release KEY .
Press [KEY1]+[KEY2].	Press and hold KEY1 down, then press KEY2 .
Press [KEY1], [KEY2].	Press KEY1 momentarily, release KEY1 , then press KEY2 .
Press [KEY]+ POWER ON .	With transceiver power OFF, press and hold KEY , then turn ON the transceiver power by pressing [POWER].
Press [F] (1 s).	Press and hold the Function key for 1 second or longer.
Press [KEY] (1 s).	Press and hold KEY until the function begins.
Press [F], [KEY] (1 s).	Press [F] momentarily, release [F], then press and hold KEY for 1 second or longer.

PREPARATION FOR MOBILE AND FIXED STATION OPERATION

1 MOBILE INSTALLATION

Install the transceiver in a safe, convenient position inside your vehicle that minimizes danger to your passengers and yourself while the vehicle is in motion. For example, consider installing the transceiver under the dash in front of the passenger seat so that knees or legs will not strike the radio during sudden braking of your vehicle. Try to pick a well-ventilated location that is shielded from direct sunlight.

■ Installation Example

Use the supplied mounting bracket to install the transceiver inside your vehicle. To enjoy the best viewing angle, you can position the transceiver in the bracket in a number of ways as shown below.

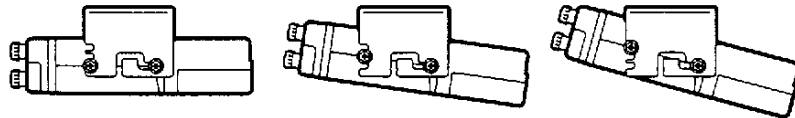

■ Installation Steps

- 1 Install the mounting bracket in the vehicle using the supplied flat washers and self-tapping screws. There are 4 washers and 4 screws supplied.
 - The bracket can be mounted with the bracket opening for the transceiver facing down for underdash mounting, or with the opening facing up.

- If mounted underdash, the bracket must be installed so that the 3 screw holes on the edge of each bracket side are facing forward. This allows you to mount the transceiver horizontally or to angle it forward.
- If mounted with the bracket opening facing upward, position the bracket with the 3 holes facing the rear to angle the transceiver upward. Position the bracket with the 3 holes facing forward if you plan to angle the transceiver downward. The transceiver can be mounted horizontally, angled neither up nor down, with the bracket positioned either way.

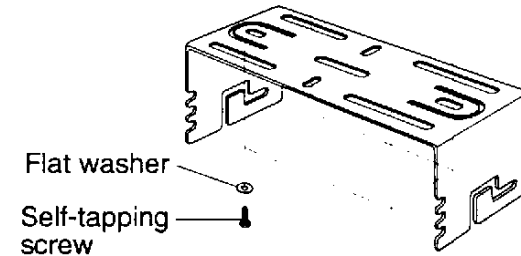

- 2 Position the transceiver, then insert and tighten the supplied hexagon SEMS screws and washers. There are 2 screws and 2 washers supplied for each side of the bracket.
 - Double check that all hardware is tightened to prevent vehicle vibration from loosening the bracket or transceiver.

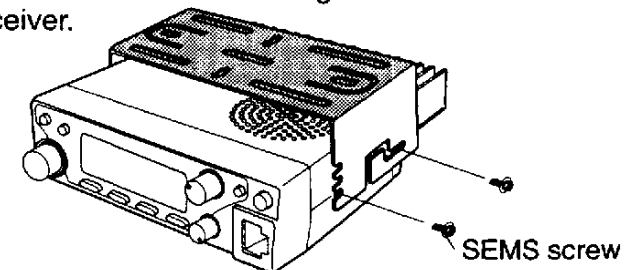

DC POWER CABLE CONNECTION

■ Mobile Operation

The vehicle battery must have a nominal rating of 12 V. Never connect the transceiver to a 24 V battery. Be sure to use a 12 V vehicle battery that has sufficient current capacity. If the current to the transceiver is insufficient, the Display may darken during transmission, or transmit output power may drop excessively.

1 Route the DC power cable supplied with the transceiver directly to the vehicle's battery terminals using the shortest path from the transceiver.

- If using a noise filter, it should be installed with an insulator to prevent it from touching metal on the vehicle.
- It is not recommended to use the cigarette lighter socket since some cigarette lighter sockets introduce an unacceptable voltage drop.
- If the power cable must be routed through a hole in the vehicle chassis or body, for example in the firewall at the front of the passenger compartment, use a rubber grommet to protect the cable from abrasion. Dismantle the fuse holder to pass the cable through the firewall.

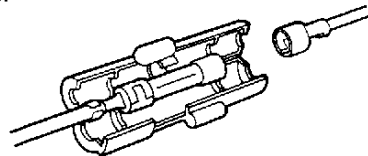

- The entire length of the cable must be dressed so it is isolated from heat and moisture.

- 2 After the cable is in place, wind heat-resistant tape around the fuse holder to protect it from moisture. Tie down the full run of cable.
- 3 To prevent the risk of short circuits, disconnect other wiring from the negative (-) battery terminal before connecting the transceiver.
- 4 Confirm the correct polarity of the connections, and attach the power cable to the battery terminals; red connects to the positive (+) terminal, black connects to the negative (-) terminal.

- Use the full length of the cable without cutting off excess even if the cable is longer than required. In particular, never remove the fuse holders from the cable.

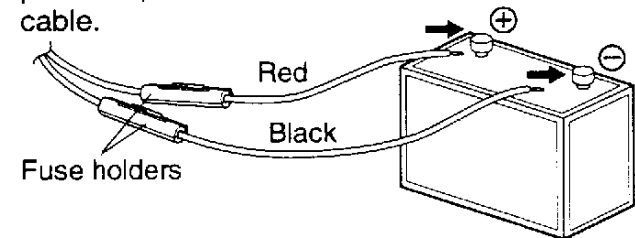

- 5 Reconnect any wiring removed from the negative terminal.
- 6 Connect the DC power cable to the transceiver's power supply connector.

- Press the connectors firmly together until the locking tab clicks.

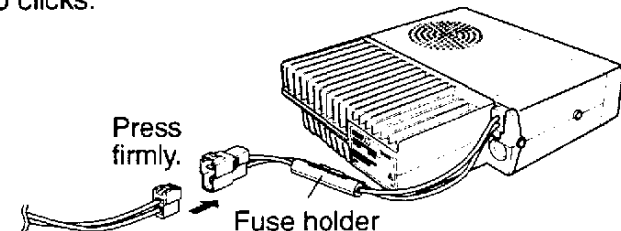

■ Fixed Station Operation

1

In order to use this transceiver for fixed station operation, you will need a separate 13.8 V DC power supply that must be purchased separately.

The following table lists the current capacity recommended for power supplies used with each type of transceiver.

Transceiver Model	Power Supply Capacity
TM-261A	11 A or more
TM-261EJ	4 A or more
TM-461A	10 A or more

1 Connect the DC power cable to the regulated DC power supply and check that polarities are correct (Red: positive, Black: negative).

- DO NOT directly connect the transceiver to an AC outlet!
- Use the supplied DC power cable to connect the transceiver to a regulated power supply.
- Do not substitute a cable with smaller gauge wires.

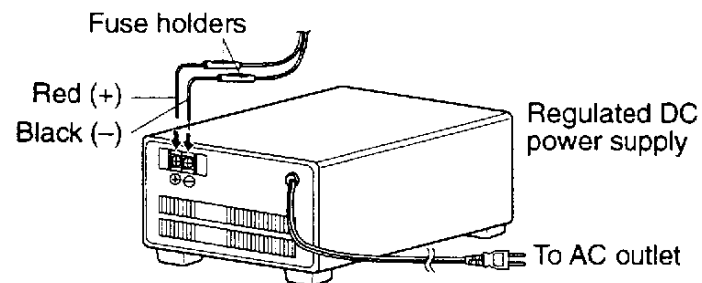

- 2 Connect the transceiver's DC power connector to the connector on the DC power cable.
- Press the connectors firmly together until the locking tab clicks.

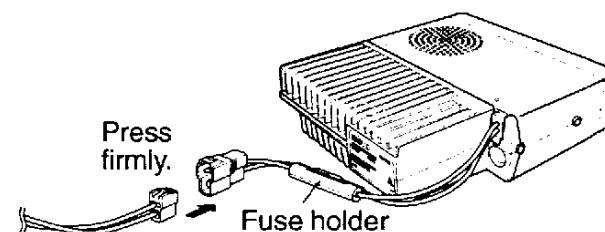

Note:

- ◆ For your transceiver to fully exhibit its performance capabilities, the following optional power supply is recommended: PS-33 (20.5 A, 25% duty cycle).
- ◆ Before connecting the DC power supply to the transceiver, be sure to switch the transceiver and the DC power supply OFF.
- ◆ Do not plug the DC power supply into an AC outlet until you make all connections.

■ Replacing Fuses

If the fuse blows, determine the cause then correct the problem. After the problem is resolved, then replace the fuse. If newly installed fuses continue to blow, disconnect the power cable and contact your dealer or nearest Service Center for assistance.

Fuse Location	Fuse Current Rating
TM-261A	15 A
TM-261EJ	4 A
TM-461A	10 A
Supplied Accessory DC Power Cable	20 A

CAUTION: Only use fuses of the specified type and rating.

Note: If you use the transceiver for a long period when the vehicle battery is not fully charged, or when the engine is OFF, the battery may become discharged, and will not have sufficient reserves to start the vehicle. Avoid using the transceiver under these conditions.

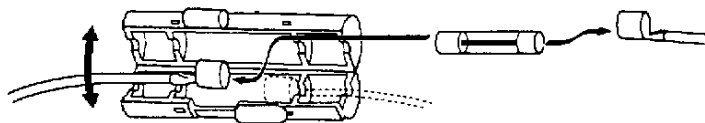

ANTENNA CONNECTION

Before operating, you must first install an efficient, well-tuned antenna. The success of your installation will depend largely on the type of antenna and its correct installation. The transceiver can give excellent results if the antenna system and its installation is given careful attention.

Your choice of antenna should have a 50 Ω impedance to match the transceiver input impedance. Use low-loss coaxial feed line that also has a characteristic impedance of 50 Ω . Coupling the antenna to the transceiver via feed lines having an impedance other than 50 Ω reduces the efficiency of the antenna system, and can cause interference to nearby broadcast television receivers, radio receivers, and other electronic equipment.

CAUTION:

- ◆ Transmitting without first connecting an antenna or other matched load may damage the transceiver. Always connect the antenna to the transceiver before transmitting.
- ◆ All fixed stations should be equipped with a lightning arrester to reduce the risk of fire, electric shock, and transceiver damage.

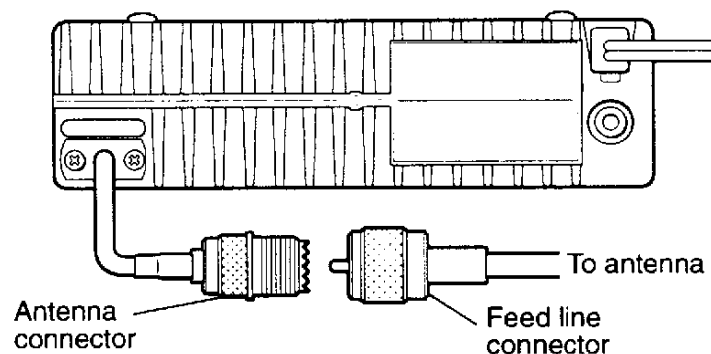

1

ACCESSORY CONNECTIONS

1 ■ External Speaker

If you plan to use an external speaker, choose a speaker with an impedance of $8\ \Omega$. The external speaker jack accepts a 3.5 mm diameter mono (2-conductor) plug. Recommended speakers include the SP-50B and SP-41.

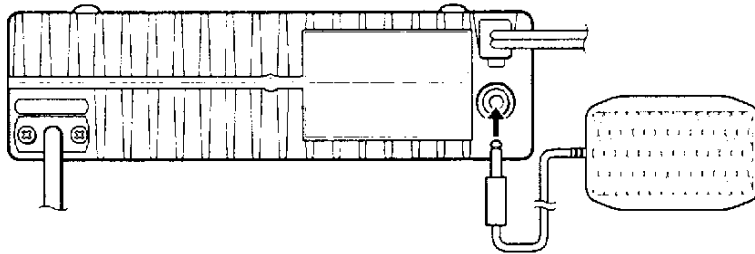

■ Microphone

To communicate in the voice modes, plug a $600\ \Omega$ microphone equipped with an 8-pin modular connector into the modular socket on the Front Panel of the transceiver. Press firmly on the plug until the locking tab clicks.

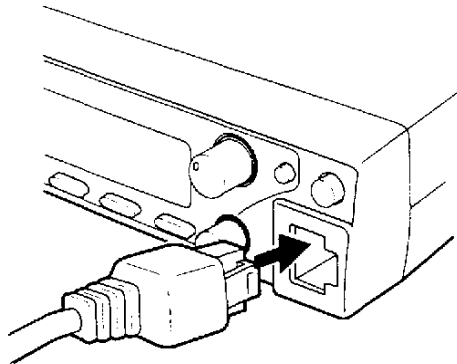

GETTING ACQUAINTED

The following sections describe basic functions of the Front Panel controls and buttons, Rear Panel jacks and connectors, microphone buttons and Display indicators. For full explanations of functions mentioned, refer to the appropriate sections elsewhere in the manual.

FRONT PANEL

The labels for some of the Front Panel buttons appear on the Display instead of on the panel or buttons. The displayed button labels change depending on which mode the transceiver is in. This "GETTING ACQUAINTED" section refers to the buttons that do not have labels on the Front Panel by the labels that appear on the Display immediately after switching ON the transceiver.

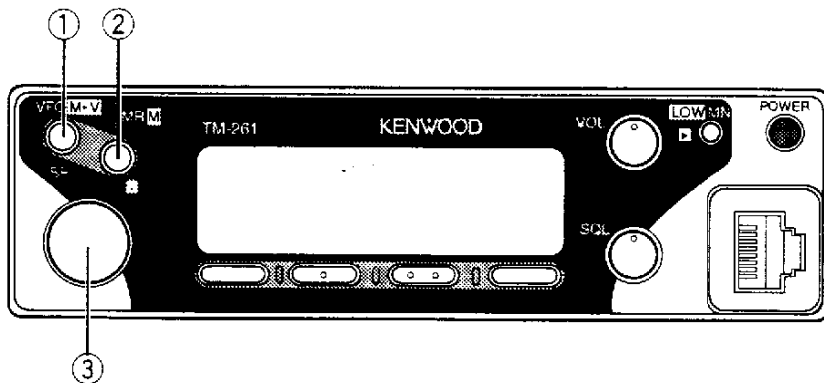

① VFO button

Selects the VFO mode {page 15}. The **Tuning** control changes the transceiver frequency in this mode. Also provides:

- Menu A or Menu B selection of choices {page 17}.
- VFO Scan start/stop to scan the entire VFO range {page 32}.
- Program Scan start/stop to scan a programmed range of frequencies {page 34}.

② MR button

Selects the Memory Recall mode {page 26}. The **Tuning** control changes the memory channel in this mode. Also provides:

- Memory Scan start/stop {page 32}.

③ Tuning control

Selects transmit/receive frequencies while in VFO mode and memory channels while in Memory Recall mode {pages 15, 26}. Also provides:

- Menu A or Menu B selection of function or choices {page 17}.
- Program Scan limits select to choose the boundaries for this type of scan {page 34}.
- Scan direction select to choose if Scan progresses upward or downward in frequency {pages 32, 35}.
- DTSS code select {page 37}.

2

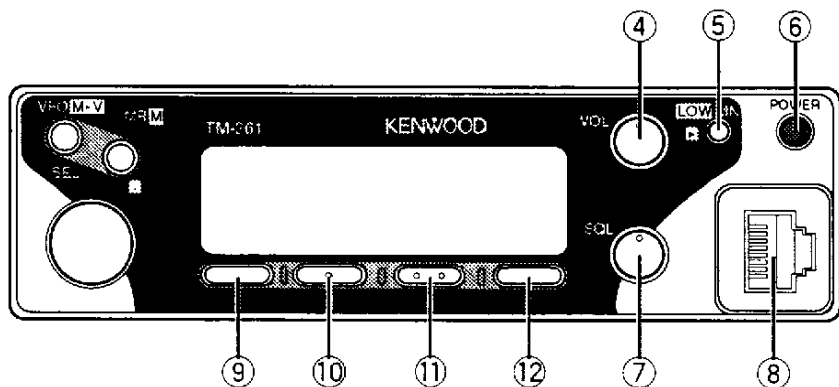

④ VOL control

Adjusts the level of receive audio from the speaker {page 14}.

⑤ MN button

Selects the Memory Name mode {page 30}.

⑥ POWER switch

Switches the transceiver ON or OFF {page 14}.

⑦ SQL (Squelch) control

Adjusts the squelch threshold level {page 14}. This allows you to mute speaker output while no stations are being received.

⑧ Microphone connector

Insert the 8-pin modular connector plug until the locking tab "clicks".

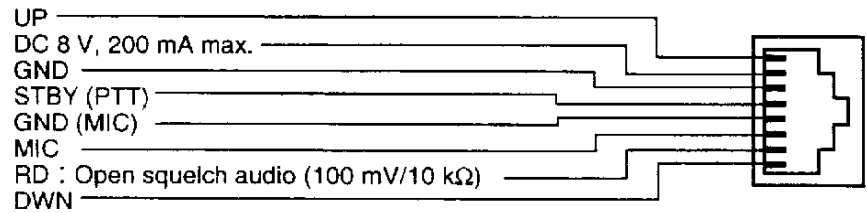

⑨ MHz button

Selects the MHz mode. This mode allows you to use the **Tuning** control or the microphone **[UP]/[DWN]** buttons to change the transceiver frequency in 1 MHz steps.

Also provides:

- AM/FM mode select (some TM-261A versions only) {page 48}.

⑩ F (Function) button

Allows you to select the different functions that are available on multifunction buttons.

⑪ TONE button

Switches the Tone function ON or OFF {page 22}. When the optional TSU-8 is installed, also switches the CTCSS function ON or OFF. Also provides:

- Automatic Tone frequency ID activate/deactivate {page 36}.

⑫ REV (Reverse) button

Switches the transmit frequency and receive frequency when operating with a transmit offset or a split memory channel {page 23}.

REAR PANEL

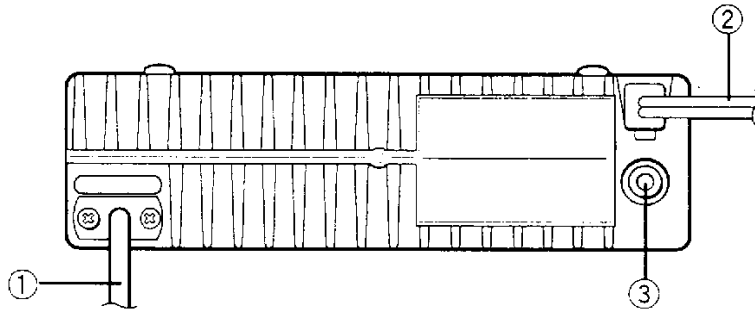

① Antenna cable

Connect an external antenna {page 5}. When making test transmissions, connect a dummy load in place of the antenna. The antenna system or load should have an impedance of 50 Ω . The connector accepts a male PL-259 connector.

② Power Input 13.8 V DC cable

Connect a 13.8 V DC power source. Use the supplied DC power cable {pages 3, 4}.

③ Speaker jack

If you wish, connect an optional external speaker for clearer audio. Accepts a 3.5 mm diameter, 2-conductor plug.

MICROPHONE

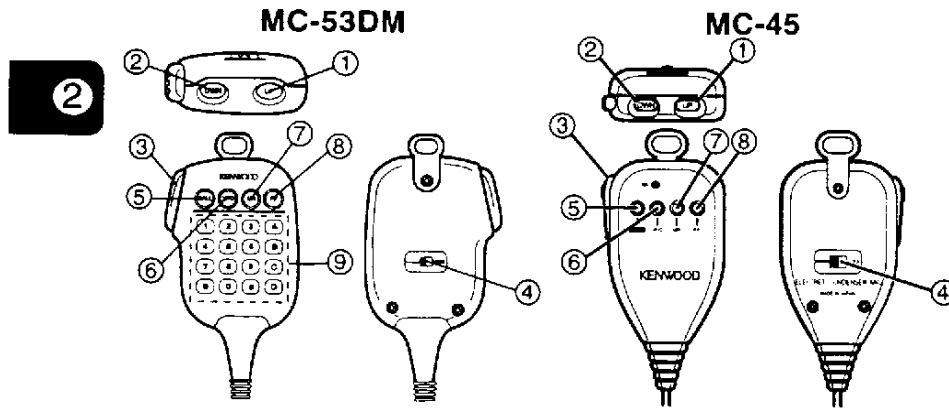

- ① UP button
- ② DWN button

Raises or lowers the VFO frequency, the memory channel number, the Tone/CTCSS frequency, or the DTSS code. Holding either button down causes the action to be repeated. Also, switches between values when selecting values for functions with multiple choices.

- ③ PTT (Push-to-talk) switch

Press to transmit; release to receive. Also used to exit various functions such as Scan, DTSS code select, or Tone/CTCSS frequency select.

- ④ LOCK switch

Locks all microphone functions except [PTT] and the DTMF keypad, if equipped.

- ⑤ CALL key

Recalls the Call channel. Pressing for more than 1 second initiates the Call/VFO Scan {page 35} or the Call/Memory Scan {page 35}.

- ⑥ VFO key
- ⑦ MR key

Identical to the Front Panel functions of the same names. Both keys can be re-programmed, if desired {page 47}.

- ⑧ PF key

Depending on which function you select by accessing "PF" in Menu B {page 48}, the function of this key differs. Refer to "CONFIGURING PROGRAM FUNCTION KEYS" {page 47}.

- ⑨ DTMF keypad (MC-53DM only)

The 16-key keypad is used with the DTMF functions, or to directly enter a frequency or a memory channel number.

DISPLAY

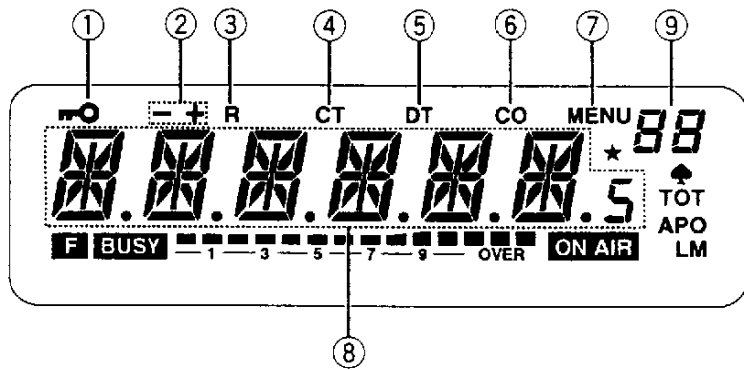

① LO

Indicates the Transceiver Lock function is ON {page 46}.

② - +

Indicates the transmit frequency is offset (different) from the receive frequency {page 22}. The symbol displayed (either “+” or “-”) indicates the direction that the transmit frequency is offset from the receive frequency. “- +” appears when a split-frequency memory channel is selected {page 25}.

③ R

Indicates the Reverse function is ON {page 23}. Transmit and receive frequencies are reversed. If any frequency is selected for “TONE.RX” in Menu B, RX Tone frequency and TX Tone frequency also are reversed. Refer to “Selecting a Tone Frequency” {page 23}.

④ CT

“T” indicates the subaudible Tone encoder function is ON {page 22}. “CT” indicates the CTCSS function is ON {page 36} provided the optional TSU-8 CTCSS unit is installed {page 54}.

⑤ DT

Indicates the Dual Tone Squelch System (DTSS) is ON {page 37}.

⑥ CO

Indicates Carrier-Operated Scan Resume is ON {page 31}. When not visible, Time-Operated Scan Resume is in effect.

⑦ MENU

Visible while accessing Menu A or Menu B {page 17}.

⑧ F . BUSY 1 3 5 7 9 OVER ON AIR

Displays the transmit/receive frequency, frequency step {page 45}, Offset frequency {page 21} and other data. Also displays the menu selections when using Menu Set-Up. The 1 MHz decimal point blinks while the transceiver is scanning {pages 32, 35}.

⑨ 88

Displays the currently selected memory channel number {page 26}. The first digit displays “A” or “B” depending on which Menu is being accessed.

2

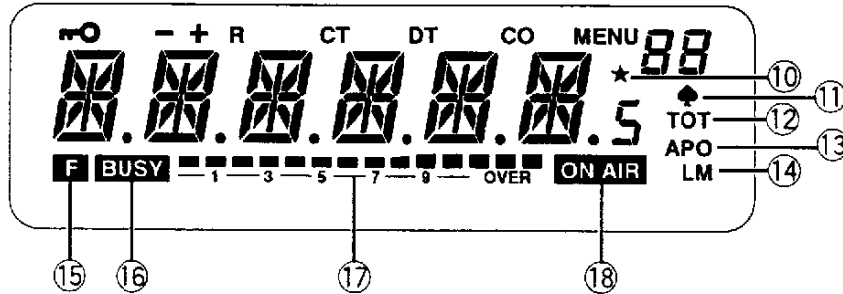

⑩ ★

This icon indicates the selected memory channel is locked-out and will not be scanned by Memory Scan {page 33}.

⑪ ♠

Indicates AM receive mode is ON {page 48}. AM mode is available only on some TM-261A versions only.

⑫ TOT

Indicates the Time-out Timer function is ON {page 46}. Blinks while accessing Menu B, "TOT".

⑬ APO

Indicates the Automatic Power Off function is ON {page 46}.

⑭ LM

Indicates whether Low (L) or Medium (M) transmit output power is selected {page 16}. When neither "L" nor "M" is visible, High output power is selected.

⑮ F

Appears when the [F] button is pressed. Indicates alternate functions of multiple-function buttons can be accessed now.

⑯ BUSY

Indicates the squelch is open and the frequency is "busy". Also appears when the squelch is set to minimum by turning the SQL control fully counterclockwise. If using either CTCSS or DTSS, indicates the squelch is open due to a received signal that contains the same CTCSS tone or DTSS code that is programmed in your transceiver.

⑰ OVER

In Receive, acts as an S-meter to indicate the signal strength of received signals. In Transmit, acts as an RF power meter to indicate the relative transmit output power {page 16}. Full scale represents High transmit power.

⑱ ON AIR

Indicates the transceiver is in Transmit mode with a transmit frequency selected that is within a transmit band.

BUTTON FUNCTION DISPLAY

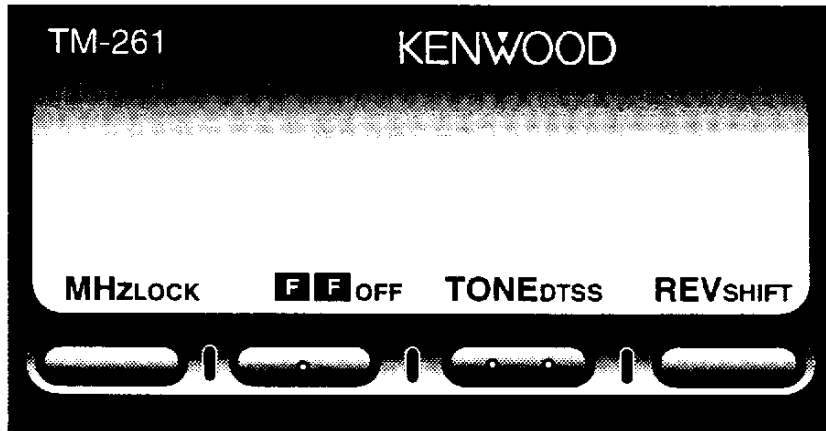

Some of the Front Panel buttons have more than one function. This allows us to provide many functions on your transceiver but keep the transceiver case small. To simplify operation, the lower portion of the Display has labels that indicate the current function of each of the 4 buttons on the lower edge of the Front Panel. The label appears immediately above its corresponding button.

When using any of the alternate functions of the multiple function buttons, you have 10 seconds to select an alternate function after pressing the [F] button. Pressing [F] again or waiting for 10 seconds restores the Basic state with button definitions of [MHz], [F], [TONE], and [REV].

■ Basic State Display Labels

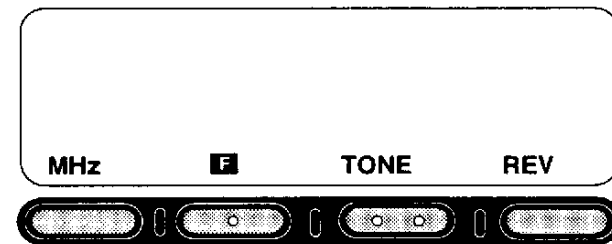

■ Labels After Pressing [F]

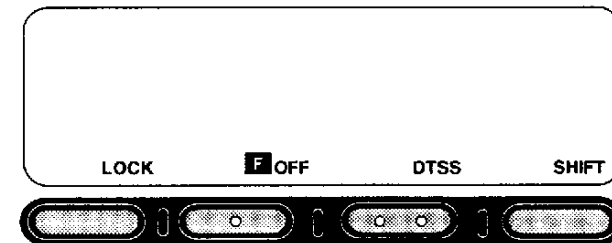

OPERATING BASICS

SWITCHING POWER ON/OFF

- 1 Switch ON the DC power supply.
 - If operating mobile, skip this step.
- 2 Press the **POWER** switch to switch ON the transceiver.

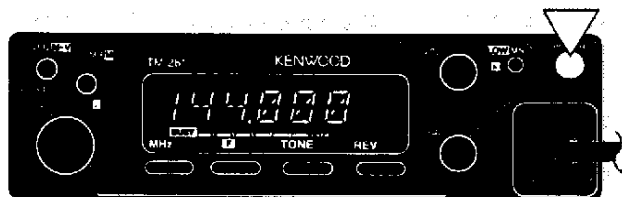

- 3 To switch OFF the transceiver, press the **POWER** switch again.
 - In a fixed installation, after the transceiver has been switched ON, it can then be switched OFF or ON by using only the power switch on the DC power supply.

ADJUSTING VOLUME

Turn the **VOL** control clockwise to increase the audio level and counterclockwise to decrease the level.



ADJUSTING SQUELCH

The purpose of squelch is to silence audio output from the speaker when no signals are present. When squelch is set correctly, you will hear sound only while a station is actually being received. The point at which ambient noise on a frequency just disappears, called the squelch threshold, depends on the frequency.

Turn the **SQL** control clockwise to just eliminate the background noise when no signal is present.

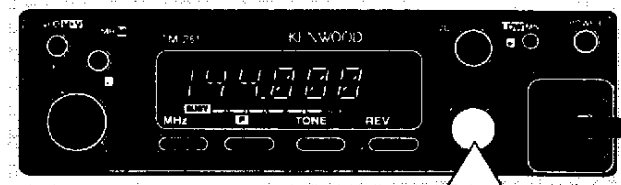

SELECTING FREQUENCIES

■ Tuning Control

Using the **Tuning** control is convenient when you are within easy reach of the transceiver Front Panel, and the frequencies to be selected lie near the current frequency.

- 1 Press **[VFO]** to select VFO mode.

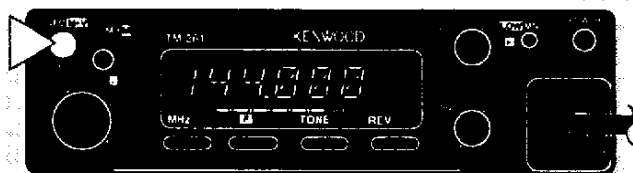

- 2 Turn the **Tuning** control to select a receive frequency.

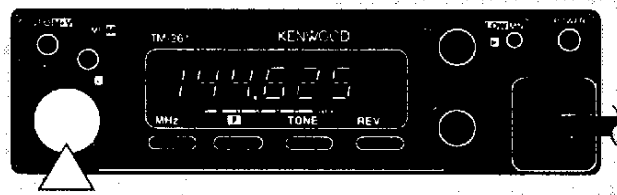

- Clockwise rotation increases the frequency one frequency step at a time.
- Counterclockwise rotation decreases the frequency one step at a time.
- If you cannot select a particular receive frequency, the frequency step size needs to be changed. See "CHANGING FREQUENCY STEP SIZE" (page 45) for further information.

- Frequencies can also be selected via the microphone keypad (MC-53DM only). See "KEYPAD DIRECT ENTRY" (page 43).

■ Microphone **[UP]/[DWN]** Buttons

Using microphone **[UP]/[DWN]** for frequency selection is useful when mobiling or any time you are not immediately in front of the transceiver.

Press **[UP]** or **[DWN]** once to change the receive frequency by one frequency step in the direction indicated by the button.

- Pressing and holding either button causes the frequency to step repeatedly in one direction until the button is released.

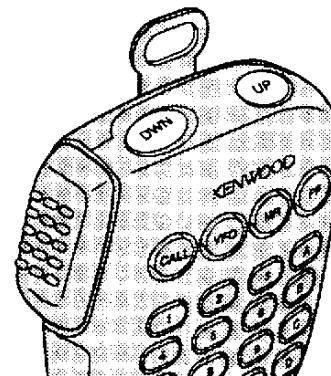

MC-53DM

3

TRANSMITTING

When ready to begin transmitting, press and hold [PTT] and speak in a normal tone of voice. Speaking too close to the microphone, or too loudly, may increase distortion and reduce intelligibility of your signal at the receiving station.

3

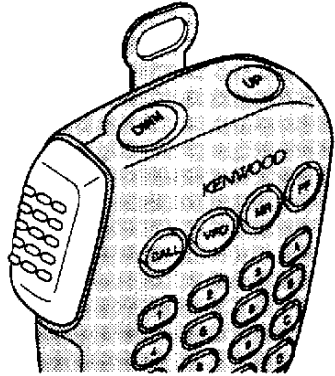

MC-53DM

■ Selecting Output Power

It's wise, and required by law, to select the lowest power that allows reliable communication. If operating from battery power, lower transmit power will give you more operating time before a charge is necessary. Reducing power lowers the risk of interfering with others on the band too.

Press [F], [MN] to select the transmit power you require.

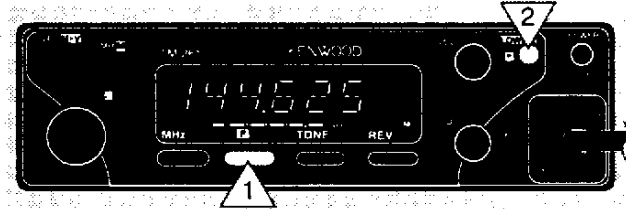

- Each time this key operation is repeated, the transmit power is changed as shown below.

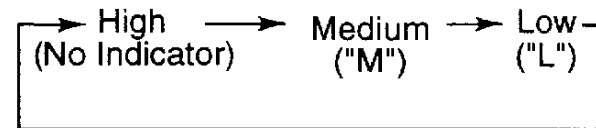

- The transmit power cannot be changed while transmitting.

MENU SET-UP

MENU DESCRIPTION

Many functions on this transceiver are selected or configured via software-controlled menus instead of physical controls on the transceiver. The menus are identified as Menu A and Menu B. Menu A is used to access functions that are frequently changed while Menu B is used for less frequently changed functions.

MENU ACCESS

- 1 To access Menu A, press [F] (1 s).

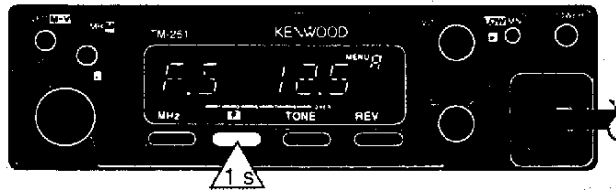

To access Menu B, press [F]+ POWER ON.

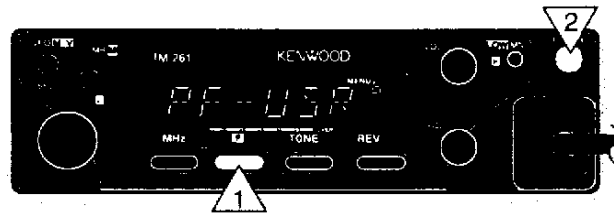

- 2 Select the desired menu function by turning the Tuning control or by pressing microphone [UP]/[DWN].

- 3 The method for selecting the desired menu selection differs depending on which menu function you selected in Step 2.

- To toggle between two selections or to select from three selections, press [VFO].
- To select from more than three selections, press [VFO], then turn the **Tuning** control or press microphone [UP]/[DWN].
- To select for the menu functions listed below, refer to the corresponding reference pages:

DTSS Code (Menu A):

"STORING DTSS CODES" on page 37

Memory Channel Lockout (Menu A):

"Locking Out Memory Channels" on page 33

Program Scan (Menu B):

"PROGRAM SCAN" on page 34

DTMF Number Storing (Menu B):

"STORING DTMF NUMBERS FOR THE AUTOMATIC DIALER" on page 40

DTMF Number Confirmation (Menu B):

"CONFIRMING STORED DTMF NUMBERS" on page 41

- 4 Press [F] or microphone [PTT] to exit Menu A or Menu B.

Note:

- ◆ If neither key strokes are made nor controls are turned within approximately 10 seconds after Menu A or Menu B is accessed, the frequency display is restored.
- ◆ When either Menu A or Menu B is accessed after the Reverse function is activated, Reverse is canceled.

MENU A CONFIGURATION

Menu Label	Description	Selections	Default	Page
F.S	Frequency Step Size ¹	12.5 kHz/ 25 kHz/ 5 kHz/ 10 kHz/ 15 kHz/ 20 kHz	TM-261A (U.S.A./ Canada): 5 kHz TM-261A (General): 12.5 kHz TM-261EJ: 20 kHz TM-461A: 25 kHz	45
O.S	Transmit Offset (Shift)	5 kHz (or 12.5 kHz) ² ~ 20 MHz (using current frequency step size)	TM-261A/TM-261EJ: 600 kHz TM-461A: 5 MHz TM-461A (China): 10 MHz	21
TO	Tone Frequency	Standard 38 Tone frequencies	88.5 Hz	23
DT.C	DTSS Code	000 ~ 999	000	37
CH.D	Channel Display	OFF/ON	OFF	29
SCN	Scan Resume Method	Time-Operated/ Carrier Operated	Time-Operated	31
MR.L	Memory Channel Lockout ³	OFF/ON	OFF	33

¹ Cannot be selected in the Memory Channel mode.

² The minimum selectable offset frequency is dependent on the current frequency step.

³ Cannot be selected in the VFO or Call Channel mode.

MENU B CONFIGURATION

Menu Label	Description	Selections	Default	Page
BEP	Confirmation Beep	OFF/ON	ON	—
TOT	Time-Out Timer	OFF/ON	OFF	46
APO	Automatic Power Off	OFF/ON	OFF	46
ARO	Automatic Repeater Offset ¹	OFF/ON	ON	22
BCL	Busy Channel Lockout	OFF/ON	OFF	46
PF	PF Key Programming	USeR setting/ MONitor/ ENTer	User setting	48
PGM.SCN	Program Scan	Upper limit/ Lower limit	Current VFO frequency	34
DTMF.IN	DTMF Number Storing	16 digits maximum	—	40
DTMF.CK	DTMF Number Confirmation	Stored DTMF number	—	41
TONE.RX	RX Tone Frequency ²	Standard 38 Tone frequencies	OFF	23
DT.D	DTSS Delay Time	350 ms/ 550 ms/ 750 ms	350 ms	39
DT.G	DTSS Group Code	OFF/A/B/C/D/E/F	OFF	38

¹ Available on some TM-261A versions only.

² Available only when the optional TSU-8 is installed.

OPERATING THROUGH REPEATERS

Compared to simplex communication, you can usually transmit over much greater distances by using a repeater. Repeaters are typically located on a mountain top or other elevated location. Often they operate at higher ERP (Effective Radiated Power) than a typical station. This combination of elevation and high ERP allows communications over considerable distances.

5

Repeaters are often installed and maintained by radio clubs, sometimes with the cooperation of local businesses from communications industries. During emergencies, repeater networks can be a valuable aid to officials responsible for coordinating communications in a community.

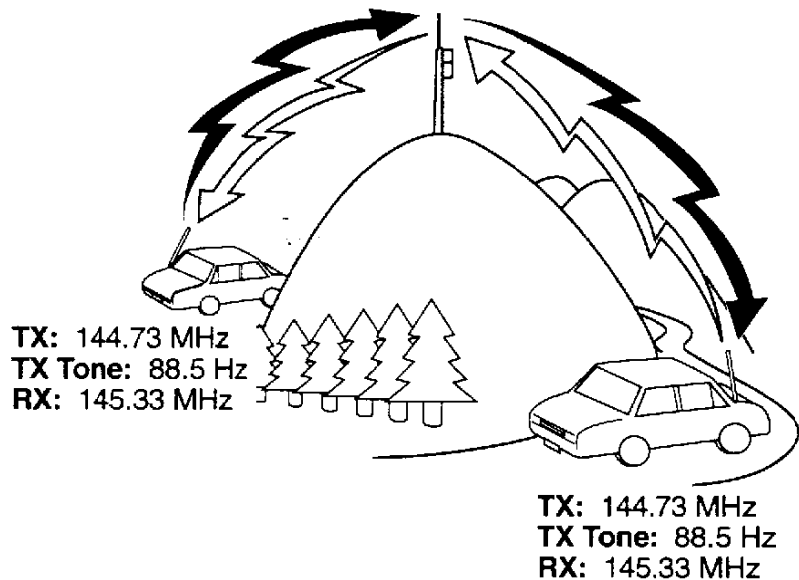

REPEATER ACCESS

Most Amateur Radio voice repeaters use a separate receive and transmit frequency. The transmit frequency may be higher or lower than the receive frequency but the difference in frequencies will be a standard amount, or “standard split”. You can set a separate receive and transmit frequency by selecting the offset frequency and offset direction with respect to the receive frequency. Instead of manually selecting the offset frequency, you can also use Automatic Repeater Offset (some TM-261A versions only).

In addition, some repeaters may require the transceiver to transmit a Tone before the repeater can be used. To transmit this required Tone, activate the Tone function and select a Tone frequency. The required Tone frequency depends on the repeater you are accessing.

Most repeater configurations fall into one of the following categories:

Offset Direction	TM-261A TM-261EJ	TM-461A
+	+600 kHz	+5 MHz (China: +10 MHz)
-	-600 kHz	-5 MHz (China: -10 MHz)

FLOW CHART FOR REPEATER ACCESS

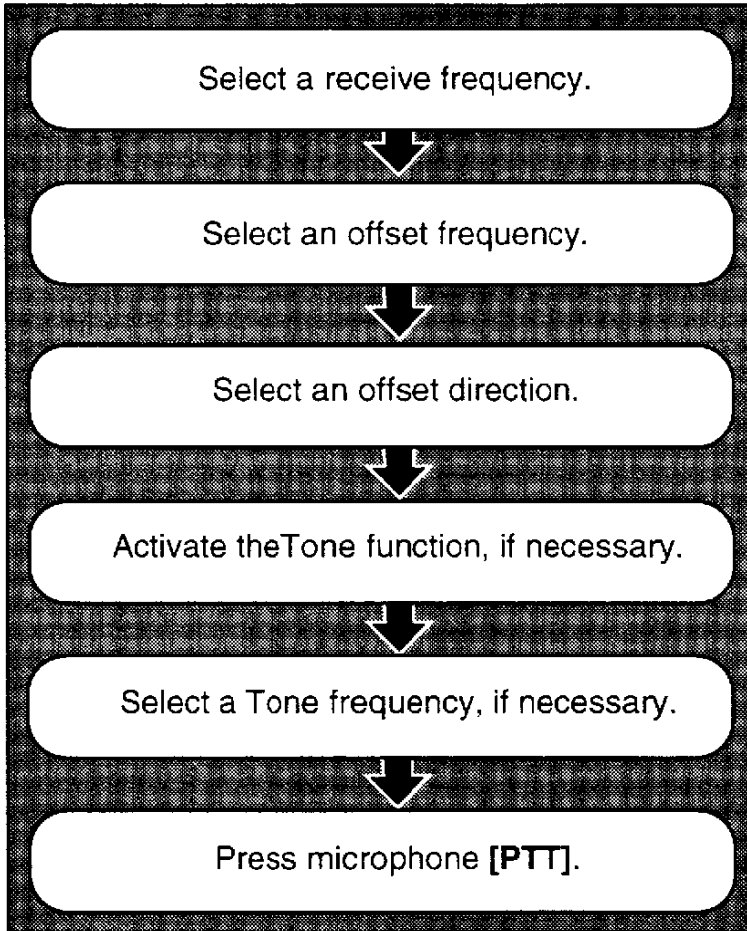

■ Selecting Offset Frequency

Select how much the transmit frequency will be offset from the receive frequency.

- 1 Press [F] (1 s) to access Menu A.
- 2 Select "O.S" {page 17}.
 - The current offset frequency appears.

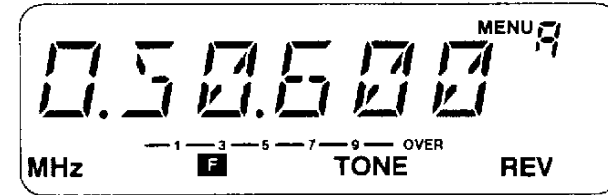

- 3 Select the appropriate offset frequency within 20 MHz of the receive frequency.
 - The setting for "F.S" (Menu A) determines the frequency steps used while you are selecting the offset frequency.
 - The minimum selectable offset frequency is dependent on the current frequency step.
- 4 Press [F] or microphone [PTT] to exit Menu A.

Note: Selections must be made within approximately 10 seconds or the previous mode is restored.

■ Selecting Offset Direction

Select whether the transmit frequency will be higher (+) or lower (-) than the receive frequency.

Press [F], [SHIFT].

- Each time this key operation is repeated, the offset direction changes as shown below.

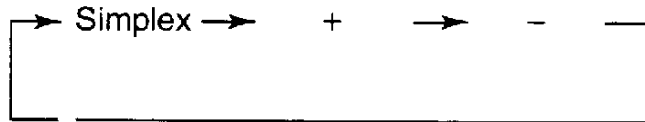

If the offset transmit frequency falls outside the transmit band, transmit is inhibited until the transmit frequency is brought within the band limits by one of the following methods:

- Move the receive frequency further inside the band.
- Reverse the offset direction.

Note: When a split memory channel is currently in use, the offset direction cannot be reversed.

■ Automatic Repeater Offset (Some TM-261A Versions Only)

This function allows the transceiver to automatically take care of setting the required offset direction of the transmit frequency from the receive frequency. Access "ARO" in Menu B in order to toggle Automatic Repeater Offset either ON or OFF {page 17}. The default is ON. The transceiver is programmed for offset direction as shown below.

144.0 145.5 146.4 147.0 147.6
145.1 146.0 146.6 147.4 148.0 MHz

S	-	S	+	S	-	+	S	-
---	---	---	---	---	---	---	---	---

S: Simplex

Note: Automatic Repeater Offset is not activated when CTCSS {page 36} or Reverse {page 23} is ON.

■ Activating Tone Function

Each press of [TONE] switches through the choices shown below.

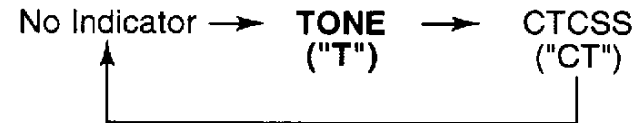

- The CTCSS indicator does not appear if the optional TSU-8 is not installed.

■ Selecting a Tone Frequency

To select the same Tone frequency for transmitting and receiving, access "TO" in Menu A {page 17}. The Tone frequencies listed below can be selected:

No.	Freq. (Hz)	No.	Freq. (Hz)	No.	Freq. (Hz)	No.	Freq. (Hz)
01	67.0	11	97.4	21	136.5	31	192.8
02	71.9	12	100.0	22	141.3	32	203.5
03	74.4	13	103.5	23	146.2	33	210.7
04	77.0	14	107.2	24	151.4	34	218.1
05	79.7	15	110.9	25	156.7	35	225.7
06	82.5	16	114.8	26	162.2	36	233.6
07	85.4	17	118.8	27	167.9	37	241.8
08	88.5	18	123.0	28	173.8	38	250.3
09	91.5	19	127.3	29	179.9		
10	94.8	20	131.8	30	186.2		

- To select a Tone for receiving that is different from the Tone used for transmitting, access "TONE.RX" in Menu B {page 17}, and select a frequency. The frequency selected here is used as the RX Tone frequency, and the frequency selected for "TO" in Menu A is used as the TX Tone frequency.

REVERSE FUNCTION

When used while monitoring a repeater, the Reverse function allows you to manually check the signal strength of a station accessing the repeater. If the station's signal is strong, it's best to move to a simplex frequency to continue the contact and free up the repeater.

Press **[REV]** to toggle the Reverse function ON or OFF.

- The receive frequency and the transmit frequency are exchanged. "R" appears when the function is ON. The default is OFF.

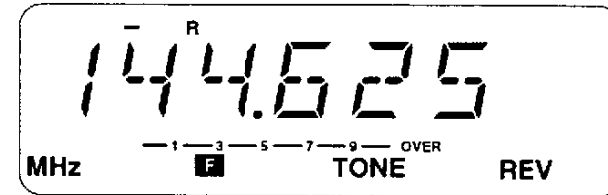

- If any Tone frequency is selected for "TONE.RX" in Menu B, the RX Tone frequency and the TX Tone frequency also are reversed.
- If reversal would place the receive frequency outside the receive frequency range, an error beep sounds when **[REV]** is pressed. No reversal occurs.
- Automatic Repeater Offset does not function while Reverse is ON.

MEMORY CHANNELS

A total of 62 memory channels (1 ~ 62) are available for storing frequencies and related data. Each memory channel can be used either as a simplex channel or split channel for storing any frequency or frequency pair that can be selected on the transceiver. Alternatively, a standard offset and offset direction required for using repeaters can be stored. Refer to "OPERATING THROUGH REPEATERS" {page 20}.

6

STORING DATA IN MEMORY

There are 2 methods of storing transmit/receive frequencies and associated data in memory channels depending on the relationship of the transmit and receive frequencies:

- Simplex memory channels:
RX frequency = TX frequency
- Split memory channels:
RX frequency \neq TX frequency

The data listed below can be stored in each memory channel:

Parameter	Simplex Channel	Split Channel
RX frequency	YES	YES
TX frequency		YES
RX Tone (CTCSS) frequency	YES	YES
TX Tone (CTCSS) frequency	YES	YES
Tone or CTCSS status	YES	YES
Frequency step	YES	YES
Offset direction, Offset status	YES	N/A
Reverse status	YES	N/A
DTSS code, DTSS status	YES	YES
Memory channel name	YES	YES

YES: Can be stored in memory.

N/A: Not applicable

■ Simplex Memory Channels

- 1 Select the desired frequency and associated data (Tone, CTCSS, DTSS, etc.) using VFO mode, Memory Recall {page 26}, or the Call channel {page 27}.
- 2 Press [F] to enter Function Select mode.
 - “F” and a memory channel number appear.

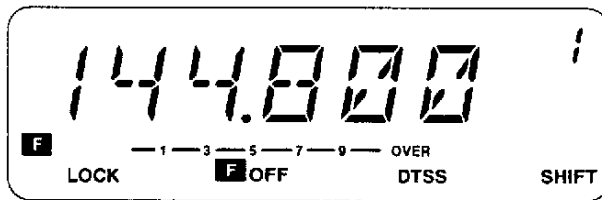

- 3 Turn the **Tuning** control, or press microphone [UP]/[DWN], to select the desired memory channel.
- 4 Press [MR].
 - The selected frequency and associated data are stored in the memory channel. A transmit frequency from a split memory channel or split Call channel is not stored.
 - If the memory channel selected in the previous step already contained data, the new data overwrites the previous data.
 - The previous mode is restored.

Note: After completing each of Steps 2 and 3, you must execute the next step within approximately 10 seconds or the previous mode is restored.

■ Split Memory Channels

- 1 Select the desired receive frequency, and associated data (Tone, CTCSS, DTSS, etc.) using VFO mode, Memory Recall {page 26} or the Call channel {page 27}.
- 2 Press [F] to enter Function Select mode.
 - “F” and a memory channel number appear.
- 3 Turn the **Tuning** control, or press microphone [UP]/[DWN], to select the desired memory channel.
- 4 Press [MR] (1 s).
 - “- +” appears.

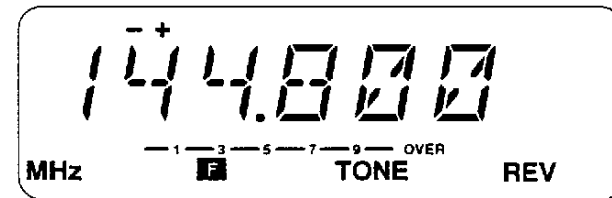

- The channel number is visible if using Memory Recall mode and the Call channel “C” is visible if using Call channel mode in Step 1.
- 5 Turn the **Tuning** control, or press microphone [UP]/[DWN], to select the desired transmit frequency.

6 Press **[MR]**.

- The selected transmit frequency is stored in the memory channel, and the previous mode is restored.
- Associated data selected in Step 1 such as Tone status/frequency, the frequency step, and DTSS status/code are not altered by this step. However, Transmit Offset status and Reverse status are erased.
- Storing a receive frequency in a split memory channel erases any previous data in that channel.

Note: After completing each of Steps 2 ~ 5, you must execute the next step within approximately 10 seconds or the previous mode is restored.

6

RECALLING MEMORY CHANNELS

1 Press **[MR]**.

- The memory channel used last is recalled.

2 Turn the **Tuning** control, or press microphone **[UP]/[DWN]**, to select the desired memory channel.

- Clockwise or microphone **[UP]**: Increases the channel number.
- Counterclockwise or microphone **[DWN]**: Decreases the channel number.
- Empty memory channels cannot be recalled.
- If **[VFO]** is pressed, the VFO mode is restored.

Note:

- ◆ Memory channels can also be recalled via the microphone keypad. See "Memory Channel Number Entry" (page 44).
- ◆ When a split memory channel is recalled, "- +" appears on the Display. Press **[REV]** to display the transmit frequency.

ERASING MEMORY CHANNELS

Although it is possible to overwrite existing data in any of the memory channels with new data, at times you may want to clear data from memory channels without entering new data. It's convenient to clear channels no longer used so you can identify channels that are free for memorizing new frequencies. Memory channels that contain no data cannot be recalled while in Memory Recall.

1 Press **[MR]** to select Memory Recall.

2 Turn the **Tuning** control, or press microphone **[UP]/[DWN]**, to select the desired memory channel.

3 Switch OFF the power to the transceiver.

4 Press **[MHz]+ POWER ON**.

- The contents of the selected memory channel are erased.

Note: Memory channel 1 cannot be erased.

CALL CHANNEL

The Call channel can be used to store any frequency and related data that you want to recall frequently. The Call channel can be programmed with a simplex or split frequency as well as related data that can be stored in the memory channels. No matter what mode the transceiver is in, the Call channel always can be selected quickly. You may want to dedicate the Call channel as an emergency channel within your group. In this case, the Call/VFO scan {page 35} will be useful.

The default frequency stored in the Call channel is shown below.

Version	TM-261A/ TM-261EJ	TM-461A
U.S.A./Canada	144 MHz	440 MHz
China	—	400 MHz or 450 MHz
General	144 MHz	430 MHz

The contents of the Call channel cannot be deleted; however, you can overwrite old data with new data as described in the next section.

■ Recalling the Call Channel

Simply press microphone **[CALL]** to retrieve the contents of the Call channel.

- “C” appears on the Display.

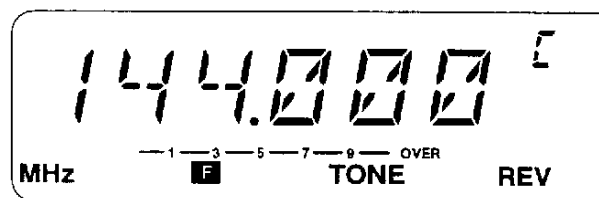

- If microphone **[CALL]** is pressed again, “C” clears and the previous mode is restored.
- The **Tuning** control and microphone **[UP]/[DWN]** do not function while the Call channel is selected.

6

■ Changing Call Channel Contents (Simplex)

- 1 Select the desired frequency and associated data (Tone, CTCSS, DTSS, etc.) using VFO mode or Memory Recall {page 26}.
- 2 Press **[F]**, microphone **[CALL]**.
 - The selected frequency and associated data are stored in the Call channel. A transmit frequency from a split memory channel is not stored.
 - The previous mode is restored.

■ Changing Call Channel Contents (Split)

- 1 Select the desired frequency and associated data (Tone, CTCSS, DTSS, etc.) using VFO mode or Memory Recall {page 26}.
- 2 Press [F], microphone [CALL] (1 s).
 - “- +” appears.

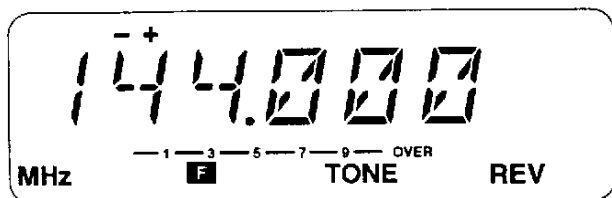

- 3 Turn the **Tuning** control, or press microphone [UP][DWN], to select the desired transmit frequency.
- 4 Press microphone [CALL].
 - The selected transmit frequency is stored in the Call channel, and the previous mode is restored.
 - Associated data selected in Step 1 such as Tone status/frequency, the frequency step, and DTSS status/code are not altered by this step. However, Transmit Offset status and Reverse status are erased.

Note: After completing each of Steps 2 and 3, you must execute the next step within approximately 10 seconds or the previous mode is restored.

MEMORY → VFO TRANSFERS

Transferring the contents of a memory channel or the Call channel to the VFO can be useful if you want to search for other stations or a clear frequency near the selected memory channel or Call channel frequency.

- 1 Press [MR] to select Memory Recall. If you want to select the Call channel, press microphone [CALL].
- 2 Recall the desired memory channel by turning the **Tuning** control or pressing microphone [UP][DWN].
 - This step is not necessary if the Call channel was selected in Step 1.
- 3 Press [F], [VFO].
 - The complete contents of the memory channel or the Call channel are copied to the VFO. VFO mode is selected after the transfer is completed.
 - A transmit frequency from a split memory channel or split Call channel is not transferred to the VFO.

INITIALIZING MEMORY

If your transceiver seems to be malfunctioning, initializing the transceiver may resolve the problem.

Remember that initializing the memory channels requires that you re-enter any memory channel data again after the initialization, if you want to use those channels. On the other hand, to erase all data from all channels, initialization is a quick way to do this.

■ Partial Reset (VFO)

To initialize all settings except the memory channels, the Call channel, and the Menu settings, press **[VFO]+ POWER ON**.

■ Full Reset (Memory)

1 To initialize all settings, press **[MR]+ POWER ON**.

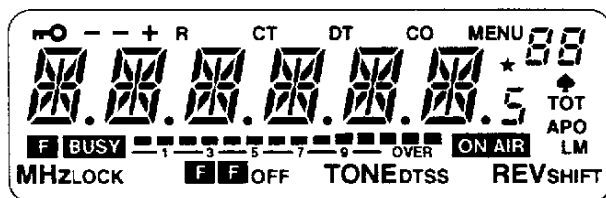

- 2 While the display shown above is visible, press **[MR]** again.
- The VFO, memories, and Menu settings are reset.

Note: After the display shown above appears, you must execute Step 2 within approximately 10 seconds or the Full Reset will be aborted and the previous mode will be restored.

Defaults

	Version	VFO Frequency	Frequency Step	Tone Frequency
TM-261A	U.S.A./Canada	144 MHz	5 kHz	88.5 Hz
	General	144 MHz	12.5 kHz	88.5 Hz
TM-261EJ	General	145 MHz	20 kHz	88.5 Hz
TM-461A	U.S.A./Canada	440 MHz	25 kHz	88.5 Hz
	China	400 MHz or 450 MHz	25 kHz	88.5 Hz
	General	430 MHz	25 kHz	88.5 Hz

6

CHANNEL DISPLAY FUNCTION

When this function is switched ON, the transceiver selects Memory Recall and displays only a memory channel number instead of a frequency.

With the Channel Display function ON, memory channels can be selected using the **Tuning** control or microphone **[UP][DWN]** as usual. Only memory channels containing data can be selected.

Access "CH.D" in Menu A to toggle the function ON or OFF {page 17}.

NAMING MEMORY CHANNELS

You can name memory channels using up to 6 characters and 5 dots. When you recall a named memory channel, its name appears on the display instead of the stored frequency. Names can be callsigns, repeater names, cities, persons' names, etc.

■ Storing a Name in Memory

- 1 Press **[MR]** to select Memory Recall.
- 2 Turn the **Tuning** control, or press microphone **[UP]/[DWN]**, to select the desired memory channel.
- 3 Switch OFF the power to the transceiver.
- 4 Press **[MN]+ POWER ON**.
 - The first digit blinks.

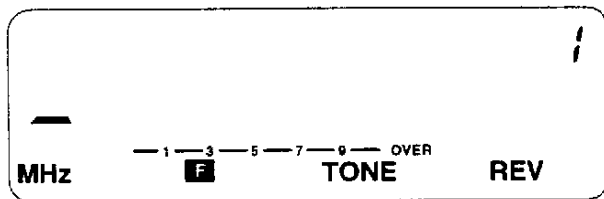

- 5 Turn the **Tuning** control, or press microphone **[UP]/[DWN]**, to select the first digit.
 - To enter a dot after the first digit, press **[MR]**. Pressing **[MR]** again clears the dot.
- 6 Press **[MN]**.
 - The second digit blinks.

- 7 Repeat Steps 5 and 6 to enter up to 6 digits.
 - When you enter less than 6 digits, press **[MHz]**, **[F]**, **[TONE]**, **[REV]**, or microphone **[PTT]** to complete entry.
 - To re-enter the preceding digit, press **[VFO]**.
 - A dot cannot be entered after the sixth digit.

After storing a name, pressing **[MN]** toggles between name display and frequency display for the memory channel.

Note:

- ◆ If you do not enter the next digit within 10 seconds, the digits already entered are stored and the entry cursor is cleared.
- ◆ Names can be assigned only to memory channels in which you have stored frequencies and related data.
- ◆ The stored names can be overwritten by repeating Steps 1 ~ 7.
- ◆ The stored names also are erased by clearing memory channels (page 26).

SCAN

Scan is a useful feature for hands-off monitoring of your favorite frequencies. After becoming comfortable with how to use all types of Scan, the monitoring flexibility gained will increase your operating efficiency.

This transceiver provides the following types of Scan:

Scan Type	Purpose
VFO Scan	General update on band activity.
Memory Scan	Quick activity update of your favorite frequencies.
Program Scan	Similar to VFO Scan except over a narrower segment of the band.
Call/VFO Scan	Monitor the Call channel plus any VFO frequency.
Call/Memory Scan	Monitor the Call channel plus any Memory channel.

Note:

- ◆ Remember to adjust the squelch threshold level (page 14) before using Scan.
- ◆ Always turn OFF Monitor (page 48) before using Scan.
- ◆ For CTCSS operation (page 36), Scan stops for any signal received; however the squelch opens only for signals that contain the same CTCSS Tone that is stored in your transceiver.
- ◆ For DTSS operation (page 37), Scan stops for any signal received; however, the squelch opens only for signals that contain the same DTSS code that is stored in your transceiver.
- ◆ When both CTCSS and DTSS are ON, Scan stops for signals that contain the matching CTCSS Tone. However, the squelch opens only when the matching DTSS code is received.

SCAN RESUME METHODS

Before using Scan, it's necessary to decide under what condition you want your transceiver to continue scanning after detecting and stopping for a signal.

Access "SCN" in Menu A to choose Time-Operated Scan or Carrier-Operated Scan. The default is Time-Operated Scan (page 17).

■ Time-Operated Scan

Your transceiver stops scanning after detecting a signal, remains there for approximately 5 seconds, and then continues to scan even if the signal is still present.

■ Carrier-Operated Scan

Your transceiver stops scanning after detecting a signal and remains on the same frequency until the signal drops out. There is a 2 second delay between signal drop-out and scan resumption to allow time for any responding stations to begin transmitting.

Note:

- ◆ Turning the **Tuning** control clockwise, or pressing microphone [UP] after a signal that has stopped Scan clears, causes scanning to resume immediately upward.
- ◆ Turning the **Tuning** control counterclockwise, or pressing microphone [DWN] after a signal that has stopped Scan clears, causes scanning to resume immediately downward.

VFO SCAN

VFO Scan allows you to scan all frequencies from the lowest frequency to the highest frequency on the band. The current frequency step size is used.

- 1 Press **[VFO] (1 s)**, and Scan starts at the frequency currently displayed.
 - The 1 MHz decimal blinks while scanning is in progress.
- 2 To reverse the scan direction, turn the **Tuning** control or press microphone **[UP]/[DWN]**.
 - Upward scan:
Turn the **Tuning** control clockwise, or
Press microphone **[UP]**.
 - Downward scan:
Turn the **Tuning** control counterclockwise, or
Press microphone **[DWN]**.
- 3 To cancel VFO Scan, press any key other than microphone **[UP]/[DWN]**.

Note: *Squelch must be closed for Scan to function {page 14}.*

MEMORY SCAN

Memory Scan allows all memory channels containing data to be scanned.

- 1 Press **[MR] (1 s)**.
 - The 1 MHz decimal blinks while scanning is in progress.
 - Scan starts with the channel last recalled.
- 2 To reverse the scan direction, turn the **Tuning** control or press microphone **[UP]/[DWN]**.
 - Upward scan:
Turn the **Tuning** control clockwise, or
Press microphone **[UP]**.
 - Downward scan:
Turn the **Tuning** control counterclockwise, or
Press microphone **[DWN]**.
- 3 To cancel Memory Scan, press any key other than microphone **[UP]/[DWN]**.

Note:

- ◆ *At least 2 or more memory channels must contain data and must not be locked out.*
- ◆ *The squelch must be closed for Scan to function {page 14}.*

■ Locking Out Memory Channels

Memory channels that you prefer not to monitor while scanning can be locked out. Lock out any memory channel with the following procedure.

- 1 Press **[MR]** to select Memory Recall.
- 2 Select the memory channel to be locked out by using the **Tuning** control or microphone **[UP]/[DWN]**.
- 3 Press **[F]** (1 s) to access Menu A.
- 4 Select "MR.L" {page 17}.

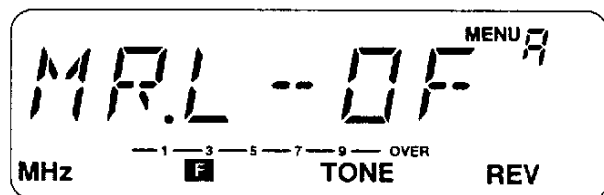

- 5 Press **[VFO]** to lock out the selected channel.

- A star icon appears which indicates that the channel has been locked out.

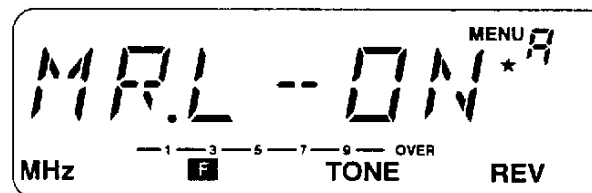

- Each press of **[VFO]** toggles the lockout status ON and OFF.

- 6 Press **[F]** or microphone **[PTT]** to exit Menu A.

Lockout for an individual channel can be canceled by repeating the above procedure.



PROGRAM SCAN

This type of scan is similar to VFO Scan except the programmable aspect allows you to set scan limits to limit the frequency range of the scan.

■ Setting Scan Limits

- 1 Press **[F]+ POWER ON** to access Menu B.
- 2 Select "PGM.SCN" {page 17}.
- 3 Press **[VFO]**.
 - "LO" and the current lower limit appears. The default is the currently selected frequency.

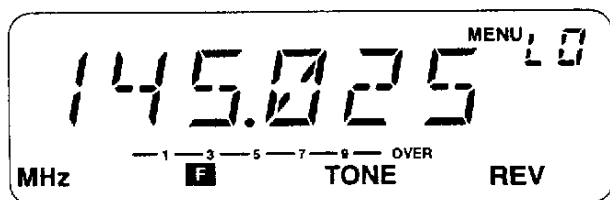

- 4 Turn the **Tuning** control, or press microphone **[UP]/[DWN]**, to display the desired lower limit.
 - Press **[MHz]** if you want to change the frequency in 1 MHz steps.
- 5 Press **[VFO]**.
 - "UP" and the current upper limit appears. The default is the currently selected frequency.

- 6 Turn the **Tuning** control, or press microphone **[UP]/[DWN]**, to display the desired upper limit.
 - Press **[MHz]** if you want to change the frequency in 1 MHz steps.
- 7 Press **[VFO]** to set the upper limit.
- 8 Press **[F]** or microphone **[PTT]** to exit Menu B.

Note:

- ◆ The lower limit must be lower in frequency than the upper limit.
- ◆ The lower and upper frequency steps must be equal.
- ◆ Selections must be made within approximately 10 seconds or the previous mode is restored.

■ Confirming Scan Limits

- 1 Press **[F]+ POWER ON** to access Menu B.
- 2 Select "PGM.SCN" {page 17}.
- 3 Press **[VFO]**.
 - This is the lower limit.
- 4 Press **[VFO]** again.
 - This is the upper limit.
- 5 Press **[F]** or microphone **[PTT]** to exit Menu B.

■ Using Program Scan

- 1 Select a frequency equal to or between the programmed scan limits.
- 2 Press **[VFO] (1 s)**, and Scan starts at the frequency currently displayed.
 - The 1 MHz decimal blinks while scanning is in progress.
- 3 To reverse the scan direction, turn the **Tuning** control or press microphone **[UP]/[DWN]**.
 - Upward scan:
Turn the **Tuning** control clockwise, or
Press microphone **[UP]**.
 - Downward scan:
Turn the **Tuning** control counterclockwise, or
Press microphone **[DWN]**.
- 4 To cancel Program Scan, press any key other than microphone **[UP]/[DWN]**.

Note:

- ◆ *Squelch must be closed for Scan to function (page 14).*
- ◆ *When the frequency step of the current VFO frequency differs from the frequency step of the programmed frequencies, the step size of the programmed frequencies is used for scanning. After terminating the Scan function, the step size of the VFO frequency is reset to the step size of the programmed frequencies.*

CALL/VFO SCAN

Use Call/VFO Scan to monitor both the Call channel and the current VFO frequency on the selected band.

- 1 Press **[VFO]** to select VFO mode.
- 2 Press microphone **[CALL] (1 s)** to start Call/VFO Scan.
 - The 1 MHz decimal blinks while scanning is in progress.
- 3 To cancel Call/VFO Scan, press any key other than microphone **[UP]/[DWN]**.

CALL/MEMORY SCAN

Use Call/Memory Scan to monitor both the Call channel and the memory channel last used.

- 1 Press **[MR]** to select Memory Recall mode.
- 2 Press microphone **[CALL] (1 s)** to start Call/Memory Scan.
 - The 1 MHz decimal blinks while scanning is in progress.
- 3 To cancel Call/Memory Scan, press any key other than microphone **[UP]/[DWN]**.

7

CONTINUOUS TONE CODED SQUELCH SYSTEM (CTCSS)

CTCSS is available only when the optional TSU-8 unit is installed {page 54}. CTCSS allows you to choose which stations will receive your transmissions. Suppose that only stations "A", "B", and "C" are programmed with the same RX Tone frequency, and this frequency is identical to the TX Tone frequency. When "A" calls, the squelch on only "B" and "C" opens. Or, these same stations could be programmed as follows:

"A": 91.5 Hz (RX)

"B": 100.0 Hz (RX) / 91.5 Hz (TX)

"C": 103.5 Hz (RX) / 91.5 Hz (TX)

In this example, "A" can call either "B" or "C" individually by selecting 100.0 Hz TX Tone or 103.5 Hz TX Tone.

8 USING CTCSS

- 1 Select the desired RX and TX Tone frequencies {page 23}.
- 2 Repeatedly press [TONE] until "CT" appears on the Display. Each press of [TONE] switches through the choices shown below.

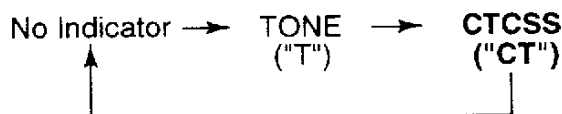

- The CTCSS indicator does not appear if the CTCSS unit is not installed.

3 When you are called:

The squelch of your transceiver opens only when the selected RX Tone is received.

When you make a call:

Press and hold microphone [PTT].

- The selected TX Tone is superimposed on your transmitted signal.

Note: When using DTSS with CTCSS, the squelch opens only if the correct Tone is received and the received DTSS code matches the code stored in your transceiver.

■ Automatic Tone Frequency ID

This function automatically identifies the incoming Tone frequency on a received signal.

- 1 Press [TONE] (1 s) to toggle the function ON or OFF.
 - A Tone frequency display replaces the frequency display and the 10 kHz decimal begins blinking.
 - When a signal is received, the transceiver begins scanning through all Tone frequencies in order to identify the Tone frequency that is being received. When the frequency is identified, an alarm beeps, and the Display begins blinking.
- 2 Press any key to cancel the function.
 - When OFF is selected for "TONE.RX" in Menu B {page 17}, the Tone frequency selected for "TO" in Menu A is replaced by the Tone frequency automatically identified in Step 1.
 - When any Tone frequency is selected for "TONE.RX" in Menu B {page 17}, this frequency is replaced by the Tone frequency automatically identified in Step 1. The Tone frequency selected for "TO" in Menu A is not changed.

DUAL TONE SQUELCH SYSTEM (DTSS)

DTSS provides another method to selectively communicate with specific stations. The squelch on the transceiver opens only when the same 3-digit DTMF (Dual Tone Multi-Frequency) code is received that is programmed in this transceiver. You can select a 3-digit code from among 1000 combinations, 000 to 999.

STORING DTSS CODES

Note:

- ◆ Be aware that audible DTMF tones from other transceivers near you may be picked up by your MC-53DM or MC-45 microphone. If so, this could prevent the functions described in this chapter from working correctly.
- ◆ DTSS does not function while you are storing DTSS codes even if a code is received that matches one already stored in memory.

■ Using the Tuning Control or Microphone [UP]/[DWN]

- 1 Press [F] (1 s) to access Menu A.
- 2 Select "DT.C" {page 17}.
 - The current DTSS code appears. The default is 000.

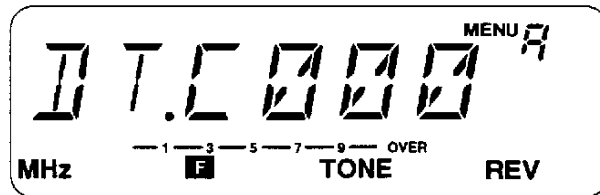

- 3 Press [VFO].
 - The first digit blinks.
- 4 Use the **Tuning** control or microphone [UP]/[DWN] to select the first digit.
- 5 Repeat Steps 3 and 4 to select the second and third digits.
- 6 Press [VFO] again to complete your selection.
- 7 Press [F] or microphone [PTT] to exit Menu A.

■ Using the Microphone DTMF Keypad

This function can be used only when the MC-53DM microphone is used.

- 1 Press [F] (1 s) to access Menu A.
- 2 Select "DT.C" {page 17}.
 - The current DTSS code appears. The default is 000.
- 3 Press [VFO].
 - The first digit blinks.
- 4 Press the correct numeric digit to select the first digit.
- 5 Repeat Step 4 to select the second and third digits.
- 6 Press [F] or microphone [PTT] to exit Menu A.

Note: If you press buttons other than microphone [UP]/[DWN] and the microphone numeric keys, or if you do not make a DTSS code entry within 10 seconds, the previous mode is restored. Digits already entered will be stored.

■ Setting a Group Code

By programming a Group code, you can simultaneously pass information to a number of stations. You may program an alphabetic character, such as “A”, as one of the digits in your transceiver’s Group code. In the following example, if you sent “12A”, or “1A3”, or “A23”, the squelch would open on transceivers that are programmed with the following DTMF codes respectively:

12A: 120, 121, 122, 123, 124, 129

1A3: 103, 113, 123, 133, 143, 193

A23: 023, 123, 223, 323, 423, 923

You can also program a Group code that includes two or three identical alphabetic characters such as “3AA”. In this example, the squelch would open on transceivers that are programmed as follows:

300, 301, 302, 303, 304, 305, 309

310, 311, 312, 313, 314, 315, 319

⋮
⋮
⋮
⋮
⋮
⋮

390, 391, 392, 393, 394, 395, 399

You may be called by other transceivers that have DTMF functions and can send a Group code. Let us assume that you program “333” and select “A” (DT.G, Menu B). In this example, the squelch on your transceiver would open when the following DTMF codes are received:

333, A33, 3A3, 33A, 3AA, AA3, A3A, AAA

- 1 Press **[F]+ POWER ON** to access Menu B.
- 2 Select “DT.G” {page 17}.

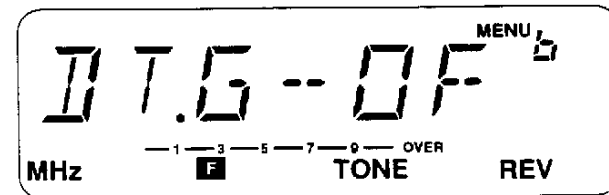

- 3 Press **[VFO]**.
 - “OF” blinks.
- 4 Turn the **Tuning** control, or press microphone **[UP]/[DWN]** to select A, B, C, D, E, or F.
- 5 Press **[F]** or microphone **[PTT]** to exit Menu B.
- 6 Store a Group code that includes the digit selected in Step 4, using one of the methods described in the preceding sections.

USING DTSS

- 1 Store the appropriate DTSS code {page 37}.
 - To make a Group call, select the common Group digit {page 38}.
- 2 Press [F], [DTSS].
 - "DT" appears when DTSS is ON.

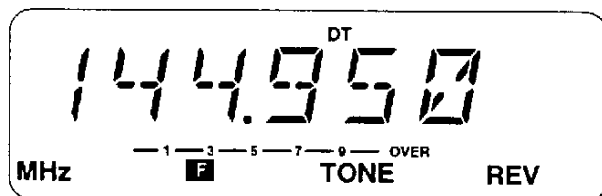

- Each time this button combination is pressed, DTSS is toggled ON and OFF.
- 3 **When you are called:**

The squelch of your transceiver opens only when the stored DTSS code is received.

 - If, after DTSS has opened the squelch, no signal is received for more than 2 seconds, the squelch then closes.

When you make a call:

Press and hold microphone [PTT] to transmit your DTSS code.

- Each time [PTT] is pressed, the DTSS code is transmitted for about 0.5 second. After establishing a contact, you can eliminate this by switching the DTSS function OFF.

Note:

- ◆ DTSS may not function in the following situations:
 - The other station is using a battery saver function.
 - A repeater ID and the DTSS code are received simultaneously. If difficulty is experienced in these cases, press [TONE] while in the transmit mode. The DTSS code is re-transmitted.
- ◆ DTSS cannot be used with some repeaters.
- ◆ DTSS also may not function if buttons are pressed or the VOL control is turned while a valid DTSS code is received.
- ◆ Both DTSS status and a DTSS code can be stored in a memory channel or the Call channel.

■ DTSS and Repeaters

Pressing [PTT] transmits the DTSS signal after a short delay. This delay helps avoid losing DTSS data when using repeaters with long response times that may miss receiving a portion of the DTSS code. The delay time is 250 ms during simplex operation.

When using a transmit offset or a split frequency, you can select either 350 ms (default), 550 ms, or 750 ms. Access "DT.D" in Menu B {page 17}.

DUAL TONE MULTI-FREQUENCY (DTMF) FUNCTIONS

The following DTMF functions require an MC-53DM microphone. The keypads on the microphone include the 12 keys found on a push-button telephone plus an additional 4 keys (A, B, C, D). These additional keys are required for various control operations by some repeater systems.

MAKING DTMF CALLS

To make a DTMF call, hold down the microphone [PTT] and press [0] ~ [9], [A], [B], [C], [D], [*], or [#].

- The corresponding DTMF tones are transmitted.

STORING DTMF NUMBERS FOR THE AUTOMATIC DIALER

To store a DTMF number with up to a maximum of 16 digits in any of 10 dedicated DTMF memories, follow the procedure below.

Note that audible DTMF tones from other transceivers near you may be picked up by your MC-53DM or MC-45 microphone. If so, this could prevent the following function from working correctly.

- 1 Press [F]+ **POWER ON** to access Menu B.
- 2 Select "DTMF.IN" {page 17}.

- 3 Press [VFO].

- The display for entering DTMF numbers appears.

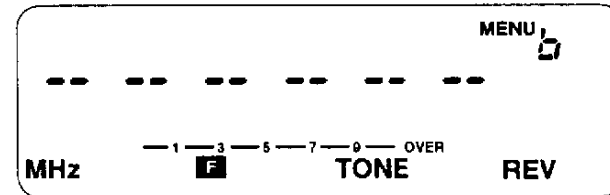

- 4 Use the keypad to enter the digits of the number to be stored.

- The corresponding DTMF tones are heard.
- If you enter an incorrect digit, press microphone [MR] to erase all digits entered.

- 5 Press microphone [PF].

- The display for selecting a memory channel appears.

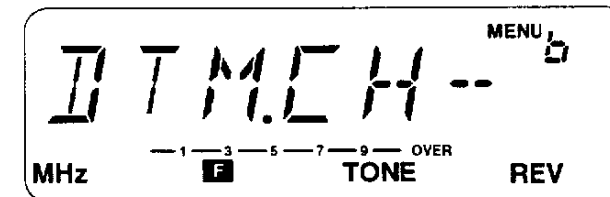

- 6 Press a single key [0] ~ [9] to select a DTMF memory channel.
 - The selected memory channel number appears and stays for approximately 1 second, then the display for entering DTMF numbers is restored.
- 7 Press [VFO] to restore the Menu B Scroll display, or wait for several seconds to restore the frequency display.

CONFIRMING STORED DTMF NUMBERS

- 1 Press [F]+ POWER ON to access Menu B.
- 2 Select "DTMF.CK" {page 17}.
- 3 Press [VFO].
 - The display for confirming DTMF numbers appears.

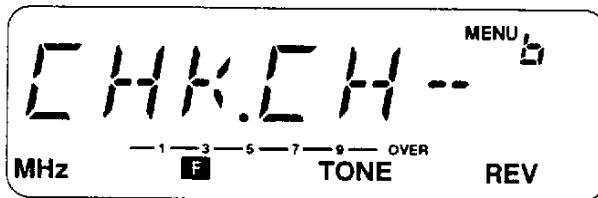

- 4 Press a single key [0] ~ [9] to select a DTMF memory channel.
 - The entered memory channel number appears and stays for approximately 1 second, then the numbers stored in the channel scroll across the Display.
 - The corresponding DTMF tones are output from the speaker.
 - After the scrolling is completed, the display for confirming DTMF numbers is restored.

- 5 Press [VFO] to restore the Menu B Scroll display, or wait for several seconds to restore the frequency display.

TRANSMITTING STORED DTMF NUMBERS

To transmit a stored DTMF number, follow the procedure below.

- 1 Press microphone [PTT]+[PF].
 - The display for selecting a DTMF memory channel appears.

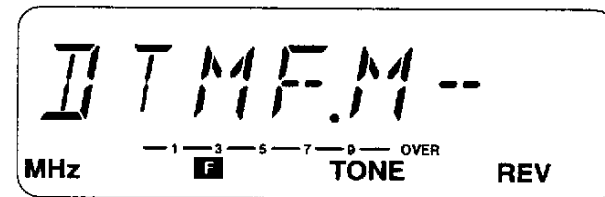

- 2 Press a single key [0] ~ [9] to select a DTMF memory channel.
 - The number stored in the memory channel scrolls across the Display accompanied by DTMF tones from the speaker.
 - After the transmission, the frequency display is restored.
 - If a memory channel that does not contain DTMF numbers is selected, an error beep sounds.
 - To escape from this DTMF memory channel mode, press microphone [PTT] again instead of a single key [0] ~ [9]. The frequency display is restored.

AUTOPATCH (U.S.A. AND CANADA VERSIONS)

Some repeaters in the U.S.A. and Canada offer a service called Autopatch. This application of the DTMF function allows you to access the public telephone network from your transceiver. This repeater function can be very convenient, and can even save lives when used appropriately during emergencies.

- 1 Press and hold **[PTT]**.
- 2 Press the keys in sequence on the keypad to send DTMF tones.
 - Your transceiver remains in the transmit mode for 2 seconds after you press each key. This means you can release **[PTT]** after beginning to press keys without interrupting the DTMF transmission.

Note: Some repeaters require a special key sequence to activate Autopatch. Check with the repeater control operator.

DTMF Tones

Freq. (Hz)	1209	1336	1477	1633
697	1	2	3	A
770	4	5	6	B
852	7	8	9	C
941	*	0	#	D

AUXILIARY FUNCTIONS

FULL RESET

- 1 To initialize all settings, press **[MR]+ POWER ON**.

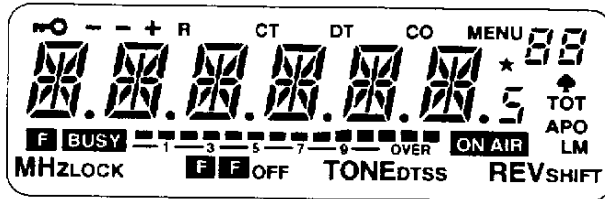

- 2 While the display shown above is visible, press **[MR]** again.
 - The VFO, memories, and Menu settings are reset.

Note: After the display shown above appears, you must execute Step 2 within approximately 10 seconds or the Full Reset will be aborted and the previous mode will be restored.

KEYPAD DIRECT ENTRY

You can enter frequency digits or memory channel digits directly from the MC-53DM microphone.

■ Frequency Entry

Entering the desired frequency directly via the microphone keypad can be the fastest way of selecting a different frequency especially when a small frequency step has been selected. If the new frequency is hundreds of kHz or more from the current frequency, and you don't have the new frequency stored in any memory channels, direct entry may be the quickest way to select your frequency.

- 1 Press **[VFO]** to select VFO mode.
- 2 Access "PF" in Menu B {page 17}, and select "ENTer".
- 3 Press microphone **[PF]**.
 - The display for Direct Frequency Entry appears.

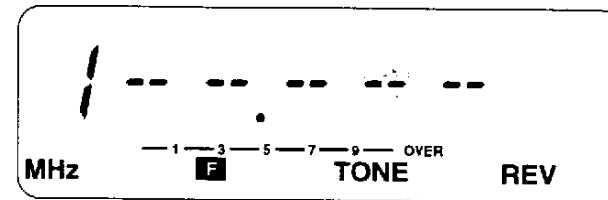

- 4 Use the microphone keypad to enter the desired frequency.
 - Enter the digits in order from the most significant down to the least significant.
 - Pressing keys other than **[0] ~ [9]** or **[PF]** cancels direct entry and restores VFO mode.
 - For versions with receiver coverage wider than 10 MHz, the 10 MHz digit must be entered. Otherwise, begin entering from the 1 MHz digit.
 - Except for the 1 kHz digit, entering a digit that is outside the allowable range causes the nearest digit within range to be displayed. For the 1 kHz digit, pressing **[0] ~ [4]** selects "0" and pressing **[5] ~ [9]** selects "5".

- When the current step size is 5 kHz, 10 kHz, 15 kHz, 20 kHz, or 25 kHz, enter numeric values down to the 1 kHz digit. Enter either 0 or 5 for the 1 kHz digit.
- When the current step size is 12.5 kHz, entering the 10 kHz digit completes frequency setting. The 10 kHz and subsequent digits are set according to which key is pressed for the 10 kHz digit as shown in the table.

10 kHz Key	Frequency (kHz)	10 kHz Key	Frequency (kHz)
0	00	5	50
1	12.5	6	62.5
2	25	7	75
3	37.5	8	87.5
4	37.5	9	87.5

Note:

- ◆ If any key other than [0] – [9] or [PF] is pressed, or if the next entry is not made within 10 seconds, the previous frequency will be restored.
- ◆ If [PF] is pressed while entering the frequency, the new data is accepted for the digits entered and the previous data remains unchanged for the digits not yet entered.
- ◆ Turning the **Tuning** control, or pressing microphone [UP]/[DWN], while entering the frequency cancels the new numeric data entered, and raises or lowers the previously displayed frequency.

11

■ Memory Channel Number Entry

This is similar to Frequency Entry except this function is used when Memory Recall is being used. If you want to choose a memory channel number quickly without scrolling through many other choices, this is the method to use.

- 1 Press [MR].
 - The last memory channel used is recalled.
- 2 Access “PF” in Menu B {page 17}, and select “ENTer”.
- 3 Press microphone [PF].
 - The display for Direct Memory Channel Entry appears.

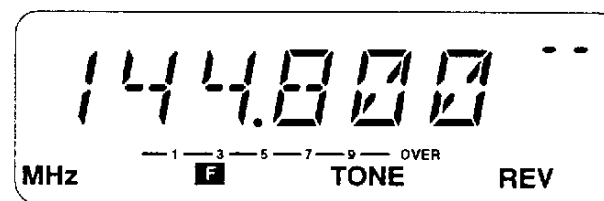

- 4 Use the microphone keypad to enter 2 digits.
 - To recall channel 3, for example, enter “03”.
 - If any key other than [0] ~ [9] is pressed, or if the next entry is not made within 10 seconds, the previous frequency display will be restored.
 - If a memory channel is entered that does not contain data, an error beep sounds.

CHANGING FREQUENCY STEP SIZE

Choosing the correct step size is essential in order to select your exact receive frequency with the **Tuning** control or microphone **[UP]/[DWN]**. The best step size on each band is the largest step that will still allow you to select all frequencies on which you plan to operate. Using the best step size reduces the time required to select new frequencies; operating becomes easier.

The default step size is as follows:

Version	TM-261A	TM-261EJ	TM-461A
U.S.A./Canada	5 kHz	–	25 kHz
China	–	–	25 kHz
General	12.5 kHz	20 kHz	25 kHz

To change the frequency step size, select the VFO mode, and access “F.S” in Menu A {page 17}. You cannot use the function if you access Menu A after a memory channel or the Call channel is recalled.

■ Changes in Displayed Frequencies

Changing between step sizes may result in a change of the displayed frequency. When a change occurs, and by how much, is shown in the accompanying tables.

For example, assume 144.995 MHz is displayed with a 5 kHz step size selected. Changing to a 12.5 kHz step size alters the displayed frequency to 144.975 MHz.

5, 10, 15, 20 or 25 kHz Step Size	→	12.5 kHz Step Size
Displayed Frequency (10 kHz/ 1 kHz)		Displayed Frequency (10 kHz/ 1 kHz)
00, 05, 10, 15		00
20, 25, 30, 35		25
40, 45, 50, 55		50
60, 65, 70, 75, 80, 85, 90, 95		75

12.5 kHz Step Size	→	5, 10, 15, 20 or 25 kHz Step Size
Displayed Frequency (10 kHz/ 1 kHz)		Displayed Frequency (10 kHz/ 1 kHz)
00		00
12.5		10
25		20
37.5		30
50		50
62.5		60
75		70
87.5		80

TIME-OUT TIMER (TOT)

It is sometimes necessary or desirable to restrict a single transmission to a specific maximum time. This feature can be useful when accessing repeaters to prevent repeater time-outs, or when particularly trying to conserve battery power. When TOT is activated, your transmit time is limited to 10 minutes.

Access "TOT" in Menu B to toggle the function ON or OFF {page 17}.

When TOT times out, the transceiver generates beeps and automatically returns to Receive. To resume transmitting, release and then press [PTT] again.

BUSY CHANNEL LOCKOUT

This function prevents you from interfering with other stations that may be using the channel that you select. Pressing [PTT] while the selected channel is in use causes your transceiver to generate an audible warning tone. Your transceiver is inhibited in this situation so it will not transmit. Release [PTT] to cancel the alarm and restore the receive mode.

11 Access "BCL" in Menu B to toggle the function ON or OFF {page 17}.

Note: When the correct Tone is received while CTCSS is in use, transmission is not inhibited.

AUTOMATIC POWER OFF (APO)

Automatic Power Off is a background function that monitors whether any buttons or keys have been pressed, or whether the **Tuning** control has been turned. After 3 hours pass with no changes, APO turns OFF the power. However, 1 minute before the power turns OFF, "APO" starts blinking and a series of warning tones sound.

If the squelch opens or any settings are changed during the 3 hour period while APO is ON, the timer resets. When the squelch closes or setting changes stop, the timer begins counting again from 0.

Access "APO" in Menu B to toggle the function ON or OFF {page 17}.

TRANSCEIVER LOCK

Transceiver Lock is suitable for a typical mobile installation where you do most functions from your microphone. This mode prevents accidental changes in settings at the transceiver by others who may also be in your mobile.

Press [F], [LOCK] to toggle Transceiver Lock ON or OFF.

- The key icon appears when Transceiver Lock is ON.
- Key functions other than the following are disabled:
 - POWER** switch
 - [F]
 - [F], [LOCK]
 - Microphone keys
- Pressing a locked button generates an alarm beep.

CONFIGURING PROGRAM FUNCTION KEYS

The Programmable Function keys are [PF], [MR], and [VFO] located on the face of the microphone. If you prefer, you can change the default functions assigned to these keys.

Programmable Function Key	Default Function
[PF]	MHz Select
[MR]	Memory Recall
[VFO]	VFO Select

- 1 Press one of the following key combinations depending on which key you want to re-assign:
 Microphone [PF]+ POWER ON (“PF1” appears)
 Microphone [MR]+ POWER ON (“PF2” appears)
 Microphone [VFO]+ POWER ON (“PF3” appears)
- 2 Press the key or key combination on the Front Panel that you want to assign to the Programmable Function key pressed in Step 1.

- The following types of Front Panel key functions can be assigned:

[KEY]

[KEY] (1 s)

[F], [KEY]

- The following types of Front Panel key functions cannot be assigned:

[KEY]+ POWER ON

[F]

[F] (1 s)

POWER switch

Tuning control

VOL control

SQL control

- After assigning a function that is executed by pressing [KEY] (1 s), press the configured Program Function key for 1 second or longer to execute the function.
- The Front Panel key will still function normally after “copying” its function to a Programmable Function key.
- To restore the default functions shown in the table, do a Full Reset {page 29}.

Note:

- ◆ If the LOCK switch located on the rear of the microphone is ON, you cannot re-assign the Programmable Function keys.
- ◆ If microphone [PF] is assigned Monitor or Enter by accessing “PF” in Menu B {page 17}, you cannot re-assign microphone [PF] by pressing microphone [PF]+ POWER ON.

■ Programming Microphone [PF]

You can program microphone [PF] with a function that cannot be activated using the Front Panel keys.

Access "PF" in Menu B to select USeR setting, MONitor, or ENTer {page 17}. The default is USeR setting.

When you select USeR setting:

The function assigned by pressing [PF]+ POWER ON is selected (Default: MHz)

When you select MONitor:

You can monitor activity on the current frequency. Pressing microphone [PF] toggles the function ON and OFF. Scan will not function if Monitor is ON (squelch open).

When you select ENTer:

After pressing microphone [PF], you can enter digits from the MC-53DM microphone. Refer to "KEYPAD DIRECT ENTRY" {page 43}.

SWITCHING AM/FM MODE (SOME TM-261A VERSIONS ONLY)

Some versions of the transceiver are able to receive AM and FM modes. The AM mode is selected automatically when any frequency in the range 118.000 to 135.995 MHz (AIR band) is chosen. Outside this range, the default is FM. However, either mode can be selected manually on any VHF frequency. Crossing the 136.000 MHz boundary restores the default modes.

Press [MHz] (1 s) to toggle between FM and AM.

- When AM is selected, a spade icon appears.

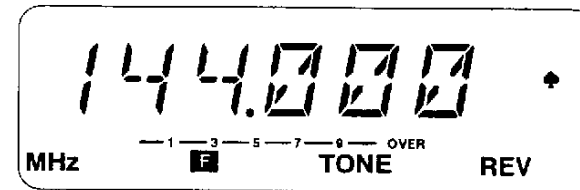

PACKET OPERATION

You can use almost any computer to control one of the widely available Terminal Node Controllers (TNC) since the computer primarily serves to input commands and output received text data to its display. Little real computing power is needed, therefore a high-powered processor is not necessary, and even a “dumb” terminal is satisfactory, at least to start.

Much reference material is available for getting started in digital communications from any store that handles Amateur Radio equipment. Or, if more convenient, check the radio magazines for mail order bookstores.

- Connect your TNC to the microphone connector on the transceiver Front Panel using a cable equipped with an 8-pin modular plug. Wiring details for the microphone connector are included in “FRONT PANEL” {page 8}.
- Do not share a single power supply between the transceiver and the TNC.
- Keep as wide a separation as possible between the transceiver and computer as practical to reduce noise-pickup by the transceiver.

1200 bps OPERATION

Using a modulator input level that is far different from the optimum 40 mV_{p-p} specifications may result in deterioration of S/N ratio or signal distortion. This could result in increased errors or a complete failure to connect with other stations.

Baud Rate	Input Impedance	Standard Modulator Input
1200 bps	10 kΩ	40 mV _{p-p}

Note:

- ◆ Transmit data input sensitivity is 40 mV_{p-p}. This is suitable for a typical 1200 bps TNC or other data communications equipment.
- ◆ The TX delay parameter on your TNC should be set for 300 ms by using your computer.
- ◆ Packet operation, easily affected by transmit and receive conditions, requires a full-scale S-meter reading for reliable communication.

MAINTENANCE

GENERAL INFORMATION

Your transceiver has been factory aligned and tested to specification before shipment. All adjustable trimmers, coils and resistors in the transceiver were preset at the factory. They should only be readjusted by a qualified technician who is familiar with this transceiver and has the necessary test equipment. Attempting service or alignment without factory authorization can void the transceiver warranty.

SERVICE

When returning the equipment to your dealer or service center for repair, pack the transceiver in its original box and packing material. Include a full description of the problems experienced. Include both your telephone number and fax number (if available) along with your name and address in case the service technician needs to call you. Don't return accessory items unless you feel they are directly related to the service problem.

You may return your transceiver for service to the authorized **KENWOOD** Dealer from whom you purchased it or any authorized **KENWOOD** service center. A copy of the service report will be returned with the transceiver. Please do not send subassemblies or printed circuit boards. Send the complete transceiver.

13

Tag all returned items with your name and call sign for identification. Please mention the model and serial number of the transceiver in any communication regarding the problem.

SERVICE NOTE

If you desire to correspond on a technical or operational problem, please make your note short, complete, and to the point. Help us help you by providing the following:

- 1 Model and serial number of equipment
- 2 Question or problem you are having
- 3 Other equipment in your station pertaining to the problem
- 4 Meter readings
- 5 Other information (Menu setup, mode, frequency, button sequence to induce malfunction, etc.)

CAUTION: Do not pack the equipment in crushed newspapers for shipment! Extensive damage may result during rough handling or shipping.

Note:

- ◆ Record the date of purchase, serial number and dealer from whom the transceiver was purchased.
- ◆ For your own information, retain a written record of any maintenance performed on the transceiver.
- ◆ When claiming warranty service, please include a photocopy of the bill of sale, or other proof-of-purchase showing the date of sale.

CLEANING

Remove the controls from the transceiver when they become soiled and clean them with a neutral detergent and warm water. Use a neutral detergent (no strong chemicals) and a damp cloth to clean the case.

TROUBLESHOOTING

The problems described in this table are commonly encountered operational malfunctions. These types of difficulties are usually caused by improper hook-up, accidental incorrect control settings, or operator error due to incomplete programming. These problem symptoms are not caused by circuit failure. Please review this table, and the appropriate section(s) of this Instruction Manual, before assuming your transceiver is defective.

Problem Symptom	Probable Cause	Corrective Action	Page Ref.
The transceiver will not power up after connecting a 13.8 V DC power supply and pressing [POWER] . Nothing appears on the Display.	1 The power cable is connected backwards.	1 Connect the supplied DC Power Cable correctly: Red → (+); Black → (-).	3, 4
	2 One or more of the power cable fuses are open.	2 Look for the cause of the blown fuse/fuses. After inspecting and correcting any problems, install new fuses with the same ratings.	5
	3 The connectorized cable has not been correctly connected.	3 Connect the connectorized cable correctly.	3, 4
The frequency cannot be selected by turning the Tuning control or by pressing microphone [UP] / [DWN] .	Memory Recall or the Call channel is selected.	Press [VFO] .	15
Most buttons/keys and the Tuning control do not function.	The Transceiver Lock function is ON.	Press [F] , [LOCK] to unlock the transceiver.	46

Continued

13

Problem Symptom	Probable Cause	Corrective Action	Page Ref.
Memory channels cannot be selected by turning the Tuning control or by pressing microphone [UP]/[DWN] when using Memory Recall.	1 No data has been saved in any memory channels, or entered data was erased by a Full Reset.	1 Store data in some memory channels.	25
	2 The Call channel is selected.	2 Press [MR] to switch to Memory Recall.	26
You cannot transmit even though you press [PTT] .	1 The microphone plug is not inserted completely in the Front Panel connector.	1 Switch OFF the power, ensure the microphone connector on the Front Panel has no foreign objects in it, then insert the microphone plug until the locking tab clicks in place.	6
	2 You have selected a transmit offset that places the transmit frequency outside the transmit band range.	2 Press [F] , [SHIFT] one or two times so neither "+" nor "-" are visible.	22
Packet operation results in no connects with other stations.	1 Your frequency differs from the target station's frequency.	1 Adjust your frequency using the Tuning control.	49
	2 The modulation level from the TNC is incorrect.	2 Adjust the TNC modulation level according to the TNC instruction manual.	49
	3 There is multi-path distortion.	3 Reorient or relocate the antenna. The strongest signal does not always provide the best operation on packet.	49
	4 The TX delay time parameter in your TNC is set incorrectly.	4 Set the TX delay time to more than 300 ms.	49

OPTIONAL ACCESSORIES

MC-45
Multi-function
Microphone

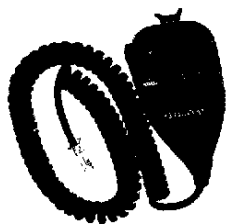

MC-53DM
Multi-function
Microphone with DTMF



MC-80
Desktop Microphone
(MJ-88 required)



PS-33
Regulated DC
Power Supply

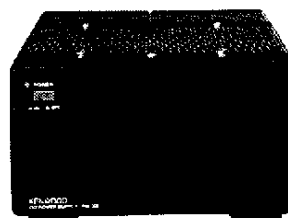

PG-2N
DC Power Cable



PG-3G
DC Line
Noise Filter

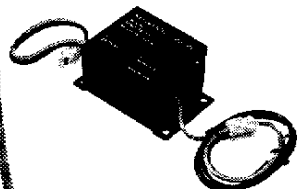

PG-3B
DC Line
Noise Filter

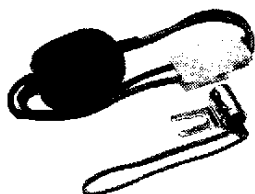

TSU-8
CTCSS Unit

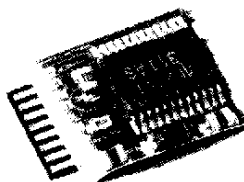

MB-12
Mobile Mounting
Bracket

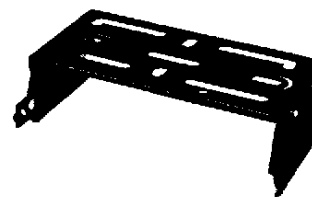

MB-201
Mobile Mounting
Bracket



SP-41
Mobile Speaker

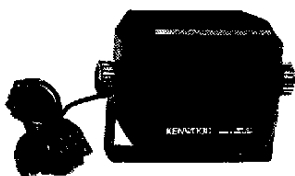

SP-50B
Communications
Speaker

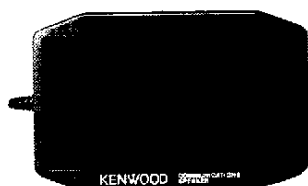

MJ-88
Microphone Plug
Adapter



MJ-89
Modular Plug
Microphone Switch

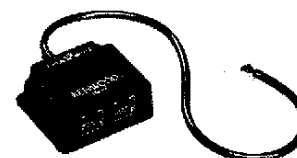

INSTALLING OPTIONS

INSTALLING THE TSU-8 CTCSS UNIT

CAUTION: Always switch OFF the power and unplug the DC power cable first.

- 1 Remove the two screws from the upper cover of the transceiver.

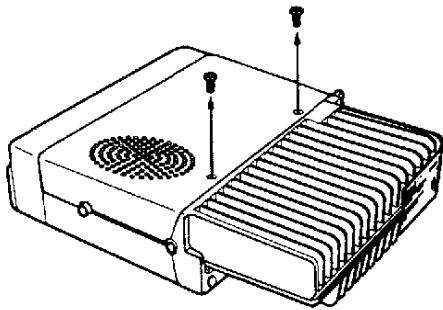

- 2 Remove the upper cover.

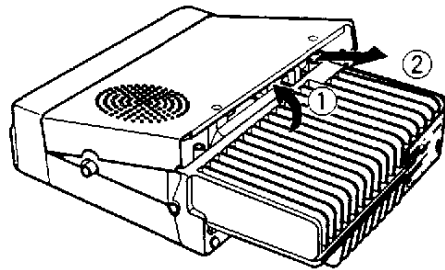

- 3 Hold the TSU-8 unit with the large IC facing downward, and insert the connector on the TSU-8 unit into the 8-pin connector as shown. Take care to keep the TSU-8 horizontal when inserting it into the 8-pin connector.

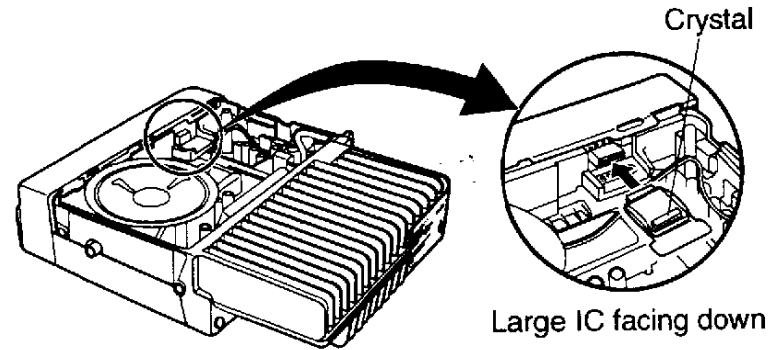

- 4 Replace the upper cover and screws.

SPECIFICATIONS

Specifications are subject to change without notice due to developments in technology.

General		TM-261A	TM-261EJ	TM-461A
Frequency range	U.S.A./ Canada	144 ~ 148 MHz	—	438 ~ 450 MHz
	China	—	—	400 ~ 420 MHz or 450 ~ 470 MHz
	General	144 ~ 148 MHz	144 ~ 146 MHz	430 MHz ~ 440 MHz
Mode		F3E (FM)		
Antenna impedance		50 Ω		
Usable temperature range		-20°C ~ +60°C (-4°F ~ +140°F)		
Power supply		13.8 V DC ±15% (11.7 ~ 16.0 V)		
Grounding method		Negative ground		
Current	Transmit (max.)	11.0 A or less	3.5 A or less	10.0 A or less
	Receive (no signal)	0.6 A or less		
Frequency stability		Within ±10 ppm		
Dimensions (W x H x D projections not included)		140 x 40 x 160.5 mm/ 5 1/2" x 1 9/16" x 6 5/16"		
Weight		1.0 kg/ 2.2 lb		

Transmitter		TM-261A	TM-261EJ	TM-461A
Power output	High	50 W	10 W	35 W
	Medium	10 W	1 W	10 W
	Low	Approx. 5 W	Approx. 0.5 W	Approx. 5 W
Modulation		Reactance		
Spurious emissions		-60 dB or less		
Maximum frequency deviation		±5 kHz		
Audio distortion (at 60% modulation)		3% or less		
Microphone impedance		600 Ω		

Receiver	TM-261A	TM-261EJ	TM-461A
Circuitry	Double conversion superheterodyne		
Intermediate frequency (1st/ 2nd)	10.7 MHz/ 455 kHz ¹	10.7 MHz/ 455 kHz	30.825 MHz/ 455 kHz ²
Sensitivity (12 dB SINAD)	0.16 μV or less		
Selectivity (-6 dB)	12 kHz or more		
Selectivity (-60 dB)	28 kHz or less		
Squelch sensitivity	0.1 μV or less		
Audio output (8 Ω, 5% distortion)	2 W or higher		
Audio output impedance	8 Ω		

¹TM-261A (U.S.A./ Canada): 30.825 MHz/ 455 kHz

²TM-461A (China): 30.3 MHz/ 455 kHz or 34.3 MHz/ 455 kHz

INDEX

Accessories		External Speaker (Option)	6	Rear Panel	9
Installing Optional	54	Microphone	6	Repeater Access	20
Optional	53	Mobile	2	Reset	
Supplied	1	Keypad Direct Entry		Full (Memory)	29, 43
AM mode	48	Frequency	43	Partial (VFO)	29
Automatic Power Off (APO)	46	Memory Channel Number	44	Reverse Function	23
Autopatch (U.S.A./Canada)	42	Lock, Transceiver	46	Scan	
Busy Channel Lockout	46	Maintenance	50	Call/Memory	35
Call Channel	see Memory Channels	Memory Channels		Call/VFO	35
Channel Display Function	29	Call Channel, Recalling	27	Carrier-Operated Resume	31
Continuous Tone Coded		Call Channel, Changing Simplex ...	27	Memory	32
Squelch System (CTCSS)	36	Call Channel, Changing Split	28	Program, Confirming Limits	34
Display	11	Erasing	26	Program, Setting Limits	34
Dual Tone Multi-Frequency (DTMF)		Initializing	29	Program, Using	35
Functions		Locking Out	33	Time-Operated Resume	31
Confirming Stored Numbers	41	Naming	30	VFO	32
Making Calls	40	Direct Number Entry	44	Specifications	55
Storing Numbers	40	Recalling	26	Squelch, Adjusting	14
Transmitting Stored Numbers	41	Storing, Simplex	25	Time-Out Timer (TOT)	46
Dual Tone Squelch System (DTSS)		Storing, Split	25	Tone	
Storing Codes	37	Transfer to VFO	28	Activating	22
Storing Group Codes	38	Menu		Automatic ID	36
Using	39	Access	17	Selecting	23
Features	Inside Front Cover	Configuration, A	18	Troubleshooting	51
Frequencies, Selecting		Configuration, B	19	Volume, Adjusting	14
Microphone [UP]/[DWN]	15	Microphone	10		
Tuning Control	15	Offset			
Frequency Step Size	45	Automatic Repeater	22		
Front Panel	7	Offset Direction	22		
Installation		Offset Frequency	21		
Antenna	5	Packet Operation	49		
CTCSS Unit (Option)	54	Power, ON/OFF	14		
DC Power Cable, Fixed Station	4	Transmit Output	16		
DC Power Cable, Mobile	3	Program Function (PF) Keys	47		

KENWOOD

Free Manuals Download Website

<http://myh66.com>

<http://usermanuals.us>

<http://www.somanuals.com>

<http://www.4manuals.cc>

<http://www.manual-lib.com>

<http://www.404manual.com>

<http://www.luxmanual.com>

<http://aubethermostatmanual.com>

Golf course search by state

<http://golfingnear.com>

Email search by domain

<http://emailbydomain.com>

Auto manuals search

<http://auto.somanuals.com>

TV manuals search

<http://tv.somanuals.com>