

KENWOOD

TM-411A/E

440MHz/430MHz FM TRANSCEIVER

INSTRUCTION MANUAL



Illustrated is the TM-411A

Thank you for purchasing our latest product, the new TM-411A/E transceiver. Please read this instruction manual carefully before placing your transceiver in service. This unit has been carefully engineered and manufactured to rigid quality standards, and should give you satisfactory and dependable operation for many years.

CONTENTS:

1. FEATURES	3
2. CONTROLS AND THEIR FUNCTIONS	4
3. INSTALLATIONS AND CONNECTIONS	10
4. OPERATION	15
5. DCS	19
6. MAINTENANCE AND ADJUSTMENT	26
7. ACCESSORIES	29
8. BLOCK DIAGRAM	33
9. SPECIFICATIONS	35

ACCESSORIES

①

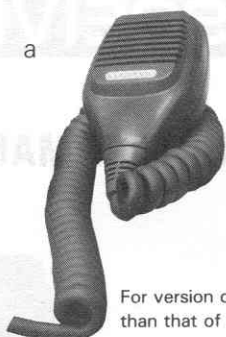

For version other than that of U.S.A.

b



For USA version.

②



Unpack your TM-411A/E carefully and confirm that it is supplied with the following accessories.

① Microphone

- a. Dynamic microphone.....(T91-0331-05).....1 pc.
British version (T91-0335-05).....1 pc.
- b. Electret condenser microphone with touch-tone.....(T91-0332-05).....1 pc.

② Communications speaker (with 2.5 m lead)(T19-0101-05).....1 pc.
British version (T19-0102-05).....1 pc.

③ Speaker mounting kit

- a. Bracket.....(J21-2799-13).....1 pc.
- b. Cushion (A)(G13-0683-04).....1 pc.
- c. Self tapping screw ($\phi 4 \times 8$).....(N87-4008-41).....4 pcs.
- d. Flat head self tapping screw ($\phi 4 \times 8$).....(N88-4008-41).....2 pcs.
- e. Pan head screw (M4 \times 10).....(N30-4010-41).....2 pcs.
- f. Hex. head nut (M4)(N10-2040-41).....2 pcs.

④ Mobile mounting kit

- g. Mounting bracket.....(A13-0640-12).....1 pc.
- h. Round head screw (M6 \times 20)(N09-0008-04).....4 pcs.
- i. Flat washer (for M6).....(N15-1060-46).....4 pcs.
- j. Spring washer (for M6).....(N16-0060-46).....4 pcs.
- k. Flange nut (M6)(N14-0510-04).....4 pcs.
- l. Self tapping screw ($\phi 5 \times 12$)(N09-0632-05).....4 pcs.
- m. Flat washer (for M5).....(N15-1050-46).....4 pcs.
- n. Cable holding metal fixture(J19-1402-04).....1 pc.
- o. Binding tapping screw ($\phi 3 \times 6$)(N89-2606-45).....2 pcs.
- p. Stacking fixture.....(J21-4147-04).....2 pcs.

⑤ DC power cord (Approx. 2 m).....(E30-1788-05).....1 pc.

⑥ Spare fuse (8A)(F05-8021-05).....1 pc.

⑦ Instruction manual(B50-4117-00).....1 pc.

③

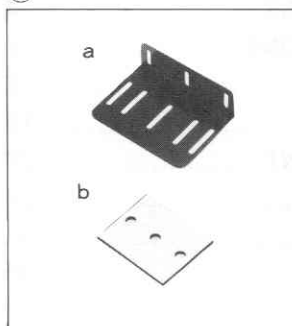

④

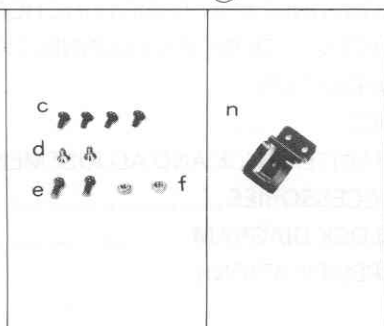

④

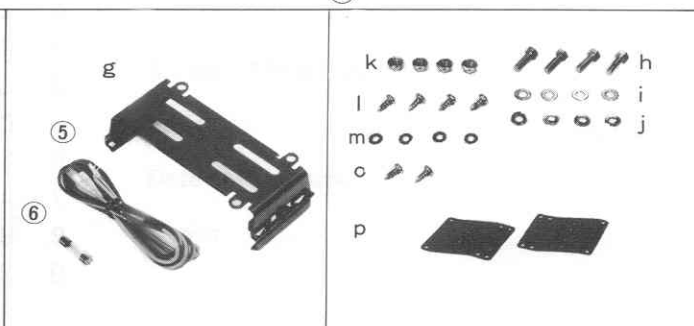

AFTER UNPACKING

Shipping container:

Save the boxes and packing in the event your unit needs to be transported for remote operation, maintenance, or service.

The following explicit definitions apply in this manual:

Note: If disregarded, inconvenience only, no risk of equipment damage or personal injury.

Caution: Equipment damage may occur, but not personal injury.

1. FEATURES

- **DCS mounted:**

The latest in digital techniques are employed enabling digital code squelch and code alert.

This feature adds another new dimension to amateur radio.

- **Panel oscillating mechanism:**

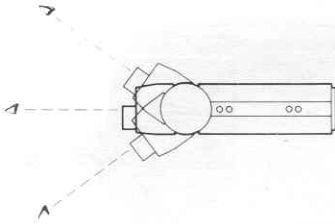

The panel oscillating mechanism has been developed to increase freedom in mounting, a basic problem of mobile transceivers. This convenient feature enables the panel to be set in an easy-to-operate position.

- **Panel layout with excellent maneuverability:**

The microphone jack, conventionally provided on the front panel, has been moved to the rear panel where it takes the form of a flexible cable and connector. This frees the front panel, allowing the transceiver to be more easily integrated with auto interiors, and allows unobstructed operation and view of front panel controls.

Front panel of TM-411A



Where is the MIC jack?

- **Dual function keyboard and LED-containing keyboard facilitating memory recall (MR):**

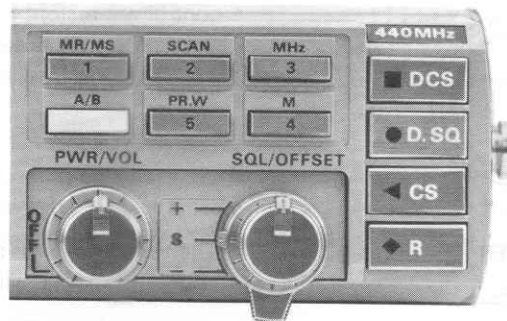

- **High reliability design:**

An aluminum die cast chassis is used in conjunction with printed circuit boards of glass material to provide increased reliability.

- **Quality transmit and receive audio:**

1. External communications speaker, 77 mm in dia., supplied as standard.
2. Maximum 3% modulation distortion ensures a quality transmit signal.

- **Microphone audio check function built in:**

Provides a convenient method for checking the microphone and modulation circuitry.

2. CONTROLS AND THEIR FUNCTIONS

Note: Illustrated is the TM-411A.



FRONT PANEL

① Tuning control (VFO)

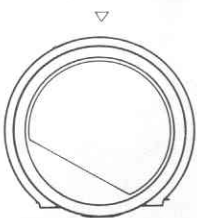

Used to set frequency for transmission and reception. One click rotation shifts the displayed frequency one step up or down. During memory recall operation, turning this control will restore the operation to the VFO with the previous frequency displayed.

Note: On rare occasions the frequency may not shift due to microprocessor transients.

② VOL/POWER



The Power ON-OFF switch and volume control are combined. Turning the control fully counterclockwise will turn the power OFF. Clockwise rotation will increase the volume.

③ a SQUELCH

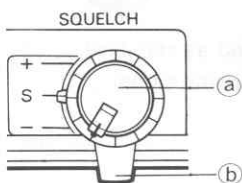

The squelch control is used to eliminate noise during periods of no-signal. Normally, this control is adjusted clockwise until the noise just disappears (squelch threshold). For scan operation, this control must be set to the threshold point.

b TX OFFSET switch

TX OFFSET Area	+	-
	Europe	-1.6 MHz (D - B)
England	+1.6 MHz	-1.6 MHz

Used to set the transmit offset.

“+” Transmit frequency is 5 MHz above the RX frequency.

“-” Transmit frequency is 5 MHz below the RX frequency.

“S” Used to select “simplex”, or transmit and receive on the same frequency.

If you attempt to transmit with an offset that would place you “out-of-band” the radio will beep 3 times to signal an error, and the radio will transmit “simplex”. The offset switch is effective only in VFO and with memory channels (M1 - M3) operations.

With the optional TU-3A tone unit installed, selecting either “+” or “-” setting of the TX OFFSET switch will enable the TU-3A 2nd tone frequency setting.

(* European and British versions excluded.)

④ Keyboard

Note: The keyboard is also used for DCS operation. For details, see Section 5. DCS.

**a MR/MS (memory recall)/
MS (memory scan) key**



This key serves two purposes. It is used to recall memory channels or to initiate memory scan. When this key is pressed momentarily memory channel 1 (M1) is recalled and displayed. To recall memory channels 2 thru 5 press the MR/M1 key first and then, press the desired memory channel key. When this key is pressed continuously for longer than approximately 1 second, memory scan mode is initiated.

b SCAN/M2 (scan) key



This key serves two purposes. It is used to initiate VFO scan, or during memory recall operation, this key works to recall memory channel 2 (M2). When this key is pressed during scan operations, the frequency is automatically shifted up one step.

c MHz/M3 (1 MHz UP) key



When depressed, the frequency will shift up 1 MHz. When this key is continuously depressed, the frequency will shift up continuously in 1 MHz steps. During memory recall operation, this key works to recall memory channel 3 (M3).

d M/M4 (memory input) key



Used to store the desired frequency in memory (and in the COM channel: European and British versions excluded). For memory input, refer to Section 4 OPERATION. During memory recall operation, depressing this key recalls memory channel 4 (M4). In memory CH4, transmit and receive frequencies are stored independently for odd split operation.

**e PR.W/M5 (priority watch)
key**



When depressed this key will "toggle" or switch the priority alert function "ON" and "OFF". For details, see Section 4. OPERATION, PR.W operation. During memory recall operation, this key works to recall memory channel 5 (M5). Like M4, M5 is a split frequency memory. This key also works to specify the program scan range. For details, see Section 4. OPERATION, (2) and (3) of "Scan Operation".

**f A/B (VFO A/B selection,
scan stop) key**



This key provides three different functions. When in the "VFO" mode, the key will switch from VFO-A to VFO-B and from VFO-B to VFO-A. When in the "MR" mode, the key will return operation to the VFO mode and frequency that was active before "MR" was selected. When in the "SCAN" mode, the key will stop scan.

⑤ COM (common channel) key

For users other than Europe and England.



When this key is depressed the radio will be switched to the "common channel". When the optional TU-3A tone unit is installed, the 1st tone frequency is emitted when operating the COM channel. For programming information on the common channel refer to Section 4. To release common channel operation depress the key again.

**TONE switch (For British
version)**



When this switch is pressed, the repeater control tone burst signal (1,750 Hz) is emitted for about 0.5 seconds at the beginning of each transmission.

**TONE switch (For European
version)**



When this switch is pressed, the repeater control tone signal (1,750 Hz) circuit is activated and the unit is set in the transmit mode.

- ⑥ **REV switch** Used to reverse the repeater shift to monitor a signal coming to a repeater.



- ⑦ **HI/LOW switch** Used to select high (■) or low (▣) transmit power.



- ⑧ **Display panel**

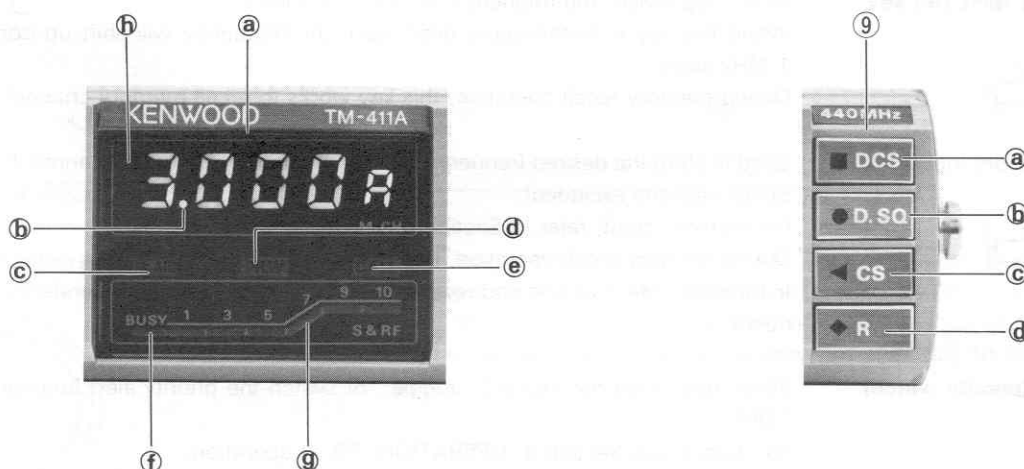

- ① **Transmit/receive frequency**
- Digital code display
 - ASCII display of call sign
- i) During VFO-A or VFO-B, frequency of operation is displayed in four digits. The 5th digit indicates VFO-A or VFO-B.
For example, when the VFO frequency is 445.02 MHz, "5.020A" is displayed.
 - ii) During MR (M1 — M5), the frequency is displayed in four digits, and the 5th digit indicates the memory channel number.
For example, when the frequency of memory channel 1 is 445.24 MHz, "5.2401" is displayed.
 - iii) During COM, the frequency is displayed in four digits, and the 5th digit becomes C indicating COM. (only U.S.A.)
Example: "3.000C"
 - iv) During DCS operation, digital code display, ASCII display of call sign and standby display are performed.
For details, refer to Section 5. DCS.
- ② **Scan indicator** During scan operation, this dot flashes.
Indicates the MHz position when not in scan mode.
- ③ **ON AIR indicator** Lights when transmitting.
- ④ **PR.W display** Lights during priority watch operation.
- ⑤ **CALL indicator** Lights when the proper DCS access code has been received.

- Ⓣ **BUSY indicator** Lights during receive whenever squelch has been opened. Provides a visual indication if the frequency is busy.
- Ⓢ **S & RF meter** Indicates the incoming signal strength during reception. During transmission, LEDs light to show the relative RF output level. With the HI/LOW switch HI, all LEDs light. With the HI/LOW switch LOW, two to four LEDs light. With the HI/LOW switch in LOW, the meter lights will vary according to the audio level input through the microphone, as a visual modulation check.
- Ⓦ **430 MHz band indicator (USA only)** In operation only within the frequency range between 438.000 and 439.995 MHz, the indicator (◆) will light.

⑨ **DCS keyboard** For details, refer to Section 5. DCS.

- ⓐ **DCS key** ON/OFF key of the DCS.



- ⓑ **D.SQ key** Used for ON/OFF of digital squelch, channel sending of digital code and digit feeding of call sign.



- ⓒ **CS key** Used for setting digital code and call sign.



- ⓓ **RESET key** Used for code alert ON/OFF, CALL indicator ON/OFF and setting the call sign.

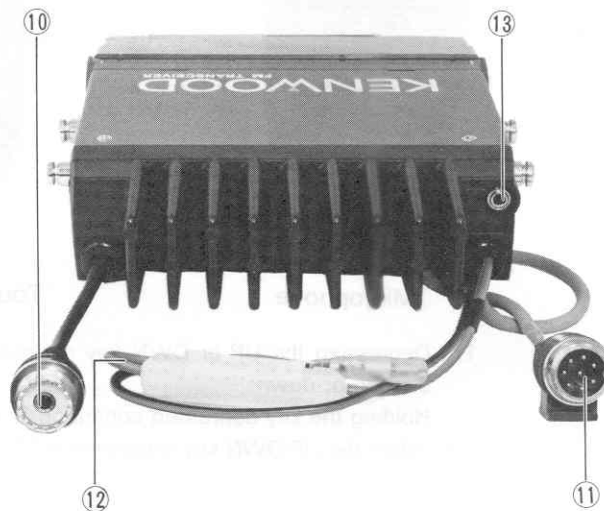

- ⑩ **ANT connector lead** Connect an antenna with a low SWR to this terminal. A coaxial cable is provided, to allow greater flexibility in installing the radio where space is at a minimum, such as some in-dash installation.

Note: A noise may be generated in the radio if the metallic part of the antenna connector contacts the chassis of the vehicle. Take care this does not happen.

⑪ MIC connector (8-pin)

A jack for connecting a microphone is provided. Make connections as illustrated above. For microphone functions, refer to the "Microphone" section. Use of other microphones may cause problems, ensure that the microphone is compatible before connecting. Avoid using microphones other than the one provided. Make sure that the microphone connectors are fully seated and locking nuts are tight, noise may appear on the transmit signal if the connectors are loose.

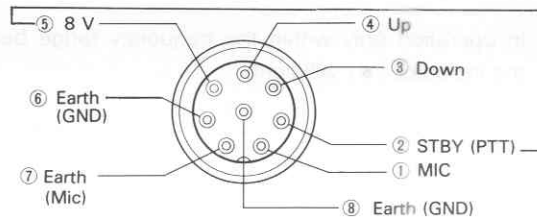

Caution:
The radio may be damaged if an external source voltage is applied to pins 2-5.

< View from connector END of the mic cable >

⑫ DC Power Terminal

DC power input terminal. Connect the supplied power cord with plug. Input voltage is 13.8 V DC. Observe plus (+) and minus (-) polarity!

⑬ SP Terminal

Connect the supplied 8 ohm speaker to this jack.

■ MICROPHONE (For U.S.A. version)



⑭ UP/DWN switches

- 1) Depressing the UP or DWN key momentarily shifts the displayed frequency one step up or down. Holding the key depressed continuously shifts the frequency up or down.
- 2) When the UP/DWN key is pressed in MR mode, the memory channel moves up or down.

⑮ PTT Switch

Press-to-talk switch is used for transmission. This will also releases scan operation. When releasing the SCAN operation, transmission is inhibited.

⑯ 16 DTMF Keys (Auto-patch operation)

Used to activate the DTMF encoder.

■ MICROPHONE (For versions other than that of U.S.A.)

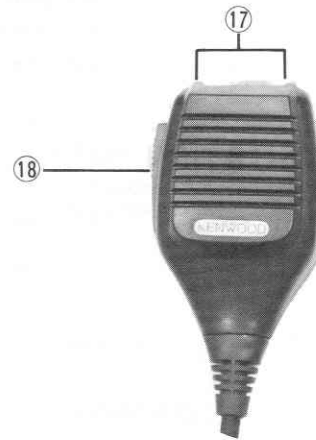

⑰ UP/DWN switches

- 1) Depressing the UP or DWN key momentarily shifts the displayed frequency one step up or down.
Holding the key depressed continuously shifts the frequency up or down.
- 2) When the UP/DWN key is pressed in MR mode, the memory channel moves up or down.

⑱ PTT switch

Press-to-talk switch used for transmission. This will also release scan operation. When releasing the scan operation, transmission is inhibited.

3. INSTALLATIONS AND CONNECTIONS

■ ANTENNA

The performance of the transceiver depends upon the type of antenna to be used. To ensure the maximum performance of the TM-411A/E, select a suitable antenna and adjust it for low VSWR.

■ MOBILE INSTALLATION

• Interconnection

- 1) The TM-411A/E is equipped with an external speaker.

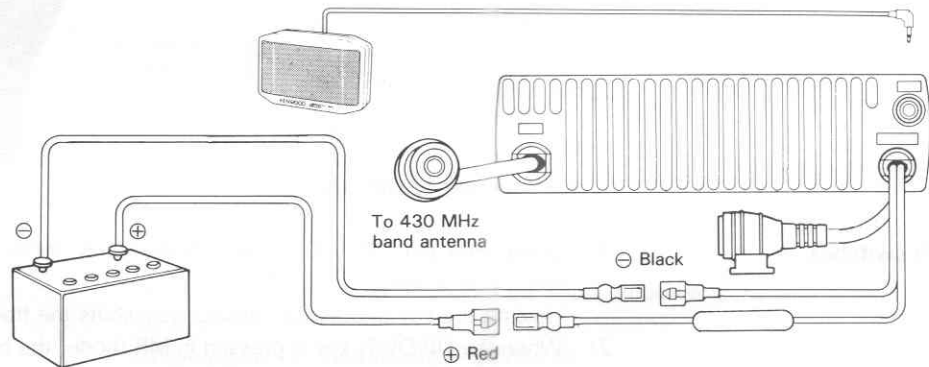

2) Installation

Using the supplied mounting bracket, mount the transceiver in any convenient location.

The oscillating mechanism permits positioning the front panel in an easy-to-operate position. Install the speaker at any desired position.

Avoid installing the speaker directly on the transceiver, as it may cause howling.

The heat sink provided at the rear of the transceiver will get hot during long transmission. Do not install the radio in a position where the heat sink may come in direct contact with the dashboard. Installation near heater air outlets should also be avoided.

If your car is equipped with an electronic fuel injection system, the transceiver should be mounted as far from the control equipment as possible.

Note: the front panel should be gently and slowly moved up or down, as rough treatment may cause a failure.

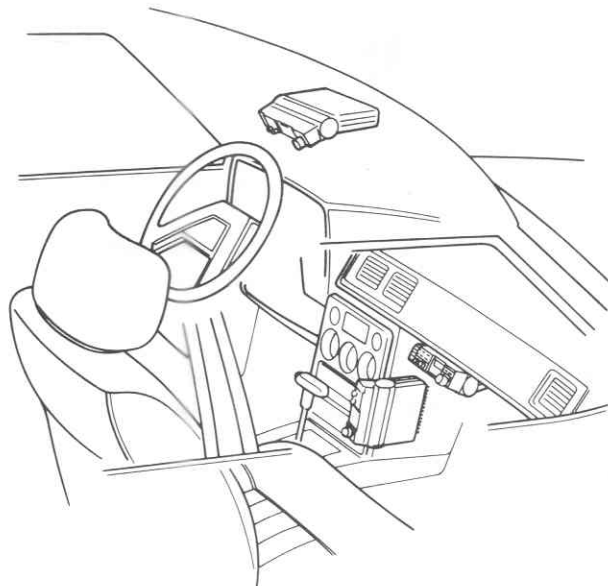

■ COMMUNICATIONS SPEAKER INSTALLATION

(1) Installing speaker on mounting bracket

Note: For safety sake do not install the speaker on the ceiling.

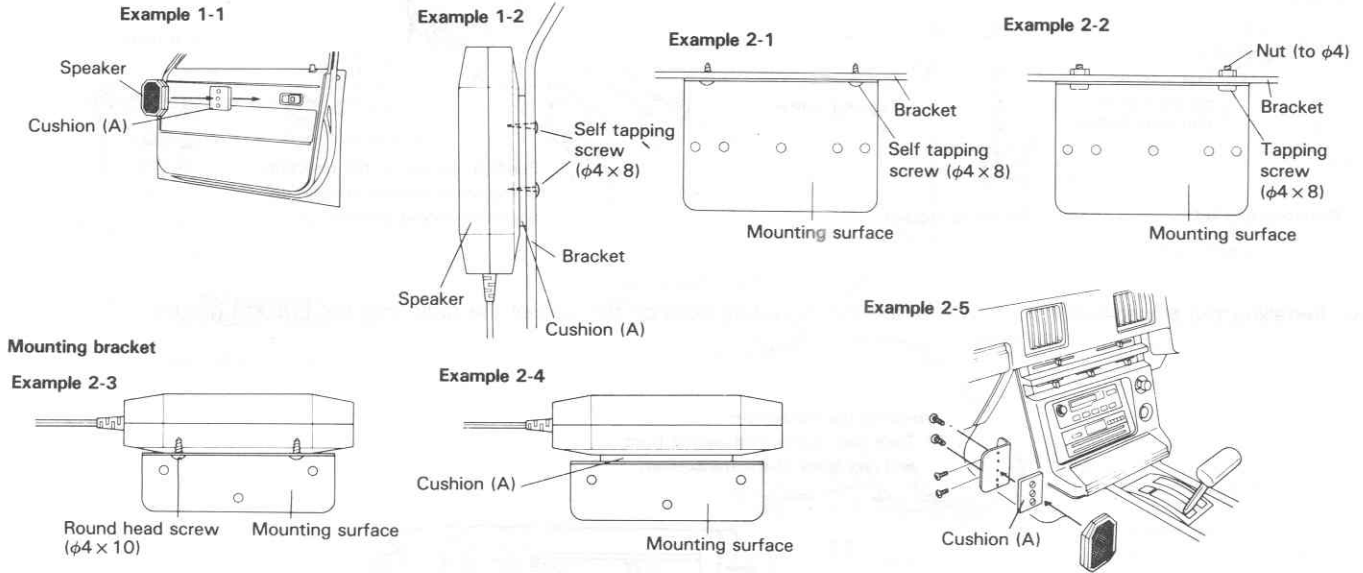

(2) Mounting bracket installation

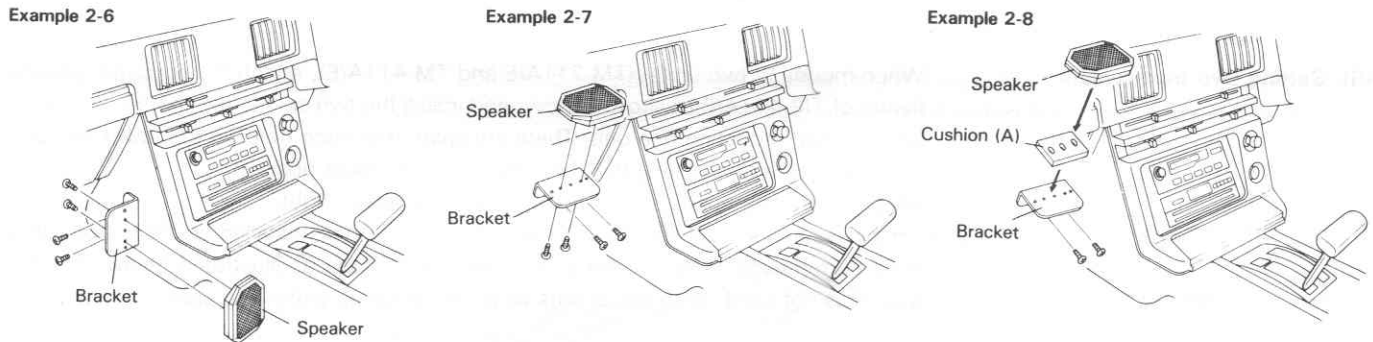

(3) Microphone cable bracket

There are mounting holes on both sides. Set the bracket on the desired side.

a) Securing the microphone cable

Hold the bracket from the top and insert the microphone cable into the bracket until the projection of the microphone connector fits in the round hole of the metal fixture.

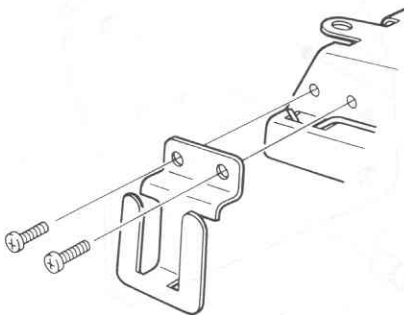

b) Removing the microphone cable

Push the microphone cable in the direction of the arrow and left it upward.

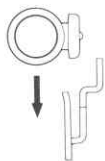

(4) Installing the mounting bracket

Install the bracket as shown below. Do not confuse the front and rear of the bracket.

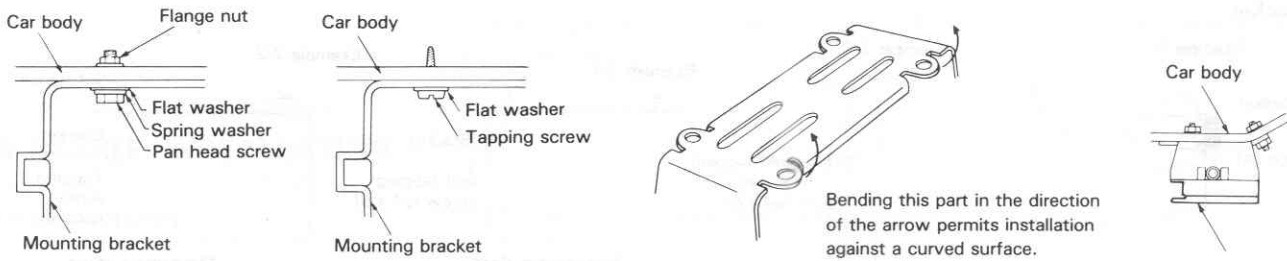

(5) Installing the transceiver

Insert the mounting boss on the side of the radio into the bracket grooves.

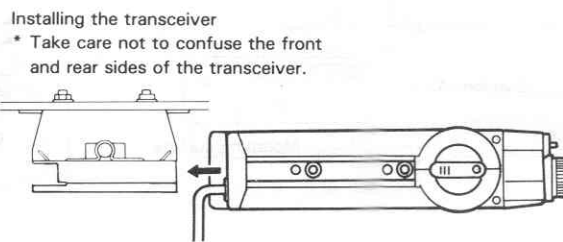

(6) Setting two transceivers

When mounting two units, (TM-211A/E and TM-411A/E), attach the supplied stacking fixture of TM-411A/E as shown below, and install the two sets to the mounting bracket just as when mounting one unit. There are spare mounting holes in the lower half providing a choice of installing the set in the upper or lower position. Attach the microphone cable bracket as desired, left or right. If the mounting bosses have been attached to the set to be installed on the bottom, they must be removed. Attach them only to the upper stage as illustrated below. The flat washer is not used. With the bosses when the stacking plates are used.

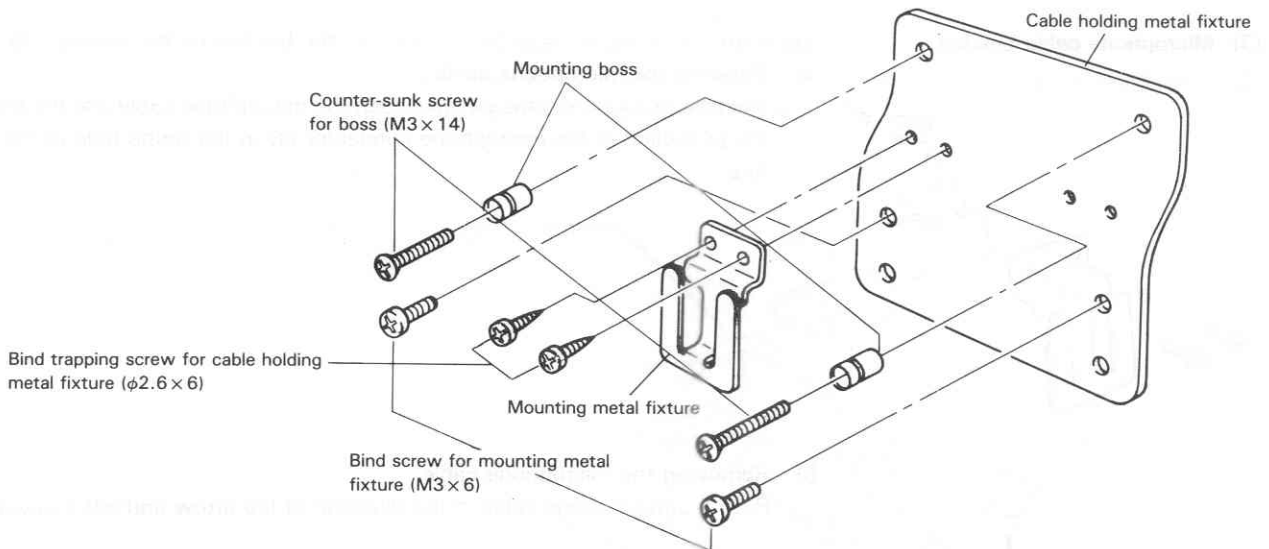

• **Antenna Installation**

Various types of antennas for UHF mobile operation are available.

Note: For gutter-mount installation, the antenna bracket must be grounded to the car body as shown below. Affix the antenna securely, referring to the antenna instruction.

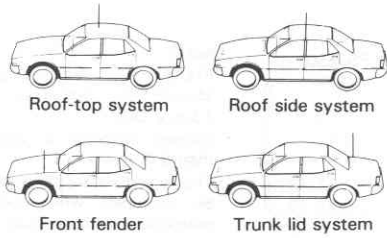

Installation for mobile operation.
Be sure to use a duplex mobile antenna.

Coax. cable routing

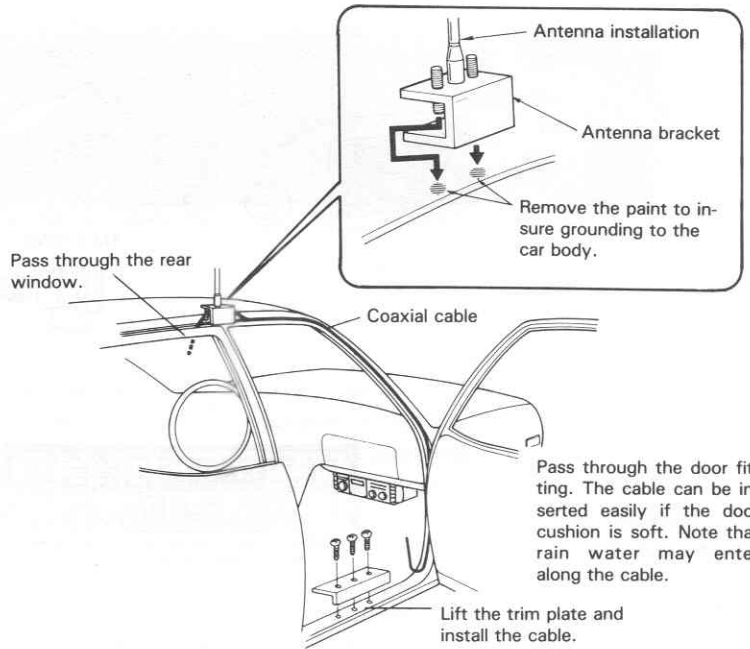

• **Power supply**

Connect the supplied power cable with fuse directly to the battery terminals. Connecting to the cigarette lighter socket can cause a poor connection, and excessive voltage drop.

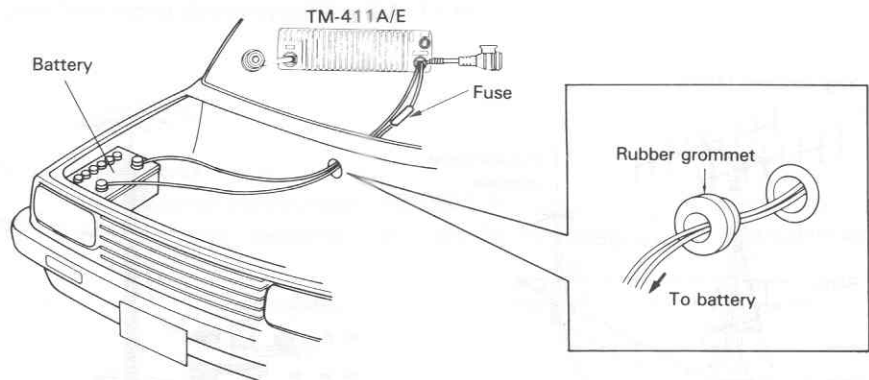

• **Ignition noise**

The transceiver is designed to suppress ignition noise; however, if excessive noise is present, it may be necessary to use suppressor spark plugs (with resistors). The PG-3A is available as an optional accessory for additional filtering, if required.

■ FIXED STATION INSTALLATION [general]

• Power supply

A regulated DC power supply (13.8 V DC, 6.9 A or more) is required.
The TRIO-KENWOOD PS-430 is recommended.

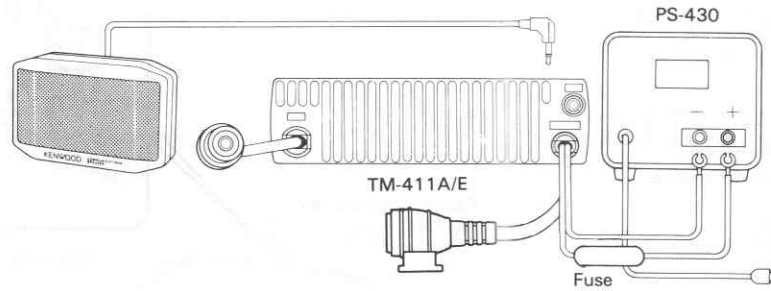

NOTE:
Preferably, the voltage should be adjusted to 13.8 V DC.
Current capacity is greater than 5.6 A.
The regulated supply should be equipped with built-in protection for both overcurrent and overvoltage.
CAUTION:
A battery charger cannot be used to power this unit.

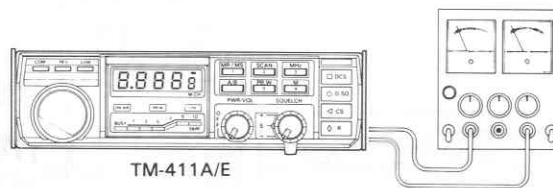

• Antenna

Various types of fixed station antennas are commercially available, select your antenna according to your installation space and application.

Note that the SWR of your antenna should be less than 1.5. A high SWR will cause the TM-411A/E protective circuit to operate, reducing the transmit output power.

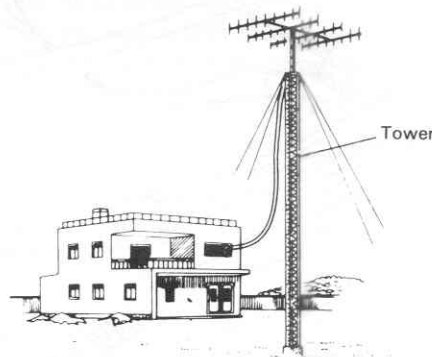
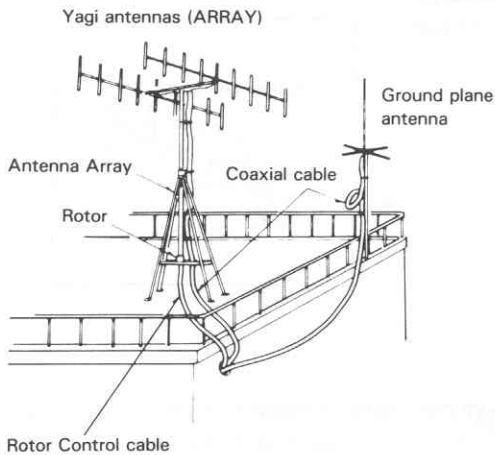

Transceiver performance depends largely on the type of antenna used. For fixed station operation there are ground plane antennas (omni-directional) and Yagi antennas (uni-directional). The Yagi antenna is suitable for long distance operation (DX) or communication with a specific party.

4. OPERATION

■ RECEPTION

After power and antenna connections have been completed, set the controls and switches as shown below:

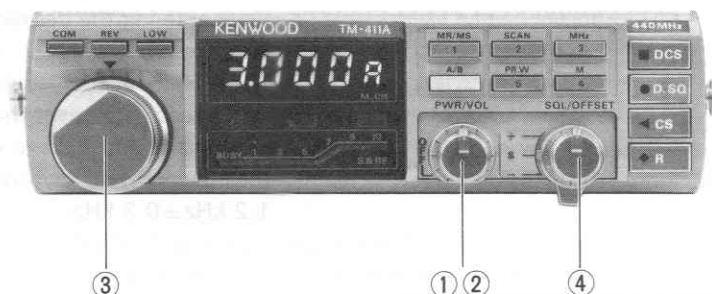

After verifying the initial setup of controls and switches, proceed as follows:

- (1) Turn the POWER/VOL control, clockwise, to turn on power. The indicators on the display will light to show the transceiver is operating.
The indicators normally work about 0.5 second after the power switch is turned on. (When the power switch is initially turned on, "3.000A" will be displayed.)
- (2) As the POWER/VOL control is turned clockwise, either background noise or a QSO will be heard.
- (3) To eliminate the no-signal noise, use the SQUELCH control. For SQUELCH control operation, refer to the following explanation.
- (4) Tune to the desired frequency using the MAIN DIAL.

• SQUELCH control

To eliminate receiver noise during no-signal periods, slowly adjust the squelch clockwise until the noise disappears and the BUSY indicator goes off (threshold point). When a signal is received, the squelch will open, the BUSY indicator will light and the speaker will operate. If the signal is weak or fades during mobile operation, readjust the squelch for constant reception. The SQUELCH control is also used for scan operation control.

Note: (USA version only)

In frequency construction, 439.965 MHz contains internal spurious. In this respect, when operating scan, note the frequency 439.965 MHz.

■ TRANSMISSION

To transmit, first select the desired frequency and see whether it is busy or not. If it is not busy, simply depress the mic PTT switch and speak into the microphone. The ON AIR indicator will light.

• Transmitter precautions

- 1) The TM-411A/E antenna impedance is 50 ohms. Be sure to use only an antenna of 50 ohms impedance.
- 2) Check the intended transmit frequency before operating to prevent interference with other stations.
- 3) Pressing the microphone PTT switch places the transceiver in transmit mode; the ON AIR indicator will light and the LED bar meter shows the relative transmitter power. Recommended talk distance to the microphone is approximately 5 cm.

• HI/LOW power switch

Local QSO's can be enjoyed with less interference to others, and with less power consumption, by reducing the RF output power. This is accomplished by depressing the HI/LOW switch, which reduces power from 25 W to approx. 6.2 A (Low ... 5 W. approx. 2.8 A). Power indication will drop to approximately "2 - 4" on the meter. At LOW power, the microphone modulation check function operates.

■ 16 key AUTO PATCH OPERATION

To operate, hold the mic PTT switch depressed until keys are started operating.

- Notes:**
1. After each number has been pressed, the transmitter will remain keyed.
 2. For approximately 1 second, allowing the release of the PTT switch. Continue entering the desired numbers within this delay to keep the transmitter keyed.
 3. The DTMF encoder level can be readjusted according to your requirement. When readjusting, set the deviation to 3 kHz with the built-in mic VR with both the 3 and 6 keys of the encoder held depressed. Next, hold both the 2 and 3 keys depressed to verify the deviation is within $1.2 \text{ kHz} \pm 0.3 \text{ kHz}$.

■ VERIFICATION BEEP TONE

When each switch is operated, a beep tone sounds to confirm the corresponding operation. The types of beep tone are described below.

- A. The beep tone will sound once, when a key is operated correctly.
- B. The beep tone will sound three times to signal mis-operation, or to signal all memory channels are "0.000" in memory scan operation. (Refer to Note: 1.)
- C. The beep tone will sound four times repeatedly, when the transmit frequency for odd split has not been stored, the beep will continue to sound until the frequency is stored.
(No other function will work until this frequency has been stored.)
- D. Beeps rapidly ON and OFF for approximately 2 seconds, when memory is ready to be stored. (Refer to Note: 2.)
- E. The tone will sound once for about 1.5 seconds for verifying memory input.

- Notes:**
1. As the memory is empty, store in the memory channel.
 2. Press the memory channel number key while the beep is sounding for about 2 seconds. Memory storing will not be accepted after the beep tone stops.

The beep tone sound volume can be adjusted by the potentiometer inside. (Refer to the page 26.)

■ MEMORY ENTRY

(1) Memory channels 1 — 3

- A. Using the main tuning dial or the UP/DOWN push buttons on the microphone select the desired frequency.
- B. Press the M/M4 key. A beep will sound. While the beep is still sounding press the desired memory channel key, 1 — 3. A beep will sound to confirm data entry.
- C. You must press the desired memory channel key while the long beep tones are sounding or data will not be stored.

(2) Memory channels 4, 5 and COM* (split channel)

* TM-411A only

- A. Using the main tuning dial or the microphone UP/DOWN buttons select the desired receive frequency.
- B. Press the M/M4 key.
- C. While the beep is sounding press 4, 5 or COM. A series of 4 beeps will sound signifying data storage, and to signal it is time to enter the transmit frequency.
- D. Select the desired transmit frequency using the main dial and or the microphone UP/DOWN buttons.
- E. Press the same key selected in step C. This will store the transmit frequency. A beep will sound to confirm data entry.

Note: The series of 4 beeps that occurs in step C will continue to sound until the transmit frequency is entered. This "Locks" the microprocessor up while it is awaiting the entry of the TX frequency. No other mode or scan can be selected as long as the 4 beeps sound!

■ SCAN OPERATION

(1) Memory scan

- Before initiating scan, adjust the SQUELCH control to eliminate the background noise.
- To initiate memory scan press and hold the MR/MS key for approximately 1 second. Scan will begin at memory channel 1 and proceed sequentially, i.e. M1→M2→M3 etc. The scan indicator dot will begin flashing.
 - Scan will stop at a busy channel.
 - Pressing the microphone UP/DOWN button will cause scan to resume immediately, in a direction corresponding to the button selected.
 - To stop scan, press the A/B or mic PTT. The scan will stop and the display will indicate the current memory channel. The scan indicator will stop flashing.

(2) Programmable scan

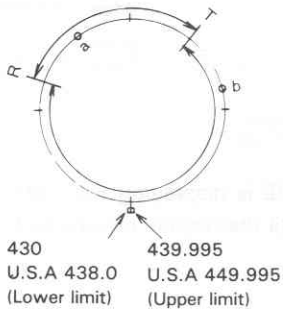

During VFO-A or VFO-B operation, depressing the SCAN/M2 key initiates scan programmed within the range set between the receive and transmit frequencies designated in memory channel 5.

As shown in the figure, R denotes the receive frequency in CH 5; T denotes the transmit frequency in CH 5.

- i) When VFO is at point A, scan starts as shown.

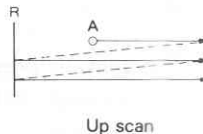

- ii) When VFO is at point B, scan starts as shown.

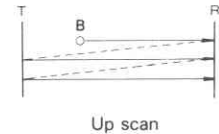

- iii) In the following cases, all the frequencies in all the bands are scanned.

- When the reception frequency R and the transmission frequency T are identical.
- When either of 439.975 (USA 449.975) MHz (when VFO A is used) or 439.995 (USA 449.995) MHz (when VFO B is used) is memorized for reception frequency R or transmission frequency T, and the VFO frequency is set to each corresponding point A.

Note: To program scan the frequency range of 439.00 (USA 449.00) - 439.975 (USA 449.975) MHz, store a frequency of 430.00 (USA 449.00) MHz for reception frequency R and 439.00 (USA 449.00) MHz for transmission frequency and set the VFO frequency to point B.

- iv) Program scan procedure is shown in the following A~G.
- Enter the lower; upper scan limits into memory channel 5, as described in the previous section.
 - To start scan, press the SCAN/M2 key. A flashing dot will appear in the display.
 - The radio will stop on an occupied channel for approximately 6 seconds.
 - To resume scan, press the UP or DOWN key of the microphone. Scan will start again immediately.
 - Holding the UP/DOWN keys depressed will cause the radio to tune rapidly up or down.
 - By holding either the UP or DOWN key of the microphone depressed past the previously programmed upper or lower limit, it will be possible to scan outside the limits, just as in (2) — ii) above.
 - To stop scan, press the A/B key or the PTT bar. The flashing dot will stop flashing, to resume scan it will be necessary to again depress the SCAN/M2 key.

(3) Releasing memory scan or program scan

Basically, press the mic PTT switch to release the memory scan, and press the A/B key or PTT switch to release the program scan. When the scan is released by PTT switch operation, no transmission is made. During scan operation, the following operations will release the scan.

- Depressing the MR switch on the keyboard or microphone during memory scan.
- Depressing the 1 key, or mic MR switch during program scan.
- Depressing the COM switch.
- Turning the power switch off.

Note: (USA version only)

In frequency construction, 439.965 MHz contains internal spurious. In this respect, when operating scan, note the frequency 439.965 MHz.

■ PR.W OPERATION

When PR.W has been selected the TM-411A/E will switch periodically, (approx. once every 6 seconds) and check for the presence of activity on channel **M1**. If there is activity on **M1** the display will change to **M1** frequency, the radio will monitor **M1** for approximately 2 seconds. If there is no activity the TM-411A/E will hold **M1** for approximately 0.3 seconds and then return to the current channel. The display frequency will remain on the active channel if no activity is present on **M1**.

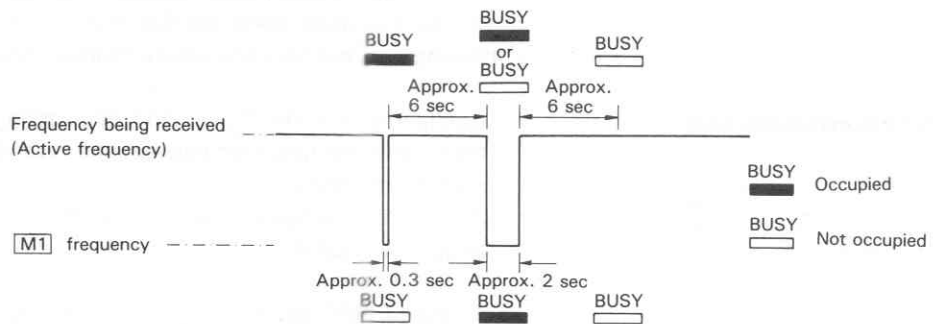

Note: If activity is present on **M1**, the TM-411A/E is displaying the **M1** frequency keyboard functions will be inhibited until the display returns to the active channel.

■ MIC CHECK FUNCTION

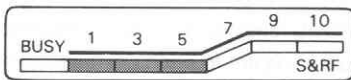

During transmission on low power, the microphone audio can be checked with the RF indicator. This is for checking if the microphone and modulation circuit are operating normally.

During transmission on low power, the RF indicator flashes 2nd — 4th LED position. When a sound is input through the microphone, the RF indicator flashes up to full scale, depending on the input level.

■ OSCILLATING MECHANISM

The TM-411A/E is designed to permit changing the front panel position in order to improve access to controls, etc.

The angle of the front panel is variable in three steps, up and down in 12° steps. The vertical angle is variable up to a total of 36°, up or down.

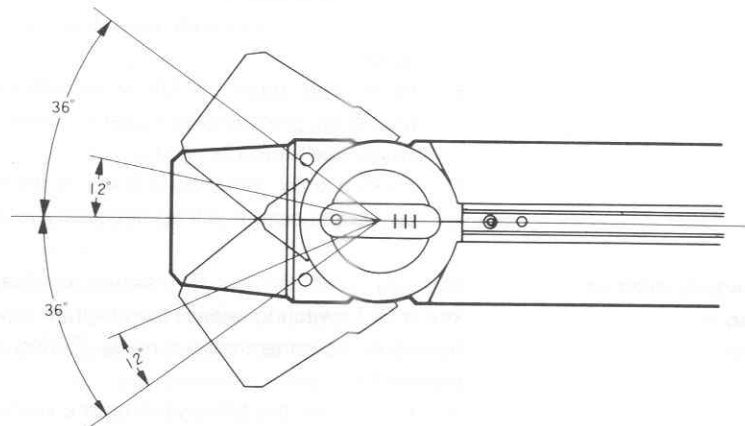

Note: When changing the front panel angle, do so gently and slowly. Rough treatment of the panel may cause a fault.

5. DCS (DIGITAL CODE SQUELCH)

1) DCS features

1. Digitally coded squelch operation.
2. 100,000 5 digit, ASCII code variations are possible. Additionally, the TM-411A/E can store 5 different code groups, any of which can be placed in a "Standby" or active mode.
3. Automatic transmission of call sign data whenever the DCS is activated.
4. Several methods of signalling the reception of the desired station are available.
5. Microprocessor control minimizes system malfunctions.

2) Table of ASCII codes for call sign entry

A : 65	B : 66	C : 67	D : 68
E : 69	F : 70	G : 71	H : 72
I : 73	J : 74	K : 75	L : 76
M : 77	N : 78	O : 79	P : 80
Q : 81	R : 82	S : 83	T : 84
U : 85	V : 86	W : 87	X : 88
Y : 89	Z : 90	Space : 32	
0 : 48	1 : 49	2 : 50	3 : 51
4 : 52	5 : 53	6 : 54	7 : 55
8 : 56	9 : 57		

■ DIGITAL CODE SETTING

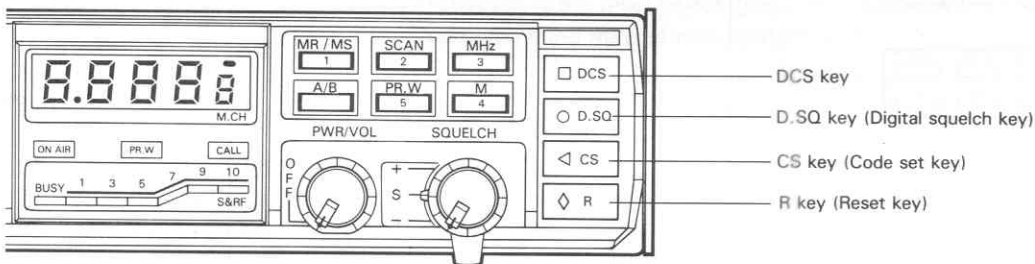

Digital code setting of TM-411A/E has the following functions.



1. Five different, erasable, digital codes (5 digits) can be stored.
2. * Standby can be designated for each digital code.
* (Refer to the later sections of connecting operation and code squelch.)

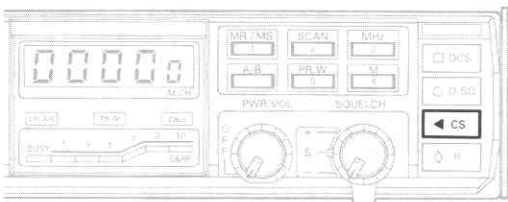

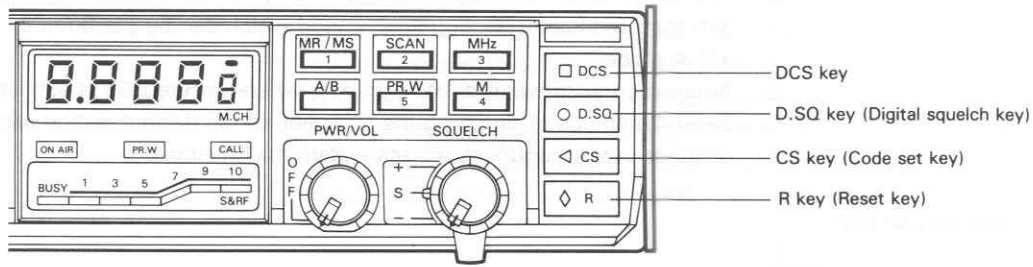
How To Operate

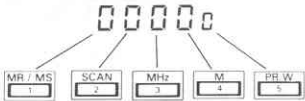
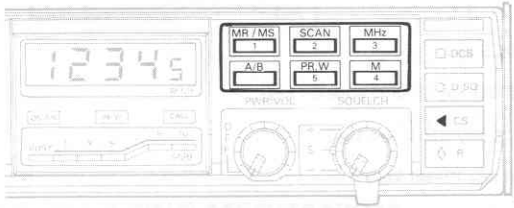
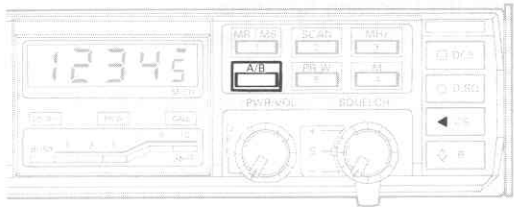
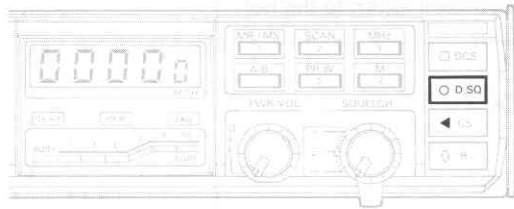
Operating procedure	Operation	Remarks
<p>1. Press the CS key to cause the digital access code to be displayed. ("00000" is displayed initially.)</p> 	<p>Pressing the key once makes the digital access code be displayed, a beep will sound the built-in LED will light. (Pressing the key again will return to the normal frequency display.)</p>	<p>This function is independent of the DCS key.</p>

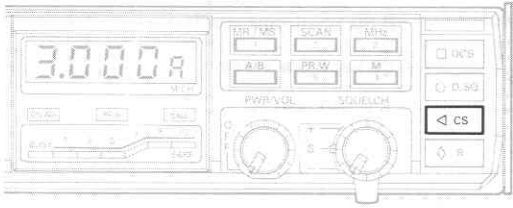

Operating procedure	Operation	Remarks
<p>2. Keys 1 thru 5 of the key board are used to set the digital access code.</p> <p>Key 1 controls the 10's of thousands digit. Key 2 control the thousands digit. Key 3 control the hundreds digit. Key 4 controls the 10's digit. Key 5 controls the 1's digit.</p>  	<p>Each time one of these keys is pressed the corresponding digit will increment up one count, i.e. 0 1 2...8 9. (Pressing the key continuously counts up continuously.)</p> <p>Referring to the illustration at the left, the digital code "12345" can be set by pressing the 1 key once, 2 key twice, 3 key three times, 4 key four times and 5 key five times.</p>	<p>It is possible to receive while setting the codes but not to transmit. The code memory is updated immediately after each key is pressed.</p>
<p>3. Press the [A/B] key to designate standby.</p> 	<p>Pressing this key once lights the standby indicator (5 in the case of the lefthand illustration). Repeating the key puts out the indicator.</p>	<p>This operation is valid only while the digital code is being displayed.</p>
<p>4. Press the [D.SQ] key to advance to the next access code channel. There are a total of 5 different code positions. (The available).</p> 	<p>Whenever the [D.SQ] key is pressed, the next digital code will be displayed. Perform procedures (2) and (3) above, and enter the desired digital codes. (The sequence number of each digital code will not be displayed.)</p>	<p>Since the [D.SQ] key works as a channel select key in this mode, the [D.SQ] LED of this key, will not turn on and off.</p>

Operating procedure	Operation	Remarks
<p>5. Press the  key to return to the normal frequency display.</p> 	<p>After all inputs have been completed, press the  key to return to the normal frequency display.</p>	<p>As long as you are displaying the digital codes you will not be able to transmit.</p>

- Notes:**
1. The digital code that appears when the  key is pressed is the code that will be transmitted, regardless of the standby status.
 2. The digital code that appears when the  key is pressed will also be one of the "Active" codes in receive, along with any other codes that have the standby indicator "ON".
 3. See page 23 for additional notes on the DCS.





■ CALL SIGN SETTING

The TM-411A/E employs a method of displaying and entering the call sign digit by digit using decimal ASCII codes. Set the call signal by referring to the ASCII code table on page 19.

After the call sign has been entered, it will not be necessary to reenter it as long as you operate the TM-411A/E.

(However, if the reset switch (page 7) is depressed or the lithium battery were to full, reprogramming may be necessary).

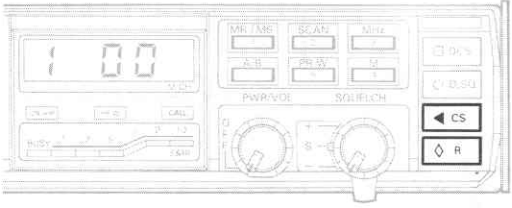
Entry

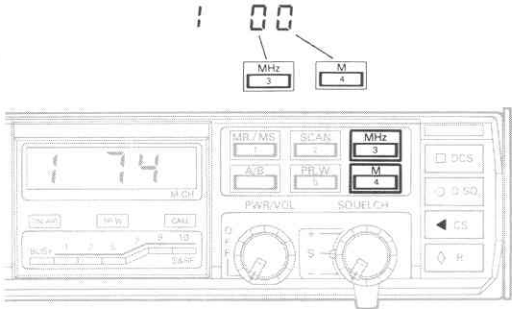
Operating procedure	Operation	Remarks
<p>1. To display the call sign, first press the  key and then, the  key.</p> 	<p>Each time the  key is pressed, the call sign and digital code will be displayed alternately.</p> <p>Referring to the lefthand illustration, 1 of "1 00" indicates the first digit of the call sign, JA1YKX, for example.</p>	<p>Whenever the call sign display has been selected by pressing the  key, the 1st digit of the call sign will always be displayed.</p>
<p>2. Enter the call sign, referring to the ASCII table on page 19 using the 3, 4 keys on the keyboard. Key 3 is used to enter the 10's digit. Key 4 is used to enter the 1's digit.</p> 	<p>Each time one of these keys is pressed, the corresponding digit will increment one count, 0 1 2 3...8 9. (Pressing the key continuously, increases the number continuously)</p> <p>Referring to the example at the left (call sign J=74), the 3 key is pressed 7 times and the 4 key is pressed 4 times.</p>	<p>It is possible to receive, but not to transmit while entering the call sign.</p>

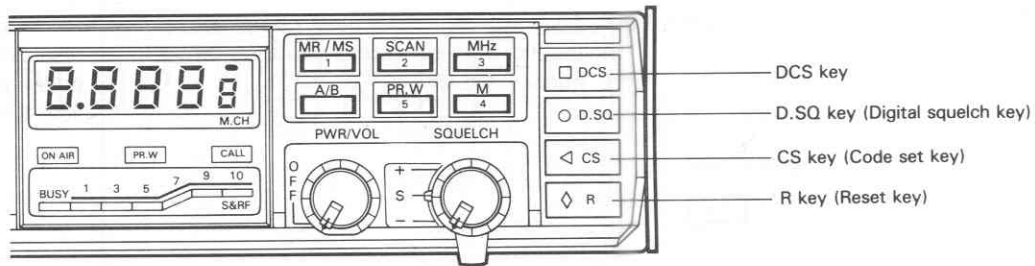

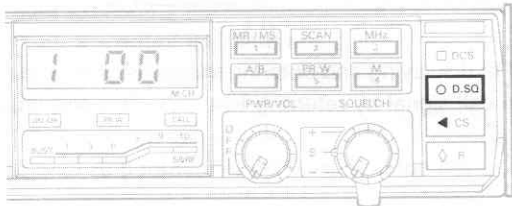
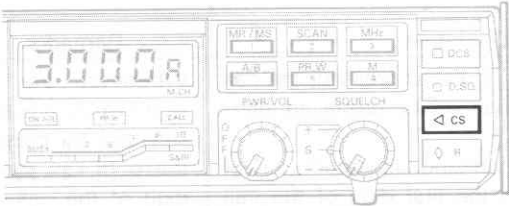
Operating procedure	Operation	Remarks
<p>3. Press the <input type="radio"/> D.SQ key to display the next digit of the call sign.</p> 	<p>Each time the key is pressed, the next digit of the call signal will be displayed. Repeat procedure (2) above, to enter the entire call sign. For example, JA1YKX, J was entered above. For the remaining characters (A)→65 2 5 5. Press the <input type="radio"/> D.SQ key. (1)→49, 3 49, <input type="radio"/> D.SQ (Y)→89 4 89 Press the <input type="radio"/> D.SQ key (K)→75 5 75, <input type="radio"/> D.SQ, (X)→88 5 88 The call sign has now been entered.</p>	<p>Since the <input type="radio"/> D.SQ key works as a digit select key in this mode the <input type="radio"/> LED, of this key, it's not turn on and off.</p>
<p>4. Press the <input type="checkbox"/> CS key to return to the normal frequency display.</p> 	<p>After all digits have been entered, press the <input type="checkbox"/> CS key to return to the normal frequency display.</p>	<p>Remember that transmit is inhibited while entering the call sign.</p>

Conversion of Call Sign to ASCII Code

1. Digit	1	2	3	4	5	6
2. Example	J	A	I	Y	K	X
	(74)	(65)	(49)	(89)	(75)	(88)
3. Your call sign	()	()	()	()	()	()

■ PRECAUTIONS ON OPERATING DSC SYSTEM

1) Digital code "Standby"

The "Standby" indicator is a usual indication of which digital access codes will actually open the squelch of your radio. Simply stated it shows the "ACTIVE" codes when the indicator is "ON", the code is "ACTIVE". When it is "OFF", the code is not active.



Fig. 1

The code displayed when the \triangleleft CS key is pressed to "ON" (called a transmit digital code) becomes an ACTIVE" digital code regardless of the standby indicator. For example, when the digital codes with the contents as shown below in Fig. 2 are stored in station A, the codes usable for standby are a, b and d. If station B transmits data using any one of a, b or d codes, station A squelch will open.

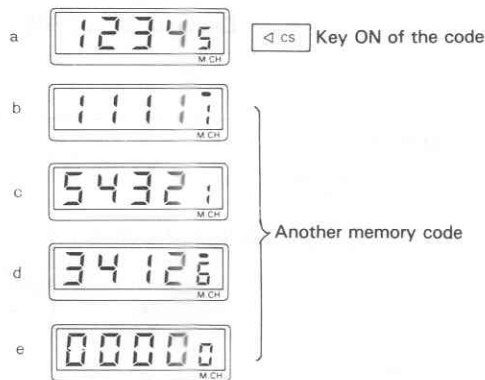
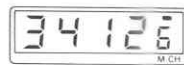

Fig. 2

If station B transmits a signal with code d above, the squelch of station A will open. At the same time station A will transmit digital code (a in the above example) will be changed to d. This is automatically performed by the microprocessor. This may be confirmed by pressing the \triangleleft CS key. Code d will be displayed. This is done so that station A will then be able to break station B's squelch.



2) There are several things that may cause the distant station to remain squelched.

DCS turned off on your set, no match on codes, interference, band conditions, microprocessor transients, noise, etc.

3) Transmitting with DCS "ON"

The DCS data string takes approximately 0,2 seconds at the beginning of the transmission. Wait a short period before talking to allow completion of the data transmission.

■ OPERATION OF DIGITAL SQUELCH

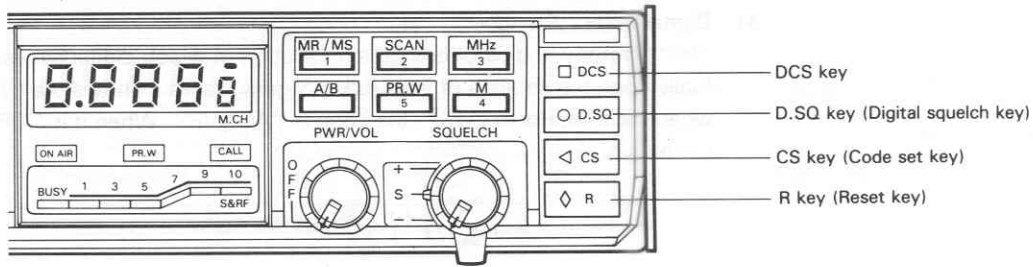

The new DCS gives the operation the ability to select which stations he wants to listen. To only those stations that transmit the proper data will be able to "OPEN" the squelch of the "TM-411A/E" when the DCS is on.

For example, when station A wishes to talk with station B only, the frequency and digital access code of both stations should be prearranged. It's assume:

Frequency: 443.00 MHz

Digital code: 12345

Operation

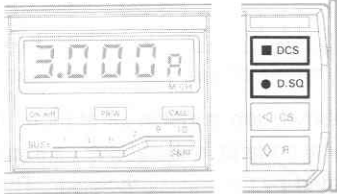
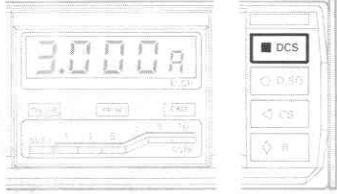
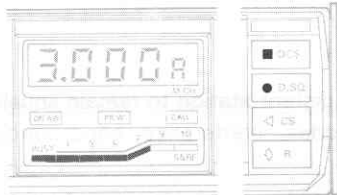
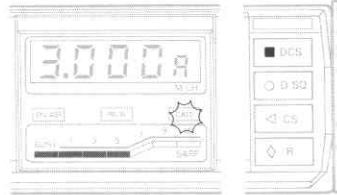
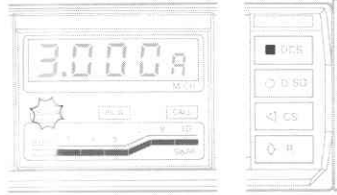
Station A	Station B
<p>1. Press the <input type="checkbox"/> DCS and <input type="radio"/> D.SQ key. The DCS is now active. (The LEDs of each key will light and undesired signals will not break squelch)</p> 	<p>1. Press the <input type="checkbox"/> DCS key to turn on the DCS.</p> 
<p>2. Signals of other stations (with different digital access codes, or no digital code) will not be heard, even though the S meter confirms it's presence.</p> 	
<p>3. When the station B transmits, the <input type="radio"/> D.SQ LED goes out, the "CALL" indicator lights and squelch will open.</p> 	<p>3. Press the microphone PTT switch to send the transmission code information. (The code information is sent at the beginning and the end of the transmission.)</p> 

- Digital squelch is operational only when the DCS is ON.
- To reset the digital squelch manually, press the D.SQ key again.
- The CALL indicator lights only when the proper code is received. To turn the indicator off, press the R key or press the D.SQ key to open the digital squelch.

■ How to use the code alert function

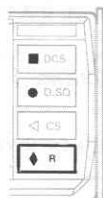
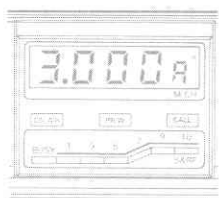

Two different alert functions see possible.

When the DCS and D.SQ keys are "ON" and the proper access code is received the TM-411A/E will beep once and the "CALL" indicator will turn on, to reset the DCS press the D.SQ key.

When the DCS, D.SQ and R keys are "ON" and the proper code is received. The D.SQ LED goes off. The TM-411A/E will beep continuously and the "CALL" indicator will light. To reset press the R key.

Use of the alert function in conjunction with the optional CD-10 call sign display will allow unattended monitoring for the desired station. If the alert "CALL" indicator is on, you can check the CD-10 to determine which station tried to contact you. See the CD-10 operating manual for further information on its operation.

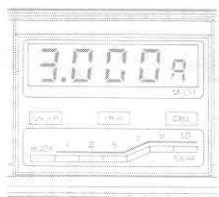

6. MAINTENANCE AND ADJUSTMENT

COVER REMOVAL

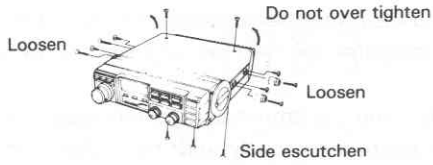

1. Loosen the 5 screws ($\phi 2.6 \times 5$ mm) of the side panels.
2. To remove the top cover, remove 2 screws. ($\phi 2.6 \times 5$ mm)
3. To remove the bottom cover, remove 5 screws. ($\phi 2.6 \times 5$ mm)

BEEPER ADJUSTMENT

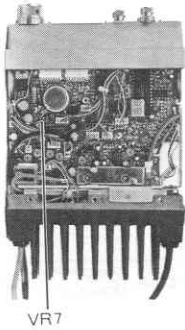

Adjust VR7 on the B unit (X53-1380-00) to the desired listening level.

- (1) Remove the bottom case.
- (2) Adjust VR7 as desired.
- (3) Replace the bottom case.

ATTACHEMENT AND DETACHMENT OF MOUNTING BOSS

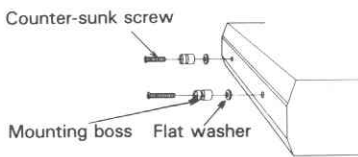

Either the flat washer or the stacking fixture must be installed, or the mounting bracket will not be securely fastened.

HOW TO REMOVE THE SHAFT COVER

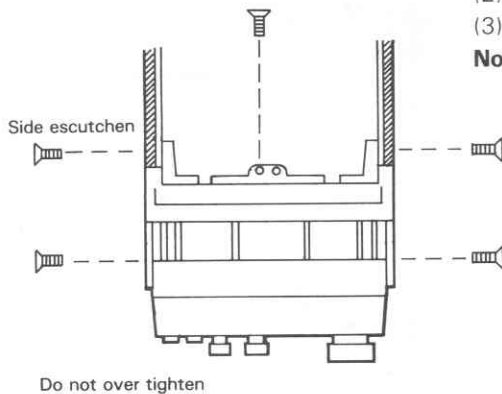

- (1) Remove 4 pan head screws and 4 mobile mounting bosses and remove the side escutcheon boards.
- (2) Remove 5 screws shown in the figure.
- (3) Move the panel three times and remove the shaft cover.

Note: When installing the shaft cover, take care not to pinch the wire harness.

■ LITHIUM BATTERY

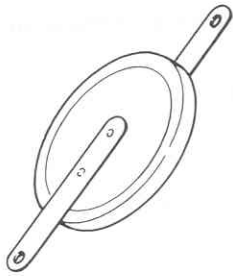

A lithium battery is contained in the transceiver to retain memory. Turning off the POWER switch, disconnecting the power cable, or a power failure will not erase the memory. The battery will last for approximately five years. When the battery discharges, an erroneous display may appear on the LED. Lithium battery replacement should be performed by an authorized TRIO-KENWOOD service facility, either your TRIO-KENWOOD dealer, or the factory.

Note: When the lithium battery is replaced, the microprocessor must be reset.

■ MICROCOMPUTER RESET

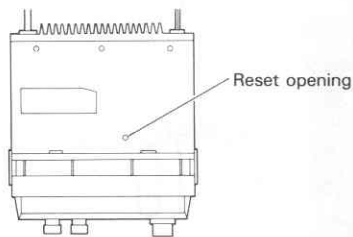

Depress the reset switch with a nonconductive rod through the reset opening of the bottom cover as shown.

- When the TM-411A/E malfunctions, do not reset the microcomputer immediately (the stored contents will be erased), but turn the power switch off and on slowly (the malfunction may be corrected by this operation) and then, if necessary, reset the microcomputer.
- First turn the power switch on and then, press the internal switch with a small rod.
- Use a non-conductive implement.

■ PANEL OSCILLATION

Front panel oscillation requires mechanical precision. Avoid removing the panel or applying unreasonable force to the panel.

■ CHANGING THE SCAN STOP MODE

The normal scan mode of the TM-411A/E is for time operated scan.

Carrier operated scan may be selected by cutting the jumper wire as illustrated in the figure on the following page 28.

■ CALL SIGN MONITOR SWITCH

This is used to monitor the call sign when the optional CD-10 call sign display is used. When switch S2 of unit B is set to ON (refer to "Adjusting beep sound level"), the data in the DCS can be monitored through the speaker. In the reception mode, a slight electrical may be received, in your speaker

■ ADJUSTING THE MICROPHONE SENSITIVITY

Turn VR5 of unit B to adjust the microphone sensitivity. Clockwise to increase. Counterclockwise to reduce.

■ ADJUSTING LOW POWER OUTPUT

Adjust VR3 of unit B to adjust the output to approximately 20 W in low power mode.
Carefully remove the cases and covers.
(When the bottom cover and the shaft cover is removed)

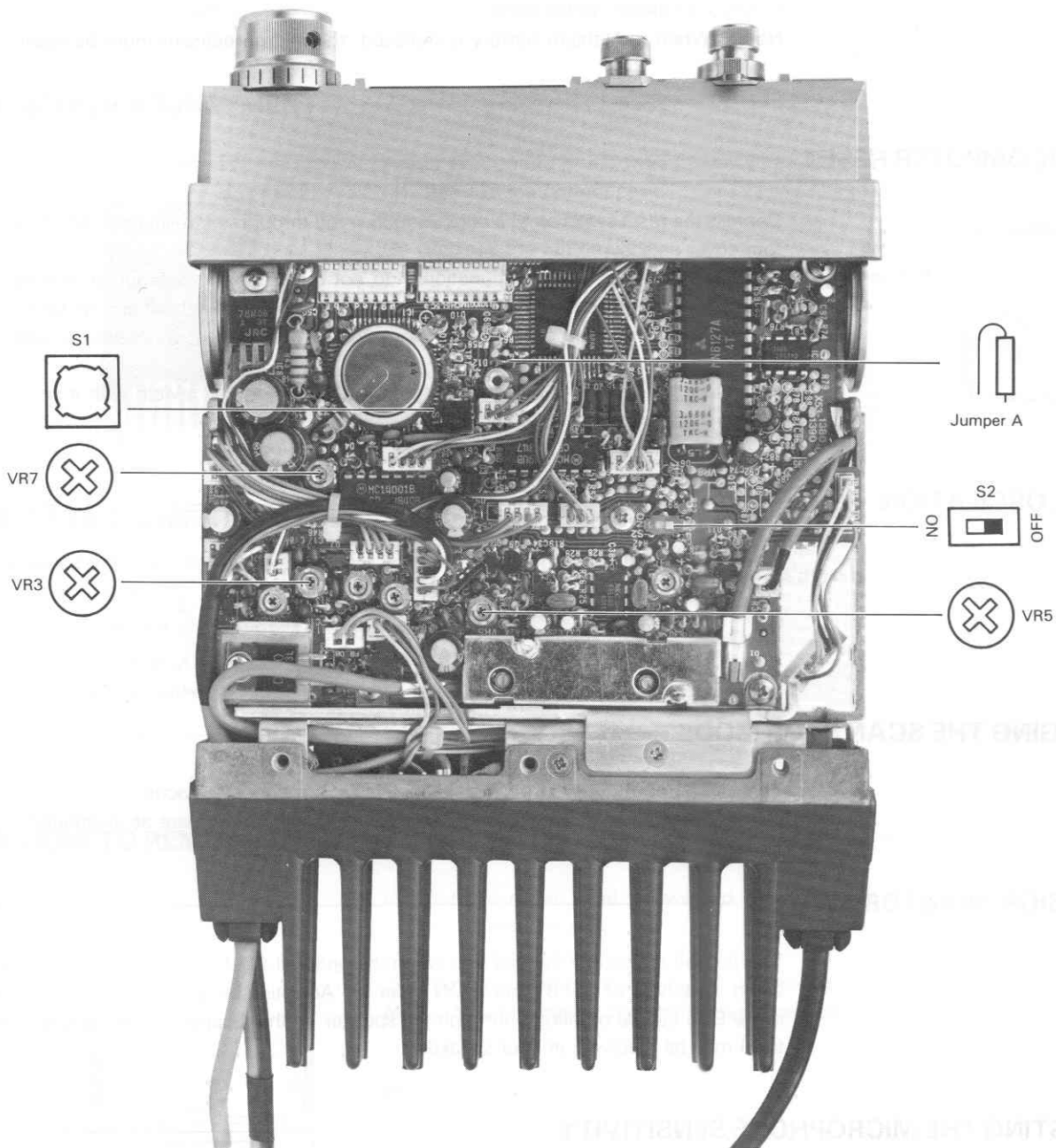

Do not touch any variable resistors or switches, other than those indicated in the above photograph. Doing so may cause a failure

7. ACCESSORIES

■ PS-430 POWER SUPPLY

A DC regulated power supply unit matching the TM-411A/E.
Combined use with TM-411A/E permits you to enjoy stable fixed station operation.



■ CALL SIGN DISPLAY

Connecting this unit with TM-411A/E permits alpha numeric display of the call sign of those remote stations (who have attempted to contact you, if they are also equipped with the DCS).

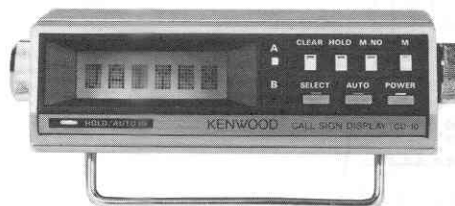

TU-3A (TWO-TONE UNIT: OPTION) Instructions for the TM-411A only

• Accessories

1. Diode Matrix (D9)(R90-0580-05) 1
2. Adhesive Cushion(G11-0612-14) 2
3. Tone Frequency Name Plate(B42-1780-14) 1
4. Biding tapping screw ($\phi 2 \times 5$)(N89-2005-00) 1
5. Instruction Manual(B50-4182-00) 1

• Tone Frequency Setting



To set subtype, cut diode(s) according to the table.

Diode Matrix (D9) Setting

1. Select the desired first tone frequency by cutting selected diodes from diode array D9, referring to the table.

Example: To set to 94.8 Hz, cut D9 diodes as shown.

To mount the D9, use a 45-W (or less) soldering pencil and solder sparingly, heating the connections only long enough to insure a good solder joint. Do not over heat.



2. Select the desired second tone frequency by setting the 6-bit dip switch, referring to the table.

Example: To set to 100.0 Hz, set the dip switch as shown.



• Tone unit Installation

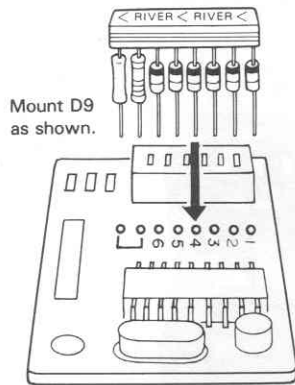

Mount D9 as shown.

1. Mount the supplied diode array D9 (frequency preset) in the TU-3A unit as shown.

2. Remove the bottom cover as shown in Fig. 3.

3. Attach the supplied cushion to the place indicated with broken lines at the rear (pattern side) of TU-3A as shown in Fig. 4.

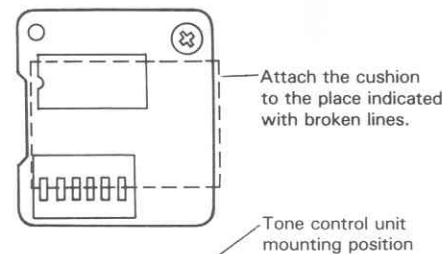
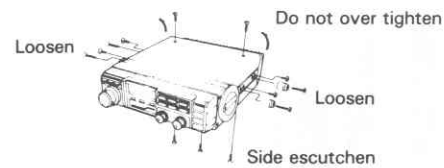

Attach the cushion to the place indicated with broken lines.

Tone control unit mounting position

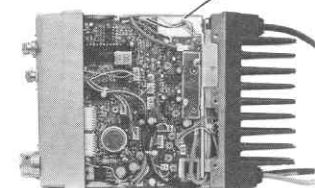

EIA Specification Group ("1" denotes that the diode is opened.)

#	EIA Specification Group	Hz	Program Lines (ON...1, OFF...0)						#	EIA Specification Group	Hz	Program Lines (ON...1, OFF...0)					
			1	2	3	4	5	6				1	2	3	4	5	6
1	A	67.0	1	1	1	1	1	1	21	A	141.3	1	0	0	0	0	0
2	B	71.9	1	1	1	1	0	1	22	B	146.2	0	1	1	1	0	1
3	C	74.4	1	1	1	0	1	1	23	A	151.4	0	1	1	1	0	0
4	A	77.0	1	1	1	1	0	0	24	B	156.7	0	1	1	0	0	1
5	C	79.7	1	1	0	1	1	1	25	A	162.2	0	1	1	0	0	0
6	B	82.5	1	1	1	0	0	1	26	B	167.9	0	1	0	1	0	1
7	C	85.4	1	1	0	0	1	1	27	A	173.8	0	1	0	1	0	0
8	A	88.5	1	1	1	0	0	0	28	B	179.9	0	1	0	0	0	1
9	C	91.5	1	0	1	1	1	1	29	A	186.2	0	1	0	0	0	0
10	B	94.8	1	1	0	1	0	1	30	B	192.8	0	0	1	1	0	1
11	A	100.0	1	1	0	1	0	0	31	A	203.5	0	0	1	1	0	0
12	B	103.5	1	1	0	0	0	1	32	B	210.7	0	0	1	0	0	1
13	A	107.2	1	1	0	0	0	0	33	A	218.1	0	0	1	0	0	0
14	B	110.9	1	0	1	1	0	1	34	B	225.7	0	0	0	1	0	1
15	A	114.8	1	0	1	1	0	0	35	A	233.6	0	0	0	1	0	0
16	B	118.8	1	0	1	0	0	1	36	B	241.8	0	0	0	0	0	1
17	A	123.0	1	0	1	0	0	0	37	A	250.3	0	0	0	0	0	0
18	B	127.3	1	0	0	1	0	1									
19	A	131.8	1	0	0	1	0	0									
20	B	136.5	1	0	0	0	0	1									

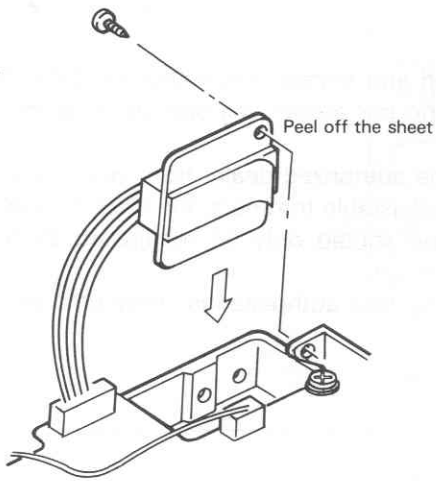

4. Connect the 5P connector of the B unit of TU-3A as shown in Fig. 6.
 5. Peel off the tape from the cushion attached to TU-3A and attach it to the mounting position.
 6. Secure with the supplied bind tap tight screws.
 7. Install the bottom case. Tighten the mounting screws securely.
 8. By removing the shield from the side case, the dip switches can be set from the outside.
- Attach the supplied frequency lable to the unit.

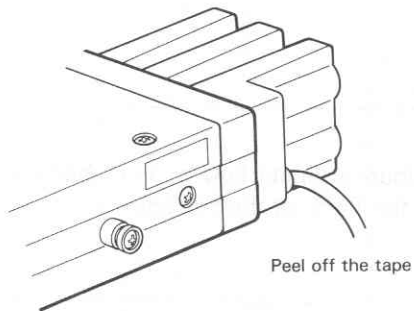

■ GENERAL INFORMATION

Your TM-411A/E has been factory aligned and tested to specification before shipment. Under normal circumstances, the transceiver will operate in accordance with these operating instructions.

If your transceiver fails to work, contact the authorized dealer from which you purchased it for quick, reliable repair. All adjustable trimmers and coils in your transceiver were preset at the factory and should only be readjusted by a qualified technician with proper test equipment.

Attempting service or alignment without factory authorization, may void the warranty.

■ HOW THE TX FINAL MODULE IS PROTECTED

Final module protection is provided by sampling the reflected power. As the reflected power is increased (higher SWR) transmitter drive is reduced, thus decreasing input to the final module. This in turn reduces collector loss, protecting the final transistor.

■ BATTERY PRECAUTION

When charging your vehicle battery, or when jumpstarting a dead battery, ALWAYS disconnect the power cable from the back of the transceiver.

■ ORDERING SPARE PARTS

When ordering replacement or spare parts for your equipment, be sure to specify the following:

- Model and serial number of your transceiver. Schematic number of the part. Printed circuit board number on which the part is located. Part number and name, if known, and quantity desired.

■ SERVICE

Should it ever become necessary to return the equipment to your dealer or service center for repair, pack in its original box and packing, and include a full description of the problems involved. Also include your telephone number. You need not return accessory items unless directly related to the service problem. Tag all returned items with your call for identification.

Please mention the model and serial number of your radio in any correspondence, whether phone or written. For future reference, record this information in the space provided on the back cover of this manual.

Note: When claiming warranty service, please include a photocopy of the bill of sale, or other proof of purchase showing the date of sale.

8. BLOCK DIAGRAM

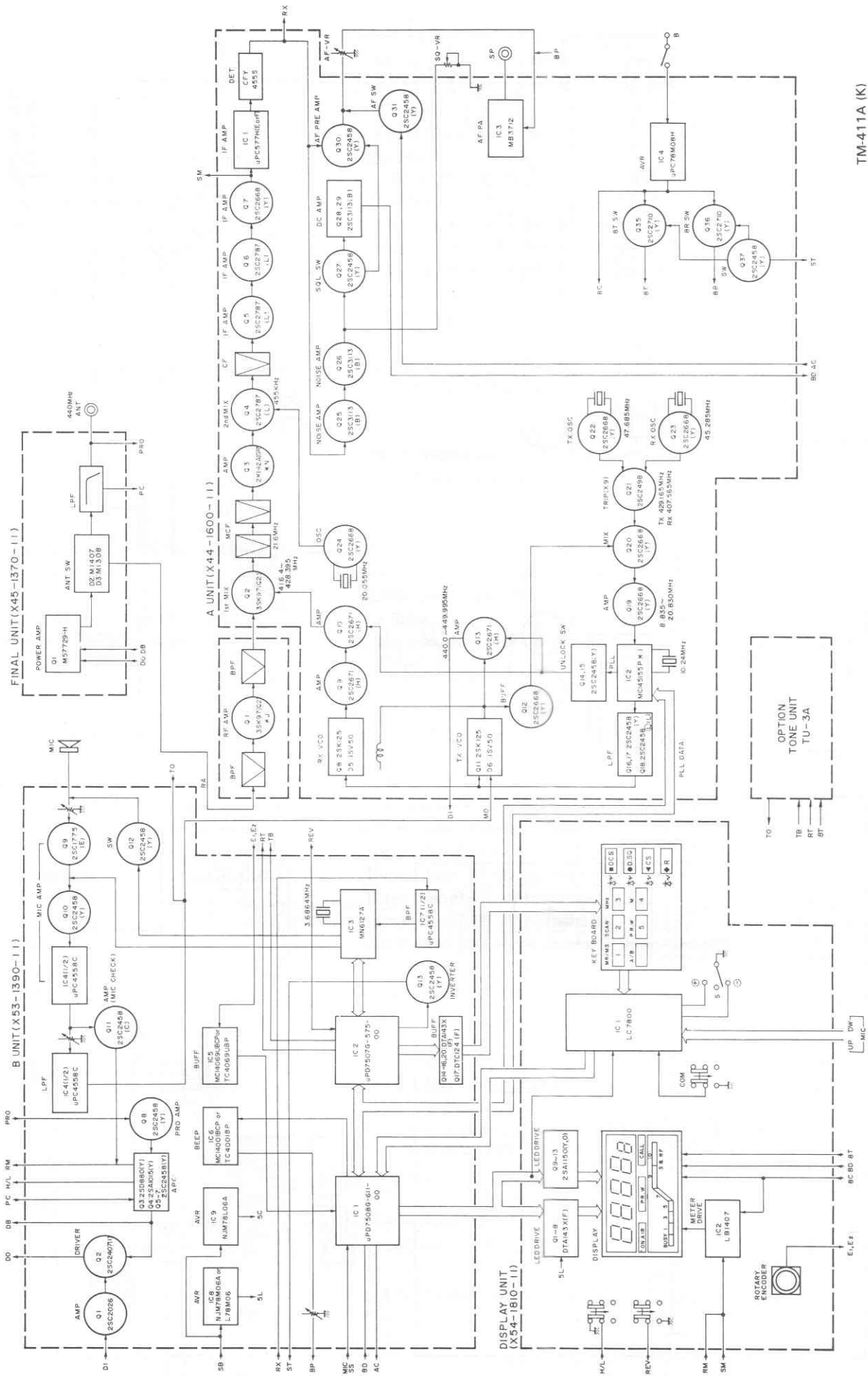

TM-411A (K)

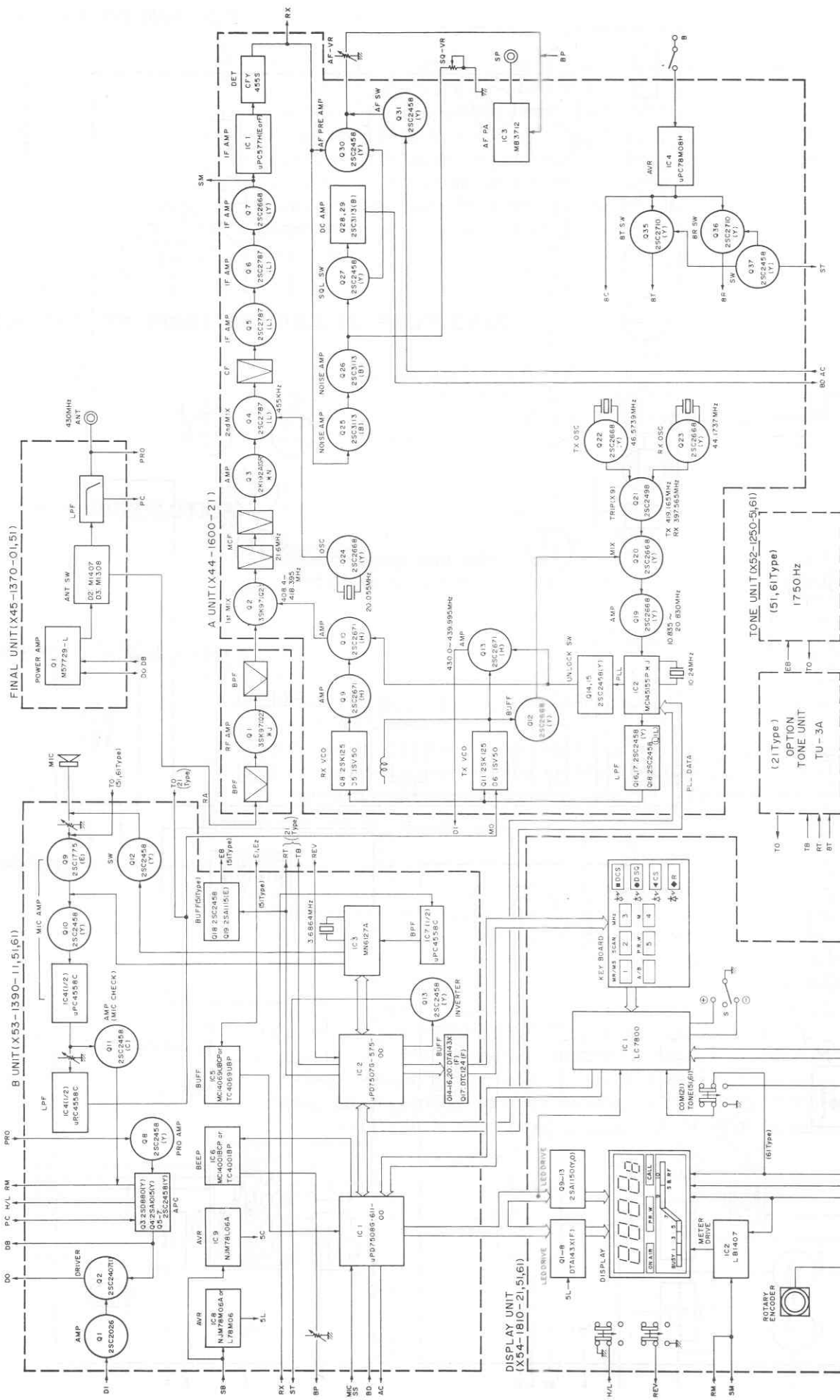

TM-411A (M)
TM-411E (T,W)

9. SPECIFICATIONS

[General]

Frequency range	430 to 440 MHz (430 MHz Version) 438 to 450 MHz (440 MHz Version)
Mode	FM F3, F2 (Control signal for DCS operation)
Antenna impedance	50 ohms
Power requirement	13.8V DC \pm 15%
Grounding	Negative
Operating temperature	-20°C to +50°C (-4°F to +122°F)
External speaker impedance	8 ohms
Current drain	0.5 A in receive mode with no input signal Max. 6.9 A in HI transmit mode 3.0 A in LOW transmit mode (Approx.)
Dimensions	140 mm wide 40 mm high 197 mm deep (projections not included)
Weight	1.25 kg (2.75 lbs)

[Transmitter]

RF output power (at 13.8V DC, 50 Ω load)	HI 25 Watts min. Low 5 Watt approx. (adjustable upto about 15 W) TX Duty cycle: 1 minute ON, 3 minutes OFF
Modulation	Reactance
Frequency tolerance (-10°C ~ +60°C)	Less than $\pm 15 \times 10^{-6}$
Spurious radiation	HI Less than -70 dB LOW Less than -60 dB
Maximum frequency deviation (FM)	± 5 kHz
Audio distortion (at 60% modulation)	3% max. (300 Hz ~ 3000 Hz)

[Receiver]

Circuitry	Double superheterodyne
Intermediate frequency	1st 10.695 MHz 2nd 455 kHz
Receiver sensitivity	SINAD 12 dB less than 0.18 μ V S + N/N more than 50 dB at 1.0 mV input
Receiver selectivity	More than 12 kHz (-6 dB) Less than 24 kHz (-60 dB)
Spurious response	Better than 70 dB (except $f_c - IF/2$)
Squelch sensitivity	Less than 0.15 μ V (threshold)
Auto scan stop level	Less than 0.18 μ V (threshold)
Audio output	More than 2.0 watts across 8 ohms load (5% dist.)

[Auto patch microphone (MC-48) supplied] — For U.S.A. version only

Impedance	900 ohms
-----------------	----------

[DCS control]

Code	NRZ equal-length code
Modulation	MSK modulation
Frequency deviation	± 2.5 kHz or more + 5 kHz or less + 3.5 kHz Standard
Mark frequency and deviation	1200 Hz \pm 200 PPM
Space frequency and deviation	1800 Hz \pm 200 PPM
Code transmission speed and deviation	1200 bits/second \pm 200 PPM

Note: Circuit and ratings are subject to change without notice due to developments in technology.

Free Manuals Download Website

<http://myh66.com>

<http://usermanuals.us>

<http://www.somanuals.com>

<http://www.4manuals.cc>

<http://www.manual-lib.com>

<http://www.404manual.com>

<http://www.luxmanual.com>

<http://aubethermostatmanual.com>

Golf course search by state

<http://golfingnear.com>

Email search by domain

<http://emailbydomain.com>

Auto manuals search

<http://auto.somanuals.com>

TV manuals search

<http://tv.somanuals.com>