

# KitchenAid®

FOR THE WAY IT'S MADE.



## KitchenAid®

### Built-In Refrigerators

Models KSSS36D KSSS36M  
KSSS42D KSSS42M  
KSSS48D KSSS48M

A Note To You .....2

Important Safety  
Instructions .....3

Parts And Features .....4

Using The Refrigerator .....5

Caring For The  
Refrigerator .....20

Food Storage Guide .....22

If You Need Assistance  
Or Service .....24

Warranty .....26

In The U.S., Call Us With  
Questions Or Comments:  
**1-800-422-1230**

## Use and Care Guide

Part No. 2001362 11/92

11-92

# A Note To You

## Thank you for buying a KitchenAid home appliance.

You have purchased a quality, *world-class* home appliance. Years of engineering experience have gone into its manufacturing. To ensure that you will enjoy many years of trouble-free operation, we have developed this Use and Care Guide. It is full of valuable information on how to operate and maintain your home appliance properly and safely. Please read it carefully. Also, please complete and mail the Ownership Registration Card provided with your home appliance.

## Your safety is important to us.

This guide contains safety symbols and statements. Please pay special attention to these symbols and follow any instructions given. Here is a brief explanation of the use of each symbol.

### **⚠ WARNING**

This symbol will help alert you to such dangers as personal injury, burns, fire and electrical shock.

### **⚠ CAUTION**

This symbol will help you avoid actions which could cause product damage (scratches, dents, etc.) and damage to your personal property.

## Our Consumer Assistance Center telephone number, 1-800-422-1230, is toll-free, 24 hours a day (for U.S. only).

If you ever have a question concerning your home appliance's operation, or if you need service, feel free to call our toll-free Consumer Assistance Center telephone number for help. When calling, you will need to know your appliance's complete model number and serial number. You can find this information on the model and serial number label (see diagram on page 4). For your convenience, we have included a handy place below for you to record these numbers. Also, please record the date the product was purchased/installed and the Builder's or Dealer's name, address and phone number. You will need this information if you ever require service. Keep this book and the sales slip together in a safe place for future reference.

**IMPORTANT:** You must provide proof of purchase or installation date for in-warranty service.

Model Number \_\_\_\_\_ Builder/Dealer Name \_\_\_\_\_  
 Serial Number \_\_\_\_\_ Address \_\_\_\_\_  
 Date Purchased \_\_\_\_\_ Phone \_\_\_\_\_  
 Date Installed \_\_\_\_\_

### Don't forget, KitchenAid offers a full line of quality home appliances.

Built-In Refrigerators	Trash Compactors	Ranges & Cooktops
Freestanding Refrigerators	Hot Water Dispensers	Microwave Ovens
50-Pound Ice Makers	Food Waste Disposers	Washers & Dryers
Dishwashers	Built-In Ovens	Mixers

For more information on these appliances, or the one you have purchased, call our toll-free Consumer Assistance Center telephone number, 1-800-422-1230 or an authorized dealer.

# Important Safety Instructions

## **⚠ WARNING**

To reduce the risk of fire, electrical shock or injury when using the refrigerator, follow these basic precautions:

- Read all instructions before using the refrigerator.
- Child entrapment and suffocations are not problems of the past. Junked or abandoned refrigerators are still dangerous ... even if they will "just sit in the garage a few days."  
If you are getting rid of your old refrigerator, do it safely. Please read the enclosed safety booklet from the Association of Home Appliance Manufacturers. Help prevent accidents.
- Never allow children to operate, play with, or crawl inside the refrigerator.
- Never clean refrigerator parts with flammable fluids. The fumes can create a fire hazard or explosion.
- Always turn the power on/off switch (located behind the upper ventilation panel) to the OFF position before attempting to change light bulbs, clean or service the refrigerator.
  - FOR YOUR SAFETY •

DO NOT STORE OR USE GASOLINE OR OTHER FLAMMABLE VAPORS AND LIQUIDS IN THE VICINITY OF THIS OR ANY OTHER APPLIANCE. THE FUMES CAN CREATE A FIRE HAZARD OR EXPLOSION.

**– SAVE THESE INSTRUCTIONS –**

## Help us help you

Please:

- Install and level refrigerator on a floor that will hold the weight, and in an area suitable for its size and use.
- Connect refrigerator only to the proper kind of outlet, with the correct electrical supply and grounding. (Refer to the Electrical Requirements and Grounding Instructions Sheet.)
- Use refrigerator only for the uses as described in this manual.
- Make sure refrigerator is not near an oven, radiator or other heat source.
- Properly maintain refrigerator.
- Make sure refrigerator is used in an area where the room temperature will not fall below 55°F (13°C).
- Make sure refrigerator is not used by anyone unable to operate it properly.
- Make sure refrigerator is not loaded with food before it has time to get properly cold.

# Parts And Features

This section contains captioned illustrations of your appliance. Use them to become familiar with where all parts and features are located and what they look like. Your appliance may have all or some of the features shown. This manual is intended to cover many models.

## Dispenser model shown

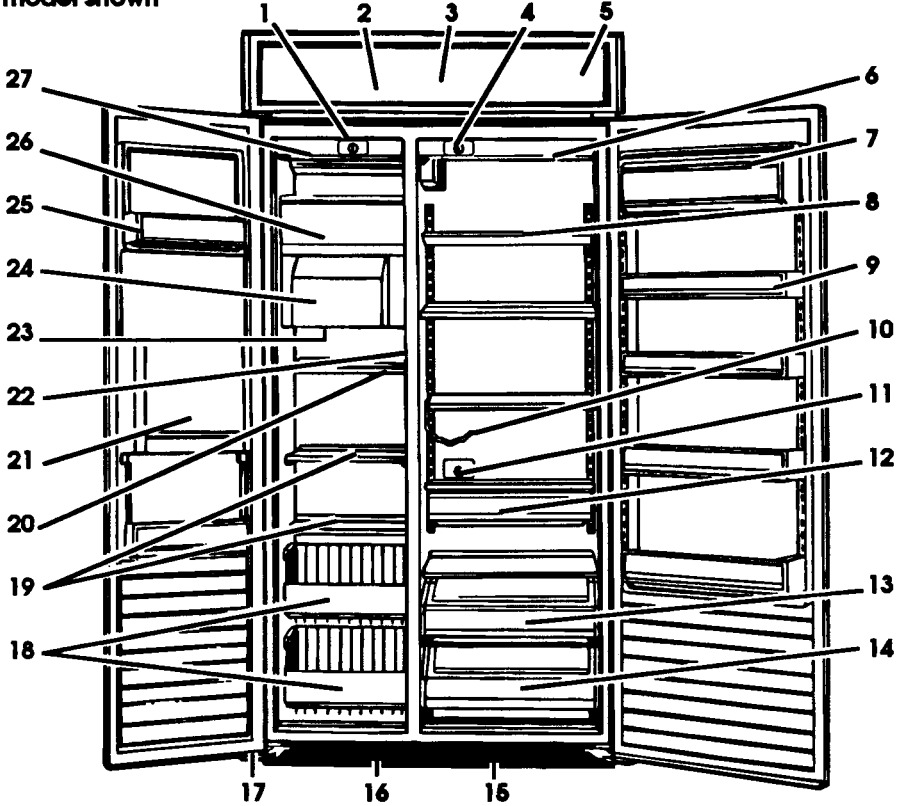

- |   |  |
|---|--|
| 1. Freezer control  | 14. Roll-out humidity-controlled ClearVue™ crisper |
| 2. Upper ventilation panel                                | 15. Base grille                                    |
| 3. Power on/off switch (behind upper ventilation panel)   | 16. Defrost pan (behind base grille)               |
| 4. Refrigerator control                                   | 17. Water/electrical dispenser supply tube         |
| 5. Water valve (behind upper ventilation panel)           | 18. Pull-out freezer baskets                       |
| 6. Refrigerator lights (behind control panel)             | 19. Stationary freezer shelves                     |
| 7. Utility compartment                                    | 20. Adjustable freezer shelf                       |
| 8. Adjustable glass shelves                               | 21. Water and Ice dispenser area (on some models)  |
| 9. Adjustable door bins                                   | 22. Model and serial number label                  |
| 10. Wine/egg rack   | 23. Freezer light (below Ice bin)                  |
| 11. WinterChill™ meat locker temperature control          | 24. Ice bin (on some models)                       |
| 12. Roll-out adjustable WinterChill™ meat locker          | 25. Stationary door shelf                          |
| 13. Roll-out humidity-controlled ClearVue™ utility drawer | 26. Automatic Ice maker                            |
|   | 27. Freezer light (behind control panel)           |

# Using The Refrigerator

In This Section		Page	Page
Upper ventilation panel .....	5	Adjustable freezer shelves .....	11
Power on/off switch .....	6	Pull-out freezer baskets .....	11
Temperature controls .....	6	Automatic ice maker .....	12
WinterChill™ meat locker temperature control .....	7	Ice maker storage bin .....	13
Adjustable utility compartment .....	7	Cold water and ice dispensers .....	14
Adjustable door bins .....	8	Dispenser/ice maker operating tips ...	15
Adjustable refrigerator shelves .....	8	Base grille .....	16
Wine/egg rack .....	8	Defrost pan .....	17
WinterChill™ meat locker .....	9	Changing the light bulbs .....	18
Humidity-controlled ClearVue™ utility drawer/crisper .....	10	To save energy .....	19
		Sounds you may hear .....	19

In order to obtain the best possible results from your refrigerator, it is important that you operate it properly. This section will tell you how to do just that.

## Upper ventilation panel

### To remove:

1. Grasp both ends of the panel.
2. Push straight up, then pull straight out.

**IMPORTANT:** A cable on each side of the upper ventilation panel attaches it to the grille assembly. The upper ventilation panel can be suspended by these cables while cleaning the condenser or turning off the power on/off switch.

### To replace:

1. Insert screw heads (on the back side of the upper ventilation panel) into the large part of the keyhole openings.
2. Pull panel down slightly to lock into place.

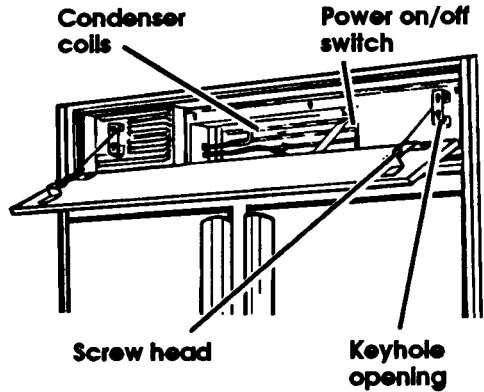

## Power on/off switch (power interrupter switch)

The power on/off switch is located behind the upper ventilation panel. It is used to turn the power to the refrigerator off when cleaning it or changing light bulbs.

### To turn power off:

1. Remove upper ventilation panel.
2. Press power on/off switch to the OFF position.

### To turn power on:

1. Press power on/off switch to the ON position.
2. Replace upper ventilation panel.

**IMPORTANT:** Be sure the power on/off switch is in the ON position after cleaning refrigerator or changing light bulbs.

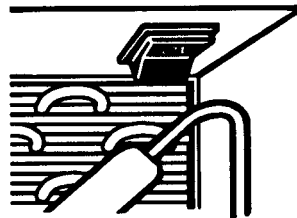

## Temperature controls

The Refrigerator and the Freezer Controls have been preset at the factory. These settings should be correct for normal household refrigerator use. Allow the refrigerator to reach the preset temperature (approximately 24 hours) before changing the settings.

### To change a temperature setting:

1. Adjust the Refrigerator and/or Freezer Control.
  - To make the selected control colder, turn the knob clockwise.
  - To make the selected control less cold, turn the knob counterclockwise.
2. Wait at least 24 hours before making further adjustments. This allows the refrigerator and/or freezer to reach the new temperature setting.

**IMPORTANT:** The Off setting on the Freezer Control stops all cooling action in the refrigerator, but it does not disconnect the refrigerator from the power supply.

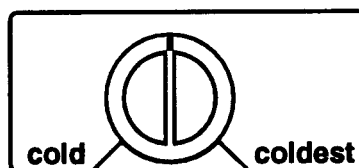

Refrigerator control

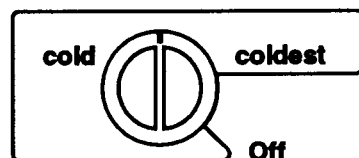

Freezer control

## WinterChill™ meat locker temperature control

The WinterChill Meat Locker Temperature Control allows you to adjust the storage temperature of the WinterChill meat locker.

Cold air flows into the meat locker through an air duct between the freezer and the refrigerator. Setting the control allows more or less cold air through the air duct. See page 9 for more information on the WinterChill meat locker.

**IMPORTANT:** Occasionally, a food item may freeze in the WinterChill meat locker, utility drawer, or crisper. When this occurs, turn the WinterChill Meat Locker Temperature Control toward cold.

Also, if the water dispenser stops working, it may be due to freezing of the water line leading to the dispenser. If this happens, turn the WinterChill Meat Locker Temperature Control toward cold.

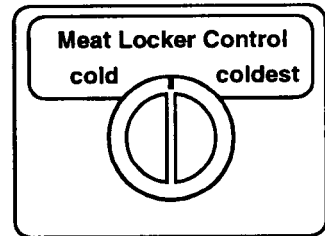

## Adjustable utility compartment

(models KSSS36D, KSSS36M, KSSS42D and KSSS42M)

The utility compartment can be placed in any position on the refrigerator door.

### To remove:

1. Grasp both ends of compartment.
2. Lift compartment up and pull out.

### To replace:

1. Insert compartment hooks into ladder slots on both sides of refrigerator door.
2. Push compartment down to lock into place.

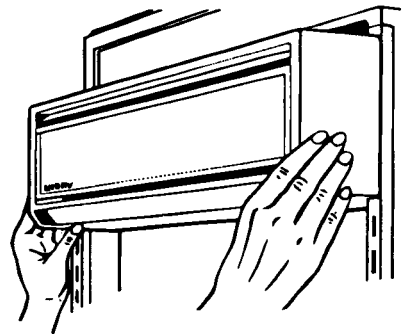

## Adjustable door bins

Door bins can hold two-liter bottles and can be placed in any position on the refrigerator door.

**To remove:**

1. Grasp door bin.
2. Lift door bin up and pull out.

**To replace:**

1. Insert door bin hooks into ladder slots on both sides of refrigerator door.
2. Push door bin down to lock into place.

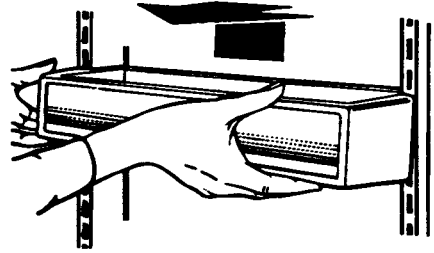

## Adjustable refrigerator shelves

The shelves can be adjusted to match the way you use your refrigerator.

**To remove:**

1. Tilt front of shelf up.
2. Lift shelf up at back.
3. Pull shelf straight out.

**IMPORTANT:** Glass shelves are heavy. Handle with care.

**To replace:**

1. Guide the rear shelf hooks into the ladder slots on back wall of refrigerator cabinet.
2. Tilt shelf up until hooks drop into slots.
3. Lower front of shelf to a level position.
4. Check the stability of the shelf to be sure the hooks have been properly inserted.

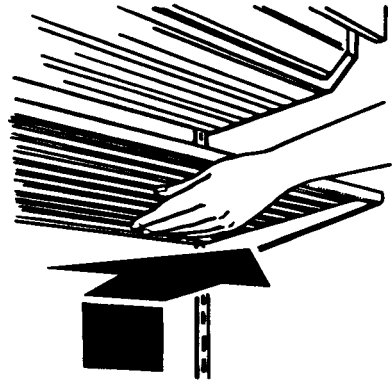

## Wine/egg rack

The wine/egg rack is shaped to hold either a bottle of wine or a carton of eggs securely. The wine/egg rack can be placed over the edge of any shelf.

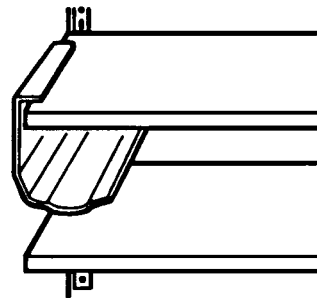



## WinterChill™ meat locker

The WinterChill Meat Locker is designed to provide colder storage temperatures than the average refrigerator temperature. The Meat Locker can be located in any set of ladder slots. For temperature controlled use, however, the Meat Locker must be located in the second to last (bottom) set of ladder slots.

The WinterChill Meat Locker can be removed for cleaning.

**IMPORTANT:** Occasionally, a food item may freeze in the WinterChill meat locker, utility drawer, or crisper. When this occurs, turn the WinterChill Meat Locker Temperature Control toward cold.

### To remove:

1. Roll meat locker out to the stop.
2. Lift front of meat locker slightly.
3. Pull meat locker out the rest of the way.

### To replace:

1. Position meat locker rollers between front roller of track and track itself.
2. Push meat locker up and onto track.
3. Slide meat locker back until it stops.

**IMPORTANT:** If the meat locker is placed in any set of slots other than the second to last (bottom) set of ladder slots, plug the air supply hole. The plug has been taped to the inside bottom of the meat locker for this purpose.

The rubber air connector (located on back of meat locker) directs air from the air supply hole into the meat locker. If the air connector comes off, replace it by pushing it into the square opening on back of meat locker.

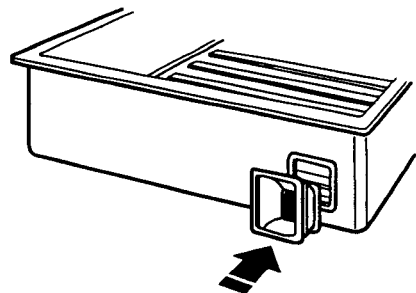
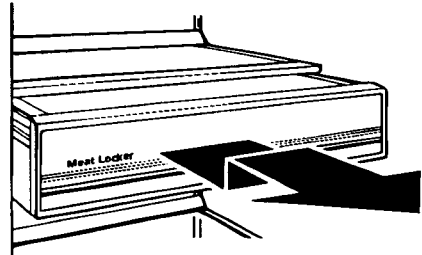

## Humidity-controlled ClearVue™ utility drawer/ crispener

The humidity controls on the drawers give you the ability to change the amount of moisture in the utility drawer and/or crispener according to what food you store in it. The humidity-controlled utility drawer and the crispener are interchangeable. The ClearVue section allows you to see into the drawer/ crispener without opening it.

**IMPORTANT: Occasionally, a food item may freeze in the WinterChill meat locker, utility drawer, or crispener. When this occurs, turn the WinterChill Meat Locker Temperature Control toward cold.**

### To adjust the humidity control:

- Move the lever to the right for higher humidity and best storage of fresh, leafy vegetables.
- Move the lever to the left for lower humidity and best storage of fruits and vegetables with skins.

See "Food Storage Guide" on page 22 for more information on storing foods properly.

### To remove utility drawer/crisper:

1. Roll drawer out to the stop.
2. Lift front of drawer and pull out the rest of the way.
3. Replace in reverse order.

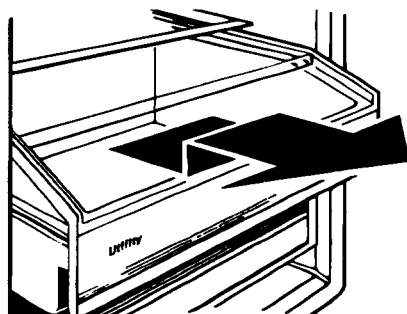

### To remove glass covers:

1. Lift right side of glass cover to free retainer and left side of cover.
2. Carefully remove glass cover.

### To replace glass cover:

1. Place retainer on right side of glass cover.
2. Insert left side of glass cover into groove on left side of drawer.
3. Lower cover so that the retainer pins are in the guide holes on right side of drawer.

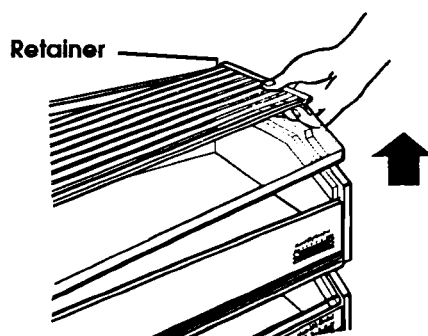

**To remove ClearVue™ section:**

1. Remove glass cover. (See page 10.)
2. Slide ClearVue section down track, away from the retainer.
3. Replace in reverse order.

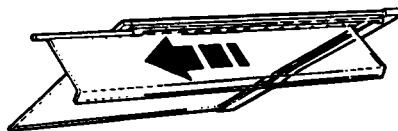



---

## Adjustable freezer shelves

**To remove:**

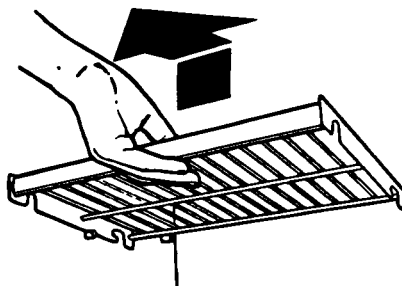
1. Lift shelf up.
2. Pull shelf straight out.
3. Replace in reverse order.



---

## Pull-out freezer baskets

**To remove:**

1. Pull basket out to the stop.
2. Lift basket slightly and move it to the left.
3. Pull basket out the rest of the way.

**To replace:**

1. Place basket in shelf tracks and move basket to the left.
2. Push basket in to the stop on the left side.
3. Lift left side of basket slightly to clear the stop.
4. Push basket in the rest of the way.

**IMPORTANT:** Be sure both sides of basket are in the shelf tracks before filling with food.

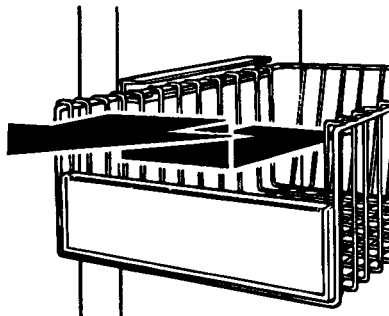

## Automatic ice maker

**IMPORTANT:** The ice maker is shipped from the factory with the signal arm in the OFF position (up). It is recommended that the ice maker be left in the OFF position for the first 24 hours after your refrigerator is turned on. This will allow the freezer compartment and the ice maker to reach the proper temperature before making ice.

### To start ice maker:

- **For dispenser models only:** Pull the ice maker covering panel out from the bottom and slide it to the rear.
- Push the ice maker signal arm down to the ON position.

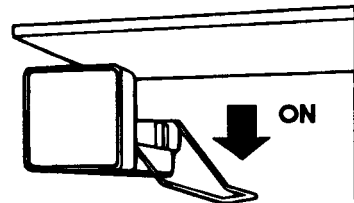

### To stop ice maker:

- Lift the ice maker signal arm until you feel it click into the OFF position.

**IMPORTANT:** The ice maker signal arm must be in the ON position (down) to produce ice. Also, the first few batches of ice from the ice maker may have an off-taste. This is from the new plumbing and parts. Please throw this ice away and allow the ice maker to make a new supply.

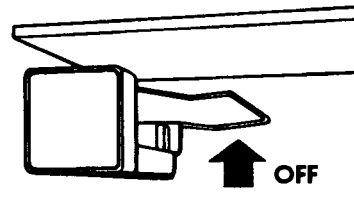

## Ice maker storage bin

**For dispenser models:** Depending on the model, the ice maker storage bin holds the following amounts of ice:

KSSS36D – 8.5 pounds (3.8 kg)

KSSS42D – 13.5 pounds (6.1 kg)

KSSS48D – 17.6 pounds (8.0 kg)

**For non-dispenser models:** The ice maker storage bin holds up to 6.5 pounds (2.9 kg) of ice.

**For all models:** Remove unused ice periodically to reduce the potential for off-taste or odor build-up in ice. The storage bin can be removed for cleaning or to dispense large amounts of ice at one time.

### To remove:

1. **For dispenser models only:** Pull the ice maker covering panel out from the bottom and slide it to the rear.
2. Lift the ice maker signal arm until you feel it click into the OFF position.

**For dispenser models only:** While the ice maker is OFF, no more ice can be produced, but ice can still be dispensed when the freezer door is closed.

3. Lift the front of the storage bin, then pull it out.
4. Empty the storage bin. Use hot or warm water to melt ice if necessary. Never use anything sharp to break up ice in the storage bin. This can damage the storage bin and the dispenser mechanism.

### To replace:

1. Make sure storage bin is pushed in all the way.
2. Push the ice maker signal arm down to the ON position to restart ice production.
3. **For dispenser models only:** Lower the ice maker covering panel.

### Dispenser models:

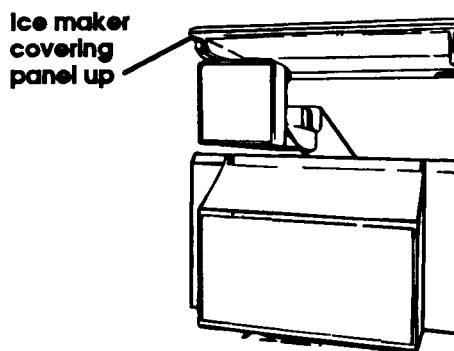
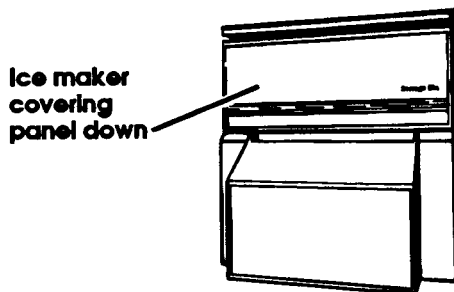

### Non-dispenser models:

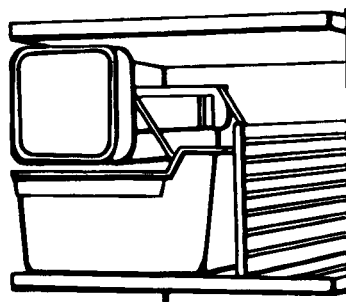

## Cold water and ice dispensers (models KSSS36D, KSSS42D and KSSS48D)

### **⚠ WARNING**

#### **Personal Injury Hazard**

Tumbling ice and pressure on a fragile glass can break it. Do not use a fragile glass when dispensing ice or water.

Failure to follow the above precaution could result in personal injury or property breakage.

### The ice dispenser

Ice is dispensed from the ice maker storage bin in the freezer. When the dispenser bar is pressed, a trapdoor opens in the chute between the dispenser and the ice bin. Ice is moved from the bin and falls through the chute. When the dispenser bar is released, a buzzing sound may be heard for a few seconds.

#### **To dispense ice:**

1. Press a **sturdy** glass against the ice dispenser bar.
2. Remove the glass to stop dispensing.



### The water dispenser

**IMPORTANT:** If the water dispenser stops working, it may be due to freezing of the water line leading to the dispenser. If this happens, turn the WinterChill Meat Locker Temperature Control toward cold.

Chilled water comes from a 50 oz. (1.5 L) tank behind the crisper/utility drawer. Allow about 24 hours to chill the first or a new tankful.

When the refrigerator is first hooked up, press the water dispenser bar with a glass or jar until you have drawn and discarded 2-3 quarts (1.9 to 2.9 L) of water. This will remove the air in the system and rinse the tank and pipes.

If the dispenser is not used regularly, dispense enough water every week to freshen the supply. Allow 2-3 hours for the new supply of water to chill.

**IMPORTANT:** The small tray under the dispenser is designed to evaporate small spills. There is no drain in this tray. Do not pour water into it or leave large amounts of ice to melt in it.

To dispense water:

1. Press a sturdy glass against the water dispenser bar.
2. Remove the glass to stop dispensing.



### The dispenser light

The dispenser light automatically turns on when you press either of the dispenser bars. It will stay on as long as the arm is pressed. The light can be turned on and used as a night light by pressing the button located behind the dispenser panel in the upper, left corner. To turn off the light, press the button again.

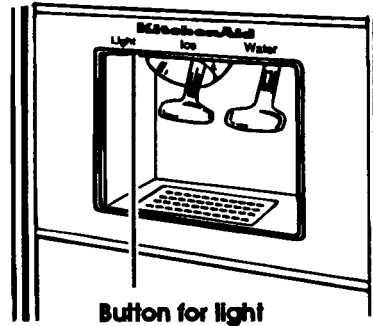

## Dispenser/ice maker operating tips

PROBLEM	CAUSE	SOLUTION
Dispensers won't work	<ul style="list-style-type: none"> <li>• Freezer door open</li> <li>• Frozen water line</li> </ul>	<ul style="list-style-type: none"> <li>• Close the freezer door.</li> <li>• Turn the WinterChill™ Meat Locker Temperature Control toward cold.</li> </ul>
Ice dispenser won't work	<ul style="list-style-type: none"> <li>• Ice bin not properly installed</li> <li>• Wrong ice in bin</li> <li>• Dispenser not used for extended periods of time, causing ice cubes to melt together</li> </ul>	<ul style="list-style-type: none"> <li>• Make sure ice bin is pushed in all the way.</li> <li>• Use only crescents from ice maker. Shake ice bin occasionally to keep cubes separated and to obtain increased storage capacity.</li> <li>• Dump old ice and make a new supply.</li> </ul>

continued on next page

PROBLEM	CAUSE	SOLUTION
Ice dispenser stops working	<ul style="list-style-type: none"> <li>• Ice dispenser bar held in too long</li> </ul>	<ul style="list-style-type: none"> <li>• Wait about 3 minutes for the dispenser motor to reset.</li> <li>• Large amounts of ice should be taken from the bin, not through the dispenser.</li> </ul>
Off-taste or odor in ice	<ul style="list-style-type: none"> <li>• Ice attracts airborne odors; old ice</li> <li>• Water quality</li> <li>• Foods not properly wrapped</li> <li>• Ice bin and freezer may need cleaning</li> <li>• Plumbing to ice maker</li> <li>• New ice maker</li> </ul>	<ul style="list-style-type: none"> <li>• Dump old ice and make a new supply; store excess ice in a covered container.</li> <li>• Water containing minerals (such as sulfur) may require a filter to remove.</li> <li>• For best results, avoid connecting ice maker to a softened water supply. If softened water supply cannot be avoided, make sure the water softener is well maintained and operating properly.</li> <li>• Wrap foods properly in air and moisture proof materials.</li> <li>• Clean freezer and ice bin. See "Cleaning the refrigerator" on page 20 for instructions.</li> <li>• Follow installation instructions for proper ice maker water supply hook up.</li> <li>• The first few batches of ice from a new ice maker may have an off-taste. Dump this ice and make a new supply.</li> </ul>

## Base grille

### To remove:

1. Remove one screw at each end of the base grille.
2. Remove base grille.
3. Replace in reverse order.

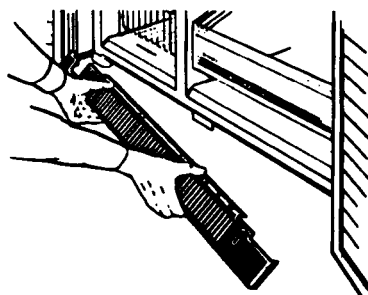



## Defrost pan

### ⚠ WARNING

#### Personal Injury And Floor Damage Hazard

- Refrigeration system tubes are located above the defrost pan and can become hot. Remove and reinstall the defrost pan carefully.
  - Replace defrost pan in the proper position after cleaning so water does not collect on the floor.
- Failure to follow the above precautions could result in personal injury or floor damage.

The defrost pan is located behind the base grille, toward the left side of the refrigerator.

#### To remove:

1. Press power on/off switch to the OFF position. (See page 6 for instructions.)
2. Remove base grille.
3. Locate retaining clip (A) under refrigerator.
4. Push up on the clip and, at the same time, slide the pan forward and out.
5. Clean the pan. (See page 20 for instructions.)

#### To replace:

1. Position the edge of the defrost pan approximately 7 inches (17.8 cm) from the left side of the refrigerator.
2. Lift defrost pan into side guides and push back until you hear the "click" or "snap" of the retaining clip moving into place.
3. Replace the base grille.
4. Press power on/off switch to the ON position.

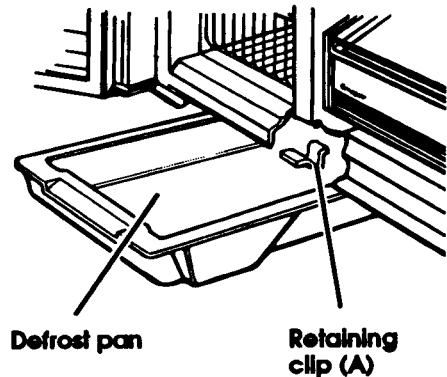

## Changing the light bulbs

### **⚠ WARNING**

#### **Electrical Shock Hazard**

Before removing a light bulb, press the power on/off switch to the OFF position to disconnect the refrigerator from the power supply.

Failure to do so could result in electrical shock or personal injury.

#### **Light bulbs behind Refrigerator and Freezer Controls:**

1. Reach behind control panel.
2. Unscrew bulb and replace it with a 25-watt, incandescent, medium-base, tubular bulb.

#### **Light bulb below ice storage bin: (Non-dispenser models)**

1. Remove light cover.
2. Unscrew bulb and replace it with a 25-watt, incandescent, medium-base, tubular bulb.
3. Replace light cover.

#### **Light bulb below ice storage bin: (Dispenser models)**

1. Grasp plastic light cover with both hands and squeeze (front to back) to release tabs.
2. Pull down and away from the ice storage bin.
3. Unscrew bulb and replace it with a 25-watt, incandescent, medium-base, tubular bulb.
4. Replace light cover.

#### **Light bulb in dispenser area: (Dispenser models)**

1. Unscrew the bulb from the top, inside of the dispenser area.
2. Replace bulb with a heavy-duty, 10-watt bulb.

**IMPORTANT:** Be sure to press power on/off switch to the ON position after changing light bulb(s).

## To save energy

- Open the doors as few times as possible. Keep food organized so you do not have to search for what you want. Get everything you need out at one time. Close the door as soon as food is removed.
- Fill the refrigerator, but do not overcrowd it so that air movement is blocked.
- Set the refrigerator and freezer compartment temperatures to suit your needs—ice cream should be firm and beverages should be as cold as you like them. Avoid setting the refrigerator and freezer compartment temperatures colder than is necessary.
- Keep the condenser coils clean. See "Cleaning the refrigerator" on page 20 for instructions.

## Sounds you may hear

Your new refrigerator may make different sounds than your old one. Hard surfaces, such as the ceiling, walls and cabinets around the refrigerator, can make sounds seem louder.

The following chart describes the kinds of sounds that might be new to you and what causes them.

SOUNDS/OBSERVATIONS	CAUSES
<b>Hum or hiss</b>	The refrigerator's fan motor and moving air.
<b>Clicking or snapping sounds</b>	The thermostat makes a definite click when the refrigerator stops running. It also makes a sound when the refrigerator starts. The defrost timer will click when the defrost cycle starts and stops.
<b>Ice maker sounds</b> • trickling water • clatter of ice	You may hear buzzing (from the water valve), trickling water and the clatter if ice falling into the bin.
<b>Running sounds</b>	The high-efficiency compressor and motor will run longer than older designs. The internal fan may occasionally run when the compressor is off.
<b>Trickling water/water sounds</b>	During the defrost cycle, the refrigerator will not be running. The trickling water is the frost accumulated on the freezer coil melting and running into the defrost pan. When the refrigerator stops running, you will hear gurgling in the tubing for a few minutes.
<b>Warm air from upper ventilation panel/base grille</b>	You may feel air blowing from behind the upper ventilation panel and base grille when the refrigerator is running. This is normal.

# Caring For The Refrigerator

<b>In This Section</b>	<b>Page</b>	<b>Page</b>
Cleaning the refrigerator .....	20	Vacation and moving care .....
		21

Your new refrigerator is designed to give you many years of dependable service. However, there are a few things you are expected to do to maintain your refrigerator properly. This section will tell you how to clean your refrigerator and how to care for it when you are going on vacation or moving.

## Cleaning the refrigerator

The refrigerator and freezer compartments defrost automatically. However, both should be cleaned once a month to help prevent odors from building up. Spills should be wiped up immediately.

Before cleaning, disconnect the refrigerator from its power supply by pressing the power on/off switch to the OFF position. Then, take out all removable parts and clean the refrigerator according to the directions given below. Be sure to press the power on/off switch to the ON position when you are finished cleaning.

**⚠ WARNING**

**Personal Injury Hazard**

Refrigeration system tubes are located above the defrost pan and can become hot. Remove and reinstall the defrost pan carefully.

Failure to do so could result in personal injury.

PART	WHAT TO USE	HOW TO CLEAN
Front door panels		<ul style="list-style-type: none"> <li>• Clean as you would your kitchen cabinets.</li> </ul>
Condenser coils	<ul style="list-style-type: none"> <li>• Vacuum cleaner with extended narrow attachment</li> </ul>	<ul style="list-style-type: none"> <li>• Remove upper ventilation panel to expose condenser coils. (See page 5.)</li> <li>• Vacuum coils periodically.</li> <li>• Replace upper ventilation panel.</li> </ul>
Base grille	<ul style="list-style-type: none"> <li>• Vacuum cleaner with brush attachment</li> </ul>	<ul style="list-style-type: none"> <li>• Vacuum base grille.</li> </ul>
Defrost pan	<ul style="list-style-type: none"> <li>• Sponge or cloth</li> <li>• Mild detergent</li> <li>• Warm water</li> </ul>	<ul style="list-style-type: none"> <li>• Press power on/off switch to the OFF position. (See page 6.)</li> <li>• Remove the base grille. (See page 16.)</li> <li>• Remove the defrost pan. (See page 17.)</li> <li>• Wash, rinse and dry thoroughly.</li> <li>• Replace defrost pan.</li> <li>• Replace base grille.</li> <li>• Press power on/off switch to the ON position.</li> </ul>

continued on next page

PART	WHAT TO USE	HOW TO CLEAN
Interior walls	<ul style="list-style-type: none"> <li>• Sponge, soft cloth or paper towel</li> <li>• Mild detergent</li> <li>• Warm water</li> </ul>	<ul style="list-style-type: none"> <li>• Wash, rinse and dry thoroughly.</li> </ul>
Door liners and gaskets	<ul style="list-style-type: none"> <li>• Sponge, soft cloth or paper towel</li> <li>• Mild detergent</li> <li>• Warm water</li> </ul>	<ul style="list-style-type: none"> <li>• Wash, rinse and dry thoroughly.</li> <li>• Do not use cleaning waxes, concentrated detergents, bleaches, or cleaners containing petroleum or alcohol on plastic parts.</li> </ul>
Removable parts (shelves, meat locker, meat locker air connector, crisper, utility drawer, etc.)	<ul style="list-style-type: none"> <li>• Sponge or cloth</li> <li>• Mild detergent</li> <li>• Warm water</li> </ul>	<ul style="list-style-type: none"> <li>• Wash, rinse and dry thoroughly.</li> </ul>

## Vacation and moving care

### Short vacations

If you will be away for less than four weeks, there is no need to shut off the refrigerator. Use up perishables and freeze other items. Turn off the automatic ice maker by lifting the signal arm to the OFF position. Turn off the water supply to the ice maker and empty the ice bin.

### Long vacations

If you will be away for a month or more:

1. Remove all food from the refrigerator.
2. Turn off the water supply to the ice maker at least one day before you leave.
3. When the last load of ice drops, turn ice maker off by lifting the signal arm to the OFF position.
4. Turn the Freezer Control to the Off setting.
5. Press the power on/off switch to the OFF position.
6. Clean the refrigerator completely. Rinse it well and dry it thoroughly.
7. Tape rubber or wood blocks to the tops of both doors, keeping them open far enough for air to get in. This will keep odor and mold from building up.

### WARNING

#### Personal Injury Hazard

Do not allow children to climb on, play near or crawl inside the refrigerator when the doors are blocked open.

Failure to follow the above precaution could result in the children becoming injured or trapped.

When you return, press the power on/off switch to the ON position to restart the refrigerator and turn the Freezer Control to a desired setting. (See "Temperature controls" on page 6.)

### Moving

If the refrigerator must be moved, contact the dealer from whom you purchased the unit or your local KitchenAid authorized servicer.

# Food Storage Guide

In This Section	Page	Page	
Storing fresh food .....	22	Storing frozen food .....	23

This section gives you helpful information on how to store all types of food and for how long. For more information, see a reliable cookbook or a freezer guide.

## Storing fresh food

### Vegetables

#### Leafy:

Remove store wrapping. Tear off bruised and discolored areas. Wash in cool water, drain. Place in plastic bag or container and store in crisper.

#### With skins:

Place in plastic bags or containers and store in crisper.

### Fruit

#### Berries:

Sort to remove injured berries. Do not wash berries until they are to be served. Store in original container in crisper.

#### Other:

Sort to remove injured fruit before storing. Wash fruit, let dry, place in perforated plastic bag or loosely covered in plastic container and store in crisper.

### Eggs

Store in original carton. For best storage, place on interior shelf or in wine/egg rack.

### Dairy products

#### Milk:

Store in original container on refrigerator shelf.

#### Butter or margarine:

Store in the utility compartment or on refrigerator shelf until opened. When opened, store in covered dish or on butter dish in the utility compartment.

#### Cheese:

Store in original packaging until opened. When opened, tightly rewrap in plastic wrap or aluminum foil and store in utility compartment or on refrigerator shelf.

### Leftovers

Cover with plastic wrap or aluminum foil, or place in plastic containers with tight fitting lids.

### Condiments

Store small jars and bottles in door bins.

### Beverages

Wipe off bottles and cans. Store in door bins or on refrigerator shelf.

### Meat

#### Cured or smoked meat and cold cuts:

Store in original packaging until opened. When opened, tightly rewrap using plastic wrap or aluminum foil.

#### Fresh, prepackaged meat and poultry:

Store in original packaging.

#### Fresh, not prepackaged:

Remove market wrapping paper. Rewrap in plastic wrap.

#### Cooked meat and poultry:

Wrap or cover with plastic wrap or aluminum foil. Store immediately.

#### Fresh fish and shellfish:

Store in plastic bag or tightly covered container.

**Storage chart for meats\***

TYPE	APPROXIMATE TIME (DAYS)
Chicken	1 to 2
Ground beef	1 to 2
Variety meats	1 to 2
Steaks and roasts	3 to 5
Cold cuts	3 to 5
Bacon	5 to 7
Cured meat	7 to 10

\*If meat is to be stored longer than the time given, freezing is recommended.

**IMPORTANT:** Fresh fish and shellfish should be used the same day as purchased.

## Storing frozen food

### Prepackaged frozen food

Store in original packaging on freezer door shelf or on freezer shelf.

### Meat/poultry

Trim off excess fat and remove bones when necessary. Meat/poultry should not be salted. Wrap tightly in heavy-duty aluminum foil, plastic-coated paper or non-permeable plastic wraps (made out of a saran film). Press out as much air as possible. Label and date the meat/poultry. Do not refreeze thawed meat.

### Ice cream

Store in original packaging. When opened, place a piece of aluminum foil or waxed paper against ice cream surface to prevent the formation of ice crystals.

### Frozen juices

Store in original container on freezer door shelf or on freezer shelf.

**Storage chart for frozen food\***

TYPE	APPROXIMATE TIME (MONTHS)
Bread	2
Cooked dishes	2 to 3
Fresh fish/seafood	6
Frozen fish/seafood	1 to 3
Fruit	6
Ice cream	1
Concentrated juice	4 to 6
Bacon	less than 1
Pork roast/chops	3 to 4
Sausage	1 to 2
Beef/veal/lamb roasts	6
Ground meat	1 to 2
Poultry	3 to 4
Vegetables	6

\*Storage times given in this chart are only a guide. For best use of freezer space, keep frozen food for short times. Use, then replace as needed.

Courtesy of National Livestock & Meat Board and U.S.D.A.

# If You Need Assistance Or Service

If you ever have questions or comments about your appliance, you can call our toll-free Consumer Assistance Center telephone number, 1-800-422-1230, 24 hours a day in the U.S.

This section is designed to help you save the cost of a service call. First we outline possible problems, their causes and their solutions. However, you may still need assistance or service. When calling our Consumer Assistance Center (U.S. only) or your authorized servicer (in Canada) for help or when calling for service, you will need to provide a complete description of the problem, your appliance's complete model and serial numbers and the purchase or installation date. (See page 2.) This information is needed to respond to your request properly.

## Before calling for service ...

If your appliance should fail to operate, review the following list before calling your dealer. You could save the cost of a service call.

PROBLEM	CHECK IF	WHAT TO DO
The refrigerator will not operate	The power on/off switch is in the OFF position. A household fuse is blown or circuit breaker is tripped. The Freezer Control is set to OFF.	Press the power on/off switch to the ON position. Replace the fuse or reset the circuit breaker. Set the Freezer Control to a setting other than OFF.
The refrigerator makes unfamiliar sounds		New features on your refrigerator make new sounds. See "Sounds you may hear" on page 19 for more information.
The lights are not working	The power on/off switch is in the OFF position. A household fuse is blown or circuit breaker is tripped. A bulb is burned out.	Press the power on/off switch to the ON position. Replace the fuse or reset the circuit breaker. See "Changing the light bulbs" on page 18 for instructions.
Your ice maker will not operate	The freezer compartment is not cold enough to make ice. The ice maker signal arm is in the OFF position (up). The water valve is not turned on. Water is not getting to the ice maker.	Allow the refrigerator to reach the proper temperature. This could take 24 hours. Move the signal arm to the ON position (down). (See page 12.) Turn on the water line valve. Check water line for leaks or clogs.
The motor seems to run too long		The motor naturally runs longer on hot days or if the room is warm. It will also run longer when a large amount of food has been added or the doors have been opened often.



---

## For service in the U.S.

### 1. If the problem is not due to one of the items on page 24:

- Call KitchenAid Consumer Assistance Center TOLL-FREE:

**1-800-422-1230**

and talk with one of our trained consultants. The consultant can instruct you in how to obtain satisfactory operation from your appliance or, if service is necessary, recommend a qualified service company in your area.

- If you prefer, write to:  
Consumer Assistance Center  
KitchenAid  
P.O. Box 558  
St. Joseph, MI 49085-0558  
Please include a daytime phone number in your correspondence.

### 2. If you need service:

- Call your dealer or the repair service he recommends.
- All service should be handled locally by the dealer from whom you purchased the unit or an authorized KitchenAid servicer.
- If you are unable to obtain the name of a local authorized KitchenAid servicer, call our Consumer Assistance Center telephone number (see Step 1).

### 3. If you are not satisfied with the action taken:

- Contact the Major Appliance Consumer Action Panel (MACAP). MACAP is a group of consumer experts that voices consumer views at the highest levels of the major appliance industry.
- Contact MACAP only when the dealer, authorized servicer, and KitchenAid have failed to resolve your problem.  
Major Appliance Consumer Action Panel  
20 North Wacker Drive  
Chicago, IL 60606
- MACAP will in turn inform us of your action.

---

## For service in Canada

### 1. If the problem is not due to one of the items on page 24 and you need service:

- Call your dealer or the repair service he recommends.
- In the event you are unable to obtain the name of a local authorized KitchenAid service outlet, look in the yellow pages of all metro area telephone directories under "Dishwashing Machines" for authorized KitchenAid servicing outlets.
- All service should be handled locally by the dealer from whom you purchased the refrigerator or by an authorized KitchenAid service outlet.

### 2. If you must call or write:

- Please provide your complete model number, serial number, date of purchase and a complete description of the problem. Write to:  
Consumer Relations Department  
KitchenAid Canada  
1901 Minnesota Court  
Mississauga, Ontario  
L5N 3A7  
Telephone: (416) 821-6606  
Please include a daytime phone number in your correspondence.

# KitchenAid<sup>®</sup>

## Built-in Refrigerator Warranty

LENGTH OF WARRANTY:	KITCHENAID WILL PAY FOR:	KITCHENAID WILL NOT PAY FOR:
<b>ONE YEAR FULL WARRANTY FROM DATE OF INSTALLATION</b>	Replacement parts and repair labor costs to correct defects in materials or workmanship. Service must be provided by an authorized KitchenAid servicing outlet.	<b>A. Service calls to:</b> <ol style="list-style-type: none"> <li>1. Correct the installation of the refrigerator.</li> <li>2. Instruct you how to use the refrigerator.</li> <li>3. Replace house fuses or correct house wiring.</li> <li>4. Replace house plumbing.</li> </ol>
<b>SECOND THROUGH FIFTH YEAR FULL WARRANTY FROM DATE OF INSTALLATION</b>	Replacement parts and repair labor costs to correct defects in materials or workmanship in the automatic ice maker. Service must be provided by an authorized KitchenAid servicing outlet. Replacement parts and repair labor costs to correct defects in materials or workmanship in the sealed refrigeration system. These parts are: 1. Compressor; 2. Evaporator; 3. Condenser; 4. Drier; 5. Connecting tubing. Service must be provided by an authorized KitchenAid servicing outlet.	<b>B. Repairs when refrigerator is used in other than normal home use.</b> <b>C. Damage resulting from accident, alteration, misuse, abuse, improper installation or installation not in accordance with local electrical codes or plumbing codes.</b> <b>D. Any food loss due to product failure.</b> <b>E. Any labor costs during the limited warranty.</b> <b>F. Replace parts or repair labor costs for units operated outside the United States.</b>
<b>SIXTH THROUGH TENTH YEAR LIMITED WARRANTY FROM DATE OF INSTALLATION</b>	Replacement parts to correct defects in materials or workmanship in the sealed refrigeration system. These parts are: 1. Compressor; 2. Evaporator; 3. Condenser; 4. Drier; 5. Connecting tubing.	<b>G. Repairs to parts or systems caused by unauthorized modifications made to the appliance.</b>

**KITCHENAID AND KITCHENAID CANADA DO NOT ASSUME ANY RESPONSIBILITY FOR INCIDENTAL OR CONSEQUENTIAL DAMAGES.** Some states or provinces do not allow the exclusion or limitation of incidental or consequential damages, so this exclusion may not apply to you.

This warranty gives you specific legal rights and you may also have other rights which may vary from state to state or province to province.

If you need service, first see the "Assistance or Service" section of this book. After checking "Assistance or Service," additional help can be found by calling our Consumer Assistance Center telephone number, 1-800-422-1230, from anywhere in the U.S. For service in Canada, see "For service in Canada" on page 25.

KitchenAid  
St. Joseph, Michigan, U.S.A. 49085

KitchenAid Canada  
Mississauga, Ontario L5N 3A7



Printed on recycled paper

® Registered Trademark of KitchenAid, KitchenAid Canada, Licensee in Canada.  
 TM Trademark of KitchenAid, KitchenAid Canada, Licensee in Canada.

## Free Manuals Download Website

<http://myh66.com>

<http://usermanuals.us>

<http://www.somanuals.com>

<http://www.4manuals.cc>

<http://www.manual-lib.com>

<http://www.404manual.com>

<http://www.luxmanual.com>

<http://aubethermostatmanual.com>

Golf course search by state

<http://golfingnear.com>

Email search by domain

<http://emailbydomain.com>

Auto manuals search

<http://auto.somanuals.com>

TV manuals search

<http://tv.somanuals.com>