

lenovo

Lenovo
G400/G500
G405/G505
G410/G510
User Guide



Read the safety notices and important tips in the included manuals before using your computer.

Notes

- Before using the product, be sure to read *Lenovo Safety and General Information Guide* first.
- Some instructions in this guide may assume that you are using Windows® 8. If you are using other Windows operating systems, some operations may be slightly different. If you are using other operating systems, some operations may not apply to you.
- The features described in this guide are common to most models. Some features may not be available on your computer and/or your computer may include features that are not described in this user guide.
- The illustrations used in this manual are for Lenovo G400 unless otherwise stated.
- The illustrations in this manual may differ from the actual product. Please refer to the actual product.

Regulatory Notice

- For details, refer to **Guides & Manuals** at <http://support.lenovo.com>.

First Edition (March 2013)

© Copyright Lenovo 2013.

LIMITED AND RESTRICTED RIGHTS NOTICE: If data or software is delivered pursuant a General Services Administration "GSA" contract, use, reproduction, or disclosure is subject to restrictions set forth in Contract No. GS-35F-05925.

Contents

Chapter 1. Getting to know your computer	1
Top view	1
Left-side view	7
Right-side view	10
Front view	11
Bottom view	13
Chapter 2. Starting to use Windows 8	14
Configuring the operating system for the first time	14
Operating system interfaces	14
The charms	15
Putting the computer to sleep or shutting it down	17
Connecting to a wireless network	19
Help and support	20
Chapter 3. Lenovo OneKey Recovery system	21
Chapter 4. Troubleshooting	22
Frequently asked questions	22
Troubleshooting	25
Appendix. CRU instructions	30
Replacing the battery	30
Replacing the hard disk drive	31
Replacing memory	35
Removing the optical drive	38
Trademarks	40

Chapter 1. Getting to know your computer

■ ■ Top view

■ G400/G405/G410

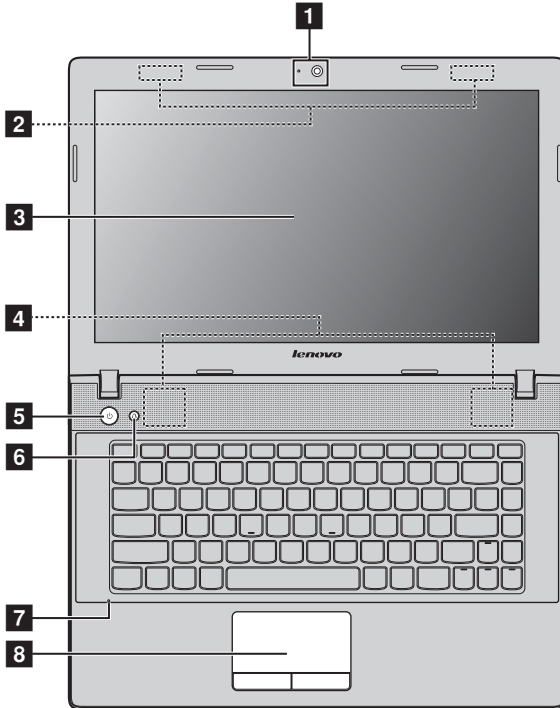

Chapter 1. Getting to know your computer

■ G500/G505/G510

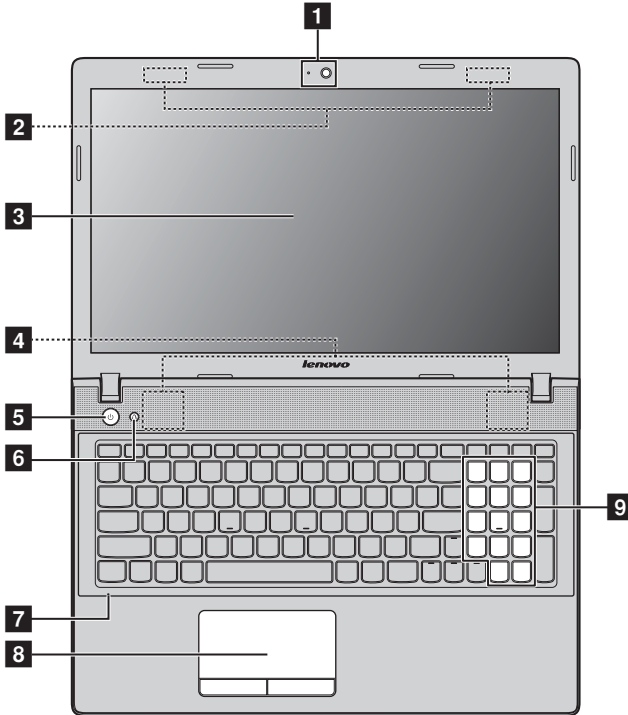

Note: The dashed areas indicate parts that are invisible from outside.

⊙ **Attention:**

- Do *not* open the display panel beyond 130 degrees. When closing the display panel, be careful *not* to leave pens or any other objects in between the display panel and the keyboard. Otherwise, the display panel may be damaged.

Chapter 1. Getting to know your computer

- 1 Integrated camera** Use the camera for video communication.
- 2 Wireless antennas** Connect to the wireless adapter to receive and send wireless radio.
- 3 Computer display** Provides brilliant visual output.
- 4 Speakers** Provide audio output.
- 5 Power button** Press this button to turn on the computer.
- 6 Novo button** When the computer is off or in hibernation mode, press this button to start the Lenovo OneKey Recovery system or the BIOS setup utility, or to enter the boot menu.

Notes:

- For details, see “Chapter 3. Lenovo OneKey Recovery system” on page 21.
- If your computer is preinstalled with a Linpus operating system, Onekey Recovery system is not available.

- 7 Built-in microphone** Captures sound which can be used for video conferencing, voice narration, or audio recording.
- 8 Touchpad** The touchpad functions as a conventional mouse.
Touchpad To move the cursor on the screen, slide your fingertip over the pad in the direction in which you want the cursor to move.
Touchpad buttons The functions of the left/right side correspond to that of the left/right mouse button on a conventional mouse.

Note: You can enable/disable the touchpad by pressing .

- 9 Numeric keypad (G500/G505/G510)** For details, see “Using the keyboard” on page 4

Chapter 1. Getting to know your computer

■ Using the keyboard

Your computer has number keys and function keys and may also have a numeric keypad (G500/G505/G510 only) incorporated into its standard keyboard.

Numeric keypad

G500/G505/G510

The keyboard has a separate numeric keypad. To enable or disable the numeric keypad, press the **Num Lock** key.

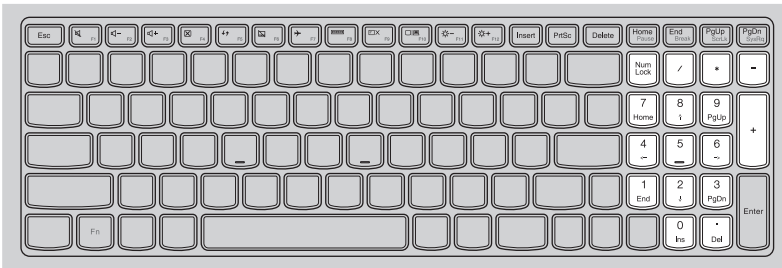



Chapter 1. Getting to know your computer

■ Keyboard function keys

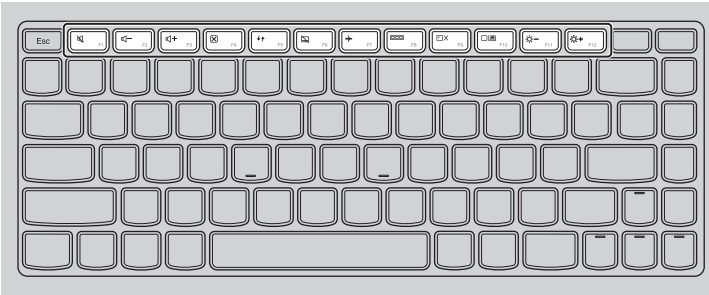
You can access certain system settings quickly by pressing the appropriate function keys.





 : Mutes/unmutes the sound.

 : Enables/disables Airplane mode.

 : Decreases the volume level.

 : Displays all currently active apps.

 : Increases the volume level.

 : Turns on/off the backlight of the LCD screen.

 : Closes the currently active window.

 : Opens the interface for the display device switch to select this notebook or an external display.

 : Refreshes the desktop or the currently active window.

 : Decreases display brightness.

 : Enables/disables the touchpad.

 : Increases display brightness.

Chapter 1. Getting to know your computer

Function key combinations

Through the use of the function keys, you can change operational features instantly. To use this function, press and hold **Fn** **1**; then press one of the function keys **2**.

G400/G405/G410

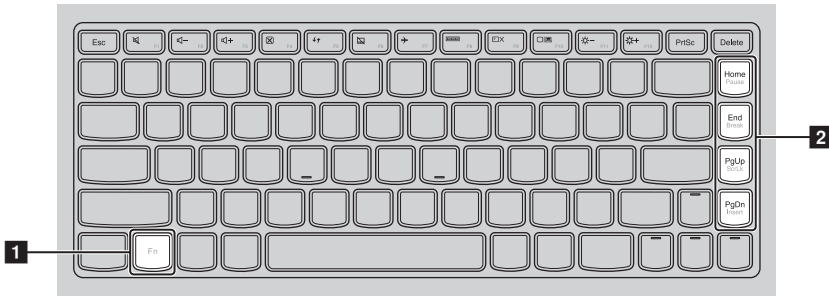

G500/G505/G510

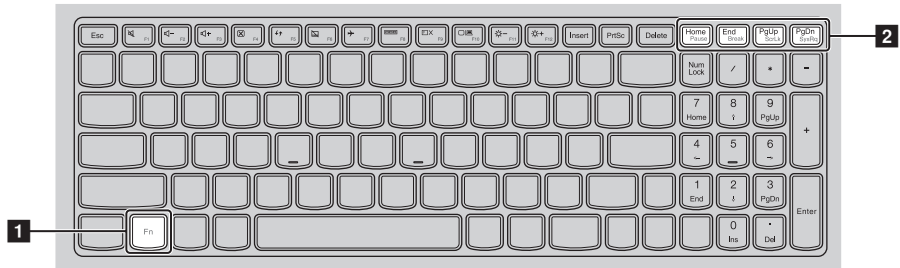

The following describes the features of each function key.

Fn + Home: Activate the pause function.

Fn + End: Activate the break function.

Fn + PgUp: Enable/Disable the scroll lock.

**Fn + PgDn (G400/
G405/G410):** Activate the insert function.

**Fn + PgDn (G500/
G505/G510):** Activate the system request.

■ ■ Left-side view

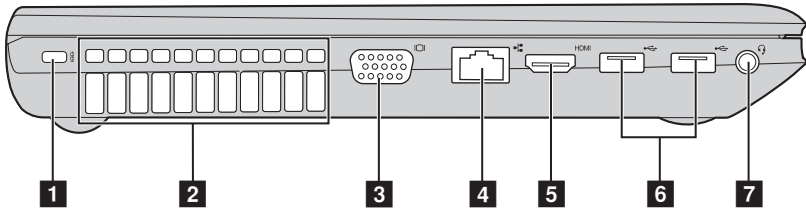

- 1 Kensington slot** Attach a security lock (not supplied) here to help protect your computer from theft and unauthorized use. You can attach a security lock to your computer to help prevent it from being removed without your permission. For details on installing the security lock, please refer to the instructions shipped with the security lock that you have purchased.

- 2 Ventilation slots** Dissipate internal heat.

Note: Make sure that none of the ventilation slots are blocked, or else overheating of the computer may occur.

- 3 VGA port** Connects to external display devices.
- 4 RJ-45 port** Connects the computer to an Ethernet network.
- 5 HDMI port** Connects to devices with HDMI input such as a TV or a display.
- 6 USB ports** Connect to USB devices.

Notes:

- The blue port supports USB 3.0.
- For details, see “Connecting USB devices” on page 8.

- 7 Combo audio jack** Connects to headsets.

Notes:

- By default, the combo audio jack does not support conventional microphones.
- The recording function may not be supported if third-party headphones or headsets are connected, due to different industry standards.

Chapter 1. Getting to know your computer

■ Connecting USB devices

You can connect a USB device to your computer by inserting its USB plug (Type A) into the USB port on your computer.

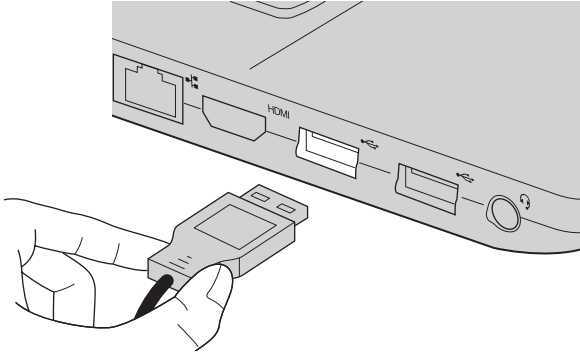

The first time you plug a USB device into a particular USB port on your computer, Windows automatically installs a driver for that device. After the driver is installed, you can disconnect and reconnect the device without performing any additional steps.

Note: Typically, Windows detects a new device after connecting it, and then installs the driver automatically. However, some devices may require you to install the driver before connecting. Check the documentation provided by the device's manufacturer before connecting the device.

Before disconnecting a USB storage device, make sure your computer has finished transferring data by that device. Click the **Safely Remove Hardware and Eject Media** icon in the notification area of the Windows desktop screen to remove the device before disconnecting.

Notes:

- If your USB device uses a power cord, connect the device to a power source before connecting it. Otherwise, the device may not be recognized.
- When in sleep mode, you can only use keyboard instead of mouse to wake up the computer.

Chapter 1. Getting to know your computer

■ Connecting a *Bluetooth* device

If your computer has an integrated *Bluetooth* adapter card, it can connect to and transfer data wirelessly to/from other *Bluetooth* enabled devices, such as notebook computers, PDAs and cell phones. You can transfer data between these devices up to 10 meters range in open space.

Note: The actual maximum range may vary due to interference and transmission barriers. For best transfer speed, place the device as near your computer as possible.

Enabling *Bluetooth* and WLAN communications on your computer

Press  to make configuration.

Notes:

- When you do not need to use the *Bluetooth* function, turn it off to save battery power.
- You need to pair the *Bluetooth* enabled device with your computer before you can transfer data between them. Read the documentation supplied with the *Bluetooth* enabled device for details on how to pair the device with your computer.

Chapter 1. Getting to know your computer

■ ■ Right-side view

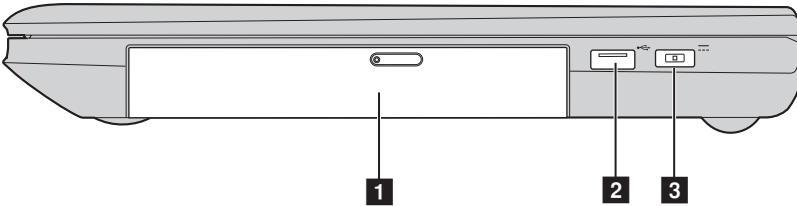

- 1 Optical disc drive** Reads/Burns optical discs.

Note: Some models are supplied with a dummy optical disc drive.

- 2 USB port** Connects to USB devices.



Note: For details, see “Connecting USB devices” on page 8.

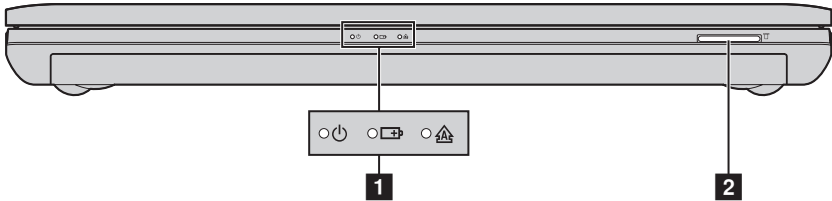

- 3 AC power adapter jack** Connects the AC adapter.

■ ■ Front view



1 System status indicators

- Power indicator 
- Battery status indicator 
- Caps lock indicator 

Symbol	Indicator status	Meaning
	On (solid white)	The computer is powered on.
	Blinking	The computer is in sleep mode.
	Off	The computer is powered off.
	On (solid white)	The battery has more than 20% charge.
	Solid amber	The battery has between 5% and 20% charge.
	Fast blinking amber	There is a problem with the battery or the battery connection.
	Slow blinking amber	The battery is being charged. When battery charge reaches 20%, the blinking color changes to white.
	Slow blinking white	The battery has between 20% and 80% charge and is still charging. When the battery reaches 80% charge, the light will stop blinking, but charging will continue until the battery is fully charged.

2 Memory card slot Insert memory cards (not supplied) here.

Note: For details, see “Using memory cards (not supplied)” on page 12.

Chapter 1. Getting to know your computer

■ Using memory cards (not supplied)

Your computer supports the following types of memory card:

- Secure Digital (SD) card
- MultiMediaCard (MMC)

Notes:

- Insert *only* one card in the slot at a time.
- This card reader does not support SDIO devices (e.g., SDIO *Bluetooth*, etc.).

Inserting a memory card

- ① Push the dummy card in until you hear a click.
- ② Gently pull the dummy card out of the memory card slot.

Note: The dummy card is used for preventing dust and small particles from entering the inside of your computer when the memory card slot is not in use. Retain the dummy card for future use.

- ③ Slide the memory card in until it clicks into place.

Removing a memory card

- ① Push the memory card in until you hear a click.
- ② Gently pull the memory card out of the memory card slot.

Note: Before removing the memory card, disable it through **Safely Remove Hardware and Eject Media** to avoid data corruption.

■ ■ Bottom view

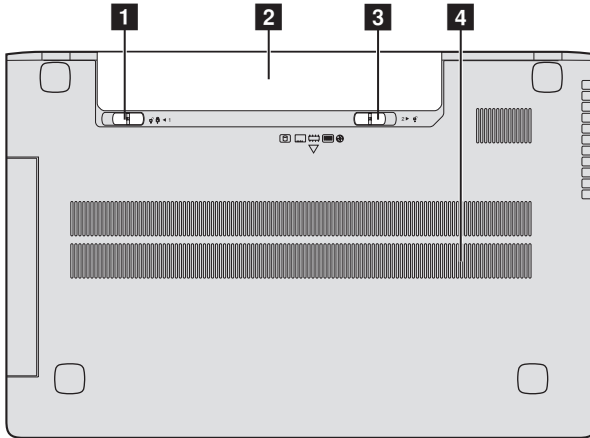

1 Battery latch - manual

The manual battery latch is used to keep the battery pack secured in place.

2 Battery pack

3 Battery latch - spring loaded

The spring-loaded battery latch keeps the battery pack secured in place.

4 Louvers

Allow air to enter the computer for cooling.

Chapter 2. Starting to use Windows 8

■ ■ Configuring the operating system for the first time

You may need to configure the operating system when it is first used. The configuration process may include the procedures below:

- Accepting the end user license agreement
- Configuring the Internet connection
- Registering the operating system
- Creating a user account

■ ■ Operating system interfaces

Windows 8 comes with two main user interfaces: the Start screen and the Windows desktop.

To switch from the Start screen to the Windows desktop, do one of the following:

- Select the Windows desktop tile on the Start screen.
- Press the Windows key  + D.

To switch from the desktop to the Start screen, do one of the following:

- Select **Start**  from the charms bar.
- Move the cursor to the lower-left corner, and then select the Start screen thumbnail when it is displayed.

Start screen

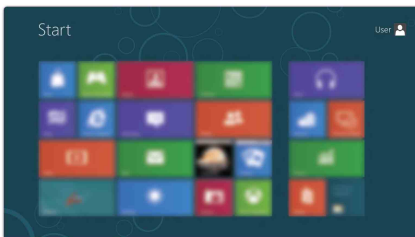

Desktop



■ ■ The charms

Charms are navigation buttons that let you control your Windows® 8 experience. Charms include: Search, Share, Start, Devices, and Settings. The **Charms Bar** is the menu that contains the charms.

The five charms provide new and faster ways to perform many basic tasks, and are always available regardless of whichever app you are currently in. To display the charms, do one of the following:

- Move the cursor to the upper-right or lower-right corner until the charms bar is displayed.
- Press Windows key  + C.

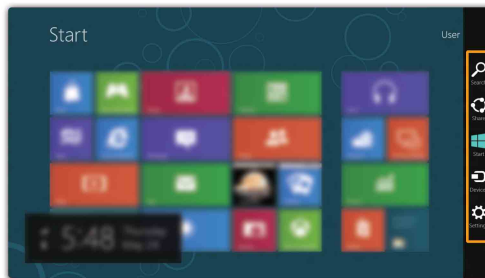

Search charm

The **Search** charm is a powerful new way to find what you are looking for, including apps, settings and files.

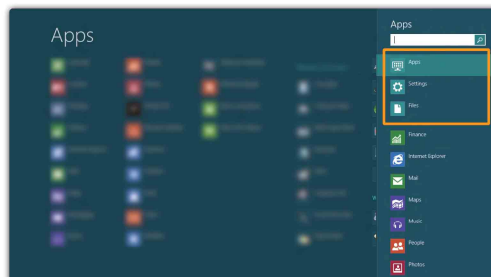

Chapter 2. Starting to use Windows 8

Share charm

The **Share** charm lets you send links, photos, and more to your friends and social networks without leaving the app you are in.

Start charm

The **Start** charm is a fast way to go to the Start screen.

Devices charm

The **Devices** charm allows you to connect or send files to any external devices, including digital cameras, TVs, or printers.

Settings charm

The **Settings** charm lets you perform basic tasks, such as setting the volume or shutting down the computer. Also, you can get to the Control Panel through the **Settings** charm when on the Desktop screen.

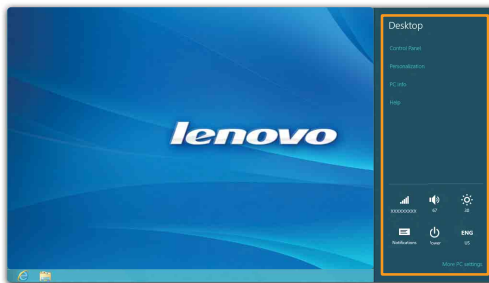

■ ■ Putting the computer to sleep or shutting it down

When you have finished working with your computer, you can put it to sleep or shut it down.

■ Putting your computer to sleep

If you will be away from your computer for only a short time, put the computer to sleep.

When the computer is in sleep mode, you can quickly wake it to resume use, bypassing the startup process.

To put the computer to sleep, do one of the following:

- Close the display panel.
- Press the power button.
- Open the charms, and then select **Settings**  → **Power**  → **Sleep**.

Note: Wait until the power indicator light starts blinking (indicating that the computer is in sleep mode) before you move your computer. Moving your computer while the hard disk is spinning can damage the hard disk, causing loss of data.

To wake the computer, do one of the following:

- Press any key on the keyboard.

Note: If the computer does not awaken after pressing a key on the keyboard, this means that the computer has entered an enhanced power-saving mode.

- Press the power button.

Chapter 2. Starting to use Windows 8

■ Shutting down the computer

If you are not going to use your computer for a long time, shut it down. To shut down your computer:

- 1 Open the charms, select **Settings** .

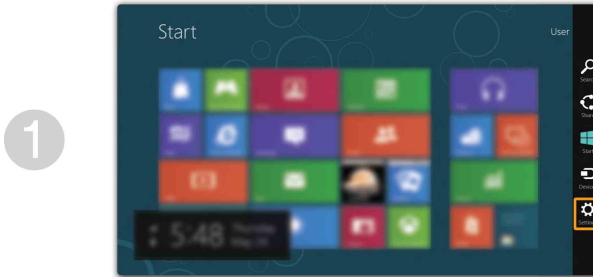

- 2 Select **Power**  → **Shut down**.

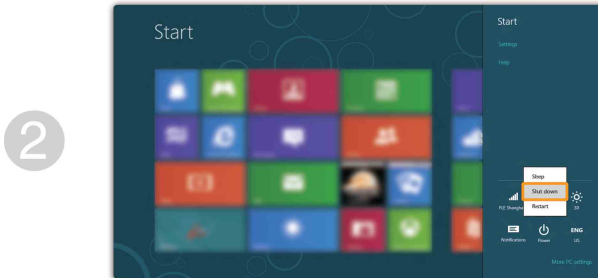

■ ■ Connecting to a wireless network

Enabling wireless connection

To enable wireless functions, do one of the following:

- Press  to disable airplane mode.
- Open the charms and select **Settings**  →  to open the network configuration page. Then toggle the airplane mode switch to **off**.

Connecting to a wireless network

After wireless has been enabled, the computer will automatically scan for available wireless networks and display them in the wireless network list. To connect to a wireless network, click the network name in the list, and then click **Connect**.

Note: Some networks require a network security key or passphrase for connection. To connect to one of those networks, ask the network administrator or the Internet service provider (ISP) for the security key or passphrase.

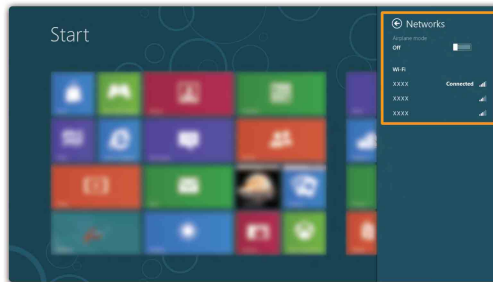

■ ■ Help and support

If you have a problem with the operating system, see the Windows Help and Support file. To open the Windows Help and Support file, do one of the following:

- Select **Settings** charm, then select **Help**.
- Press Windows key  + **Fn + F1**.

You can read the Windows Help and Support file on your computer. You can also get online help and support by clicking on one of the two links listed under **More to explore**.

Chapter 3. Lenovo OneKey Recovery system

The Lenovo OneKey Recovery system is software designed to back up and restore your computer. You can use it to restore the system partition to its original status in case of a system failure. You can also create user backups for easy restoration as required.

Note: To utilize the features of the OneKey Recovery system, your hard disk already includes a hidden partition by default to store the system image file and the OneKey Recovery system program files. This default partition is hidden for security reasons, which explains why the available disk space is less than the stated capacity.

■ Backing up the system partition

You can back up the system partition to an image file. To back up the system partition:

- 1 Press the Novo button to start the Lenovo OneKey Recovery system.
- 2 Click **System Backup**.
- 3 Select a back-up location and click **Next** to start the backup.

Notes:

- You can choose a back-up location on the local hard disk drive or an external storage device.
- The back-up process may take a while.
- The back-up process is only available when Windows can be started normally.

■ Restoring

You can choose to restore the system partition to its original status or to a previously created back-up point. To restore the system partition:

- 1 Press the Novo button to start the Lenovo OneKey Recovery system.
- 2 Click **System Recovery**. The computer will restart to the recovery environment.
- 3 Follow the on-screen instructions to restore the system partition to its original status or to a previously created back-up point.

Notes:

- The recovery process is irreversible. Make sure to back up any data you wish to save on the system partition before starting the recovery process.
- The recovery process may take a while. So be sure to connect the AC adapter to your computer during the recovery process.
- The above instructions should be followed when Windows can be started normally.

If Windows cannot be started, then follow the steps below to start the Lenovo OneKey Recovery system:

- 1 Shut down the computer.
- 2 Press the Novo button. From **Novo Button Menu**, select **System recovery** and press Enter.

Chapter 4. Troubleshooting

■ ■ Frequently asked questions

This section lists frequently asked questions by category.

■ Finding information

What safety precautions should I follow when using my computer?

The *Lenovo Safety and General Information Guide* which came with your computer contains safety precautions for using your computer. Read and follow all the precautions when using your computer.

Where can I find the hardware specifications for my computer?

You can find hardware specification for your computer from the printed flyers which came with your computer.

Where can I find warranty information?

For the warranty applicable to your computer, including the warranty period and type of warranty service, see the Lenovo limited warranty flyer that came with your computer.

■ Drivers and preinstalled software

Where are the installation discs for Lenovo preinstalled software (desktop software)?

Your computer did not come with installation discs for Lenovo preinstalled software. If you need to reinstall preinstalled software, you can find the installation program on the D partition of your hard disk. If you cannot find the installation program there, download it from the Lenovo consumer support Web site.

Where can I find drivers for the various hardware devices of my computer?

If your computer is preinstalled with a Windows operating system, Lenovo provides drivers for the hardware devices that you need on the D partition of your hard disk. You can also download the latest device drivers from the Lenovo consumer support Web site.

■ Lenovo OneKey Recovery system

Where are the recovery discs?

Your computer did not come with recovery discs. Use the Lenovo OneKey Recovery system if you need to restore the system to its factory status.

What can I do if the back-up process fails?

If you can start the backup but it fails during the back-up process, try the following steps:

- ❶ Close all open programs, and then restart the back-up process.
- ❷ Check to see if the destination media is damaged. Select another path and then try again.

When do I need to restore the system to its factory status?

Use this feature when the operating system fails to start up. If there is critical data on the system partition, back it up before starting recovery.

■ BIOS setup utility

What is the BIOS setup utility?

The BIOS setup utility is ROM-based software. It communicates basic computer information and provides options for setting boot devices, security, hardware mode, and other preferences.

How can I start the BIOS setup utility?

To start the BIOS setup utility:

- ❶ Shut down the computer.
- ❷ Press the Novo button and then select **BIOS Setup**.

How can I change the boot mode?

There are two boot modes: **UEFI** and **Legacy Support**. To change the boot mode, start the BIOS setup utility and set boot mode to **UEFI** or **Legacy support** on the boot menu.

Chapter 4. Troubleshooting

When do I need to change the boot mode?

The default boot mode for your computer is **UEFI** mode. If you need to install a legacy operating system, such as Windows (that is, any operating system before Windows 8), Linux or Dos, etc on your computer, you must change the boot mode to **Legacy support**. The legacy operating system, such as Windows, Linux or Dos, etc cannot be installed if you don't change the boot mode.

■ Getting help

How can I contact the customer support center?

See “Chapter 3. Getting help and service” of *Lenovo Safety and General Information Guide*.

●● Troubleshooting

Display problems

When I turn on the computer, nothing appears on the screen.

- If the screen is blank, make sure that:
 - The battery is installed correctly.
 - The AC adapter is connected to the computer, and the power cord is plugged into a working electrical outlet.
 - The computer power is on. (Press the power button again for confirmation.)
- If these items are properly set, and the screen remains blank, have the computer serviced.

When I turn on the computer, only a white cursor appears on a blank screen.

- Restore backed-up files to your Windows environment or the entire contents of your hard disk to its original factory contents using the Lenovo OneKey Recovery system. If you still see only the cursor on the screen, have the computer serviced.

My screen goes blank while the computer is on.

- Your screen saver or power management may be enabled. Do one of the following to exit from the screen saver or to resume from sleep mode:
 - Touch the touchpad.
 - Press any key on the keyboard.
 - Press the power button.
 - Press **F9** () to confirm whether the backlight for the LCD screen has been turned off.

Chapter 4. Troubleshooting

BIOS password problems

I forgot my password.

- If you forget your user password, you must ask the system administrator to reset your user password.
- If you forget your HDD password, a Lenovo authorized servicer cannot reset your password or recover data from the hard disk. You must take your computer to a Lenovo authorized servicer or a marketing representative to have the hard disk drive replaced. Proof of purchase is required, and a fee will be charged for parts and service.
- If you forget your administrator password, a Lenovo authorized servicer cannot reset your password. You must take your computer to a Lenovo authorized servicer or a marketing representative to have the system board replaced. Proof of purchase is required, and a fee will be charged for parts and service.

Sleep problems

The critical low-battery error message appears, and the computer immediately turns off.

- The battery power is getting low. Connect the AC adapter to the computer, or replace the battery with a fully charged one.

The computer enters sleep mode immediately after Power-on self-test (POST).

- Make sure that:
 - The battery is charged.
 - The operating temperature is within the acceptable range. See “Chapter 2. Use and care Information” of *Lenovo Safety and General Information Guide*.



Note: If the battery is charged and the temperature is within range, have the computer serviced.

The computer does not return from sleep mode, and the computer does not work.

- If your computer is in sleep mode, connect the AC adapter to the computer and then press any key or the power button.
- If the system still does not return from sleep mode, stops responding, or cannot be turned off, reset the computer. Unsaved data may be lost. To reset the computer, press and hold the power button for 4 seconds or more. If the computer is still not reset, remove the AC adapter and the battery.

Display panel problems

The screen is blank.

- Do the following:
 - If you are using the AC adapter or the battery and the battery status indicator is on, press **F12** () to make the screen brighter.
 - If the power indicator is blinking, press the power button to resume from sleep mode.
 - If the problem persists, follow the solution in the next problem "The screen is unreadable or distorted."
 - Press **F9** () to confirm whether the backlight for the LCD screen has been turned off.

The screen is unreadable or distorted.

- Make sure that:
 - The display device driver is installed correctly.
 - The screen resolution and color quality are correctly set.
 - The monitor type is correct.

Incorrect characters appear on the screen.

- Are the operating system or programs installed correctly? If they are installed and configured correctly, have the computer serviced.

Chapter 4. Troubleshooting

Sound problems

No sound can be heard from the speaker even when the volume is turned up.

- Make sure that:
 - The Mute function is off.
 - The combo audio jack is not used.
 - The speaker is selected as the playback device.

Battery problems

Your computer shuts down before the battery status indicator shows empty.

-or-

Your computer operates after the battery status indicator shows empty.

The computer does not operate with a fully charged battery.

- Discharge and recharge the battery.
- The surge protector in the battery might be active. Turn off the computer for one minute to reset the protector; then turn on the computer again.

A hard disk drive problem

The hard disk drive does not work.

- Make sure that the hard disk drive is included in the **Boot** menu in the BIOS setup utility correctly.

OneKey Recovery system problems

Backup cannot be made.

- You are not currently using a Windows operating system.
- There is not enough space to store the backed up data. You will need to free more hard disk space on your backup partition.
- The system partition, such as the partition size or the drive capacity has been modified.

Failure to restore the system partition to its factory default.

Other problems

Your computer does not respond.

- To turn off your computer, press and hold the power button for 4 seconds or more. If the computer still does not respond, remove the AC adapter.
- Your computer might lock when it enters sleep mode during a communication operation. Disable the sleep timer when you are working on the network.

The computer does not start from a device you want.

- See the **Boot** menu of the BIOS setup utility. Make sure that the BIOS setup utility is set so that the computer starts from the device you want.
- Also make sure that the device from which the computer starts is enabled. Make sure that the device is included in the **Boot** menu in the BIOS setup utility correctly.
- While turned off, press the Novo button to select the device you want the computer to start from.

The connected external device does not work.

- Do not connect or disconnect any external device cables other than USB while the computer power is on; otherwise, you might damage your computer.
- When using a high power consumption external device such as an external USB optical disk drive, use an external device power adapter. Otherwise, the device may not be recognized, or system shut down may result.

Appendix. CRU instructions

Notes:

- The illustrations used in this appendix are for the Lenovo G400, unless otherwise stated.
- The following steps about upgrading and replacing devices are the same for the G400 and G500/G405/G505/G410/G510.
- Make sure the battery has been removed before replacing any devices.

■ Replacing the battery

Note: Use only the battery provided by Lenovo. Any other battery could ignite or explode.

To replace the battery, do the following:

- ❶ Turn off the computer. Disconnect the AC adapter and all cables from the computer.
- ❷ Close the computer display, and turn the computer over.
- ❸ Unlock the manual battery latch **1**. Hold the spring-loaded battery latch in the unlocked position **2**, remove the battery pack in the direction shown by the arrow **3**.

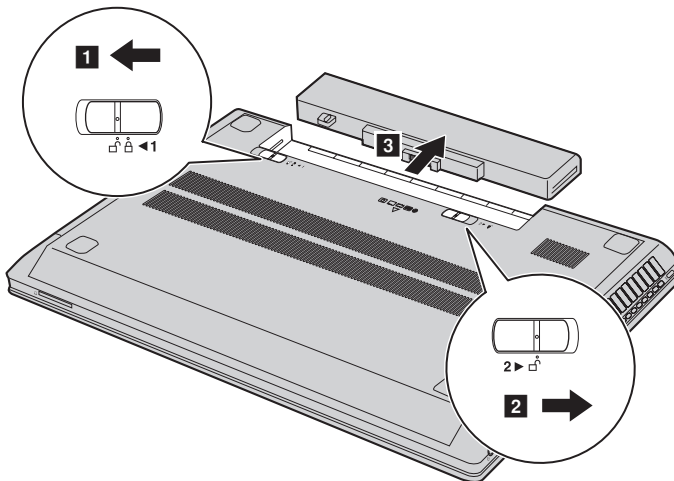

- ❹ Install a fully charged battery.
- ❺ Slide the manual battery latch to the locked position.
- ❻ Turn the computer over again.
- ❼ Connect the AC adapter and the cables to the computer.

■ ■ Replacing the hard disk drive

You can increase the storage capacity of your computer by replacing the hard disk drive with one of greater capacity. You can purchase a new hard disk drive from your reseller or Lenovo marketing representative.

Notes:

- Replace the hard disk drive only if you upgrade it or have it repaired. The connectors and bay of the hard disk drive were not designed for frequent changes, or drive swapping.
- The preinstalled software is not included on an optional hard disk drive.

Handling a hard disk drive

- Do not drop the drive or subject it to physical shocks. Put the drive on a material, such as soft cloth, that absorbs the physical shock.
- Do not apply pressure to the cover of the drive.
- Do not touch the connector.

The hard disk drive is very sensitive. Incorrect handling may cause damage and permanent loss of data on it. Before removing the hard disk drive, make a backup copy of all the information on it, and then turn the computer off. Never remove the drive while the system is operating, in sleep mode.

Appendix. CRU instructions

To replace the hard disk drive, do the following:

- ❶ Turn off the computer, then disconnect the AC adapter and all cables from the computer.
- ❷ Close the computer display, and then turn the computer over.
- ❸ Remove the battery pack.
- ❹ Remove the Hard disk drive/Memory/Central processing unit/Mini PCI Express Card slot compartment cover.
 - a. Loosen the screws that secure the compartment cover ❶.
 - b. Remove the compartment cover ❷.

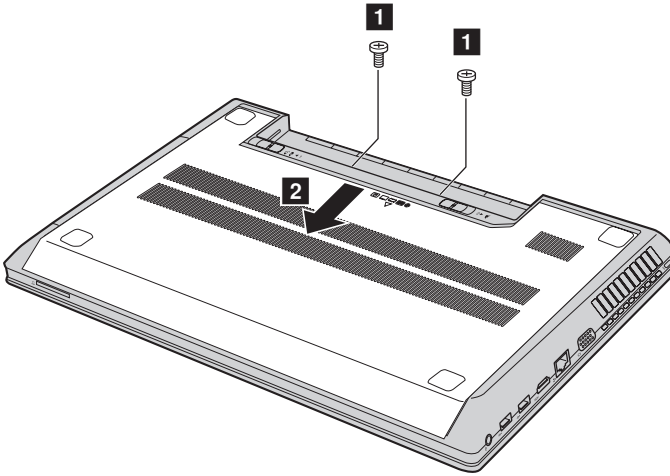

- 5 Remove the frame fixing screws 3.

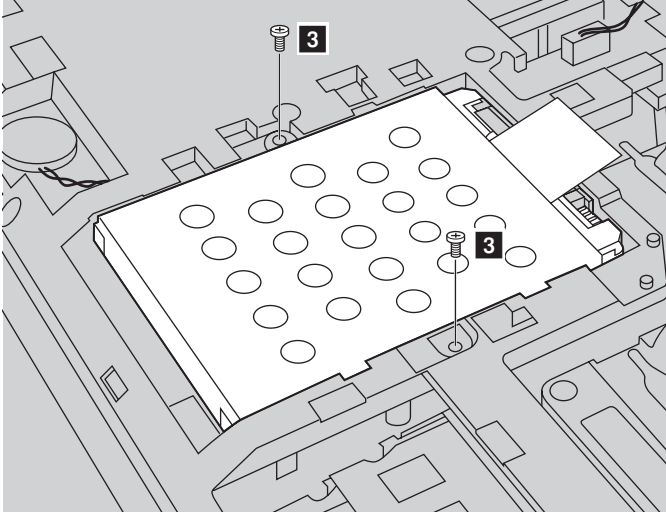

- 6 Pull the tab in the direction shown by arrow 4.

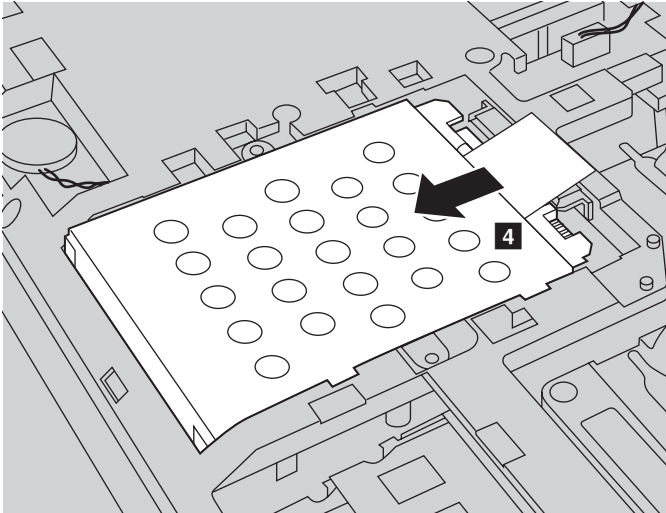

Appendix. CRU instructions

- 7 Take out the hard disk drive secured in a metal frame 5.

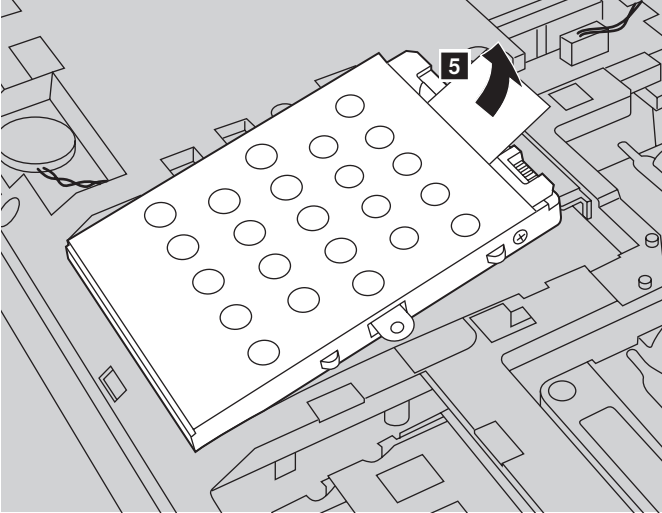

- 8 Remove the screws and detach the metal frame from the hard disk drive.
- 9 Attach the metal frame to a new hard disk drive and tighten the screws.
- 10 Put the hard disk drive gently into the hard disk drive bay with the tab facing upwards and the connectors facing each other, then push it firmly into space.
- 11 Reinstall the frame fixing screw.
- 12 Reinstall the compartment cover and tighten the screws.
- 13 Reinstall the battery pack.
- 14 Turn the computer over again.
- 15 Connect the AC adapter and the cables to the computer.

■ ■ Replacing memory

You can increase the amount of memory in your computer by installing a double-data-rate three low voltage synchronous dynamic random access memory (DDR3L SDRAM)-available as an option-in the memory slot of your computer. DDR3L SDRAMs are available in various capacities.

Note: Use only the memory types supported by your computer. If you incorrectly install optional memory, or install an unsupported memory type, a warning beep will sound when you try to start the computer.

To install a DDR3L SDRAM, do the following:

- ❶ Touch a metal table or a grounded metal object to reduce any static electricity in your body, which could damage the DDR3L SDRAM. Do not touch the contact edge of the DDR3L SDRAM.
- ❷ Turn off the computer. Disconnect the AC adapter and all cables from the computer.
- ❸ Close the computer display, and turn the computer over.
- ❹ Remove the battery again.
- ❺ Remove the Hard disk drive/Memory/Central processing unit/Mini PCI Express Card slot compartment cover.

a. Loosen the screws that secure the compartment cover **❶**.

b. Remove the compartment cover **❷**.

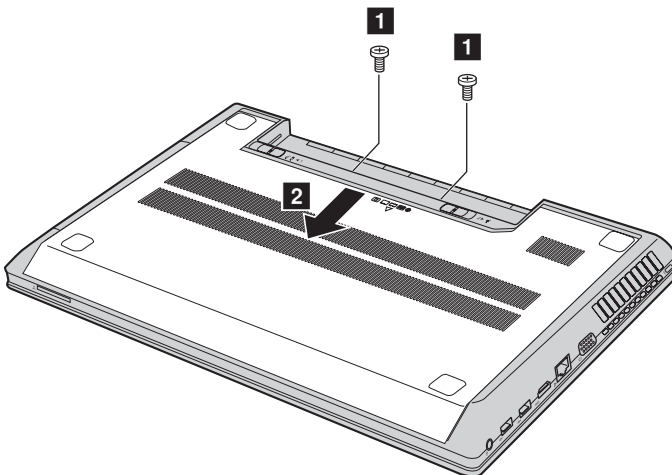

Appendix. CRU instructions

- 6 If two DDR3L SDRAMs are already installed in the memory slot, remove one of them to make room for the new one by pressing out on the latches on both edges of the socket at the same time. Be sure to save the old DDR3L SDRAM for future use.

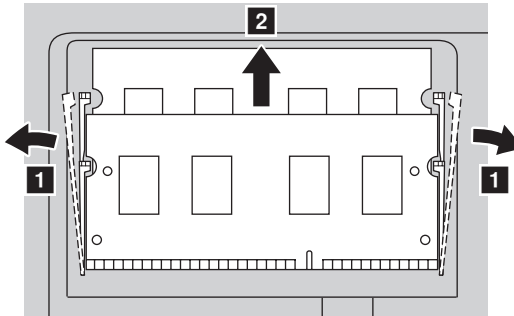

- 7 Align the notch of the DDR3L SDRAM with the protrusion of the socket and gently insert the DDR3L SDRAM into the socket at a 30-45° angle.
- 8 Push the DDR3L SDRAM inward toward the socket until the latches on both edges of the socket are pushed into the closed position.

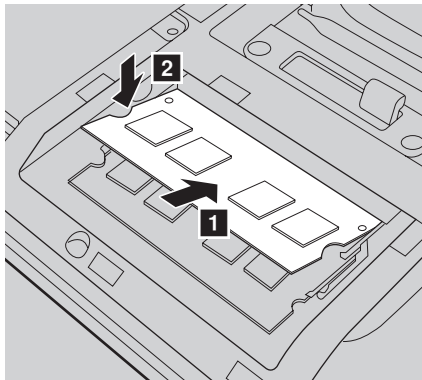

- 9 After aligning the attachment clips with their matching gaps, reinstall the compartment cover.
- 10 Reinstall and tighten the screws.
- 11 Reinstall the battery.
- 12 Turn the computer over again.
- 13 Connect the AC adapter and the cables to the computer.

Appendix. CRU instructions

Note: If only one DDR3L SDRAM is used on the computer you are servicing, the card must be installed in SLOT-0 (**a**: lower slot), but not in SLOT-1 (**b**: upper slot).

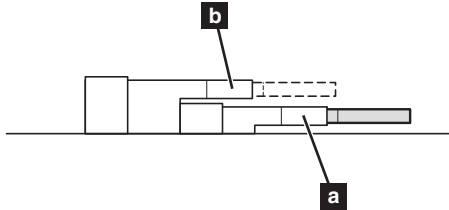

To make sure that the DDR3L SDRAM is installed correctly, do as follows:

- 1 Turn the computer on.
- 2 Hold **Fn + F2** during startup. The BIOS setup utility screen opens. The **System Memory** item shows the total amount of memory installed in your computer.

Appendix. CRU instructions

■ ■ Removing the optical drive

To remove the optical drive, do the following:

- 1 Remove the Hard disk drive/Memory/Central processing unit/Mini PCI Express Card slot compartment cover.
- 2 Remove the screw shown in the illustration **1**.
- 3 Gently pull the optical drive out **2**.

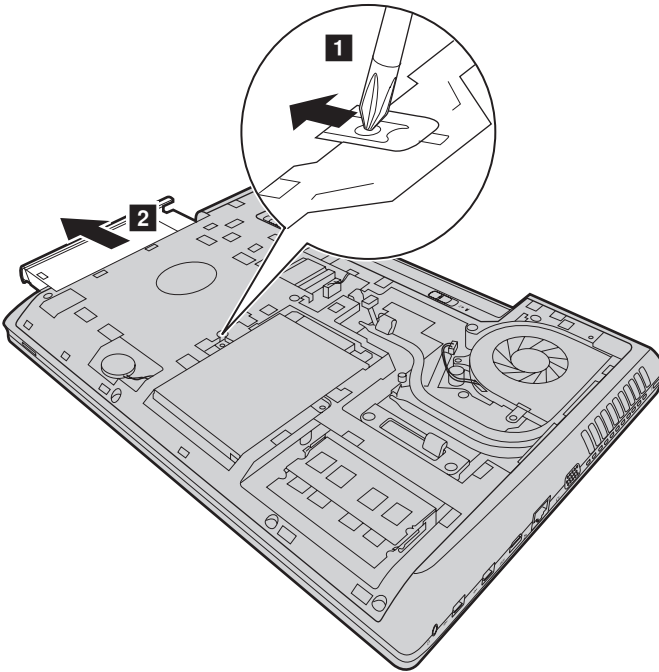

Appendix. CRU instructions

The following table provides a list of CRUs (Customer Replaceable Units) for your computer, and informs you of where to find replacement instructions.

	Setup Poster	User Guide
AC adapter	○	
Power cord for AC adapter	○	
Battery pack	○	○
Hard disk drive		○
Memory		○
Optical drive		○

Trademarks

The following terms are trademarks or registered trademarks of Lenovo in the United States, other countries, or both.

Lenovo
OneKey

Microsoft and Windows are trademarks of Microsoft Corporation in the United States, other countries, or both.

Other company, products, or service names may be trademarks or service marks of others.

lenovo[®]

©Lenovo China 2013

en-US
Rev. AA00

Free Manuals Download Website

<http://myh66.com>

<http://usermanuals.us>

<http://www.somanuals.com>

<http://www.4manuals.cc>

<http://www.manual-lib.com>

<http://www.404manual.com>

<http://www.luxmanual.com>

<http://aubethermostatmanual.com>

Golf course search by state

<http://golfingnear.com>

Email search by domain

<http://emailbydomain.com>

Auto manuals search

<http://auto.somanuals.com>

TV manuals search

<http://tv.somanuals.com>