

LA CROSSE®
TECHNOLOGY

Mood Light Alarm Clock

with Nature Sounds



For online video support:
<http://bit.ly/LaxTechTalk>

Model: C85135
DC: 022117

Table of Contents

Button Function Explanation	1
Buttons and Ports	1
Setup	2
LCD Features	2
Settings Menu	3
Nature Sounds with Sleep Timer	4
Mood Light	5
Backlight	5
Nap Feature	6
Time Alarms: Light or Sound	7
Set Light Alarm 1	7
Set Sound Alarm 2	8
Snooze	8
Deactivate or Activate Alarm	9
Low Battery Icon	9
USB Charging Port	9
Audio Port (AUX)	10
Specifications	10
Visit Us on Social Media	10
Care and Maintenance	11
Warranty and Support	11
FCC Statement	11

Button Function Explanation

For better programming instructions, please note these terms for button use:

- Press: Press and release the designated button.
- Hold: Hold the button for 3 seconds then release the button.
- Touch: Touch the SNOOZE/LIGHT area on top of the clock.

Buttons and Ports

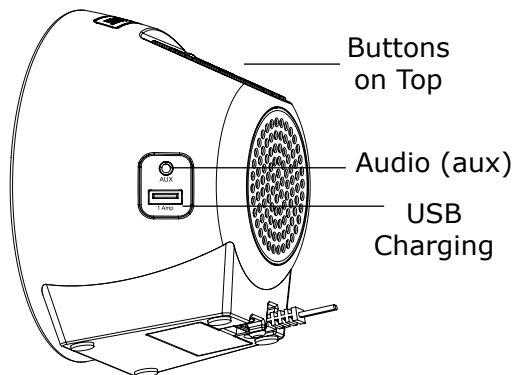
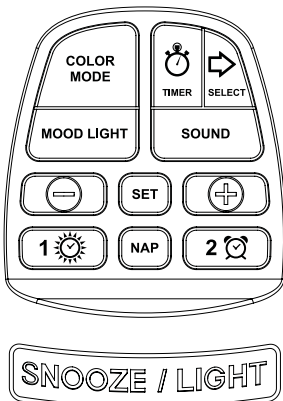

Setup

1. Insert the 5.0 volt power cable into the wall outlet, then into the side of the clock.
2. (Optional), Insert 2 AAA batteries (included) into the bottom of the clock.
3. Set language, time, calendar, and snooze duration.

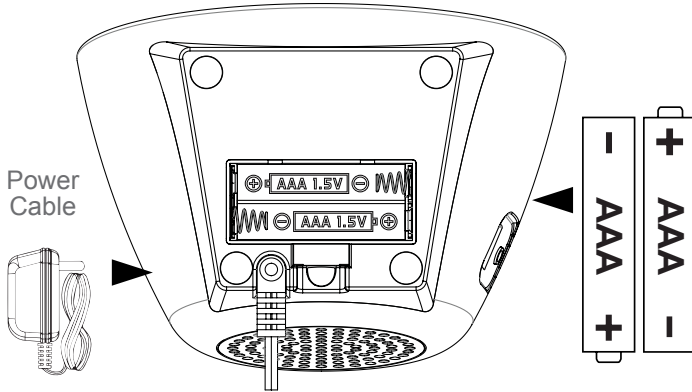



LCD Features

     Nature Sounds

 Active Sound (double ring)

PM AM | PM

1  Light Alarm 1

2  Sound Alarm 2

 Timer

 Low Battery



Settings Menu

- Hold the SET button to enter the settings menu.
- Press the + or - buttons to adjust the values.
- Press the SET button to confirm adjustments and move to the next item or exit.
- Press SNOOZE/LIGHT button to exit at any time.

Setting menu order:

1. Language (English or Spanish)
2. Beep ON/OFF
3. Hour
4. Minutes
5. Year
6. Month
7. Date
8. Snooze duration (5 minutes-120 minutes)

Note: When Español is selected, the instructions on screen will be in Spanish.

Begin: Hold the SET button. ENGLISH will show.

English or Español



Beep ON | OFF



Hour

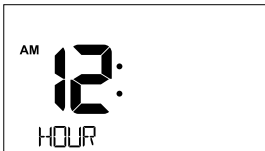

Minutes



Year

Month

Date

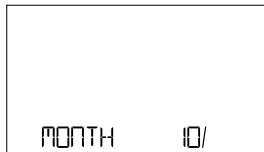
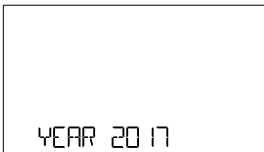

Snooze Duration (5-120)



Nature Sounds with Sleep Timer

- **NATURE SOUNDS:** Choose from five different nature sounds to listen to when you go to sleep.
 - The active icon (double ring) will indicate which sound is selected.
- Note:** Power adapter must be used for the sleep timer to work.
- **VOLUME:** When nature sound is playing you can adjust the volume with the + or - button.
 - **TIMER:** When nature sound is playing, choose how long the selected nature sound will play (15 minute increments up to 90 minutes).

To select a nature sound and timer:

1. Press the SELECT button to select the sound you want.
2. The active icon will start at Rain and move to a different sound with each press of the SELECT button.



The selector icon is the double ring around the sound icon.

IMPORTANT: The sound must be playing in order to adjust volume or set the timer. Power adapter must be used for the sleep timer.

3. Press the + or - button to adjust the volume (1-10) when sounds are playing.
4. Press the TIMER button to select the nature sound duration in 15 minute increments, up to 90 minutes.
 - The sound will play for the selected time then shut off.
 - The clock will remember the last sound and duration selected.
 - Press the SOUND button at any time to turn the sounds OFF.

Note: If you choose to change the time, press the TIMER button until the desired time is selected.



Backwoods sound selected.
Timer set for 30 minutes.

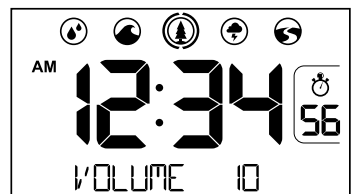

Normal display (hour, minutes) with
count down timer icon showing.

Mood Light

- The Mood Light surrounds the clock display.
- The brightness (intensity) and the color of the mood light are programmable (power cord required for mood light).

1. Press the MOOD LIGHT button to select mood light intensity level.

Level	Intensity
1	OFF
2	3%
3	20%
4	50%
5	100%

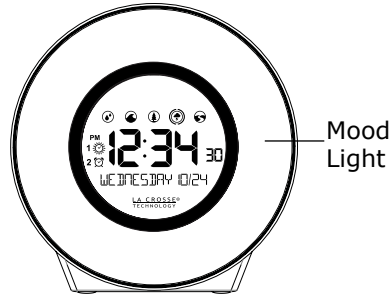

2. With mood light ON, press the COLOR MODE button to select from 7 color choices or cycle through all colors every 5 seconds.
(Red **1** | Yellow **2** | Green **3** | Cyan **4** | Blue **5** | Purple **6** | White **7**)
3. If Cycle is selected, the mood light will change colors every 5 seconds. Cycle does not have a number selection.

Note: The clock will save the last color choice, in the event the mood light is turned off.



Backlight

- When using provided power cable, the backlight can be adjusted in 5 levels.
- When using battery power only, the backlight will come on at 100% for 10 seconds only, when the SNOOZE/LIGHT button is touched.

1. Touch the SNOOZE/LIGHT button to select backlight intensity level.
(OFF | 10% | 30% | 60% | 100%)
2. Backlight and mood light adjust separately.

Backlight adjusts how bright the numbers appear on the black display.

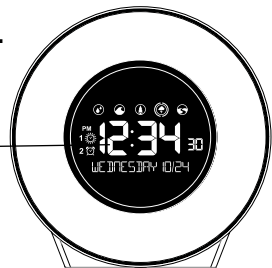

Nap Feature

Set the nap duration one time, then, a simple press of the NAP button starts the nap countdown.

Set Nap Duration:

1. Hold the NAP button. NAP and the nap duration will show (default is 15 minutes).
2. Press the + or - button to select nap duration (up to 120 minutes).
3. Press the NAP button to confirm and start the nap countdown to zero.



When you are ready to nap: Press the NAP button once, and the clock will wake you up after the nap countdown timer reaches zero.

- From normal time display, press the NAP button once to start the nap countdown.
- NAP will show with the preset duration.
- Minutes and seconds will countdown.
- When the alarm sounds, NAP "00m 00" will flash. The alarm will sound for two minutes and then stop if no buttons are pressed.
- Press any button except SNOOZE/LIGHT, at any time to stop the nap countdown alarm.



Time Alarms: Light or Sound

- This station offers a LIGHT ALARM and a SOUND ALARM.
- Both alarms may be set for the same time or separate times.
- The individual alarms will be active after the alarm time is set.

Light Alarm:

- The LIGHT ALARM is the White Mood Light.
- When alarm time is reached the White Mood Light will begin to glow and increase intensity over a 5 minute period, to 100%.
- It will stay at 100% for another 1 hour unless turned off.
- After 1 hour or when deactivated, the clock will automatically return to previous mood light color selected.
- Press the LIGHT ALARM 1 button to view alarm time. Press LIGHT ALARM 1 button again to deactivate the light alarm.
- When the alarm is turned off the alarm icon will disappear.

Sound Alarm:

- The sound alarm defaults to the Beep sound.
- You can select one of these sounds for the alarm:
(Beep | Rain | Ocean | Backwoods | Thunder | River)
- When alarm time is reached the sound selected will increase in volume over a 5 minute period, to volume 10.
- After 5 minutes the alarm will stop if not deactivated.
- Press the SOUND ALARM 2 button to view alarm time. Press SOUND ALARM 2 button again to deactivate the sound alarm.
- When the alarm is turned off the alarm icon will disappear.

Set LIGHT ALARM 1

1. Press the LIGHT ALARM 1 button to view LIGHT ALARM 1.
2. The default alarm time will show.
3. Hold the LIGHT ALARM 1 button to enter alarm time settings mode. The alarm hour will flash. Press the + or - button to set alarm hour.
4. Press the LIGHT ALARM 1 button to confirm and move to the minutes. The alarm minutes will flash. Press the + or - button to set the minutes.
5. Press the LIGHT ALARM 1 button to exit settings. This will set and activate the Light Alarm.

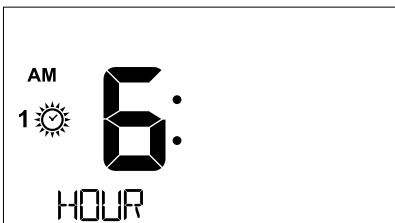

Set SOUND ALARM 2

1. Press the SOUND ALARM 2 button to view SOUND ALARM 2. The default alarm time will show.
2. Hold the SOUND ALARM 2 button to enter alarm setting mode. The alarm hour will flash. Press the + or - button to set alarm hour.
3. Press the SOUND ALARM 2 button to confirm and move to the minutes. The alarm minutes will flash. Press the + or - button to set the minutes.
4. Press the SOUND ALARM 2 button to choose alarm sound.
(Beep | Rain | Ocean | Backwoods | Thunder | River)
5. The weekday area will read BEEP which is the default sound.
6. Press the + or - button to select a different sound.
7. Press and release the SOUND ALARM 2 button to confirm and exit. This will set and activate the Sound Alarm.

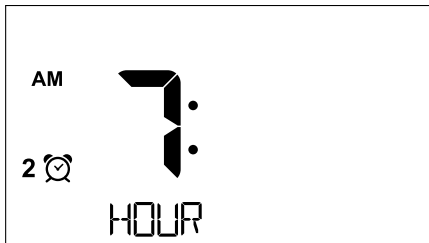

Snooze

- When alarm sounds, press the SNOOZE/LIGHT button to activate the SNOOZE function. SNOOZE - duration will show in date area.
- The alarm icon will flash.
- When snooze alarm sounds, SNOOZE duration "00 00" will flash, press any button except for SNOOZE/LIGHT to stop sounding and exit snooze function.

Snooze duration:



Deactivate or Activate Alarm

Alarms are active when alarm time is set.

1. Press the LIGHT ALARM 1 or SOUND ALARM 2 button.
2. Alarm time will show for 3 seconds.
3. Press the LIGHT ALARM 1 button or SOUND ALARM 2 button to deactivate or activate that specific alarm.
4. Alarm icon will show when active and disappear when deactivated.
5. Alarm icon will flash when alarm sounds.
6. When alarm time is reached, press any button except for SNOOZE/LIGHT to deactivate alarm for one day.



Alarms Active



Alarms Inactive

Low Battery Icon

- The low battery icon will appear between the hour and minutes.
- This icon indicates it is time to replace the batteries.

USB Charging Port

There is a 1 Amp USB charging port on the side of the clock. The included power adapter must be in use to charge a device with your cable.

- Connect your external device's USB charging cable (not included) to the USB charging port.
- Charging times will vary.
- USB Power Output: 1A maximum current.
- Charge 1A devices or devices that are self-regulating.

Audio Port (AUX)

There is an audio input jack on the side of this clock, which will allow you to play music through the internal speakers of this alarm clock.

To play audio from a phone, MP3 player, or other device:

1. Simply plug an auxiliary cord (not included) into your device, then into the clock. Be sure sound is turned up on your device.
2. Press the SOUND button to turn on audio.
3. Use the + or - button to adjust the volume (1-10).
"VOLUME 5" and the Volume number will show in the date area.
Volume will stay on last setting level.
4. Press the SOUND button to turn off the auxiliary port sounds or simply remove the auxiliary cord.

Note: A sounding alarm will temporarily interrupt the auxiliary port for the alarm duration. When the alarm ends or is turned off, music resumes automatically.

Note: Nature sounds/timer feature will be disabled when auxiliary cord is inserted. When cord is removed nature sound/timer feature will work if activated.

Specifications

Power: 5.0V AC6: HX15-0501500-AU

Optional-2-AAA, IEC, LR3 batteries (included)

USB Output: 1 Amp

Battery Life: Battery life is over 24 months with reputable batteries

Dimensions: 5.44" W x 3.4" D x 5.5" H

(13.81cm W x 8.6cm D x 13.97cm H)

Visit Us on Social Media



Latest video content

http://bit.ly/LaxTech_YouTube



For personalized interaction

http://bit.ly/LaxTech_Facebook



Join the conversation

http://bit.ly/LaxTech_Twitter



Pin and share

http://bit.ly/LaxTech_Pinterest

Care and Maintenance

- Do not mix old and new batteries.
- Do not mix Alkaline, Standard, Lithium, or Rechargeable Batteries.
- Always purchase the correct size and grade of battery most suitable for intended use.
- Replace all batteries of a set at the same time.
- Clean the battery contacts and also those of the device prior to battery installation.
- Ensure the batteries are installed with correct polarity (+ and -).
- Remove batteries from equipment when it is not used for an extended period of time.
- Promptly remove expired batteries.

Warranty and Support

La Crosse Technology, Ltd. provides a 1-year limited time warranty (from date of purchase) on this product relating to manufacturing defects in materials & workmanship.

Before returning a product, please contact our friendly customer support with questions or visit our online help:

Phone: 1-877-408-2678

Online Product Support and Registration:

www.lacrossetechnology.com/support

View full warranty details online at:

www.lacrossetechnology.com/warranty_info.pdf

FCC Statement

This equipment has been tested and found to comply with the limits for a Class B digital device, pursuant to part 15 of the FCC Rules. These limits are designed to provide reasonable protection against harmful interference in a residential installation. This equipment generates, uses and can radiate radio frequency energy and, if not installed and used in accordance with the instructions, may cause harmful interference to radio communications. However, there is no guarantee that interference will not occur in a particular installation.

If this equipment does cause harmful interference to radio or television reception, which can be determined by turning the equipment off and on, the user is encouraged to try to correct the interference by one or more of the following measures:

- Reorient or relocate the receiving antenna.
- Increase the separation between the equipment and receiver.
- Connect the equipment into an outlet on a circuit different from that to which the receiver is connected.
- Consult the dealer or an experienced radio/TV technician for help.

This device must not be co-located or operating in conjunction with any other antenna or transmitter.

Operation is subject to the following two conditions:

- (1) This device may not cause harmful interference, and
- (2) This device must accept any interference received, including interference that may cause undesired operation.

Caution!

The manufacturer is not responsible for any radio or TV interference caused by unauthorized changes or modifications to this equipment. Such changes or modifications could void the user authority to operate the equipment.

This equipment must be installed and operated in accordance with provided instructions and the antenna(s) used for this transmitter must be installed to provide a separation distance of at least 20 cm from all persons and must not be co-located or operating in conjunction with any other antenna or transmitter

All rights reserved. This manual may not be reproduced in any form, even in part, or duplicated or processed using electronic, mechanical or chemical process without the written permission of the publisher. This booklet may contain errors or misprints. The information it contains is regularly checked and corrections are included in subsequent editions. We disclaim any responsibility for any technical error or printing error, or their consequences. All trademarks and patents are recognized.

Free Manuals Download Website

<http://myh66.com>

<http://usermanuals.us>

<http://www.somanuals.com>

<http://www.4manuals.cc>

<http://www.manual-lib.com>

<http://www.404manual.com>

<http://www.luxmanual.com>

<http://aubethermostatmanual.com>

Golf course search by state

<http://golfingnear.com>

Email search by domain

<http://emailbydomain.com>

Auto manuals search

<http://auto.somanuals.com>

TV manuals search

<http://tv.somanuals.com>