

# SEARS Kenmore

## OWNER'S MANUAL

MODEL NO.

911. 95361

911. 95368

911. 95455

911. 95459

911. 95465

911. 95469

911. 95371

911. 95378

### **CAUTION:**

*Read and Follow All Safety  
Rules and Operating  
Instructions Before First  
Use of This Product*

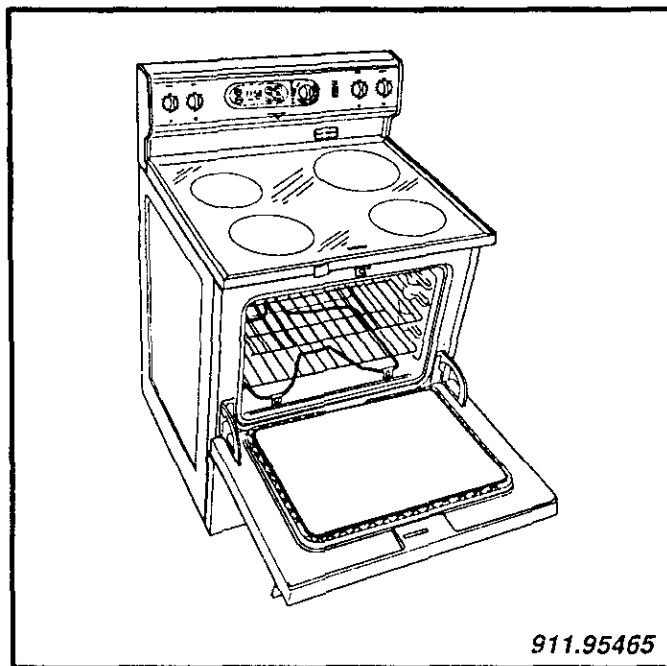

## **30" RADIANT SELF-CLEANING FREE-STANDING RANGE**

- *Safety Instructions*
- *Features*
- *Operation*
- *Care and Cleaning*
- *Problem Solving*
- *Easy Adjustment*
- *Consumer Service*

---

**Sears, Roebuck and Co., Hoffman Estates, IL 60179 U.S.A.**

---

MAR 29 2000

22904020P064-2(SR10287)

# RADIANT FREE-STANDING RANGE

## TABLE OF CONTENTS



### SAFETY INSTRUCTIONS

Range Safety .....	13
Stability Device .....	13

### INTRODUCING YOUR RANGE

Removal of Packaging Tape .....	7
Features of Your Range .....	8
Protecting Your New Cooktop .....	7

### COOKTOP COOKING

Cooking Zones .....	9
Cooking Utensils and Woks .....	9
Checking Your Cookware .....	9
Radiant Coils .....	9
Cookware Performance .....	9
Radiant Unit Cycle .....	10
Control Settings .....	10
Home Canning .....	10

### ABOUT YOUR CONTROL

Arrow Pads .....	11
Display .....	11
Indicator Lights .....	11
F-Codes .....	11
PF-Codes .....	11
Black-Out Display .....	11
Automatic Shut-Off .....	11
To Set the Clock .....	12
To Set the Timer .....	12
To Reset the Timer .....	12
To Cancel the Timer .....	12

### USING YOUR OVEN

How to Set Bake .....	15
Oven Cooking Tips .....	13-15
Temperature Adjustment .....	15
<b>Broiling</b> .....	16
General Rules: Preparing Meats for	
Broiling, How to Set Broil .....	16
<b>Self-Cleaning</b> .....	17-18
Preparing Your Oven .....	17
Oven Door Gasket .....	17
Door Lock Device .....	17
Walls of the Oven .....	17
How to Set A Clean Cycle .....	18
To Stop A Cycle .....	18
After The Cycle .....	18

### CLEANING

Control Panel .....	20
Broiler Pan and Grid .....	20
Painted Surfaces .....	20
Glass Ceramic Cooktop .....	19

### REMOVABLE PARTS

Surface Control Knobs .....	21
Oven Light Bulb .....	21
Storage Drawer .....	22
Oven Racks .....	23
Oven Door .....	23

### SERVICE

Before Calling for Service .....	24, 25
Temperature Adjustment .....	26
Consumer Service Numbers .....	27
Warranty .....	

**For your convenience and future reference, please write down your model and serial numbers in the space provided. They are located on the front frame behind the storage drawer.**

**MODEL NUMBER:**

**SERIAL NUMBER:**

# IMPORTANT INSTRUCTIONS FOR YOUR SAFETY



## SAVE THESE INSTRUCTIONS

Read all instructions before using this appliance. When using gas or electrical appliances, basic safety precautions should be followed, including the following:

### STABILITY DEVICE

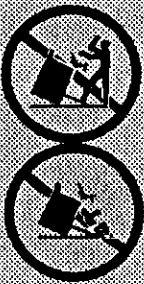

#### WARNING

- All Ranges Can Tip
- Injury To Persons Could Result
- Install Anti-tip Device Packed With Range
- See Installation Instructions

#### Tools you will need:

- Phillips head screwdriver
- 1 3/8" open end or adjustable wrench

### INSTALLATION OF THE ANTI-TIP DEVICE

1. Remove the bracket from the prepack located inside the oven.
2. Decide whether the bracket will be installed on the right or left side of range location.
3. If the bracket side of the range is adjacent to a cabinet, place the bracket against back wall and cabinet as shown below.

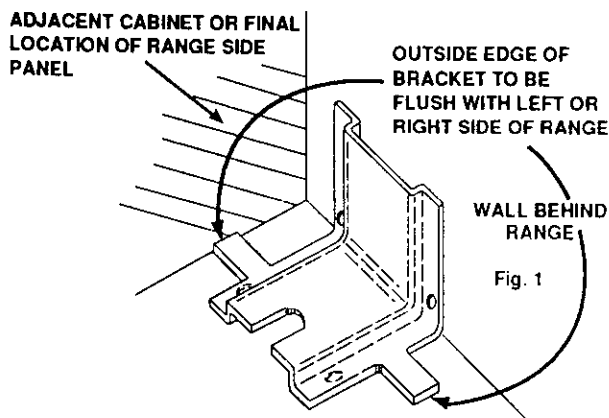

If there is no adjacent cabinet, determine where the location of the range side (painted outside panel) will be. Place the bracket with its outside edge at this location and against back wall. See illustration below.

4. Determine whether you will anchor the bracket to the floor or wall. Make sure this location is clear of electrical wiring or plumbing.
5. Fasten the bracket securely with the screws provided. Screws are self-drilling in wood, plywood, particle and chip board, and most metal framing. If attaching to masonry, you can buy suitable screws and anchors at hardware stores. Use a masonry drill to drill the required holes.

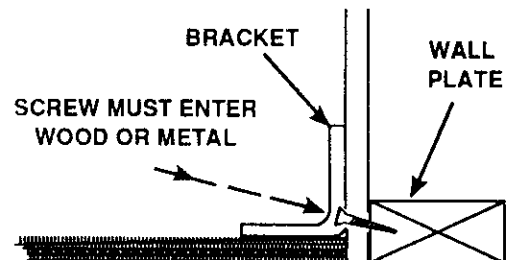

6. Using the wrench, back out the four leg levelers at least two turns. See your installation guide for more leveling information before positioning range.
7. Slide the range into place. Be sure rear leg leveler fully engages the slot in the bracket. If range cannot be moved back far enough for rear leg leveler to enter bracket, move bracket forward as required and attach to floor in new location.

# IMPORTANT INSTRUCTIONS FOR YOUR SAFETY *continued*

To insure safety for yourself, family and home, please read your Owner's Manual carefully. Keep it handy for reference. Pay close attention to Safety Sections.

**BE SURE** your appliance is installed and grounded by a qualified technician.

## IMPORTANT SAFETY NOTICE

**The California Safe Drinking Water and Toxic Enforcement Act requires the governor of California to publish a list of substances known to the state to cause birth defects or other reproductive harm and requires businesses to warn their customers of potential exposure to such substances.**

**The fiberglass insulation in self-cleaning oven will give off a very small amount of carbon monoxide during the cleaning cycle. Exposure can be minimized by venting with an open door or window or using a ventilation fan or hood.**

### WARNING!



**To prevent accidental tipping of the range from abnormal usage, including excessive loading of the oven door, attach it to the wall or floor by installing the Anti-Tip device supplied. If the range is moved for cleaning, servicing or any reason, be sure the Anti-Tip device is re-engaged properly when the range is slid back in the opening. Failure to do so could result in the range tipping or personal injury. To inspect the anti-tip device, remove the storage drawer and look to see if the rear leg leveler fully engages the slot in the bracket.**

**DO NOT** touch heating elements, surfaces near them or interior oven surfaces. These may be hot enough to burn even though they are dark in color. During and after use, do not touch or let clothing or flammable materials contact the elements or hot surfaces until they have had time to cool. Other surfaces near the oven vent opening, oven door, window and top surfaces may also be hot enough to cause burns.

**DO NOT** leave children unattended near an appliance in use.

### TEACH CHILDREN

- Not to play with controls or any part of the appliance.
- Not to sit, climb or stand on the door or any other part of the appliance.



**CAUTION:** Never store items of interest to children on the backguard or in cabinets above the appliance. Children climbing on the appliance could be seriously injured.



**KEEP THIS** book for later use.

**NEVER TRY** to repair or replace any part of the appliance unless instructions are given in this manual. All other work should be done by a qualified technician.

**NEVER USE** your appliance for warming or heating the room.

**ALWAYS KEEP** combustible wall coverings, curtains, dish cloths, towels, potholders and other linens a safe distance from the appliance.



**NEVER HEAT** unopened food containers. Pressure buildup can cause the container to burst and cause injury.

# IMPORTANT INSTRUCTIONS FOR YOUR SAFETY<sub>continued</sub>

**NEVER LEAVE** jars or cans of fat or drippings in your oven.

**ALWAYS KEEP** the oven and surface unit areas free from things that will burn. Food, wooden utensils, grease buildup, gasoline and other flammable vapors or liquids could catch fire. Plastic utensils could melt and canned foods could explode. Your appliance should never be used as a storage area.

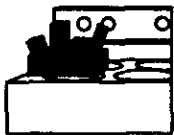

**SOME CLEANERS** produce noxious fumes and wet cloths or sponges could cause steam burns.

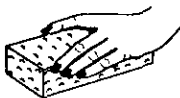

**NEVER WEAR** hanging or loose fitting clothing when using your appliance.

**NEVER USE** a towel or other bulky cloth as a potholder and make sure the potholder is dry. Moist potholders could cause steam burns. Do not let potholders touch heating elements.



**COOKWARE USED** for cooktop cooking should be flat on the bottom and large enough to cover the heating area being used. This will improve heating efficiency. Undersized utensils expose the heating area and may result in direct contact or ignition of clothing.



**NEVER LEAVE** surface units unattended at high settings. Boilovers result in smoking or greasy spills that could catch fire.

**ALWAYS** turn utensil handles inward and away from other surface units to reduce the risk of burns, ignition, unintended contact or spillage.

**NEVER** cook on a broken cooktop; cleaning solutions or spillage could penetrate it and create the risk of electrical shock or fire.

## OVEN SAFETY

**PLACE OVEN RACKS** in the desired position while the oven is cool. If racks must be moved while oven is hot, do not let the potholder contact the hot oven element.

**AFTER BROILING,** always take the broiler pan and grid out of the oven and clean them. Leftover grease in the broiler pan could catch fire next time you use your oven.

**ALWAYS USE** care when opening the oven door. Let hot air and steam escape before moving foods.

**NEVER USE** aluminum foil to line the oven bottom. Improper use of foil could result in the risk of electrical shock and fire.

## COOKTOP SAFETY

**ONLY SOME** kinds of glass or ceramic cookware can be used for cooktop cooking. Make sure the cookware you choose to use is designed for cooktop cooking without cracking due to the sudden changes in temperatures.

**ALWAYS USE** care when touching cooktop cooking zones. They will retain heat after the range has been turned off.

**NEVER BLOCK** the oven air vent on the backguard of the range.

# IMPORTANT INSTRUCTIONS FOR YOUR SAFETY<sup>continued</sup>

## SELF-CLEAN SAFETY

**CLEAN ONLY** the parts listed in this manual. Follow all cleaning instructions. Be sure to remove the broiler pan and grid before starting the self-clean cycle.

**IF THE SELF-CLEANING** mode malfunctions, turn off the controls or disconnect the power supply. Have serviced by a qualified technician.

**NEVER RUB,** move or damage the door gasket on self-cleaning ranges.

**NEVER TRY** to clean utensils, cookware, removable parts or broiler pan and grid in the self-clean cycle.

**DO NOT USE** oven cleaners—No commercial oven cleaner or protective coating of any kind should be used in or around any part of the oven.



## READ AND UNDERSTAND THIS INFORMATION NOW!

Should you ever need it, you will not have time for reading. Be sure everyone in your home knows what to do in case of fire. Never use water on a grease fire; it will only spread the flames.

## COOKTOP GREASE FIRE:

**Never pick up a flaming pan...**

1. Turn off the surface elements.
2. Smother the flame with a tightly fitting lid, baking soda or use a dry chemical, foam or halon type extinguisher.

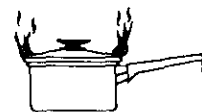

## OVEN FIRE:

**Do not try to move the pan!**

1. Close the oven door and turn controls off.
2. If fire continues, throw baking soda on the fire, or use a dry chemical, foam, or halon type extinguisher.



# PROTECTING YOUR NEW COOKTOP

## IMPORTANT INSTRUCTIONS TO AVOID DAMAGE TO YOUR NEW RADIANT COOKTOP

- Do not slide cookware across your cooktop.
- Do not use a dish towel or sponge to clean or wipe down your cooktop.
- Do not use scouring powders or plastic, nylon or metal cleaning pads on your cooktop.
- Do not apply your cooktop cleaning creme to the cooktop surface if the surface is hot.
- Read the instruction label on the cooktop cleaning creme bottle before attempting to clean the surface of your cooktop.
- After cleaning the cooktop surface, be sure to wipe off any residue that may be left from the creme with a dry paper towel.
- For major spills, turn the surface control knob to OFF; use a dry paper towel to wipe up spill, then use a razor scraper (held with a potholder) at a 30° angle against the surface of the cooktop to scrape remaining spill from the hot cooking zone.
- Do not cook directly on the surface of the glass.
- Do not use the cooktop as a cutting board.



**CAUTION:**  
When the surface controls are turned off, the Hot Surface Indicator light will remain lit until the cooktop surface has cooled to approximately 150°F. The glass ceramic surface will retain heat after the indicator light goes out. Use caution until the cooktop surface has had time to cool.

## REMOVAL OF PACKAGING TAPE

To remove the adhesive left from packaging tape, use household dishwashing liquid, mineral oil or cooking oil. With a soft cloth rub into the area and allow to soak. Rinse and dry well. Repeat procedure using an appliance polish to insure no damage is done to the oven. **This should be done before the range is turned on for the first time. The tape cannot be removed once the oven has heated.**

**Packaging tape can be found in the following areas:**

**Cooktop surface  
Door handle  
Control panel area  
Door trim  
Oven area**

# FEATURES OF YOUR NEW RADIANT RANGE

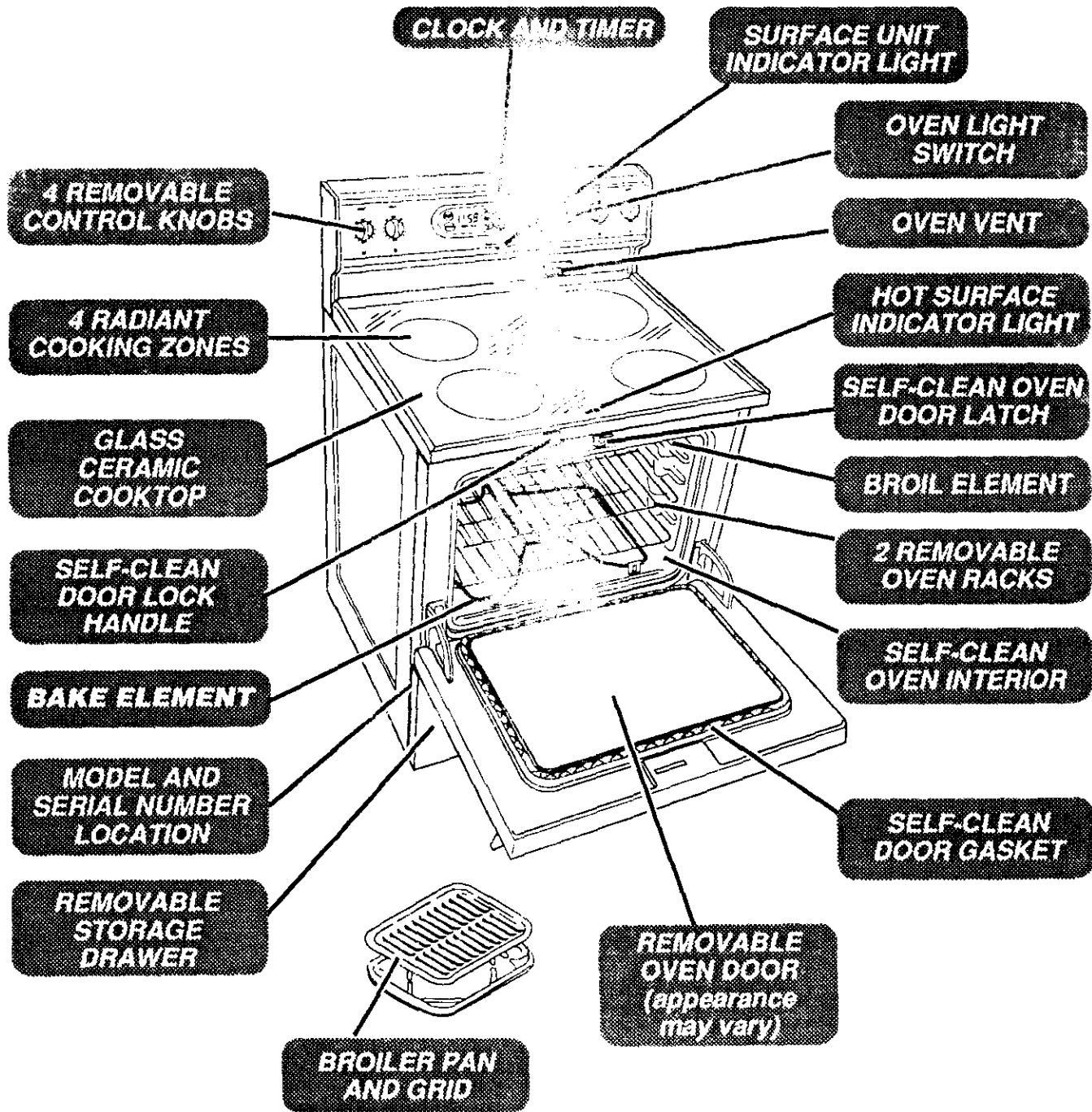



# RADIANT COOKTOP COOKING

Before using your new radiant cooktop, clean it with the Cooktop Cleaning Creme®. This will leave a protective coating.



## COOKING ZONES

The cooking zones are shown by the outline on the glass. The sign near each control knob shows you which radiant zone is turned on by that knob.

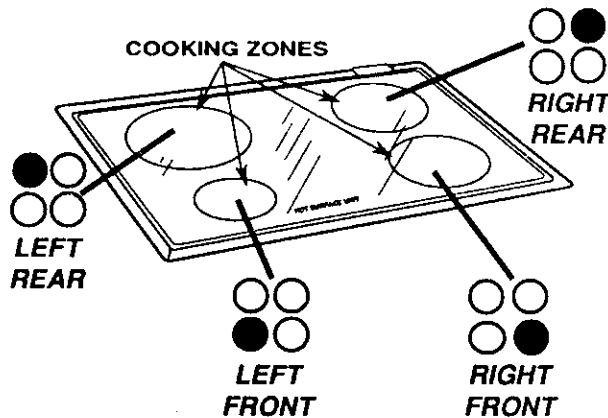

## COOKING UTENSILS AND WOKS

Use pans and woks that are flat on the bottom. The size of the pan should be the same size as the zone used when cooking.



Pans should be flat on bottom

## CHECKING YOUR COOKWARE

If you don't know if your cookware is flat on the bottom, try this test. Turn your pan upside down on the countertop, place a ruler flat against the surface of the pan. The bottom of the pan and the edge of the ruler should fit flush against each other all the way across. Turn the ruler a full 360 degrees, checking as you turn for any space between the two surfaces.

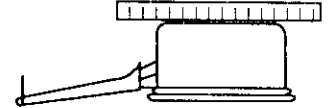

## COOKWARE PERFORMANCE

**Stainless Steel:** Highly recommended for use with your new cooktop. Especially good with a sandwich clad bottom.

**Aluminum:** Heavy weight aluminum cookware recommended.

**Cast Iron:** Cast iron cookware that is completely covered with porcelain enamel is recommended. Cast iron that is not covered with porcelain enamel may scratch the glass ceramic surface of the cooktop.

**Copper Bottom:** Has good performance, but it can leave a residue on the cooktop surface.

**Glass-Ceramic or Stoneware:** Usable, but not recommended. It may scratch the surface of the cooktop.

## RADIANT COILS

When the knobs are turned on, coils beneath the glass radiate heat through the glass to the cooking utensil. It will take a few minutes for the coils to heat; as they do, a red glow can be seen on the surface of the cooktop.

# RADIANT COOKING continued

## RADIANT UNIT CYCLE

The Temperature Limiters of the cooking zones provide a protection for your new cooktop. The Limiters will turn the radiant coils on and off while cooking or canning. This procedure helps maintain an even cooking temperature without allowing the cooking zones to overheat.

## CONTROL SETTINGS

### HI

Used for quick starts, such as bringing water to a boil.



### MED

Used for slow boil and sautéing.

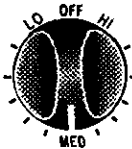

### LO

Used for steaming foods or keeping cooked foods at serving temperature.



1. Push down to turn the knob.

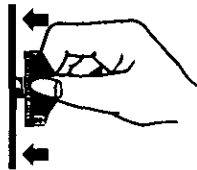

2. Set on or between marks for desired heat.

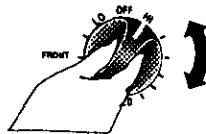

## HOME CANNING TIPS

Water-bath or pressure canners and large diameter pots extending more than 1" beyond the edge of the cooktop zones may be used when canning. This is because the temperature needed to boil water is not harmful to the surfaces surrounding the cooktop zones.

**However, do not use large diameter canners, pots or pans for anything other than boiling water.**

## OBSERVE THE FOLLOWING POINTS WHEN CANNING

1. Be sure the canner is centered over the zones.
2. Make sure the canner is flat on the bottom.



3. Use recipes and procedures from reputable sources. These are available from manufacturers such as Ball and Kerr and the Department of Agriculture Extension Service.
4. Use caution while canning, to prevent burns from steam or heat.

# CLOCK, TIMER, & OVEN CONTROL

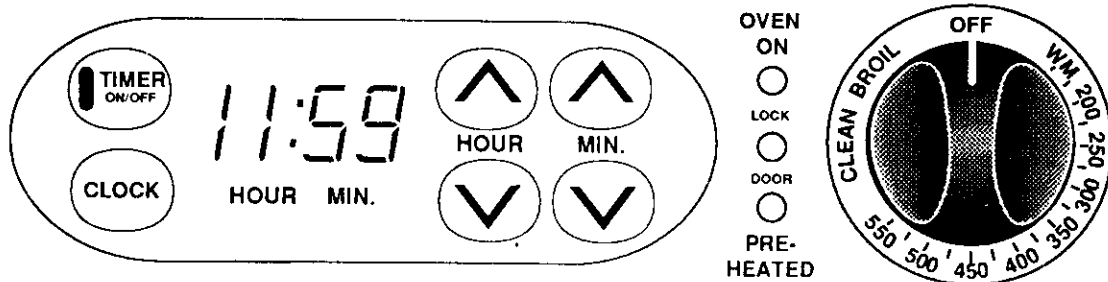

Your new range **CLOCK**, **TIMER** and **OVEN** operations are simple and easy to understand.

## THE HOUR/MINUTE ARROW PAD

The **HOUR/DOWN** arrow pads allow you to set the exact time you need.

## DISPLAY

The display in the center of your control will show:

1. The time of day **CLOCK**.
2. The amount of time you choose when using the **TIMER**.

## INDICATOR LIGHTS

Your control has individual indicator lights that will show you the operations you have chosen.

As you read through your manual, you will find what each of these indicators are used for and how they will help you in understanding your new control.

## F-CODES

If the display flashes an **"F"** followed by a number and beeps continuously, you have a function error code. Note the number after the **"F"**. Turn the oven control knob to the **OFF** position and press the **TIMER ON/OFF** pad and the **CLOCK** pad. Allow the oven to cool for about 1 hour and retry the oven operation. If the problem repeats call for service. Advise the Technician what the flashing code was.

## PF CODE

When the power to your range is turned on for the first time, the display will flash **"PF"**. By pressing the **CLOCK** pad, the display will flash **"12:00"**. Press the **CLOCK** pad again and you will be ready to set the clock.

If you experience a power failure, the display will flash **"PF"**. The clock and any oven operation being used at the time the power failure occurred will need to be reset. Make sure you turn the **OVEN CONTROL KNOB** to **"OFF"** before resetting the operation.

## TO BLACK OUT THE DISPLAY

Your new control has the special feature of blacking out the display (have nothing showing in the display).

To activate this feature:

If the time of day is showing in the display, press the **CLOCK** pad once.

To bring back the display from the time of day black-out, press the **CLOCK** pad twice.

## AUTOMATIC OVEN SHUT-OFF

As a safety feature, this oven will automatically shut off if it has been left on for more than 12 hours.

# CLOCK AND TIMER

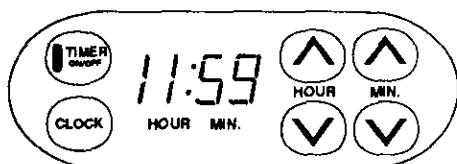

The **CLOCK** and **TIMER** are set by using the touch pads. The **TIMER** will not control any oven operation.

## TO SET THE CLOCK



1. Press the **CLOCK** pad until display flashes.



2. Press the **HOUR/MINUTE UP** or **DOWN** pads to set the time of day.



The clock will automatically start keeping time within one minute or you may press the **CLOCK** pad for immediate start.

## TO SET THE TIMER

The **TIMER** is only a minute timer; it will not control oven operations. The maximum time you may set is 11 hours and 59 minutes.



1. Press the **TIMER ON/OFF** pad. "0:00" and the Timer indicator light will flash.



2. Press the **HOUR/MINUTE UP** or **DOWN** arrow pads to set the time you prefer to use.



After releasing the **MIN/HR** pad, the timer indicator light will blink three to five times and the timer will begin the countdown. The Timer Indicator Light will remain on until the countdown reaches "0".

When the timer has started the countdown, you may press the **CLOCK** pad to return to the current time of day.

At the end of the countdown the control will beep and the Timer Indicator Light will flash to alert you the time is up. Press the **TIMER ON/OFF** pad.

## REMINDER!

If you hesitate while pressing the **UP** or **DOWN** arrow pads the display and the timer indicator lights will blink 3 times and return the display to the time of day clock. If this happens, press the **TIMER ON/OFF** pad to start over.

## TO RESET THE TIMER

If you have selected an amount of time, but decide to change it:

If the countdown is showing in the display, press the **MINUTE/HOUR UP** or **DOWN** arrow pad. Select the time.

If the time of day clock is showing in the display, press the **TIMER ON/OFF** pad. Then, press either the **MINUTE/HOUR UP** or **DOWN** arrow pad. Select the time.

## TO CANCEL THE TIMER

If you wish to cancel the **TIMER**, the countdown must be showing in the display. If it isn't, press the **TIMER ON/OFF** pad to recall the countdown, then press the **TIMER ON/OFF** pad to cancel.

# OVEN COOKING TIPS

## STRONG SMELL OR ODOR

It is normal to have some odor when using your oven for the first time. This is caused by the heating of new parts and insulation.

To help eliminate this odor, **ventilate the room by opening a window or using a vent hood.**

## ALUMINUM FOIL

### IMPORTANT:

Never cover the oven bottom or oven rack with aluminum foil. Improper use can cause poor heat flow, poor baking results, and may damage the oven finish.

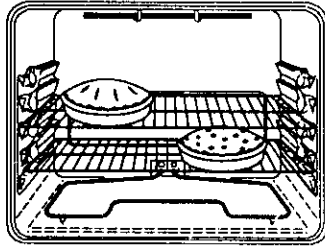

## OVEN VENT

The oven vent is located on the back of the control panel. This area could become hot during oven use. The vent is important for proper air circulation. **Never block this vent.**

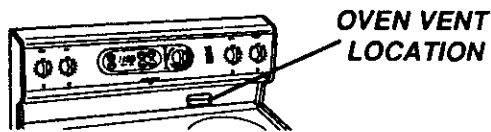

## PREHEATING

Let the oven preheat thoroughly when recipes call for preheating. Preheating is bringing the temperature up to the temperature you will be using during baking. When the oven has reached the preheat temperature, a tone will sound. Have foods nearby ready to place in the oven.

## OVEN TEMPERATURE SENSOR

In the back of the oven you will notice a small tube. This is a heat sensor that maintains the temperature of the oven. Never move or bend this tube.

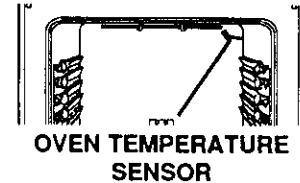

## NO PEEKING

Opening the door often to check foods will cause heat loss and poor baking results.

## FAN RUNNING

During any oven operation you may hear a fan noise. This is the internal cooling fan that keeps all electrical parts from overheating. It is not uncommon for this fan to keep running even after the oven is turned off.

# OVEN COOKING TIPS *continued*

## BAKEWARE

### FLAT COOKIE SHEETS

(without sides)

Flat cookie sheets allow air to circulate all around the cookies for even browning.

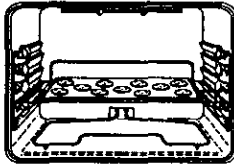

### SHINY PANS

(reflect heat)

Shiny pans are perfect for cakes and quick breads that have a golden brown crust.

### GLASS, DARK NON-STICK, OR DARKENED BY AGE BAKEWARE

(absorb heat)

Perfect for yeast breads, pie crust or foods that have a brown crust. The oven temperature should be reduced by 25°F.

## MOISTURE

As the oven heats, the change in temperature inside the oven causes water droplets to form on the oven door glass. To prevent this, open the door momentarily to allow the moist air out.

## BAKEWARE PLACEMENT

If baking with more than one pan, place the pans so each has at least 1 to 1 1/2" of air space around it. Place pans so one is not directly above the other.

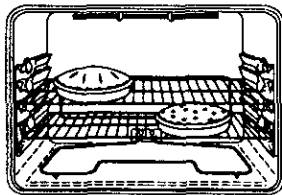

## ELEMENT CYCLING

The Oven Temperature Sensor at the back of the oven continuously senses and controls the temperature inside the oven. To keep a constant set temperature, the elements will cycle or turn on and off during cooking.

## LOW TEMPERATURE ZONE

The low temperature zone of your oven (between 170° and 200°F) is available to keep hot cooked foods warm. However, foods kept at these temperatures longer than 2 hours may spoil.

## OVEN RACKS

The oven racks are designed with stop locks, a convenience as well as a safety precaution, for placing foods in or removing foods from the oven. When the racks are placed correctly in the oven, the guides have a bump to prevent the racks from tilting. Your oven has four (4) rack positions that may be used during cooking.

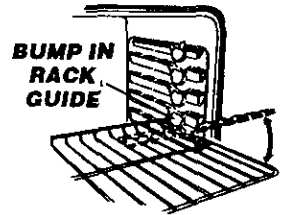

**The top position is only a guide. It cannot be used as a rack position.**

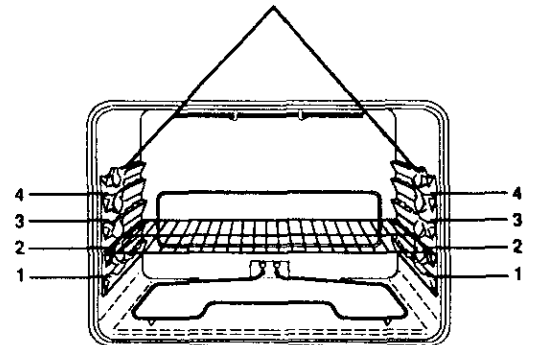

**Always place oven racks in the proper position while oven is cool.**

# OVEN COOKING TIPS continued

## OVEN TEMPERATURE ADJUSTMENT

You may feel that your new oven cooks differently than the oven it replaced. We recommend that you use your new oven a few weeks to become more familiar with it, following the times given in your recipes as a guide. See *Do It Yourself Temperature Adjustment* in the back of this manual, if you feel your oven is too hot or too cool for your cooking preference.

## SELF-CLEAN DOOR LOCK HANDLE

Your new range is equipped with a Self-Clean Door lock handle (used for self-clean only).

**Never lock during baking or broiling.**

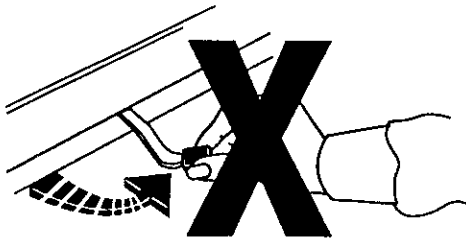

## OVEN CONTROL

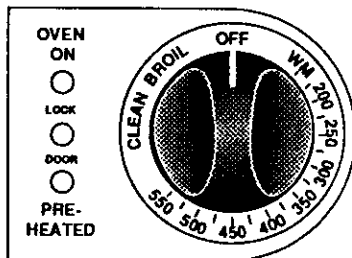

Your oven control has a selector knob for choosing **BAKE**, **BROIL**, or **CLEAN**. There are also three indicator lights:

- **PREHEATED Indicator Light** — turns on and stays on when oven has reached selected temperatures.
- **OVEN ON Indicator Light** — turns on and stays on when bake, broil, or clean function has been chosen.
- **LOCK DOOR Indicator Light** — turns on for self-clean. If the **LOCK DOOR** Indicator Light flashes you should check for one of the following:
  1. The latch handle is locked during a baking function.
  2. The latch handle is not locked during a self-clean function.

## TO SET BAKE

1. Turn the **OVEN CONTROL KNOB** to selected temperature from **WM** to **550°F**.
2. The **“OVEN ON”** indicator light will glow.
3. When the oven has reached the selected temperature the **“PREHEATED”** and **“OVEN ON”** indicator lights will glow. Place food in the oven.
4. The **“PREHEATED”** and **“OVEN ON”** indicator lights will remain on until baking is complete and the control knob is turned to the **OFF** position.

During the baking function you may hear clicking. This is normal. The oven heating elements cycle on and off to maintain the selected temperature.

# BROILING

## GENERAL RULES

Broiling is cooking by direct heat from the upper element.

The oven door should remain opened to the broil stop position during broiling.

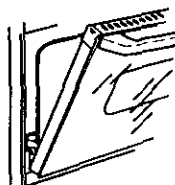

It is not necessary to preheat the oven when broiling. Use the broiler pan and grid that came with your range. Both are designed for proper drainage of fat and liquids.

### WARNING!



**Foil must be molded tightly to the grid and slits cut into the foil to match those of the grid. This allows fats and liquids to drain into the broiler pan, preventing fire and excessive smoke.**

**Always remove the pan and grid from the oven. Storing or forgetting a soiled broiler pan in the oven is a potential smoke or fire hazard.**

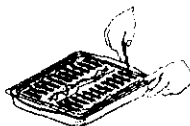

## PREPARING MEATS FOR BROILING

- Choose tender cuts of meat at least 3/4" thick for broiling.
- Trim the outer layer of fat; slit the edges to keep meats from curling.
- Always use tongs to turn meats. Piercing meat allows juices to escape.
- Salt the first side of meats just before turning, the second side just before serving. Brush chicken and fish with butter several times as they broil.
- Chicken and fish should be placed on the grid skin side down. For fish, lightly grease the grid to prevent sticking.

The U.S. Department of Agriculture notes that meat cooked rare is popular, but meat cooked to only 140°F (rare) means that some food poisoning organisms may survive.

The closer you place foods to the broil element, the faster foods brown on the outside yet remain red to pink in the center.

Moving meats away from the element will allow the meat to cook to the center while browning on the outside. Cook side 1 at least 2 minutes longer than side 2. If your oven is connected to 208 volts, you may want to use a higher rack position and/or broil foods longer.

The size, weight, thickness, starting temperature and your preference of the doneness of the meat will affect broiling. This chart is based on meats at refrigerator temperature.

FOOD	RACK POSITION	TOTAL TIME (MIN.)
Steak 1" thick	3	9-11
Ground beef patties 1" thick	3	16-18
Pork Chops- 1/2" thick	3	27-29
Fish (fillets)	3	11-13
Chicken (pieces)	2	45-55

## HOW TO SET BROIL

1. Set the **OVEN CONTROL KNOB** to **BROIL**.
2. When broiling is finished, turn the **OVEN CONTROL KNOB** to the "OFF" position.

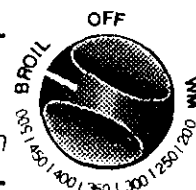



# SELF-CLEANING CYCLE

## PREPARING YOUR OVEN FOR A SELF-CLEAN CYCLE

1. Remove the broiler pan and grid, oven racks, utensils and any foil that may be in the oven.
2. Soil on the front frame, 1" inside the oven, and outside the door gasket will need to be cleaned by hand.

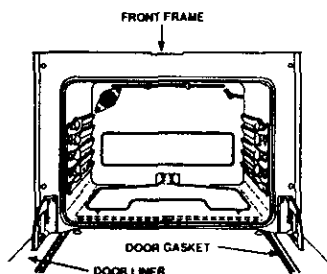

Clean these areas with hot water, soap-filled steel wool pads or cleansers such as Soft Scrub® to remove any soil. Rinse well with clean water and dry.

3. Wipe up any heavy spillovers on the oven bottom.
4. Do not clean the door gasket. The fiberglass material of the oven door gasket cannot withstand abrasion. It is essential for the gasket to remain intact. If you notice it becoming worn, frayed, or displaced on the door, it should be replaced.

## OVEN DOOR GASKET

The door gasket is designed to have a 5-6" gap at the bottom of the door.

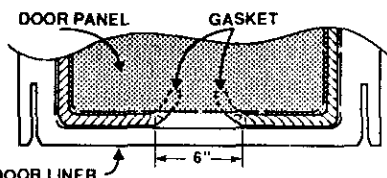

This allows for proper air circulation. It is normal for your oven door to give the appearance of not having a good seal against the range. This is due to the gasket. The location of the gasket on the oven door maintains a good seal and prevents any heat loss.

## WARNING!



**Utensils should never be left in a self-clean cycle.**

**The oven racks may be cleaned during the self-clean cycle, but will lose their luster and become hard to slide. If you choose to leave them in during the cycle, wiping them down with vegetable oil after the cycle will help them slide easier.**

**Always make sure the oven light is off during the self-clean cycle to prolong the life of the bulb.**

**For the first clean cycle, vent the room with an opened window or hood vent. This will prevent the strong odor from heating new parts.**

## THE DOOR LOCK DEVICE

- When the door locks, **LOCK DOOR** and **OVEN ON** indicator lights will glow. The oven temperature will need to drop below the locking temperature before the door can be opened. The **LOCK DOOR**, and **OVEN ON** indicators will blink.
- If the **LOCK DOOR** indicator flashes, the door is not closed completely; simply push the handle to the lock position.

## WALLS OF THE OVEN

Clean only as touch up between clean cycles. Use dishwashing liquid, warm water, or soap-filled steel wool pad. Rinse well after cleaning and dry.

**NEVER USE OVEN CLEANERS IN OR AROUND ANY PART OF THE OVEN.**

When cleaning, be sure not to bend or displace the temperature sensor located on the back wall of the oven.

# SELF-CLEANING CYCLE *continued*

## HOW TO SET A CLEAN CYCLE

1. For best results, follow the steps in **BEFORE A CLEAN CYCLE**.
2. Slide the handle to the right.

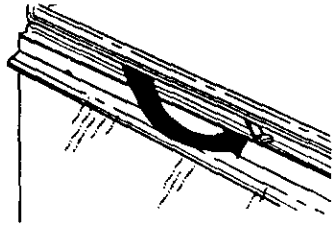

3. Turn the oven control knob to "**CLEAN**". The "**LOCK DOOR**" and "**OVEN ON**" indicator lights will glow.

If you turn the oven control knob to **CLEAN** and forget to lock the door, the "**LOCK DOOR**" indicator light will flash, alerting you to lock the door.

4. The clean cycle lasts 4 hours and 20 minutes. The "**OVEN ON**" and "**LOCK DOOR**" indicator lights will blink at the end of the clean cycle. The oven door cannot be unlocked until the temperature has cooled and the door handle slides easily to the left.
5. After the cycle is finished, turn the oven control knob to the off position and unlock the door.

## TO STOP A CLEAN CYCLE

Turn the oven control knob to the off position. You will need to wait for the oven temperature to drop below the lock temperature (approx. 1 hour) before attempting to open the door. The indicator light will not blink if the cycle is interrupted.

## AFTER THE CYCLE

After the cycle, you may notice some white ash in the oven. Just wipe it up with a damp cloth or sponge.



If white spots remain, scrub them with a soap-filled steel wool pad. Be sure to rinse thoroughly. These are usually deposits of salt that cannot be removed during the cycle.

**If for any reason you are not satisfied with the cleaning results, just repeat the cycle.**

# CLEANING

## GLASS-CERAMIC COOKTOP CLEANING

Cleaning a glass-ceramic cooktop is different from cleaning a standard porcelain cooktop. To maintain and protect your glass-ceramic cooktop follow these basic steps.

### DAILY CLEANING

Use only Cook Top Cleaning Creme® on glass-ceramic.

#### For normal, light soil:

1. Using a damp paper towel, rub a few drops of creme onto soiled area. Wipe until all soil and creme are removed.
2. Clean surface with creme after each cooktop use. Frequent cleaning is essential in preventing scratches and abrasions.

#### For heavy, burned-on soil:

1. Apply a few drops of creme to the cool, soiled area.
2. Using a damp paper towel, rub creme into the burned-on area.
3. Holding a razor scraper at a 30° angle against the ceramic surface, carefully scrape remaining soil.
4. If any soil remains, repeat the steps listed above. For additional protection after soil has been removed, polish the entire surface with creme.



**IMPORTANT:** Using a razor scraper will not damage the surface if the 30° angle is maintained. Do not use a dull or nicked razor blade on your cooktop. Store the razor scraper out of reach of children.

### SPECIAL CARE

Sugar spills (such as jellies, fudge, candy syrups) or melted plastic can cause pitting of the cooktop surface unless the spill is removed while it is still hot. Special care should be taken when removing hot substances.

Follow these instructions carefully and remove soil while spill is hot.

1. Turn off the cooking zone affected by the spill. Remove the utensils.
2. Wearing an oven mitt, hold the razor scraper at a 30° angle against the cooktop and scrape hot spill to a cool area outside the cooking zone.
3. With spill in a cool area, use a dry paper towel to remove any excess soil. Any spill remaining should be left until the surface of the cooktop has cooled. Do not continue to use the soiled cooking zone until all of the spill has been removed. Follow the steps under Heavy Soil to continue the cleaning process.

### GENERAL INFORMATION

As the Creme cleans, it leaves a protective coating that helps prevent buildup or mineral deposits (water spots) and will make future cleaning easier. Dishwashing detergent removes the protective coating and should not be used.

# CLEANING continued

## MORE ON YOUR NEW GLASS-CERAMIC COOKTOP CLEANING

### PRECAUTIONS

- Most cleaners contain ammonia, chemicals and abrasives that damage the surface of your cooktop. Use only the Cooktop Cleaning Creme® for proper cleaning and protection of your ceramic surface.
- If you slide aluminum or copper cookware across the surface of the cooktop, they may leave metal markings which appear as scratches. Use the razor scraper and cooktop creme to remove these marks. Failure to remove this residue immediately may leave permanent marks.
  - If pots with a thin overlay of aluminum, copper or enamel boil dry, bonding with the ceramic surface of the cooktop may occur. This black discoloration should be removed immediately or it could become permanent.
  - Use of window cleaner may leave an iridescent film on the cooktop. Cleaning Creme will remove this film.
  - Water stains (mineral deposits) are removable using the creme or full strength white vinegar.
  - Do not use a dull or nicked razor blade on your cooktop.
  - Do not use abrasive cleaners or abrasive scouring pads on your cooktop.
  - Plastic mesh pads, such as Dobie® may be used.

To order additional Cooktop Cleaning Creme®, call your nearest Sears Service Center or Retail Store, ask for (Stock No. 40079).

### CONTROL PANEL

#### CLEANING MATERIALS TO USE:

- Dishwashing detergent
- Warm water
- Soft cloth

**Do not use abrasive cleaners, industrial cleaners or bleach.**

#### TO CLEAN:

Wipe with soft cloth and warm soapy water. Rinse and dry well.

### BROILER PAN AND GRID

#### CLEANING MATERIALS TO USE:

- Dishwashing detergent
- Warm water
- Soap-filled scouring pad
- Commercial oven cleaner

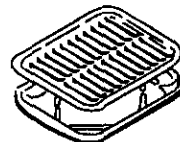

#### TO CLEAN:

Allow the pan to soak. Sprinkle the grid with dishwashing detergent and cover with a damp cloth or paper towel. Rinse and dry well. Scour as needed. You may also place both the pan and grid in the dishwasher.

### PAINTED SURFACES

#### CLEANING MATERIALS TO USE:

- Dishwashing detergent
- Warm water
- Paper towels

#### TO CLEAN

Do not use oven cleaners, cleansing powder, or harsh abrasives. If marinades, tomato sauce, basting materials, etc. should spill, wipe up as much as possible. When surfaces have cooled thoroughly clean painted areas.

# REMOVABLE PARTS

## SURFACE CONTROL KNOBS

### CLEANING MATERIALS TO USE:

- Dishwashing detergent
- Warm water
- Soft cloth

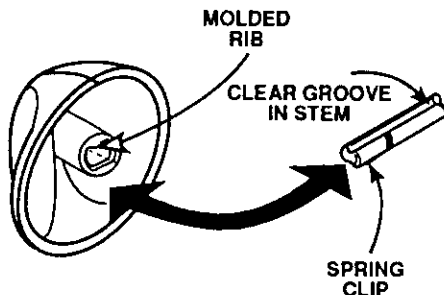

### TO REMOVE:

1. Be sure the control knob is in the off position.
2. Pull straight off the stem. Using a piece of string can make removing the knob easier. Slip the string under and around the knob, pulling straight out.

### TO CLEAN:

Wash the knob thoroughly with soapy water. Dry completely with a soft cloth. **DO NOT let the knob soak.**

### TO REPLACE:

1. Check the back of the knob. The molded rib of the knob is designed to fit perfectly onto the knob stem.
2. Align the molded rib to the clear groove in the knob stem.
3. Push the knob back as far as it will go.

## REPLACING THE OVEN LIGHT BULB



### CAUTION:

Be sure the oven light switch is in the off position. Do not touch a hot light bulb with wet hands or a wet cloth. Wait until the bulb has cooled and use a dry cloth. Never touch the live collar of the bulb. If you are replacing a broken light bulb, make sure the power supply is off.

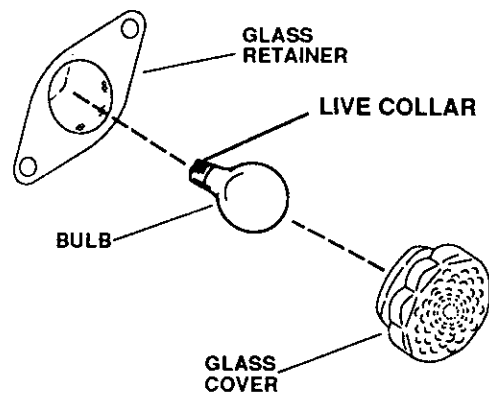

### TO REPLACE:

1. Unscrew glass cover and remove.
2. Unscrew the light blub.
3. Replace the bulb with a 3 1/2" 40 watt appliance bulb.
4. Replace the cover.

# REMOVABLE PARTS *continued*

## REMOVABLE STORAGE DRAWER

### CLEANING MATERIALS TO USE:

- Dishwashing detergent
- Damp cloth
- Warm water

### TO REMOVE:

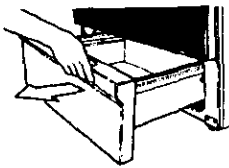

1. Pull the drawer out until it stops.

2. Lift the front of the drawer until the stop guide of the drawer clears the stop guide on the base rail.

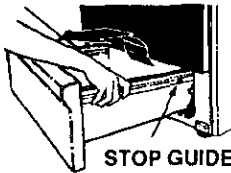

3. Lift the drawer up and over the drawer stop.

### TO CLEAN:

Wipe the inside and outside with warm soapy water and a damp cloth or sponge. Do not use harsh abrasives or scouring pads on the drawer.

### TO REPLACE:

1. Lift the front of the drawer stop and lower the stop of the drawer through the opening of the base rail.
2. Lower the front of the drawer and push back the drawer until it stops.

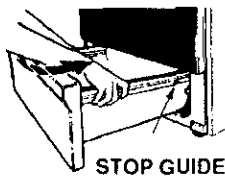

3. Lift up on the front of the drawer until the stop guide of the drawer clears the stop guide of the base rail. Slide the drawer into place.



**CAUTION:** The drawer gives you space for keeping cookware and bakeware.

Plastics and flammable materials should not be kept in this drawer. Do not overload the storage drawer. If the drawer is too heavy, it may slip off the base rail when opened.

# REMOVABLE PARTS *continued*

## REMOVABLE OVEN RACKS

### CLEANING MATERIALS TO USE:

- Dishwashing detergent
- Warm water
- Scouring pad or soap-filled steel wool pad

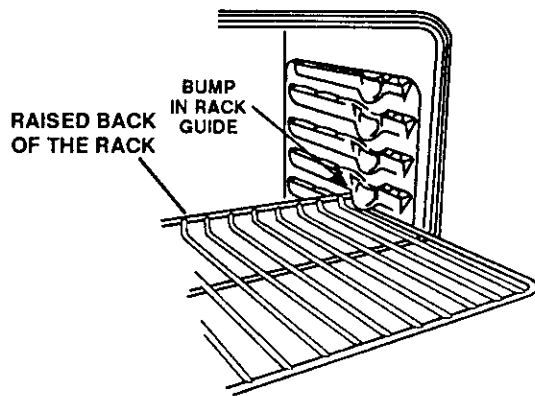

### TO REMOVE:

1. Pull the racks out to the stop lock position.
2. Pull up the front of the rack and slide under the bump of the rack guide.

### TO CLEAN:

Clean with warm water and detergent. For hard to remove stains, gently scrub with a scouring pad or a soap-filled steel wool pad. Rinse well.

### TO REPLACE:

1. Place the raised back of the rack onto the rack guides.
2. Lift the front of the rack until the raised back slides under the bump of the rack guides.
3. Slide the rack all the way back.

## REMOVABLE OVEN DOOR

### BROIL STOP POSITION

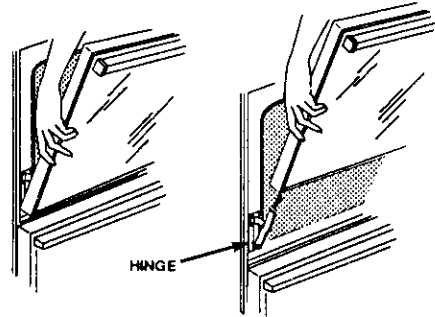

### TO REMOVE:

1. Open the door to the broil stop position.
2. Grasp the door at each side and lift up and off the hinges. **DO NOT LIFT DOOR BY THE HANDLE.**



**CAUTION:** When the door is removed and the hinge arms are at the broil stop position, as a precaution, cover the hinge arms with toweling or an empty paper towel roll. Do not bump or try to move the hinge arms while working in the oven area. They could snap back causing injury to the hands or damage the porcelain finish of the front frame.

### TO REPLACE:

1. Make sure the hinge arms are in the broil stop position.
2. Lift the door by the sides.
3. Line up the slots at the bottom edge of the door with the hinge arms.
4. Slide the door down onto the hinge arms as far as it will go.
5. Close the door.

# BEFORE CALLING FOR SERVICE

To save you time and money, before making a service call check the list below for any problem you may feel you have with the performance of your range. If the problem is something you cannot fix use the Consumer Service Numbers located at the back of this manual. **When making any calls have the Model No., Repair Parts list, Use and Care Manual and the Date of Purchase available.**

PROBLEM	POSSIBLE CAUSE	POSSIBLE SOLUTION
<b>The display of your control is flashing "F" followed by a number or letter.</b>	Range malfunction.	Turn the oven control knob to off. Press the <b>CLOCK</b> pad and the <b>TIMER ON/OFF</b> pad. Let the range cool for 1 hour and place the range back into an oven or cleaning operation. If code repeats call for service.
<b>Tiny scratches or abrasions on the cooktop.</b>	<ul style="list-style-type: none"> <li>a. Use of incorrect cleaning materials.</li> <li>b. Coarse particles (salt, etc.) between cookware bottom and cooking surface.</li> <li>c. Cookware with rough bottoms.</li> </ul>	<ul style="list-style-type: none"> <li>a. Use only Cooktop Cleaning Creme®.</li> <li>b. Make sure the cooktop surface and bottom of cookware are clean before using.</li> <li>c. Use only flat bottomed cookware.</li> </ul>
<b>Metal markings on the cooktop surface (may appear as scratches).</b>	Sliding or scraping metal utensils and cookware across cooktop surface.	Use recommended cleaning procedure to clean the cooktop surface.
<b>Areas of discoloration on the cooktop surface.</b>	Mineral deposits from water or food.	Use recommended cleaning procedure to clean the cooktop surface.
<b>Dark streaks and specks on the cooktop surface.</b>	<ul style="list-style-type: none"> <li>a. Encrusted boilovers or grease spatters.</li> <li>b. Incorrect cleaning materials.</li> </ul>	<ul style="list-style-type: none"> <li>a. Use razor scraper and follow the directions in the cleaning section of this manual.</li> <li>b. Use only the Cooktop Cleaning Creme® on the cooktop surface.</li> </ul>
<b>Oven temperature seems inaccurate.</b>	Thermostat Calibration.	See the temperature adjustments described following this section.
<b>Oven will not unlock.</b>	Clean cycle is not finished.	Oven temperature must drop below the lock temperature before the door will unlock.
<b>Oven light does not work.</b>	<ul style="list-style-type: none"> <li>a. Light switch in off position.</li> <li>b. Oven light bulb burned out.</li> </ul>	<ul style="list-style-type: none"> <li>a. Check switch oven light switch setting.</li> <li>b. Check the oven light bulb.</li> </ul>



## **BEFORE CALLING FOR SERVICE** *continued*

<b>PROBLEM</b>	<b>POSSIBLE CAUSE</b>	<b>POSSIBLE SOLUTION</b>
<b>Foods do not broil properly.</b>	<ul style="list-style-type: none"> <li><b>a.</b> <i>Improper rack position.</i></li> <li><b>b.</b> <i>Oven preheated.</i></li> <li><b>c.</b> <i>Improper use of foil.</i></li> <li><b>d.</b> <i>Oven door closed during broiling.</i></li> <li><b>e.</b> <i>Low voltage (208 volts).</i></li> <li><b>f.</b> <i>Improper broiling time.</i></li> </ul>	<ul style="list-style-type: none"> <li><b>a.</b> <i>Check broil pan placement; see broiling section.</i></li> <li><b>b.</b> <i>Do not preheat when broiling.</i></li> <li><b>c.</b> <i>Check broiling section.</i></li> <li><b>d.</b> <i>Open door to broil stop position.</i></li> <li><b>e.</b> <i>Use higher rack position and/or longer cooking time.</i></li> <li><b>f.</b> <i>Check broiling chart in broiling section.</i></li> </ul>
<b>Oven smokes.</b>	<ul style="list-style-type: none"> <li><b>a.</b> <i>Dirty oven.</i></li> <li><b>b.</b> <i>Improper use of aluminum foil.</i></li> <li><b>c.</b> <i>Broiler pan containing grease left in the oven.</i></li> </ul>	<ul style="list-style-type: none"> <li><b>a.</b> <i>Check for heavy spillover.</i></li> <li><b>b.</b> <i>Do not let foil cover slits in the grid; this will prevent grease drainage.</i></li> <li><b>c.</b> <i>Clean pan and grid after each use.</i></li> </ul>
<b>Cooktop will not work, oven is ok.</b>	<ul style="list-style-type: none"> <li><b>a.</b> <i>Control set improperly.</i></li> </ul>	<ul style="list-style-type: none"> <li><b>a.</b> <i>Push knob in while turning to temperature setting.</i></li> </ul>
<b>Oven will not work, cooktop ok.</b>	<ul style="list-style-type: none"> <li><b>a.</b> <i>Control set improperly.</i></li> <li><b>b.</b> <i>Control knob turned too far past 550°.</i></li> </ul>	<ul style="list-style-type: none"> <li><b>a.</b> <i>Check the control and check oven cooking section.</i></li> <li><b>b.</b> <i>The indicator mark on the knob should align exactly with 550°.</i></li> </ul>
<b>Oven door accidentally locked while baking.</b>	<ul style="list-style-type: none"> <li><b>a.</b> <i>Do not force the lock handle. Temperatures above the locking temperature will prevent the lock handle from sliding to the unlock position.</i></li> </ul>	<ul style="list-style-type: none"> <li><b>a.</b> <i>Turn the control knob to the off position. Allow the oven to cool until the temperature inside drops below the lock temperature and the handle slides easily.</i></li> </ul>
<b>Cleaning results were poor.</b>	<ul style="list-style-type: none"> <li><b>a.</b> <i>Clean cycle interrupted.</i></li> <li><b>b.</b> <i>Oven was heavily soiled.</i></li> </ul>	<ul style="list-style-type: none"> <li><b>a.</b> <i>Allow the oven to clean its full cycle.</i></li> <li><b>b.</b> <i>Heavy spillovers should be cleaned before the cycle is set.</i></li> </ul>

# “DO IT YOURSELF” TEMPERATURE ADJUSTMENT

You may feel that your new oven cooks differently than the oven it replaced. We recommend that you use your new oven a few weeks to become more familiar with it, following the times given in your recipes as a guide.

If you think your new oven is too hot (burning foods) or not hot enough (foods are undercooked) you can adjust the temperature yourself. The appearance and texture of foods is a better indicator of oven accuracy than an oven thermometer, such as those found in grocery stores, to check the temperature setting of your new oven. These thermometers can vary by 20-40 degrees. In addition, the oven door must be opened to read these thermometers. Opening the door will change the temperature of the oven.

To decide how much to change the temperature, set the oven temperature 25 degrees higher (if foods are undercooked) or 25 degrees lower (if foods are burning) than the temperature in your recipe, then bake. The results of this “test” should give you an idea of how much the temperature should be changed.

## TO MAKE THE ADJUSTMENT



HR



1. Press and hold, **at the same time**, the **HOUR UP** and **DOWN** arrow pads until the display shows a two digit number.
2. Press the **HOUR UP** arrow pad to increase the temperature up to +35°F hotter.  
**or**  
Press the **HOUR DOWN** arrow pad to decrease the temperature down to -35°F cooler.
3. When this adjustment has been made the display will return to the time of day.

This adjustment will remain in memory until these steps are repeated and a new temperature is selected. It will remain in memory even after a power failure.

This adjustment will not affect the Broil or Clean temperatures.

For the repair or replacement parts you need  
delivered directly to your home

Call 7 am - 7 pm, 7 days a week

**1-800-366-PART**

(1-800-366-7278)

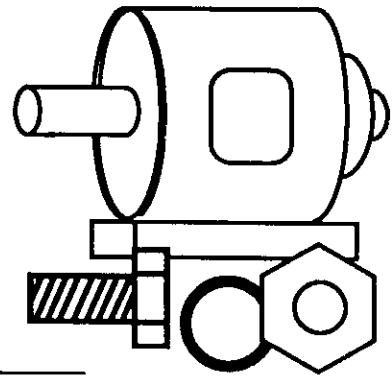

For in-home major brand repair service

Call 24 hours a day, 7 days a week

**1-800-4-REPAIR**

(1-800-473-7247)

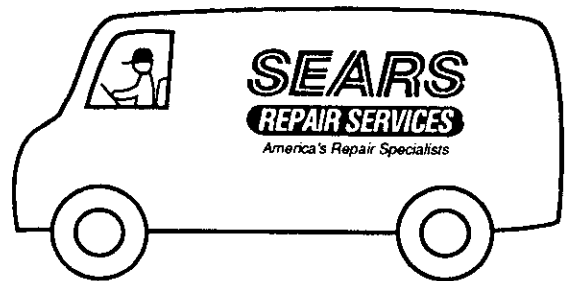

For the location of a  
Sears parts and Repair Center in your area

Call 24 hours a day, 7 days a week

**1-800-488-1222**

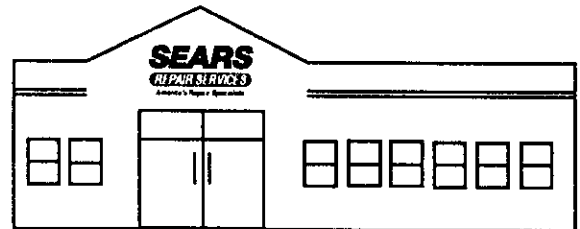

For information on purchasing a Sears  
Maintenance Agreement or to inquire  
about an existing Agreement

Call 9 am - 5 pm, Monday-Saturday

**1-800-827-6655**



**SEARS**  
**REPAIR SERVICES**

*America's Repair Specialists*

# KENMORE ELECTRIC RANGE WARRANTY

Dear Customer:

Our constant efforts are directed toward making sure your new Kenmore Range will arrive at your home in perfect condition and will give you proper performance. As part of these efforts, we feel it is our responsibility to provide you with this warranty for your range.



## FULL ONE YEAR WARRANTY ON THE FUNCTIONING OF ALL PARTS EXCEPT GLASS PARTS

If, within one year from the date of installation, any part, other than a glass part, fails to function properly due to a defect in material or workmanship, Sears will repair or replace it, free of charge.

## FULL 30-DAY WARRANTY ON GLASS PARTS AND FINISH OF PORCELAIN ENAMEL, PAINTED OR BRIGHT METAL FINISHED PARTS

If, within 30 days from the date of installation, any glass part or the finish on any porcelain enamel, painted or bright metal part is defective in material or workmanship, Sears will replace the part, free of charge.

## FULL 90-DAY WARRANTY ON MECHANICAL ADJUSTMENTS

For 90 days from the date of installation, Sears will provide, free of charge, any mechanical adjustments necessary for proper operation of the range, except for normal maintenance.

If the range is subjected to other than private family use, the above warranty coverage is effective for only 90 days.

## WARRANTY SERVICE IS AVAILABLE BY CONTACTING THE NEAREST SEARS SERVICE CENTER/DEPARTMENT IN THE UNITED STATES

This warranty applies only while this product is in use in the United States. This warranty gives you specific legal rights, and you may also have other rights which vary from state to state.

**SEARS, ROEBUCK and CO.**  
Dept. 817 WA  
Hoffman Estates, IL 60179

## WE SERVICE WHAT WE SELL

"We Service What We Sell" is our assurance to you that you can depend on Sears for service because Sears service is nationwide.

Your Kenmore Range has added value when you consider that Sears has a service unit near you staffed by Sears trained technicians... professional technicians specifically trained on Sears appliances, having the parts, tools and equipment to ensure that we meet our pledge to you — "We Service What We Sell!"

### TO FURTHER ADD TO THE VALUE OF YOUR RANGE, BUY A SEARS MAINTENANCE AGREEMENT.

Kenmore Ranges are designed, manufactured and tested for years of dependable operation. Yet, any modern appliance may require service from time to time. The Sears Warranty plus the Sears Maintenance Agreement provides protection from unexpected repair bills and assures you of enjoying maximum range efficiency.

Here's a comparative warranty and Maintenance Agreement chart showing you the benefits of a Sears Range Maintenance Agreement.

Years of Ownership Coverage		1st Year	2nd Year	3rd Year
1	Replacement of Defective Parts other than Porcelain or Glass	W	MA	MA
2	Mechanical Adjustment	90 DAYS W	MA	MA
3	Porcelain and Glass Parts	30 DAYS W	MA	MA
4	Annual Preventive Maintenance Check at your request	MA	MA	MA

W - Warranty MA - Maintenance Agreement

CONTACT YOUR SEARS SALESPERSON OR LOCAL SEARS SERVICE CENTER TODAY AND PURCHASE A SEARS MAINTENANCE AGREEMENT.

# Kenmore® America's Best Selling Appliance Brand

Sold by SEARS, ROEBUCK AND CO., Hoffman Estates, IL 60179

— Printed in the United States —

## Free Manuals Download Website

<http://myh66.com>

<http://usermanuals.us>

<http://www.somanuals.com>

<http://www.4manuals.cc>

<http://www.manual-lib.com>

<http://www.404manual.com>

<http://www.luxmanual.com>

<http://aubethermostatmanual.com>

Golf course search by state

<http://golfingnear.com>

Email search by domain

<http://emailbydomain.com>

Auto manuals search

<http://auto.somanuals.com>

TV manuals search

<http://tv.somanuals.com>