

SUZUKI

Pianos

DIGITAL PIANOS

HP-8

HP-88F

HP-8F

HP-95

HP-9

HP-105W

HP-10

HP-11



OWNER'S MANUAL

SUZUKI

WELCOME!

We would like to express our appreciation and congratulate you for purchasing this Suzuki digital piano. This piano has been designed to provide you with years of musical enjoyment. State of the art electronics combined with an elegant black lacquer upright cabinet, add beauty and sophistication to any home environment. Some of the features your new piano is equipped with include:

- * weighted, hammer action keyboard for an authentic acoustic piano feel
- * a dynamic sound delivery system with EQ controls
- * twelve realistic sampled keyboard voices with a stereo grand piano voice
- * two track sequencer/music recorder
- * built in metronome with range from 40 to 240 BPM
- * digital effects to further enhance the keyboard voices
- * transpose function that allows play in any piano key
- * complete MIDI controls



You will find many more features and functions listed within this owners manual. This digital piano also has the latest MIDI features that allow you to interface with your personal computer or other MIDI equipment for endless musical possibilities.



In order to fully appreciate all the unique features of this digital piano, please take a few minutes to read the following pages of instruction and precaution. We'll cover assembly, the function of each control button, warranty information and general precautions. Thank you again and congratulations for choosing this digital piano package from the Suzuki Keyboard Product Line of portable keyboards, home digital pianos and ensembles, plus the elegant digital grand ensemble.

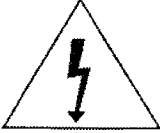

GENERAL PRECAUTIONS

	CAUTION RISK OF ELECTRIC SHOCK DO NOT OPEN	
CAUTION: TO REDUCE THE RISK OF ELECTRIC SHOCK, DO NOT REMOVE COVER (OR BACK) NO USER-SERVICEABLE PARTS INSIDE REFER SERVICING TO QUALIFIED SERVICE PERSONNEL		

INSTRUCTIONS PERTAINING TO A RISK OF FIRE, ELECTRIC SHOCK, OR INJURY:

The lightning flash with arrowhead symbol, within an equilateral triangle, is intended to alert the user to the presence of uninsulated "dangerous voltage" within the product's enclosure that may be of sufficient magnitude to constitute a risk of electric shock to persons.

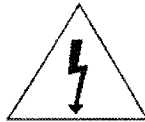

The exclamation point within an equilateral triangle is intended to alert the user to the presence of important operating and maintenance (servicing) instructions in the instruction manual accompanying the product.



- 1. CAUTION:** Any changes or modification in construction of this device which are not expressly approved by the party responsible for compliance could void the user's authority to operate the equipment.
- 2. NOTE:** This equipment has been tested and found to comply with the limit for a Class A digital device, pursuant to part 15 of the FCC rules. These limits are designed to provide reasonable protection against harmful interference when the equipment is operated in a non-commercial environment. This equipment generates, uses, and can radiate radio frequency energy and if not installed and used in accordance with the instruction manual, may cause harmful interference to radio communications. Operation of this equipment in a residential area is likely to cause harmful interference in which case the user will be required to correct the interference at his own expense.

TAKING CARE OF YOUR DIGITAL PIANO

This Suzuki digital piano will supply you with years of musical enjoyment if you follow the simple rules listed below:

LOCATION

Do not expose the instrument to the following conditions to avoid deformation, discoloration, or more serious damage.

- ◆ Direct sunlight (e.g. near a window).
- ◆ High temperatures (e.g. near a heat source, outside, or in a car during the daytime)
- ◆ Excessive humidity.
- ◆ Excessive dust.
- ◆ Strong vibration.

AC POWER CORD

- ◆ Turn the power switch off when the instrument is not in use.
- ◆ Unplug the AC power cord during an electrical storm.
- ◆ Avoid plugging the AC adaptor into the same AC outlet as appliances with high power consumption, such as electric heaters or ovens.

TURN POWER OFF WHEN MAKING CONNECTIONS

- ◆ To avoid damage to the instrument and other devices to which it is connected, turn the power switches of all related devices off prior to connecting or disconnecting MIDI cable.

HANDLING AND TRANSPORT

- ◆ Never apply excessive force to the controls, connectors or other parts of the instrument.
- ◆ Always unplug cables by gripping the plug firmly, not by pulling on the cable.
- ◆ Disconnect all cables before moving the instrument.
- ◆ Physical shocks caused by dropping, bumping, or placing heavy objects on the instrument can result in scratches and more serious damage.

CLEANING

- ◆ Clean the cabinet and panel with a dry soft cloth. A waxed based polish may be used on the cabinet, although you will find that rubbing with a soft cloth will usually suffice. **Do not use thinner's or petro-chemical-based polishes.**
- ◆ Avoid placing vinyl objects on top of the instrument (vinyl can stick to and discolor the surface).
- ◆ To maintain the luster of the keys and buttons wipe with a clean, lightly dampened cloth, and then polish with a soft dry cloth.

ELECTRICAL INTERFERENCE

- ◆ This instrument contains digital circuitry and may, cause interference if placed too close to radio or television receivers. If this occurs, move the instrument further away from the affected equipment.
- ◆ Do not switch the unit on and off in quick succession, as this places an undue load on the electronic components

SERVICE AND MODIFICATION

- ◆ Opening and tampering with the Digital Piano can lead to irreparable damage. Please call the local music dealer or factory before attempting to service or modify this instrument.

CONTENTS

EASY SET AND QUICK PLAY GUIDE

Easy set up and quick play steps page.....	6
HP-8 and HP-9 Assembly	7
HP-10 Assembly.....	8
Quick play guide.....	13

BASIC FUNCTIONS

Panel Controls.....	14
Demo	17
Digital Effects (Reverb/Chorus)	17
Split Feature.....	19
Dual Feature	20
Transpose.....	20
Lesson.....	21
Value Buttons.....	22
Metronome	23

RECORDING ON THIS SUZUKI PIANO

Music recorder.....	24
---------------------	----

FUNCTION CONTROLS

Touch Sensitivity	26
Tuning.....	27

MIDI FUNCTIONS AND FEATURES

What is MIDI?.....	28
Basic MIDI set ups.....	29
Setting the various functions.....	30
MIDI Implementation Chart.....	33

BACK PANEL AND CONNECTORS AND CONTROLS ...

PEDALS

SPECIFICATIONS.....

WARRANTY.....

ACCESSORIES.....

EASY SET UP AND QUICK PLAY

EASY SET UP AND QUICK PLAY IN FOUR SIMPLE STEPS

1

**CHECK THE
PACKAGE
CONTENTS**

2

**ASSEMBLE THE
PIANO STAND**

3

**PLACE THE PIANO
ON IT'S STAND
AND PLUG THE
AC CORD INTO
THE AC OUTLET**

4

**TURN THE POWER
SWITCH ON,
ADJUST THE
VOLUME AND
BEGIN TO PLAY**

HP-8 & HP-9 ASSEMBLY

1 MAKE SURE THAT YOUR PACKAGE CONTAINS THE FOLLOWING ITEMS:

- 1. PIANO
- 2. MUSIC RACK
- 3. RIGHT PIANO STAND LEG
- 4. LEFT PIANO STAND LEG
- 5. CROSSPIECE
- 6. PEDAL BOARD

- 7. OWNERS MANUAL
- 8. AC POWER CORD
- 9. CROSSPIECE SCREWS (4)
- 10. LEG SCREWS (4)
- 11. LEG SCREW COVERS (4)
- 12. HAND BOLTS (4)

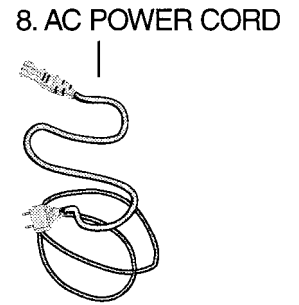
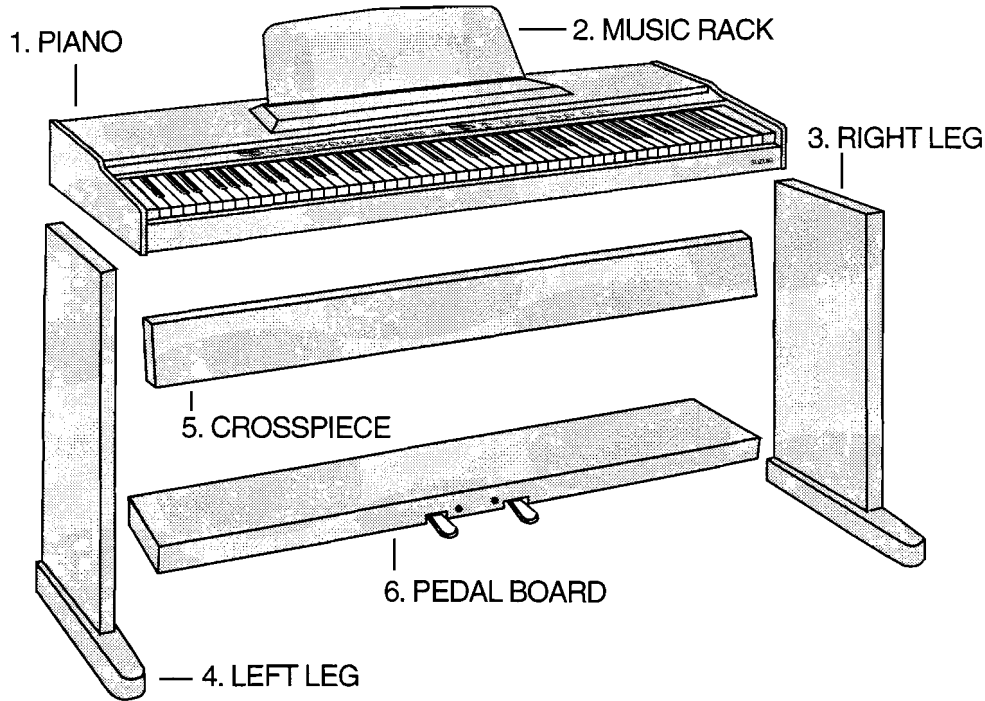
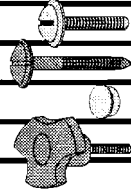

2 ASSEMBLE THE PIANO STAND AS SHOWN BELOW

The complete assembly is shown below. Please follow steps A-C to the piano assembly.

9. CROSSPIECE SCREWS

10. LEG SCREWS

11. LEG SCREW COVERS

12. HAND BOLTS

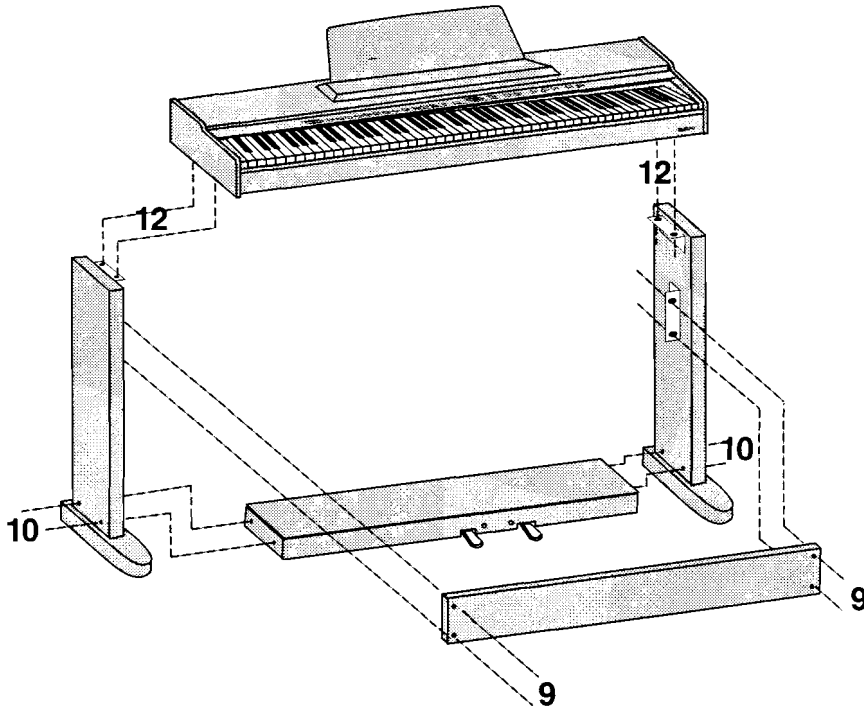
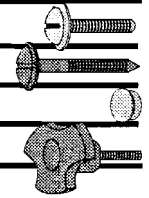

A)

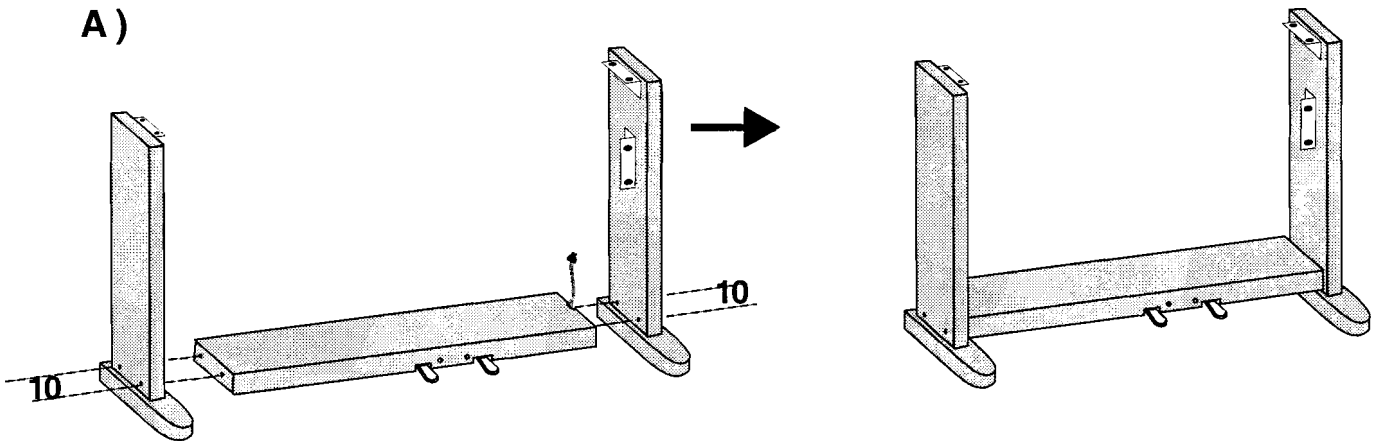

DO ALL YOUR FINAL TIGHTENING ONLY AFTER THE ASSEMBLY PROCEDURE HAS BEEN COMPLETED.

2 ASSEMBLE THE PIANO STAND AS SHOWN BELOW (CONTINUED)

DO ALL YOUR FINAL TIGHTENING ONLY AFTER THE ASSEMBLY PROCEDURE HAS BEEN COMPLETED.

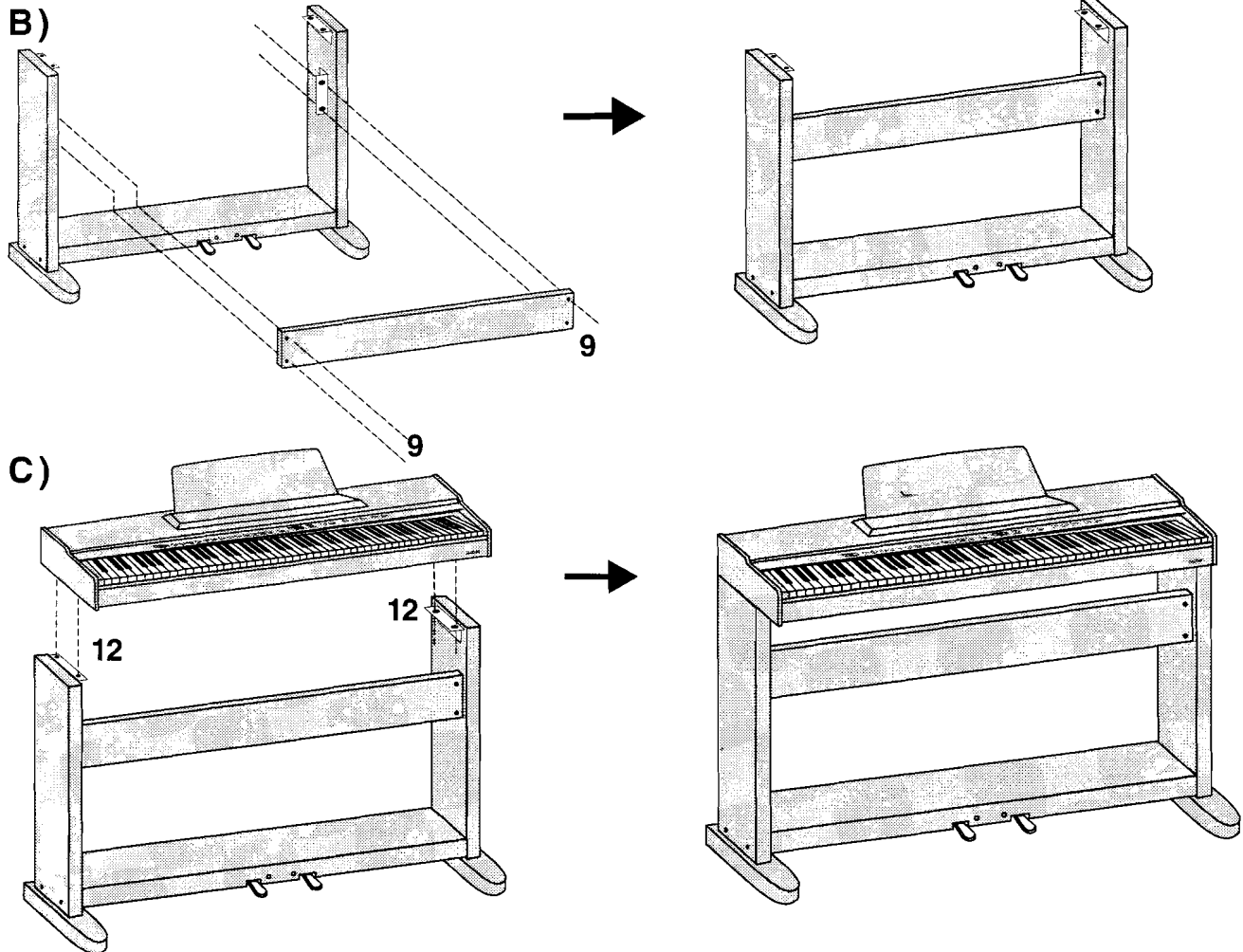

YOU MAY NOW DO YOUR FINAL TIGHTENING ON THE PIANO STAND AND PLACE THE SCREW CAPS WHERE NEEDED.



ON THE BOTTOM RIGHT PORTION OF THE PIANO, PLUG THE PEDAL CABLE INTO ITS RECEPTACLE. (THE PLUG CAN ONLY BE INSERTED ONE WAY, MAKE SURE IT IS PROPERLY ALIGNED BEFORE INSERTION.)

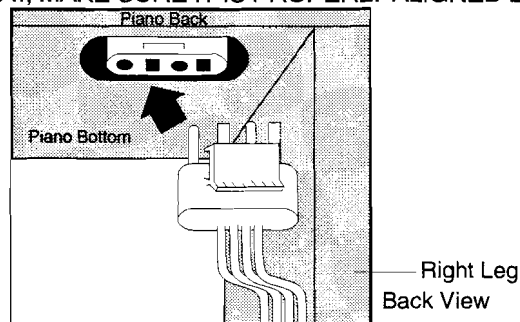





HP-10 ASSEMBLY

1 MAKE SURE THAT YOUR PACKAGE CONTAINS THE FOLLOWING ITEMS:

PARTS LIST

Please make sure you have all the parts prior to assembly.

1. PIANO	7. CRSPSC & PANEL SCREWS	PIECES	
2. PEDAL ASSEMBLY	8. LEG SCREWS	4 PIECES	
3. RIGHT STAND LEG	9. BACK PANEL SKIRT		
4. LEFT STAND LEG	10. LEG SCREW COVERS	4 PIECES	
5. HORIZONTAL SUPPORT	11. HAND BOLTS	4 PIECES	
6. POWER CORD (not shown)			

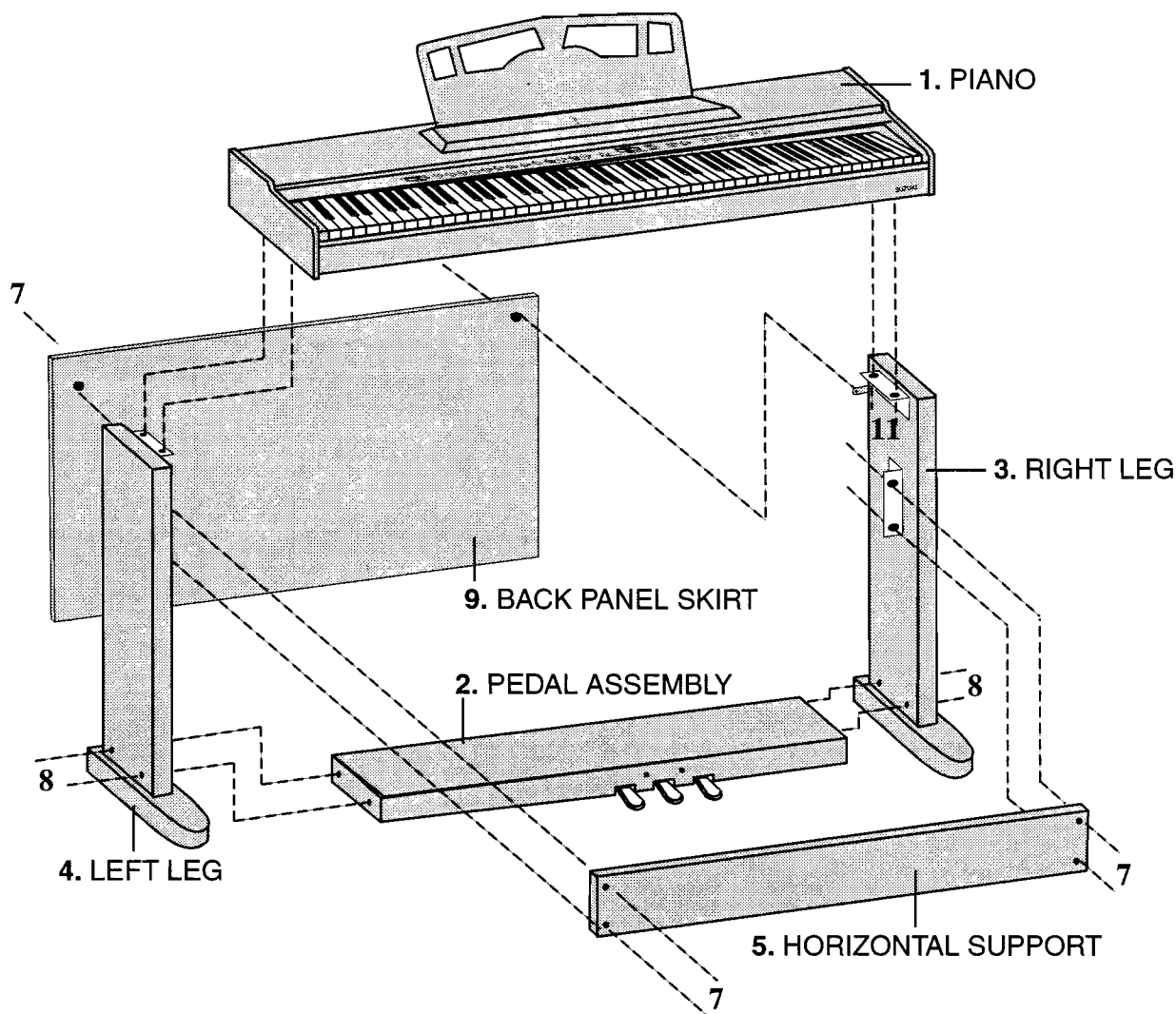

2 ASSEMBLE THE PIANO STAND AS SHOWN BELOW

Follow steps A-C to complete piano assembly.

A) Attach the horizontal pedal assembly, to the two legs.

Use the four pedal assembly screws (#8) located in the pedal assembly crosspiece itself

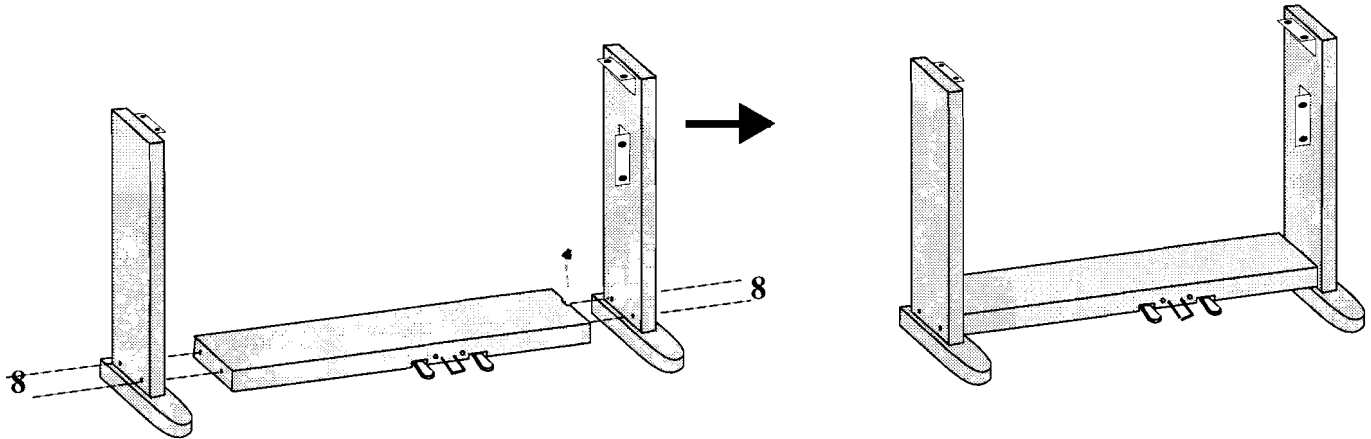

DO ALL YOUR FINAL TIGHTENING ONLY AFTER THE ASSEMBLY PROCEDURE HAS BEEN COMPLETED.

B) Assemble the Horizontal Support board to both right and left legs . Use the four Crspsc. & Panel screws (#8).

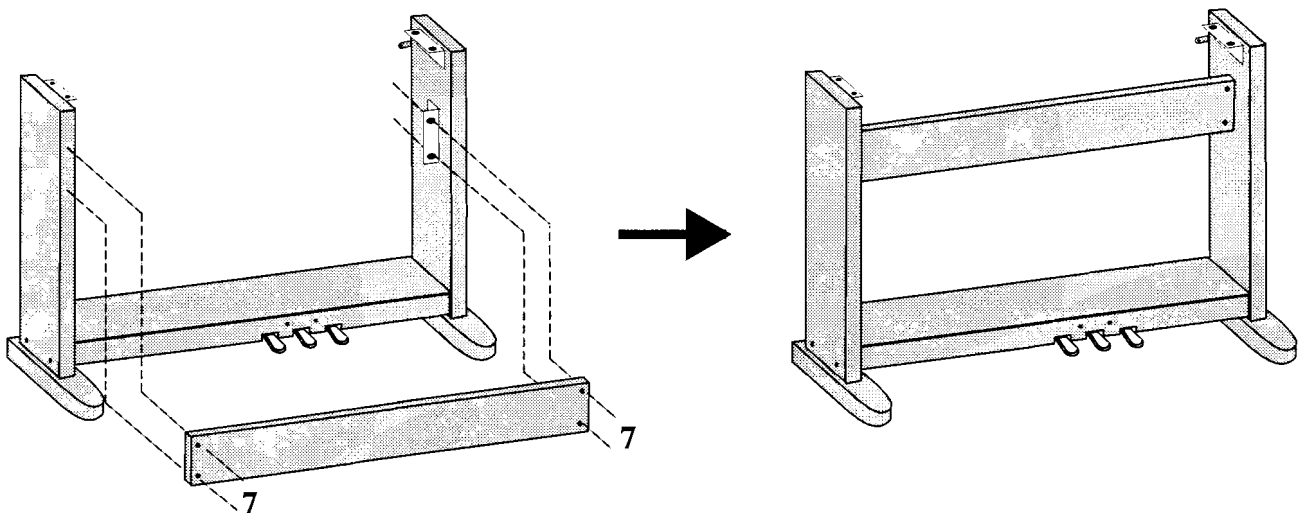

DO ALL YOUR FINAL TIGHTENING ONLY AFTER THE ASSEMBLY PROCEDURE HAS BEEN COMPLETED.

2 ASSEMBLE THE PIANO STAND AS SHOWN BELOW (continued)

C) Attach the Back Panel Skirt (#9) to the piano legs as shown below with Crspsc & Panel Screws (#7).

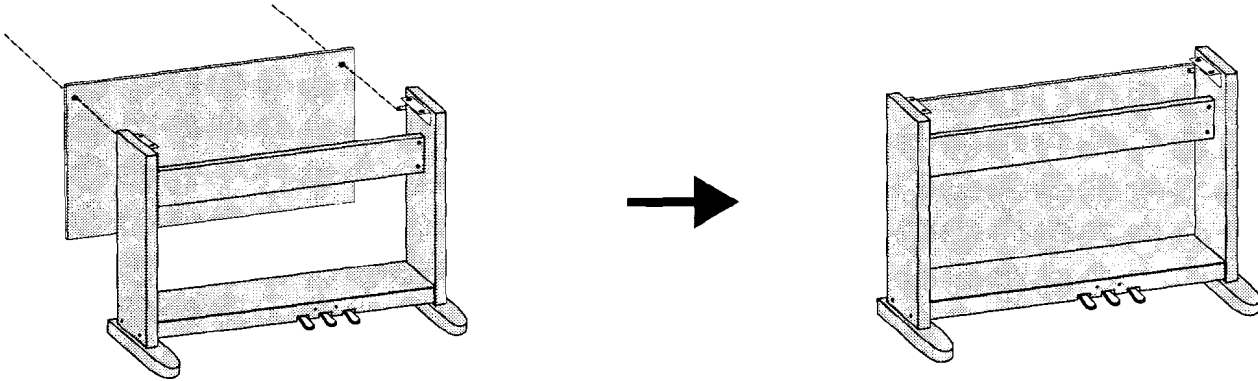

3 ASSEMBLE THE PIANO STAND AS SHOWN BELOW

Attach the piano to the stand using the four hand bolts (#11). Position the Music Stand into the upright position.

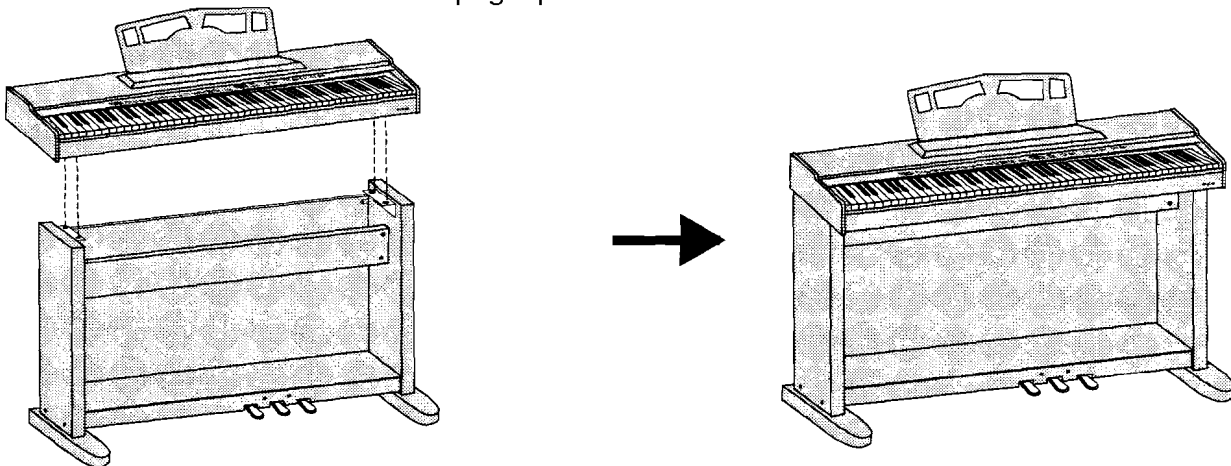

Plug the Pedal cable (located under the Pedal Assembly #2) into its receptacle on the bottom of This Suzuki Piano

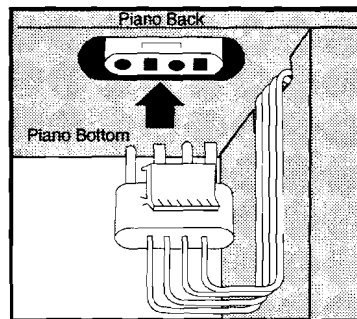

The Pedal Cable can only be inserted one way. Please make sure that it is properly aligned before you insert it. The Pedal Cable travels up the back of the leg, not in the center of the leg as shown.



You may now tighten all the piano assembly hardware and insert the leg screw covers (#10) on the outside of each leg.

QUICK PLAY

After following steps one and two listed for assembly procedures continue with steps 3 and 4.

3 PLUG THE AC CORD INTO THE PIANO AND THEN INTO THE NEAREST POWER OUTLET (CONTINUED)

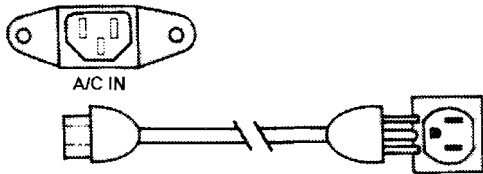

Plug the A/C power cord into the receptacle jack located on the bottom back left portion of the piano.

HEADPHONE JACKS



You can play in total silence without disturbing other in the same room by plugging a set of headphones into one of the appropriate sockets, located directly under the keyboard on the left side of the instrument. Two sets of headphones may be used.

4 TURN THE POWER SWITCH ON, SET THE VOLUME AND BRILLIANCE CONTROLS TO YOUR DESIRED SETTING AND BEGIN TO PLAY

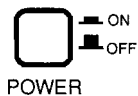

1 Turn on the power switch located on left portion of the control panel. The LED above the Piano 1 voice will turn on. Adjust the volume control to a comfortable level.



2 You can adjust the Brilliance control on the control panel to change the tone of your selected instruments.

LOCATED ON THE BACK PANEL OF THIS PIANO



There are additional Bass and Treble controls on the back panel of the piano. These EQ knobs offer the user even more control of the over all tone quality from the piano's sound delivery system.

NOTE: Depending on the instrument voice(s) selected and the setting of the Bass and Treble controls, it is possible to overdrive sound delivery system. If this happens adjust your selected tone contrls to a proper setting.

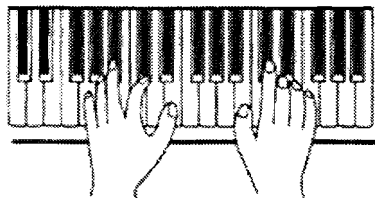

3 Begin to play the piano.

PANEL CONTROLS

This Suzuki Piano's control panel is simple and elegant. The following is a brief description of all the features located on the control panel.

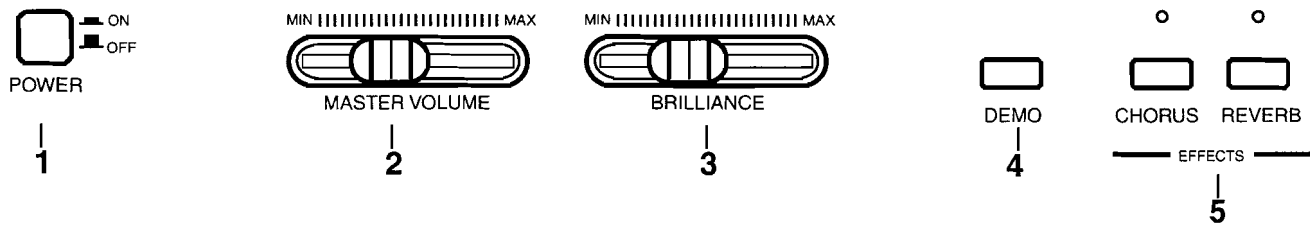

LEFT PORTION OF THE CONTROL PANEL

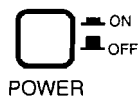

POWER



MASTER VOLUME



BRILLIANCE



DEMO

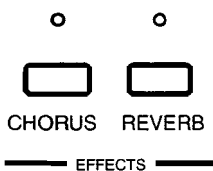

CHORUS REVERB

EFFECTS

- 1** Press the ON/OFF switch to turn the power on and off. When you turn the power off, do not turn the power back on immediately. Wait at least 5 seconds to turn the power back on so that the circuit can be properly reset.
- 2** This sliding control button simply adjusts the overall volume of the selected keyboard voice(s).
- 3** The Brilliance control will adjust the overall tone of the piano. To make the selected keyboard voice brighter move the Brilliance slider control to the right. To add bass to the selected keyboard voice move the Brilliance slider control to the left. There are also Bass and Treble controls on the back panel of this piano.
- 4** There are thirteen different demonstration songs that can be selected by pressing the individual instrument voice buttons. Each song offers a musical passage in the selected instrument voice's style.
Press the Demo button to start or stop the demo songs from playing.
- 5** This Suzuki Piano features an on board digital signal processor (DSP) that can add realism and presence to your selected keyboard sound. Two types of effects are offered: Reverb and Chorus. Reverb simulates the effect of playing in a big room or hall where the sound reverberates off the walls and ceiling. The Chorus effect adds depth and spaciousness to the selected keyboard voice.
The Value Up arrow and Down arrow buttons allow you to control the amount of Reverb and Chorus you apply to the selected instrument voice. (See #12)

PANEL CONTROLS

(CONTINUED)

The following is a brief description of all the features located on the control panel (continued).

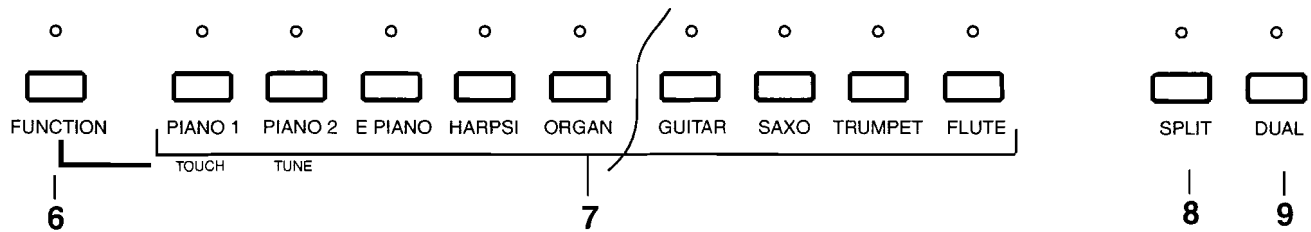

MIDDLE PORTION OF THE CONTROL PANEL

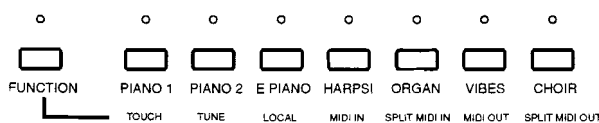

6 The function button toggles the Function LED on and off. When selected the first seven instrument voice buttons can be used to access the Touch Sensitivity of the piano, the Tuning of the piano and the MIDI configuration of the piano. When the Function button is engaged you can not select another instrument voice.

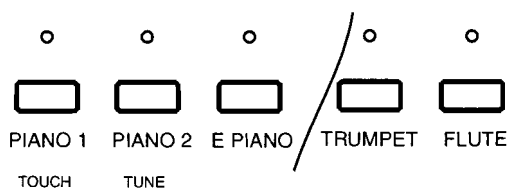

7 This Suzuki Piano contains thirteen digitally sampled instrument voices. When the piano is first turned on, the Piano 1 voice is automatically selected as indicated by the LED above the button being lit. To select a different voice simply press the desired instrument voice button that you would like to hear (only five of the 13 voice buttons are shown).



8 The Split function allows the player the opportunity to divide the keyboard into two instrument voice sections. You may select an instrument voice for the lower and the upper sections of the 88 note piano.



9 The Dual button (or voice layering function) allows the user to combine or mix any two of the thirteen instrument voices. You may increase or decrease one of the two layered voices by using the Up and Down Value buttons.

PANEL CONTROLS

(CONTINUED)

The following is a brief description of all the features located on the control panel (continued).

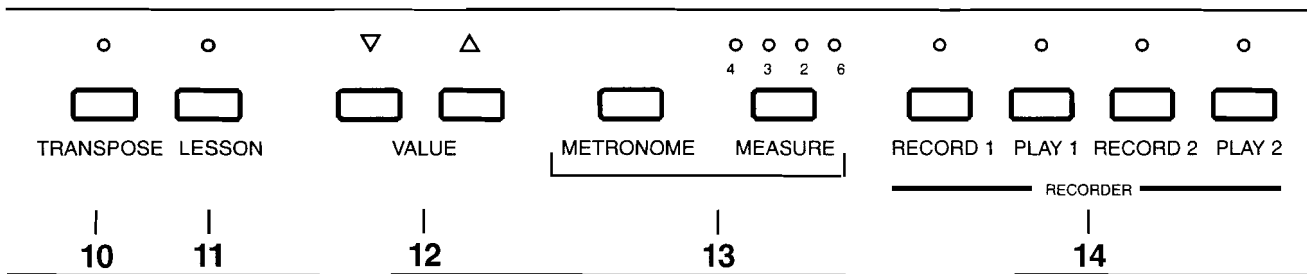

RIGHT PORTION OF THE CONTROL PANEL

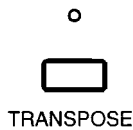

10 The transposition feature allows the user to transpose or change the overall pitch of the piano to the key of your choice.

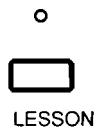

11 This button actually splits the 88 note piano into 2 44 note pianos. This is useful for instruction or if the users would like to perform a duet on the piano. The split point occurs at the F above Middle C.

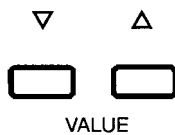

12 These Up or Down Value buttons are to adjust a variety of functions or parameters. For example, depth control of the Reverb and Chorus, volume for single voices on the Split and Dual functions, Tempo adjust, and control function buttons utilize the Value buttons to change parameters.

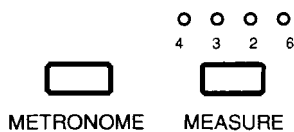

13 This piano's built-in Metronome aids with practice or performance. The tempo range is from 40 to 240 BPM and adjusted via the Value buttons. The Measure button selects the Meter of your choice (4/4, 3/4, 2/4, 6/8, or fixed).

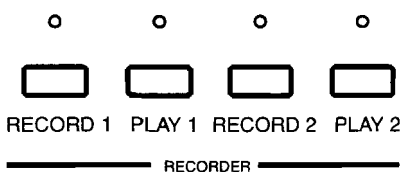

14 The Music Recorder buttons on this piano feature a built-in two track real-time sequencer. This allows the user to record up to two musical passages and then listen to the playback simultaneously. It operates much like a built-in two track tape recorder.

BASIC OPERATION

The following instructions explain the easy to use features of this Suzuki Digital Piano.

DEMO

This piano offers 13 different demonstration songs that are designed to showcase the different sampled voices that are available.

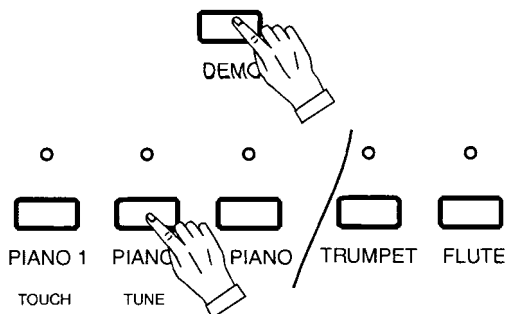

1 Press the Demo button. The Piano 1 LED will begin to flash and the Piano 1 demo song will begin to play.

2 Press the instrument voice button that you would like to hear a demonstration song for, or just let the piano sequence through all the demonstration songs. Press the Demo button again to turn the Demonstration song feature off.

EFFECTS

The digital effects offer the user added realism and presence to the selected keyboard voice.

This Suzuki Piano offers two types of digital effects: Reverb and Chorus

The Reverb effect gives the impression of playing in a big room or hall where the sound reverberates or bounces off the walls and ceiling.

TO ENGAGE THE REVERB EFFECT UPON THE SELECTED KEYBOARD VOICE

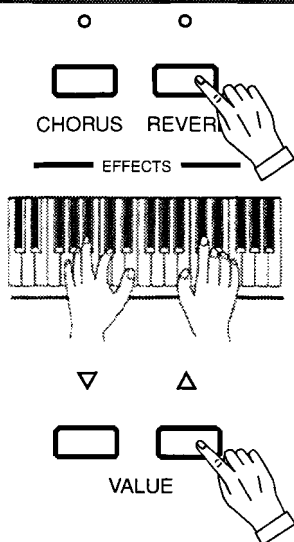

1 With the Piano 1 voice selected, press the Reverb button. The Reverb LED will turn on. Play the piano keys and you will hear the Reverb effect.

2 To increase the Reverb effect press the up Value button at least five times to hear a large increase in the Reverb effect. To reduce the Reverb depth press the down Value button at least five times.



The Up or Down Value buttons for the Reverb and Chorus effects increase or decrease the amount of these effects in small increments so that the user can customize their sound with precision. It is advised that if you want to moderately adjust the selected effect that you press the Value button a minimum of five times.

BASIC OPERATION

EFFECTS

The **CHORUS** effect offers varying degrees of rate, depth, phase and delay settings. The chorus can particularly enrich the sounds of Strings, Electric Piano, Organ and Vibes. Experiment with the various effects on different voices so that you discover your most desirable settings.

TO ENGAGE THE CHORUS EFFECT UPON THE SELECTED KEYBOARD VOICE

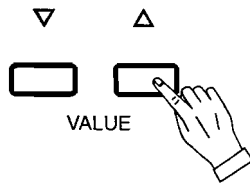
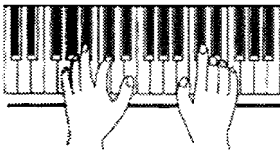
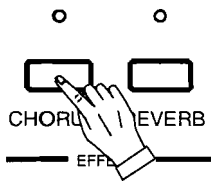

The Chorus operates exactly like the Reverb explained on the previous page.

- 1** With the Vibes button selected, the Chorus button should be automatically selected. Play the piano keys and will hear the Chorus effect.
- 2** To increase the Chorus effect press the Up Value button at least five times to hear a large noticeable difference in the Chorus effect.

The Up or Down Value buttons for the Reverb and Chorus effects increase or decrease the amount of these effects in small increments so that the user can customize their sound with precision. It is advised that if you want to moderately adjust the selected effect that you press the Value button a minimum of five times.

NOTE:

If you engage the Reverb or Chorus for an instrument voice and/or alter the depth of the effect it will be saved for that particular voice, until the power is turned off or until the digital effect settings for that particular voice has been once again altered.

This time saving memory feature is so the user doesn't have to re-configure digital effect settings every time the instrument's voice is changed.



If you press the Up and Down Value buttons at the same time the digital effects settings for the selected instrument voice will be reset to its original default (power up) setting.

SPLIT

The Split function will divide the keyboard into two separate sections. You may select a different keyboard voice for each section.

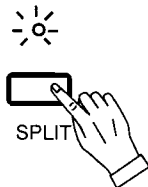

- 1 Assign a voice to the left of the Split point by pressing the keyboard voice select button of your choice. Press the Split button (the LED above the button will blink).

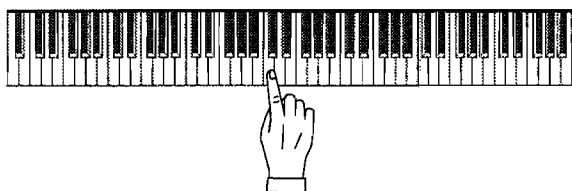

- 2 Press the piano key at the note you would like to split the keyboard (for our example we are choosing Middle C key (C4)). The LED above the Split button will stop blinking but remain lit.

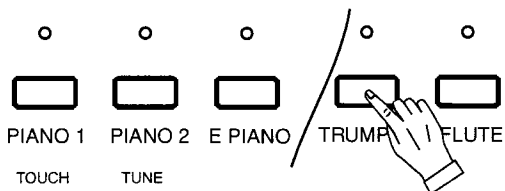

- 3 Assign a voice to the right of the Split point by Pressing the keyboard voice select button of your choice (two voice selection LED's should now be lit).

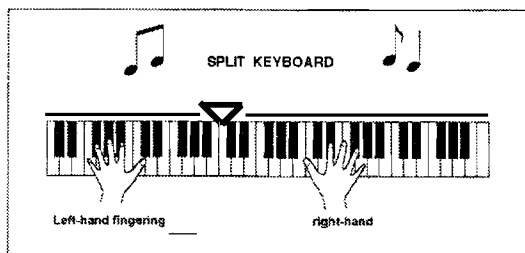

- 4 The keys should now sound with the voices selected for both the Upper and Lower sections of the piano. For our example the Split point is set at the Middle C key (C4), therefore all keys played to the left of that key (B3 on down) will sound in a different keyboard voice.

NOTE:

All notes to the left of the Split point automatically shift up one octave so that the user will have more playable notes in the low end of the keyboard. Therefore one octave to the left of the Split point will play the same notes as the octave to the Right of the Split point.

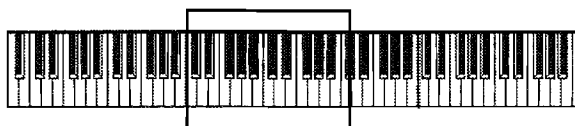

Example, if Middle C is the Split point the keys indicated in the box will play the same notes.

To disengage the Split keyboard function, press the Split button (the LED will turn off). All eighty-eight keys will now resume to the standard play mode with a single voice for all keys.



The keyboard voice that was already engaged when you pressed the Split button will automatically be assigned to the keyboard section to the left of the Split point.

DUAL

This feature allows the user to combine, layer or mix two separate instrument voices to play at the same time across the entire keyboard range.

1 Press the Dual button and its LED will light.

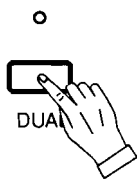

2 Select the two desired voice selection buttons, their LED's will turn on. Now when the keys are played you should be able to hear a mixture of both instrument voices.

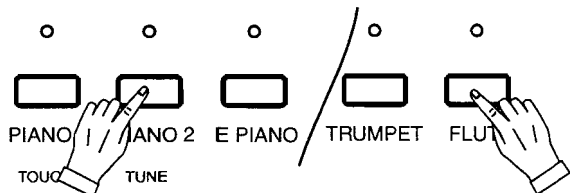

To disengage the Dual function, press the Dual button (the LED will turn off). All eighty-eight keys will now play with a single instrument voice.

NOTE:

BALANCING THE VOLUMES OF THE LAYERED VOICES.

To increase one of the layered instrument voices volume, tap on that instruments' voice button.

The selected instrument voice will increase in volume each time you press or tap it's instrument voice button (max. volume is reached after five taps).

In our example we are increasing the volume of the Flute voice in the Dual mode.

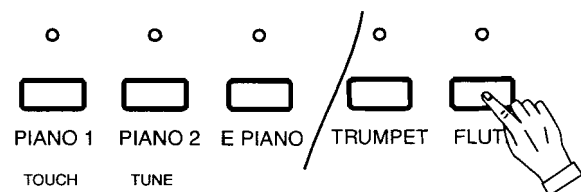

TRANSPOSE

The Transpose feature is designed to make it easier to play difficult key signatures by adjusting the keyboard to play in the key that you are familiar with.

With the Transpose function engaged the Up Value button can raise the pitch of the piano in semitone steps (+6) and the Down Value button can lower the pitch (-5).

1 Press the Transpose button. The LED above the button will turn on.

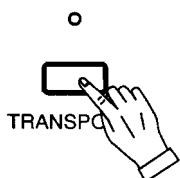

(Continued on next page)

TRANSCOPE

(Continued)

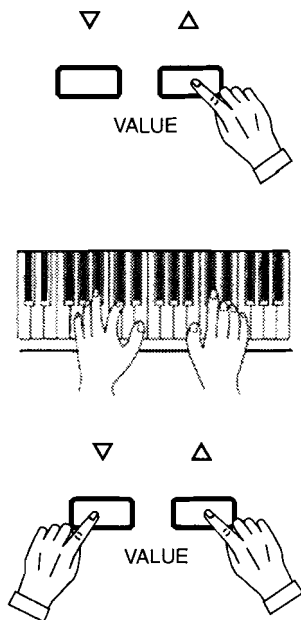

- 2** Press the Up Value button each time that you want to Transpose the pitch of the piano Up one semitone (up to 6 semitones). Press the Down Value button each time you want to lower the pitch of the piano by one semitone (down to -5 semitones).

For example, to transpose up the pitch of the piano six semitones (C=F#), (engage the Transpose button) and press the Up Value button six times. Or if you want to Transpose down the pitch of the piano by five semitones (C=G) press the Down Value button five times.

- 3** To reset the piano back to it's standard A440 pitch, press the Up and Down Value button simultaneously. The "C" piano key will now once again play a "C" note.



The Transpose button must be the last control panel button engaged for the Up or Down Value buttons to be dedicated to Transpose control.

If the Up and Down Value buttons are not altering the Transpose function, disengage and reengage the Transpose button. This will dedicate the Value buttons to the Transpose feature.

LESSON

This Suzuki Piano offers an exclusive feature that will aid Teacher/Student activity or for duet performance.

The Lesson feature actually splits the 88 note piano into two 44 note pianos.

The Split point is fixed at F4 (Middle C being C4). Left Middle C is C2 and Right Middle C is C6.

TO ENGAGE THE LESSON BUTTON

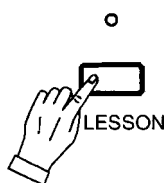

- 1** Press the Lesson button, its LED will turn on. The LED above the Split button will also turn on. The piano is now divided into two 44 note keyboards.

(Continued on the next page)

BASIC OPERATION

LESSON

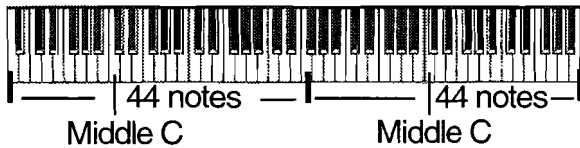

2

As mentioned on previous page the Middle C keys are shown in the diagram to the left.

TO SELECT DIFFERENT INSTRUMENT VOICES FOR EACH 44 NOTE KEYBOARD

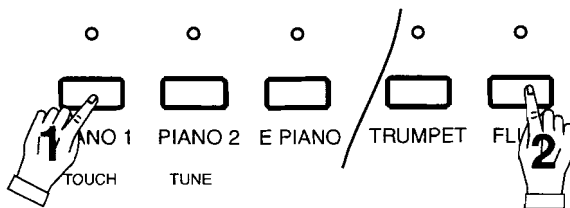

3

To select different voices for each of the 44 note pianos, press and hold the instrument voice button that you want to hear on the upper 44 note keyboard, while you continue to press that instrument voice button press the other instrument voice button that you would like to hear for the lower 44 note keyboard.

Our example shows that the Piano 1 voice is selected for the voice on the upper 44 note keyboard and that the Flute voice is engaged for the lower 44 note keyboard.

NOTE:

To disengage the Lesson Feature press the Lesson button and its LED will turn off. Make sure that both the Lesson and Split LED's are off to return the piano to its normal 88 key play mode.

VALUE

The Value buttons are used to alter an engaged feature or function.

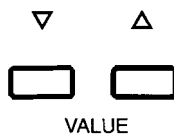

These buttons will alter the last engaged feature or function.

To make sure that the feature or function you want to alter was last engaged you may want to deselect and then re-select your desired function.



From time to time it may be necessary to reset the piano. To reset this piano, with the power off, hold down both Up and Down Value buttons and continue to hold them down while you turn the piano's power switch on. You may release the Value buttons after the power switch has been turned on.

BASIC OPERATIONS

METRONOME

This Suzuki Piano offers a built-in Metronome that can be set to various Meters (beats) and Tempos ranging from 40 BPM to 240 BPM.

TO SELECT AND ADJUST THE METRONOME FEATURE

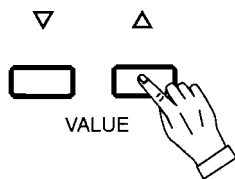
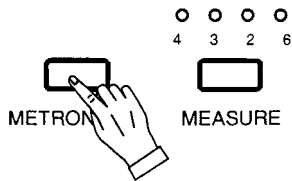

1 Press the Metronome Button and the LEDs above the Measure Button will sequence to the tempo of the selected beat. Default Tempo is 120 BPM.

2 To increase the Tempo, press the Up Value button. To decrease the Tempo of the Metronome press the Down Value button. Every time the Up or Down Value button is pressed it will increase or decrease the Tempo by 5 BPM.

You may adjust the Tempo with the sound off by selecting the measure button and then pressing the Up or Down Value buttons.



To reset the Tempo of the Metronome back to 120 BPM press both the Up and Down Value buttons simultaneously.

TO CHANGE THE BEAT SELECTION OF THE METRONOME

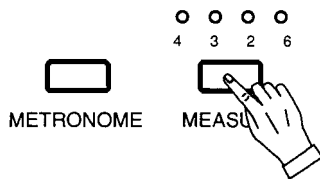

1 Press the Measure Button and the LED of the selected time signature will turn on. Continue to press the measure button to select the desired beat.



The choice of time signatures are 4/4, 3/4, 2/4, 6/8 and "basic beat" (no down beat accent).

The lit LED will indicate which time signature has been selected.

The "basic beat" selection is indicated by having no LED's engaged.

MUSIC RECORDER

This Suzuki Piano has a built-in two track sequencer to record your musical performance. It will record all note events exactly as they were performed.

THE MUSIC RECORDER: HOW TO RECORD

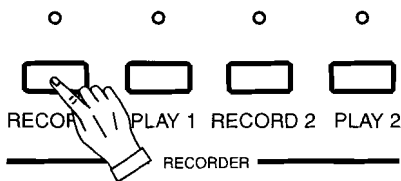
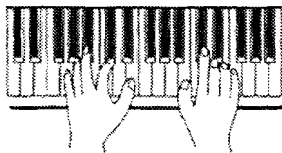
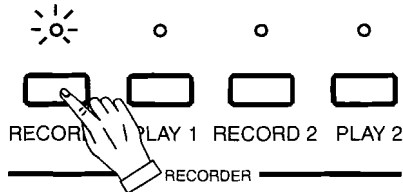

1 Press the Record 1 button. The LED above the button will turn on and the Metronome will sound.

To turn the Metronome sound off press the Metronome button. The Metronome LEDs will continue to flash but the Metronome will not sound.

2 Begin to play your musical selection. The LEDs above the Measure button will stop flashing and begin to sequence in the selected Tempo and Time Signature.

3 Press the Record 1 button to stop recording. The LED above the button will turn off as will the Measure LEDs. If the LED above the Record 1 button turns off by itself, then Track 1 memory has reached its capacity.

THE MUSIC RECORDER: HOW TO PLAYBACK THE RECORDED MUSIC

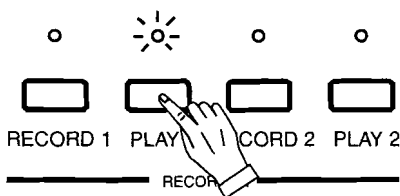

1 Press the Play 1 button. The LED above the button will turn on. The musical passage that you just entered into the musical recorder will playback just as it was performed.

The Metronome beat will not be heard but the Measure LEDs will blink in sequence.

THE MUSIC RECORDER: TO RECORD AND PLAYBACK ON TRACK 2

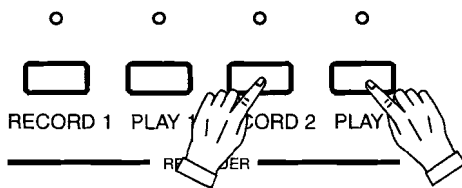

2 Follow the steps listed above, substituting Record 2, Play 2 buttons for the Record 1, Play 1 buttons.

(How to use the Music Recorder is continued on the next page)

MUSIC RECORDER

THE MUSIC RECORDER: HOW TO RECORD ON TRACK 2 WHILE LISTENING TO TRACK 1

While listening to your performance on Track 1 you may simultaneously record on Track 2. You may wish to record a song by recording a chord progression or a bass line on Track 1 and a melody line on Track 2. Whatever your desire is, the flexibility of a two track sequencer will supply you with many different musical possibilities.

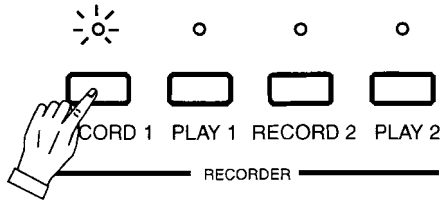

1 Follow the steps listed on the previous page regarding how to Record on Track 1.

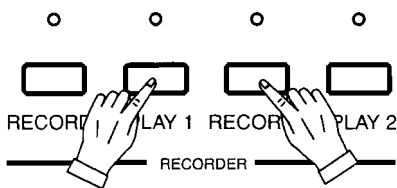

2 After you have recorded a musical passage into Track 1, press the Record 2 button and then press the Play 1 button.

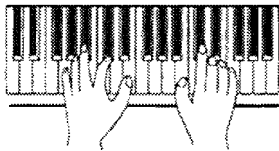

3 As the musical passage recorded on Track 1 begins to play you may begin to play your piece that you would like to record into Track 2

THE MUSIC RECORDER: HOW TO PLAYBACK BOTH TRACKS SIMULTANEOUSLY

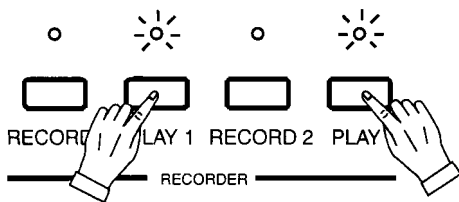

1 To playback both tracks simultaneously simply press both Play 1 and Play 2 buttons at the same time. The LED above each button will turn on and the Measure LED's will begin to sequence with the previously selected Record Tempo.



To Erase Track 1 or Track 2 simply press the Record button for the track that you want to erase. The Music Recorder is automatically erased when the power on the piano is turned off.

FUNCTION CONTROLS - TOUCH SENSITIVITY

FUNCTION

The Function Button Controls up to seven different Control features.

When the Function Button LED is engaged the Instrument Voice Buttons will not select Instrument Voices but instead select any of the seven Control features that you would like to access.

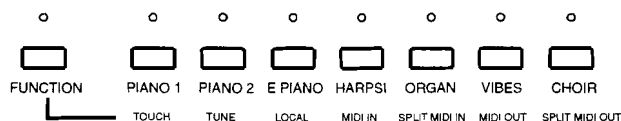

With the Function Button engaged :

Piano 1 controls the **Touch Sensitivity of the piano**

Piano 2 controls the **Tuning of the piano**

E. Piano controls the **MIDI Local On/Off**

Harpsi controls the **MIDI Input Channel**

Organ controls the **MIDI Split Lower Input Channel**

Vibes controls the **MIDI Output Channel**

Choir controls the **MIDI Split Lower Output Channel**

The remaining voice buttons are inoperative in this mode.

TOUCH

This Suzuki Piano offers four types of keyboard Touch Sensitivity settings: Fixed, Soft, Normal and Hard. These are also known as velocity or dynamic curves and are designed to suit your style of playing.

Fixed The only setting that does not offer any touch sensitivity. Each key plays at full volume no matter how hard the piano key is hit. Its commonly used on Harpsichord and Organ voices.

Soft The most sensitive keyboard response which permits maximum sound levels with a light touch.

Normal An intermediate response suitable for most styles of music.

Hard A not so sensitive keyboard response which requires a heavier touch to obtain maximum sound level controls.

TO ADJUST THE TOUCH SENSITIVITY OF THE PIANO'S KEYBOARD

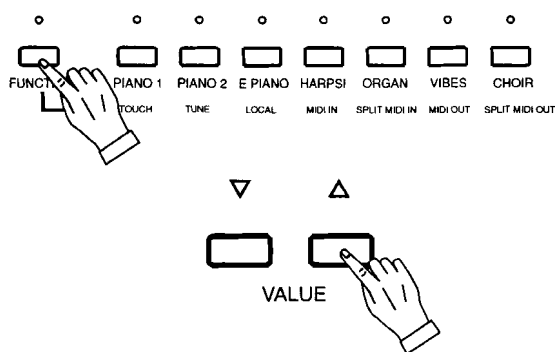

To change from the Normal default Touch Sensitivity setting follow these simple steps:

- 1** Press the Function Button, it's LED will turn on and the Piano 1 (Touch Sensitivity) LED will also by default turn on.
- 2** Press the Up or Down Value button to adjust the piano sensitivity.
Press the Up button once for Soft, twice for Fixed.
Press the Down button once for Hard
- 3** To reset the Piano's touch sensitivity to normal press both Up and Down Value buttons simultaneously.

FUNCTION CONTROLS - TUNING

TUNING

When this Suzuki Piano is turned on, the keyboards pitch is automatically set to Standard A440 concert pitch. However if a different pitch is desired follow the steps listed below. The tuning range is + or - 50 cents.

TO RAISE THE WHOLE KEYBOARD'S PERFECT PITCH

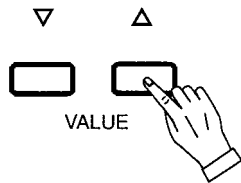

3 Press the Up Value Button to increase the keyboard's pitch by one cent or press the Down Value button to decrease the keyboard's pitch by one cent.

To hear a noticeable pitch change we suggest that you press and release the selected Value button about twenty times.

4 Press both the Up and Down Value buttons simultaneously to return the keyboard's pitch to the Standard A440 pitch.

TO LOWER THE WHOLE KEYBOARD'S PERFECT PITCH

Follow the steps listed above, except for Step 3 use the Down Value button to lower the keyboard's pitch.

FUNCTION CONTROLS - MIDI

MIDI

WHAT IS MIDI?

MIDI stands for Musical Instrument Digital Interface. This is a world wide standard communication interface that enables musical instruments (of all brands) and computers to communicate so that instructions and other data can pass between them. This exchange of information makes it possible to create a "system" of MIDI instruments and equipment that offer greater musical versatility and control than what would be available with just isolated instruments. Whether you interface with computers, sequencers, expanders or other keyboards your musical horizons will be greatly enhanced. For further information on MIDI and MIDI equipment that is available please contact your local Suzuki music store.

THE MIDI TERMINALS ARE LOCATED ON THE BACK BOARD CONNECTOR PANEL OF THE SUZUKI PIANO.

HP-8 MIDI TERMINALS

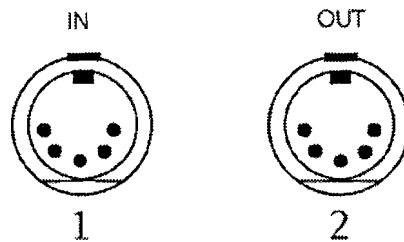

1. The **MIDI IN** connector receives MIDI data from an external MIDI device which can be used to control this Suzuki Piano.
2. The **MIDI OUT** connector transmits MIDI data generated by This Suzuki Piano. Therefore note and velocity data produced by playing the keyboard.

HP-9, HP-10, HP-11 & HG-411 MIDI TERMINALS ALSO INCLUDE A MIDI THRU PORT

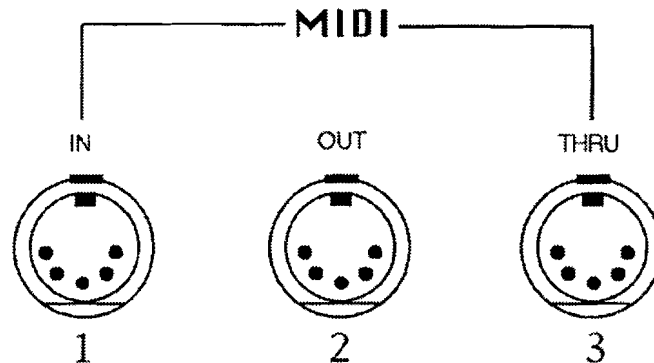

3. The **MIDI THRU** (for models HP-9, HP-10 ,HP-11 & HG-411) connector transfers data from the MIDI IN connector directly to the other MIDI devices that are connected to the **MIDI THRU** port.

FUNCTION CONTROLS - MIDI

MIDI

BASIC MIDI SETUPS

MIDI keyboards transmit note and velocity (touch response) information via the MIDI OUT connector whenever a note is played on the keyboard. If the MIDI OUT is connected to the MIDI IN connector of a tone generator (tone generators usually offer 128 different voices), the tone generator will respond precisely to the notes played on the original transmitting keyboard (in this case this Suzuki Piano).

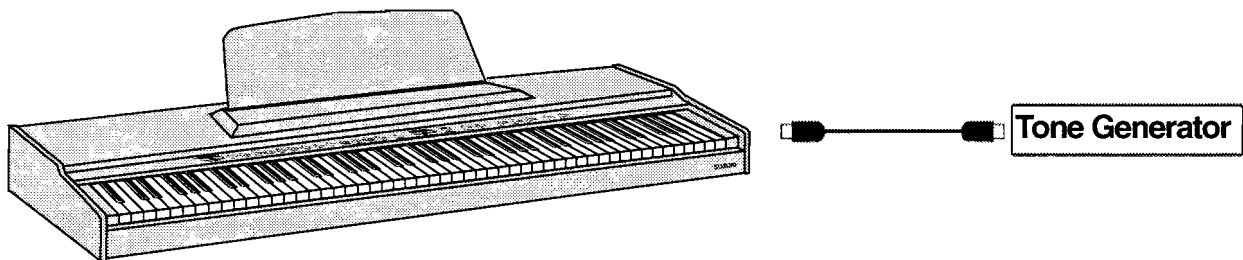

Connecting this Suzuki Piano to another keyboard in the same matter as mentioned above will result in that you can effectively play two instruments at once to provide thick, layered multi-instrument sounds.

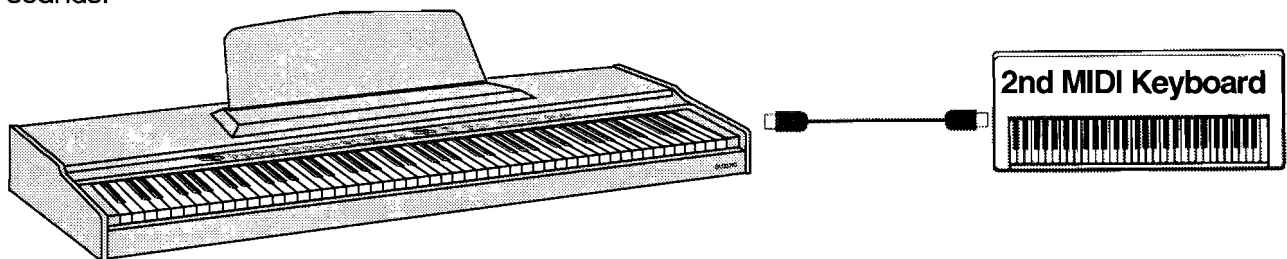

Although This Suzuki Piano offers a built-in "sequencer" (the music recorder is a real-time two track sequencer), the same type of musical information transfer that is described above can be used for more sophisticated MIDI sequence recording using an external sequencer or computer. These devices could be used to "record" MIDI data received from this piano. When the recorded data from this Suzuki Piano is played back by this piano, it will automatically play the recorded performance.

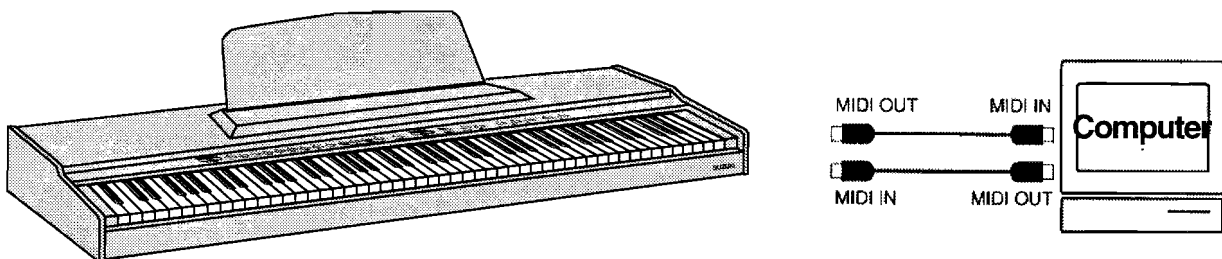

FUNCTION CONTROLS - MIDI

MIDI - LOCAL

LOCAL CONTROL MODE: Local Control refers to the fact that normally, this Suzuki Piano controls the internal tone generator. With Local Control On the internal tone generator is controlled locally by its own keyboard (this is normal play mode). Local Control can be turned off, so that the keyboard does not play the internal voices. However the MIDI information is still transmitted via the MIDI OUT connector when notes are played on the keyboard. At the same time, the internal tone generator can respond to MIDI data received via the MIDI IN connector.

TO SELECT THE LOCAL MODE ON

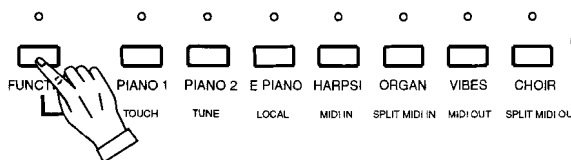

1 Press the Function button, it's LED will turn on and the Piano 1 LED will turn on.

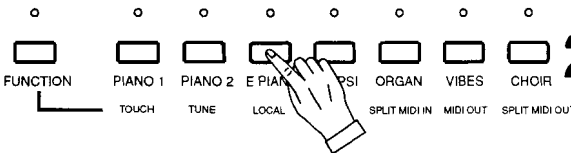

2 Press the E. Piano (local MIDI) instrument voice button. The E. Piano LED will turn on.

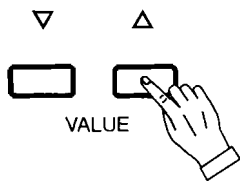

3 Press the Down Value button to toggle the Local MIDI control off.
Press the Up Value button to toggle the Local MIDI control on.

MIDI - INPUT

MIDI INPUT CHANNEL SELECTION - The user may select an individual MIDI channel to Receive MIDI data on. The power up default setting is the OMNI mode which receives MIDI data on all channels.

TO SELECT A DISCRETE MIDI CHANNEL TO RECEIVE MIDI DATA ON

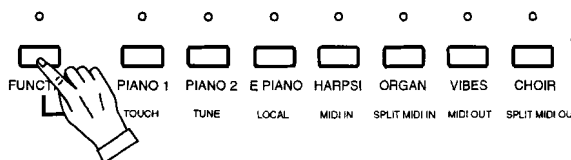

1 Press the Function button, it's LED will turn on and the Piano 1 LED will turn on.



2 Press the Harpsi (MIDI IN) instrument voice button. The Harpsi LED will turn on.

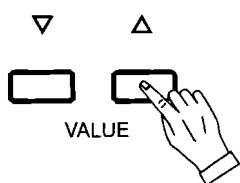

3 Press the Up Value button once to receive data on MIDI channel one, twice to receive on MIDI channel two etc...
The MIDI Input Channel range is from Omni then 1-16 MIDI Channels.

FUNCTION CONTROLS - MIDI

MIDI - SPLIT IN

MIDI SPLIT INPUT LOWER CHANNEL MODE: This MIDI Input Channel mode is used to select which MIDI Input channel that you want receive the Lower Split Keyboard MIDI data that your computer or other MIDI keyboard is transmitting. The previous MIDI Input Mode will receive the Upper Split keyboard data.

TO SELECT A DISCRETE MIDI CHANNEL TO RECEIVE THE LOWER SPLIT MIDI DATA ON

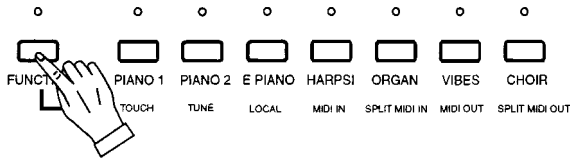

1 Press the Function button, it's LED will turn on and the Piano 1 LED will turn on.

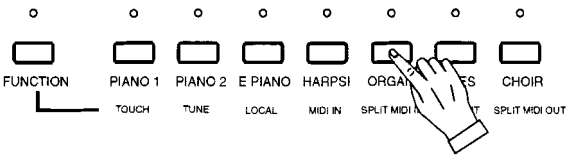

2 Press the Organ (Lower Split MIDI Input) instrument voice button. The Organ LED will turn on.

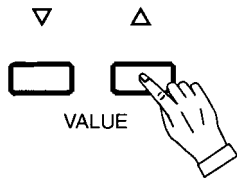

3 Press the Up Value button once to receive data on MIDI Channel one, twice to receive on MIDI Channel two etc... The MIDI Lower Split Input is range is from Omni then 1-16 MIDI Channels.

MIDI - OUTPUT

MIDI OUTPUT CHANNEL SELECTION: The user may select an individual MIDI Channel to Transmit MIDI data on. The power up default setting to transmit MIDI data is Channel 1.

TO SELECT A DISCRETE MIDI CHANNEL TO TRANSMIT MIDI DATA

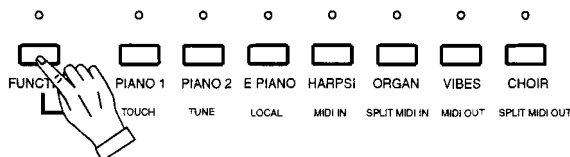

1 Press the Function button, it's LED will turn on and the Piano 1 LED will turn on.

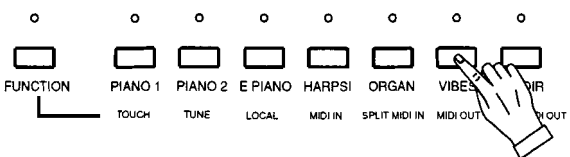

2 Press the Vibes (MIDI Output) instrument voice button. The Vibes LED will turn on.

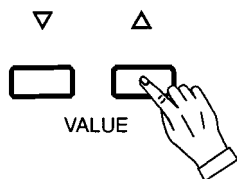

3 Press the Up Value button once to transmit data on MIDI Channel two, twice to receive on MIDI Channel three etc... The MIDI Lower Split Input is range is MIDI Channels 1-16 and Off.

FUNCTION CONTROLS - MIDI

MIDI-SPLIT OUTPUT

MIDI SPLIT OUTPUT LOWER CHANNEL MODE: This MIDI Output Channel mode is used to select which MIDI Output channel that you want transmit on for the Lower Split Keyboard MIDI data. This MIDI data can be sent separately on a discrete MIDI Channel. The previous MIDI Input Mode will Transmit the Upper Split keyboard data. The default setting for this mode transmits on Channel two.

TO SELECT A DISCRETE MIDI CHANNEL TO TRANSMIT MIDI DATA

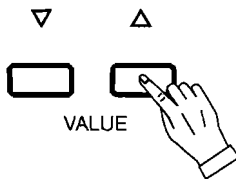
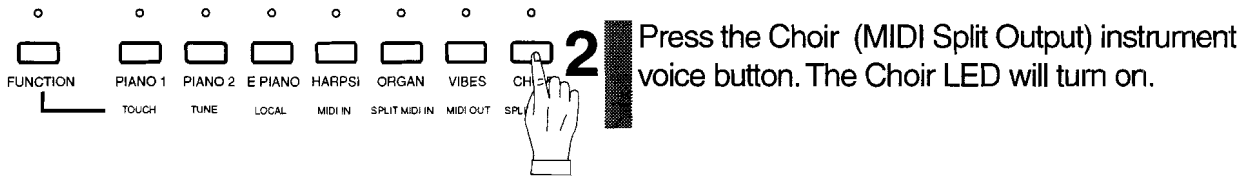
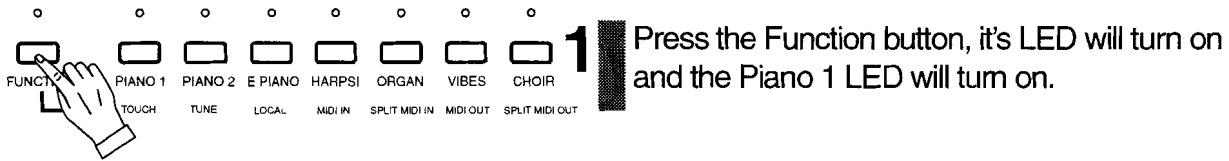

MIDI IMPLEMENTATION CHART: This chart lists the actual data that is transmitted and recognized by this Suzuki Piano .

MIDI IMPLEMENTATION CHART

FUNCTION		TRANSMITTED	RECOGNIZED	REMARKS
Basic	Default	1, 2, 3	omni	
Channel	Channel	1-16, off	omni, 1-16	
Mode	Default	X	mode 3	
	Messages	X	X	
	Altered	-----		
Note		15-114	0-127	
Number	True Voice	-----	21-109	
Velocity	Note On	*1	O	
	Note OFF	X	X	
After Touch	Key's	X	X	
	Ch's	X	O	
Pitch Bender		*1	O	
	1	X	O	Modulation
	5	X	O	Portamento Time
	6,38	O	O	Data Entry
	7	O	O	Volume
	64	O	O	Damper
	66	O	O	Sostenuto
	67	O	O	Soft
	91	O	O	Reverb Level
	93	O	O	Effect Level
	96,97	O	O	Data Inc/Dec
	98,99	O	O	NRPN LSB, MSB
	100,101	O	O	RPN LSB, MSB
Prog		O	O	0-12
Change	True	-----		0-12
System Exclusive		X	X	
System	:Song Pos	X	X	
	:Song Sel	X	X	
Common	:Tune	X	X	
System	:Clock	O	X	
Real Time	:Commands	O	O	
Aux	:Local ON/OFF	X	X	
Messages	:Active Sense	O	O	
Notes		*1 Can be selected		

O: YES

X: NO

BACK PANEL CONNECTORS AND CONTROLS

These connector jacks are located on the back of the piano.

The headphone jacks are located on the bottom left of the piano beneath the lowest keys on the keyboard.

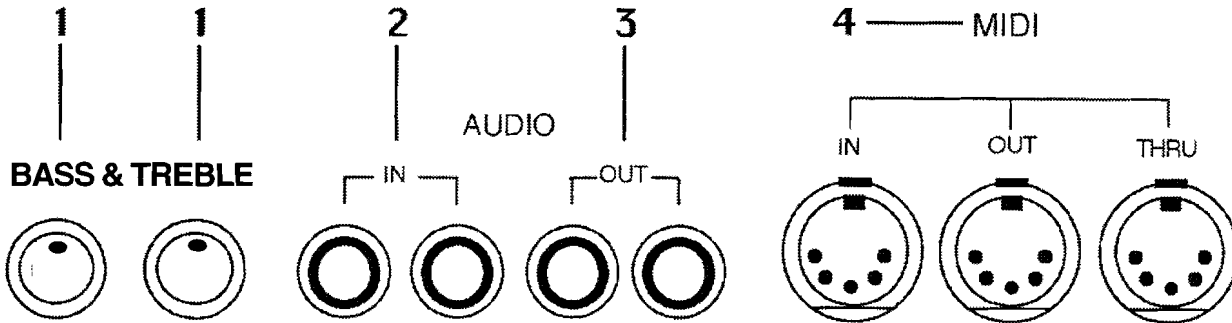

1. BASS & TREBLE CONTROLS

These tone controls allow the user to add or remove Bass and Treble from the piano's audio sound delivery system. These tone controls are in addition to the Brilliance control found on the Control panel.

NOTE: Depending on the instrument voice(s) selected, the selected effects and the setting of the Bass and Treble controls, it is possible to overdrive the sound delivery system. If this happens adjust your selected tone controls to a proper setting.

2. AUDIO IN

These jacks connect the output of other electronic instruments to the internal amplifier and speakers within this piano.

3. AUDIO OUT

These stereo RCA audio output jacks supply your piano's output signal to external amplification.

4. MIDI

MIDI jacks allow communication with other products equipped with MIDI interfaces. See the MIDI section of this manual for further details.

The HP-8 piano contains only MIDI In and MIDI Output ports.

HEADPHONE JACKS



THE HEADPHONE JACKS

You can play in total silence without disturbing other in the same room by plugging a set of headphones into one of the appropriate sockets, located directly under the keyboard on the left side of the instrument. Two sets of headphones may be used.

PEDALS HP-8 AND HP-9

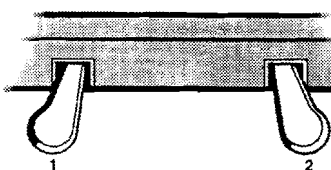

The Soft Pedal (Left): when engaged the keyboard volume is reduced and the timbre slightly altered.

PEDALS HP-10 AND HP-11

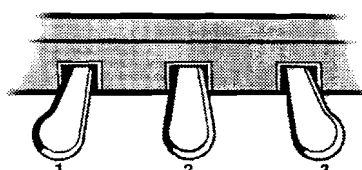

Sustain Pedal (Right): when the sustain pedal is engaged all the keys that are played will sustain with a gradual decay for as long as you hold down the pedal.

The Sostenuto Pedal (Middle): when engaged the keyboard sustains any key to the left of the Middle C piano key that is depressed immediately before the pedal is engaged.

SPECIFICATIONS

KEYBOARD	88 KEY WITH WEIGHTED HAMMER ACTION 64 NOTE POLYPHONY (HP-8 IS WEIGHTED ACTION)
KEYBOARD VOICES	ONE STEREO GRAND PIANO SAMPLE AND TWELVE PCM VOICES (WAVETABLE SYNTHESIS)
FUNCTIONS	TUNE, TRANSPOSE, METRONOME, MIDI, DEMONSTRATION SONGS (13), DUAL, SPLIT, LESSON
CONTROLS	MASTER VOLUME, BRILLIANCE, BASS, TREBLE
DIGITAL EFFECTS	DIGITAL REVERB, CHORUS
TOUCH CONTROL	VELOCITY SENSITIVE - SOFT, NORMAL, HARD, FIXED
MASTER TUNE	+/- 50 CENTS
METRONOME	TEMPO RANGE FROM 40 TO 240 BPM
RECORDER	TWO TRACKS, APPROXIMATELY 4,000 NOTES
PEDALS	SOFT, SUSTAIN (SUSTENUTO FOR HP-10, HP-11 & HG-411)
SPEAKERS	FULL DYNAMIC RANGE, 8" X 2 (HP-10 8X2, 21/2X2)
POWER OUTPUT	40 WATT + 40 WATT(PER SIDE)
CONNECTORS	HEADPHONE, AUDIO IN (LEFT/RIGHT), AUDIO OUT (LEFT/RIGHT), MIDI IN/OUT/THRU, AC INPUT, PEDAL CONNECTOR
FINISH	ROSEWOOD, CHERRY, OAK, IVORY & EBONY
DIMENSIONS	HP-8: 53 1/2"W X 15 7/8"D X 31" H HP-9: 53 3/4"W X 19 7/8"D X 32 3/4" H HP-10:53 3/4"W X 19 7/8"D X 32 3/4" H HP-11:54 1/2"W X 21"D X 36" H
WEIGHT	HP-8: 79lbs. (INCLUDING STAND) HP-9: 149lbs. (INCLUDING STAND) HP-10: 140lbs. (INCLUDING STAND) HP-11: 220lbs. (FULL CABINET)

WARRANTY

This product, except the exterior cosmetic parts, is warranted by the Suzuki Corporation to the original purchaser to be free from defects in materials and workmanship under normal use as follows:

- 1. For a period of one year from the date of purchase, the Suzuki Corporation will pay the labor charges to repair the defective product. After this one year period, you must pay all labor charges.**
- 2. In addition, the Suzuki Corporation will supply, at no charge, new or rebuilt for defective parts for a period of one year from the date of purchase.**

In the event repairs are needed, the original purchaser will return the product to an Authorized Suzuki Retail Center with the dated proof of purchase. The dealer will then repair the product or return it to the Suzuki distribution center in San Diego, California for repairs. Upon completion of the repair, the unit will be returned to the dealer freight prepaid. This warranty will not apply to this product if it has been misused, abused, or altered. This warranty is void if the product is opened. Without limiting the foregoing, bending, dropping of unit, or visible cracks and/or scratches are presumed to be defects resulting from misuse or abuse.

Neither this warranty nor any other warranty expressed or implied, including implied warranties of merchantability, shall extend beyond the warranty period. No responsibility is assumed for any incidental or consequential damages.

In the United States Contact: Suzuki Corporation

San Diego Distribution Center, P.O. Box 261030, San Diego, CA 92196

All Other Countries Contact: Original retailer where product was purchased for additional warranty details.

ACCESSORIES

These accessories have been specifically designed to enhance the enjoyment of your new SUZUKI Keyboard. They are available through your local Suzuki Piano Dealer.

PIANO BENCH Standard Size
Padded seat with square upholstery and storage, 23" x 14 1/2" x

MODEL XB-S

PIANO BENCH Large Size
Padded seat with diamond upholstery and storage, 31" x 14 1/2."

MODEL XB-L

KEYBOARD AMPLIFIERS
Specially designed keyboard amplifiers compatible with all digital pianos and keyboards. 5 channel amps with discrete controls for each channel. 12" woofer and 3" tweeter or piezo/horn.

MODEL SA-100 100 WATT KYBD AMP
MODEL SA- 50 50 WATT KYBD AMP

DYNAMIC STEREO HEADPHONES
Practice and play in private with full range stereo headphones.

MODEL SP-H

For more information see your local Suzuki Dealer or visit us on the web @ www.suzukipianos.com

SUZUKI

DIGITAL PIANOS

OWNER'S MANUAL

HP-8	HP-88F
HP-8F	HP-95
HP-9	HP-105W
HP-10	
HP-11	



P.O. BOX 261030, SAN DIEGO, CALIFORNIA 92196

1-800-854-1594

Visit us on the web at www.suzukipianos.com

Copyright 2000 Suzuki Musical Instrument Corporation

Free Manuals Download Website

<http://myh66.com>

<http://usermanuals.us>

<http://www.somanuals.com>

<http://www.4manuals.cc>

<http://www.manual-lib.com>

<http://www.404manual.com>

<http://www.luxmanual.com>

<http://aubethermostatmanual.com>

Golf course search by state

<http://golfingnear.com>

Email search by domain

<http://emailbydomain.com>

Auto manuals search

<http://auto.somanuals.com>

TV manuals search

<http://tv.somanuals.com>