

Atomos Ninja 2 ~ QuickStart Guide

Download the full Ninja-2 User Manual

➔ www.atomos.com/support

Activate Avid DNxHD® if required

➔ www.atomos.com/activation

Register now to extend your warranty to 3 years from date of purchase

➔ www.atomos.com/registration

Checklist:

- Ninja-2
- 1 x 2-Cell Battery
NP-570 Compatible 2600mAh
- Single Battery Charger
+ Power Supply Unit
- Master Caddy Docking Station
+ USB 2.0 Power Cable, USB 3.0 Cable
- 9V AC Battery Eliminator
110-240V AC for AC operation
- 2 x Master Caddies
- QuickStart Guide'
- Canon LP-E6 or Nikon EN-EL15 Battery Adaptor**
for use of Nikon and Canon batteries
Available upon registration*

* Due to unforeseen circumstances the **Battery Adaptor Plates for Canon & Nikon** will not be available until July 2013. All registered users will be notified when they are available. Please register now to ensure you receive notification email ➔ www.atomos.com/register

You will also need:

HDMI cable

One end having a common 13.9mm type A plug for connection to Ninja-2, and the other end having a plug suitable for your camera.



HDD/SSD

2.5 inch Hard Disk Drive [HDD] or Solid State Drive [SSD]. For recommendations refer to:

➔ www.atomos.com/drives



Getting started:

Battery:

We recommend that you charge new batteries before using them.

To begin, connect battery to charger and commence charging. While charging, the red light will illuminate. When the red light turns green, the battery is 100% charged.

Assemble Master Caddy:

Fix the Hard Disk or Solid State Drive into the Master Caddy as shown (right). Align screw holes on all three pieces and assemble completely. Insert screws last.

⚠ Handle the HDD or SSD with care

Touch screw holes or metal shell first. Avoid contact with circuit board and connectors. **Refer to manual if unfamiliar with handling ESD sensitive devices.**

Format HDD/SSD:

Once your drive is inserted into the caddy, format it in your Ninja-2 recorder by selecting the BLUE arrow  next to Recording Time Remaining, Press **Format HDD/SSD** and follow the on-screen instructions. **For more information refer to the User Manual.**

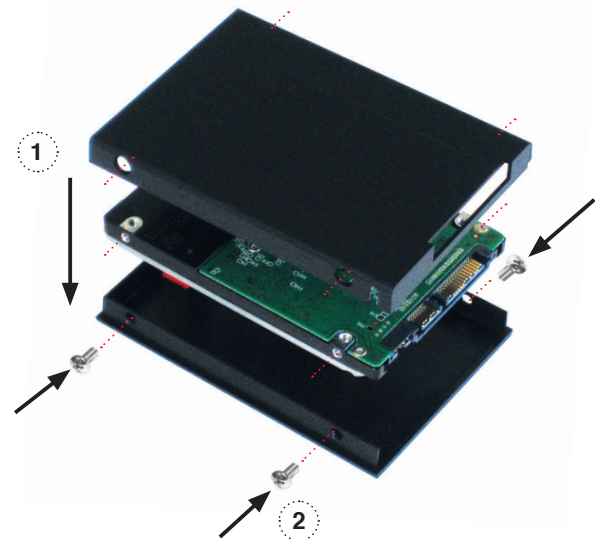

⚠ **Important:** Insert screws last and **DO NOT** over-tighten the screws or proper alignment of the Master Caddy can not be guaranteed.

Atomos Ninja 2 ~ QuickStart Guide

Connect & power-up

Attach Battery:

Attach the supplied battery to the Ninja-2. Make sure to use the battery slot marked with the number "1" as this is the primary battery. If you purchase an additional battery, it should be connected to the other, secondary slot.

The Ninja-2 utilises only one battery at a time. This way a battery can be removed, charged and replaced during operation. Refer to the User Manual for more information.

IMPORTANT Ninja-2 can only power up / turn on from the primary battery position. [Battery Slot #1]



CONNECT:

Video Input

Connect camera or other source device to the Ninja-2 using a HDMI cable.

Video Output

Loop or Play out to an external HDMI TV/Monitor

Media Storage:

Insert Master Caddy into the Ninja-2 until it clicks into position.

Audio

Stereo Line In
Stereo Line Out
or Headphones



Mount

Mount the Ninja-2 on or between the camera or tripod using the standard 1/4" inch tripod screw mounts top and bottom.

Eject Button: HDD / SSD

To eject the Master Caddy, slide the latch on the side of the Ninja-2 and pull out Master Caddy from the slot. **The Master Caddy is hot-swappable so you can do this at any time... except while actively recording.**

POWER:

On/Off

Briefly press the circular button on the side of the Ninja-2 to **power-up** the unit.

To **shut down**, depress button for **at least 4 seconds** (until unit turns off)

⚠️ **CAUTION:** The Ninja-2 is constructed from aluminium which acts as the unit's heat sink. In high or extreme temperatures / climates, the metal chassis may feel slightly warm / hot to touch. This is completely normal and does not in any way effect the overall functionality of the Ninja-2.

Main Controls: One-touch Operation (Simple Touchscreen Interface)

The Ninja-2 is controlled by a simple user-friendly **touchscreen** interface.

Please find herewith a brief description of the main controls seen when the Ninja-2 is first powered up. **Please refer to the User Manual for more details.**



Pay special attention to any items on screen which are marked by a small blue arrow. Touch these items to **access** or cycle thru related options.



A larger blue arrow in the top right corner of the screen will **return** you from other menus to the main controls.

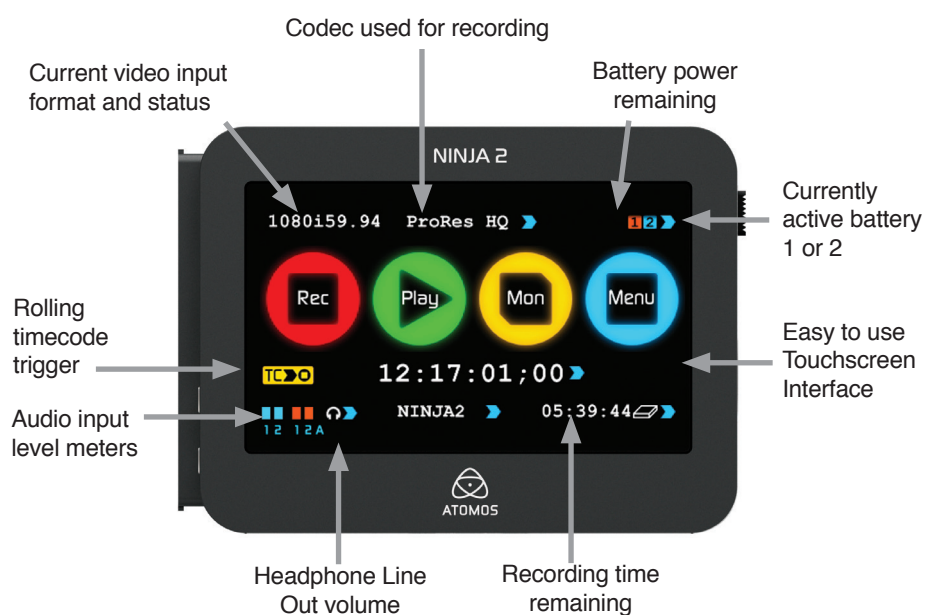

Atomos Ninja 2 ~ QuickStart Guide

Record

Main Interface:

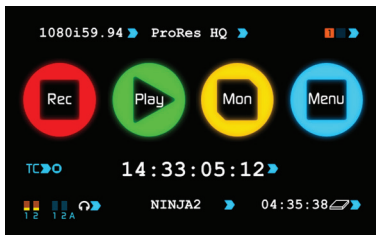

- Rec** Record: Press to start/stop recording
- Play** Play: Enter playback mode
- Mon** Monitor: Enter monitor mode
- Menu** Menu: Device settings / options

Audio Indicator
The Audio Levels associated with the current Recording

14:33:05:12 Timecode Display and settings

TC Start/stop trigger from moving timecode
Canon 5D MKIII, 1DC & C100 - select HDMI and Canon from the timecode menu (Menu > Timecode)
Sony NEX-FS100 & NEX-FS700 - select HDMI and Sony from the timecode menu (Menu > Timecode)
Atomos timecode - Rec run, Auto restart and time of day

Monitor & Record while monitoring

Monitor & Record: Configurations

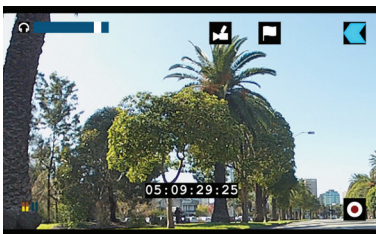

- Record while Monitoring**
Press to Record in Monitor Mode
- Smart Log: Smart Log Mode**
- Back:** Takes user back to the main control screen
- Smart monitor**
- Headphones:** Volume adjustment

Smart Monitor Interface

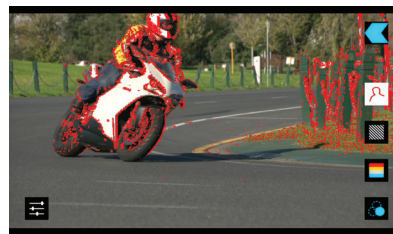

- Focus Assist: Peaking**
- Exposure Assist: Zebra**
- False Colour Twin Mode**
- Blue Only: Exposure Check**
- Monitor Assist: Control adjustments for individual filters**

Playback & Edit: One-touch Review

Smart Log: Tagging Interface



- Smart Log**
- Smart Monitor Mode**
- Loop IN Point**
- Loop: Loop Playback**
- Loop OUT Point**

Tagged Clips: Areas of the video clip can be tagged & highlighted
12:32:41:08 Timecode Display Indicator: Video clip playback information

Playback: Play, Loop & Scrub

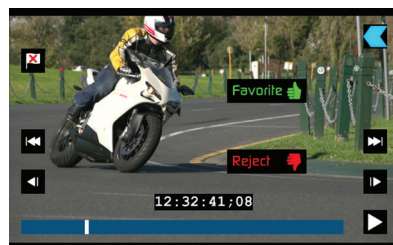

- Super RWD/Super FFWD**
- Play:** Press to play clip
- Jump to beginning / end**
- Frame by Frame: RWD/FFWD**
- SmartLog:**
Clear all smartlog tags
- 12:32:41:08** Timecode Display

Favorite Tag for Favourite: Touch once to set the IN point. Touch again to set OUT point.
Reject Tag for Reject: Touch once to set the IN point. Touch again to set OUT point.

Connect & Edit

Master Caddy Docking Station

To access and edit your recorded material:

Connect the Master Caddy Docking Station to a Mac® or Windows® editing workstation via USB 2.0 and/or USB 3.0 compatible port/s.

! When using USB, you may also need to connect power to the Docking Station using the included USB power cable and connecting it to a USB 2.0 port. Try this if you encounter problems.

Ready to edit:

Next, eject the Master Caddy from the Ninja-2 and insert it into the Docking Station. After a short wait your recorded video will become accessible as a standard external disk (Native ExFAT / FAT32 formatted drive/s also supported).

? For more detailed instructions and important up-to-date information regarding the Ninja-2 please consult the Ninja-2 User Manual available for download from

www.atomos.com/support

Atomos Ninja 2 ~ Important information

Warranty & Conditions

Notice

Copyright © 2013 ATOMOS Global Pty Ltd (referred to as ATOMOS). All rights reserved. All information in this document is subject to change without notice. No part of the document may be reproduced or transmitted in any form, or by any means, electronic or mechanical, including photocopying or recording, without the express written permission of ATOMOS. A reference to ATOMOS includes its related entities, subsidiaries and parent company.

Trademarks

NINJA / NINJA-2 / ATOMOS are registered trademarks of ATOMOS Pty Ltd. Apple, the Apple logo, AppleShare, AppleTalk, FireWire, iPod, iPod Touch, Mac, and Macintosh are registered trademarks of Apple Inc. Final Cut Pro, QuickTime and the QuickTime Logo are trademarks of Apple Inc. All other trademarks are the property of their respective holders.

International Hardware Limited Warranty (1 Year Standard/3 Years if registered)

ATOMOS warrants that:

- the main product, not including TFT/LCD, or any external accessories, will be free from defects in materials and workmanship for a period of 1 year from the date of purchase; or 3 years upon completion of product registration at www.atomos.com
- the TFT/LCD, batteries, battery charger, HDD/SSD docking station, case and master caddies will be free from defects in materials and workmanship for a period of 1 year from the date of purchase regardless of registration.

This warranty is exclusively for the benefit of the original purchaser and is not assignable or transferable.

If during the warranty period the product is shown to be defective ATOMOS may at its option:

- a) replace the goods or supply equivalent ones, b) repair the goods, c) pay the cost of replacing the goods or of acquiring equivalent ones and d) paying the cost of having the goods repaired;

The customer must notify ATOMOS of any defect in the goods in writing prior to the expiry of the warranty periods set out above. The customer will be solely responsible for returning the goods to ATOMOS or its authorized distributor. Upon acceptance of a warranty claim by ATOMOS, where ATOMOS repairs or replaces the goods, it will be responsible for reasonable shipping costs incurred in sending the goods to the Customer, provided that customer is located in a country in which ATOMOS has an authorized distributor or repair centre or agent.

Warranty Exclusions

This warranty applies only to defects in workmanship and does not cover defects caused by:

- A failure to comply with the then current operating instructions issued by ATOMOS;
- Neglect;
- Improper or negligent acts or omissions;
- Unauthorised repairs or attempted repairs;
- Tampering with or modification of the goods;
- Connection to incompatible equipment or power sources;
- Exposure to water or weather;
- Exposure to magnetic fields or corrosive liquids or substances;

EXCEPT AS STATED IN THIS WARRANTY, ATOMOS, ITS VENDORS, AGENTS, RESELLERS AND DISTRIBUTORS DISCLAIM IN THEIR ENTIRETY ALL OTHER WARRANTIES, EXPRESS OR IMPLIED, INCLUDING WITHOUT LIMITATION ALL WARRANTIES OF MERCHANTABILITY OR FITNESS FOR A PARTICULAR PURPOSE. THE REMEDIES OUTLINED IN THIS WARRANTY ARE THE EXCLUSIVE REMEDY A CUSTOMER HAS ARISING FROM DEFECTIVE GOODS WHICH ARE SUBJECT TO THE WARRANTY.

ATOMOS DOES NOT WARRANT THAT THE GOODS WILL OPERATE IN A MANNER WHICH IS ERROR FREE, OR UNINTERRUPTED. THE GOODS ARE NOT INTENDED TO BE THE PRIMARY OR ONLY DATA STORAGE DEVICE FOR DATA – CUSTOMERS ARE SOLELY RESPONSIBLE FOR BACK UP AND PROTECTION OF DATA.

Software License Agreement

IMPORTANT, PLEASE READ CAREFULLY. THIS IS A LICENSE AGREEMENT.

This ATOMOS software, related documentation, any included sample images and other files (the "Software"), is protected by copyright laws and international copyright treaties, as well as other intellectual property laws and treaties. The Software is licensed, not sold.

This End User License Agreement ("EULA") is a legal agreement between you (either an individual or a single entity) and ATOMOS with regard to the copyrighted Software provided with this EULA. Use of the Software provided to you by ATOMOS in whatever form or media, will constitute your acceptance of these terms, unless separate terms are provided by the software supplier, in which case certain additional or different terms may apply. If you do not agree with the terms of this EULA, do not download, install copy or use the Software. By installing, copying or otherwise using the Software, you agree to be bound to the terms of this EULA. If you do not agree to the terms of this EULA, ATOMOS is unwilling to license the Software to you.

1. Eligible licensees. This Software is available for license solely to purchasers of the ATOMOS Ninja, who have purchased a unit manufactured by ATOMOS Ninja-2 and purchased through an ATOMOS authorized reseller, with no right of duplication or further distribution, licensing or sub-licensing.
2. License Grant. ATOMOS grants you a personal, non-transferable and non-exclusive right to use the copy of the Software provided with this EULA. You agree you will not copy the Software except as necessary to use it with the ATOMOS Ninja-2. You agree that you may not copy the written materials accompanying the Software. Modifying, reverse engineering, translating, renting, copying, transferring or assigning all or part of the Software or any rights granted hereunder, to any other persons or reverse engineering the hardware on which the Software runs, is strictly prohibited. The software is license, not sold. You acknowledge that no title to intellectual property in the Software is transferable to you. You further acknowledge that title and full ownership rights to the Software will remain the exclusive property of ATOMOS and/or its suppliers, and you will not acquire any rights to the Software, except as expressly set forth above. All copies of the software will contain the same proprietary notices as contained in or on the Software. All title and copyrights in and to the Software (including but not limited to any images, animations, video, audio, text incorporated), the accompanying printed materials, and any copies of the Software are owned by ATOMOS or its suppliers.
3. Reverse engineering. You agree that you will not attempt, and if you are a corporation, you will use your best efforts to prevent your employees and contractors from attempting to reverse compile, derive circuits, modify, translate or disassemble the Software and/or the ATOMOS Ninja-2 in whole or in part. Any failure to comply with the above or any other terms and conditions contained herein will result in the automatic termination of this license and the reversion of the rights granted hereunder by ATOMOS.

ATOMOS reserves the right to terminate this license without prejudice to any additional recourse ATOMOS may have against you if you violate any of its terms and conditions.

Download the Ninja-2 User Manual

➔ www.atomos.com/support



ATOMOS – Website: www.atomos.com | Sales: sales@atomos.com | Support: support@atomos.com

ATOMOS.COM

© ATOMOS Global Pty. Ltd. trading as ATOMOS under license. All trademarks are the property of their respective owners. Atomos reserves the right to change or alter any product specifications without notice.

ATOMOS

Free Manuals Download Website

<http://myh66.com>

<http://usermanuals.us>

<http://www.somanuals.com>

<http://www.4manuals.cc>

<http://www.manual-lib.com>

<http://www.404manual.com>

<http://www.luxmanual.com>

<http://aubethermostatmanual.com>

Golf course search by state

<http://golfingnear.com>

Email search by domain

<http://emailbydomain.com>

Auto manuals search

<http://auto.somanuals.com>

TV manuals search

<http://tv.somanuals.com>