

## LUBRICATION

The rod on which the **product holder** slides, which is underneath the slicer, should be lubricated weekly with several drops of oil. Machine without oiler. Lift up the machine and oil the rod directly. After the lubrication have the carriage sliding 4 or 5 times.

Use oil SHELL ONDINA 15 or ESSO MARCOL 82.

Occasionally, the **slice thickness plate** slide rod should be coated lightly with lubricant. Turn the **slice thickness control** fully counterclockwise when lubricating this slide rod and then turn it fully clockwise when finished.

DO NOT lubricate the rod on which the **last slice device** slides.

It must be kept clean but not lubricated. The motor has sealed bearings and requires no lubrication maintenance.

## WEAR ADJUSTMENT

After several years of operation and many sharpenings of the blade it may become necessary to have the slice thickness plate adjusted closer to the blade.

Dimension mm

	AX-S9Ultra	AX-S10Ultra	AX-S12Ultra	AX-SD12Ultra
E	330	360	390	470
F	280	280	320	365
G	410	410	450	500
H	360	360	420	455
L	590	590	600	630

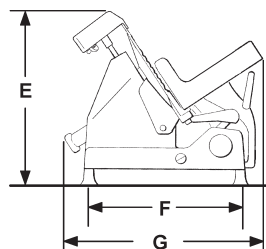

Motor Data	AX-S9Ultra	AX-S10Ultra	AX-S12Ultra	AX-SD12Ultra
Volts		115		
Hz		60		
Ph		1		
Amp	1,5	1,5	2,5	2,5
N/min		1750		

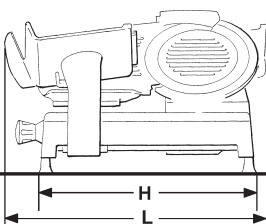

Weight	AX-S9Ultra	AX-S10Ultra	AX-S12Ultra	AX-SD12Ultra
Net kg	12	13	18	24
Brut kg	15	16	22	29

Slicing capacity mm

	AX-S9Ultra	AX-S10Ultra	AX-S12Ultra	AX-SD12Ultra
A	140	140	150	200
B	190	190	220	270
C	170	170	210	235

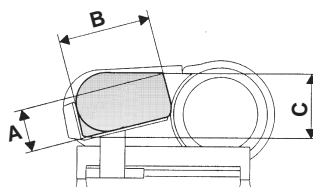

PLEASE CALL AXIS EQUIPMENT FOR PARTS & SERVICE FOR YOUR SLICER AT: (514) 737-9701 / (888) 275-4538



# AXIS

GB

**AX-S9 Ultra**  
**AX-S10 Ultra**  
**AX-S12 Ultra**  
**AX-SD12 Ultra**

**INSTALLATION**  
**MAINTENANCE**  
**SLICER**

## INSTALLATION

### UNPACKING

Immediately after unpacking the slicer, check it for possible shipping damage. If this machine is found to be damaged after unpacking, save the packing material and contact the carrier within 15 days of delivery.

Prior to installation, test the electrical service to assure that it agrees with the specifications on the machine data plate (1).

### ELECTRICAL



**WARNING:** THIS MACHINE IS PROVIDED WITH THIS PLUG MUST BE CONNECTED TO PROPERLY GROUNDING PLUG, GROUNDED OUTLET. IF THE RECEPTACLE IS NOT THE PROPER GROUNDING TYPE, CONTACT AN ELECTRICIAN.

### CLEANING

This machine must be thoroughly cleaned and sanitized after installation and before being put into service.

### SAFETY

SAFETY DEVICES INCORPORATED IN THIS SLICER MUST BE IN THEIR CORRECT OPERATING POSITIONS ANYTIME THE SLICER IS IN USE.

The **blade cover** (5) must be in position over the knife and secured by tightening the hand knob.

The **last slice device** (4) must be used when slicing it keep your hands away from the blade.

When the slicer is not running, the **slicer thickness control** (2) must be set on zero (fully clockwise) to prevent the blade edge from being exposed. Always UNPLUG the power cord before cleaning or moving the slicer.

## SLICING

Pull the **product holder** (3) toward you until it stops and place the product to be sliced on the product holder tray. Set the **last slice device** (4) against the product and stwich on the slicer by pressing the on-off stwich.

Adjust the **slice thickness** (7) by turning the **slice thickness control** (2).

The numbers on the slice thickness control do not indicate actual measurements but may be used for reference to duplicate slice thickness.

Using the **last slice device** (4) handle push the **product holder** (3) back and forth to slice. Always turn off the slicer and turn the **slice thickness control** clockwise to zero when not slicing.

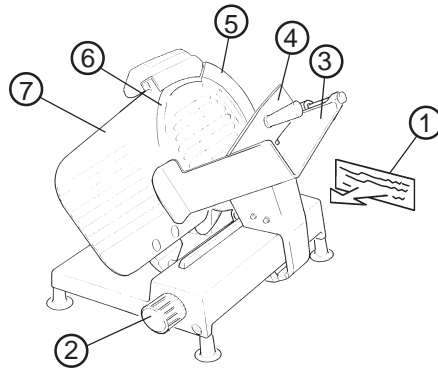

## CLEANING

This machine must be thoroughly cleaned after each day's operation or anytime it will not be used for an extended period of time.

**WARNING: UNPLUG MACHINE POWER CORD AND TURN THE INDEX KNOB FULLY CLOCKWISE BEFORE CLEANING THE SLICER.**

Remove the **slice deflector** by removing its thumb screw.

Turnover **product holder** (3). Pull the carriage up to its limit stop and rotate towards the outside, by having the plate either removed or turned over, makes easier the cleaning of remote spots otherwise difficult to be reached.

Using a mild soap and hot water solution and a clean cloth, wipe all surfaces of the slicer. Thoroughly rinse it with another clean cloth and fresh water.

Remove the blade cover by removing the hand knob (5).

With the hand knob removed, grasp the edge of the blade cover and carefully lift it straight off the blade.

**WARNING: THE SLICER BLADE IS VERY SHARP USE EXTREME CAUTION WHEN WORKING NEAR THE BLADE.**

CAREFULLY wash both sides of the **blade** with the **slice thickness control** turned fully clockwise. Wash the blade by wiping outward from the center. ALWAYS rinse the **blade** thoroughly using fresh water and a clean cloth. Never use steel pads it clean the **blade**. Wash and thoroughly rinse the removed components prior to reassembling them. DO NOT wash any slicer components in a dishwasher.

## MAINTENANCE

**ATTENTION**  
Use protection gloves

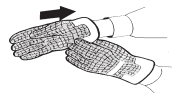

## ELECTRICAL SAFETY

When the slicer is running the eventual removal of the blade cover, or the default of electric power, causes the stop of the machine.

## SHARPENING OPERATION

Your slicer **blade** will provide long service in normal deli, food store, or commercial kitchen use.

However, in high volume applications where it is a practice to sharpen the **blade** frequently or even daily, the **blade** will be expended in a shorter time.

**For a correct sharpening of the blade follow these instructions:**

1 Make sure that the machine off.

2 Clean the blade removing any greasy residue.

3 Rotate the slice thickness control to zero to make sure that the blade is covered by the slice thickness plate.

**ATTENTION: During the sharpening operations, pay attention to an accidental contact with the blade.**

4 Slip off completely the sharpener and spin it 180 degrees.

5 **Sharpening:** Press the sharpening wheel for about 10-15 seconds, then press simultaneously also the grinding stone for two seconds. Contemporaneously loosen the two grindstones.

6 Lift and rotate 180 degrees the sharpener and reallocate it into its initial position.

**Cleaning of the grinding wheels**  
For an adequate sharpening the grinding wheel must always be clean. Remove dirt and grease with alcohol and using a brush.

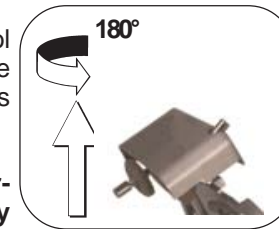
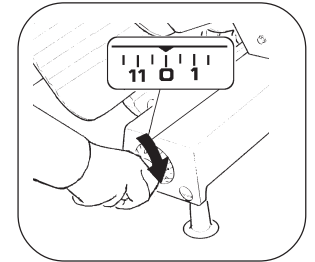

## Free Manuals Download Website

<http://myh66.com>

<http://usermanuals.us>

<http://www.somanuals.com>

<http://www.4manuals.cc>

<http://www.manual-lib.com>

<http://www.404manual.com>

<http://www.luxmanual.com>

<http://aubethermostatmanual.com>

Golf course search by state

<http://golfingnear.com>

Email search by domain

<http://emailbydomain.com>

Auto manuals search

<http://auto.somanuals.com>

TV manuals search

<http://tv.somanuals.com>