

ARCTIC AIR™ Ultra

Evaporative Air Cooler



Product Guide

SAVE THESE INSTRUCTIONS

READ ENTIRE MANUAL BEFORE USE

Congratulations!

Thank you for choosing Arctic Air™ Ultra!
The #1 Best Selling Personal Space Cooler!
If you have any questions or problems, go to:

www.ArcticAirFAQ.com

If you can't find the answer or do not have access to the internet,
call our customer service line Monday-Friday 9am to 6pm EST:

1-800-205-3001

WHAT'S INCLUDED:

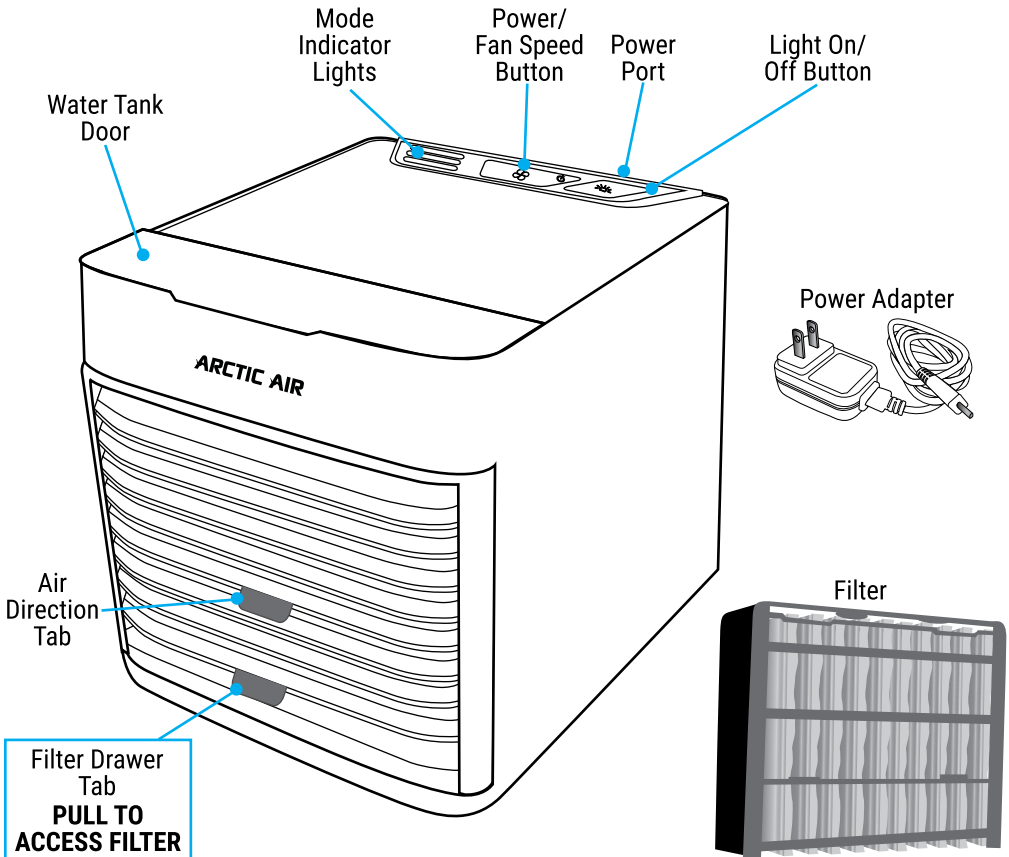

SETUP:

1. Set Arctic Air™ Ultra on a flat surface such as a table or desk. Attach Power Adapter to Power Adapter Port, and plug Power Adapter into wall outlet.

NOTE: Use built-in Cord Guides along back to keep cord away from fan.

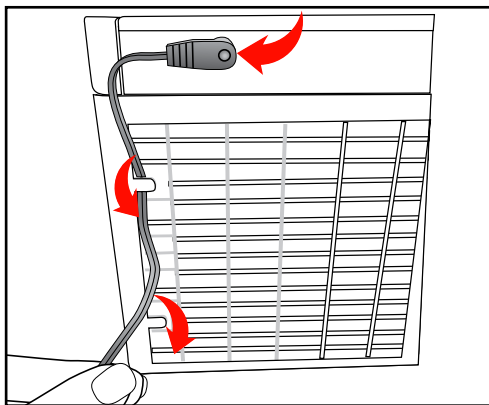

2. Use the Filter Drawer Tab to pull out the filter drawer & remove filter.

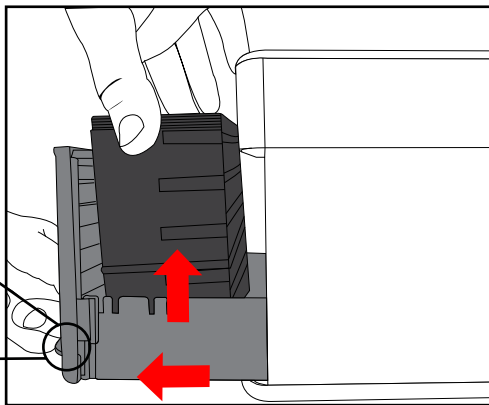
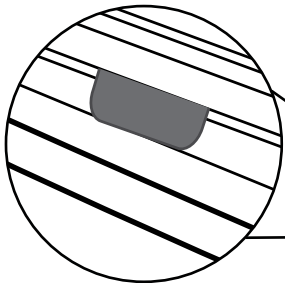

3. For best results, lightly pre-soak under cold, running water. For even more cooling power, place a wet filter in the freezer until frozen.

Place back in drawer when done.

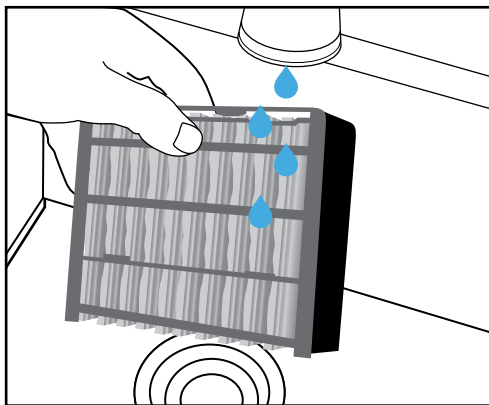

SETUP (CONT.):

4. Open Water Tank Door and fill until line on MAX FILL tab. Close Water Tank Door when done.

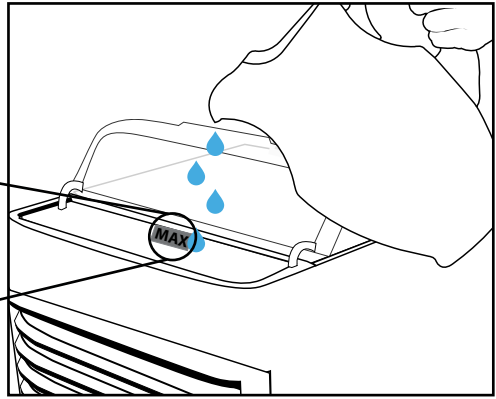
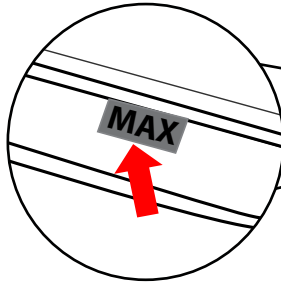

USAGE:

1. Press the  button to turn Arctic Air™ Ultra on - it will default to High speed mode.

- 1st press: Power on, High
- 2nd press: Medium
- 3rd press: Low
- 4th press: Power off

NOTE: Arctic Air™ Ultra will run up to 8 hours on High, 10 hours on Medium, & 12 hours on Low.

2. Use the Air Direction Tab to adjust airflow up/down to your preference.

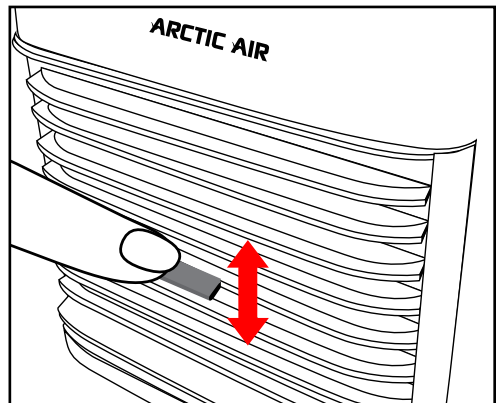
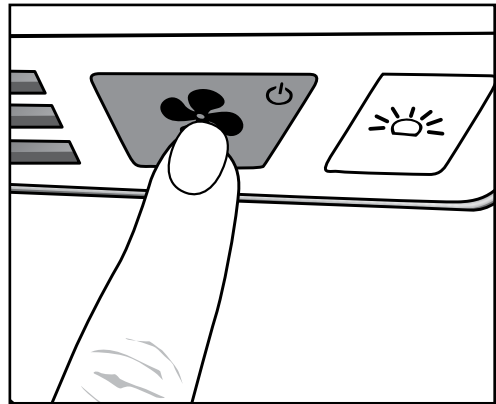

USAGE (CONT.):

3. Choose night light setting by pressing  button - default setting is High brightness.

- Default: Light on, High brightness
- 1st press: Low brightness
- 2nd press: Light off

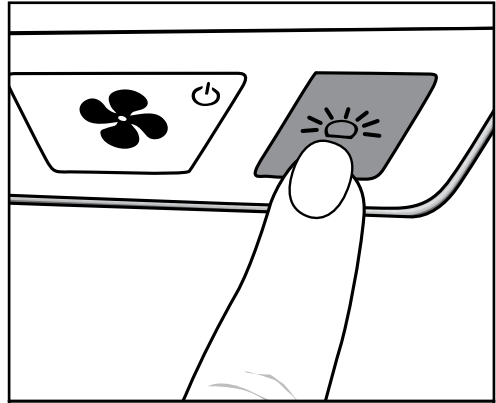

4. To power off, press the  button until fan turns off (one press after Low speed), and Mode Indicator Lights are no longer lit.

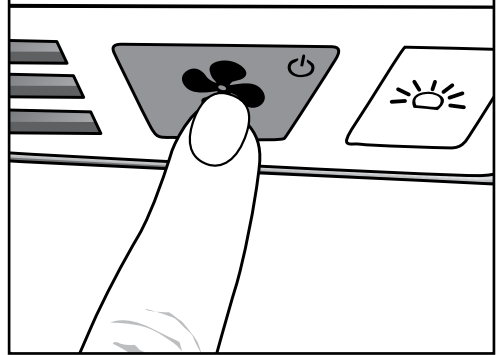

IMPORTANT: If you do not plan to use Arctic Air™ Ultra for an extended period of time, it is recommended that you empty and let unit & filter dry before storing. This will avoid mold and unpleasant smells, and prolong life of Arctic Air™ Ultra and the filter.

MAINTENANCE:

We recommend weekly cleaning of your Arctic Air™ Ultra and Filter to keep in best working condition and replacing the Filter every 3-6 months.

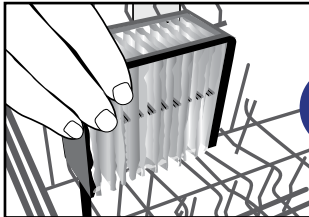

OR

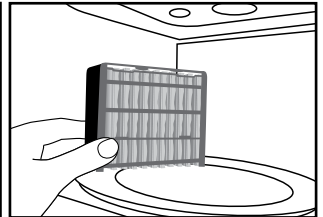
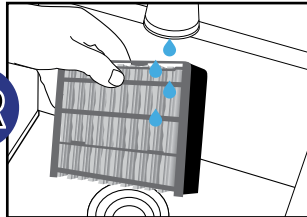

DISHWASHER: Place filter in the top-rack of your dishwasher & run cycle normally. Remove and let air dry.

HAND WASH: Hand wash gently with warm water & soap. Shake out excess water & let air dry.

MICROWAVE: Between washes, sanitize your filter by placing in microwave on high for 30 second increments, up to 2 minutes. Let sit until cool.

MAINTENANCE:

IMPORTANT: If you see mold on the filter or notice a musty smell, stop and clean the filter before further use. Fully submerge the filter in a pot or bowl filled with equal parts clean water and white vinegar – allow to soak for 45-60 minutes. Rinse with warm water, wring out and let air dry.

UNIT CLEANING

- To prepare for cleaning, run Arctic Air™ Ultra until all water has emptied from the water tank, or hold Arctic Air™ Ultra over a sink and carefully dump out to avoid splashing or spilling.
- Remove Filter tray from Arctic Air™ Ultra. Using warm, soapy water, wipe filter tray and grill, then rinse off until clean. Let air dry.
- If you notice water tank is dirty, use a small, bendable brush (i.e. toothbrush, bottle brush, etc) and carefully clean the inside of the tank until clean. Rinse clean with warm water.

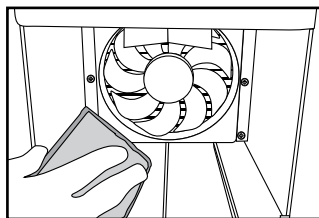
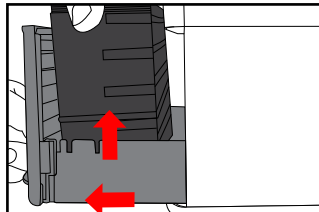

To Order A New Filter or Customer Service:



Web: www.ArcticAirFilter.com



Call: 1-800-205-3001



Email: ArcticAir@rephelpdesk.com

WARNINGS:

- Do not carry Arctic Air™ Ultra when filled with water. Some water may remain in unit even if tank is empty.
- Use only clean water. If needed, use distilled water.
- Please read and follow regular maintenance as recommended in “Maintenance” section of this guide.
- Arctic Air™ Ultra works best in non-polluted areas. Large dust/dirt particles may reduce lifetime of unit.
- We recommend use only in dry locations. If using in a moist area or environment, take care not to get water on external areas of the product.
- If a leak or spill occurs on the surface of device, unplug Arctic Air™ Ultra & let it dry for 24 hours. Then, use as normal.
- Do not place in direct sunlight for extended periods of time.

WARNINGS:

- Before not using Arctic Air™ Ultra for extended periods of time, empty the water tank, turn unit on, and set to highest fan speed for at least 4 hours. This will dry out then filter and inside of your unit.
- Only use the original power adapter and cord supplied in package.
- Do not touch the power supply or power cord with wet hands.
- Unplug Arctic Air™ Ultra when cleaning, removing/replacing filter, or moving the device.
- For best results, place Arctic Air™ Ultra on a higher surface like a table or countertop.
- Do not place Arctic Air™ Ultra near a heater or any electrical equipment.
- Do not place the device in passageways or high traffic areas where there is a possibility of tripping or knocking it over.
- Do not allow any foreign objects inside Arctic Air™ Ultra.
- Do not place items on top Arctic Air™ Ultra.
- Do not block the front and back grills of the device.
- Do not turn the device upside down.
- Do not submerge the Arctic Air™ Ultra under water or other liquids.
- Do not place Arctic Air™ Ultra near open flames or fire sources.
- People with limited physical, visual or mental abilities or lacking proper experience and/or knowledge should never use the device without supervision of those responsible for their safety or those capable of assistance in using the device.
- The device can be switched off completely only when disconnected from the power supply.
- The manufacturer does not bear any responsibility for any damage from failure to comply with this product guide.
- A replaceable water filter is designed specifically for this product. If your cartridge has been broken or damaged, you can purchase a replacement.

ONTEL® ASSUMES NO RESPONSIBILITY FOR ANY INCIDENTAL OR CONSEQUENTIAL DAMAGES ARISING OUT OF YOUR USE OF THE PRODUCT. IN PURCHASING AND USING THIS PRODUCT, YOU ASSUME ALL RESPONSIBILITY FOR CLEANING THE PRODUCT AND MONITORING THE PRODUCT FOR MOLD. ADDITIONALLY, ONTEL® SPECIFICALLY DISCLAIMS ALL EXPRESSED WARRANTIES NOT OTHERWISE SET FORTH HEREIN AND ANY IMPLIED WARRANTIES OF MERCHANTABILITY OR FITNESS FOR A PARTICULAR PURPOSE. THERE ARE NO WARRANTIES WHICH EXTEND BEYOND THE DESCRIPTION OF THE FACE HEREOF.

FOR BEST RESULTS:

1 PRE-SOAK FILTER:

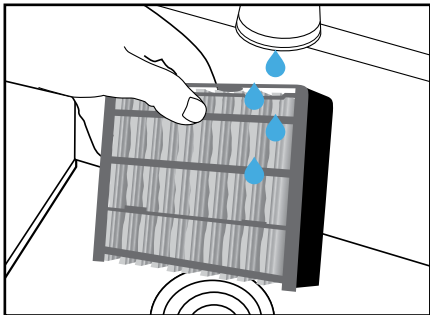

Place your filter under running cold water until wet.

TIP: For even more cooling, place a wet filter in the freezer until frozen.

2 FILL WITH PITCHER:

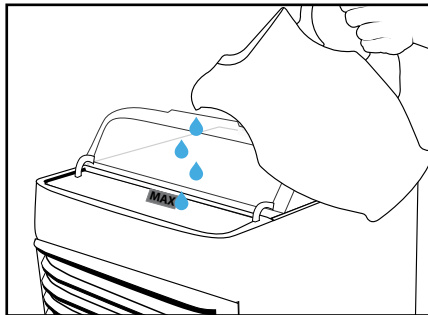

Place on flat surface & fill tank from a water pitcher.

3 SET AIR FLOW:

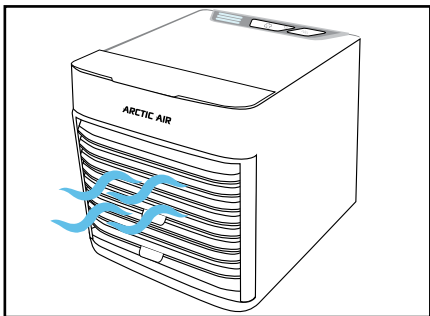

Point towards you, and adjust the grill to direct air flow.

4 FILTER CLEANING:

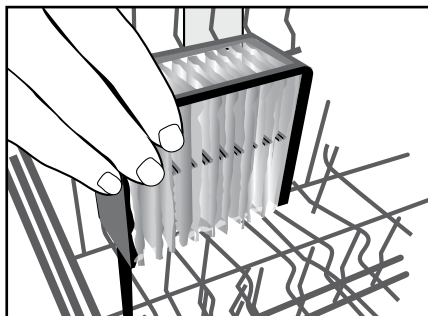

We recommend regular cleaning of your filter. See Product Guide or Care & Cleaning label on filter for instructions.

Please Note: You may notice some condensation forming on the front grill. This is normal.

FOR HOUSEHOLD USE ONLY

Distributed by
Ontel
PRODUCTS CORPORATION

©2018 Ontel Products Corp.
Fairfield, NJ 07004
All Rights Reserved.

Made In China
AAUIM-01-1118-200

Model Number: 18009
AC100~120V
DC 5V, 1.5-2.0A
1217.0101

Free Manuals Download Website

<http://myh66.com>

<http://usermanuals.us>

<http://www.somanuals.com>

<http://www.4manuals.cc>

<http://www.manual-lib.com>

<http://www.404manual.com>

<http://www.luxmanual.com>

<http://aubethermostatmanual.com>

Golf course search by state

<http://golfingnear.com>

Email search by domain

<http://emailbydomain.com>

Auto manuals search

<http://auto.somanuals.com>

TV manuals search

<http://tv.somanuals.com>