

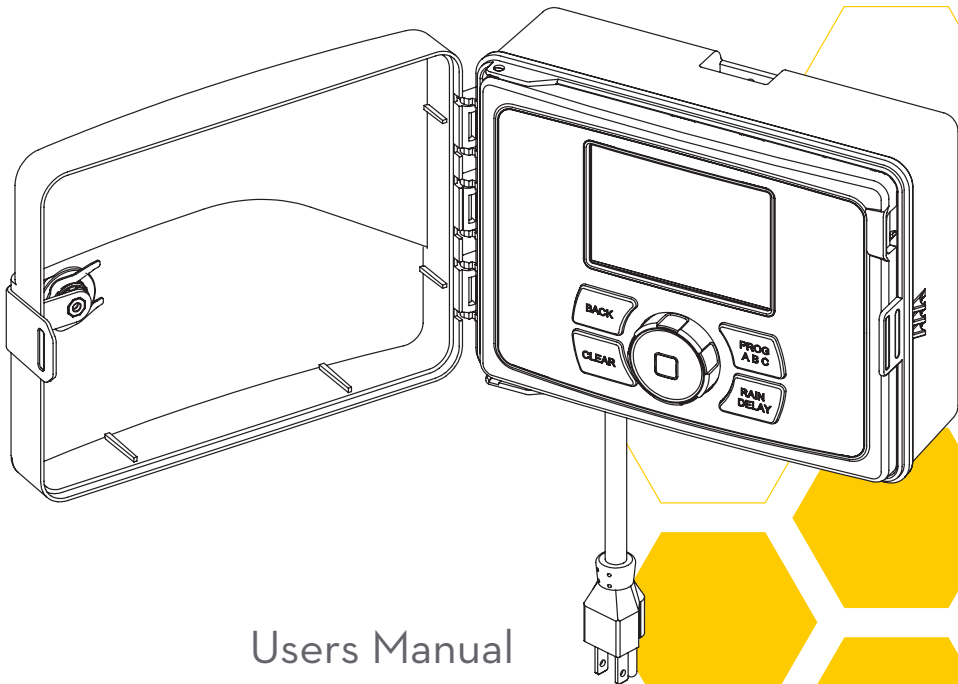

b•hyve™
WIFI SPRINKLER TIMER



Users Manual

57946-50 rA

Welcome to B-hyve™

Thank you for purchasing the Orbit® B-hyve™ wifi sprinkler timer. At Orbit, we share your passion for a beautiful landscape while protecting our most valuable resource—water. For over 40 years, this passion has driven us to deliver top of the line irrigation products to millions of customers all around the world. Our slogan, “Conservation through Innovation,” has driven our product development in timers for decades and continues to define our direction today with the B-hyve™ smart wifi sprinkler timer.

Connecting with B-hyve™

Nature is a wonderful gardener and is always subtly working with you to take care of your landscape. Bees provide a great example of this remarkable, unseen effort to help your plants grow. The beehive is the central hub where this effort is coordinated, and the communication happens. While nature does a great job, sometimes a little help is needed. That is where we come in. When you connect your B-hyve™ timer to your wifi, you are plugging in to nature. The local weather, along with some inputs about your landscape, will work together to deliver the right amount of water to your plants, eliminating water waste and saving you money. Thanks for connecting and welcome to B-hyve™!

Table of Contents

Contents in the Box	4
Getting Started	5
Timer Installation.....	6
Uninstalling/Reinstalling	8
The B-hyve App.....	9
Timer Controls/Features.....	10
Simple Controls.....	11
Using the Dial	12
Using the Back and Clear Buttons	13
Using the Program (PROG ABC) Button... ..	14
Using the Rain Delay Button.....	15
Timer LCD.....	16
Programming the Timer	17
Manual Operation.....	23

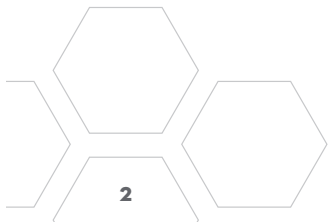

Contents in the Box

- A Wifi Sprinkler Timer
- B Screwdriver
- C Installation Hardware
- D Keys
- E Quick Start Guide

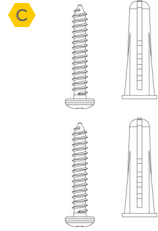
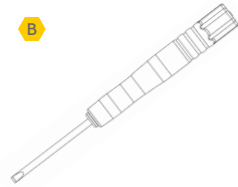
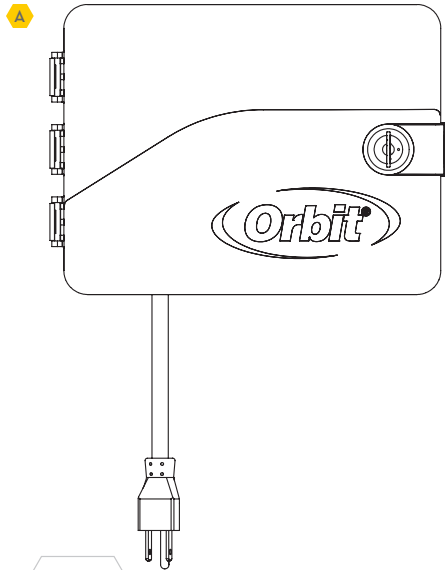

4

Getting Started

Your B-hyve™ sprinkler timer is great for new installations or for replacing an old sprinkler timer. Here are some basic steps to get your timer set up and get you closer to saving water and money.

- **Install the timer**
Choose a location on your property with a good wifi signal.
- **Install the B-hyve™ app on your smart device**
You will need a smart device to connect the timer to wifi. After the timer is paired, you can also use a computer to adjust your timer.
- **Setup your timer with the app or at the timer**
Your timer works with and without wifi—it can be programmed with your smart device or at the timer interface.
- **Note:** If replacing a timer, it is helpful to take a photo of the wires before you remove them from the old timer.

5

Timer Installation

- **Select a location**

Choose a location near power and away from direct sunlight, if possible. Make sure to leave room for the timer door to open completely.

- **Mount the timer**

Install a screw (included) into the wall. Use the expanding anchors (included) for plaster, masonry or drywall installations. Hang the timer on the installed screw using the keyhole slot. Level the timer and use the second screw in one of the preformed mounting holes to secure the timer.

- **Connect valve wires**

Strip 1/2" (12 mm) of insulation from each wire. Connect one wire from each valve to a "Common" (COM) wire and the other wires to a numbered terminal (only one wire per terminal.)

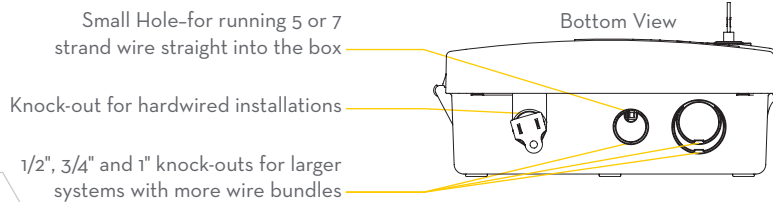
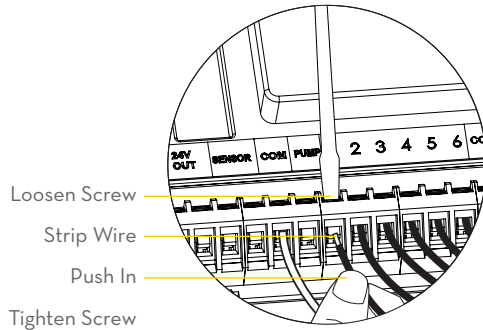
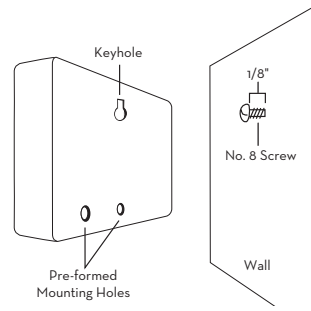

- **Note:** We recommend you consult an electrician for hardwired installations.

Timer Installation-Connecting to WIFI

- **Plug in your Orbit® B-hyve™ timer**

Once your Orbit® timer is plugged into the power source, it will automatically look to pair with your smart device. In the top left corner of the timer screen the "wifi" icon will begin a graduated blinking sequence. This indicates that your timer is ready to pair with a smart device.

- **Install the Orbit® B-hyve™ app and create an account on your smart device**

- **Find Orbit_SmartHome_XXXX in your wifi list**

The B-hyve™ timer will create its own network that will appear in your list of available wifi connections on your smart device. Connect to the Orbit SmartHome network and then return to the Orbit® B-hyve™ app.

- **Enter your wifi settings**

After returning to the app, you will see a list of available networks. Choose your network and then enter the password for the network to connect your timer to your wifi signal. When connected, the wifi icon on the timer will stop blinking and show solid lines.

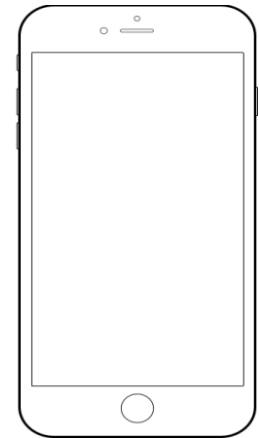
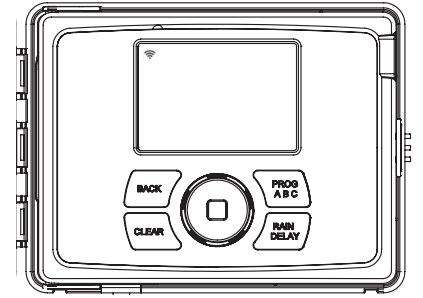

Uninstalling/Reinstalling

- **How to re-pair with wifi**

You can re-pair your smart device with your B-hyve™ timer by turning the dial to “Off” and pressing the reset button on the back of the swing panel. The timer display will show “Pair.”

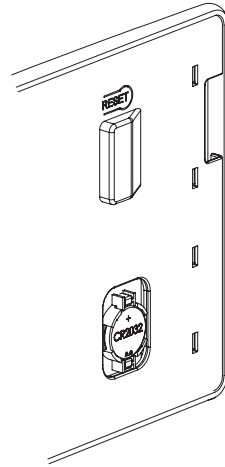

- **Deleting the timer from the app**

You may need to delete the timer from a smart device. Go to settings to deauthorize the timer, after which it will ask for confirmation to remove the timer.

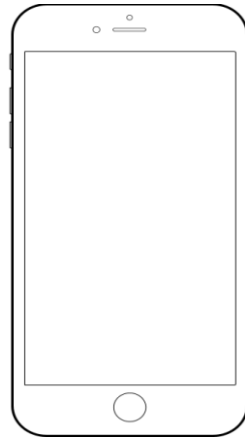

The B-hyve™ App



- **Note:** There is a wizard in the app to guide you through initial set up of your sprinkler timer. In addition, there are help icons throughout the app with more information and useful tips.



Timer Controls/Features

- Your timer was built to make installation easy and fast, while providing convenient controls to make adjustments from anywhere in the world, or when you're standing in front of the timer.

- A** Lock and Latch
- B** Weather Resistant Cover
- C** Dial
- D** Digital Display
- E** Swing Door Panel
- F** Battery Compartment
- G** Transformer
- H** Wiring Terminals
- I** Reset Button
- J** Line Cord

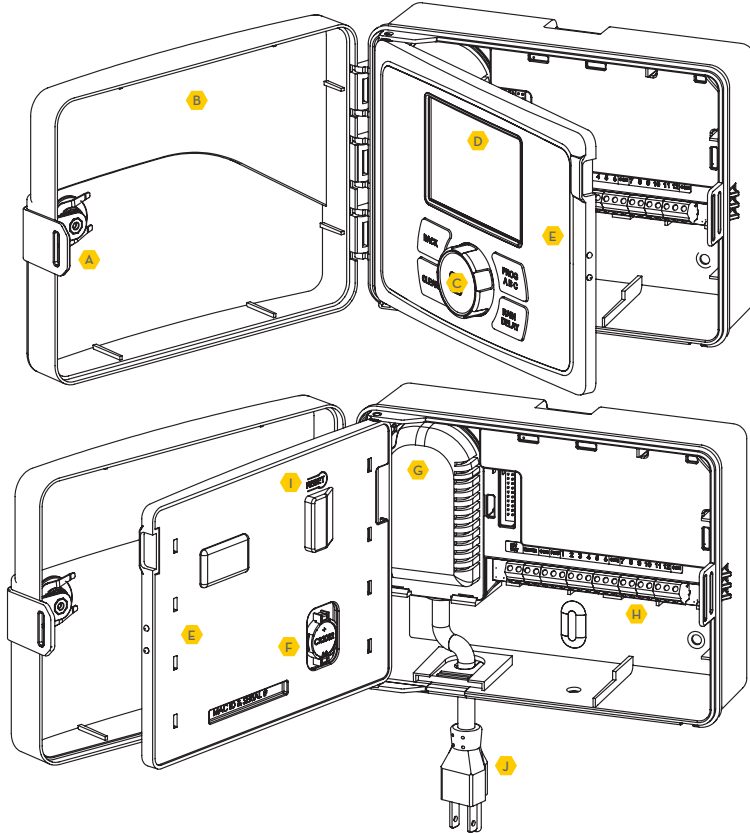

Simple Controls

- Programming at the timer can be done whether you are connected to wifi or not. It allows the gardener who left their phone inside to run a manual cycle, or adjust programming as needed and keep dirty hands away from the phone.

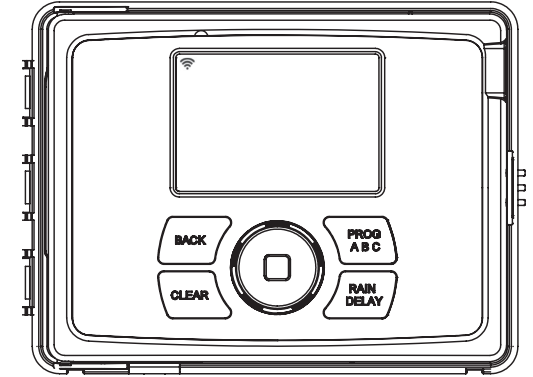

Buttons	Function
	Scroll up or down, left or right and push to make a selection
CLEAR	To clear a setting
PROG ABC	To move to different programs: A, B, and C
BACK	To go back a step
RAIN DELAY	To pause operation for 1 to 32 days due to rain or other factors

Using the DIAL

- The DIAL can be used to scroll up or down, left or right on menus, dates and times.
- Press the DIAL to confirm a selection, to deselect or to skip a running station.

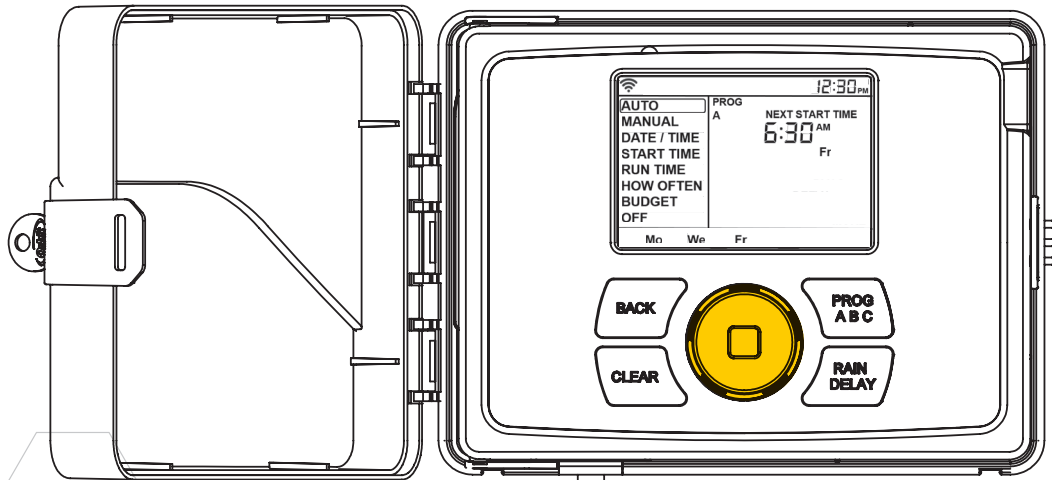

Using the BACK and CLEAR Buttons

- The BACK button can be used return to the main menu, or can be pushed twice to return to auto.
- The CLEAR button can be used to clear entries in a selected screen.
- The CLEAR button may also be used to cancel Rain Delay, cancel a running program or cancel a manual watering cycle.

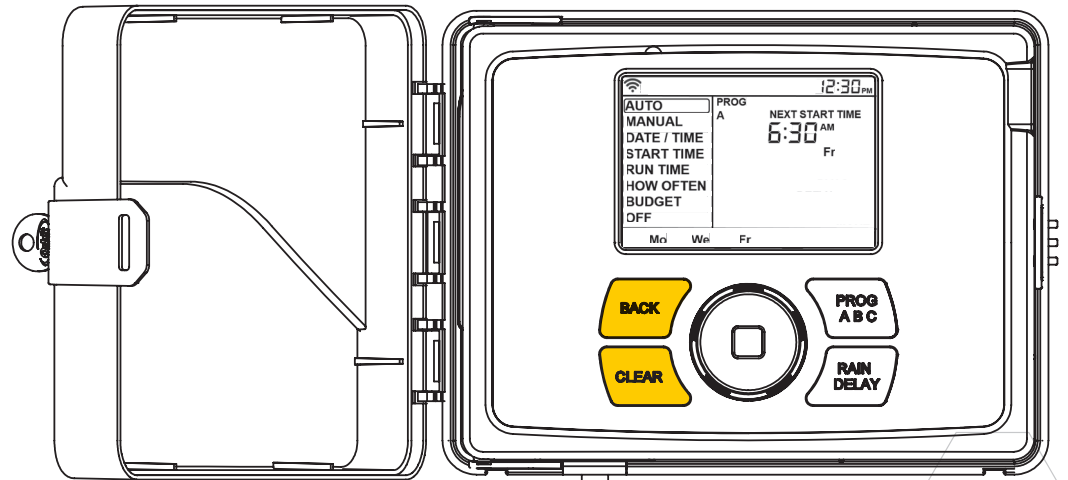

Using the PROGRAM (PROG ABC) Button

- The A, B, C and Smart programs provide the flexibility to set up and run different programs for plants with different watering needs. For example: you could set your lawn zones to run on program A, your flowerbeds to run on program B and your garden to run on program C. Or, you can set up your zones to use smart watering and the timer will use local weather and on-site information to automatically set a watering schedule for you.
- The PROG ABC button toggles between programs when setting up or modifying start times, run times, how long and budget.
- Press PROG ABC to turn on or off programs that have been set-up. A, B, C or Smart will illuminate to show programs that are active and will water.
- **Note:** To water in smart mode only, the Phone icon is the only program that should be showing in the LCD.
- **Note:** If you do not see the program letter (A, B, C or the phone) in the LCD, that program will not water. Press PROG ABC until you see the program(s) that you wish to water.

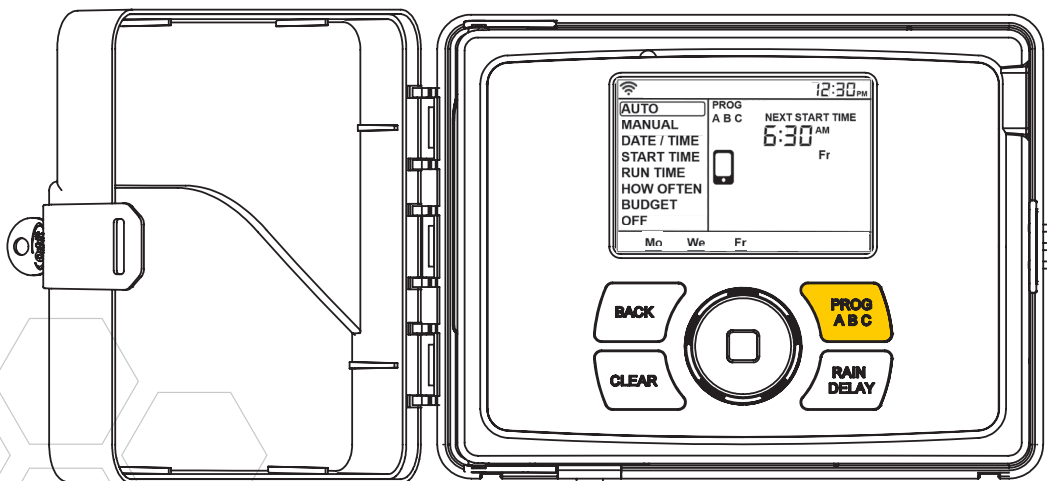

14

Using the RAIN DELAY Button

- The RAIN DELAY button can be used to turn off all watering for a duration of 1 to 32 days.
- Press RAIN DELAY repeatedly, or turn the dial after pressing rain delay once, until the desired number of days is showing in the LCD.
- To cancel a rain delay, press CLEAR.

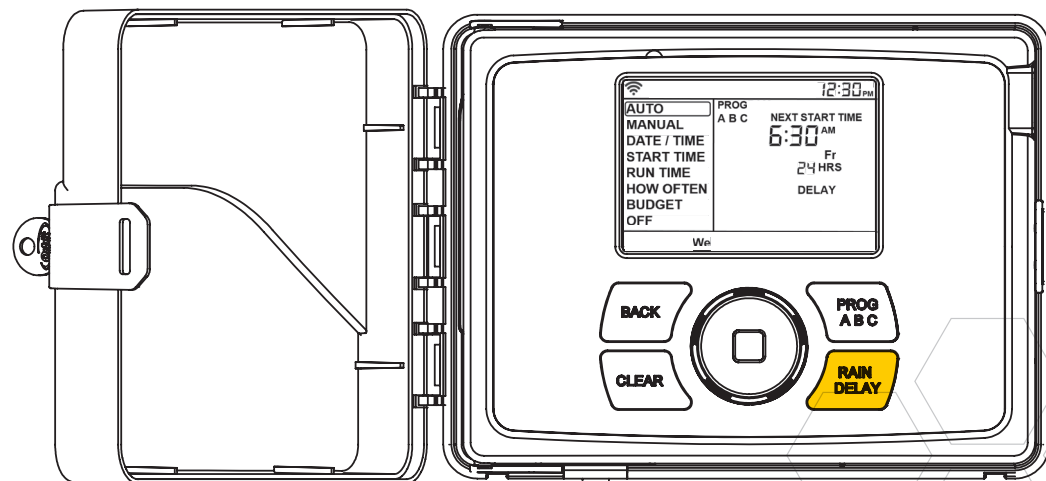

15

Timer LCD

Status Bar	Function
WIFI	Solid—shows signal strength of wifi and indicates that it is connected. Graduated Blinking—indicates the timer is in pairing mode. Blinking—it is not connected to wifi. Solid, with an exclamation point—communicating with wifi, but not communicating with Orbit's servers.
FAULT	Indicates a short in a zone
%	Indicates that water budgeting has been adjusted
RAIN DROP	Indicates a zone is watering
NO AC	There is no AC power getting to the timer
BATTERY	Indicates a low battery. The battery only functions to keep the time and date in the event of power loss. Your program is stored in non-volatile memory and will not be lost if your timer loses power.
CURRENT TIME	If connected to wifi, this is set automatically. Or it can be set manually in Date/Time.

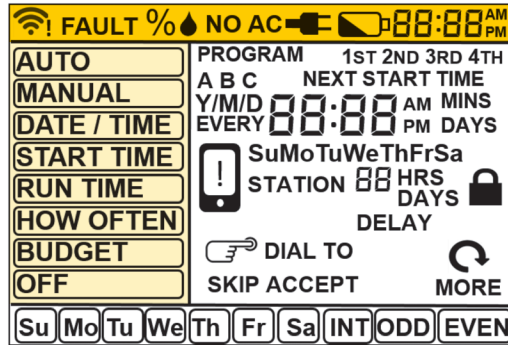

Main Menu	Function
AUTO	Set program is running
MANUAL	To water stations manually
DATE/TIME	Set clock time, Year, Month, and Day
START TIME	Set time to begin watering
RUN TIME	Set watering duration for each station
HOW OFTEN	Set frequency of watering days
BUDGET	Adjust overall watering as a percentage
OFF	Turn all stations/functions off

Programming the Timer-AUTO and OFF

- The timer should be in AUTO during the irrigation season and OFF in the winter months or the non-irrigation months.
- Turn the dial to the AUTO position and press the dial or just leave it there to keep it in AUTO.
- If the dial selection is left in any position other than OFF, it will revert back to AUTO after approximately 20 seconds.
- To turn your timer OFF, turn the dial to OFF and press the dial or just leave it in the OFF position.

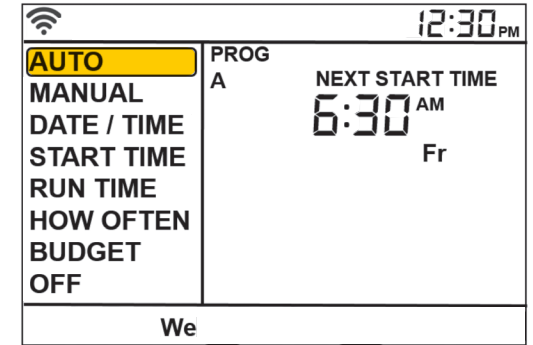

- Note:** Programming for each of the features covered here can be accomplished at the timer or with the app.

Programming the Timer-DATE/TIME

- If you are connected to wifi, the time and date will automatically be sent to the sprinkler timer.
- To set the date and time manually, turn the dial until the selection box is on DATE/TIME and press the dial.
- Set the date by turning the dial until the correct year, month and day are shown and press the dial to confirm each selection.
- When setting the time, press the dial when the right time is set. Be careful to make sure that the am/pm selection is correct.

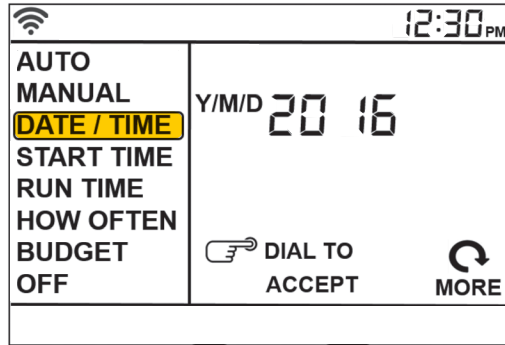

Programming the Timer-START TIME

- This is the time that the first zone will begin watering. Only one start time is needed to run each station in the program.
- Turn the dial until the selection box is on START TIME and press the dial.
- Turn the dial to the desired start hour and press the dial to confirm the selection.
- Turn the dial to the desired start minute and press the dial to confirm the selection.
- **Note:** only one start time is needed to run all of your zones and that start time will show up as 1st. If additional start times are needed, repeat this process. Additional start times are helpful to avoid run off and allow time for the soil to absorb the water.
- Press PROG ABC to set up start times for additional programs.

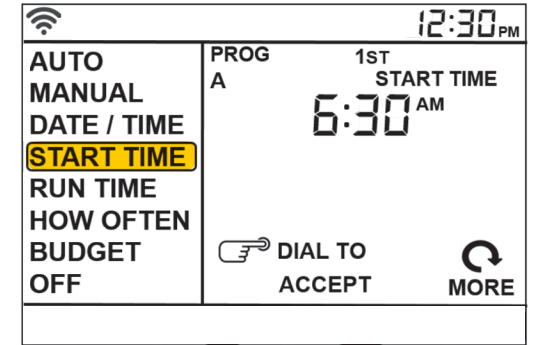

- **Note:** Programming for each of the features covered here can be accomplished at the timer or with the app.

- **Note:** Programming for each of the features covered here can be accomplished at the timer or with the app.

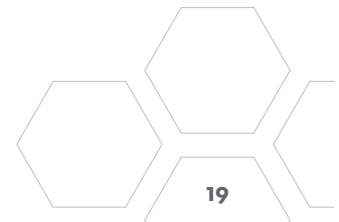

Programming the Timer-RUN TIME

- This is where you will set up how long each zone will run
- Turn the dial until the selection box is on RUN TIME and press the dial.
- The station number will flash-turn the dial until the desired zone is flashing and press the dial.
- The duration for that zone will flash-turn the dial until the desired duration is showing and press the dial.
- Repeat this process for each zone you wish to set up.
- If you wish to set-up zones in different programs, A B or C, press the PROG ABC button until the program is showing in the LCD.

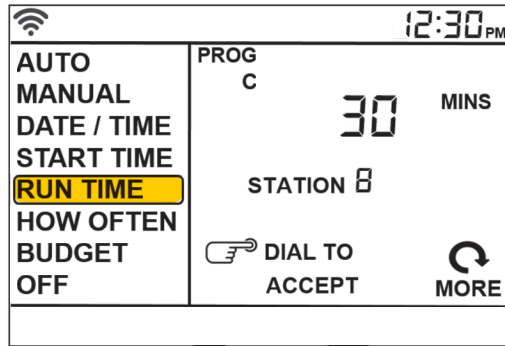

- **Note:** Programming for each of the features covered here can be accomplished at the timer or with the app.

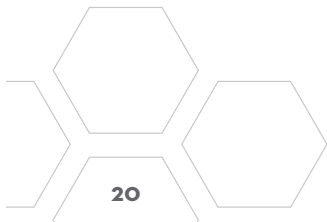

Programming the Timer-HOW OFTEN

- This will determine HOW OFTEN (what days or interval) the timer will water.
- Turn the dial until the selection box is on HOW OFTEN and press the dial.
- Rotate the dial until the desired day of the week or Odd/Even or Int is flashing and press the dial.
- If days of the week are chosen, repeat this process until all of the desired watering days have a box around them.
- If INT (interval) is chosen, rotate the dial until the desired number of days between waterings is showing.
- If you are setting up additional programs, A B or C, press the PROG ABC button until the program is showing in the LCD and repeat this process.

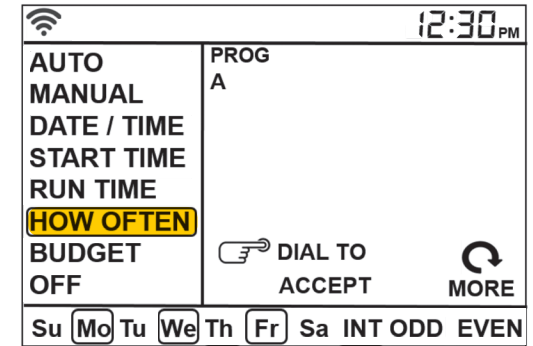

- **Note:** Programming for each of the features covered here can be accomplished at the timer or with the app.



Programming the Timer-BUDGET

- Budget makes it easy to change all of your run times without having to change them one by one.
- Turn the dial until the selection box is on BUDGET and press the dial.
- Adjusting budget will adjust all of the run times in a program by the percentage chosen.
- Example: If you have zones set up to water for 10 minutes and you adjust your budget from 100% to 150%, those same zones will water for 15 minutes without having to change each run time.
- Budget is an easy way to adjust all zones for seasonal changes.
- If you are setting up additional programs, A B or C, press the PROG ABC button until the program is showing in the LCD and repeat this process.

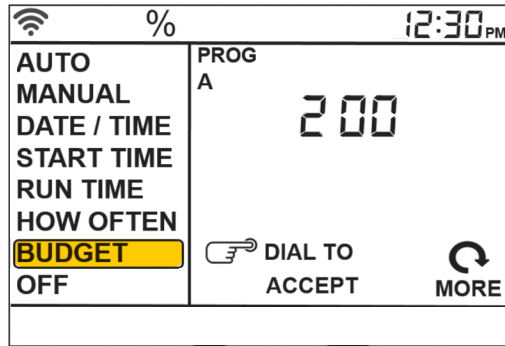

- **Note:** Programming for each of the features covered here can be accomplished at the timer or with the app.

Manual Operation

- Manual is used to test zones or run an extra cycle for a zone, a program or for all zones.
 - Turn the dial until the selection box is on MANUAL and press the dial.
 - ALL will be displayed in the LCD.
 - To water all zones–
 - Press the dial while ALL is displayed and it will ask for a duration.
 - Rotate the dial to the desired duration.
 - Press the dial to begin watering.
 - To water a specific program-A, B or C–
 - When ALL is displayed, rotate the dial until the program you wish to water is showing.
 - Press the dial to begin watering the specified program.
 - To water a specific zone–
 - When ALL is displayed, rotate the dial past the A, B, C programs until Station and a number appear and press the dial.
 - Rotate the dial to the desired zone and press the dial to enter a duration.
 - Rotate the dial to the desired duration and press the dial to begin watering.
- **Note:** you can program more than one specific zone using this process. Repeat the steps for zone selection and duration to water additional zones.

Remember, you can set your timer up with the app. But, if you don't have wifi or just want to make an adjustment while you are outside, you can do it at the timer. Timer changes will be reflected in the app, and app changes will be reflected at the timer.

For more detailed instructions or troubleshooting information, visit bhyve.orbitonline.com

Also, the app has help screens and video to assist you with wifi connections, programming, smart watering and other general questions you may have.

If the app and the website don't have what you're looking for, please call our technical support line.

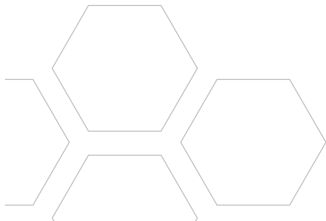

Help

1-800-488-6156 or 1-801-299-5555

www.orbitonline.com

bhyve.orbitonline.com

Before returning this sprinkler timer to the store, contact Orbit® Technical Service at: 1-800-488-6156, 1-801-299-5555

Free Manuals Download Website

<http://myh66.com>

<http://usermanuals.us>

<http://www.somanuals.com>

<http://www.4manuals.cc>

<http://www.manual-lib.com>

<http://www.404manual.com>

<http://www.luxmanual.com>

<http://aubethermostatmanual.com>

Golf course search by state

<http://golfingnear.com>

Email search by domain

<http://emailbydomain.com>

Auto manuals search

<http://auto.somanuals.com>

TV manuals search

<http://tv.somanuals.com>