

MDRC-1119
MDRC-1119 (option TS)
MDRC-1119 (option HB)
MDRC-2120

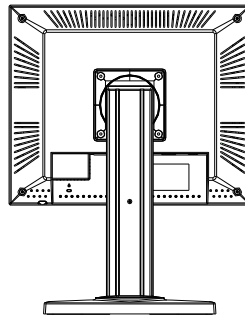
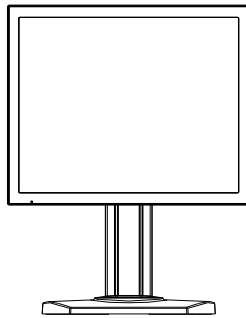

User manual

Copyright notice

This document is copyrighted. All rights are reserved. Nor this document, nor any part of it, may be reproduced or copied in any form or by any means - graphical, electronic, or mechanical including photocopying, taping or information storage and retrieval systems - without written permission of Barco

© 2017 Barco N.V. All rights reserved.

Table of Contents

Table of Contents	3
Preface.....	5
Important notice.....	5
Environmental information.....	6
Safety Instructions.....	7
Recommendations for using your display system.....	11
Unpacking and handling tips	13
Preventing fire and injury.....	13
Cleaning the display.....	14
Shipping/storing the display	15
Explanation of symbols	16
Introduction.....	17
About the product	17
Package Overview.....	19
Installation.....	20
Product Overview	20
Front View.....	20
Back View	21
Tilt	22
Kensington Security Slot.....	22
Start Your Installation.....	22
Connecting the Display.....	23
Adjusting the screen position	25
User Controls	26
Jog Dial Controls	26
How to Use the OSD Menus.....	27
On-Screen Display Menus	28
Appendix	46
Troubleshooting.....	46
Warning Signal	47
Product Dimensions MDRC-1119/MDRC-1119 (option TS)/MDRC-1119 (option HB)	48
Technical specifications MDRC-1119	49
Technical specifications MDRC-1119 (option TS)	51
Technical specifications MDRC-1119 (option HB)	54

Compatibility Modes MDRC -1119/MDRC-1119 (option TS)/MDRC-1119 (option HB)	56
Product Dimensions MDRC-2120	57
Technical specifications MDRC-2120	58
Compatibility Modes MDRC-2120	60
Regulatory Compliance	61

Preface

Important notice

Notice

Although every attempt has been made to achieve technical accuracy in this document, we assume no responsibility for errors that may be found. Our goal is to provide you with the most accurate and usable documentation possible; if you discover errors, please let us know.

Barco software products are the property of Barco. They are distributed under copyright by Barco N.V., for use only under the specific terms of a software license agreement between Barco N.V. and the licensee. No other use, duplication, or disclosure of a Barco software product, in any form, is authorized.

The specifications of Barco products are subject to change without notice.

Trademarks

All trademarks and registered trademarks are property of their respective owners.

Environmental information

Disposal Information

The lamps inside the display contain mercury. Do not throw the display in the trash. Dispose of it as required by local ordinances or regulations.

This equipment has required the extraction and use of natural resources for its production. It may contain hazardous substances for health and environment.

In order to avoid the dissemination of those substances in the environment and to diminish the pressure on natural resources, we encourage you to use the appropriate take-back systems.

Those systems will reuse or recycle most of the materials of your end-of-life equipment in a sound way.



The crossed-out wheeled bin symbol invites you to use those systems.

If you need more information on the collection, reuse and recycling systems, please contact your local or regional waste administrator.

You can also contact us for more information on the environmental performances of our products.

China Energy Label

If there is a China Energy Label on your packaging or product, the product meets the following energy requirements corresponding with the energy efficiency level on the label.





按照中国<<能源效率标识管理办法>> In accordance with The Regulation of the Implementation on China Energy Label	本显示器符合以下要求 This monitor is compliant with the following requirements	本显示器符合以下要求 This monitor is compliant with the following requirements
能源效率等级 Energy Efficiency Level	1	2
能源效率 Energy Efficiency (cd/W)	> 1.05	> 0.85
关闭状态能耗 Energy Consumption in off mode (W)	< 0.5	< 1.0
执行的能源效率国家标准编号 Code of National Standard applied	GB 21520	GB 21520

Safety Instructions

General Recommendations

- Read the safety and operating instructions before operating the display.
- Retain safety and operating instructions for future reference.
- Adhere to all warnings on the display and in the operating instructions manual.
- Follow all instructions for operation and use.

Electrical shock

	Warning-	To prevent the risk of fire or shock hazards, do not expose this product to rain or moisture
	Warning-	Please do not open or disassemble the product as this may cause electric shock.
	Warning-	Do not modify this equipment without authorization of the manufacturer.
	Warning-	To avoid risk of electric shock, this equipment must only be connected to a supply mains with protective earth.
	Warning-	Make sure the user not to contact SIP/SOPs and the patient at the same time.

Classification:

Electrical Shock Protection: Class I.

Disconnect Device: Connect / Remove power cord plug directly.

Degree of Protection Against Electric Shock: No applied part.

Degree of Protection Against Harmful Ingress of Water: Ordinary equipment (IPX0).

Degree of Safety in the Presence of Flammable Anesthetic Mixture with Air or with Oxygen or Nitrous Oxide: Not suitable for use in the presence of a flammable anesthetic mixture with air or with oxygen or nitrous oxide.

Mode of Operation: Continuous.

Intended use

This display is an AMLCD display designed for viewing medical images. This unit should not be used near patients and should be kept outside of 1.50 m perimeter in all directions.

The unit is not intended to be used in any life support system and diagnosis.

Power connection

Power requirements: The display must be powered using a medical approved 12VDC SELV power supply (MDRC-1119, MDRC-1119 (option TS), MDRC-1119 (option HB)) or a 24VDC SELV power supply (MDRC-2120).

The medical approved DC power supply must be powered by the AC mains voltage.

The equipment should be installed near an easily accessible outlet.

Power cords

Utilize a UL-listed detachable power cord, 3-wire, type SJ or equivalent, 18 AWG min., rated 300 V min., provided with a hospital-grade type plug 5-15P configuration for 120V application, or 6-15P for 240V application.

Do not overload wall outlets and extension cords as this may result in fire or electric shock.

Mains lead protection (U.S.: Power cord): Power cords should be routed so that they are not likely to be walked upon or pinched by items placed upon or against them, paying particular attention to cords at plugs and receptacles.

Use a power cord that matches the voltage of the power outlet, which has been approved and complies with the safety standard of your particular country.

Grounding Reliability

Grounding reliability can only be achieved when the equipment is connected to an equivalent receptacle marked 'Hospital Only' or 'Hospital Grade' (located on product or power supply cord).

External equipment

External equipment intended for connection to signal input/output or other connectors, shall comply with relevant UL/ EN/ IEC standard (e.g. UL/EN/IEC 60950 for IT equipment and ANSI/AAMI ES60601-1/EN 60601-1 / IEC 60601 series for medical electrical equipment). In addition, all such combinations – systems – shall comply with the standard IEC 60601-1-1, Safety requirements for medical electrical systems. Equipment not complying with ANSI/AAMI ES60601-1/EN / IEC 60601-1 shall be kept outside the patient environment, as defined in the standard.

Equipment not complying with IEC 60601 must be kept outside the patient environment, as defined in the standard as at least 1.5 meters from the patient or the patient support.

Any person who connects external equipment to signal input, signal output, or other connectors has formed a system and is therefore responsible for the system to comply with the requirements of IEC 60601-1-1. If in doubt, speak with a qualified technician.

In locations where 240V outlets are used, connect this display only on a center-tapped, 240V, single-phase supply.

Water and moisture

Never expose the display to rain or moisture.

Never use the display near water - e.g. near a bathtub, washbasin, swimming pool, kitchen sink, laundry tub or in a wet basement.

Ventilation

Do not cover or block the ventilation openings in the cover of the set. When installing the display in a cupboard or another closed location, heed the necessary space between the set and the sides of the cupboard.

Installation

Place the display on a flat, solid and stable surface that can support the weight of at least 3 displays. If you use an unstable cart or stand, the display may fall, causing serious injury to a child or adult, and serious damage to the equipment.

Recommendations for using your display system

1. Optimize the lifetime of your display

Enabling the Display Power Management System (DPMS) of your display (in the display's Settings menu) will optimize its lifetime by automatically switching off the backlight when the display is not used for a specified period of time. By default, DPMS is enabled on your display, but it also needs to be activated on your workstation. To do this, go to "Power Options Properties" in the "Control Panel".

Barco recommends setting DPMS activation after 20 minutes of non-usage.

2. Use a screen saver to avoid image retention

Prolonged operation of an LCD with the same content on the same screen area may result in a form of image retention.

You can avoid or significantly reduce the occurrence of this phenomenon by using a screen saver. You can activate a screen saver in the "Display properties" window of your workstation.

Barco recommends setting screen saver activation after 5 minutes of non-usage. A good screen saver displays moving content.

In case you are working with the same image or an application with static image elements for several hours continuously (so that the screen saver is not activated), change the image content regularly to avoid image retention of the static elements.

3. Understand pixel technology

LCD displays use technology based on pixels. As a normal tolerance in the manufacturing of the LCD, a limited number of these pixels may remain either dark or permanently lit, without affecting the performance of the product. To ensure optimal product quality, Barco applies strict selection criteria for its LCD panels.

To learn more about LCD technology and missing pixels, consult the dedicated white paper available at www.barco.com/healthcare.

4. Enhance user comfort

Every Barco multi-head display system is color matched with the highest specification in the market.

Barco recommends keeping color-matched displays together. Furthermore, it is important to use all displays of a multi-head configuration at the same rate to preserve color matching throughout the economic lifetime of the system.

5. Maximize Quality Assurance

The 'MediCal QAWeb' system offers online service for high-grade Quality Assurance, providing maximum confidence and uptime.

Learn more and sign up for the free MediCal QAWeb Essential level at www.barco.com/healthcare/qa

Unpacking and handling tips

The MDRC display is a precision instrument that requires proper care to maintain product operation and adherence to specification. Unpack the display and components carefully, then set up and handle the unit properly to avoid damage to the LCD panel.

- Use both hands to grasp the display case when lifting it from the shipping carton, but avoid touching the screen.
- Do not apply pressure to the screen or touch the screen with bare fingers or objects. Pressure can affect image quality. Cosmetics and oils on the skin are both detrimental to the screen and difficult to remove.
- Allow the display to warm up to room temperature before turning it on. Avoid sudden temperature changes in the environment, as this may cause condensation, which damages the display.
- Do not set up the display near strong light or heat sources.
- Do not block the vents on the back of the display or install the display in a built-in enclosure. Blocked vents cause excessive heat to build up inside the display, increasing risk of fire.
- When installing components, turn off your computer, but leave it plugged into a grounded outlet.
- Do not remove the back cover or disassemble the display. There are no user-serviceable parts inside.

Preventing fire and injury

- Replace the power supply or cables if damaged.
- Use only the power source indicated in this guide or listed on the display.

-
- Do not plug the power supply into an overloaded AC outlet or extension cord. Overloaded AC outlets and cords can result in electric shock or fire.
 - Do not drop or push objects into the display case. Internal components contain high voltage.
 - Unplug the power cord from the wall outlet during thunderstorms.
 - Do not place magnetic devices, such as motors, near the display.

Cleaning the display

Observe the following guidelines to maintain display and LCD screen.

- Use a clean, lint-free, absorbent cotton cloth to clear off any residual glue from removal of the protective film or to remove surface dust. Apply light pressure to remove the dust.
- Dampen a clean cloth with a small amount of isopropyl alcohol to remove glue or dust if the screen is still not clean. Do not saturate the cloth; otherwise, alcohol may seep into the display case and collect in the enclosure. Use a clean, dry cloth to completely remove the alcohol residue.
- It is advised to clean the display on weekly basis.
- Do not use chemically treated dust cloths, acetone, toluene, or harsh solvents on the display case or the screen. They can damage the polarizer and the display case.
- Do not expose the display to water or excessive moisture. Do not allow water or other stains to stand on the unit. Wipe liquids off immediately to prevent damage to the display case and the screen.

Shipping/storing the display

Keep the display in its shipping container until installation. Return the display to its original container whenever you need to store the unit, move it to another location, or return it for repair. The packaging supplied by the manufacturer protects the display while it is in transit. See environment specifications for more information.

Before returning the display to the container, do the following:

- 1 Swivel the display panel in landscape mode.
- 2 Push the panel down to the lowest position.
- 3 Use the stand lock to anchor the panel.

Explanation of symbols



DISPOSAL. Do not use household or municipal waste collection services for disposal of electrical and electronic equipment. EU countries require the use of separate recycling collection services.



CAUTION. Read the accompanying text carefully for proper operation and maintenance of the display system.



DIRECT CURRENT



ALTERNATING CURRENT



RELATIVE HUMIDITY

Storage & transport: 5%~ 90% (No condensation)
Operating: 8% ~ 80%



TEMPERATURE

Storage & transport: -20C° to 60C°
Operating: +15°C to +35°C



ISO 7000-1641. Follow operating instructions or consult instructions for use.

Introduction

About the product

Thank you for choosing Barco.

The MDRC series are LCD displays with an active matrix, thin-film transistor (TFT) liquid crystal display (LCD). These products also demonstrate the following outstanding features:

MDRC-1119 / MDRC-1119 (option TS) / MDRC-1119 (option HB)

- Dual Analog and Digital signal.
- 19" diagonal Screen.
- 1280x1024 high resolution.
- Wide Viewing Angle Technology.
- 31.5 ~ 80 kHz horizontal scan.
- 56 ~ 75 Hz refresh rate.
- Auto Adjustment and Re-scaling function.
- High quality full screen re-scaling capability.
- Multilingual OSD user controls.
- VESA DPM power saving.
- Kensington lock capability

MDRC-2120

- Dual Analog and Digital signal.
- 20.1" diagonal Screen.
- 1600x1200 high resolution.
- Wide Viewing Angle Technology.
- 31.5 ~ 93.75 kHz horizontal scan.
- 59 ~ 61 Hz refresh rate.
- Auto Adjustment and Re-scaling function.
- High quality full screen re-scaling capability.
- Multilingual OSD user controls.
- VESA DPM power saving.
- Kensington lock capability

Package Overview

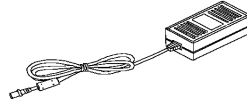
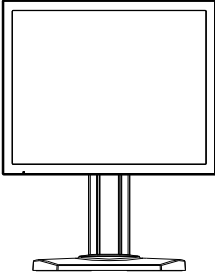

Power Adapter

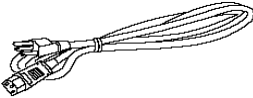

USA Power Cord

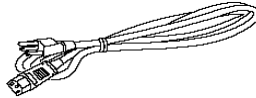

EUR Power Cord

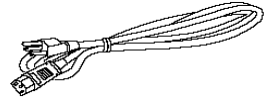

China Power Cord

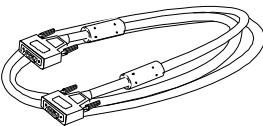

VGA Signal Cable

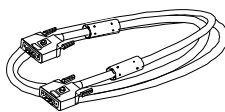

DVI-D Cable



User's Manual

Installation

Product Overview

Front View

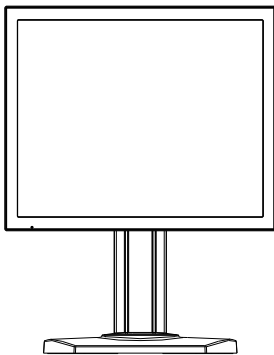

Back View

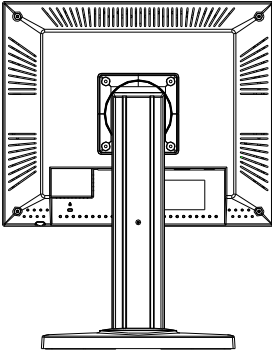

MDRC-1119 / MDRC-1119 (option TS) / MDRC-1119 (option HB)

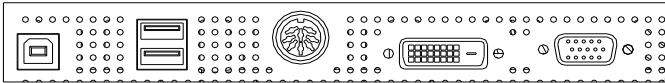

USB Ports

DC Power-In

VGA Input

DVI-D Input

MDRC-2120

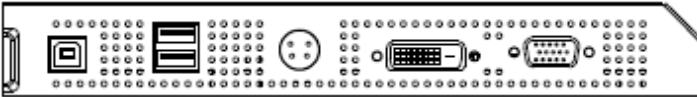

DC Power-In

VGA Input

USB Ports

DVI-D Input

Tilt

Grasp the LCD Display with both hands and adjust the tilt as desired.

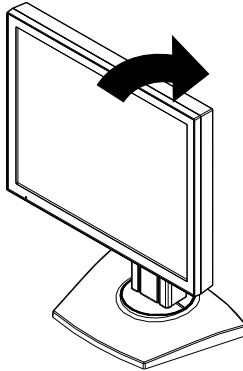

Kensington Security Slot

The Monitor can be secured to your desk or any other fixed object with Kensington lock security products. Kensington lock is not included.

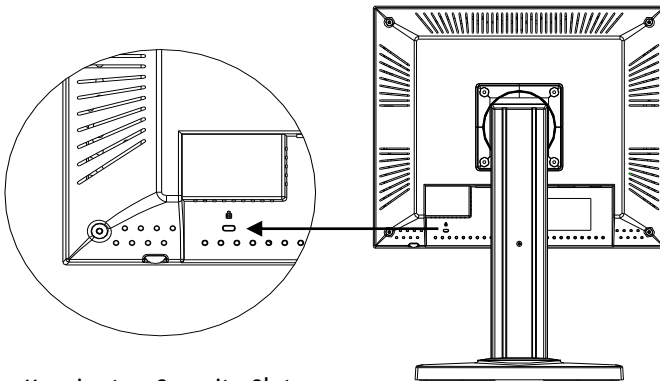

Kensington Security Slot

Start Your Installation

Connecting the Display

Use only the power adapter which are the forming part of each medical device, the power cord, and the video cable shipped with this display.

CAUTION: For MDRC-1119 / MDRC-1119 (option TS): The universal external 12V DC/ 5.0A power adapter (100-240V~, 1.5A, 50-60Hz for power adapter rating) is the BridgePower (BPM060S12F09). For MDRC-2120: The universal external 24V DC/ 2.7A power adapter (100-240V~, 1.5A, 50-60Hz for power adapter rating) is the BridgePower (BPM060S24F09). For MDRC-1119 (option HB): The universal external 12 V DC / 7.0A power adapter (100-240V~, 2.0A, 50-60Hz for power adapter rating) is the BridgePower (JMW190KB1200F09).



To setup this display, please refer to the following figure and procedures.

1. Be sure all equipment is turned off.
2. Connect the DC power cord to the power connector; plug one end of the AC power cord into the power adapter, and the other end into an electrical outlet. (1).
3. For a PC with Analog output: Connect the VGA signal cable from display VGA input connector to the 15-pin connector of your host computer and tighten the screws. (2).
4. For a PC with DVI digital output: Connect the DVI signal cable to the connector of the display card in your computer, connect the other side to the DVI-D input port of your display. Tighten the screws (3).
5. Turn on your computer, display and video source.

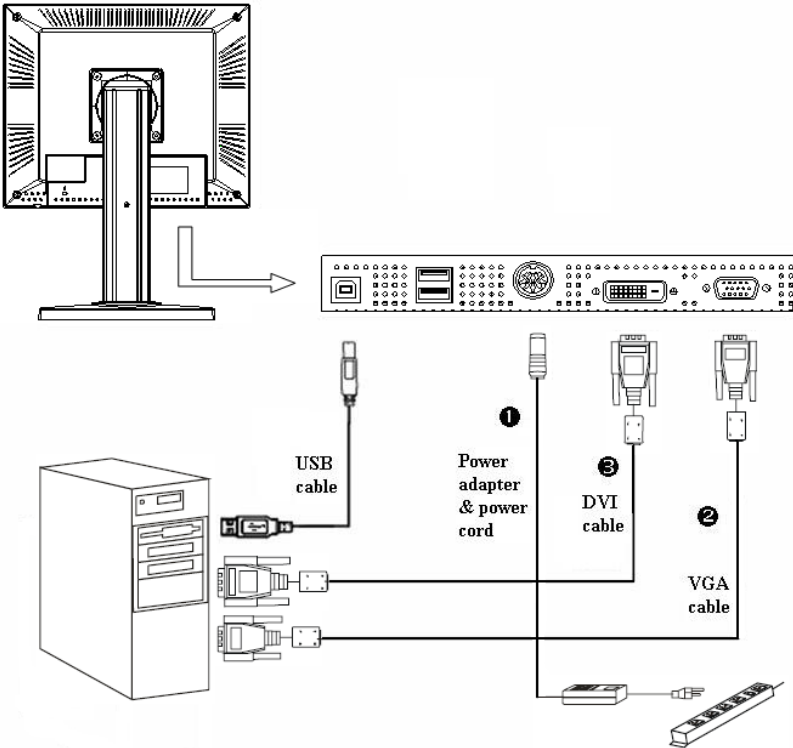
Note: To ensure the LCD Display will work well with your computer, please configure the display mode of your graphics card to make it less than or equal to the native resolution, and make sure the timing of the display mode is compatible with the LCD screen. We have listed the "Compatibility Modes" of this LCD screen in appendices for your reference.



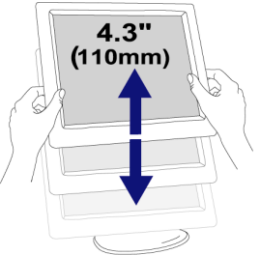
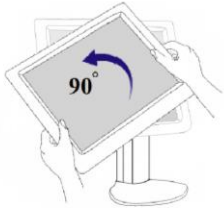
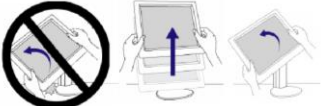
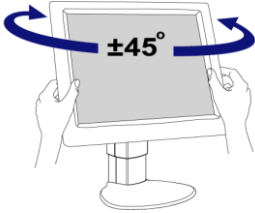
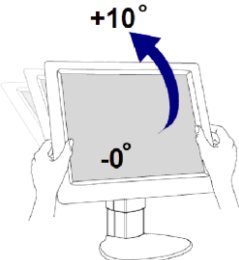
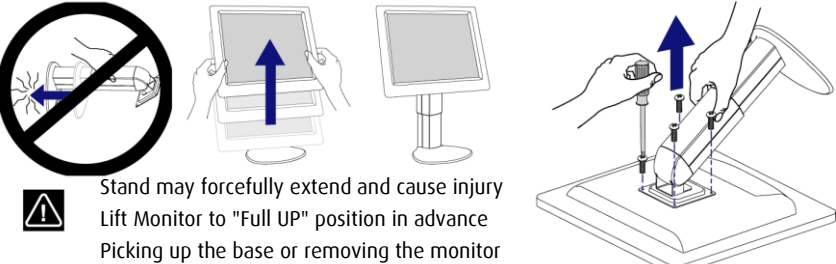

Adjusting the screen position

<p>Vertical Height</p> 	<p>Portrait/Landscape</p>  
<p>Left to Right Pan</p> 	<p>Front to Back Tilt</p> 
<p>Remove Monitor</p>  <p> Stand may forcefully extend and cause injury Lift Monitor to "Full UP" position in advance Picking up the base or removing the monitor</p>	

User Controls

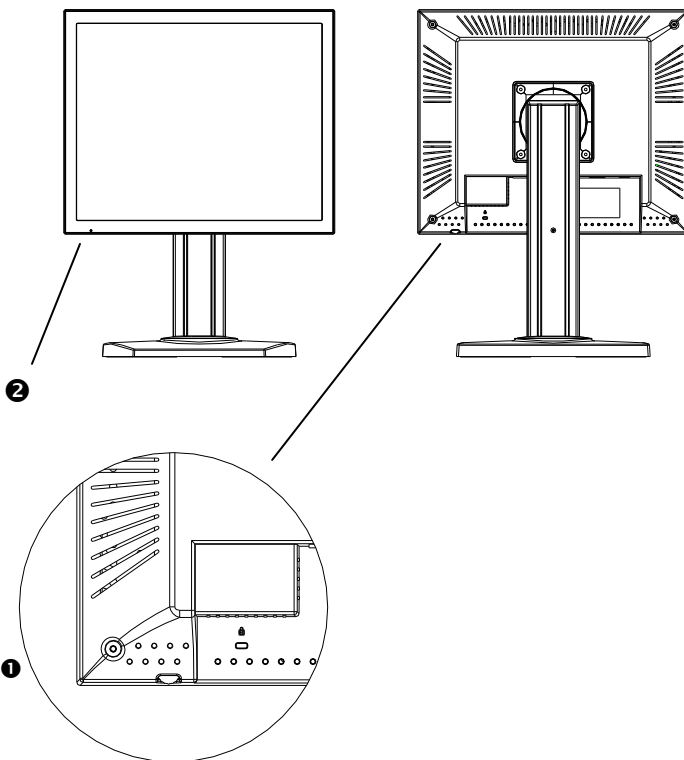
Jog Dial Controls



No./ Icon	Control	Function
1  Jog Dial button	- Power Switch - Menu	1. Press the jog dial button for 1 sec to power off to the LCD Display. 2. Swivel jog dial button for OSD menu
2 LED	Power LED	1. Green indicates the display is turned on. 2. Orange indicates the display is in stand-by mode.

How to Use the OSD Menu

1. Swivel the Jog dial button to pop up the "on-screen menu" and to scroll among the six Main Menus.
2. Choose the adjustment items by pressing the jog dial button.
3. Adjust the value of the adjustment items by swiveling the jog dial button.
4. After a period of inactivity *(based on a user setting), the OSD menu will automatically disappear.

On-Screen Display Menus

Main Menu

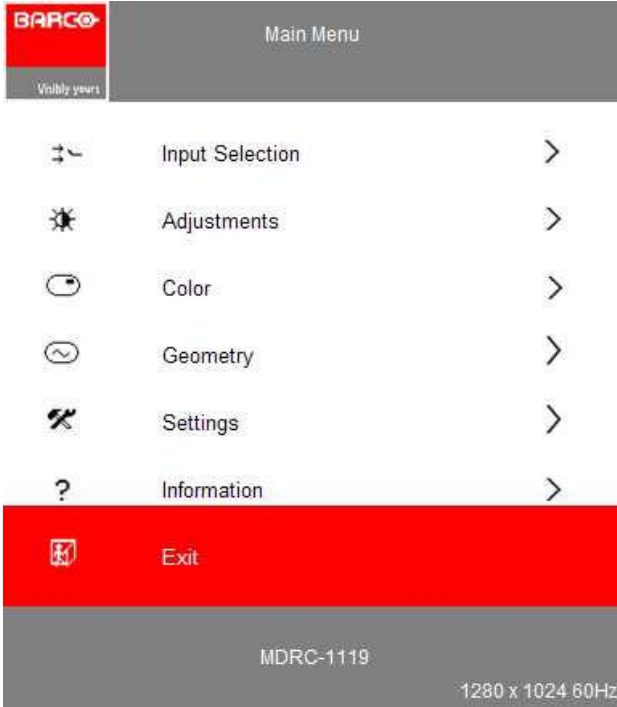

Function	Description
Input Selection	Go to the 'Input Selection Menu' while the jog-dial button is pressed.
Adjustments	Go to the 'Adjustment Menu' while the jog-dial button is pressed.

Color	Go to the 'Color Menu' while the jog-dial button is pressed.
Geometry*	Go to the 'Geometry Menu' while the jog-dial button is pressed.
Settings	Go to the 'Settings Menu' while the jog-dial button is pressed.
Information	Go to the 'Information Menu' while the jog-dial button is pressed.
Exit	Close this menu.

Input selection Menu

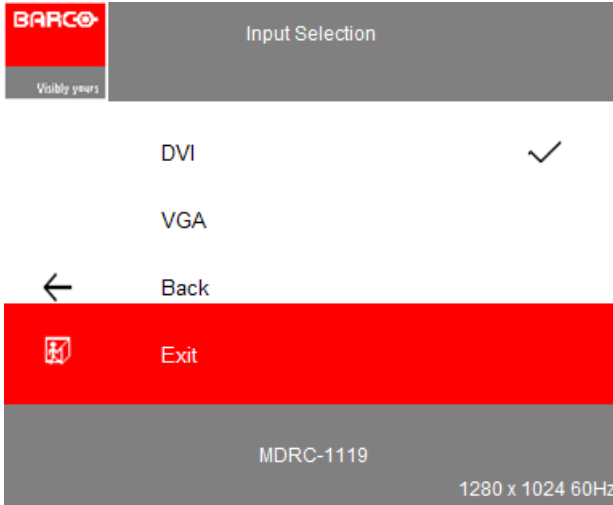

Function	Description
DVI	Select the DVI input while the jog-dial button is pressed.
VGA	Select the VGA input while the jog-dial button is pressed.
Back	Go back to the 'Main Menu'.
Exit	Close this menu.

Adjustments Menu

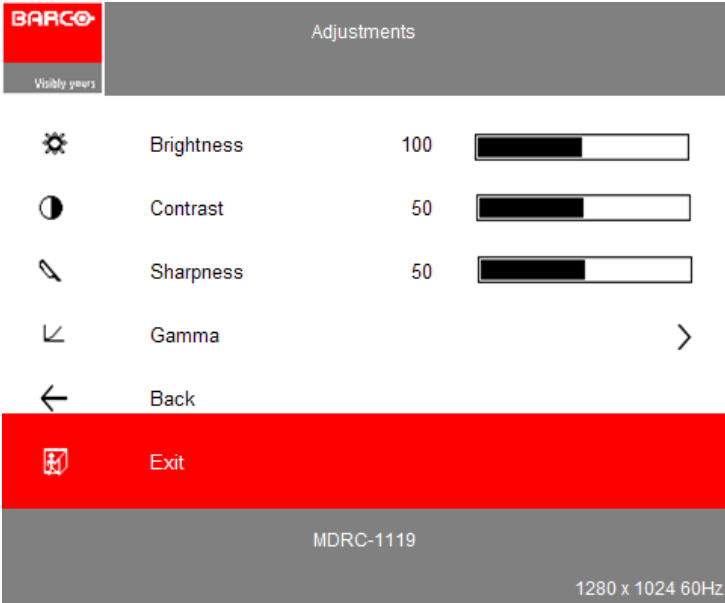

Function	Description
Brightness	To adjust the backlight luminance..
Contrast**	To adjust the image contrast (only applicable if VGA is selected).
Sharpness**	Manual adjustment of the image sharpness (only applicable if VGA is selected)
Gamma	Go to the 'Gamma Menu' while the jog-dial button pressed.
Exit	Close this menu.

Adjustments -> Gamma menu

Function	Description
Native	Select the panel original gamma.
Gamma 1.8	Select the Dynamic Gamma 1.8.
Gamma 2.2	Select the Dynamic Gamma 2.2.
Dicom	Select the Dicom.
User	Select the user defined gamma which built by QAWeb Agent tool.
Back	Go back to the 'Adjustments Menu'
Exit	Close this menu.

Color Menu

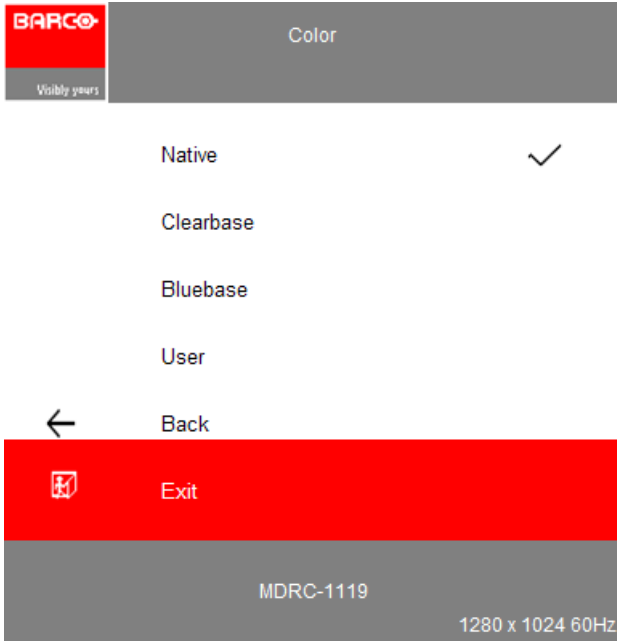

Function	Description
Native	Select the panel original color temperature.
Clearbase	Set the image color temperature to Clearbase
Bluebase	Set the image color temperature to Bluebase
User	Go to the 'User Menu' while the jog-dial button pressed.
Back	Go back to the 'Adjustments Menu'.

Exit	Close this menu.
------	------------------

Color Menu -> User Menu

Function	Description
Red	Turn red gain value manually.
Green	Turn green gain value manually.
Blue	Turn blue gain value manually.
Back	Go back to the 'Color Menu'.
Exit	Close the menu.

Geometry Menu**

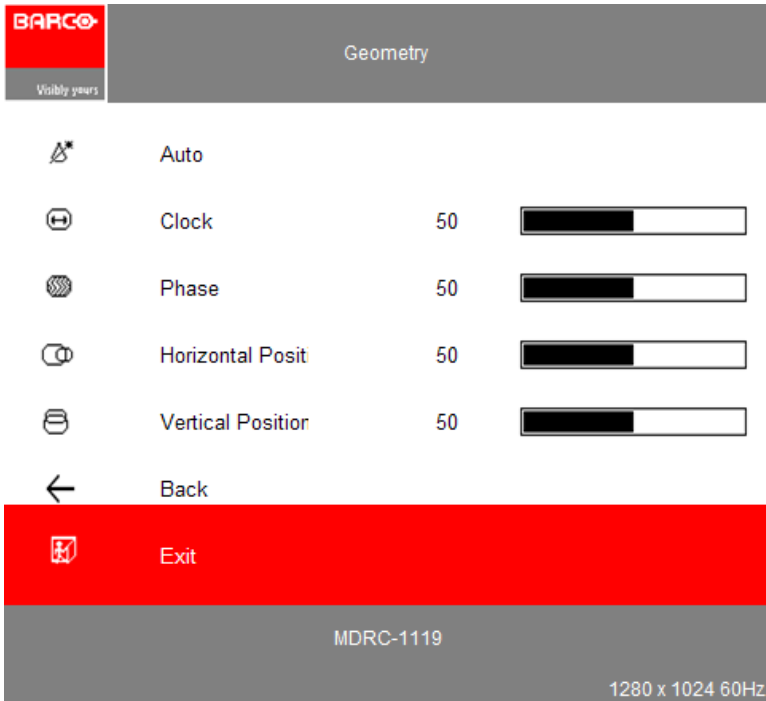

Function	Description
Auto set	Adjust the image parameters to obtain a correctly aligned image automatically while the jog-dial button pressed.
clock	Adjust the internal clock frequency manually. Increase this value to make the image wider, decrease this value to make the image smaller.
Phase	Adjust the internal clock phase manually. If this setting is not correct, the vertical bands with alternate intensity will be visible.

Horizontal position	Adjust the image horizontal position manually.
Vertical position	Adjust the image vertical position manually.
Exit	Close this menu.

Setting Menu

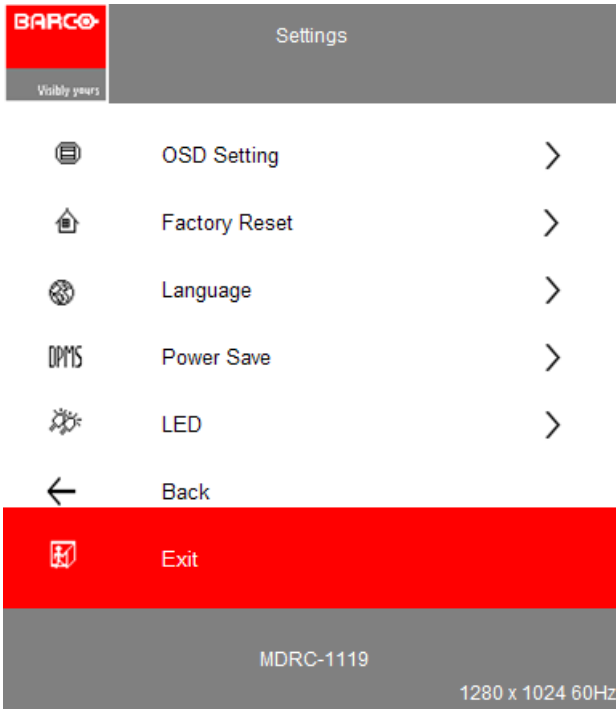

Function	Description
OSD Setting	Go to the 'OSD Settings menu' while the jog-dial button is pressed.
Factory Reset	Go to the 'Factory Reset Menu' while the jog-dial button is pressed.
Language	Go to the 'Language Menu' while the jog-dial button is pressed.

Power Save	Go to the 'Power Save Menu' while the jog-dial button is pressed.
LED	Go to the 'LED Menu' while the jog-dial button is pressed.
Back	Go back to the 'Main Menu'.
Exit	Close this menu.

Settings Menu -> OSD Settings Menu

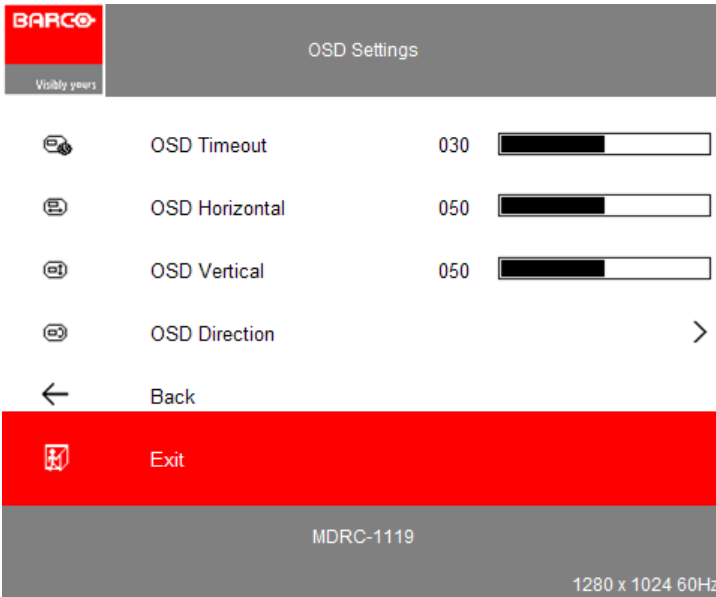

Function	Description
OSD Timeout	Set the OSD timeout value.
OSD Horizontal	Set the OSD horizontal alignment
OSD Vertical	Set the OSD vertical alignment
OSD Direction	Go to the 'OSD Direction Menu' while the jog-dial button pressed.
Back	Go back to the 'Settings Menu'.
Exit	Close the menu.

Settings Menu -> OSD Settings Menu -> OSD Direction

Function	Description
Landscape	Select OSD Landscape.
Portrait	Select OSD Portrait.
Back	Go back to the 'OSD Settings Menu'.
Exit	Close the menu.

Settings Menu -> Factory Reset Menu

Function	Description
Yes	Execute the 'Factory Reset'.
No	Abort the 'Factory Reset'.
Back	Go back to the 'Settings Menu'.
Exit	Close the menu.

Settings Menu -> Factory Reset Menu

Function	Description
English	Execute the 'Factory Reset'.
Français	Select 'Français' as the OSD words while the jog-dial button pressed.
Deutsch	Select 'Deutsch' as the OSD words while the jog-dial button pressed.
Español	Select 'Español' as the OSD words while the jog-dial button pressed.
Italiano	Select 'Italiano' as the OSD words while the jog-dial button pressed.
Nederlands	Select 'Nederlands' as the OSD words while the jog-dial button pressed.
日本語	Select '日本語' as the OSD words while the jog-dial button pressed.
简体中文	Select '简体中文' as the OSD words while the jog-dial button pressed.
繁體中文	Select '繁體中文' as the OSD words while the jog-dial button pressed.
한국	Select '한국' as the OSD words while the jog-dial button pressed.
Back	Go back to the 'Settings Menu'.
Exit	Close the menu.

Settings Menu -> Power Save Menu

Function	Description
On	Enable the 'Power Save' function.
Off	Disable the 'Power Save' function.
Back	Go back to the 'Settings Menu'.
Exit	Close the menu.

Settings Menu -> LED Menu

<i>Function</i>	<i>Description</i>
On	Enable the LED.
Off	Disable the LED.
Back	Go back to the 'Settings Menu'.
Exit	Close the menu.

Information Menu

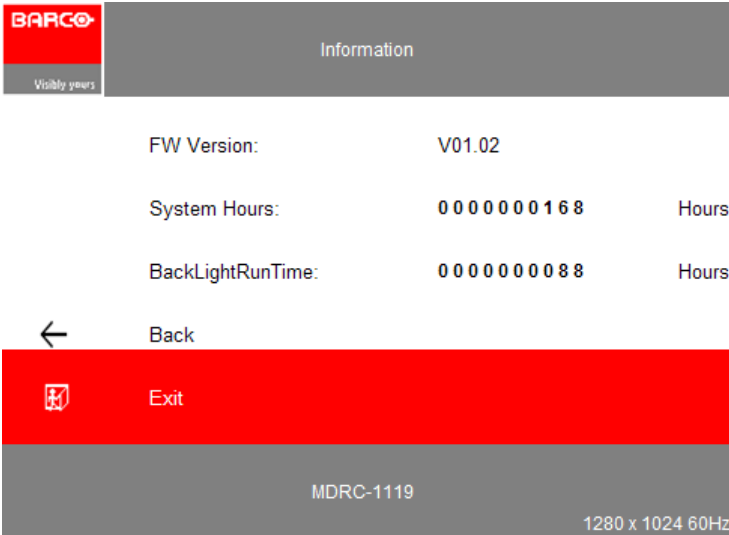

<i>Function</i>	<i>Description</i>
FW version	Firmware version
System hours	System run time
Backlight run time	Backlight run time
Back	Go back to the 'Main Menu'.
Exit	Close the menu.

Notes 1 : Symbol (*) means only active while VGA is selected. Otherwise, it will be un-selectable with gray color, and the subordinate items are blocked.

Note 2: Symbol (**) means only active while VGA is selected. Otherwise, it will be not selectable with gray color.

Appendix

Troubleshooting

If you are experiencing trouble with the LCD display, refer to the following troubleshooting. If the problem persists, please contact your local dealer or our service center.

Problem: No image appears on screen.

- Check that all the I/O and power connectors are correctly and well connected as described in the “Installation” section.
- Make sure the pins of the connectors are not crooked or broken.

Problem: Partial image or incorrectly displayed image.

- Check to see if the resolution of your computer is higher than that of the LCD Display.
- Reconfigure the resolution of your computer to make it less than or equal to the native resolution MDRC-1119, MDRC-1119 (option TS) and MDRC-1119 (option HB) (1280 x 1024) MDRC-2120(1600 x1200)

Problem: Image has vertical flickering line bars.

- Use “Clock” to make an adjustment.
- Check and reconfigure the display mode of the vertical refresh rate of your graphics card to make it compatible with the LCD Display.

Problem: Image is unstable and flickering

- Use “Phase” to make an adjustment.

Problem: Image is scrolling

- Check and make sure the VGA signal cable (or adapter) is well connected.
- Check and reconfigure the display mode of the vertical refresh rate of your graphics card to make it compatible with the LCD Display.

Problem: Vague image (characters and graphics)

- Use “Clock” to make an adjustment. If this problem still exists, use “Phase” to make an adjustment.

Warning Signal

Sometimes you may see warning messages for this LCD Display. This means that the LCD Display cannot correctly receive the signal from the computer graphics card.

No Signal

This message means that the LCD Display has been powered on but it cannot receive any signal from the computer graphics card. Check all the power switches, power cables, and VGA signal cable.

Out Of Range

This message means that the signal of the computer graphics card is not compatible with the LCD Display. When the signal is not included in the compatibility mode we have listed in the Appendices of this manual, the LCD display will show this message.

Product Dimensions MDRC-1119/MDRC-1119 (option TS)/MDRC-1119 (option HB)

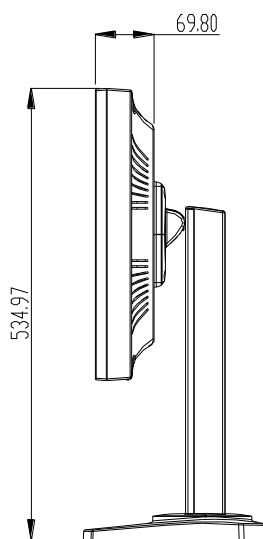
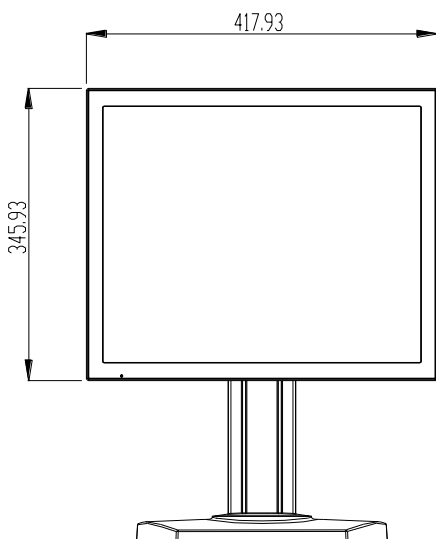
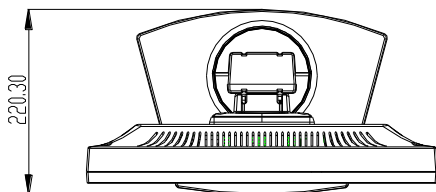

Technical specifications MDRC-1119

Product	MDRC-1119
Technology	TFT Color LCD (VA)
Native resolution	1280 x1024
Active screen diagonal	19" (483 mm)
Active screen area	376 x 301 mm
Pixel Pitch	0.294 x 0.294
Visual Characteristic	
Maximum luminance	300 cd/m ²
DICOM calibrated luminance	180 cd/m ²
Image stabilization	BLOS (Backlight sensor)
Contrast ratio	1300:1
Aspect ratio	5:4
Viewing angle (CR>10)	178°/178°
Display LUT	10 bit
Response time (G-G)	8 ms
Display Functions	Gamma, Dicom
Colors	16.7 million
Connectivity and control	
Video Input	DVI
	VGA (DB15)
	USB (1 upstream, 2 downstream)

OSD languages	English, French, German, Spanish, Italian, Dutch, Simplified Chinese, Traditional Chinese, Korean.
Options	
Protective Cover	Yes
Touch Screen	No
Landscape/Portrait	Yes
Certifications	
EMC	EN 60601-1-2; FCC-B; ICES-001, VCCI, KC, CCC, BSMI
Safety	CE EN 60601-1:2006+A11:2011; ANSI/AAMI ES60601-1 (2005/(R)2012 + C1:2009/(R)2012 + A2:2010/(R)2012), CAN/CSA-C22.2 No. 60601-1(2008), DEMKO-EN 60601-1:2006, CCC, KC, PSE, BSMI
Mechanical characteristics	
Display dimensions (W x H x D) Landscape, w/o pedestal	418 x 346 x 70 mm
Display weight	With Stand : 8.75 kg
	Without Stand : 5.65 kg
Display stand	Tilt, height & swivel
Mounting	VESA 100x100 WARNING: use suitable mounting apparatus to avoid risk of injury.
Power requirements	
System rating	Input: 12Vdc/5A
External DC Power Supply	Input: 100-240Vac (50Hz-60Hz), 1.5A Output: 12Vdc/5A For only use power supply BridgePower: BPM060S12F09
Standby Power	< 1 W

Power consumption	50 Watts
Environmental	
Operational temperature range within specs	+15°C to +35°C
Storage & transport temperature	-20°C to +60°C
Operating humidity	8% - 80% (non-condensing)
Storage & transport humidity	5% - 90% (non-condensing)
Operating altitude	3048 m
Storage & transport altitude	5000 m
Operating pressure	70 kPa – 106 kPa
Storage & transport pressure	50 kPa – 106 kPa

Technical specifications MDRC-1119 (option TS)

Product	MDRC-1119 (option TS)
Technology	TFT Color LCD (VA)
Native resolution	1280 x1024
Active screen diagonal	19" (483 mm)
Active screen area	376 x 301 mm
Pixel Pitch	0.294 x 0.294
Visual Characteristic	
Maximum luminance	300 cd/m ²
DICOM calibrated luminance	180 cd/m ²
Image stabilization	BLOS (Backlight sensor)
Contrast ratio	1300:1

Aspect ratio	5:4
Viewing angle (CR>10)	178°/178°
Display LUT	10 bit
Response time (G-G)	8 ms
Display Functions	Gamma, Dicom
Colors	16.7 million
Connectivity and control	
Video Input	DVI
	VGA (DB15)
	USB (1 upstream, 2 downstream)
OSD languages	English, French, German, Spanish, Italian, Dutch, Simplified Chinese, Traditional Chinese, Korean.
Options	
Protective Cover	No
Touch Screen	Yes
Landscape/Portrait	Yes
Certifications	
EMC	EN 60601-1-2; FCC-B; ICES-001, VCCI, KC, CCC, BSMI
Safety	CE EN 60601-1:2006+A11:2011; ANSI/AAMI ES60601-1 (2005)/(R)2012 + C1:2009/(R)2012 + A2:2010/(R)2012), CAN/CSA-C22.2 No. 60601-1(2008), DEMKO-EN 60601-1:2006, CCC, KC, PSE, BSMI
Mechanical characteristics	
Display dimensions (W x H x D) Landscape, w/o pedestal	418 x 346 x 70 mm

Display weight	With Stand : 9.39 kg
	Without Stand : 6.29 kg
Display stand	Tilt, height & swivel
Mounting	VEESA 100x100 WARNING: use suitable mounting apparatus to avoid risk of injury.
Power requirements	
System rating	Input: 12Vdc/5A
External DC Power Supply	Input: 100-240Vac (50Hz-60Hz), 1.5A Output: 12Vdc/5A For only use power supply BridgePower: BPM060S12F09
Standby Power	< 1 W
Power consumption	50 Watts
Environmental	
Operational temperature range within specs	+15°C to +35°C
Storage & transport temperature	-20°C to +60°C
Operating humidity	8% - 80% (non-condensing)
Storage & transport humidity	5% - 90% (non-condensing)
Operating altitude	3048 m
Storage & transport altitude	5000 m
Operating pressure	70 kPa – 106 kPa
Storage & transport pressure	50 kPa – 106 kPa

Technical specifications MDRC-1119 (option HB)

Product	MDRC-1119 (option HB)
Technology	TFT Color LCD (VA)
Native resolution	1280 x1024
Active screen diagonal	19" (483 mm)
Active screen area	376 x 301 mm
Pixel Pitch	0.294 x 0.294
Visual Characteristic	
Maximum luminance	600 cd/m ²
DICOM calibrated luminance	300 cd/m ²
Image stabilization	BLOS (Backlight sensor)
Contrast ratio	2000:1
Aspect ratio	5:4
Viewing angle (CR>10)	178°/178°
Display LUT	10 bit
Response time (G-G)	8 ms
Display Functions	Gamma, Dicom
Colors	16.7 million
Connectivity and control	
Video Input	DVI
	VGA (DB15)
	USB (1 upstream, 2 downstream)
OSD languages	English, French, German, Spanish, Italian, Dutch, Simplified Chinese, Traditional Chinese, Korean.

Options	
Protective Cover	No
Touch Screen	No
Landscape/Portrait	Yes
Certifications	
EMC	EN 60601-1-2; FCC-B; ICES-001, VCCI, KC, CCC, BSMI
Safety	CE EN 60601-1:2006+A11:2011; ANSI/AAMI ES60601-1 (2005)/(R)2012 + C1:2009/(R)2012 + A2:2010/(R)2012), CAN/CSA-C22.2 No. 60601-1(2008), DEMKO-EN 60601-1:2006, CCC, KC, PSE, BSMI
Mechanical characteristics	
Display dimensions (W x H x D) Landscape, w/o pedestal	418 x 346 x 70 mm
Display weight	With Stand : 7.61 kg
	Without Stand : 4.42 kg
Display stand	Tilt, height & swivel
Mounting	VESA 100x100 WARNING: use suitable mounting apparatus to avoid risk of injury.
Power requirements	
System rating	Input: 12Vdc/7A
External DC Power Supply	Input: 100-240Vac (50Hz-60Hz), 2.0A Output: 12Vdc/7A For only use power supply BridgePower: JMW190KB1200F09
Standby Power	< 1 W
Power consumption	47 Watts

Environmental	
Operational temperature range within specs	+15°C to +35°C
Storage & transport temperature	-20°C to +60°C
Operating humidity	8% - 80% (non-condensing)
Storage & transport humidity	5% - 90% (non-condensing)
Operating altitude	3048 m
Storage & transport altitude	5000 m
Operating pressure	70 kPa – 106 kPa
Storage & transport pressure	50 kPa – 106 kPa

Compatibility Modes MDRC -1119/MDRC-1119 (option TS)/MDRC-1119 (option HB)

Standard	Resolution	Vertical Refresh (Hz)	Horizontal Scan (KHz)
IBM VGA	640x350	70	31.5
IBM VGA	640x480	60	31.5
IBM VGA	720x400	70	31.5
VESA VGA	640x480	72	37.9
VESA VGA	640x480	75	37.5
VESA SVGA	800x600	56	35.1
VESA SVGA	800x600	60	37.9
VESA SVGA	800x600	72	48.1
VESA SVGA	800x600	75	46.9
VESA XGA	1024x768	60	48.4
VESA XGA	1024x768	70	56.5
VESA XGA	1024x768	75	60.0

VESA XGA	1152x870	60	54.36
VESA XGA	1152x864	75	68.1
VESA SXGA	1280x1024	60	63.96
VESA SXGA	1280x1024	75	79.95
Apple Mac II	640x480	67	35.0
Apple Mac	832x624	75	49.7
Apple Mac	1024x768	75	60.2

Product Dimensions MDRC-2120

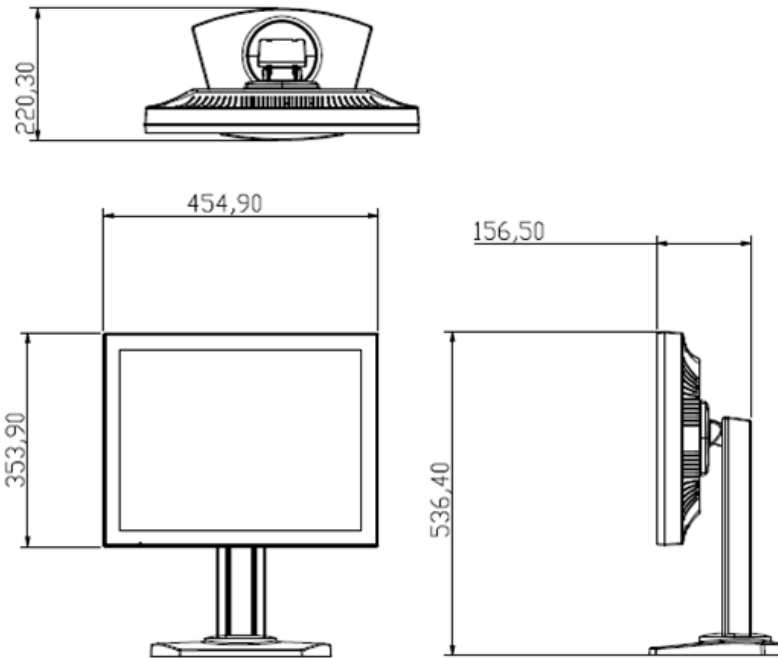

Technical specifications MDRC-2120

Product	MDRC-2120
Technology	TFT Color LCD (IPS)
Native resolution	1600 x1200
Active screen diagonal	20.1" (510.54 mm)
Active screen area	432 x 331.5 mm
Pixel Pitch	0.255 x 0.255
Visual Characteristic	
Maximum luminance	300 cd/m2
DICOM calibrated luminance	180 cd/m2
Image stabilization	BLOS (Backlight sensor)
Contrast ratio	800:1
Aspect ratio	4:3
Viewing angle (CR>10)	178°/178°
Display LUT	10 bit
Response time (G-G)	6 ms
Display Functions	Gamma, Dicom
Colors	16.7 million
Connectivity and control	
Video Input	DVI
	VGA (DB15)
	USB (1 upstream, 2 downstream)

OSD languages	English, French, German, Spanish, Italian, Dutch, Simplified Chinese, Traditional Chinese, Korean.
Options	
Protective Cover	Yes
Touch Screen	No
Landscape/Portrait	Yes
Certifications	
EMC	EN 60601-1-2; FCC-B; ICES-001, VCCI, KC, CCC, BSMI
Safety	CE EN 60601-1:2006+A11:2011; ANSI/AAMI ES60601-1 (2005/(R)2012 + C1:2009/(R)2012 + A2:2010/(R)2012), CAN/CSA-C22.2 No. 60601-1(2008), DEMKO-EN 60601-1:2006, CCC, KC, PSE, BSMI
Mechanical characteristics	
Display dimensions (W x H x D) Landscape, w/o pedestal	455 x 354 x 70 mm
Display weight	With Stand : 9.8 kg
	Without Stand : 6.0 kg
Display stand	Tilt, height & swivel
Mounting	VESA 100 x 100 mm WARNING: use suitable mounting apparatus to avoid risk of injury.
Power requirements	
System rating	Input: 24Vdc/2.7A
External DC Power Supply	Input: 100-240Vac (50Hz-60Hz), 1.5A Output: 24Vdc/2.7A For only use power supply BridgePower: BPM060S24F09
Standby Power	< 1 W

Power consumption	55 Watts
Environmental	
Operational temperature range within specs	+15°C to +35°C
Storage & transport temperature	-20°C to +60°C
Operating humidity	8% - 80% (non-condensing)
Storage & transport humidity	5% - 90% (non-condensing)
Operating altitude	3000 m
Storage & transport altitude	5000 m
Operating pressure	70 kPa – 106 kPa
Storage & transport pressure	50 kPa – 106 kPa

Compatibility Modes MDRC-2120

Standard	Resolution	Vertical Refresh (Hz)	Horizontal Scan (KHz)
VGA	640x480	60	31.50
SVGA	800x600	60	37.68
XGA	1024x768	60	48.36
	1152*870	60	54.36
SXGA	1280*1024	60	63.96
1MP2FH	1280*1024	60	62.50
	1024*1280	59	77.78
UXGA	1600*1200	60	75.00
2MP2FH	1600*1200	59	72.81
	1200*1600	59	95.84

Regulatory Compliance

Canada, European Union, United States



MEDICAL – GENERAL
MEDICAL EQUIPMENT
AS TO ELECTRICAL SHOCK,
FIRE AND MECHANICAL
HAZARDS ONLY
IN ACCORDANCE WITH
ANSI/AAMI ES60601-1,
CAN/CSA-C22.2 NO.60601-1

This display has been tested and found to comply with IEC/EN 60601-1 and IEC 60601-1-2 standards, and is certified to meet medical standard ANSI/AAMI ES60601-1 and CAN/CSA C22.2 No 60601.1(C US Mark) which

are related to electrical shock, fire and mechanical hazards only as shown on right UL mark on this page.

The medical display, in addition to meeting medical requirements, has been tested and found to comply with the limits for Federal Communications Commission (FCC) Class B computing devices in a typically configured system since many medical offices are located in residential areas. It is the system integrator’s responsibility to test and ensure that the entire system complies with applicable electromagnetic compatibility (EMC) laws.

Barco NV has made great efforts to support the medical device industry, in particular, medical device manufacturers and medical device system integrators. We offer state-of-the-art color displays that are compliant with worldwide accepted medical device safety standards, and for the European market, CE-marked displays based on compliance with counsel directive 93/42/EEC—commonly referred to as the Medical Device Directive (MDD). The following summarizes our qualification of these displays as it relates to compliance with the MDD.

The European Medical Device Directive requires that the intended use of the device be defined. The intended use of these displays is “to display alphanumeric, graphic, and image data as inputted from any type of medical device.” These displays do not provide a measurement function in any way, and it is the device and systems manufacturer’s responsibility to verify its function in the integrated device or system.

The display was classified as required by the MDD according to Annex IX of the directive and the medical device (MEDDEV) guidance available at the time of classification. Because the display uses electrical energy and has no direct patient connections and—by itself—no medical utility, the display is classified according to Rule 12 as an MDD Class I device, component, or accessory. The MDD states that manufacturers of Class I medical devices or accessories shall satisfy the requirements in regard to design and manufacturing controls, that is, the applicable assessment route to be used for CE-marking under the MDD, and it shall carry the CE mark according to Annex XII of the directive, with no notified body annotation.

In the opinion of Barco NV registration required to put this device into commerce is the responsibility of the medical device/system manufacturer, and Barco supports this requirement by providing a European Commission (EC) declaration of conformity. If Barco supplies a display to an end user, rather than a device manufacturer, it is the end user's responsibility to ensure continued compliance with the MDD of the system in which the display is integrated.

The supplier will make available on request, circuit diagrams, component part lists, etc.

For vigilance reporting as required under Article 10 of the MDD, Barco NV will provide any information requested by competent authority to support any reported incident investigation by such an authority.

Contra-indications

This display is not intended to be used for direct diagnosis and therapeutic interventional radiology.

EU Declaration of Conformity for Medical Application

A Declaration of Conformity has been filed for this product. For additional copies of the Declaration of Conformity document, contact Barco NV

The MDRC series digital flat-panel display meets the essential health and safety requirements, is in conformity with, and the CE marking has been applied according to the relevant EU Directives listed below, using the relevant section of the following EU standards and other normative documents;

EU EMC Directive 2004/108/EC

EU Electromagnetic Compatibility Directive

EN 60601-1-2 (2007)	Collateral standard electromagnetic
Medical Electrical Equipment	compatibility requirements
EN 55011 (Class B)	Limits and methods of measurements for radio interference characteristics of industrial, scientific, and medical equipment
IEC 61000-3-2	Harmonic emissions
IEC 61000-3-3	Voltage fluctuations/flicker emissions
IEC 61000-4-2	Electrostatic discharge requirements for industrial process measurement and control equipment
IEC 61000-4-3	Radiated electromagnetic field requirements for industrial process measurement and control equipment
IEC 61000-4-4	Electrically fast transients for industrial process measurement

	and control equipment
IEC 61000-4-5	Surge requirements
IEC 61000-4-11	Voltage variations/dips/interrupts
IEC 61000-4-6	Conducted immunity
IEC 61000-4-8	Magnetic field immunity
EN 60601-1 Medical Part 1	General requirements for safety Electrical Equipment.

U.S. FCC Compliance Statement

This device complies with Part 15 of the FCC Rules.

Operation is subject to the following two conditions:

(1) This device may not cause harmful interference, and (2) this device must accept any interference received, including interference that may cause undesired operation.

NOTE: This equipment has been tested and found to comply with the limits for a Class B digital device, pursuant to Part 15 of the FCC Rules. These limits are designed to provide reasonable protection against harmful interference in a residential installation. This equipment generates, uses, and can radiate radio frequency energy and, if not installed and used in accordance with the instruction, may cause harmful interference to radio communications.

However, there is no guarantee that interference will not occur in a particular installation. If this equipment does cause harmful interference to radio or television reception, which can be determined by turning the equipment off and on, the user is encouraged to try to correct the interference by one or more of the following measures:

- Reorient or relocate the receiving antenna.

-
- Increase the separation between the equipment and receiver.
 - Connect the equipment into an outlet on a circuit different from that to which the receiver is connected.
 - Consult the dealer or an experienced radio/TV technical for help.

CAUTION: Changes or modifications to this equipment not expressly approved by the party responsible for compliance could void the user's authority to operate the equipment.

Other countries

Japan VCCI level B

Korea KC

PRC CCC level B

Taiwan BSMI level B



B4100531-08
November 2017

Barco NV

Beneluxpark 21, 8500 Kortrijk, Belgium

Phone: +32 56.23.32.11

Fax: +32 56.26.22.62

Support: www.barco.com/en/support

Visit us at the web: www.barco.com

Registered address: Barco NV

President Kennedypark 35, 8500 Kortrijk, Belgium

Phone: +32 56.23.32.11

Fax: +32 56.26.22.62

Support: www.barco.com/en/support

Visit us at the web: www.barco.com



Free Manuals Download Website

<http://myh66.com>

<http://usermanuals.us>

<http://www.somanuals.com>

<http://www.4manuals.cc>

<http://www.manual-lib.com>

<http://www.404manual.com>

<http://www.luxmanual.com>

<http://aubethermostatmanual.com>

Golf course search by state

<http://golfingnear.com>

Email search by domain

<http://emailbydomain.com>

Auto manuals search

<http://auto.somanuals.com>

TV manuals search

<http://tv.somanuals.com>