

B-CONTROL ▶ DEEJAY BCD2000

User's Manual

GB

Version 1.0 June 2005



www.behringer.com



B-CONTROL ► DEEJAY BCD2000

IMPORTANT SAFETY INSTRUCTIONS



CAUTION: To reduce the risk of electric shock, do not remove the top cover (or the rear section). No user serviceable parts inside; refer servicing to qualified personnel.

WARNING: To reduce the risk of fire or electric shock, do not expose this appliance to rain and moisture. The apparatus shall not be exposed to dripping or splashing and no objects filled with liquids, such as vases, shall be placed on the apparatus.



This symbol, wherever it appears, alerts you to the presence of uninsulated dangerous voltage inside the enclosure—voltage that may be sufficient to constitute a risk of shock.



This symbol, wherever it appears, alerts you to important operating and maintenance instructions in the accompanying literature. Please read the manual.

DETAILED SAFETY INSTRUCTIONS:

- 1) Read these instructions.
 - 2) Keep these instructions.
 - 3) Heed all warnings.
 - 4) Follow all instructions.
 - 5) Do not use this apparatus near water.
 - 6) Clean only with dry cloth.
 - 7) Do not block any ventilation openings. Install in accordance with the manufacturer's instructions.
 - 8) Do not install near any heat sources such as radiators, heat registers, stoves, or other apparatus (including amplifiers) that produce heat.
 - 9) Do not defeat the safety purpose of the polarized or grounding-type plug. A polarized plug has two blades with one wider than the other. A grounding type plug has two blades and a third grounding prong. The wide blade or the third prong are provided for your safety. If the provided plug does not fit into your outlet, consult an electrician for replacement of the obsolete outlet.
 - 10) Protect the power cord from being walked on or pinched particularly at plugs, convenience receptacles, and the point where they exit from the apparatus.
 - 11) Only use attachments/accessories specified by the manufacturer.
 - 12) Use only with the cart, stand, tripod, bracket, or table specified by the manufacturer, or sold with the apparatus. When a cart is used, use caution when moving the cart/apparatus combination to avoid injury from tip-over.
- 
- 13) Unplug this apparatus during lightning storms or when unused for long periods of time.
 - 14) Refer all servicing to qualified service personnel. Servicing is required when the apparatus has been damaged in any way, such as power supply cord or plug is damaged, liquid has been spilled or objects have fallen into the apparatus, the apparatus has been exposed to rain or moisture, does not operate normally, or has been dropped.
 - 15) **CAUTION** - These service instructions are for use by qualified service personnel only. To reduce the risk of electric shock do not perform any servicing other than that contained in the operation instructions unless you are qualified to do so.

B-CONTROL ► DEEJAY BCD2000

The Ultimate DJ Machine—Play, Mix and Scratch any MP3 and WAV Files just like Vinyl Records

GB

- ▲ Play, mix and scratch any MP3 and WAV files just like vinyl records with ultra-low latency
- ▲ Full-speed USB 4-channel audio interface plus high-resolution 24-bit A/D and D/A converters
- ▲ Perfectly complements the included BEHRINGER B-DJ software or any other DJ software
- ▲ 2 scratch wheels support creative DJing such as scratching, pitch bending and cue searching
- ▲ Full-fledged DJ mixer control panel with premium quality mic preamp, 3-band kill EQ per channel, ultra-precise faders, super-smooth crossfader and talkover function
- ▲ 2 state-of-the-art phono preamplifiers—one switchable to CD player
- ▲ Sophisticated headphone section includes PFL Mix, Split options and direct listening to master output mix
- ▲ Play, Pause, Cue, Loop and Pitch Bend functions via dedicated controls for intuitive DJing
- ▲ 4 user-assignable controls and buttons available for integrated FX section
- ▲ Innovative Cue logic with multiple storable cue points per song
- ▲ High-quality components and exceptionally rugged construction ensure long life
- ▲ Conceived and designed by BEHRINGER Germany

BCD2000

FOREWORD



Dear Customer,

welcome to the team of BCD2000 users, and thank you very much for expressing your confidence in us by purchasing the B-CONTROL.

Writing this foreword for you gives me great pleasure, because it represents the culmination of many months of hard work delivered by our engineering team to achieve a very ambitious goal: to present a first-rate DJ system that combines software with controller technology. The B-CONTROL fulfills

the wish of DJs who want intuitive and needs-oriented controllers. The task of designing our new B-CONTROL certainly meant a great deal of responsibility, which we assumed by focusing on you, the discerning computer user and musician. Meeting your expectations also meant a lot of work and night shifts. But it was fun, too. Developing a product usually brings a lot of people together, and what a great feeling it is when all who participated in such a project can be proud of what they've achieved.

It is our philosophy to share our enjoyment with you, because you are the most important member of the BEHRINGER team. With your highly competent suggestions for new products you've made a significant contribution to shaping our company and making it successful. In return, we guarantee you uncompromising quality as well as excellent technical and audio properties at an extremely reasonable price. All of this will enable you to give free rein to your creativity without being hampered by budget constraints.

We are often asked how we manage to produce such high-quality equipment at such unbelievably low prices. The answer is quite simple: it's you, our customers! Many satisfied customers mean large sales volumes enabling us to get better purchasing terms for components, etc. Isn't it only fair to pass this benefit on to you? Because we know that your success is our success too!

I would like to thank all of you who have made the B-CONTROL possible. You have all made your own personal contributions, from the developers to the many other employees at this company, and to you, the BEHRINGER user.

My friends, it's been worth the effort!

Thank you very much,

Uli Behringer

TABLE OF CONTENTS

1. INTRODUCTION	5
1.1 Before you get started	5
1.1.1 Shipment	5
1.1.2 Initial operation	5
1.1.3 Online registration	5
1.2 System requirements	5
2. INSTALLATION	5
2.1 Driver installation	5
2.2 Installation of the B-DJ software	6
2.3 Control panel software	6
3. CONTROL ELEMENTS AND CONNECTIONS	8
3.1 Control surface	8
3.2 The rear panel	9
4. THE B-DJ SOFTWARE	10
5. OPERATION	10
5.1 First steps	10
5.2 Additional DJ functions	11
5.3 Expanded setup	12
5.4 Signal routing	12
5.4.1 Routing options with ASIO driver	12
5.4.2 Routing options with WDM/MME driver	13
6. MIDI CONTROL	13
6.1 Sending control change functions	13
6.2 Sending button functions	13
6.3 Receiving MIDI commands	14
7. AUDIO CONNECTIONS	15
8. SPECIFICATIONS	15
9. WARRANTY	16

1. INTRODUCTION

Thank you for expressing your confidence in us by purchasing the B-CONTROL BCD2000. The BCD2000 features a full-speed USB 4-channel audio interface plus high-resolution 24-bit A/D and D/A converters. It perfectly complements the included BEHRINGER B-DJ software or any other DJ software. And don't let the cutesy looks fool you: this is an integrated, full-fledged audio mixer with a premium quality mic preamp, 3-band kill EQ per channel, ultra-precise faders, super-smooth crossfader and talkover function.

The BCD2000 is packed with 2 state-of-the-art phono pre-amplifiers, one of which is switchable to a CD player. Its sophisticated headphone section includes PFL Mix, Split options and direct listening to master output mix. Play, Pause, Cue, Loop and Pitch Bend functions are regulated via dedicated controls for intuitive Djing, and 4 user-assignable controls and buttons are available for an integrated FX section. Take advantage of the enormous processing power of modern PCs and mix, scratch and manipulate digital music in real time—regardless of the format!

 **The following user's manual is intended to familiarize you with the unit's control elements, so that you can master all the functions. After having thoroughly read the user's manual, store it in a safe place for future reference.**

1.1 Before you get started

1.1.1 Shipment

The BCD2000 was carefully packed at the assembly plant to assure secure transport. Should the condition of the cardboard box suggest that damage may have taken place, please inspect the unit immediately and look for physical indications of damage.

 **Damaged equipment should NEVER be sent directly to us. Please inform the dealer from whom you acquired the unit immediately as well as the transportation company from which you took delivery. Otherwise, all claims for replacement/repair may be rendered invalid.**

 **To assure optimal protection of your B-CONTROL during use or transport, we recommend utilizing a carrying case.**

 **Please always use the original packaging to avoid damage due to storage or shipping.**

 **Never let unsupervised children play with the B-CONTROL or with its packaging.**

 **Please dispose of all packaging materials in an environmentally friendly fashion.**

1.1.2 Initial operation

Please make sure the unit is provided with sufficient ventilation, and never place the B-CONTROL on top of an amplifier or in the vicinity of a heater to avoid the risk of overheating.

A power supply unit which meets the necessary safety requirements is enclosed for connecting the B-CONTROL to the mains.

WARNING!

 **We would like to bring your attention to the fact that extremely loud sound levels may damage your hearing as well as your headphones. Please turn the MASTER control all the way to the left before powering up the unit. Always try to keep volume at appropriate levels.**

1.1.3 Online registration

Please do remember to register your new BEHRINGER equipment right after your purchase by visiting www.behringer.com (alternatively www.behringer.de) and kindly read the terms and conditions of our warranty carefully.

Should your BEHRINGER product malfunction, our goal is to have it repaired as quickly as possible. To arrange for warranty service, please contact the retailer from whom the equipment was purchased. Should your BEHRINGER dealer not be located in your vicinity, you may directly contact one of our subsidiaries. Corresponding contact information is included in the original equipment packaging (Global Contact Information/European Contact Information). Should your country not be listed, please contact the distributor nearest you. A list of distributors can be found in the support area of our website (www.behringer.com).

Registering your purchase and equipment with us helps us process your repair claims quicker and more efficiently.

Thank you for your cooperation!

1.2 System requirements

Minimum requirement:	IBM compatible computer
Operating system	Windows® XP 1 free USB port (USB 1.1)
Processor	800 MHz or higher (recommended) 192 MB RAM min. 30 MB free hard-disk memory
Screen resolution	800 x 600 pixels, 1024 x 768 pixels recommended DirectX® 8.1 or higher is required in all cases!

2. INSTALLATION

2.1 Driver installation

First, install the driver on your computer. The driver is on the CD-ROM supplied with the unit.

1. Connect the BCD2000 to a free USB port on your computer
2. Start Windows® XP
3. Once your computer has booted, switch on the BCD2000 and wait for the device to be detected by the system. The "Found New Hardware Wizard" opens up
4. Close all applications, in particular those running in the background, such as virus scanner software
5. Put the driver/software CD-ROM supplied with the unit into the CD/DVD drive
6. In the first window that opens up, select "Automatic software installation" and click on "Next >"
7. If the error message "Driver software has not passed Windows Logo testing" appears, ignore it and click on "Continue anyway" to install the first part of the driver
8. Then click on "Finish"
9. Now the installation window for the WDM driver of the BCD2000 appears on the screen. Again, select "Automatic software installation" and click on "Next >"
10. If the error message is shown again ("Driver software has not passed Windows Logo testing"), ignore it and click on "Continue anyway"
11. The second part of the driver is installed
12. Click on "Finish".

The driver installation is complete. After a system reboot, the BCD2000 is ready for use.

B-CONTROL ► DEEJAY BCD2000

 Note for notebook users: If you encounter problems operating the BCD2000 from your system, please disable the following settings:

1. In the Device Manager (right click on My Computer > Manage > Device Manager), click option “Batteries” > disable Microsoft ACPI-Compliant Control Method Battery.
2. In the USB Controller, do the following for each single USB Root Hub: Right click > Properties > Power management > disable the option “Allow the computer to turn off this device to save power”.
3. Restart Windows® XP. Now the system performance of your computer should be more stable.

2.2 Installation of the B-DJ software

Preparatory steps:

In order to use the B-DJ software without problems, you must have DirectX®, rev. 8.1 or higher. Please check what version of DirectX® is installed on your system before you start to install the software.

1. Start > Browse > Files or folders...
2. Select the following option on the left-hand side (below “Select the item to be searched”): Files and folders
3. Enter **dxdiag** (= DirectX® Diagnosis) in the upper text box, and click on **Browse**
4. Double-click on the file **diag.exe** found in the folder **C:\WINDOWS\system32**
5. In the DirectX diagnostic program now appearing, the current DirectX® revision stored on your computer is shown at the bottom of the main “System” page.

Installation:

1. Open Windows® Explorer (My Computer > right mouse button > Explorer)
2. In Windows® Explorer, select the drive containing the BCD2000 driver/software CD-ROM (e. g. double click on DVD drive (D:))
3. Select the folder **B-DJ Software**
4. Double-click on the setup file (.exe) to start installation
5. Follow the on-screen installation instructions.

After installation, the B-DJ software will be ready to operate.

Open the B-DJ program by double-clicking on the B-DJ icon on the desktop or use Start > Programs > XYLIO B-DJ > B-DJ 1.0.

 Please note that the B-DJ Software can only be used if the BCD2000 hardware is connected and switched on!

2.3 Control panel software

The BCD2000 control panel allows you to control some general settings of the BCD2000. The control panel will be available in the system as soon as the driver has been installed and the BCD2000 has been connected and switched on. To start the control panel software, click on the BCD2000 control panel symbol in the task bar at the bottom right of your screen. If the B-DJ software has already been started, you can also access the control panel from the “Configuration” menu.

The following basic settings can be selected in the control panel:

GLOBAL MODE selection:

If **B-DJ** is selected, you can only adjust the input source for IN A (Mic or Phono A) and the driver latency on the ASIO page (see below). The outputs are assigned as follows:

CH 1-2: channels 1-2 are always routed to the MASTER OUT,

CH 3-4: channels 3-4 are always routed to the PHONES OUT.

Additionally, the BCD2000's MIDI characteristics differ from those in **ADVANCED** mode (see below). In **ADVANCED** mode, all selection options are available in the ASIO window.

The ASIO page:

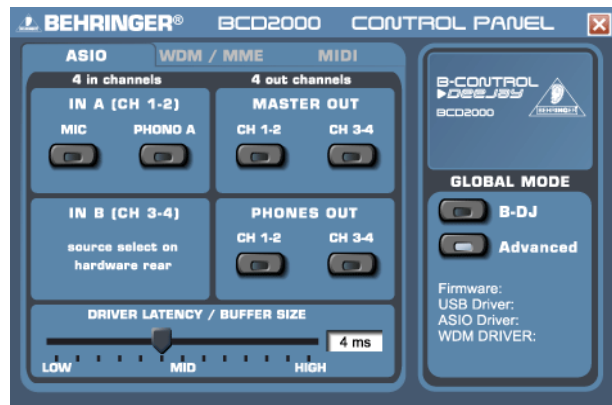

Fig. 2.1: The ASIO window in the BCD2000 control panel

This is where all ASIO driver parameters can be adjusted. Most professional music programs use ASIO, as does our B-DJ software.

You can only select one software button per field.

In the field **IN A (CH 1-2)**, you can select the input source to be routed to the computer on channels 1-2 (Record).

In the **MASTER OUT** section, you can select the playback channels CH 1-2 or CH 3-4 for the main [34] outputs (Playback).

In the **PHONES OUT** field, you can select the playback channels CH 1-2 or CH 3-4 for the headphones connector [9] (Playback).

Use **DRIVER LATENCY** to adjust the latency in order to optimize your computer's performance. If you set the control to “low” this will optimize the response of your BCD2000, but also increase the processor workload. In extreme cases, this can lead to clicking and drop-outs in the audio signal. The “mid” position gives you a good compromise between processor workload and the response time of the BCD2000. A “high” latency ensures trouble-free performance even on slow computers.

 “Latency” is the time that elapses between an operator action on the BCD2000 (e. g. pressing the PLAY button) and the actual output of the audio signal from the OUT connectors. Latency depends on the system used and the processing speed of your computer. Typical latencies are in the milliseconds range (1 ms = one thousandth of a second). Most people cannot hear latencies below 10 ms. When audio signals are passing through a computer, it is impossible to achieve a 0-ms latency.

The WDM/MME page:

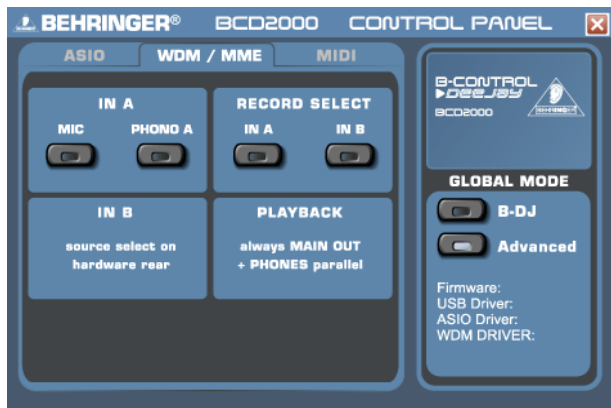

Fig. 2.2: The WDM/MME window in the BCD2000 control panel

Use the WDM/MME driver if your music software does not support ASIO (e. g. most software media players).

RECORD SELECT allows you to select BCD2000 input **IN A** or **IN B** for 2-channel recording.

When you choose **IN A**, you can determine in the left-hand field whether the phono or microphone signal will be recorded.

PLAYBACK of this driver type is always stereo (channels 1-2). For this reason, the **MASTER OUT** connectors on the rear panel and the **PHONES** connector on the front panel always provide the same music signal.

The MIDI page:

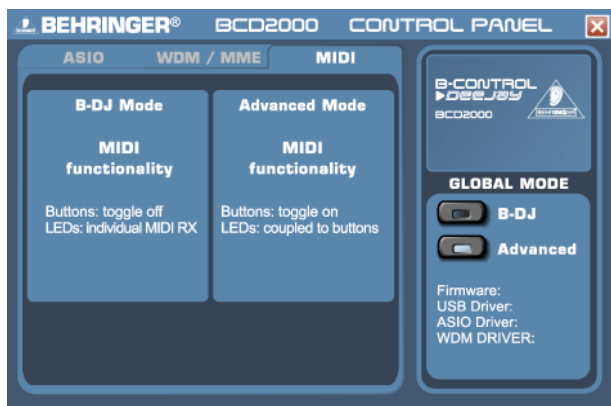

Fig. 2.3: The MIDI window in the BCD2000 control panel

On the MIDI page no parameters can be set. It only informs you about the various MIDI modes, depending on the **GLOBAL MODE** selected:

In **B-DJ** mode, the buttons are “toggle off”, i. e. when you release a button after pressing, the MIDI command is set back to its original value (like when you release a key on a keyboard).

In **B-DJ** mode, all LEDs can be switched on and off individually with specific MIDI commands.

In **ADVANCED** mode, all buttons are “toggle on”, i. e. press = “switch on”; press again = “switch off” the MIDI function (similar to a light switch).

In **ADVANCED** mode, the response of the button LEDs depends on the respective button, i. e. LED on = “function enabled”, LED off = “function disabled”.



3. CONTROL ELEMENTS AND CONNECTIONS

The various control elements of your BCD2000 are described in this chapter. All controls and connections are explained in detail, and there are several useful tips on their use.

3.1 Control surface

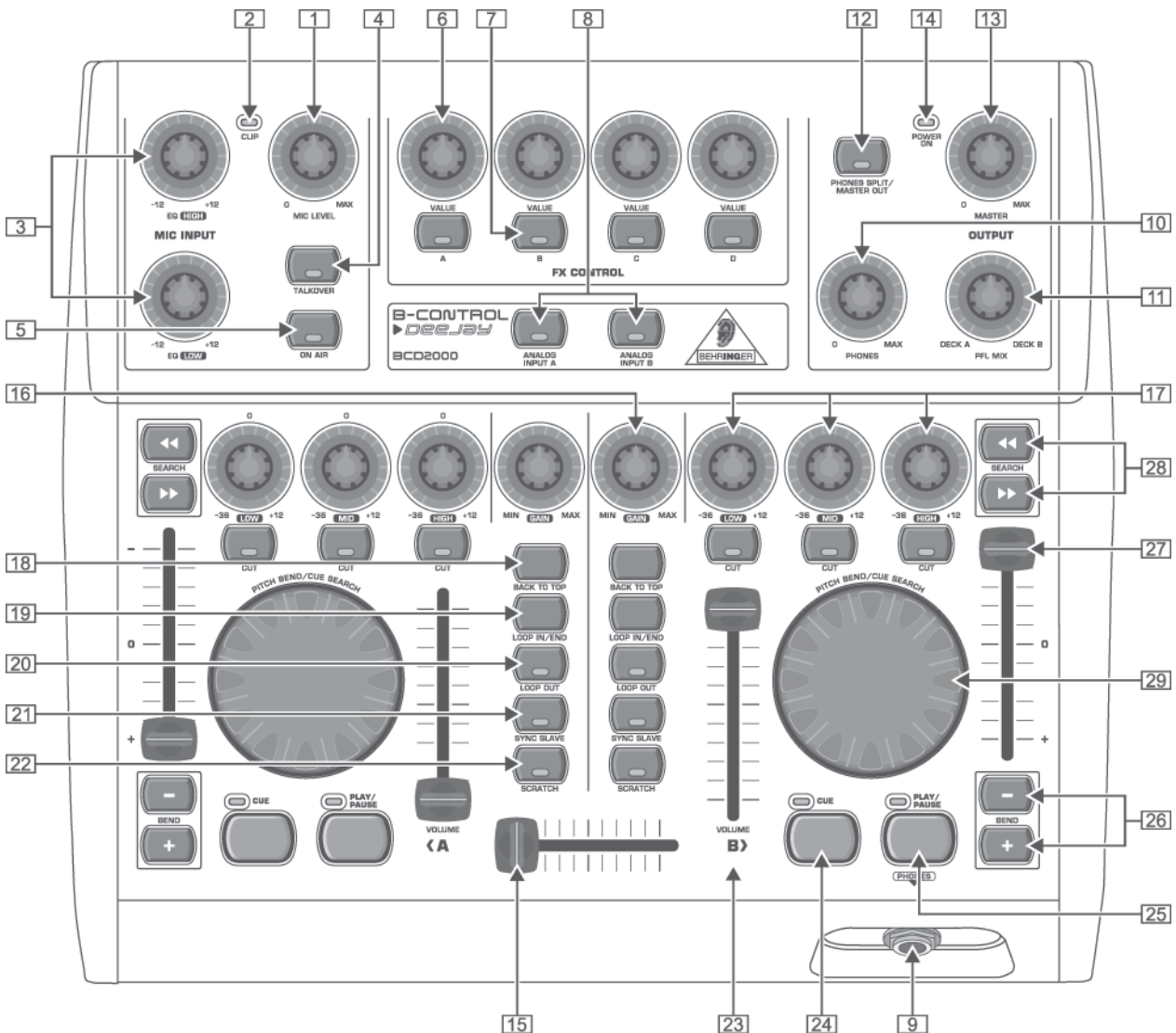

Fig. 3.1: The BCD2000's control elements

The microphone input section (MIC INPUT)

- 1 Set the volume of the microphone signal with the *MIC LEVEL* control.
- 2 The *CLIP* LED illuminates as soon as the microphone signal level is too high and could possibly cause audible distortion. If this happens, slightly turn the *MIC LEVEL* control counter-clockwise.
- 3 The microphone input section has a 2-band equalizer (*EQ HIGH* for high frequencies and *EQ LOW* for low frequencies).
- 4 Use the *TALKOVER* button to activate the software's talk-over function. The talk-over function reduces the master output signal and can come in handy when your own voice needs to be prominently heard. When you want to make an announcement, also press button 5.
- 5 The *ON AIR* button routes the microphone signal to the master output signal.

The FX CONTROL section

These four controls 6 as well as the buttons A to D 7 can have various software functions assigned to them. By default they are assigned to the two effects sections.

Use the *ANALOG INPUT* buttons 8 to select the input source. If the buttons are not pressed, the signals from decks A and B of the software are played back. When you press a button, the analog input signal will be added to the corresponding deck in the B-DJ software. Deck A can play back the phono input A 31 or the microphone signal. Deck B plays back the signal applied at input B (phono or CD). The input source for deck A is chosen in the control panel (see chapter 2.3), while the input source for deck B is selected on the rear panel (phono/line switch 33).

The OUTPUT section

- 9 The *PHONES* output (1/4" stereo connector) is used for connecting headphones.
- 10 Use the *PHONES* control to adjust the volume for the headphones output 9.

- [11] The *PFL MIX* control determines the headphone volume ratio between deck A and deck B. Both signals can be heard in both earcups (stereo). When the *PHONES SPLIT* button [12] is pressed, it controls the volume ratio between the signals of deck A in the left and deck B in the right earcup.
- [12] *PHONES SPLIT/MASTER OUT* button. In the position *PHONES SPLIT* (press button briefly) the signals of both decks are separated in the headphones. In this case, they will be audible in mono in each earphone. In the position *MASTER OUT* (keep button pressed until button LED starts flashing), the same signal is applied to the headphones output and the master outputs. This allows you to control your crossfader skills, for example, when practicing at home or when there is nothing connected to the master outputs.
- [13] Set the volume of the *MASTER* output [34] with the *MASTER OUTPUT* control.
- [14] The *POWER ON*-LED lights up when the BCD2000 is switched on.

The deck sections A and B

The control elements of decks A and B are the same. However, some of them are grouped the opposite way round. We will therefore describe the elements [16] to [29] only once. All of these control elements refer to the software functions which can be "remotely" controlled from the BCD2000.

- [15] The crossfader is used to fade between deck A and deck B.
- [16] Use the *GAIN* control to adjust the input signal.
- [17] Each deck features a 3-band equalizer (*HI*, *MID* and *LOW*) with kill feature. Thus, the signal can be attenuated to a much greater extent (-36 dB) than it can be raised (+12 dB). The *CUT* buttons below the EQ controls give you maximum signal attenuation at the touch of a button. In this way, you can fade out a specific frequency range of a music piece completely and produce interesting filter effects. For beat juggling, too, this function is a must.
- [18] When you press the *BACK TO TOP* button, the song position pointer is set back to the beginning of the piece. Playback stops even though the deck has just played!
- [19] *LOOP IN/END* determines the start and end points of a sequence to be played back several times in a loop. Press the button to set the loop start point, and then again to set the end point. Once the end point has been set, the loop starts, i. e. the sequence is played back from the start point and is repeated until you press the *LOOP OUT* button.
- [20] *LOOP OUT* deactivates the loop which was started with button [19]. Depending on the setting chosen in the software configuration, the loop is either deleted directly or repeated one more time.
- [21] *SYNC SLAVE* is a function which allows you to automatically adapt the tempo of two music pieces to each other. The song whose *SYNC SLAVE* button is pressed, is automatically adapted to meet the tempo of the song currently playing.
- [22] The scratch function is usually active only when the deck is in pause mode. The *SCRATCH* button activates the scratch function of the scratch wheel also during playback (*PLAY* button pressed).
- [23] With the *VOLUME* fader, you can control the volume. While mixing, it is important to have the same volume in both decks.
- [24] Use the *CUE* button to set and select the cue points. Press the *CUE* button a little longer to delete the currently selected *CUE* point. How to use the *CUE* function is described in chapter 5.2.
- [25] Playback is started with the *PLAY/PAUSE* button. Press this button again to stop playback. Press the button once again to resume playback from the position where it stopped.

- [26] *BEND* button. Press the *UP* button (+) to raise the playback tempo. Press the *DOWN* button (-) to slow down the playback tempo. With this function you can synchronize the beats of two pieces currently running. In the Configuration window of the B-DJ software you can adjust the percentage by which the tempo is changed.
- [27] The pitch fader provides continuously adjustable playback tempo control. The pitch range can be adjusted in the Configuration menu.
- [28] Use the *SEARCH* buttons to move forward or backward in a song.
- [29] The function performed by the scratch wheel depends on whether the deck is in *PLAY* or *PAUSE* mode.

PLAY: pitch bend is active. This function mimics the "pitching" technique (accelerating and slowing down the turntable to adapt the rhythm of two vinyl records to each other). Turn the scratch wheel clockwise to raise the playback tempo. Turn it counter-clockwise to slow down the tempo. However, if the *SCRATCH* button is pressed, you can also scratch during playback.

PAUSE: Cue Search is active: You can both scratch and locate exact cue positions.

3.2 The rear panel

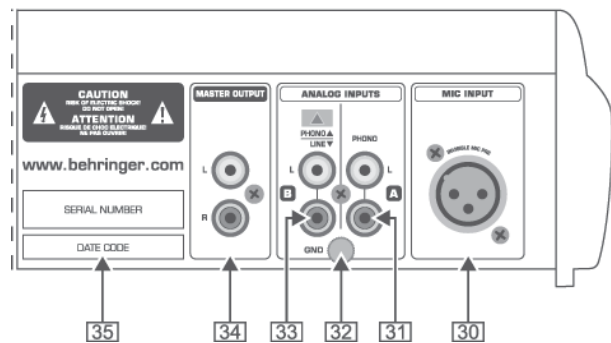

Fig. 3.2: The rear-panel audio connectors of the BCD2000

- [30] *MIC INPUT*. The *MIC IN* connector is the balanced XLR input for your dynamic microphone.
- [31] The analog input A (*PHONO*) is used for connecting a turntable.
- [32] Connect the ground cable on your turntable to the *GND* screw on the BCD2000 housing.
- [33] Analog input B. To connect a CD player or tape deck to this input, set the switch to *LINE*.
- [34] Connect the *MASTER OUTPUT* to your power amplifier. It provides the main output signal, which can be adjusted with the *MASTER* control [13].
- [35] *SERIAL NUMBER*.

B-CONTROL ► DEEJAY BCD2000

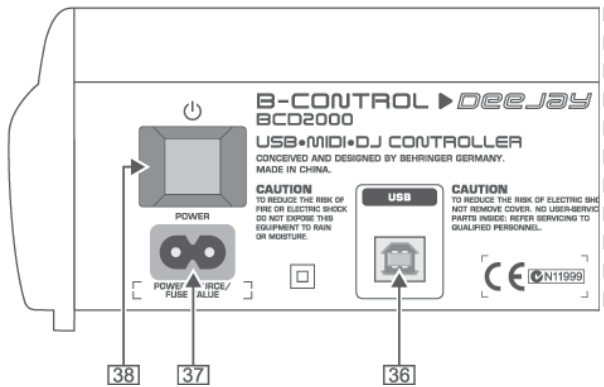

Fig. 3.3: POWER switch, mains and USB connectors

- [36]** The USB connector is used for connecting to a computer with a compatible USB port. The BCD2000 uses the USB connector to send and receive audio and control data.
 - [37]** A standard power socket is provided for connection to the mains. A matching power cable is included with the unit.
 - [38]** The POWER switch turns your BCD2000 on and off. It should always be in the OFF position (out) when connecting the unit to or disconnecting the unit from the mains.
- ⚠ Please note:** The power switch does not completely separate your BCD2000 from AC power. If you plan on not using your BCD2000 for a prolonged period of time, please disconnect it from the mains by removing the power cable from the wall outlet.

4. THE B-DJ SOFTWARE

Here's a short overview of the enclosed B-DJ program. Since many program functions are controlled from the B-CONTROL, chapter 5 describes how to work with the B-DJ system (hardware and software) as a whole. A detailed description of the B-DJ software can be found in the enclosed B-DJ manual (pdf document accessible via *Configuration > Help*).



Fig. 4.1: The main B-DJ window

The B-DJ user interface is divided into several sections: the two decks are displayed in the lower left and right halves of the screen, like two CD players or turntables (deck A is on the left and deck B is on the right). Between the two decks, there is the mixer section with the crossfader and level indicators for both decks as well as the master level indicator.

The List Browser is located in the upper half of the screen, on the left; the list currently selected is shown on the right.

In the middle of the screen, there are the two graphic waveform displays showing the tracks currently loaded in the decks.

5. OPERATION

The operating concept of the B-DJ system has been designed so that you will understand it quickly and intuitively. All control elements are arranged in a way you probably know from DJ mixers or DJ CD players. The user interface (BCD2000 Blue Skin) is almost identical to the user interface of the BCD2000, so that you can control as many functions as possible from the B-CONTROL, thus knowing immediately where to do what—without having to touch your computer mouse.

5.1 First steps

Wiring

First of all, connect all the devices you need to the BCD2000. Make sure the unit is off before connecting it to other equipment. If you want to use the BCD2000 without additional audio sources (CD player, turntable, microphone), you only need to wire the outputs:

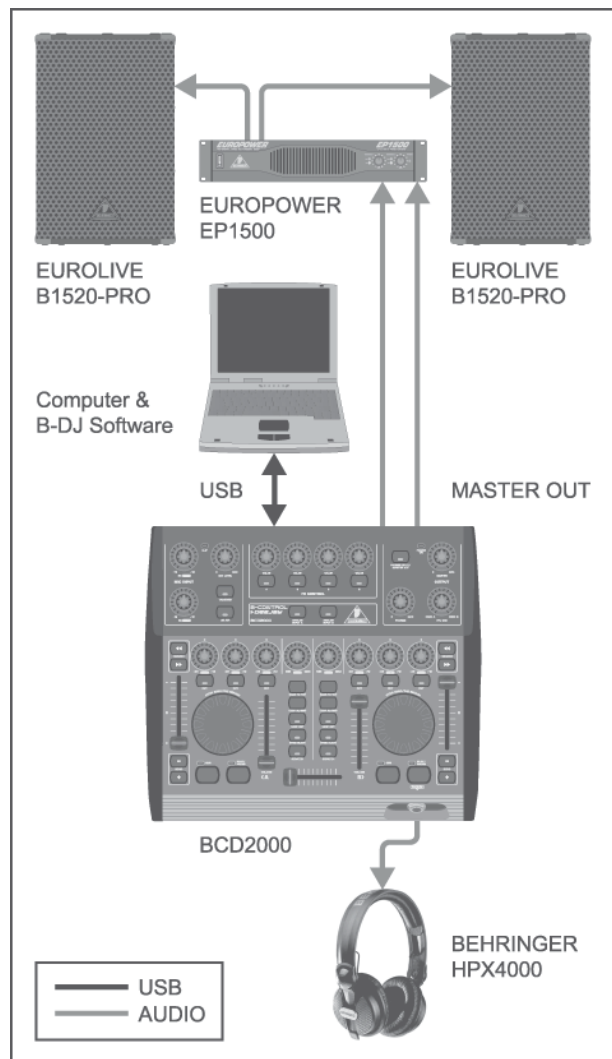

Fig. 5.1: Standard wiring of the BCD2000

Connect the MASTER output [34] to your hi-fi system, a pair of active speakers or the PA system in the club where you are playing. Connect your headphones to the PHONES output [9]. The BEHRINGER DJ headphones HPX4000 are particularly well suited.

Program launch

Once you have installed the driver and B-DJ software, you can launch the program. Boot your computer, then switch on the BCD2000. Your computer will detect the driver and display the control panel icon. Start the B-DJ program via the Start bar or by clicking on the B-DJ icon.

The output section

Set the volume of the MASTER output [34] with the MASTER control [13]. The MASTER output always provides the signal routed to the crossfader.

Use the PHONES control [10] to adjust the headphone volume. The PFL MIX [11] control determines the balance between deck A and deck B.

Create a play list

Before you can play back a song or track, you need to create a list or load an existing list. Click on the ADD button to load a new track onto the current list. "Add Directory" allows you to upload a complete directory from hard-disk. The sequence of songs on the list can always be changed later on.

Load a track

Load a song from the list by clicking on the title and dragging it to the waveform display of deck A. Alternatively, you can use the Load button to load the next track you have marked from the current list.

Start playback

Move the crossfader fully to the left and start playback by pressing the PLAY button of deck A. Select a second track, move it to deck B and start it by pressing the PLAY button of deck B.

Pre-listen to next song

Move the PFL MIX control [11] to the right to pre-listen to the next song on your headphones. You will hear the song played on deck B. Now you have to adapt its tempo to the tempo of the song that is currently being played back on deck A. There are various ways to do this. Either you control the tempo with the pitch fader [27] or use the pitch bend buttons [26] located below the pitch fader. A third alternative is to turn the scratch wheel [29] clockwise (faster) or counter-clockwise (slower). It will be best to use the currently playing kick or snare drum as a "metronome". Once the rhythms are in sync, the beat has been aligned perfectly. Use the Beat Mix indicator in the waveform display as your optical guide, or simply use the Sync Slave function (button [21]).

5.2 Additional DJ functions

Phones Split

In order to listen to both decks separately (Phones Split function), briefly hit the PHONES SPLIT/MASTER OUT button [12] (LED lights up). The signal on deck A can be heard on the left. The signal on deck B can be heard on the right. The PFL MIX control [11] determines the volume ratio between the left and right signals.

Master Out

Press the PHONES SPLIT/MASTER OUT button longer to activate the Master Out function (button LED starts flashing). When Master Out is on, you will always hear the master signal in your headphones, i. e. the music that is being played on the dance floor.

CUE function

The CUE function allows you to set cue points in a track. Cue points are positions in the track, which you can mark during playback. Mainly, these will be positions you want to return to later to start the song from this point, e. g. the beginning of a chorus. You can set eight cue points per track and select them at the touch of a button. When you press the CUE button [24], the song position cursor "jumps" to the selected cue point. If no cue point has been selected, it will automatically go back to the beginning of the track.

Pitch Bend

With the pitch bend function, you can modify the tempo of a track, in order to adapt it to the tempo of the track playing on the other channel. There are several ways to do this:

1. Use the pitch fader to control the software's pitch function. Move the pitch fader [27] up or down to raise or slow down the tempo. The pitch range can be adjusted in the Configuration menu.
2. If the deck is in play mode, you can use the scratch wheel to adapt to the tempo (and beat) of the second track. It's similar to vinyl records: turn the scratch wheel clockwise to raise the playback tempo; turn it counter-clockwise to slow down the tempo.
3. The bend "+" and bend "-" buttons perform the same functions as the software's bend buttons: Press either of these buttons to temporarily change the tempo.

Loop function

The loop function of the B-DJ software can also be controlled from the BCD2000. This is done with the LOOP IN/END and LOOP OUT buttons. Basically, you can define any segment of a currently played song as a loop. First, mark the start and end points on the fly, i.e. during playback (first press = start point; second press = end point). Once the end point has been set, playback returns to the IN point and the loop is started immediately. Press the LOOP OUT button to deactivate loop playback.

Sync Slave

With its Sync Slave function, the B-DJ software gives you a tool for synchronizing two musical pieces. This function should always be activated in the currently pre-listened channel. Otherwise, there may be jumps in the rhythm, which would be very annoying. The pre-listened song is adapted to the piece currently being played back.

5.3 Expanded setup

Even though the B-DJ system can do without external drives and media, you can expand this controller software setup by adding a CD player (which you maybe already have) or two turntables. In this case, you can integrate the analog signal into the software mixer and process it with all real-time functions of the decks (such as EQ, cut-off filter, effects, fader, crossfader, VU meters, etc). Operating external devices is as intuitive as internal mixing.

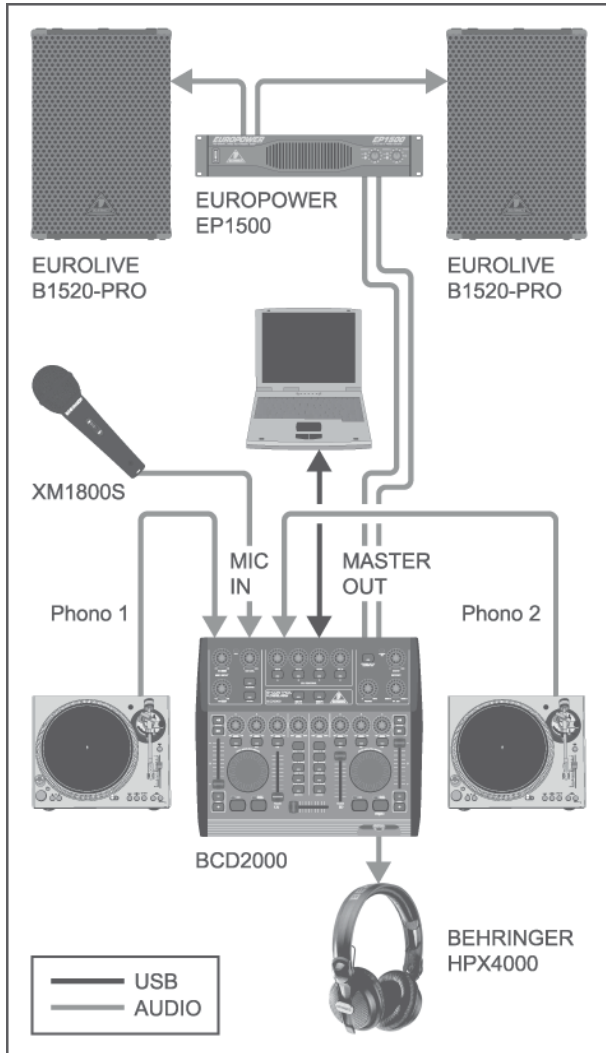

Fig. 5.2: Expanding the standard setup

In this setup, the standard setup shown in fig. 5.1 is expanded by adding two turntables and a microphone. The connection to the computer and the other peripheral devices is the same as in example 1.

Connect the outputs of the turntables to inputs A and B. To use input B, set the PHONO/LINE switch to position "PHONO". Alternatively, you can connect a CD player to input B. In this case, the PHONO/LINE switch must be set to "LINE". Press the input source button [8] to activate the inputs. You can manage up to four signal sources at the same time by switching the two channels between the analog source and the software signal.

The MIC input with its XLR connector allows you to connect a microphone. The MIC LEVEL control in the MIC INPUT section determines the volume of the microphone signal. Use the ON AIR switch to activate the microphone channel. The clip LED illuminates as soon as the input signal's level is too high and could possibly cause audible distortion. If this happens, turn the MIC LEVEL control to the left until the LED does not light up anymore.

ANALOG INPUT A [31] overrides the microphone channel. When this button is pressed, you cannot use the microphone.

5.4 Signal routing

The USB interface allows you to record and play back four audio signals at the same time. The signal routing is determined by the settings of the B-DJ software, the control panel and the button positions. The signal routing also depends on the selected driver (ASIO or WDM/MME).

5.4.1 Routing options with ASIO driver

B-DJ Mode:

If "B-DJ" is selected in the GLOBAL MODE of the control panel, you can only select the input signals. The assignment of the outputs is fixed. Output 1-2 always provides the MASTER OUT signal, while the stereo headphone mix is assigned to output 3-4. The headphones mix is the same as the master signal, if MASTER OUT [12] has been activated too.

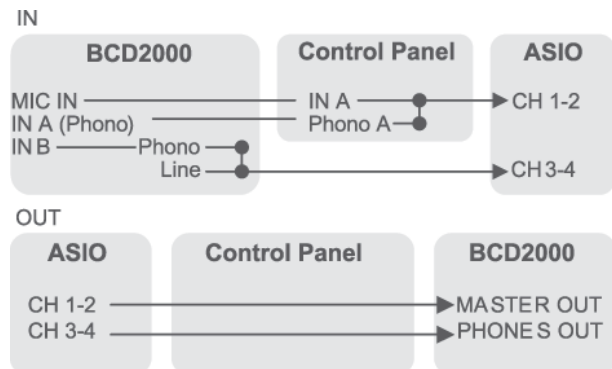

Fig. 5.3: Audio routing in B-DJ mode (ASIO driver)

Advanced Mode:

In Advanced Mode all ASIO parameters can be set. Select the input source for channel IN A (CH 1-2, Mic or Phono A) in the control panel. Select the input source for IN B (CH 3-4, Phono or Line) with the PHONO/LINE switch [33] on the rear of the BCD2000. The playback channels CH 1-2 or CH 3-4 for the main outputs [34] and the headphones connector [9] are also selected in the control panel (MASTER OUT or PHONES OUT field respectively).

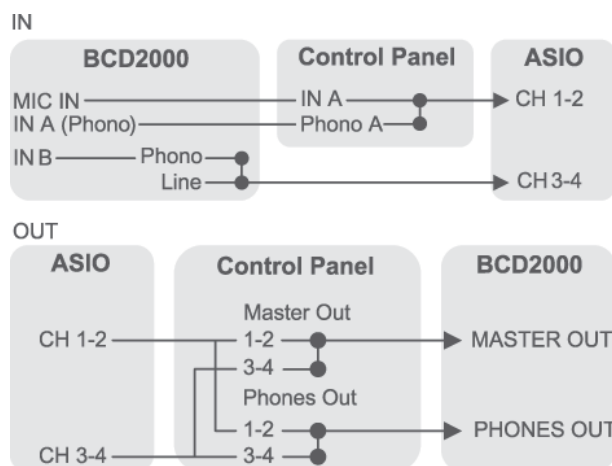

Fig. 5.4: Audio routing in Advanced Mode (ASIO)

5.4.2 Routing options with WDM/MME driver

The WDM/MME driver supports playback/recording of 2 audio signals. For 2-channel recording you can select input **IN A** or **IN B** in the WDM/MME window of the control panel. When you choose **IN A**, you can also determine the signal to be recorded (Phono A or MIC).

When you select **IN B**, you can use the PHONE/LINE switch [33] to determine the signal to be recorded (phono or line).

Playback with the WDM/MME driver is always in stereo, which is why the MASTER output and the PHONES connector of the BCD2000 provide the same music signal.

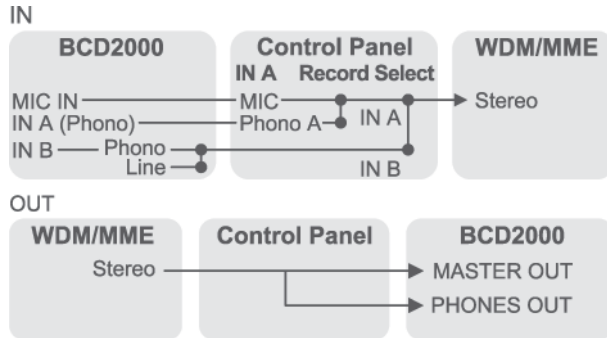

Fig. 5.5: Audio routing with the WDM/MME driver

6. MIDI CONTROL

All control functions of the BCD2000 are sent to your computer as MIDI data. The Musical Instruments Digital Interface is a generic, non-manufacturer-specific standard that enables communication between electronic musical instruments. Although the BCD2000 is not equipped with the "classic" 5-pin MIDI connectors, it still uses the MIDI protocol for data transmission via USB. Thus, the BCD2000 can also control third-party software, as long as it is able to "speak" MIDI. In turn, the BCD2000 can receive MIDI data and use them to show the switching status of the button LEDs.

Basically, two types of MIDI data are used: **Control Change** (CC no.) and **note messages** (Note no.). CC commands are used for the real-time transmission of values that are changed continuously. Note commands are used for the transmission of button functions. You can use any DJ software you like to adapt the MIDI commands to the software functions.

6.1 Sending control change functions

All rotary controls, all faders, the scratch wheel and the crossfader are control elements sending CC data. Each control element has a CC number assigned to it. The absolute values transmitted range from 0 to 127, an exception being the scratch wheels as they are infinitely variable encoders sending no absolute values. Instead, they transmit value changes in steps of 1 (increment = +1, decrement = -1). The following tables show the fixed assignment of CC numbers according to function groups.

Rotary control functions:

Group	Name	MIDI CC no.
DECK A	LOW (EQ)	3
	MID (EQ)	4
	HIGH (EQ)	5
	GAIN	6
DECK B	LOW (EQ)	7
	MID (EQ)	8
	HIGH (EQ)	9
	GAIN	10
FX CONTROL	Value A	13
	Value B	14
	Value C	15
	Value D	16
OUTPUT	PFL MIX	17

Table 6.1: MIDI commands for transmitting rotary control functions

Infinitely variable encoder functions:

Group	Name	MIDI CC no.
DECK A	PITCH BEND/CUE	19*
	SEARCH WHEEL	
DECK B	PITCH BEND/CUE	18*
	SEARCH WHEEL	

* the scratch wheels transmit +1/-1 pulses only (Inc/Dec)

Table 6.2: MIDI commands for transmitting infinitely variable encoder functions

Fader functions:

Group	Name	MIDI CC no.
DECK A	PITCH Fader	11
	VOLUME Fader	0
DECK A<->B	CROSS Fader	1
DECK B	PITCH Fader	12
	VOLUME Fader	2

Table 6.3: MIDI commands for transmitting fader functions

6.2 Sending button functions

All switching elements (buttons) of the BCD2000 transmit MIDI note commands. When you press a button, the system sends a "note on" command, together with the corresponding note number. When the button is released, the system transmits a "note off" command.

Press (and hold) a button = note on / release a button = note off.

(For a permanent note-on command, please select "toggle on" in the software.)

B-CONTROL ► DEEJAY BCD2000



Group	Name	MIDI note no.	MIDI note name
DECK A	SEARCH <<	0	C -1
	SEARCH >>	1	C# -1
	BEND -	2	D -1
	BEND +	3	D# -1
	LOW CUT	12	C 0
	MID CUT	13	C# 0
	HIGH CUT	14	D 0
	BACK TO TOP	4	E -1
	LOOP IN/END	15	D# 0
	LOOP OUT	5	F -1
	SYNC SLAVE	16	E 0
	SCRATCH	17	F 0
	CUE	18	F #0
	PLAY/PAUSE	19	G 0
DECK B	SEARCH <<	6	F# -1
	SEARCH >>	7	G -1
	BEND -	8	G# -1
	BEND +	9	A -1
	LOW CUT	20	G #0
	MID CUT	21	A 0
	HIGH CUT	22	A# 0
	BACK TO TOP	10	A# -1
	LOOP IN/END	23	B 0
	LOOP OUT	11	B -1
	SYNC SLAVE	24	C 1
	SCRATCH	25	C# 1
	CUE	26	D 1
	PLAY/PAUSE	27	D# 1
MIC INPUT	TALKOVER	29	F 1
	ON AIR	30	F# 1
FX CONTROL	Button A	31	G 1
	Button B	32	G# 1
	Button C	33	A 1
	Button D	34	A# 1
INPUT SELECT & OUTPUT	ANALOG INPUT A	35	B 1
	ANALOG INPUT B	36	C 2
	PHONES SPLIT	28	E 1

Table 6.4: MIDI commands for transmitting button functions

6.3 Receiving MIDI commands

The reception of MIDI data also allows for transmitting commands from third-party DJ software to your BCD2000. Although this function is not necessary to control the device from the software, you can still display the switching status of button LEDs, which enables you to work more intuitively.

All button LEDs receive MIDI control change data (on/off). If the controller value transmitted is between 0 and 63, this value corresponds to the switched-off status (LED off). If the value is 64 or higher (max. 127), the LED illuminates.

Group	Name	MIDI CC no.
DECK A	LOW CUT	24
	MID CUT	23
	HIGH CUT	22
	LOOP ON/OFF	21
	SYNC SLAVE	20
	SCRATCH	19
	CUE	18
	PLAY/PAUSE	17
DECK B	LOW CUT	16
	MID CUT	15
	HIGH CUT	14
	LOOP ON/OFF	13
	SYNC SLAVE	12
	SCRATCH	11
	CUE	10
	PLAY/PAUSE	9
MIC INPUT	TALKOVER	8
	ON AIR	7
FX CONTROL	Button A	6
	Button B	5
	Button C	4
	Button D	3
INPUT SELECT & OUTPUT	ANALOG INPUT A	2
	ANALOG INPUT B	1
	PHONES SPLIT	25

Table 6.5: MIDI commands for receiving button LED statuses

Data request for all moving elements:

Current control element values of the program used can be transmitted to the B-CONTROL using a "data request" command, as long as this command type is supported by the program. In this case, the MIDI device doesn't send data. The B-CONTROL requests them instead. The required command is of the control change type:

MIDI CC no.
100

Table 6.6: Controller for data request

Selecting the input channel:

You can select the analog input A (see chapter 2.3) via MIDI. To do this, a **program change** command must be sent to the BCD2000.

ANALOG INPUT A selection	MIDI channel	MIDI message
PHONO A IN	CH. 1	Program Change 0
MIC IN	CH. 1	Program Change 1

Table 6.7: Switching the analog input using program change commands

7. AUDIO CONNECTIONS

You will need a large number of cables for different applications. The illustrations below show how the connectors should be wired. Be sure to use only high-grade cables.

The microphone input of the BCD2000 is electronically balanced to avoid hum problems.

Of course, you can also connect unbalanced microphones to the balanced input. In this case, connect pin 1 and pin 3.

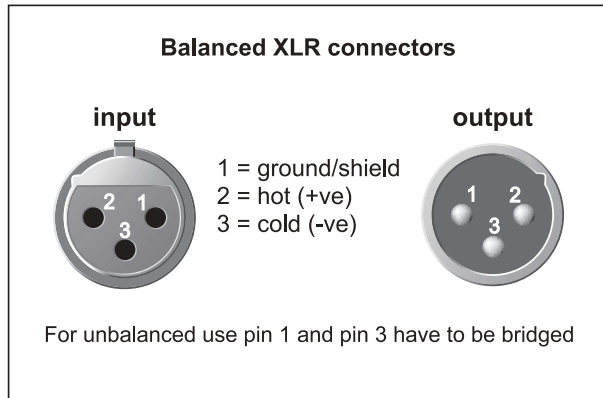

Fig. 7.1: XLR connector

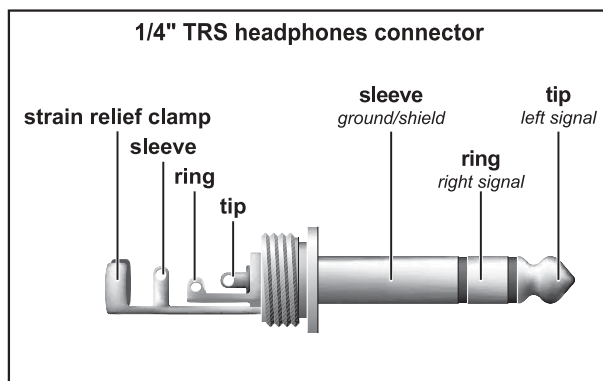

Fig. 7.2: 1/4" TRS headphones connector

8. SPECIFICATIONS

AUDIO INPUTS

Microphone input

Type	XLR balanced
Gain range	-∞ - +50 dB
Frequency response	10 Hz - 29 kHz (-3 dB)
Impedance	approx. 2 kΩ (balanced)
Max. input level	-25 dBu @ 35 dB Gain (mic level center position)
Signal-to-noise ratio	110 dB (A-weighted)
Distortion (THD+N)	0.01 % (A-weighted)
CMRR	typ. -40 dB
Equalizer	
EQ low	±12 dB @ 40 Hz
EQ high	±12 dB @ 12 kHz

Line inputs

Phono in	40 dB Gain
Line in	0 dB Gain
Impedance	approx. 47 kΩ
Max. input level	+12 dBu

AUDIO OUTPUTS

Master Out

Type	RCA
Impedance	120 Ω
Signal-to-noise ratio	101 dB
Crosstalk	<80 dB @ 1 kHz
Max. output level	+18 dBu

Phones Out

Type	1/4" TRS connector
Max. output level	+4.7 dBu (+18.2 dBm) @ 30 Ω loading

DIGITAL PROCESSING

Converter	24 Bit
Sample rate	44.1 kHz
Signal-to-noise ratio	A/D: 100 dB D/A: 100 dB

USB INTERFACE

Type	Full-Speed 12 MBit/s
------	----------------------

SYSTEM SPECIFICATIONS

Signal-to-noise ratio	>80 dB
Crosstalk	<80 dB
Distortion (THD)	0.01%
Frequency response	15 Hz - 21 kHz, +0/-3 dB

POWER SUPPLY

Voltage	100 - 240 V~, 50/60 Hz
Power consumption	max. 7 W
Fuse	T 1 A H 250 V
Mains connection	Standard IEC receptacle

DIMENSIONS/WEIGHT

Dimensions (W x H x D)	13" x 3.9" x 11.8" (330 mm x 100 mm x 300 mm)
Weight	approx. 4.41 lbs (2.0 kg)

BEHRINGER is constantly striving to maintain the highest professional standards. As a result of these efforts, modifications may be made from time to time to existing products without prior notice. Specifications and appearance may differ from those listed or illustrated.



9. WARRANTY

§ 1 OTHER WARRANTY RIGHTS AND NATIONAL LAW

1. This warranty does not exclude or limit the buyer's statutory rights provided by national law, in particular, any such rights against the seller that arise from a legally effective purchase contract.

2. The warranty regulations mentioned herein are applicable unless they constitute an infringement of national warranty law.

§ 2 ONLINE REGISTRATION

Please do remember to register your new BEHRINGER equipment right after your purchase by visiting www.behringer.com (alternatively www.behringer.de) and kindly read the terms and conditions of our warranty carefully. Registering your purchase and equipment with us helps us process your repair claims quicker and more efficiently. Thank you for your cooperation!

§ 3 WARRANTY

1. BEHRINGER (BEHRINGER International GmbH including all BEHRINGER subsidiaries listed on the enclosed page, except BEHRINGER Japan) warrants the mechanical and electronic components of this product to be free of defects in material and workmanship for a period of one (1) year* from the original date of purchase, in accordance with the warranty regulations described below. If the product shows any defects within the specified warranty period that are not excluded from this warranty as described under § 5, BEHRINGER shall, at its discretion, either replace or repair the product using suitable new or reconditioned parts. In the case that other parts are used which constitute an improvement, BEHRINGER may, at its discretion, charge the customer for the additional cost of these parts.

2. If the warranty claim proves to be justified, the product will be returned to the user freight prepaid.

3. Warranty claims other than those indicated above are expressly excluded.

§ 4 RETURN AUTHORIZATION NUMBER

1. To obtain warranty service, the buyer (or his authorized dealer) must call BEHRINGER (see enclosed list) during normal business hours **BEFORE** returning the product. All inquiries must be accompanied by a description of the problem. BEHRINGER will then issue a return authorization number.

2. Subsequently, the product must be returned in its original shipping carton, together with the return authorization number to the address indicated by BEHRINGER.

3. Shipments without freight prepaid will not be accepted.

§ 5 WARRANTY REGULATIONS

1. Warranty services will be furnished only if the product is accompanied by a copy of the original retail dealer's invoice. Any product deemed eligible for repair or replacement under the terms of this warranty will be repaired or replaced.

2. If the product needs to be modified or adapted in order to comply with applicable technical or safety standards on a national

or local level, in any country which is not the country for which the product was originally developed and manufactured, this modification/adaptation shall not be considered a defect in materials or workmanship. The warranty does not cover any such modification/adaptation, irrespective of whether it was carried out properly or not. Under the terms of this warranty, BEHRINGER shall not be held responsible for any cost resulting from such a modification/adaptation.

3. Free inspections and maintenance/repair work are expressly excluded from this warranty, in particular, if caused by improper handling of the product by the user. This also applies to defects caused by normal wear and tear, in particular, of faders, crossfaders, potentiometers, keys/buttons, tubes, guitar strings, illuminants and similar parts.

4. Damages/defects caused by the following conditions are not covered by this warranty:

▲ improper handling, neglect or failure to operate the unit in compliance with the instructions given in BEHRINGER user or service manuals.

▲ connection or operation of the unit in any way that does not comply with the technical or safety regulations applicable in the country where the product is used.

▲ damages/defects caused by force majeure or any other condition that is beyond the control of BEHRINGER.

5. Any repair or opening of the unit carried out by unauthorized personnel (user included) will void the warranty.

6. If an inspection of the product by BEHRINGER shows that the defect in question is not covered by the warranty, the inspection costs are payable by the customer.

7. Products which do not meet the terms of this warranty will be repaired exclusively at the buyer's expense. BEHRINGER will inform the buyer of any such circumstance. If the buyer fails to submit a written repair order within 6 weeks after notification, BEHRINGER will return the unit C.O.D. with a separate invoice for freight and packing. Such costs will also be invoiced separately when the buyer has sent in a written repair order.

§ 6 WARRANTY TRANSFERABILITY

This warranty is extended exclusively to the original buyer (customer of retail dealer) and is not transferable to anyone who may subsequently purchase this product. No other person (retail dealer, etc.) shall be entitled to give any warranty promise on behalf of BEHRINGER.

§ 7 CLAIM FOR DAMAGES

Failure of BEHRINGER to provide proper warranty service shall not entitle the buyer to claim (consequential) damages. In no event shall the liability of BEHRINGER exceed the invoiced value of the product.

* Customers in the European Union please contact BEHRINGER Germany Support for further details.

Technical specifications and appearance subject to change without notice. The information contained herein is correct at the time of printing. The names of companies, institutions or publications pictured or mentioned and their respective logos are registered trademarks of their respective owners. Their use neither constitutes a claim of the trademarks by BEHRINGER® nor affiliation of the trademark owners with BEHRINGER®. BEHRINGER® accepts no liability for any loss which may be suffered by any person who relies either wholly or in part upon any description, photograph or statement contained herein. Colours and specification may vary slightly from product. Products are sold through our authorised dealers only. Distributors and dealers are not agents of BEHRINGER® and have absolutely no authority to bind BEHRINGER® by any express or implied undertaking or representation. No part of this manual may be reproduced or transmitted in any form or by any means, electronic or mechanical, including photocopying and recording of any kind, for any purpose, without the express written permission of BEHRINGER Spezielle Studiotechnik GmbH. BEHRINGER® is a registered trademark.

ALL RIGHTS RESERVED. © 2005 BEHRINGER Spezielle Studiotechnik GmbH,
Hanns-Martin-Schleyer-Str. 36-38, 47877 Willich-Münchheide II, Germany.
Tel. +49 2154 9206 0, Fax +49 2154 9206 4903

Free Manuals Download Website

<http://myh66.com>

<http://usermanuals.us>

<http://www.somanuals.com>

<http://www.4manuals.cc>

<http://www.manual-lib.com>

<http://www.404manual.com>

<http://www.luxmanual.com>

<http://aubethermostatmanual.com>

Golf course search by state

<http://golfingnear.com>

Email search by domain

<http://emailbydomain.com>

Auto manuals search

<http://auto.somanuals.com>

TV manuals search

<http://tv.somanuals.com>