

Built-in Hob

User manual



HQC 63402 E

EN

185.9274.51/R.AA/17.07.2017/2-1

Please read this user manual first!

Dear Customer,

Thank you for purchasing this Beko product. We hope that you get the best results from your product which has been manufactured with high quality and state-of-the-art technology. Therefore, please read this entire user manual and all other accompanying documents carefully before using the product and keep it as a reference for future use. If you handover the product to someone else, give the user manual as well. Follow all warnings and information in the user manual.

Remember that this user manual is also applicable for several other models. Differences between models will be identified in the manual.

Explanation of symbols

Throughout this user manual the following symbols are used:

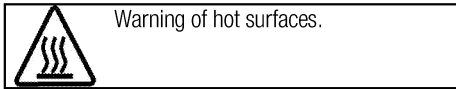
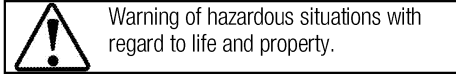

Arçelik A.Ş.
Karaağaç caddesi No:2-6
34445 Sütlüce/İstanbul/TURKEY
Made in TURKEY



This product was manufactured using the latest technology in environmentally friendly conditions.

TABLE OF CONTENTS

1 Important instructions and warnings for safety and environment 4

General safety	4
Electrical safety	4
Product safety	5
Intended use	6
Safety for children.....	6
Disposing of the old product.....	7
Package information	7
Future Transportation.....	7

2 General information 8

Overview	8
Technical specifications	8

3 Installation 9

Before installation	9
Installation and connection	10

4 Preparation 12

Tips for saving energy	12
Initial use	12
First cleaning of the appliance.....	12

5 How to use the hob 13

General information about cooking	13
Using the hobs	13
Control panel	14

6 Maintenance and care 20

General information.....	20
Cleaning the hob	20

7 Troubleshooting 21

8 Guarantee Details 22

1 Important instructions and warnings for safety and environment

This section contains safety instructions that will help protect from risk of personal injury or property damage. Failure to follow these instructions shall void any warranty.

General safety

- This appliance can be used by children aged from 8 years and above and persons with reduced physical, sensory or mental capabilities or lack of experience and knowledge if they have been given supervision or instruction concerning use of the appliance in a safe way and understand the hazards involved.

Children shall not play with the appliance. Cleaning and user maintenance shall not be made by children without supervision.

- The appliance is not to be used by persons (including children) with reduced physical, sensory or mental capabilities, or lack of experience and knowledge, unless they have been given supervision or instruction. Children being supervised not to play with the appliance.
- If the product is handed over to someone else for personal use or second-hand use purposes, the user manual, product labels and

other relevant documents and parts should be also given.

- Installation and repair procedures must always be performed by Authorized Service Agents. The manufacturer shall not be held responsible for damages arising from procedures carried out by unauthorized persons which may also void the warranty. Before installation, read the instructions carefully.
- Do not operate the product if it is defective or has any visible damage.
- Ensure that the product function knobs are switched off after every use.

Electrical safety

- If the product has a failure, it should not be operated unless it is repaired by an Authorized Service Agent. There is the risk of electric shock!
- Only connect the product to a grounded outlet/line with the voltage and protection as specified in the "Technical specifications". Have the grounding installation made by a qualified electrician while using the product with or without a transformer. Our company shall

not be liable for any problems arising due to the product not being earthed in accordance with the local regulations.

- Never wash the product by spreading or pouring water onto it! There is the risk of electric shock!
- The product must be disconnected during installation, maintenance, cleaning and repairing procedures.
- If the power connection cable for the product is damaged, it must be replaced by the manufacturer, its service agent or similarly qualified persons in order to avoid a hazard.
- The appliance must be installed so that it can be completely disconnected from the mains supply. The separation must be provided by a switch built into the fixed electrical installation, according to construction regulations.
- Any work on electrical equipment and systems should only be carried out by authorized and qualified persons.
- In case of any damage, switch off the product and disconnect it from the mains. To do this, turn off the fuse at home.
- Make sure that fuse rating is compatible with the product.

Product safety

- **WARNING:** The appliance and its accessible parts become hot during use. Care should be taken to avoid touching heating elements. Children less than 8 years of age shall be kept away unless continuously supervised.
- Never use the product when your judgment or coordination is impaired by the use of alcohol and/or drugs.
- Be careful when using alcoholic drinks in your dishes. Alcohol evaporates at high temperatures and may cause fire since it can ignite when it comes into contact with hot surfaces.
- Do not place any flammable materials close to the product as the sides may become hot during use.
- Keep all ventilation slots clear of obstructions.
- Do not use steam cleaners to clean the appliance as this may cause an electric shock.
- **WARNING:** Unattended cooking on a hob with fat or oil can be dangerous and may result in fire. NEVER try to extinguish a fire with water, but switch off the appliance and then cover flame e.g. with a lid or a fire blanket.
- **CAUTION:** The cooking process has to be supervised. A short

term cooking process has to be supervised continuously.

- **WARNING:** Danger of fire: Do not store items on the cooking surfaces.
- **WARNING:** If the surface is cracked, switch off the appliance to avoid the possibility of electric shock.
- In case of hotplate glass breakage : Immediately shut off all burners and any electrical heating element and isolate the appliance from the power supply. Do not touch the appliance surface. Do not use the appliance.
- The appliance is not intended to be operated by means of an external timer or separate remote-control system.
- Vapour pressure that build up due to the moisture on the hob surface or at the bottom of the pot can cause the pot to move. Therefore, make sure that the oven surface and bottom of the pots are always dry.
- **WARNING:** Use only hob guards designed by the manufacturer of the cooking appliance or indicated by the manufacturer of the appliance in the instructions for use as suitable or hob guards incorporated in the appliance. The use of inappropriate guards can cause accidents.

Prevention against possible fire risk!

- Ensure all electrical connections are secure and tight to prevent risk of arcing.
- Do not use damaged cables or extension cables.
- Ensure liquid or moisture is not accessible to the electrical connection point.

Intended use

- This product is designed for domestic use. Commercial use will void the guarantee.
- This appliance is for cooking purposes only. It must not be used for other purposes, for example room heating.
- The manufacturer shall not be liable for any damage caused by improper use or handling errors.

Safety for children

- **WARNING:** Accessible parts may become hot during use. Young children should be kept away.
- The packaging materials will be dangerous for children. Keep the packaging materials away from children. Please dispose of all parts of the packaging according to environmental standards.
- Electrical products are dangerous to children. Keep children away from the product when it is operating and do not allow them to play with the product.

- Do not place any items above the appliance that children may reach for.

Disposing of the old product

Compliance with the WEEE Directive and Disposing of the Waste Product:



This product complies with EU WEEE Directive (2012/19/EU). This product bears a classification symbol for waste electrical and electronic equipment (WEEE).

This product has been manufactured with high quality parts and materials which can be reused and are suitable for recycling. Do not dispose of the waste product with normal domestic and other wastes at the end of its service life. Take it to the collection center for the recycling of electrical and electronic equipment. Please consult your local authorities to learn about these collection centers.

Compliance with RoHS Directive:

The product you have purchased complies with EU RoHS Directive (2011/65/EU). It does not contain harmful and prohibited materials specified in the Directive.

Package information

- Packaging materials of the product are manufactured from recyclable materials in accordance with our National Environment Regulations. Do not dispose of the packaging materials together with the domestic or other wastes. Take them to the packaging material collection points designated by the local authorities.

Future Transportation

- Keep the product's original carton and transport the product in it. Follow the instructions on the carton. If you do not have the original carton, pack the product in bubble wrap or thick cardboard and tape it securely.



Check the general appearance of your product for any damages that might have occurred during transportation.

2 General information

Overview

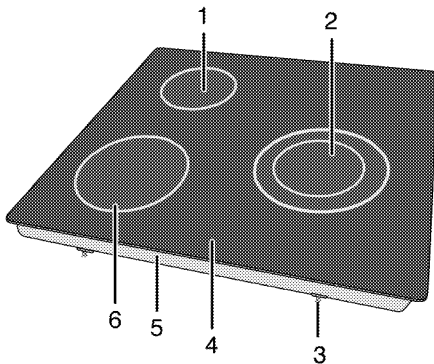

- | | | | |
|---|------------------------------|---|------------------------------|
| 1 | Single-circuit cooking plate | 4 | Vitroc ceramic surface |
| 2 | Dual-circuit cooking plate | 5 | Base cover |
| 3 | Assembly clamp | 6 | Single-circuit cooking plate |

Technical specifications

Voltage / frequency	220-240 V~/380-415 V 2N ~ 50 Hz
Total power consumption	5700 W
Fuse	min. 25 A
Cable type / section	min.H05V2V2-F 3 x 2,5 mm ²
External dimensions (height / width / depth)	55 mm/580 mm/510 mm
Installation dimensions (width / depth)	560 (+2) mm/490 (+2) mm
Burners	
Front left	Single-circuit cooking plate
Dimension	180 mm
Power	1800 W
Rear left	Single-circuit cooking plate
Dimension	140 mm
Power	1200 W
Right	Dual-circuit cooking plate
Dimension	270/210 mm
Power	2700/1800 W



Technical specifications may be changed without prior notice to improve the quality of the product.



Figures in this manual are schematic and may not exactly match your product.



Values stated on the product labels or in the documentation accompanying it are obtained in laboratory conditions in accordance with relevant standards. Depending on operational and environmental conditions of the product, these values may vary.

3 Installation

Product must be installed by a qualified person in accordance with the regulations in force. The manufacturer shall not be held responsible for damages arising from procedures carried out by unauthorized persons which may also void the warranty.



Preparation of location and electrical installation for the product is under the installer's responsibility.



DANGER:

The product must be installed in accordance with all local electrical regulations.



DANGER:

Prior to installation, visually check if the product has any defects on it. If so, do not have it installed.

Damaged products cause risks for your safety.

Before installation

The hob is designed for installation into commercially available work tops. A safety distance must be left between the appliance and the kitchen walls and furniture. See figure (values in mm).

- It can also be used in a free standing position. Allow a minimum distance of 650 mm above the hob surface.
- (*) If a cooker hood is to be installed above the cooker, refer to cooker hood manufacturer' instructions regarding installation height (min 650 mm)
- Remove packaging materials and transport locks.
- Surfaces, synthetic laminates and adhesives used must be heat resistant (100 °C minimum).
- The worktop must be aligned and fixed horizontally.
- Cut aperture for the hob in worktop as per installation dimensions.

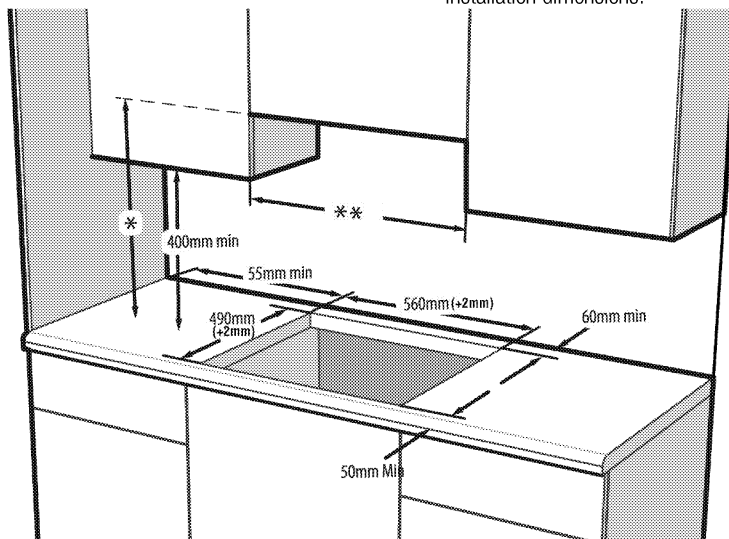

* Minimum height to extractor as recommend in extractor instruction manual

** Minimum distance between cabinetry must be equal to width of hob

Installation and connection

- The product must be installed in accordance with all local gas and electrical regulations.



Do not install the hob on places with sharp edges or corners.
There is the risk of breaking for glass ceramic surface!

Electrical connection

Connect the product to a grounded outlet/line protected by a fuse of suitable capacity as stated in the "Technical specifications" table. Have the grounding installation made by a qualified electrician while using the product with or without a transformer. Our company shall not be liable for any damages that will arise due to using the product without a grounding installation in accordance with the local regulations.



DANGER:

The product must be connected to the mains supply only by an authorised and qualified person. Manufacturer shall not be held responsible for damages arising from procedures carried out by unauthorised persons.



DANGER:

The power cable must not be clamped, bent or trapped or come into contact with hot parts of the product.

A damaged power cable must be replaced by a qualified electrician. Otherwise, there is risk of electric shock, short circuit or fire!

- Connection must comply with national regulations.
- The mains supply data must correspond to the data specified on the type label of the product. Type label is at the rear housing of the product.
- Power cable of your product must comply with the values in "Technical specifications" table.



DANGER:

Before starting any work on the electrical installation, disconnect the product from the mains supply.
There is the risk of electric shock!

Connecting the power cable

- If it is not possible to disconnect all poles in the supply power, a disconnection unit with at least 3 mm contact clearance (fuses, line safety switches, contactors) must be connected and all the poles of this disconnection unit must be adjacent to (not above) the product in accordance with IEE directives. Failure to obey this instruction may

cause operational problems and invalidate the product warranty.

Additional protection by a residual current circuit breaker is recommended.

f a cable is supplied with the product:

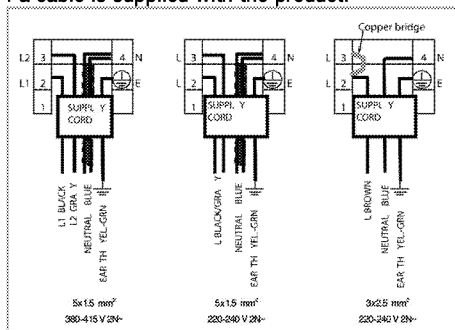

- For single-phase connection, connect the wires as identified below:

- Brown/Black cable = L (Phase)
- Blue/Grey cable = N (Neutral)
- Green/yellow cable = (E) \equiv (Ground)

» or

- Grey/Black cable = L (Phase)
- Blue/Brown cable = N (Neutral)
- Green/yellow cable = (E) \equiv (Ground)

- For double-phase connection, connect the wires as identified below:

- Brown cable = L1 (Phase 1)
- Black cable = L2 (Phase 2)
- Blue/Grey cable = N (Neutral)
- Green/yellow cable = (E) \equiv (Ground)

» or

- Black cable = L1 (Phase 1)
- Grey cable = L2 (Phase 2)
- Blue/Brown cable = N (Neutral)
- Green/yellow cable = (E) \equiv (Ground)

Installing the product

- Turning the hob upside down, place it on a flat surface.
- The sealing gasket provided in the package must be applied on the lower casing bend around the hob as shown in the figure, during installation of the hob.



- Fix the mounting springs inserting and screwing them through the holes of the bottom case as shown in the figure.

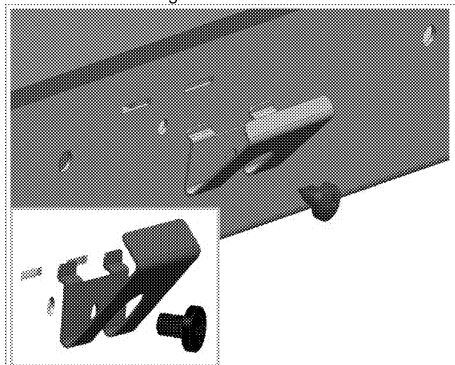

For some models, your product may come with the mounting springs already fitted on it.

- Place the hob on the counter and align it.
- When the hob is placed on the counter top it will be fixed easily with the help of the clamps. If the installation with this clamps are not in appropriate for your cooktop, additional 2 mounting clamps can be fixed to the front side of the product as shown in the below figure.

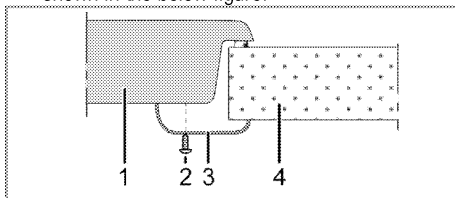

- Hob
- Screw
- Installation clamp
- Counter



When installing the hob onto a cabinet, a shelf must be installed in order to separate the cabinet from the hob as illustrated in the above figure. This is not required when installing onto a built-under oven.

For example, if it is possible to touch the bottom of the product since it is installed onto a drawer, this section must be covered with a wooden plate.

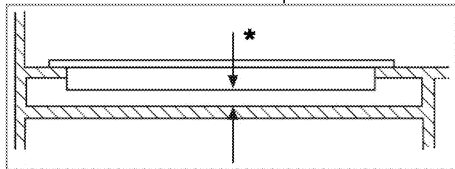

* min. 15 mm

Rear view (connection holes)

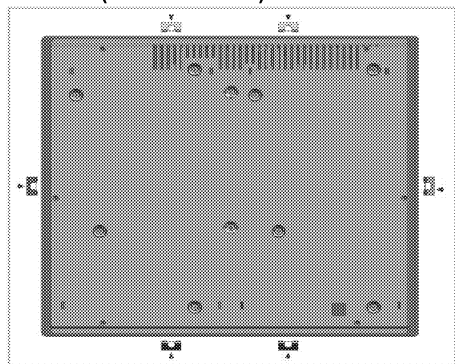

DANGER:

Making connections to different holes is not a good practice in terms of safety since it can damage the gas and electrical system.



DANGER:

There are gas and electrical components contained within this hob, therefore when fitting the mounting springs/clamps only attach the supplied fixings to the connection holes shown in this manual. Failure to observe this advice may lead to life and property safety.

Final check

- Connect the power cable and switch on the product's fuse.
- Check the functions.

4 Preparation

Tips for saving energy

The following information will help you to use your appliance in an ecological way, and to save energy:

- Defrost frozen dishes before cooking them.
- Use pots/pans with cover for cooking. If there is no cover, energy consumption may increase 4 times.
- Select the burner which is suitable for the bottom size of the pot to be used. Always select the correct pot size for your dishes. Larger pots require more energy.
- Pay attention to use flat bottom pots when cooking with electric hobs.
Pots with thick bottom will provide a better heat conduction. You can obtain energy savings up to 1/3.
- Vessels and pots must be compatible with the cooking zones. Bottom of the vessels or pots must not be smaller than the hotplate.
- Keep the cooking zones and bottom of the pots clean. Dirt will decrease the heat conduction between the cooking zone and bottom of the pot.
- For long cookings, turn off the cooking zone 5 or 10 minutes before the end of cooking time. You can obtain energy savings up to 20% by using the residual heat.

Initial use

First cleaning of the appliance



The surface might get damaged by some detergents or cleaning materials.

Do not use aggressive detergents, cleaning powders/creams or any sharp objects during cleaning.

Do not use harsh abrasive cleaners or sharp metal scrapers to clean the oven door glass since they can scratch the surface, which may result in shattering of the glass.

1. Remove all packaging materials.
2. Wipe the surfaces of the appliance with a damp cloth or sponge and dry with a cloth.

5 How to use the hob

General information about cooking



Never fill the pan with oil more than one third of it. Do not leave the hob unattended when heating oil. Overheated oils bring risk of fire. **Never attempt to extinguish a possible fire with water!** When oil catches fire, cover it with a fire blanket or damp cloth. Turn off the hob if it is safe to do so and call the fire department.

- Before frying foods, always dry them well and gently place into the hot oil. Ensure complete thawing of frozen foods before frying.
- Do not cover the vessel you use when heating oil.
- Place the pans and saucepans in a manner so that their handles are not over the hob to prevent heating of the handles. Do not place unbalanced and easily tilting vessels on the hob.
- Do not place empty vessels and saucepans on cooking zones that are switched on. They might get damaged.
- Operating a cooking zone without a vessel or saucepan on it will cause damage to the product. Turn off the cooking zones after the cooking is complete.
- As the surface of the product can be hot, do not put plastic and aluminum vessels on it. Clean any melted such materials on the surface immediately. Such vessels should not be used to keep foods either.
- Use flat bottomed saucepans or vessels only.
- Put appropriate amount of food in saucepans and pans. Thus, you will not have to make any unnecessary cleaning by preventing the dishes from overflowing. Do not put covers of saucepans or pans on cooking zones.

Place the saucepans in a manner so that they are centered on the cooking zone. When you want to move the saucepan onto another cooking zone, lift and place it onto the cooking zone you want instead of sliding it.

Tips about glass ceramic hobs

- Glass ceramic surface is heatproof and is not affected by big temperature differences.
- Do not use the glass ceramic surface as a place of storage or as a cutting board.

- Use only the saucepans and pans with machined bottoms. Sharp edges create scratches on the surface.
- Do not use aluminum vessels and saucepans. Aluminum damages the glass ceramic surface.

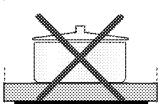
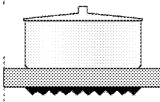
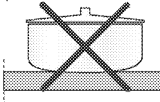
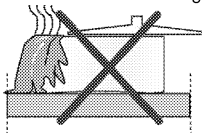

Spills may damage the glass ceramic surface and cause fire.

Do not use vessels with concave or convex bottoms.

Use only the saucepans and pans with flat bottoms. They ensure easier heat transfer. If the diameter of the saucepan is too small, energy will be wasted.

Using the hobs

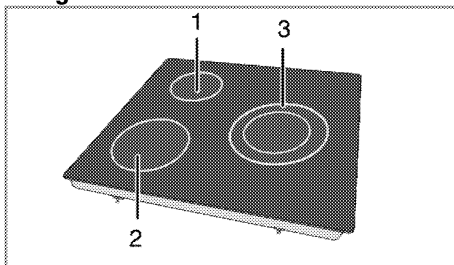

List of advised diameter of pots to be used on related burners.

- 1 Single-circuit cooking plate 14-16 cm
- 2 Single-circuit cooking plate 18-20 cm
- 3 Dual-circuit cooking plate 27-29/21-23 cm



DANGER:

Do not allow any object to drop on the hob. Even small objects such as a saltshaker may damage the hob.







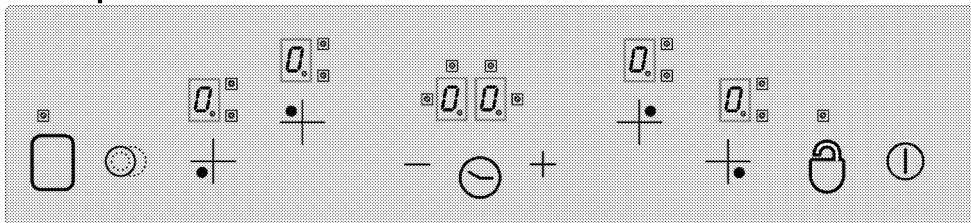











Do not use cracked hobs. Water may leak through these cracks and cause short circuit. In case of any kind of damage on the surface (eg., visible cracks), switch off the product immediately to minimize the risk of electric shock.

i Quick heating glass-ceramic hobs emit a bright light when they are switched on. Do not stare at the bright light.

Control panel





Specifications

-  Main key - ON/OFF key
-  Keylock
-  Temperature setting/Increasing timer
-  Temperature setting/Decreasing timer
-  ** Dual/Triple cooking zone selection key
-  * Enable/disable timer
-  ** Enable/disable cooking zone
-  Cooking zone selection controls
-  .
-  .
-  .
-  (***)  Cooking zone display (temperature setting 0 ... 9)
-   Dual/triple cooking zone operation LED (Cooking zone display)
-  *   * Timer display (there are 4 LEDs for 4 different cooking zones)

i This unit is controlled over the touch control unit. Each operation you make on your touch control will be confirmed by an audible signal if your touch control unit is equipped with a timer.

i Always keep the control panels clean and dry. Humidity and dirt can cause problems in functions.

 (*) If your hob is equipped with a timer.

 ** If your hob is equipped with these functions

 In models with a clock

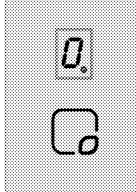
 (***) Not contained in hobs with 3 burners.

Graphics and figures are for informational purposes only. Actual appearance or functions may vary.

Turning on the hob

Touch the "⏻" key on control panel for 1 second. Cooking zone displays illuminate. The hob is ready for use now. You can select different cooking zones within the following 10 seconds. Other controls are not allowed to function when main key "⏻" is being operated.

"0." and all the relevant decimal points will flash in all cooking zone displays.

If no operation is performed within 10 seconds, the hob will automatically return to Standby mode.

If you press main key "⏻" for longer than 2 seconds, the hob will turn off and return to Standby mode.

Selecting the cooking zones

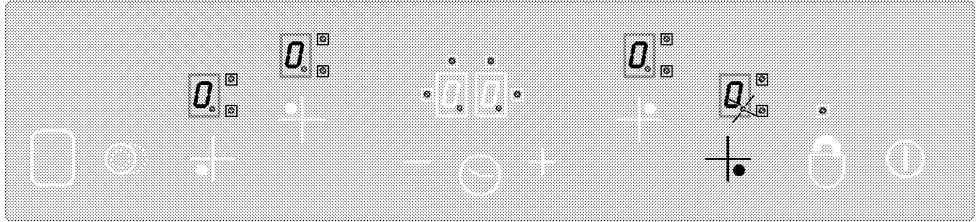

1. Turn on the hob.
2. Touch one of the cooking zone selection controls to turn on the desired cooking zone. After selecting the cooking zone of the hob, "0." decimal point will flash on the relevant cooking zone display.

If no operation is performed within 10 seconds, the hob will automatically return to Standby mode.

3. Touch "+" or "-" keys to set the temperature level to a value between "1" and "9" or between "9" and "1".

"+" and "-" keys are equipped with repeat function. If you touch any of these keys for a long time, temperature level will continuously increase or decrease at every 0,4 seconds.

If you start with "+" key, "1" appears on display. If you start with "-" key, set value appears on display (e.g., half second "A" and half second "9"). This indicates that Booster is activated.

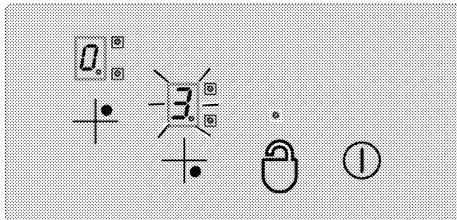

Booster

This function facilitates cooking. When Booster is activated, the cooking will operate at maximum power for a certain period of time (see, Table-1). Booster time depends on the selected temperature level. This is indicated with an "A" and the set temperature value which flash alternately on cooking zone display (e.g., half second "A", half second "9") One the Booster time is over, power of cooking zone will be reduced and the temperature value will be displayed continuously.

All cooking zones are equipped with Booster function.

Enabling the Booster function:

1. Turn on the hob.

2. Select the desired cooking zone by touching the cooking zone selection keys.
3. Use "-" key to set the cooking zone temperature value to "9". Once the temperature setting is made, "9" and "A" will appear on the display alternately. This indicates that temperature value is set to "9" and Booster function is activated.
4. Then, use "-" key within 10 seconds to select the temperature setting you want to be activated for the remainder of cooking process after the Booster time is over. Use "+" or "-" keys to set the cooking zone to a value between "1" or "9" (it is supposed that level 6 is selected for the example).
5. "A" and "6" appears alternately on the display during Booster function (at the end of Booster period, "6" will be displayed continuously).

Turning off the Booster function:

- Touch "-" key until temperature level decreases "0" to disable the Booster function earlier.
- If "9" will be selected as temperature level that will be activated after Booster period and no other lower level is selected, then flashing of the screen will cease in 10 seconds. Booster is now deactivated.

Turn off the hob.

If you press main key "⏻" for longer than 2 seconds, the hob will turn off and return to Standby mode.

If there is residual temperature that can be used after the hob is turned off, this will be indicated with "H" symbol that appears on the relevant cooking zone display continuously.

Turning off cooking zones individually:

A cooking zone can be turned off in 3 different ways:

1. By touching "+" and "-" keys simultaneously.
2. By decreasing the temperature level to "0" with "-" key.
3. By using the timer function (if any) for the relevant cooking zone

1. Touching "+" and "-" keys simultaneously

Select the desired cooking zone with cooking zone selection key "+". Decimal point appears on "0" cooking zone display. Touch "+" and "-" keys simultaneously to turn off the cooking zone.

2. Decreasing the temperature level of the desired cooking zone to "0" with "-" key

Furthermore, cooking zone can also be turned off by decreasing the temperature level to "0".

3. Using the timer off function (if any) for the relevant cooking zone

When the time is over, the timer will turn off the cooking zone assigned to it. "0" and "00" will appear on all displays. Dual/triplet cooking zone and the LEDs connected to the timer will be deactivated.

Furthermore, when the time is over, an audible alarm will sound. Touch any key on the touch control panel to silence the audible alarm.

Turning on Dual/Triplet cooking zones**

Turning on the dual cooking zone:

Select the desired cooking zone equipped with dual zone. Decimal point of the relevant cooking zone must start to flash.

Set the temperature level to a value between 1 and 9 and touch "☉" key to activate the dual zone of the cooking zone.

"E" LED of the relevant dual zone will also flash continuously. "☉" Status of the dual cooking zone will change when you touch the key for a second time: dual cooking zone will switch between on and off statuses.

Expansion zone will only be activated if the main zone of the cooking zone is set to a temperature level between "1" and "9".

Turning on the triplet cooking zone:

Select the desired cooking zone equipped with triplet zone. Decimal point of the relevant cooking zone must start to flash. Set the temperature level to a value between 1 and 9 and touch "☉" key to activate the dual zone of the cooking zone.

"E" LED of the relevant dual zone will also light up continuously. If you touch "☉" key again, "E" LED of the triplet zone flashes and triplet cooking zone is activated.

When you touch "☉" key once again triplet zone of the cooking zone turns off again. Above operation will always change the status of the double/triplet cooking zones.

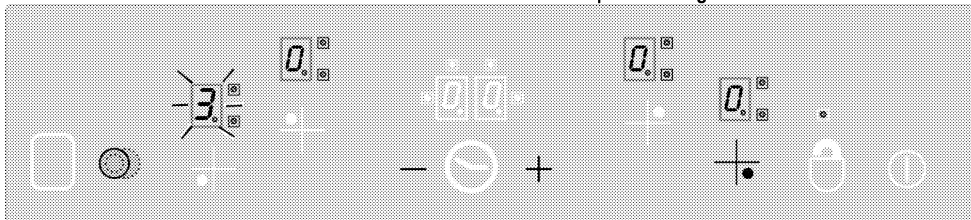

Enabling the double and triplet zones by touching the "☉" key of the selected cooking zone.

Keylock ** (in models with clock)

Touch the "🔒" key for longer than 2 seconds to lock the touch control. Operation will be confirmed with an audible signal. Then, "🔒" LED will flash and all cooking zones will be locked.

Cooking zones, can only be locked in the operation mode. If the cooking zones are locked: only the main

key "🔒" can be operated. "🔒" LED will flash and indicate a key lock module. If you turn the hob off when the keys are locked, the keylock will be activated next time you turn the hob on again. Key lock must be deactivated in order to be able to operate the hob.

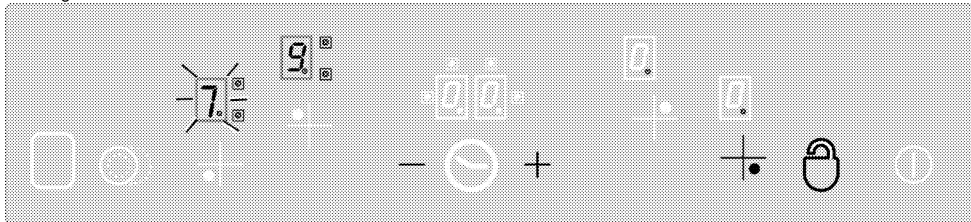

"🔒" key will allow you to lock or unlock the touch control in operation mode.

Touch "0" key for 2 seconds to unlock the cooking zones. Operation will be confirmed with an audible signal.

Then, "0" LED turns off. Now the touch control is unlocked and can be operated normally.

Child Lock

You can protect the hob against being operated unintentionally in order to prevent children from turning on the cooking zone. Child Lock function contains a few complex steps to lock the touch control unit. Child Lock can only be activated and deactivated in Standby mode.

Locking the module:

1. Touch main key "0" to turn on the hob.
2. Touch "+" and "-" keys simultaneously for at least 2 seconds.
3. Then, touch "+" key once again.

» Child Lock function is activated and "L" appears on all cooking zone displays.

Disabling the Child Lock:

You can disable the child lock as you have activated it.

1. Touch main key "0" to turn on the hob.
2. Touch "+" and "-" keys simultaneously for at least 2 seconds.
3. Then, touch "-" key once again.

» "L" appears on all cooking zone displays as long as the Child lock is activated. "L" will disappear when the lock is deactivated successfully.

Timer function *

This feature facilitates cooking for you. You will not have to attend the hob continuously during the cooking process and the cooking zone will turn off automatically at the end of the time you have selected. Timer provides following features: Touch control can command to maximum 4 cooking zone timers and one alarm cooking timer assigned at the same time. All timers can only be used in operation mode.

Timer as an alarm

Alarm timer operates independently from other cooking zones. Therefore, it is not important whether a cooking zone is selected or not.

1. Touch "0" key to enable the alarm timer. "00" and "00:00" will appear on the timer display and a dot will appear on the lower right side. Thus, alarm timer is activated.
2. Then, set the desired time value by touching "+" and "-" keys.
3. Timer will start to countdown after you have made the time setting.

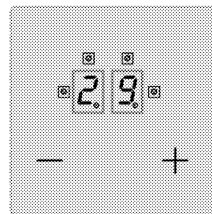
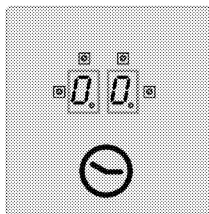

» When the time is over, an audible alarm will sound. Touch any key on the touch control panel to silence the audible alarm.

Cooking zone timer:

The cooking zone timers can only be set for the cooking zones that are activated.

1. First turn on the hob and then enable the desired cooking zone. (cooking zone must be set to a value between 1 and 9)
2. As in the alarm timer, enable the cooking zone timer by touching "0" key. "00" and "00:00" will appear on the timer display and a dot will appear on the lower right side. Thus, cooking zone timer is activated.
3. You must touch "0" key for a second time in order to enable cooking zone timer. Now you can assign the timer.
4. Set the desired time value by touching "+" and "-" keys.

To set the hob timers:

1. After enabling the first cooking zone timer, touch the "0" key again. The control will turn clockwise towards the next active cooking zone assigned to the timer. Assignment proposal will be shown with a flashing "0" LED.
2. Set the desired time value by touching "+" and "-" keys.
3. Timer activated for the cooking zone which was set first is indicated with a continuously flashing "0" LED.
 - More timers can be assigned for other active cooking zones by touching the "0" key once again.
 - After 10 seconds, timer display reverts back to the timer that will end first.
 - "00:00" LEDs that illuminate continuously on the timer display indicate the timer that is currently counting down.
 - You can display the values set for cooking zone timers and egg timer by changing the position of "0" key. A flashing front right "0" LED always shows an assignment. If no LED is flashing, value of the egg timer will be displayed on the timer screen.

Disabling the timers:

First you must display the timer by changing the position of the "⌚" key until the timer appears. This value can later be cancelled in 2 different ways:

- By decreasing the value step by step to "00" by touching "—" key.

- By touching "+" and "—" keys simultaneously for half second until "00" appears on timer display.

When the time is over, an audible alarm will sound. Touch any key on the touch control panel to silence the audible alarm.

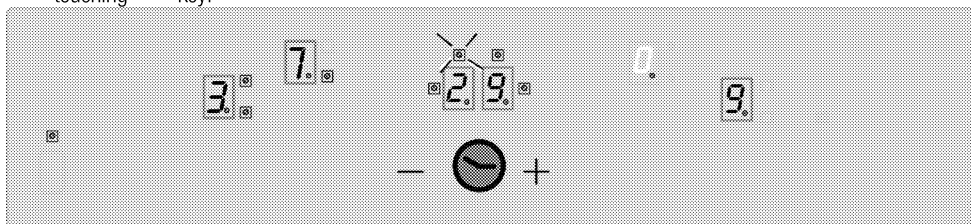

Display the remaining time value of the cooking zone timer 3 (indicator LED flashes) to the timer display (the indicator LEDs of the active timers of the cooking zones 1 and 4 in fact will not be visible on the timer display).

Keep warm function (if any)

Keep Warm function of the cooking zone helps to keep the food warm by selecting an additional temperature level between 0 and 1. Touch "□" key to activate the Keep Warm function.

Then, "□" LED flashes. Touch "□" key again to disable the cooking zone.

Operation time constraints

The hob control is equipped with an operation time limit. When one or more cooking zones are left on

Table-1: Temperature setting parameters; Cycle time 47.0 seconds

Temperature setting	OFF Time - seconds	ON Time - seconds	Operation time limit - hour	Booster time - seconds
0	0	0	0	-
1	45,6	1,4	6	60
2	43,6	3,4	6	180
3	41,3	5,7	5	288
4	38,4	8,6	5	390
5	35,9	11,1	4	510
6	33,1	13,9	1,5	150
7	26,2	20,8	1,5	210
8	19,2	27,8	1,5	270
9	0	47,0	1,5	-

Residual Heat Functions

For a deactivated cooking zone whose surface temperature is sensed to be above 60°C or whose display indicates a value above 60°C, a "H" (residual heat) symbol appears on the display. When residual heat falls below 60°C, "0" appears on the display.

When power restores after a power failure and if the residual heat of the relevant cooking zone was above 60°C before the failure, residual heat display flashes.

unintentionally, the cooking zone will automatically be deactivated after a certain period of time. (see, Table-1). Operation time limit depends on the selected temperature setting. If there is a timer assigned for the cooking zone, "00" appears on the timer display for 10 seconds (10 seconds later, residual heat indicator turns on).

Then, timer display is turned off.

After disabling the cooking zone automatically as described above, it becomes operational again and maximum operation time is applied for this temperature setting.

Display continues to flash until the maximum residual heat time is over or the cooking zone is selected and enabled.

Sensor Calibration and Error Messages

When the supply power is applied, hob control system performs calibration depending on the sensor, glass and ambient conditions. Do not cover the glass part of the sensor with anything during calibration. Hob control system should also not be exposed to strong light sources such as sun light, strong halogen lamps and etc.

Table-2:Error codes and error sources

Cause of error	Display
Ambient light is too high	F1
Fluorescent lamp	F2
Sensor is covered with a bright substance	F3
Ambient light is fluctuating strongly	F4

Sample application:

Following lightning conditions will allow a smooth calibration:

Illumination with a bulb without a reflector (100W, dull) 70 cm above the glass ceramic hob. After a successful calibration, it is warranted that the hob will operate as intended even under a strong illumination such as halogen spot lamp with reflector (50 W).

If an error occurs, calibration is repeated until the ambient conditions allow for a successful calibration. Hob control system can only be operated when the calibration of all sensors are successful.

You must remove all substances on the hob during calibration. Also the ambient illumination should not be too strong during calibration. If one of the F1, F2 or F4 messages is obtained, user must turn off all light sources or close the window during the calibration process at first connection to the supply power. When the calibration is completed successfully, control system can tolerate high amount of ambient light. Hob control system adopts and recalibrates itself according to the changes in ambient conditions while it is in use.



Touch control is equipped with a sensor ensuring protection against overheating. Relevant cooking zone will be deactivated when reacting to this sensor. To obtain more information about the error messages, please see the table.
If a key is activated repeatedly (for longer than 10 seconds), all control system is deactivated and audio signal is given.

6 Maintenance and care

General information

Service life of the product will extend and the possibility of problems will decrease if the product is cleaned at regular intervals.



DANGER:

Disconnect the product from mains supply before starting maintenance and cleaning works.

There is the risk of electric shock!



DANGER:

Allow the product to cool down before you clean it.

Hot surfaces may cause burns!

- Clean the product thoroughly after each use. In this way it will be possible to remove cooking residues more easily, thus avoiding these from burning the next time the appliance is used.
- No special cleaning agents are required for cleaning the product. Use warm water with washing liquid, a soft cloth or sponge to clean the product and wipe it with a dry cloth.
- Always ensure any excess liquid is thoroughly wiped off after cleaning and any spillage is immediately wiped dry.
- Do not use cleaning agents that contain acid or chloride to clean the stainless or inox surfaces and the handle. Use a soft cloth with a liquid detergent (not abrasive) to wipe those parts clean, paying attention to sweep in one direction.



The surface might get damaged by some detergents or cleaning materials.

Do not use aggressive detergents, cleaning powders/creams or any sharp objects during cleaning.

Do not use harsh abrasive cleaners or sharp metal scrapers to clean the oven door glass since they can scratch the surface, which may result in shattering of the glass.



Do not use steam cleaners to clean the appliance as this may cause an electric shock.

Cleaning the hob

Glass ceramic surfaces

Wipe the glass ceramic surface using a piece of cloth dampened with cold water in a manner as not to leave any cleaning agent on it. Dry with a soft and dry cloth. Residues may cause damage on the glass ceramic surface when using the hob for the next time.

Dried residues on the glass ceramic surface should under no circumstances be scraped with hook blades, steel wool or similar tools.

Remove calcium stains (yellow stains) by a small amount of lime remover such as vinegar or lemon juice. You can also use suitable commercially available products.

If the surface is heavily soiled, apply the cleaning agent on a sponge and wait until it is absorbed well. Then, clean the surface of the hob with a damp cloth.



Sugar-based foods such as thick cream and syrup must be cleaned promptly without waiting the surface to cool down. Otherwise, glass ceramic surface may be damaged permanently.

Slight color fading may occur on coatings or other surfaces in time. This will not affect operation of the product.

Color fading and stains on the glass ceramic surface is a normal condition, and not a defect.

7 Troubleshooting

Product emits metal noises while heating and cooling.

- When the metal parts are heated, they may expand and cause noise. >>> *This is not a fault.*

Product does not operate.

- The mains fuse is defective or has tripped. >>> *Check fuses in the fuse box. If necessary, replace or reset them.*
- Product is not plugged into the (grounded) socket. >>> *Check the plug connection.*
- If the display does not light up when you switch the hob on again. >>> *Disconnect the appliance at the circuit breaker. Wait 20 seconds and then reconnect it.*



Consult the Authorised Service Agent or technician with licence or the dealer where you have purchased the product if you can not remedy the trouble although you have implemented the instructions in this section. Never attempt to repair a defective product yourself.

8 Guarantee Details

Your new Beko product is guaranteed against faulty materials, defective components or manufacturing defects. The guarantee starts from the date of original purchase of the product for a period of twelve (12) months unless Beko plc (the "Manufacturer") agrees to extend the guarantee for the product in writing. If you have any questions about the guarantee on your product (including how long it is valid), please contact your retailer or our Call Centre on 0333 207 9710.

This guarantee does not in any way diminish or affect your statutory rights in connection with the product. This guarantee is in addition to your statutory rights as a consumer. If you have any questions about these rights, please contact the retailer from which you purchased the product. In certain circumstances, it is possible that your statutory rights may offer additional or higher levels of protection than those offered under the terms of this guarantee.

What is covered by this guarantee?

- Repairs to the product required as a result of faulty materials, defective components or manufacturing defects.
- Functional replacement parts to repair a product.
- The costs of a Beko Approved Engineer to carry out the repair.

What is not covered?

- Transit and delivery damage.
- Cabinet or appearance parts, including but not limited to control knobs, flaps and handles.
- Accessories and/or consumable items including but not limited to ice trays, scrapers, cutlery baskets, filters and light bulbs.
- Repairs necessary as a direct or indirect result of:
 - Accidental damage, misuse or abuse of a product.
 - An attempted repair of a product by anyone other than a Beko authorised repairer.
 - Installation or use of a product where such installation or use fails to meet the requirements contained in this guarantee or the User Instructions Booklet.
- Repairs to a product operated at any time on commercial or non-residential household premises (unless we have previously agreed to the installation environment).

This guarantee is limited to the cost of repairing the product. To the extent permitted by law, the Manufacturer does not accept and will not be held liable for any financial loss incurred in connection with the failure of any product to operate in accordance with the expected standards. Such financial loss includes but is not limited to loss arising from:

- Time taken off work.
- Damaged food, clothing or other items.
- Meals taken at restaurants or from takeaways.
- General compensation for inconvenience.

Important Notes

- Your product is designed and built for domestic household use only.
- The guarantee will automatically be void if the product is installed or is used in commercial or non-residential domestic household premises, unless we have previously agreed to the installation environment.
- The product must be correctly installed, located and operated in accordance with the instructions contained in the User Instructions Booklet provided with your product.
- Professional installation by a qualified Electrical Domestic Appliance Installer is recommended for all Washing Machines, Dishwashers and Electric Cookers (as incorrect installation may result in you having to pay for the cost of repairing the product).
- Gas Cookers must be professionally installed by a Gas Safe (or Gas Networks Ireland for Republic of Ireland) registered gas installer.

- This guarantee is given in respect of products purchased and used within the United Kingdom and the Republic of Ireland.
- This guarantee is effective from the initial date of purchase of a new product from an authorised retailer and will be void if the product is resold.
- This guarantee does not apply to graded sales (where the product is purchased as a “second”).
- Possession of a copy of these terms and conditions does not necessarily mean that a product has the benefit of this guarantee. If you have any questions, please call our Call Centre on the number set out above.
- The Manufacturer reserves the right to terminate the guarantee if its staff or representatives are subjected to physical or verbal abuse in the course of carrying out their duties.
- Optional extras, where available (i.e. extendable feet) are supplied on a chargeable basis only.

Does Beko offer replacements?

This is a repair-only guarantee. On occasion, the Manufacturer may at its sole discretion, replace your product with a new product instead of carrying out a repair. Where a replacement is offered, this would normally be an identical model but when this is not possible, a model of similar specification will be provided. The Manufacturer will cover the costs and arrange for the delivery of the new product and for the return of the old product. Any costs related to disconnecting the faulty product and installing the replacement product will not be borne by the Manufacturer unless previously agreed to in writing. The original guarantee will continue to apply to the replacement product; the new product will not come with a new guarantee.

When will the repair take place?

Our Engineers work Monday to Friday 9.00am to 5.00pm. Appointments outside these hours may be possible at the sole discretion of the Manufacturer but cannot be guaranteed. Whilst our Engineers will endeavour to minimize inconvenience and to meet requests for specific timed appointments, this cannot be guaranteed. We will not be liable for delays or if it is unable to carry out a repair because a convenient appointment cannot be arranged.

Will there be any charge for the repairs?

It is your responsibility to provide evidence to the Engineer that your product is covered by this guarantee with a proof of purchase. The Manufacturer reserves the right to charge for the reasonable cost of any service call if:

- You cannot provide evidence that your product is covered by this guarantee.
- Where a service call has been made and the engineer finds that there is no fault with your product.
- That your product has not been installed or operated in accordance with the User Instructions Booklet.
- That the fault was caused by something other than faulty materials, defective components or manufacturing defects.
- For missed appointments.

Payment of these costs are due immediately upon the Engineer providing you with an invoice. The Manufacturer reserves the right to terminate the guarantee if you fail to pay the costs for the service call in a timely manner.

If you are a resident of the United Kingdom, this guarantee will be governed by English law and subject to the English Courts, save where you live in another part of the United Kingdom, in which case the law and courts of that location will apply.

If you are resident in the Republic of Ireland, this guarantee will be governed by Irish law and the Irish courts will have jurisdiction.

HOW TO OBTAIN SERVICE

Please keep your purchase receipt or other proof of purchase in a safe place; you will need to have it should the product require attention under guarantee.

It will be useful if you complete the details below, as it will help us assist you when requesting service (the model number is printed on the Instruction Booklet and the serial number is printed on the Rating Label affixed to the appliance). Recording of these details alone will not count as proof of purchase. A valid proof of purchase is required for under guarantee service.

The area around the product must be easily accessible to the Engineer without the need for cabinets or furniture being removed.

It is your responsibility to ensure our Engineers have a clean and safe environment to carry out any repairs.

.....
Model No:

Serial No:

Retailer:

Date of purchase:
.....

For service under guarantee simply telephone the appropriate number below:

UK Mainland & Northern Ireland: 0333 207 9710 or customerservice@support.Beko.co.uk

Republic of Ireland: 01 862 3411 or customerservice@support.Beko.ie

Register your appliance: For UK registrations visit beko.co.uk/register and for the Republic of Ireland beko.ie/register.

Before requesting service please check the troubleshooting guide in the Operating Instructions as a charge may be levied where no fault is found even though your product may still be under guarantee.

Service once the manufacturers guarantee has expired

If you have purchased an extended guarantee please refer to the instructions contained within the extended guarantee agreement document, otherwise please call the appropriate number above where service can be obtained at a charge.

Should you experience any difficulty in obtaining service contact the Beko Customer Helpline on Tel: 0333 207 9710 or e-mail: CustomerService@support.beko.co.uk
.....

This guarantee is provided by Beko plc. Beko House, 1 Greenhill Crescent, Watford, Herts, WD18 8QU. Beko plc is registered in England and Wales with company registration number 02415578.

Free Manuals Download Website

<http://myh66.com>

<http://usermanuals.us>

<http://www.somanuals.com>

<http://www.4manuals.cc>

<http://www.manual-lib.com>

<http://www.404manual.com>

<http://www.luxmanual.com>

<http://aubethermostatmanual.com>

Golf course search by state

<http://golfingnear.com>

Email search by domain

<http://emailbydomain.com>

Auto manuals search

<http://auto.somanuals.com>

TV manuals search

<http://tv.somanuals.com>