

# Double Oven

User manual

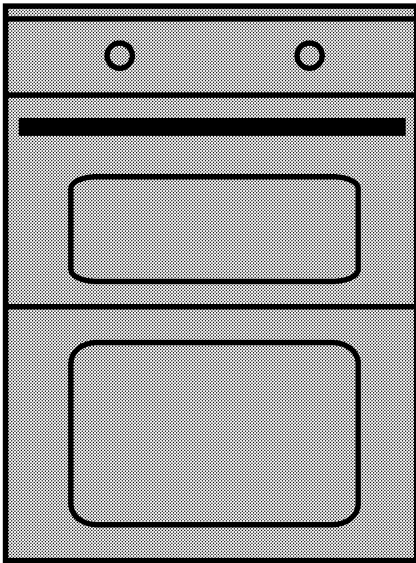

BDC6C55W

BDC6C55X

XDC653W

XDC663SM

XDC653K

JDC683X

**EN**

285.3036.96/R.AB/19.04.2018

## Please read these instructions first before using your appliance

Thank you for choosing a Beko appliance.

Please take some time to read this user manual before using your appliance, to ensure you know how to safely operate the controls and functions.

Carefully follow all unpacking and installation instructions to ensure the appliance is correctly connected and fitted prior to use.

Please write your product model and serial number on the last page of this user manual, and store in a safe location close to the appliance for easy future reference.

This user manual may also be applicable for several other models. Differences between models will be listed.

If you have any questions or concerns, please call our contact centre or find help and information online at [www.beko.co.uk](http://www.beko.co.uk)

## Explanation of symbols used throughout this User Manual

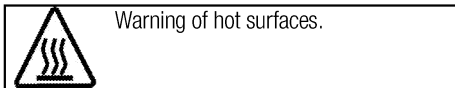
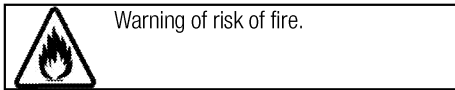
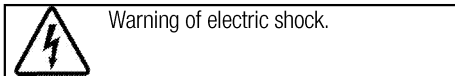
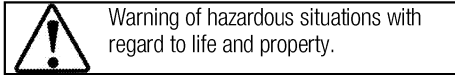
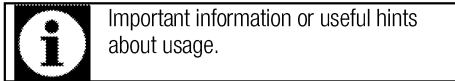

---

This product was manufactured using the latest technology in environmentally friendly conditions.

## TABLE OF CONTENTS

### **1 Important instructions and warnings for safety and environment 4**

General safety.....	4
Electrical safety.....	4
Product safety.....	5
Intended use.....	8
Safety for children.....	8
Disposing of the old product.....	9
Package information.....	9

### **2 General information 10**

Overview.....	10
Package contents.....	11
Technical specifications.....	12

### **3 Installation 13**

Before installation.....	13
Installation and connection.....	14
Future Transportation.....	15

### **4 Preparation 16**

Tips for saving energy.....	16
Initial use.....	16
Time setting.....	16
First cleaning of the appliance.....	16
Initial heating.....	16

### **5 How to use the hob 18**

General information about cooking.....	18
Using the hobs.....	19

### **6 How to operate the oven 20**

General information on baking, roasting and grilling.....	20
How to operate the electric oven.....	20
Operating modes.....	21
Using the oven clock.....	21
Cooking times table.....	23
How to operate the top oven.....	24
Cooking times table.....	24
How to operate the top grill.....	26
Electric grilling guide.....	26
Top oven cooking times table for grilling.....	26

### **7 Maintenance and care 27**

General information.....	27
Cleaning the hob.....	27
Cleaning the control panel.....	27
Cleaning the oven.....	27
Removing the top oven door.....	28
Removing the door inner glass.....	29
Replacing the oven lamp.....	29

### **8 Troubleshooting 30**

### **9 Guarantee Details 31**

## **1 Important instructions and warnings for safety and environment**

This section contains safety instructions that will help protect from risk of personal injury or property damage. Failure to follow these instructions shall void any warranty.

### **General safety**

- This appliance can be used by children aged from 8 years and above and persons with reduced physical, sensory or mental capabilities or lack of experience and knowledge if they have been given supervision or instruction concerning use of the appliance in a safe way and understand the hazards involved.

Children shall not play with the appliance. Cleaning and user maintenance shall not be made by children without supervision.

- The appliance is not to be used by persons (including children) with reduced physical, sensory or mental capabilities, or lack of experience and knowledge, unless they have been given supervision or instruction. Children should be supervised and ensure they do not play with the appliance
- If the product is handed over to someone else for personal use or second-hand use purposes, the

user manual, product labels and other relevant documents and parts should be also given.

- Never place the product on a carpet-covered floor. Otherwise, lack of airflow beneath the product will cause electrical parts to overheat. This will cause problems with your product.
- Installation and repair procedures must always be performed by Authorised Service Agents. The manufacturer shall not be held responsible for damages arising from procedures carried out by unauthorised persons which may also void the warranty. Before installation, read the instructions carefully.
- Do not operate the product if it is defective or has any visible damage.
- Ensure that the product function knobs are switched off after every use.

### **Electrical safety**

- If the product has a failure, it should not be operated unless it is repaired by an Authorised Service Agent. There is the risk of electric shock!
- Only connect the product to a grounded outlet/line with the

voltage and protection as specified in the “Technical specifications”. Have the grounding installation made by a qualified electrician while using the product with or without a transformer. Our company shall not be liable for any problems arising due to the product not being earthed in accordance with the local regulations.

- Never wash the product by spreading or pouring water onto it! There is the risk of electric shock!
- The product must be disconnected during installation, maintenance, cleaning and repairing procedures.
- If the power connection cable for the product is damaged, it must be replaced by the manufacturer, its service agent or similarly qualified persons in order to avoid a hazard.
- Only use the connection cable specified in the “Technical specifications”.
- The appliance must be installed so that it can be completely disconnected from the mains supply. The separation must be provided by a switch built into the fixed electrical installation, according to construction regulations.

- Rear surface of the oven gets hot when it is in use. Make sure that the electrical connection does not contact the rear surface; otherwise, connections can get damaged.
- Do not trap the mains cable between the oven door and frame and do not route it over hot surfaces. Otherwise, cable insulation may melt and cause fire as a result of short circuit.
- Any work on electrical equipment and systems should only be carried out by authorised and qualified persons.
- In case of any damage, switch off the product and disconnect it from the mains. To do this, turn off the fuse at home.
- Make sure that fuse rating is compatible with the product.

### **Product safety**

- **WARNING:** The appliance and its accessible parts become hot during use. Care should be taken to avoid touching heating elements. Children less than 8 years of age shall be kept away unless continuously supervised.
- Never use the product when your judgment or coordination is impaired by the use of alcohol and/or drugs.
- Be careful when using alcoholic drinks in your dishes. Alcohol

evaporates at high temperatures and may cause fire since it can ignite when it comes into contact with hot surfaces.

- Food Poisoning Hazard: Do not let food sit in oven for more than 1 hour before or after cooking. Doing so can result in food poisoning or sickness.
- Do not place any flammable materials close to the product as the sides may become hot during use.
- During use the appliances becomes hot. Care should be taken to avoid touching heating elements inside the oven.
- Keep all ventilation slots clear of obstructions.
- Do not heat closed tins and glass jars in the oven. The pressure that would build-up in the tin/jar may cause it to burst.
- Do not place baking trays, dishes or aluminium foil directly onto the bottom of the oven. The heat accumulation might damage the bottom of the oven.
- Do not use harsh abrasive cleaners or sharp metal scrapers to clean the oven door glass since they can scratch the surface, which may result in shattering of the glass.

- Do not use steam cleaners to clean the appliance as this may cause an electric shock.
- (Varies depending on the product model.)

Placing the wire shelf and tray onto the wire racks properly  
It is important to place the wire shelf and/or tray onto the rack properly. Slide the wire shelf or tray between 2 rails and make sure that it is balanced before placing food on it (Please see the following figure).

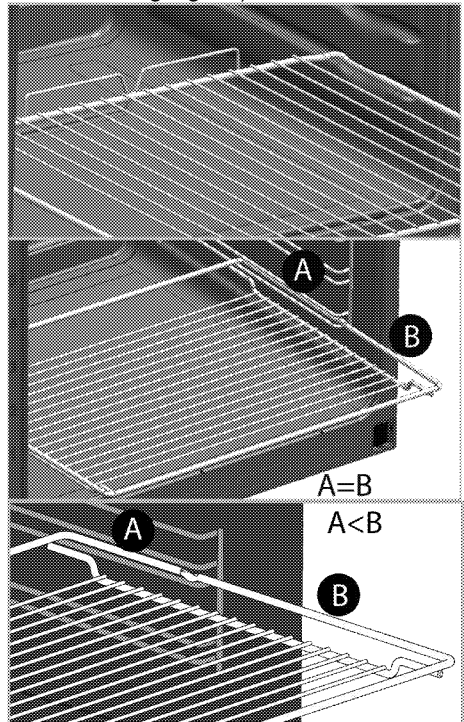

- Do not use the product if the front door glass removed or cracked.
- Do not use the oven handle to hang towels for drying. Do not

hang up towel, gloves, or similar textile products when the grill function is at open door.

- Always use heat resistant oven gloves when putting in or removing dishes into/from the hot oven.
  - Place the baking paper into the cooking pot or on to the oven accessory (tray, wire grill etc) together with the food and then insert all into the preheated oven. Remove the excess parts of the baking paper overflowing from the accessory or the pot in order to prevent the risk of touching the oven's heating elements. Never use the baking paper in an operating temperature higher than the indicated value for the baking paper. Do not place the baking paper directly on the base of the oven.
  - **WARNING:** Ensure that the appliance is switched off before replacing the lamp to avoid the possibility of electric shock.
  - The appliance must not be installed behind a decorative door in order to avoid overheating.
  - Product must be placed directly on the floor. It must not be placed onto a base or a pedestal.
  - **WARNING:** Unattended cooking on a hob with fat or oil can be dangerous and may result in fire.
- NEVER try to extinguish a fire with water, but switch off the appliance and then cover flame e.g. with a lid or a fire blanket.
- **CAUTION:** The cooking process has to be supervised. A short term cooking process has to be supervised continuously.
  - **WARNING:** Danger of fire: Do not store items on the cooking surfaces.
  - **WARNING:** If the surface is cracked, switch off the appliance to avoid the possibility of electric shock.
  - In case of hotplate glass breakage : Immediately shut off all burners and any electrical heating element and isolate the appliance from the power supply. Do not touch the appliance surface. Do not use the appliance.
  - The appliance is not intended to be operated by means of an external timer or separate remote-control system.
  - Vapour pressure that build up due to the moisture on the hob surface or at the bottom of the pot can cause the pot to move. Therefore, make sure that the oven surface and bottom of the pots are always dry.
  - **WARNING:** Use only hob guards designed by the manufacturer of the cooking appliance or

indicated by the manufacturer of the appliance in the instructions for use as suitable or hob guards incorporated in the appliance. The use of inappropriate guards can cause accidents.

Prevention against possible fire risk!

- Ensure all electrical connections are secure and tight to prevent risk of arcing.
- Do not use damaged cables or extension cables.
- Ensure liquid or moisture is not accessible to the electrical connection point.

### **Intended use**

- This product is designed for domestic use. Commercial use will void the guarantee.
- This appliance is for cooking purposes only. It must not be used for other purposes, for example room heating.
- This product should not be used for warming the plates under the grill, drying towels, dish cloths etc. by hanging them on the oven door handles. This product should also not be used for room heating purposes.
- The manufacturer shall not be liable for any damage caused by improper use or handling errors.
- The oven can be used for defrosting, baking, roasting and grilling food.

### **Safety for children**

- **WARNING:** Accessible parts may become hot during use. Young children should be kept away.
- The packaging materials will be dangerous for children. Keep the packaging materials away from children. Please dispose of all parts of the packaging according to environmental standards.
- Electrical products are dangerous to children. Keep children away from the product when it is operating and do not allow them to play with the product.
- Do not place any items above the appliance that children may reach for.
- When the door is open, do not load any heavy object on it and do not allow children to sit on it. It may overturn or door hinges may get damaged.



## Disposing of the old product

### Compliance with the WEEE Directive and Disposing of the Waste Product:



This product complies with EU WEEE Directive (2012/19/EU). This product bears a classification symbol for waste electrical and electronic equipment (WEEE).

This product has been manufactured with high quality parts and materials which can be reused and are suitable for recycling. Do not dispose of the waste product with normal domestic and other wastes at the end of its service life. Take it to the collection center for the recycling of electrical and electronic equipment.

Please consult your local authorities to learn about these collection centers.

### Compliance with RoHS Directive:

The product you have purchased complies with EU RoHS Directive (2011/65/EU). It does not contain harmful and prohibited materials specified in the Directive.

### Package information

- Packaging materials of the product are manufactured from recyclable materials in accordance with our National Environment Regulations. Do not dispose of the packaging materials together with the domestic or other wastes. Take them to the packaging material collection points designated by the local authorities.

## 2 General information

### Overview

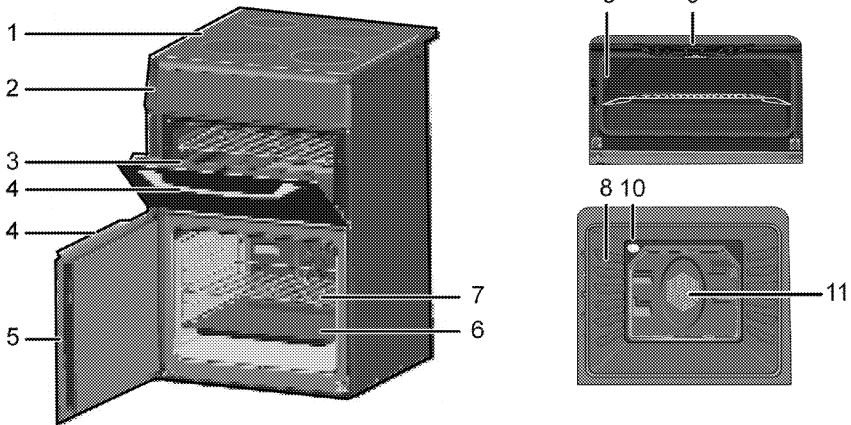

- |   |                |    |                                |
|---|----------------|----|--------------------------------|
| 1 | Burner plate   | 7  | Wire shelf                     |
| 2 | Control panel  | 8  | Shelf positions                |
| 3 | Top oven door  | 9  | Grill heating element          |
| 4 | Handle         | 10 | Lamp                           |
| 5 | Main oven door | 11 | Fan motor (behind steel plate) |
| 6 | Tray           |    |                                |

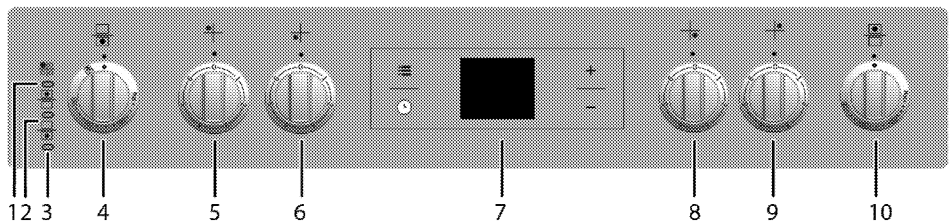

- |    |  |
|----|--|
| 1  | Warning lamp                             |
| 2  | Thermostat lamp for top oven             |
| 3  | Thermostat lamp for main oven            |
| 4  | Main oven function knob                  |
| 5  | Single-circuit cooking plate Rear left   |
| 6  | Single-circuit cooking plate Front left  |
| 7  | Digital timer                            |
| 8  | Single-circuit cooking plate Front right |
| 9  | Single-circuit cooking plate Rear right  |
| 10 | Top oven function knob                   |

## Package contents



Accessories supplied can vary depending on the product model. Not every accessory described in the user manual may exist on your product.

1. **User manual**

2. **Oven tray**

Used for pastries, frozen foods and big roasts.

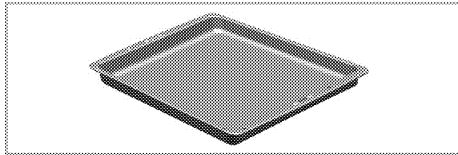

3. **Wire Shelf**

Used for roasting and for placing the food to be baked, roasted or cooked in casserole dishes to the desired rack.

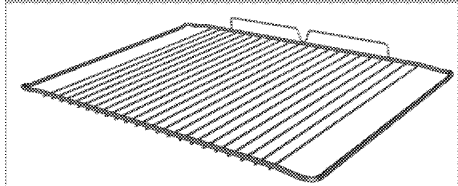
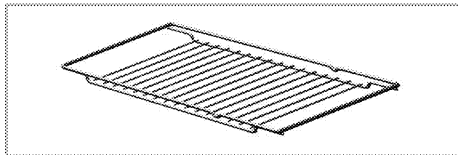

4. **Small wire shelf**

It is placed into the tray (if supplied) in order to collect the dripping fat while grilling so that the oven is kept clean.

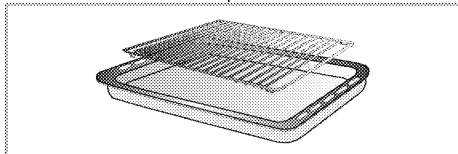

5. **Placing the wire shelf and tray onto the telescopic racks properly**  
**(This feature is optional. It may not exist on your product.)**

Telescopic racks allow you to install and remove the trays and wire shelf easily. When using the tray and wire shelf with telescopic racks, make sure that the pins at the rear section of the telescopic rack stands against the edges of the wire shelf and tray.

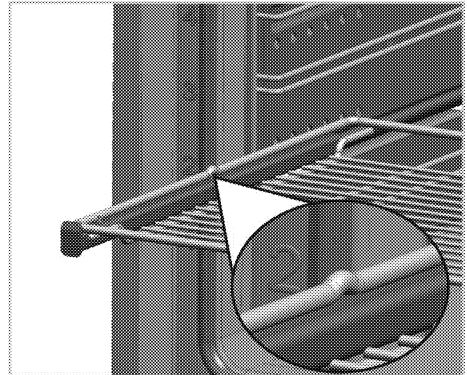
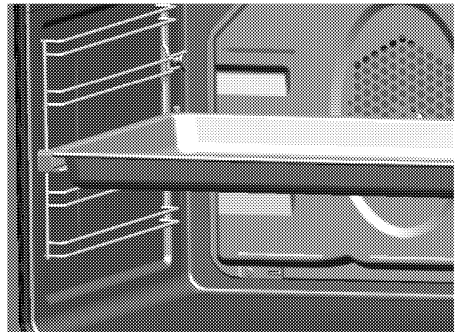

## Technical specifications

GENERAL	
External dimensions (height / width / depth)	900 mm/600 mm/600 mm
Voltage / frequency	220-240 V ~ 50 Hz
Total power consumption	10 kW
Fuse	32 A
Cable type / section	H05VV-FG 3 x 4 mm <sup>2</sup> or equivalent
HOB	
Burners	
Rear left	<b>Single-circuit cooking plate</b>
Dimension	140 mm
Power	1200 W
Front left	<b>Single-circuit cooking plate</b>
Dimension	180 mm
Power	1700 W
Front right	<b>Single-circuit cooking plate</b>
Dimension	140 mm
Power	1200 W
Rear right	<b>Single-circuit cooking plate</b>
Dimension	180 mm
Power	1700 W
OVEN/GRILL	
Top oven	<b>Conventional oven</b>
Grill power consumption	2.2 kW
Main oven	<b>Fan oven</b>
inner lamp	15-25 W

\* Basics: Information on the energy label of electrical ovens is given in accordance with the EN 60350-1 / IEC 60350-1 standard. Those values are determined under standard load with bottom-top heater or fan assisted heating (if any) functions.

Energy efficiency class is determined in accordance with the following prioritization depending on whether the relevant functions exist on the product or not. 1-Cooking with eco-fan, 2- Turbo slow cooking, 3- Turbo cooking, 4- Fan assisted bottom/top heating, 5-Top and bottom heating.



Technical specifications may be changed without prior notice to improve the quality of the product.



Figures in this manual are schematic and may not exactly match your product.



Values stated on the product labels or in the documentation accompanying it are obtained in laboratory conditions in accordance with relevant standards. Depending on operational and environmental conditions of the product, these values may vary.

### 3 Installation

Product must be installed by a qualified person in accordance with the regulations in force. The manufacturer shall not be held responsible for damages arising from procedures carried out by unauthorized persons which may also void the warranty.

	Preparation of location and electrical installation for the product is under the installer's responsibility.
	<b>DANGER:</b> The product must be installed in accordance with all local electrical regulations.
	<b>DANGER:</b> Prior to installation, visually check if the product has any defects on it. If so, do not have it installed. Damaged products cause risks for your safety.

#### Before installation

To ensure that critical air gaps are maintained under the appliance, we recommend that this appliance is mounted on a solid base and that the feet do not sink into any carpet or soft flooring.

The kitchen floor must be able to carry the weight of the appliance plus the additional weight of cookware and bakeware and food.

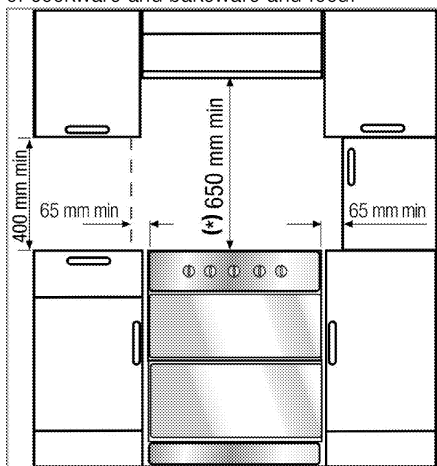

- It can be used with cabinets on either side but in order to have a minimum distance of 400mm

above hotplate level allow a side clearance of 65mm between the appliance and any wall, partition or tall cupboard.

- It can also be used in a free standing position. Allow a minimum distance of 650 mm above the hob surface.
- (\*) If a cooker hood is to be installed above the cooker, refer to cooker hood manufacturer' instructions regarding installation height (min 650 mm).
- Movement of your appliance is most easily achieved by lifting the front as follows and pulling towards. Open the top oven door and the bottom oven door sufficiently to allow a comfortable grip on the underside front edge of the oven roofs. While gripping, it should be avoided to damage any grill elements or oven interior furniture.
- The appliance corresponds to device class 1, i.e. it may be placed with the rear and **one** side to kitchen walls, kitchen furniture or equipment of any size. The kitchen furniture or equipment on the **other** side may only be of the same size or smaller.
- Any kitchen furniture next to the appliance must be heat-resistant (100 °C min.).

#### Safety chain

##### If your product has 2 safety chains;

The appliance must be secured against overbalancing by using the supplied two safety chains on your oven.

Fasten hook (1) by using a proper peg to the kitchen wall (6) and connect safety chain (3) to the hook via the locking mechanism (2).

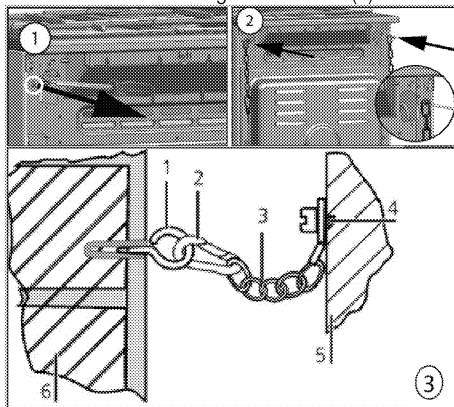

1 Stability hook

- 2 Locking mechanism
- 3 Safety chain (supplied and mounted to oven)
- 4 Firmly fix chain to cooker rear
- 5 Rear of cooker
- 6 Kitchen wall

### If your product has 1 safety chain;

The appliance must be secured against overbalancing by using the supplied one safety chain on your oven.

Follow below steps in the picture to secure the safety chain to your product.

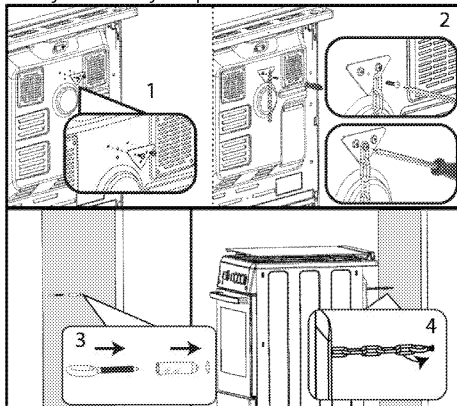

**i** Stability chain to be as short as practicable to avoid oven tilting forward and diagonal to avoid oven side tilting.

Cooker stability chain for cookers is not designed with bracket engagement slot.

### Installation and connection

Product can only be installed and connected in accordance with the statutory installation rules.

**i** Do not install the product next to refrigerators or freezers. The heat emitted by the product will increase the energy consumption of cooling appliances.

- Carry the product with at least two persons.
- Product must be placed directly on the floor. It must not be placed onto a base or a pedestal.

**i** Do not use the door and/or handle to carry or move the product. The door, handle or hinges get damaged.

### Electrical connection

Connect the product to a grounded outlet/line protected by a fuse of suitable capacity as stated in

the "Technical specifications" table. Have the grounding installation made by a qualified electrician while using the product with or without a transformer. Our company shall not be liable for any damages that will arise due to using the product without a grounding installation in accordance with the local regulations.



#### DANGER:

The product must be connected to the mains supply only by an authorised and qualified person. Manufacturer shall not be held responsible for damages arising from procedures carried out by unauthorised persons.



#### DANGER:

The power cable must not be clamped, bent or trapped or come into contact with hot parts of the product. A damaged power cable must be replaced by a qualified electrician. Otherwise, there is risk of electric shock, short circuit or fire!

The mains supply data must correspond to the data specified on the type label of the product. The rating plate is either seen when the door or the lower cover is opened or it is located at the rear wall of the unit depending on the unit type.

Power cable of your product must comply with the values in "Technical specifications" table.



#### DANGER:

Before starting any work on the electrical installation, disconnect the product from the mains supply. There is the risk of electric shock!

### Connecting the power cable

1. **If a power cable is not supplied together with your product**, a power cable that you would select from the table in accordance with the electrical installation at your home must be connected to your product by following the instructions in cable diagram.

This product must only be installed by a qualified electrician eg local electricity company or NICEIC registered contractor to a suitable double-pole control unit with a minimum contact clearance of 3mm in all poles and with a minimum rating please consider technical data table, *Technical specifications, page 11* which should be fitted adjacent to (but not above) the cooker in accordance with IEE regulations. Failure to

observe this instruction may result in operational problems and invalidation of the product warranty.



Additional protection by a residual current circuit breaker is recommended.

- The cable must have conductors of sufficiently high cross sectional area to prevent overheating and deterioration.

The mains cable must conform to BS6004. This appliance must be earthed.

The mains cable must pass through the cable clamp.

The mains cable should be routed away from the appliance and in particular ventilation slots, the vent outlet and should not be obstructed when pushed in to position between the appliance and the wall and/or cabinets.

- Open the terminal block cover with a screwdriver.
- Insert the power cable through the cable clamp below the terminal and secure it to the main body with the integrated screw on cable clamping component.
- Connect the cables according to the supplied diagram.

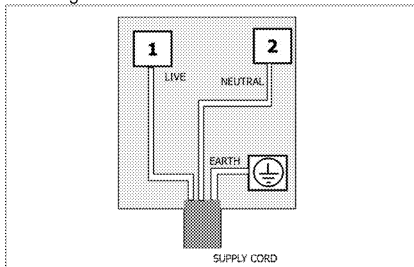

- After completing the wire connections, close the terminal block cover.
- Route the power cable so that it will not contact the product and get squeezed between the product and the wall.



Power cable must not be longer than 2 m because of safety reasons.

- Push the product towards the kitchen wall.
- Hook safety chain.
- Adjusting the feet of oven**

Vibrations during use may cause cooking vessels to move. This dangerous situation can be avoided if the product is level and balanced.

For your own safety please ensure the product is level by adjusting the four feet at the bottom by turning left or right and align level with the work top.

## For equipment with a cooling fan

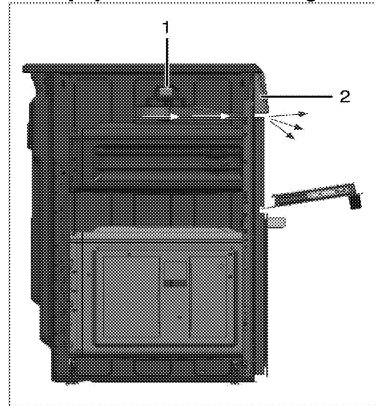

- Fan
- Control panel

While open door grilling, in order to protect control panel, knobs and related oven parts; a fan automatically starts working.



Fan continues working until the product cools down.

## Final check

- Reconnect the product to the mains.
- Check electrical functions.

## Future Transportation

- Keep the product's original carton and transport the product in it. Follow the instructions on the carton. If you do not have the original carton, pack the product in bubble wrap or thick cardboard and tape it securely.
- To prevent the wire grill and tray inside the oven from damaging the oven door, place a strip of cardboard onto the inside of the oven door that lines up with the position of the trays. Tape the oven door to the side walls.
- Do not use the door or handle to lift or move the product.



Do not place any objects onto the product and move it in upright position.



Check the general appearance of your product for any damages that might have occurred during transportation.

## 4 Preparation

### Tips for saving energy

The following information will help you to use your appliance in an ecological way, and to save energy:

- Use dark coloured or enamel coated cookware in the oven since the heat transmission will be better.
- While cooking your dishes, perform a preheating operation if it is advised in the user manual or cooking instructions.
- Do not open the door of the oven frequently during cooking.
- Try to cook more than one dish in the oven at the same time whenever possible. You can cook by placing two cooking vessels onto the wire shelf.
- Cook more than one dish one after another. The oven will already be hot.
- You can save energy by switching off your oven a few minutes before the end of the cooking time. Do not open the oven door.
- Defrost frozen dishes before cooking them.

### Initial use

#### Time setting

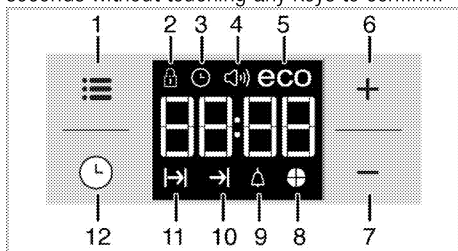

 While making any adjustment, related symbols will flash on the display.

Press **+**/**-** keys to set the time of the day after the oven is energized for the first time. Confirm the setting by touching  symbol and wait for 4 seconds without touching any keys to confirm.



- 1 Adjustment key
- 2 Keylock symbol
- 3 Clock symbol
- 4 Alarm volume symbol

- 5 Eco mode symbol
- 6 Plus key
- 7 Minus key
- 8 Time pie symbol
- 9 Alarm symbol
- 10 End of Cooking Time symbol
- 11 Cooking Time symbol
- 12 Program key

 If the initial time is not set, clock will run starting from **12:00** and  symbol will be displayed. The symbol will disappear once the time is set.

 Current time settings are canceled in case of power failure. It needs to be readjusted.

### First cleaning of the appliance

 The surface might get damaged by some detergents or cleaning materials. Do not use aggressive detergents, cleaning powders/creams or any sharp objects during cleaning. Do not use harsh abrasive cleaners or sharp metal scrapers to clean the oven door glass since they can scratch the surface, which may result in shattering of the glass.

1. Remove all packaging materials.
2. Wipe the surfaces of the appliance with a damp cloth or sponge and dry with a cloth.

### Initial heating

Heat up the product for about 30 minutes and then switch it off. Thus, any production residues or layers will be burnt off and removed.



#### WARNING

Hot surfaces cause burns!

Product may be hot when it is in use. Never touch the hot burners, inner sections of the oven, heaters and etc. Keep children away. Always use heat resistant oven gloves when putting in or removing dishes into/from the hot oven.



### **Electric oven**

1. Take all baking trays and the wire grill out of the oven.
2. Close the oven door.
3. Select Static position.
4. Select the highest oven power; See *How to operate the electric oven, page 20*.
5. Operate the oven for about 30 minutes.
6. Turn off your oven; See *How to operate the electric oven, page 20*

### **Grill oven**

1. Take all baking trays and the wire grill out of the oven.

2. Close the oven door.
3. Select the highest grill power; see *How to operate the grill, page 25*
4. Operate the grill about 30 minutes.
5. Turn off your grill; see *How to operate the grill, page 25*



Smoke and smell may emit for a couple of hours during the initial operation. This is quite normal. Ensure that the room is well ventilated to remove the smoke and smell. Avoid directly inhaling the smoke and the smell that emits.

## 5 How to use the hob

### General information about cooking



Never fill the pan with oil more than one third of it. Do not leave the hob unattended when heating oil. Overheated oils bring risk of fire. **Never attempt to extinguish a possible fire with water!** When oil catches fire, cover it with a fire blanket or damp cloth. Turn off the hob if it is safe to do so and call the fire department.

- Before frying foods, always dry them well and gently place into the hot oil. Ensure complete thawing of frozen foods before frying.
- Do not cover the vessel you use when heating oil.
- Place the pans and saucepans in a manner so that their handles are not over the hob to prevent heating of the handles. Do not place unbalanced and easily tilting vessels on the hob.
- Do not place empty vessels and saucepans on cooking zones that are switched on. They might get damaged.
- Operating a cooking zone without a vessel or saucepan on it will cause damage to the product. Turn off the cooking zones after the cooking is complete.
- As the surface of the product can be hot, do not put plastic and aluminum vessels on it. Clean any melted such materials on the surface immediately. Such vessels should not be used to keep foods either.
- Use flat bottomed saucepans or vessels only.
- Put appropriate amount of food in saucepans and pans. Thus, you will not have to make any unnecessary cleaning by preventing the dishes from overflowing. Do not put covers of saucepans or pans on cooking zones. Place the saucepans in a manner so that they are centered on the cooking zone. When you want to move the saucepan onto another cooking zone, lift and place it onto the cooking zone you want instead of sliding it.

- Do not use the glass ceramic surface as a place of storage or as a cutting board.
- Use only the saucepans and pans with machined bottoms. Sharp edges create scratches on the surface.
- Do not use aluminum vessels and saucepans. Aluminum damages the glass ceramic surface.

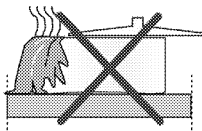

Spills may damage the glass ceramic surface and cause fire.

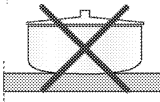

Do not use vessels with concave or convex bottoms.

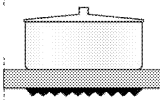

Use only the saucepans and pans with flat bottoms. They ensure easier heat transfer. If the diameter of the saucepan is too small, energy will be wasted.

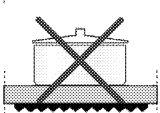

### Tips about glass ceramic hobs

- Glass ceramic surface is heatproof and is not affected by big temperature differences.

## Using the hobs

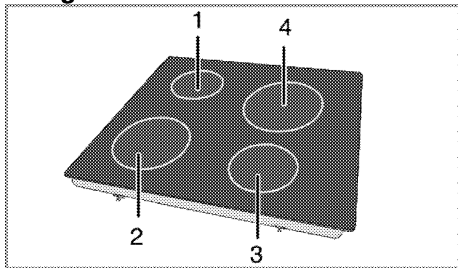

list of advised diameter of pots to be used on related burners.

- 1 Single-circuit cooking plate 14-16 cm
- 2 Single-circuit cooking plate 18-20 cm
- 3 Single-circuit cooking plate 14-16 cm
- 4 Single-circuit cooking plate 18-20 cm



### **DANGER:**

Do not allow any object to drop on the hob. Even small objects such as a saltshaker may damage the hob. Do not use cracked hobs. Water may leak through these cracks and cause short circuit.

In case of any kind of damage on the surface (eg., visible cracks), switch off the product immediately to minimize the risk of electric shock.

Glass ceramic hob is equipped with an operation light and a hot zone warning indicator.

Hot zone warning indicator indicates the status of the active zone and it remains lit after the plate is turned off. When the temperature of the plate cools down to a level that it can be touched by hand, warning indicator turns off. Flickering of the hot zone warning indicator is not a failure.

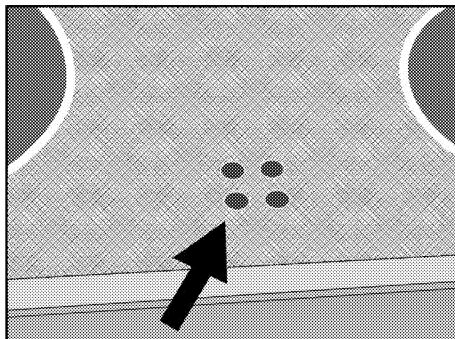

Quick heating glass-ceramic hobs emit a bright light when they are switched on. Do not stare at the bright light.

### **Turning on the ceramic plates**

The hob control knobs are used for operating the plates. To obtain the desired cooking power, turn the hob control knobs to the corresponding level.

Cooking level	1	2 — 3	4 — 6
	warming	stewing, simmering	boiling

### **Turning off the ceramic plates**

Turn the plate knob to OFF (upper) position.

## 6 How to operate the oven

### General information on baking, roasting and grilling



#### WARNING

Hot surfaces cause burns!  
Product may be hot when it is in use. Never touch the hot burners, inner sections of the oven, heaters and etc. Keep children away. Always use heat resistant oven gloves when putting in or removing dishes into/from the hot oven.



#### DANGER:

Be careful when opening the oven door as steam may escape.  
Exiting steam can scald your hands, face and/or eyes.

#### Tips for baking

- Use non-sticky coated appropriate metal plates or aluminum vessels or heat-resistant silicone moulds.
- Make best use of the space on the rack.
- Place the baking mould in the middle of the shelf.
- Select the correct rack position before turning the oven or grill on. Do not change the rack position when the oven is hot.
- Keep the oven door closed.

#### Tips for roasting

- Treating whole chicken, turkey and large piece of meat with dressings such as lemon juice and black pepper before cooking will increase the cooking performance.
- It takes about 15 to 30 minutes longer to roast meat with bones when compared to roasting the same size of meat without bones.
- Each centimeter of meat thickness requires approximately 4 to 5 minutes of cooking time.
- Let meat rest in the oven for about 10 minutes after the cooking time is over. The juice is better distributed all over the roast and does not run out when the meat is cut.

- Fish should be placed on the middle or lower rack in a heat-resistant plate.

### How to operate the electric oven



Before you can use the oven, the time must be set. If the time is not set, oven will not operate.

Product is equipped with two ovens. Overview section indicates the relevant knobs for each oven.

#### How to operate the main oven

#### Select temperature and operating mode / Easy Steam Cleaning

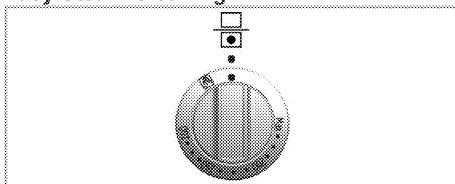

or

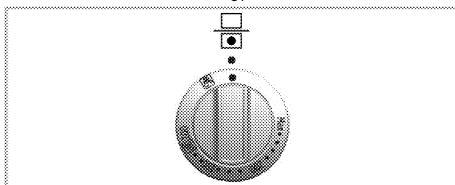

1. Set the Function knob to the desired temperature.

» Oven heats up to the adjusted temperature and maintains it. During heating, temperature lamp stays on.

This function must be used for easy steam cleaning as well.

#### Switching off the electric oven

Turn the Function knob to Off (top) position.

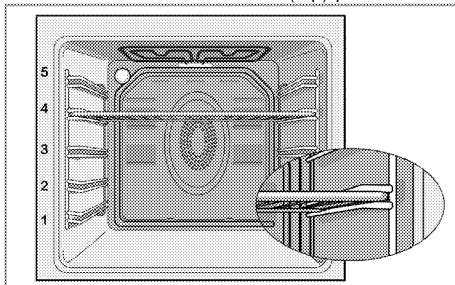

## Rack positions (For models with wire shelf)

It is important to place the wire shelf onto the side rack correctly. Wire shelf must be inserted between the side racks as illustrated in the figure.

Do not let the wire shelf stand against the rear wall of the oven. Slide your wire shelf to the front section of the rack and settle it with the help of the door in order to obtain a good grill performance.

## Operating modes

All functions in your oven (including the main oven) are described in this section.

The order of operating modes shown here may be different from the arrangement on your product.

## Operating with fan





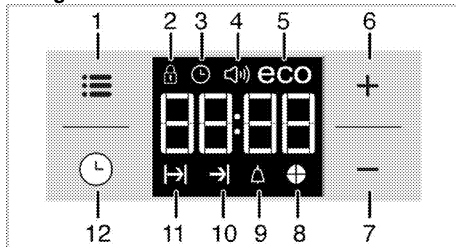

The oven is not heated. Only the oven lamp and the fan (in the rear wall) are in operation. Suitable for thawing frozen granular food slowly at room temperature and cooling down the cooked food.

Other functions are for cooking; select suitable temperature for your food.

## Using the oven clock





- 1 Adjustment key
- 2 Keylock symbol
- 3 Clock symbol
- 4 Alarm volume symbol
- 5 Eco mode symbol
- 6 Plus key
- 7 Minus key
- 8 Time pie symbol
- 9 Alarm symbol
- 10 End of Cooking Time symbol
- 11 Cooking Time symbol
- 12 Program key

	Maximum time that can be set for end of cooking is 5 hours 59 minutes. Program will be cancelled in case of power failure. You must reprogram the oven.
	While making any setting, related symbols will flash on the display. You must wait for a short time for the settings to take effect.
	If no cooking setting is made, time of the day cannot be set.
	Remaining time will be displayed if cooking time is set when the cooking starts.

## Cooking by setting the cooking time;









You can set the oven so that it will stop at the end of the specified time by setting the cooking time on the timer.

1. Select the function for cooking.
2. Touch  until  symbol appears on display for cooking time.
3. Set the cooking time with **+** / **-** keys.
- » » After the cooking time is set,  symbol and the time slice will appear on display continuously.
4. Place the dish into the oven and set the temperature with temperature knob. Cooking will start.

» Cooking time starts to count down on display when cooking starts and all parts of time slice symbol is lit. The set cooking time is divided into 4 equal parts and when the time of each parts ends, the symbol of that parts turns off. So you can understand the ratio of remaining cooking time to total cooking time easily.

## Setting the the end of cooking time to a later time;

After setting the cooking time on the timer, you can set the end of cooking time to a later time.

1. Select the function for cooking.
2. Touch  until  symbol appears on display for cooking time.
3. Set the cooking time with **+** / **-** keys.
- » » Once the Cooking Time is set,  symbol will appear on display continuously.
4. Touch  until  symbol appears on display for the end of cooking time.
5. Press **+** / **-** keys to set the end of cooking time.
- » After the cooking time is set,  symbol plus  symbol and the time slice will appear on display continuously. Once the cooking starts,  symbol disappears.

6. Place the dish into the oven and set the temperature with temperature knob. Cooking will start.

» **Oven timer calculates the startup time by deducting the cooking time from the end of cooking time you have set.** Selected operating mode is activated when the startup time of cooking has come and the oven is heated up to the set temperature. It maintains this temperature until the end of cooking time.

» Cooking time starts to count down on display when cooking starts and all parts of time slice symbol is lit. The set cooking time is divided into 4 equal parts and when the time of each parts ends, the symbol of that parts turns off. So you can understand the ratio of remaining cooking time to total cooking time easily.

7. After the cooking process is completed, **"End"** appears on the displayed and the timer gives an audio warning.
8. Audio warning sounds for 2 minutes. To stop the audio warning, just press any key. Audio warning will be silenced and current time will be displayed.



If you press any key at the end of the audio warning, the oven will restart operating. Turn the temperature knob and function knob to "0" (off) position to switch off the oven in order to prevent re-operation of the oven at the end of warning.

### Activating the keylock

You can prevent oven from being intervened with by activating the key lock function.

1. Touch until symbol appears on display.
- » **"OFF"** will appear on the display.
2. Press **+** to activate the key lock.
- » Once the key lock is activated, **"On"** appears on the display and the symbol remains lit.



When keys are not functional when the key lock is activated. Key lock will not be cancelled in case of power failure.

### To deactivate the keylock

1. Touch until symbol appears on display.
- » **"On"** will appear on the display.
2. Disable the key lock by pressing the **-** key.
- » **"OFF"** will be displayed once the keylock is deactivated.

### Setting the alarm clock

You can use the timer of the product for any warning or reminder apart from the cooking program.

The alarm clock has no influence on the functions of the oven. It is only used as a warning. For example, this is useful when you want to turn food in the oven at a certain point of time. Timer will give an audio warning at the end of the set time.

1. Touch until symbol appears on display.



Maximum alarm time can be 23 hours and 59 minutes.

2. Set the alarm duration by using **+** / **-** keys.



Function keys for alarm tone, time of day, display brightness and temperature keys should be at 0 (OFF) position.

- » symbol will remain lit and the alarm time will appear on the display once the alarm time is set.
3. At the end of the alarm time, symbol starts flashing and the audio warning is heard.

### Turning off the alarm

1. Audio warning sounds for 2 minutes. To stop the audio warning, just press any key.
- » Audio warning will be silenced and current time will be displayed.

### Cancelling the alarm;

1. Touch until symbol appears on display in order to cancel the alarm.
2. Press and hold **-** key until **"00:00"** is displayed.



Alarm time will be displayed. If the alarm time and cooking time are set concurrently, shortest time will be displayed.

### Changing alarm tone

1. Touch until symbol appears on display.
  2. Adjust the desired alarm tone with **+** / **-** keys.
  3. The tone you have set will be activated in a short time.
- » Selected alarm tone will appear as **"b-01"**, **"b-02"** or **"b-03"** on the display.

### Changing the time of the day

To change the time of the day you have previously set:

1. Touch until symbol appears on display.
2. Set the time of the day with **+** / **-** keys.
3. The time you have set will be activated in a short time.

### Economy mode

You can save energy with economy mode while cooking by setting cooking time in the oven. This mode completes the cooking with the inner temperature of the oven by switching off the heaters before the end of cooking time.

## Setting the economy mode

1. Touch  symbol until **eco** symbol appears on display.  
» **"OFF"** will appear on the display.
2. Enable economy mode by touching **+** key.  
» Once the economy mode is activated, **"On"** appears on the display and the eco symbol remains lit.

## Disabling economy mode

1. Touch  symbol until **eco** symbol appears on display.  
» **"On"** will appear on the display.
2. Disable economy mode by touching **—** key.  
» **"Off"** will be displayed once the eco mode is deactivated.

## Setting the screen brightness

1. Touch  until **d-01** or **d-02** or **d-03** appears on display for display brightness.
2. Set the desired brightness with **+**/**—** keys.  
» The time you have set will be activated in a short time.

## Cooking times table

 The timings in this chart are meant as a guide. Timings may vary due to temperature of food, thickness, type and your own preference of cooking.

## Baking and roasting

 1st rack of the oven is the **bottom** rack.

Food	Shelf level	Rack position	Temperature (°C)	Cooking time (min.) (approx.)
Fruit pies	One level	3	175	25 ... 30
Pizza	One level	3	190	12-25 mins depending on thickness
Small cakes	One level	3	160	25 ... 30
	2 levels	1 - 5	175	25 ... 30
Victoria sandwich	One level	3	160	25 ... 30
Biscuits	One level	3	160	20 ... 25
	2 levels	1 - 5	175	25 ... 30
Rich fruit cake (20-22cm)	One level	3	140	3-4 hours, if required cover with baking parchment
Bread	One level	3	190	20 ... 30
Roast beef; Sirloin, topside, topump, rib	One level	3	220 then 180	<b>20-30 mins, then</b> <b>Rare</b> <i>15mins per 450g/lb + 15 mins</i> <b>Medium</b> <i>20mins per 450g/lb + 20mins</i> <b>Well done</b> <i>25mins per 450g/lb + 25mins</i>
<b>Roast Lamb; Leg, shoulder, rack, breast, whole neck fillet</b>	One level	3	220 then 180	20-30 mins, then <b>20-25mins per 450g/lb + 20 mins</b>
Roast pork; loin, shoulder, leg	One level	3	220 then 180	20-30 mins, then <b>25-30 mins per 450g/lb + 25 mins</b>
Roast chicken	One level	3	220 then 180	20 mins, then <b>20-25 mins per 450g/lb + 20 mins</b>
Roast turkey	One level	2	250/max then 180...190	20-30 mins, then <b>25-30 mins per 450g/lb + 25 mins</b>
Casseroles	One level	3	150	2-3 hours
Whole fish	One level	3	180	20 ... 30
Pasta bake	One level	3	190	25 ... 30
While cooking with 2 trays at the same time, place the deep tray to the upper shelf and shallow tray to the lower shelf.				

## Tips for baking cake

- If the cake is too dry, increase the temperature by 10°C and decrease the cooking time.
- If the cake is wet, use less liquid or lower the temperature by 10°C.
- If the cake is too dark on top, place it on a lower rack, lower the temperature and increase the cooking time.
- If cooked well on the inside but sticky on the outside use less liquid, lower the temperature and increase the cooking time.

## Tips for baking pastry

- If the pastry is too dry, increase the temperature by 10°C and decrease the cooking time. Dampen the layers of dough with a sauce composed of milk, oil, egg and yoghurt.
- If the pastry takes too long to bake, pay care that the thickness of the pastry you have prepared does not exceed the depth of the tray.
- If the upper side of the pastry gets browned, but the lower part is not cooked, make sure that the amount of sauce you have used for the pastry is not too much at the bottom of the pastry. Try to scatter the sauce equally between the dough layers and on the top of pastry for an even browning.



Cook the pastry in accordance with the mode and temperature given in the cooking table. If the bottom part is still not browned enough, place it on one lower rack next time.

## Tips for cooking vegetables

- If the vegetable dish runs out of juice and gets too dry, cook it in a pan with a lid instead of a tray. Closed vessels will preserve the juice of the dish.
- If a vegetable dish does not get cooked, boil the vegetables beforehand or prepare them like canned food and put in the oven.

## How to operate the top oven

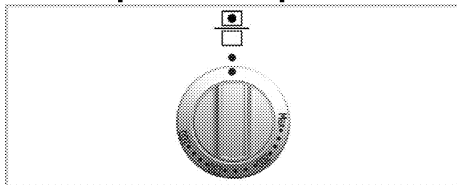

Grill oven can be used both as a grill and a baking oven. Switch on the top oven operates the oven when

the oven door is closed, and the grill when the oven door is opened.

## Turning on the oven

Oven is operated with Function knob. Oven is turned off when the Function knob is in Off (upper) position.

1. Close the oven door.
  2. Set the oven temperature.
- » Temperature light will turn of when the set temperature is attained.

## Turning off the grill oven

1. Turn the Function knob to Off (top) position.

## Cooking times table

	The timings in this chart are meant as a guide. Timings may vary due to temperature of food, thickness, type and your own preference of cooking.
	Maximum load capacity of oven tray: 4 kg (8.8 lb).
	1st rack of the oven is the <b>bottom</b> rack.

- Do not place cookware with rough bases on the oven door.
- Ensure that there is at least 25mm space at top of oven when cooking larger foods or using taller cookware.

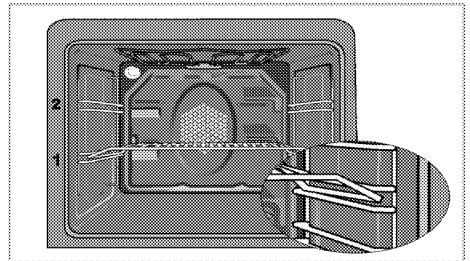

## Rack positions (For models with wire shelf)

It is important to position the wire grill on the wire shelf correctly. The wire grill must be placed so that it will fit into the opening of the wire shelf as illustrated in the figure.

## Cooking guide for top oven using top and bottom heat

- The timings in this chart are meant as a guide. Timings may vary due to temperature of food,



thickness, type and your own preference of cooking.

- Cook on the bottom Shelf level 1 only. Do not cook on the base of oven.
- Do not place cookware with rough bases on the oven door.
- Ensure that there is at least 25mm space between the top of oven when cooking larger foods or using taller cookware.
- Preheat oven first.
- When removing tray from top oven, pull as shown in picture and hold with two hands from two sides.

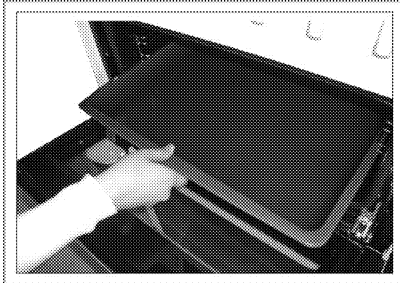
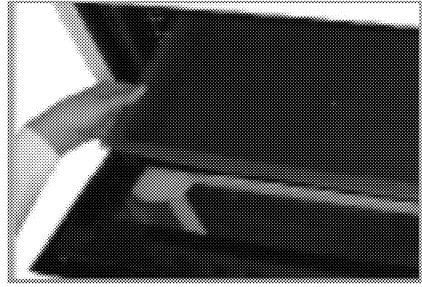

### Baking and roasting



1st rack of the oven is the **bottom** rack.

Food	Shelf level	Rack position	Temperature (°C)	Cooking time (min.) (approx.)
Fruit pies/pastries	One level	1	175	25 ... 30
Pizza	One level	1	190	12-25 mins depending on thickness
Small cakes	One level	2	160	25 ... 35
Victoria sandwich	One level	1	175	25 ... 30
Biscuits	One level	2	175	15 ... 20
Scones	One level	1	180	20 ... 25
Casseroles	One level	1	150	2-3 hours
Whole fish	One level	1	190	20 ... 30
Pasta bake	One level	1	200	25 ... 30

## How to operate the top grill



### WARNING

This product is designed for **OPEN DOOR GRILLING**.



### WARNING

Hot surfaces may cause burns! Keep children away from the product. Oven door remains slightly inclined when opened full and thus, possible splashes do not reach you.

There is a switch on the door. As a safety precaution, this switch prevents operation of the grill when the door is **CLOSED**.

Grill oven can be used both as a grill and a baking oven. Switch on the top oven operates the oven when the oven door is closed, and the grill when the oven door is opened.

The door switch functions as a selector between the grill and electric oven feature, i.e. when the door is closed while grilling, top oven automatically switches to electric oven and **continues working**.

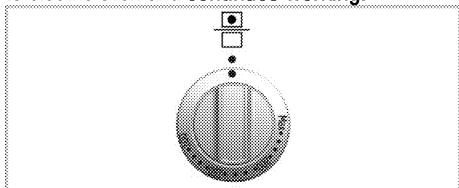

### Switching on the grill

Grill is operated with Function knob. Grill is turned off when the Function knob is in Off (upper) position.

1. Open the oven / grill door.
  2. Set the grill temperature to 150 °C and if required, perform a preheating for about 5 minutes.
  3. Then, select the desired grilling temperature.
- » Thermostat (temperature) light turns on.

### Turning off the grill oven

1. Turn the Function knob to Off (top) position.

## Electric grilling guide

- The timings in this chart are meant as a guide. Timings may vary due to starting temperature of food, thickness, type and your own preference of cooking.
- Cook only on Shelf level 1.
- If food is cooking too quickly, it can be placed in the bottom of the grill pan.
- Do not place cookware with rough bases on the oven door.
- Ensure that there is at least 25mm space at top of oven when grilling larger foods or using tall cookware.
- Always grill with the door open.
- Do not place aluminium foil on the wire rack to grill on.
- Turn food over to ensure it is cooked on both sides.
- Preheat grill first.
- Put big or medium-sized portions in correct rack position under the grill heater for grilling.
- For food only whose top is required to be roasted, grill the food either by placing onto the wire grill in the tray or by placing the tray onto the floor of grilling compartment.
- Food and plates placed onto the floor of grill compartment will get heated when the main oven is in use. Do not switch on the grill compartment when using it for storing food.



Foods that are not suitable for grilling carry the risk of fire. Only grill food which is suitable for intensive grilling heat. Do not place the food too far in the back of the grill. This is the hottest area and fatty food may catch fire.

## Top oven cooking times table for grilling Grilling with electric grill



1st rack of the oven is the **bottom** rack.

Food	Insertion level	Grilling time (approx.)	Preparation
Toast	1	2-4 mins	Place on wire rack in grill pan.
Bacon	1	4-6 mins	Place on wire rack in grill pan.
Gammon steaks	1	8-12 mins	Place on wire rack in grill pan.
Beefburgers	1	10-15 mins	Place on wire rack in grill pan.
Sausages	1	10-15 mins	Place on wire rack in grill pan.
Chops, chicken pieces	1	15-30 mins	Place on upturned wire rack in grill pan.
Fish fillets, fish fingers	1	10-20 mins	Place on wire rack in grill pan.
Grilling /browning tops of foods e.g. cottage pie	1	8-10 mins	Place on base of top oven.

## 7 Maintenance and care

### General information

Service life of the product will extend and the possibility of problems will decrease if the product is cleaned at regular intervals.



#### **DANGER:**

Disconnect the product from mains supply before starting maintenance and cleaning works.

There is the risk of electric shock!



#### **DANGER:**

Allow the product to cool down before you clean it.

Hot surfaces may cause burns!

- Clean the product thoroughly after each use. In this way it will be possible to remove cooking residues more easily, thus avoiding these from burning the next time the appliance is used.
- No special cleaning agents are required for cleaning the product. Use warm water with washing liquid, a soft cloth or sponge to clean the product and wipe it with a dry cloth.
- Always ensure any excess liquid is thoroughly wiped off after cleaning and any spillage is immediately wiped dry.
- Do not use cleaning agents that contain acid or chloride to clean the stainless or inox surfaces and the handle. Use a soft cloth with a liquid detergent (not abrasive) to wipe those parts clean, paying attention to sweep in one direction.



The surface might get damaged by some detergents or cleaning materials.

Do not use aggressive detergents, cleaning powders/creams or any sharp objects during cleaning.

Do not use harsh abrasive cleaners or sharp metal scrapers to clean the oven door glass since they can scratch the surface, which may result in shattering of the glass.



Do not use steam cleaners to clean the appliance as this may cause an electric shock.

### Cleaning the hob

#### **Glass ceramic surfaces**

Wipe the glass ceramic surface using a piece of cloth dampened with cold water in a manner as not to leave any cleaning agent on it. Dry with a soft and dry cloth. Residues may cause damage on the glass ceramic surface when using the hob for the next time.

Dried residues on the glass ceramic surface should under no circumstances be scraped with hook blades, steel wool or similar tools.

Remove calcium stains (yellow stains) by a small amount of lime remover such as vinegar or lemon juice. You can also use suitable commercially available products.

If the surface is heavily soiled, apply the cleaning agent on a sponge and wait until it is absorbed well. Then, clean the surface of the hob with a damp cloth.



Sugar-based foods such as thick cream and syrup must be cleaned promptly without waiting the surface to cool down. Otherwise, glass ceramic surface may be damaged permanently.

Slight color fading may occur on coatings or other surfaces in time. This will not affect operation of the product.

Color fading and stains on the glass ceramic surface is a normal condition, and not a defect.

#### **Cleaning the control panel**

Clean the control panel and knobs with a damp cloth and wipe them dry.



Do not remove the control buttons/knobs to clean the control panel.

Control panel may get damaged!



Do not remove the control buttons/knobs to clean the control panel.

Control panel may get damaged!

### Cleaning the oven

#### **To clean the side wall**

(This feature is optional. It may not exist on your product.)

1. Remove the front section of the side rack by pulling it in the opposite direction of the side wall.
2. Remove the side rack completely by pulling it towards you.

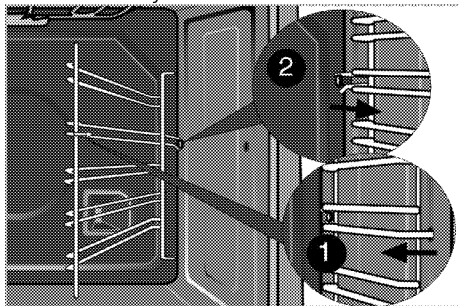

### Catalytic walls

(This feature is optional. It may not exist on your product.)

The inner side walls (A) and/or the rear wall (B) of your product may be coated with catalytic enamel. Catalytic walls have a light matte colour and a porous surface. Catalytic walls of the oven should not be cleaned. Porous surfaces of the catalytic walls are automatically cleaned by absorbing and converting the spilled oil (steam and carbon dioxide).

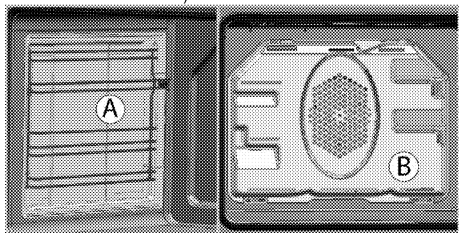

### Easy Steam Cleaning

It ensures easy cleaning because the dirt (having waited not for too long) is softened with the steam that forms inside the oven and the water drops condensing on the inner surfaces of the oven.

1. Remove all accessories inside the oven.
2. Pour 500 ml of water into the oven tray and place the tray at the 2nd rack of the oven.

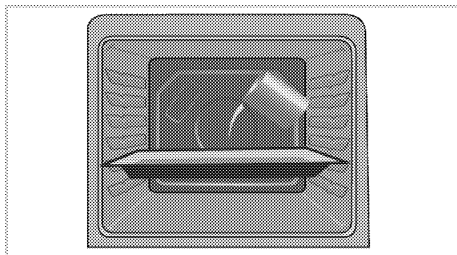

3. Set the oven at easy steam cleaning mode/ 100°C for 25 minutes.
4. Open the door and wipe the inner surfaces of the oven with a damp sponge or cloth.
5. Use warm water with washing liquid, a soft cloth or sponge to clean the persistent dirt and wipe it with a dry cloth.

### Clean oven door

To clean the oven door, use warm water with washing liquid, a soft cloth or sponge to clean the product and wipe it with a dry cloth.

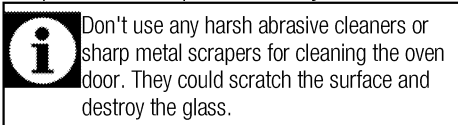

Don't use any harsh abrasive cleaners or sharp metal scrapers for cleaning the oven door. They could scratch the surface and destroy the glass.

### Removing the top oven door

1. Open the front door (1).
2. Open the clips at the hinge housing (2) on the right and left hand sides of the front door by pressing them down as illustrated in the figure.

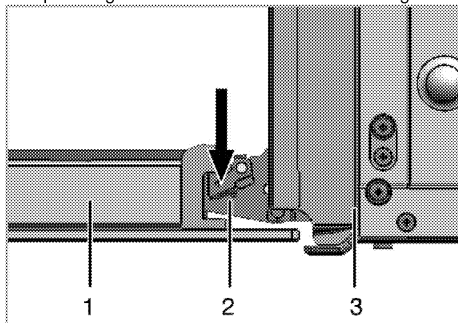

- 1 Front door
- 2 Hinge
- 3 Oven

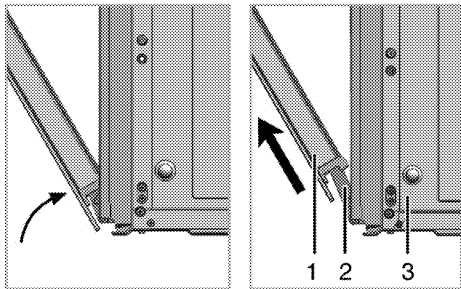

3. Move the front door to half-way.
4. Remove the front door by pulling it upwards to release it from the right and left hinges.

**i** Steps carried out during removing process should be performed in reverse order to install the door. Do not forget to close the clips at the hinge housing when reinstalling the door.

### Removing the door inner glass (This feature is optional. It may not exist on your product.)

1. Open the oven door.

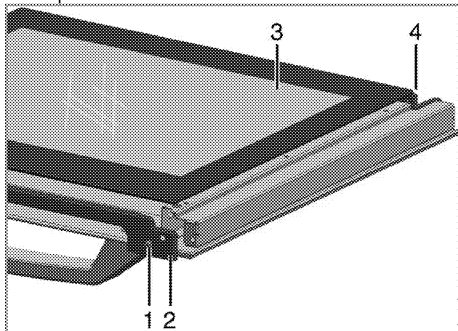

- 1 Screw
  - 2 Profile
  - 3 Inner glass pane
  - 4 Plastic slot
2. Take out the screw(1) with a screwdriver
  3. Take out the profile (2) than hold up to inner glass (3).
  4. Then group the door again, put the glass pane (3) to the plastic slots (4) and group the profile.

**i** If the oven door has three glasses, be sure to reattach the inner glass panel.

### Replacing the oven lamp



#### DANGER:

Before replacing the oven lamp, make sure that the product is disconnected from mains and cooled down in order to avoid the risk of an electrical shock. Hot surfaces may cause burns!



The oven lamp is a special electric light bulb that can resist up to 300 °C. See *Technical specifications, page 11* for details. Oven lamps can be obtained from Authorised Service Agents.



Position of lamp might vary from the figure.



The lamp used in this appliance is not suitable for household room illumination. The intended purpose of this lamp is to assist the user to see foodstuffs.



The lamps used in this appliance have to withstand extreme physical conditions such as temperatures above 50 °C.

#### If your oven is equipped with a round lamp:

1. Disconnect the product from mains.
2. Turn the glass cover counter clockwise to remove it.

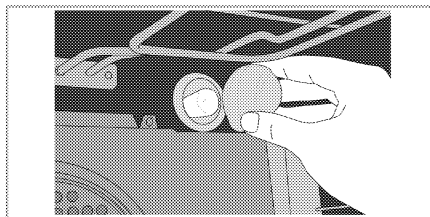

3. If your oven lamp is of type (A) shown in the figure below, remove it by rotating as shown and replace it. If it is of type (B), pull and remove it as shown in the figure and replace it.

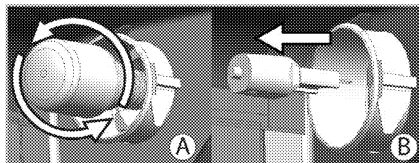

4. Install the glass cover.

## 8 Troubleshooting

### Oven emits steam when it is in use.

- It is normal that steam escapes during operation. >>> *This is not a fault.*

### Product emits metal noises while heating and cooling.

- When the metal parts are heated, they may expand and cause noise. >>> *This is not a fault.*

### Product does not operate.

- The mains fuse is defective or has tripped. >>> *Check fuses in the fuse box. If necessary, replace or reset them.*
- Product is not plugged into the (grounded) socket. >>> *Check the plug connection.*
- Buttons/knobs/keys on the control panel do not function. >>> *Keylock may be enabled. Please disable it. (See. Using the keylock, page*

### Oven light does not work.

- Oven lamp is defective. >>> *Replace oven lamp.*
- Power is cut. >>> *Check if there is power. Check the fuses in the fuse box. If necessary, replace or reset the fuses.*

### Oven does not heat.

- Function and/or Temperature are not set. >>> *Set the function and the temperature with the Function and/or Temperature knob/key.*
- In models equipped with a timer, the timer is not adjusted. >>> *Adjust the time.* (In products with microwave oven, timer controls only microwave oven.)
- Power is cut. >>> *Check if there is power. Check the fuses in the fuse box. If necessary, replace or reset the fuses.*

### (In models with timer) Clock display is blinking or clock symbol is on.

- A previous power outage has occurred. >>> *Adjust the time / Switch of the product and switch it on again.*



Consult the Authorised Service Agent or the dealer where you have purchased the product if you can not remedy the trouble although you have implemented the instructions in this section. Never attempt to repair a defective product yourself.

## 9 Guarantee Details

### BEKO UK AND IRELAND STANDARD MANUFACTURER GUARANTEE TERMS AND CONDITIONS

Your new Beko product is guaranteed against faulty materials, defective components or manufacturing defects.

The standard guarantee starts from the date of original purchase of the product, and lasts for a period of twelve (12) months unless Beko plc (the "Manufacturer") agrees to extend the guarantee for the product in writing.

If you have purchased an American style Fridge freezer, the standard guarantee starts from the date of original purchase of the product, and lasts for a period of twenty four (24) months unless Beko plc (the "Manufacturer") agrees to extend the guarantee for the product in writing.

If you have any questions about the guarantee on your product (including how long it is valid), please contact your retailer or our contact centre on **0333 207 9710** (UK and Northern Ireland) or 01 862 3411 (Republic of Ireland)

This guarantee does not in any way diminish or affect your statutory rights in connection with the product. This guarantee is in addition to your statutory rights as a consumer. If you have any questions about these rights, please contact the retailer from which you purchased the product. In certain circumstances, it is possible that your statutory rights may offer additional or higher levels of protection than those offered under the terms of this guarantee.

#### What is covered by this guarantee?

- Repairs to the product required as a result of faulty materials, defective components or manufacturing defects.
- Functional replacement parts to repair a product.
- The costs of a Beko Approved Engineer to carry out the repair.

#### What is not covered?

- Transit and delivery damage.
- Cabinet or appearance parts, including but not limited to control knobs, flaps and handles.
- Accessories and/or consumable items including but not limited to ice trays, scrapers, cutlery baskets, filters and light bulbs.
- Repairs necessary as a direct or indirect result of:
  - Accidental damage, misuse or abuse of a product.
  - An attempted repair of a product by anyone other than a Beko Approved Engineer (the "Engineer").
  - Installation or use of a product where such installation or use fails to meet the requirements contained in this guarantee or the User Instructions Booklet.
- Repairs to a product operated at any time on commercial or non-residential household premises (unless we have previously agreed to the installation environment).

This guarantee is limited to the cost of repairing the product. To the extent permitted by law, the Manufacturer does not accept and will not be held liable for any financial loss incurred in connection with the failure of any product to operate in accordance with the expected standards. Such financial loss includes but is not limited to loss arising from:

- Time taken off work.

- Damaged food, clothing or other items.
- Meals taken at restaurants or from takeaways.
- General compensation for inconvenience.

## **Important Notes**

1. Your product is designed and built for domestic household use only.
2. The guarantee will automatically be void if the product is installed or is used in commercial or non-residential domestic household premises, unless we have previously agreed to the installation environment.
3. The product must be correctly installed, located and operated in accordance with the instructions contained in the User Instructions Booklet provided with your product.
4. Professional installation by a qualified Electrical Domestic Appliance Installer is recommended for all Washing Machines, Dishwashers and Electric Cookers (as incorrect installation may result in you having to pay for the cost of repairing the product).
5. Gas Cookers must be professionally installed by a Gas Safe (or Gas Networks Ireland for Republic of Ireland) registered gas installer.
6. This guarantee is given in respect of products purchased and used within the United Kingdom and the Republic of Ireland.
7. This guarantee is effective from the initial date of purchase of a new product from an authorised retailer and will be void if the product is resold.
8. This guarantee does not apply to graded sales (where the product is purchased as a "second").
9. Possession of a copy of these terms and conditions does not necessarily mean that a product has the benefit of this guarantee. If you have any questions, please call our Call Centre on the number set out above.
10. The Manufacturer reserves the right to terminate the guarantee if its staff or representatives are subjected to physical or verbal abuse in the course of carrying out their duties.
11. Optional extras, where available (i.e. extendable feet) are supplied on a chargeable basis only.

## **Does Beko offer replacements?**

This is a repair-only guarantee. On occasion, the Manufacturer may at its sole discretion, replace your product with a new product instead of carrying out a repair. Where a replacement is offered, this would normally be an identical model but when this is not possible, a model of similar specification will be provided. The Manufacturer will cover the costs and arrange for the delivery of the new product and for the return of the old product. Any costs related to disconnecting the faulty product and installing the replacement product will not be borne by the Manufacturer unless previously agreed to in writing. The original guarantee will continue to apply to the replacement product; the new product will not come with a new guarantee.

## **When will the repair take place?**

Our Engineers work Monday to Friday 9.00am to 5.00pm. Appointments outside these hours may be possible at the sole discretion of the Manufacturer but cannot be guaranteed. Whilst our Engineers will endeavour to minimize inconvenience and to meet requests for specific timed appointments, this cannot be guaranteed. We will not be liable for delays or if it is unable to carry out a repair because a convenient appointment cannot be arranged.



## **Will there be any charge for the repairs?**

It is your responsibility to provide evidence to the Engineer that your product is covered by this guarantee with a proof of purchase. The Manufacturer reserves the right to charge for the reasonable cost of any service call if:

- You cannot provide evidence that your product is covered by this guarantee.
- Where a service call has been made and the engineer finds that there is no fault with your product.
- That your product has not been installed or operated in accordance with the User Instructions Booklet.
- That the fault was caused by something other than faulty materials, defective components or manufacturing defects.
- For missed appointments.

Payment of these costs are due immediately upon the Engineer providing you with an invoice. The Manufacturer reserves the right to terminate the guarantee if you fail to pay the costs for the service call in a timely manner.

If you are a resident of the United Kingdom, this guarantee will be governed by English law and subject to the English Courts, save where you live in another part of the United Kingdom, in which case the law and courts of that location will apply.

If you are resident in the Republic of Ireland, this guarantee will be governed by Irish law and the Irish courts will have jurisdiction.

This guarantee is provided by Beko plc. Beko House, 1 Greenhill Crescent, Watford, Hertfordshire. WD18 8QU.

Beko plc is registered in England and Wales with company registration number 02415578.

## **BEKO UK AND IRELAND BUILT-IN APPLIANCES GUARANTEE TERMS AND CONDITIONS**

If you have purchased a built-in or integrated appliance, and registered it within 90 days of purchase by completing the online registration form, then the standard 12 month guarantee will be extended to 24 months, under the same terms and conditions as detailed in our Standard Guarantee Terms and Conditions.

## **BEKO UK AND IRELAND PROSMART INVERTER MOTOR GUARANTEE TERMS AND CONDITIONS**

**This 10 year guarantee relates to Beko products that feature the ProSmart Inverter Motor.**

The ProSmart Motor guarantee terms and conditions are in addition to our Standard guarantee terms and conditions detailed in the previous section.

**In order to activate the 10 year guarantee you MUST register the appliance within 90 days of the original purchase date. You can register by first visiting [Beko.co.uk/register](http://Beko.co.uk/register) and by following the online instructions.**

Beko Free standing appliances come with a 12 month parts and labour guarantee as standard,

Beko Built-in appliances come with a 12 month parts and labour guarantee as standard. This is extended to 24 months, free of charge, upon registration of the appliance. When you register your appliance for additional guarantee, you will automatically activate the ProSmart Motor 10 year guarantee. You do not need to register twice. ([beko.co.uk/guarantee-terms](http://beko.co.uk/guarantee-terms)).

To make a claim against your Beko ProSmart Inverter Motor Guarantee (the "Guarantee"), all customer and product details must be registered with Beko plc using the procedure outlined below.

1. This extra 9 years (for free standing appliances) or 8 years (for built-in or integrated appliances) guarantee is only effective after the expiration of the standard manufacturer's guarantee.
2. It is only valid for the ProSmart Inverter motors of selected washing machines, washer-dryers, tumble dryers and dishwashers. It does not cover any labour charge or any other components of the product. In addition, it is only valid for one replacement of the ProSmart motor during the extra 9-year (for free standing appliances) or 8 year (for built-in appliances) guarantee period.
3. To activate your guarantee, you MUST register your appliance within 90 days of the original purchase date, by visiting [beko.co.uk/register](http://beko.co.uk/register).
4. Customers will receive a unique reference code as proof of guarantee validation by email or post, which must be quoted at the time of a claim being made.
5. Any repair/replacement of the ProSmart Inverter motor must only be carried out by an authorised Beko Service Agent (the "Service Agent").
6. Labour for the repair/replacement of the ProSmart Inverter motor is not included in this guarantee and is chargeable directly by the Service Agent.
7. Any additional components fitted to the product at any time will not be covered by this guarantee and will be chargeable directly by the Service Agent.
8. The guarantee is not transferable and cannot be exchanged for cash.
9. There are no alternative or additional offers to this Guarantee.
10. The guarantee is exclusive of the manufacturer's standard guarantee.

11. The Terms and Conditions shown above are in addition to the standard terms and conditions of your product guarantee. Please read and refer to such Terms and Conditions when making any claim.
12. We may use the information you provide for marketing purposes and to analyse your purchasing preferences. We may keep your information for a reasonable period for these purposes in accordance with the applicable Data Protection Laws and General Data Protection Regulations (GDPR). You can opt into this service during the registration process. Further details are available at <http://www.beko.co.uk/cookie-and-privacy>.
13. These Terms and Conditions are governed by the laws of England and Wales; manufacturer: Beko plc, Beko House, 1 Greenhill Crescent, Watford WD18 8QU. Company Registration Number: 02415578.

## HOW TO OBTAIN SERVICE FOR YOUR APPLIANCE

Please keep your purchase receipt or other proof of purchase details in a safe place; you will need to have this documentation available should the product require attention under guarantee.

Please take a few moments to complete the details below, as you will need this information when you call us, or to use our online services. When you call us you may be required to input your serial number into your telephone keypad. For help please visit [beko.co.uk/support/model-finder](http://beko.co.uk/support/model-finder)

- The product model number is printed on the Operating Instruction Booklet / User guide
- The product model and serial number is printed on the Rating Label affixed to the appliance.
- The Retailer (Purchased from) and Date of purchase will be printed on your purchase receipt or other proof of purchase paperwork

Recording of these details alone will not count as proof of purchase. A valid proof of purchase is required for requesting service under guarantee.

Model number	Serial number	Purchased from	Date of purchase

### For service under guarantee or for product advice please call our Contact centre

Before requesting service please check the troubleshooting guide in the Operating Instructions booklet, as a charge may be levied where no fault is found, and even though your product may still be under guarantee.

After arranging service the area around the product must be easily accessible to the Engineer, without the need for cabinets or furniture to be removed or moved.

It is your responsibility to ensure our Engineers have a clean and safe environment to carry out any repairs.

Please have your Model number and Serial number available when you call us, as you may be required to input your serial number into your telephone keypad during your call.

### UK Mainland & Northern Ireland:

# 0333 207 9710

Landline or mobile calls to 0333 numbers cost no more than calls to geographic numbers 01 or 02, and are charged at the basic rate. Calls from landlines and mobiles are included in free call packages but please check with your telephone service provider for exact call charges.

**Republic of Ireland:**

**01 862 3411**

**Service once the manufacturers guarantee has expired**

If you have purchased an extended guarantee please refer to the instructions contained within the extended guarantee agreement document, otherwise please call us using the appropriate number above, where service can be obtained at a charge.

Should you experience any difficulty in obtaining service please call us on **0333 207 9710** or **01 862 3411**

**Contact us through our website**

Send us a secure message through our online contact us form. Please visit our website, click Contact Us and choose a product support topic from the list of options. Complete the required details and click send message.

**Product registrations**

For UK registrations please visit [beko.co.uk/register](http://beko.co.uk/register) and for the Republic of Ireland visit [beko.ie/register](http://beko.ie/register).







## Free Manuals Download Website

<http://myh66.com>

<http://usermanuals.us>

<http://www.somanuals.com>

<http://www.4manuals.cc>

<http://www.manual-lib.com>

<http://www.404manual.com>

<http://www.luxmanual.com>

<http://aubethermostatmanual.com>

Golf course search by state

<http://golfingnear.com>

Email search by domain

<http://emailbydomain.com>

Auto manuals search

<http://auto.somanuals.com>

TV manuals search

<http://tv.somanuals.com>