

Microwave Oven

User Manual



MGC20100W | MGC20100S

EN

01M-8850433200-0817-03

beko



Please read this manual first!

Dear Customer,

Thank you for selecting a Beko product. We hope that you get the best results from your product which has been manufactured with high quality and state-of-the-art technology. Therefore, please read this entire user manual and all other accompanying documents carefully before using the product and keep it as a reference for future use. If you handover the product to someone else, give the user manual as well. Follow all warnings and information in the user manual.

Meanings of the symbols

Following symbols are used in the various section of this user manual:

	Warnings for dangerous situations concerning the safety of life and property.
	Warning for hot surfaces.



This product has been manufactured in environmentally modern facilities.

This appliance conforms to the WEEE regulation.



This product does not contain PCB's.

CONTENTS

1 Important safety and environmental instructions 4

1.1 General safety	4
1.1.1 Electrical safety	6
1.1.2 Product safety	7
1.2 Intended use	8
1.3 Children's safety	8
1.4 Compliance with the WEEE Directive and Disposing of the Waste Product:	10
1.5 Compliance with RoHS Directive	10
1.6 Package information	10
1.7 Plug Wiring	10

2 Technical Specifications of the Product 11

3 Description of the product 12

Control panel	12
Power setting	12
Accessories	13
Glass plate	13
Rotating base	13
Grill Rack	13
Microwave oven cookware	13
Metal cookware - foils	14
Glass cookware	14
Plastic cookware - bags	14
Paper	14
Wooden or wicker cookware	14

4 Operating your product 15

Placing the food	15
Useful suggestions	15
To defrost:	15
Amount of food	15
Moisture content	15
Condensation	15
Sugar	15
Reducing the pressure in foods	16
Mixing and turning the food during cooking ..	16
Different cooking times	16

Resting time	16
Grill	16
Combination Mode	17
Operating your oven	17
Cooking table	18
Cooking table	19
Defrosting	20
Defrosting table	20
Heating table	21
Heating	21

5 Cleaning and Care 22

Outer surfaces	22
Inner surfaces	22
For transportation;	22

6 Guarantee 23

Important Safety Instructions Read Carefully And Keep For Future Reference

This section contains safety instructions that will help protect from risk of fire, electric shock, exposure to leak microwave energy, personal injury or property damage. Failure to follow these instructions shall void any warranty.

1.1 General safety

- The microwave oven is intended for heating food and beverages. Drying of or clothing and heating of warming pads, slippers, sponges, damp cloth and similar may lead to risk of injury, ignition or fire.

This appliance is intended to be used in household and similar applications such as:

- Staff kitchen areas in shops, offices and other working environments;
- By clients in hotels, and other residential type environments;
- Bed and Breakfast type environments.

- Do not attempt to start the oven when its door is open; otherwise you may be exposed to harmful microwave energy. Safety locks should not be disabled or tampered with.
- Do not place any object between the front side and the door of the oven. Do not allow dirt or cleaning agent remnants to build up on the closure surfaces.
- Any service works involving removal of the cover that provides protection against exposure to microwave energy must be performed by authorized persons/service. Any other approach is dangerous.
- Your product is intended for cooking, heating and defrosting food at home.
- Do not use this appliance outdoors, in bathrooms or humid environments or in places where the it can get wet.
- No responsibility or warranty claim shall be assumed for damages arising from misuse or improper handling of the appliance.
- Never attempt to dismantle the appliance. No warranty claims are accepted for damage caused by improper handling.

1

Important safety and environmental instructions

- Only use the original parts or parts recommended by the manufacturer.
- Do not leave this appliance unattended while it is in use.
- Always use the appliance on a stable, flat, clean dry, and non-slip surface.
- Do not use with an external clock timer or separate remote control system.
- Before using the appliance for the first time, clean all parts. Please see the details given in the "Cleaning and Maintenance" section.
- Operate the appliance for its intended purpose only as described in this manual. Do not use abrasive chemicals or steam on this appliance. This oven is particularly intended for heating and cooking the food.
It is not intended for industrial or laboratory use.
- Do not use your appliance to dry clothes or kitchen towels.
- Appliance becomes very hot while it is in use. Pay attention not to touch the hot parts inside the Microwave oven.
- Your microwave oven is not designed to dry any living being.
- Do not operate the microwave oven when it is empty.
- Cooking utensil may get hot due to the heat transferred from the heated food to the utensil. You may need oven gloves to hold the utensil.
- Utensils shall be checked to ensure that they are suitable for use in microwave ovens.
- Do not place the microwave oven on cooking hobs or other heat generating appliances. Otherwise, it may be damaged and the warranty becomes void.
- The microwave oven must not be placed in a cabinet that is not in compliance with the installation instructions.
- Take care when removing lids from food packages after heating as steam is present.
- Use gloves while taking any kind of heated food out of the microwave oven.

- All appliance surfaces may be very hot when the appliance is in use.
- Door and outer glass may be very hot when the appliance is in use do not use the microwave oven.
- Use the appliance with a grounded outlet only.
- Never use the appliance if the power cable or the appliance itself is damaged.

1.1.1 Electrical safety

- If the supply cord is damaged, The supply cord must be replaced by the manufacturer or its service agent or a similarly qualified person in order to avoid a hazard.
- Beko Microwave Ovens comply with the applicable safety standards; therefore, in case of any damage on the appliance or power cable, it should be repaired or replaced by the dealer, service center or a specialist and authorized service alike to avoid any danger. Faulty or unqualified repair work may be dangerous and cause risk to the user.
- Make sure that your mains power supply complies with the information supplied on the rating plate of the appliance.

The only way to disconnect the appliance from the power supply is to remove the power plug from the power outlet.
- Do not use this appliance with an extension cord.
- Never touch the appliance or its plug with damp or wet hands.
- Place the appliance in a way so that the plug is always accessible.
- Prevent damage to the power cable by not squeezing, bending, or rubbing it on sharp edges. Keep the power cable away from hot surfaces and naked flame.
- Make sure that there is no danger that the power cable could be accidentally pulled or that someone could trip over it when the appliance is in use.
- Unplug the appliance before cleaning and when the appliance is not in use.
- Do not pull the power cable of the appliance to disconnect it from its power supply and never wrap its power cable around the appliance.
- Do not immerse the appliance, power cable, or power plug in water or any other liquids. Do not hold it under running water.

- When heating food in plastic or paper containers, keep an eye on the oven due to the possibility of ignition.
- Ensure containers are suitable for microwave use.
- Remove the wire strings and/or metal handles of paper or plastic bags before placing bags suitable for use in microwave oven to the oven.
- If smoke is observed, switch off or unplug the appliance if safe to do so and keep the door closed in order to stifle any flames.
- Do not use microwave oven for storage. Do not leave paper items, cooking material or food inside the oven when it is not being used.
- The contents of feeding bottles and baby food should shall be stirred or shaken and the temperature checked before consumption, in order to avoid burns.
- This appliance is a Group 2 Class B ISM equipment. Group 2 contains all ISM (Industrial, Scientific and Medical) equipment in which radio-frequency energy is intentionally generated and/or used in the form of electromagnetic radiation for the treatment of material, and spark erosion equipment.
- Class B equipment is suitable for use in domestic establishments and establishments directly connected to a low voltage power supply network.
- Door or outer surface of the appliance may become hot when it is in use.

1.1.2 Product safety

- Be careful when removing beverages and food from the microwave.
- Do not use cooking oil in the oven. Hot oil may damage the components and materials of the oven, and it may even cause skin burns.
- Pierce food with thick crust such as potatoes, courgettes, apples and chestnuts.
- Appliance must be placed so that the rear side is facing the wall.
- Before moving the appliance, please secure the turntable to prevent damage.
- Eggs in their shell and whole hard-boiled eggs must not be heated in microwave ovens since they may explode, even after microwave heating has ended.

1

Important safety and environmental instructions

- Never remove the parts at the rear and sides of the appliance, which protect the minimum distances between the cabinet walls and the appliance in order to allow for the required air circulation.
- Do not use the appliance as a heat source.
- Microwave oven is intended to thaw, cook and stew food only.
- Do not over-cook foods; otherwise, you may cause a fire.
- Do not use steam assisted cleaners to clean the appliance.

1.2 Intended use

- **WARNING:** If the door or door seals are damaged, the oven must not be operated until it has been repaired by a qualified person.
- **WARNING:** It is hazardous for anyone other than a competent person to carry out any service or repair operation which involves the removal of a cover which gives protection against exposure to microwave energy.
- **WARNING:** Liquids and other foods must not be heated in sealed containers since they are liable to explode.
- The oven should be cleaned regularly and any food deposits removed.
- There should be min 20cm free space above the top surface of the oven.
- Do not use the appliance for anything other than its intended use.

1.3 Children's safety

- Extreme caution is advised when being used near children and persons who are restricted in their physical, sensory or mental abilities.
- This appliance can be used by the children who are at the age of 8 or over and by the people who have limited physical, sensory or mental capacity or who do not have knowledge and experience, as long as they are supervised with regard to safe use of the product or they are instructed accordingly or understand the risks of using the product. Children should not play with the appliance. Cleaning and user maintenance procedures should not be performed by children unless they are controlled by their elders.

1

Important safety and environmental instructions

- Danger of choking! Keep all the packaging materials away from children.
- Only allow children to use the oven without supervision when adequate instructions have been given so that the child is able to use the microwave oven in a safe way and understands the hazards of improper use.
- Due to excessive heat that arises in grill and combination modes, children should only be allowed to use these modes under supervision of an adult.
- Keep the product and its power cable so that they are inaccessible by children under 8 years old.
- The appliance and its accessible surfaces may be very hot when the appliance is in use. Keep children away.
- The appliance is not intended for use by persons (including children) with reduced physical, sensory or mental capabilities, or lack of experience and knowledge, unless they have been given supervised or instruction concerning use of the appliance by a responsible person for their safety.
- Young children should be supervised to ensure that they do not play with the appliance.
- **WARNING:** Only allow children to use the oven without supervision when adequate instructions have been given so that the child is able to use the oven in a safe way and understands the hazards of improper use.

1

Important safety and environmental instructions

1.4 Compliance with the WEEE Directive and Disposing of the Waste Product:

This product complies with EU WEEE Directive (2012/19/EU). This product bears a classification symbol for waste electrical and electronic equipment (WEEE).



This product has been manufactured with high quality parts and materials which can be reused and are suitable for recycling. Do not dispose of the waste product with normal domestic

and other wastes at the end of its service life. Take it to the collection center for the recycling of electrical and electronic equipment. Please consult your local authorities to learn about these collection centers.

1.5 Compliance with RoHS Directive

The product you have purchased complies with EU RoHS Directive (2011/65/EU). It does not contain harmful and prohibited materials specified in the Directive.

1.6 Package information



Packaging materials of the product are manufactured from recyclable materials in accordance with our National Environment Regulations. Do not dispose of the packaging materials together with the domestic or other wastes. Take them to the packaging material collection points designated by the local authorities.

1.7 Plug Wiring

The moulded plug on this appliance incorporates a 13 A fuse. Should the fuse need to be replaced an ASTA approved BS1362 fuse of the same rating must be used. Do not forget to refit the fuse cover. In the event of losing the fuse cover, the plug must not be used until a replacement fuse cover has been fitted. Colour of the replacement fuse cover must be the same colour as that visible on the pin face of the plug. Fuse covers are available from any good electrical store.

• Fiting a different plug

As the colours of the wires in the mains lead of this appliance may not correspond with the coloured markings identifying the terminals on your plug, proceed as follows:

- Brown cable = L (Live)
- Blue cable = N (Neutral)
- Green/yellow cable must be connected to ground (E) \equiv line

With the alternative plugs a 13 A fuse must be fitted either in the plug or adaptore or in the main fuse box. If in doubt contact a qualified electrician.

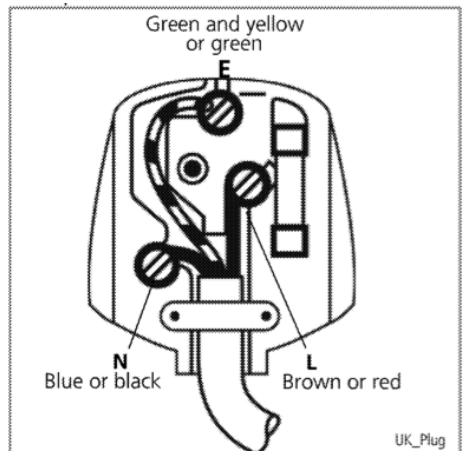

2 Technical Specifications of the Product

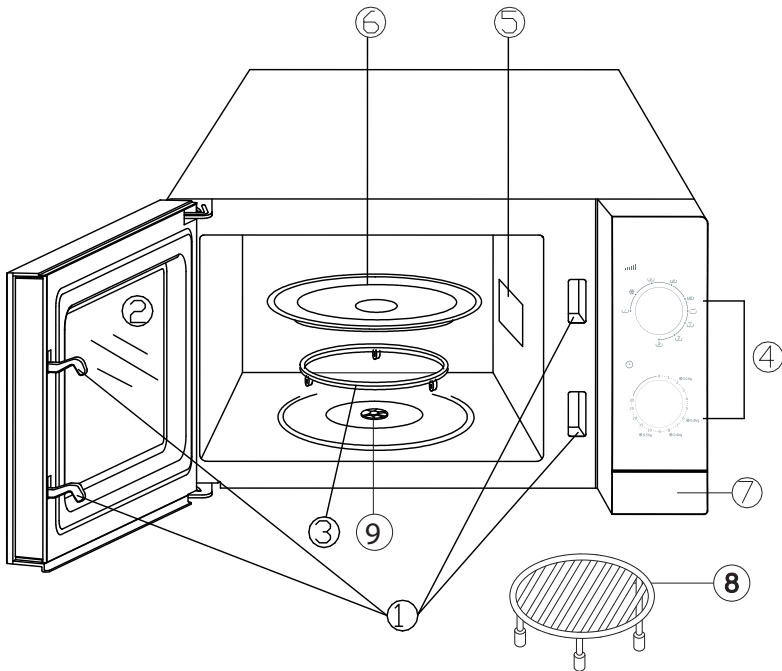

1. Door lock system
2. Front door glass
3. Rotating base support
4. Control panel
5. Microwave guide
6. Glass plate
7. Door open key
8. Grill rack (only to be used in grill function and placed on the glass tray)
9. Shaft

External width	449 mm
External depth	312 mm
External height	262 mm
Oven volume	20 L
Weight	10.5 kg
Supply voltage	230-240V~50 Hz
Output power	700 W
Total power	1200 W
Time	0-30 minutes
Grill power	900 W
Colour	White / Silver

Markings on the appliance or the values stated in other documents supplied with the product are values obtained under laboratory conditions as per relevant standards. These values may vary according to the usage of the appliance and ambient conditions.

3 Description of the product

Control panel

Power setting
button

Time setting
button

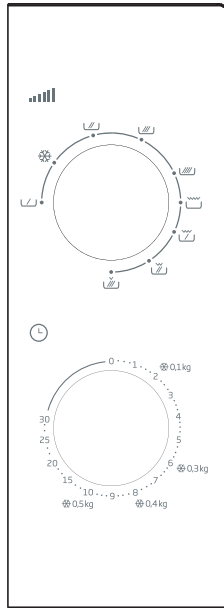

Power setting

The setting button at the upper section of the control panel will allow you to use any of the 9 different power levels.

The following table contains some sample meals and corresponding power levels to cook them in microwave oven.

Power Level	Usage
High	<ul style="list-style-type: none"> - Boiling water - Minced meat - Cooking chicken/turkey, fish and vegetables - Cooking thin sliced meat
Medium	<ul style="list-style-type: none"> - Cooking cakes and pastries - Cooking soup or rice
Medium-Low	<ul style="list-style-type: none"> - Melting butter and chocolate
Defrosting	<ul style="list-style-type: none"> - Thawing frozen food
Low	<ul style="list-style-type: none"> - Softening butter and cheese - Softening the ice cream - Raising the yeast dough

3 Description of the product

Accessories

Glass plate

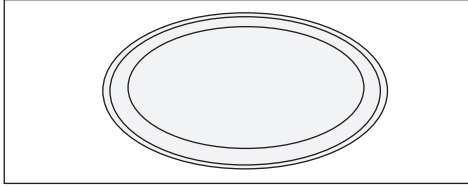

Use the glass plate during cooking, as this will serve to collect cooking juices and food remnants and prevent these from dirtying the base of the microwave oven.

- The glass plate can be washed in a dishwasher.
- Place the glass plate onto the rotating base.

Rotating base

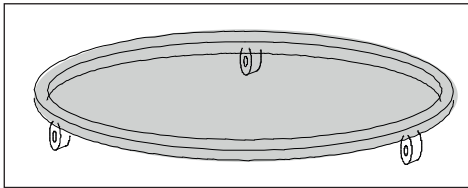

The rotating base must be placed below the glass plate. Do not place any other plate apart from the supplied glass plate onto the rotating base. Wash the rotating base with warm and soapy water at least once a week.

The rotating base must be fit securely into its seating.

Grill Rack

Wire grill must be used with grill cooking and combination programme. You must place the grill rack on glass plate. Thus, you can prevent oven from getting damaged and fats from dripping on the base.

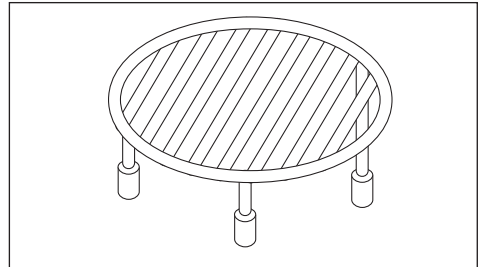

Microwave oven cookware

Use round cookware for cooking instead of elliptic or rectangular cookware. Otherwise, the food that remains on the edges will be effected more by the microwave and edges will get overcooked.

- Microwave can pass through substances such as paper, plastic, glass and ceramic without producing any heat. Cookware made of such materials can be suitable for use in cooking in some cases.
- You can employ the following method to check whether the cookware you will put your food is suitable for microwave cooking.

Place the empty cookware with a glass full of water on it onto the glass plate in microwave oven and select and run Max power level for 60 seconds. Cookware that overheat after this process should not be used.

3 Description of the product

Metal cookware - foils

Metal cookware reflects the microwaves away from the food. Therefore, do not use them. Aluminum foil in small pieces or stripes can be used to cover wings or legs, or the parts that remain on the edge such as thin tips of the joints of poultry. Flat cooking trays with a depth less than 1.5 cm on the edges can also be used; however, in such grease proof paper and cling film should be used instead of foil.

Glass cookware

Very thin glass cookware and crystal with lead content should not be used.

Plastic cookware - bags

Melamine cookware and lids as well as the bags used for freezing or preservation should not be used.

Paper

Do not use any type of paper during cooking in the microwave oven.

Wooden or wicker cookware

Large wooden cookware should not be used as the microwave energy causes the wood get dry and crispy.

4 Operating your product

Placing the food

- You will get the best results if you scatter the food into the plate. This may be achieved in various ways to get better results.
- If you will cook too many pieces of the same type (such as potatoes with skin) place them in a circular form.
- When cooking food with different shapes and thicknesses, place the smallest and thinnest part into the middle of your cookware. Thus, you can have that piece cooked last.
- Place food with irregular shape such as fish in a way that their tails will be in the middle of the cookware.
- When storing a meal in the refrigerator or heating it, place the thick and dense ones to out and thin and less dense ones in.
- Place thin sliced meat pieces on top of each other.
- Thicker pieces such as sausage and chopped meat should not be placed close to each other.
- Heat broth and sauces in separate cookware. Prefer narrow and long cookware to wide and long ones. Do not fill more than 2/3 of the cookware when heating broth, sauce or soup.
- If you will cook whole fish, make some cuts on it; thus you will prevent skin from bursting.
- Cover the head and tail parts of the fish with aluminum foil to protect them against overcooking.
- If you are using cling film, a cooking bag or grease proof paper, make a hole or leave a small opening in order to allow steam get out.
- Food with small pieces will get cooked sooner than the ones with large pieces and the ones with regular shapes will get cooked sooner than the ones with irregular shapes. Cut the food in even sizes and regularly to cook them in the best way possible.

Useful suggestions

To defrost:

- Shape of the package may change the defrost time. Shallow rectangular packages will defrost quicker than the deep cookware.
- Separate the pieces from each other as they get defrosted. Thus other pieces will defrost easier.
- Cover the parts of the food that start heating with small pieces of foil. Wood toothpicks will help keeping the foil in place.

Amount of food

The more food you cook the more time it will take. Double amount of food mean double amount of time.

Moisture content

Cooking time will change depending of the amount of juice as microwave is sensitive to moisture. Food with natural juice (vegetables, fish and poultry) will get cooked quickly and easily. Adding water is suggested when cooking dry food such as rice and beans in microwave.

Condensation

Moisture in food items may sometimes cause condensation inside the oven during cooking. This is normal. Generally, foods that are covered will cause less condensation.

Sugar

Follow the suggestions in microwave cooking books when cooking food items such as pudding or tart which contain too much sugar or butter. If you exceed the suggested time, you may cause the food item get burned or the oven get damaged.

4 Operating your product

Reducing the pressure in foods

Many food items are covered with skin or shell. They may crack due to the pressure that builds up during cooking. To avoid this, the skin or shell must be punctured with a fork or knife. This process must be applied to potato, chicken liver, egg yolk, sausage and some fruits.

Mixing and turning the food during cooking

Mixing and turning the food is important in terms of cooking all parts evenly.

Different cooking times

Always start by trying the minimum cooking time and check whether the food is cooked or not. Cooking times in this user manual are approximate values. Cooking times may vary depending on the sizes and shapes of the foods and vessels.

Resting time

Always keep the food resting for some time after taking it from the microwave oven. Resting food for some time after defrosting, cooking and reheating will always give better results. Because the heat of the food will dissipate well. In microwave ovens, foods continue to cook for some more time even after the microwave oven is switched off. Cooking continues not because of the microwave oven but the energy inside the food. The resting time may change depending on the meal. In some cases, this duration is as short as it takes you to take the meal from the microwave oven and transfer it to the service plate. This time may take up to 10 minutes and depends on the type and size of the food.





Grill

Turn the knob clockwise to  programme. This programme allows you to grill thin meat slices, steaks, shish, kebabs, sausages and chicken pieces.

4 Operating your product

Combination Mode

This programme combines both microwave power and grill power of the appliance. Following 3 combination options can be selected with this programme individually. These combinations are particularly suitable for some dishes, some cooking processes and for keeping some foods at the desired crispiness.

Programme	Microwave power level	Grill power	Suitable for
	%0	%100	Grill
	Medium-Low (%30)	High (%70)	Fish, potato, cereal
	Medium (%49)	Medium (%51)	Pudding, omelet, baked potato
	Medium-High (%67)	Low (%33)	Poultry

Operating your oven

1. Always plug your oven into grounded sockets.
2. Open the front door.

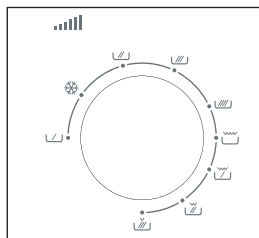

3. Place the meal or meal tray on the rotary tray in the oven.

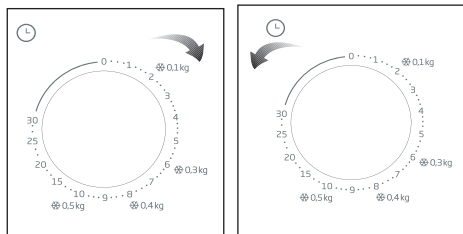

















4. Turn the time setting button in clockwise to set the desired time. First pass the desired time a little bit to make the time setting correctly. Then go back to the desired time.

5. Close the front door securely. Your oven's light will turn on and it will start. Oven will not start if the door is not closed securely.
6. Open the door from time to time to mix or check the meal (this may disturb the cooking process). Cooking process and time setting will stop when you open the front door and will resume when the front door is closed again.
7. You can stop the oven by opening the front door during cooking. Do not forget to set the time to (0) position if you do not want to continue cooking.
8. Buzzer will be activated at the end of the set cooking time. Oven light turns off and cooking ends automatically.

4 Operating your product

Cooking table





















Because of microwave cooking feature keep food waiting for some time after cooking is over. This duration is 5-10 minutes for food meats and 2-3 minutes for vegetables.

Food	Power Level	Cooking Time
Meats		
Minced beef	()	3-5 minutes for ~ 500 g
Meatball	()	9-12 minutes for ~ 500 g
Hamburger	()	4-5 minutes for ~ 500 g
Steaks (3 pieces of 0,5 cm thick)	()	1.5-2.5 minutes
Lamb roast, shank or shoulder	() - ()	8-10 minutes for ~ 500 g
Veal, roasted arm	() - ()	9-10 minutes for ~ 500 g
Lamb/veal cubes (3-4 pieces)	()	~ 6-8 minutes
Poultry		
Chicken pieces (1 breast)	()	2-3.5 minutes
Chicken pieces (1 drumstick)	()	1.5-2.5 minutes
Whole chicken	()	9-10 minutes for ~ 500 g
Casserole (for 1 person)	()	1.5-3.5 minutes
Turkey breast	()	8-9 minutes for ~ 500 g
Fish and seafood		
Fillet / sliced (170-230 g)	()	1.5-2.5 minutes
Whole fish	()	7-9 minutes for ~ 500 g

- Cooking times in table are provided for information purposes only. You can increase or decrease the cooking time according to your palate.
- The values stated have been obtained in laboratory testing. For personal preferences the cooking time can be changed.

4 Operating your product

Cooking table

Food	Power Level	Cooking Time
Egg and cheese		
Fried egg	()	1-2 minutes per egg
Scrambled eggs	()	45/-90 sec. to melt the butter and then 1-2 minutes per egg
Dessert with egg (caramel custard) 20 x 20 cm	()	15-19 minutes
Vegetables		
Vegetables (1 person)	()	1.5-3 minutes
Green beans	()	~ 500 g 8-12 minutes
Cabbage (freshly chopped)	()	6-8 minutes for ~ 500 g
Carrot (freshly chopped)	()	3-6 minutes for ~ 200 g
Corn (fresh 2 pieces)	()	5-9 minutes
Mushroom (freshly chopped)	()	2-3 minutes for ~ 230 g
Potatoes (4 pieces, 170-230 g each)	()	10-15 minutes
Spinach (fresh, leaves)	()	5-8 minutes for ~ 500 g
Grains		
1/2 fast cooking oatmeal (water: 1 cup)	()	1-2 minute(s)
1/2 long cooking oatmeal (water: 1 cup)	()	2-4 minutes
1/2 corn puree (water: 2 cups)	()	2-3 minutes
Cakes		
Carrot cake	()	9-12 minutes
Plain or chocolate cake (in round vessel)	()	5-6 minutes
Round cake	()	5-5.5 minutes
Small cake in mould	()	2-2.5 minutes
Cookies (foursquare vessel)	()	3-6 minutes
Soup/beverage		
for 1 person	()	2-3 minutes

4 Operating your product

Defrosting

Defrosting food in a short time is one of the biggest advantages of the microwave oven. First remove the metal fastening wires of the frozen food bags and replace them with thread or rubber. Open the packaging made of materials such as cardboard before placing them into the oven. Cut or pierce the plastic bags or packages. If the food is in foil packaging, remove the foil and place the food in a suitable vessel. (If the frozen food has skin, remove the skin.) Flex the plastic bag on the food to provide even defrosting.

(While defrosting large pieces of meat, do not forget to cover the thin parts of the poultry in order to slow down heating. Otherwise, outer parts will dry out or even start being cooked.)

Always keep the defrost time short. If inside of the defrosted food is still frozen, place it back to the microwave oven to defrost it some more.

Duration of the defrosting time depends on food's level of freezing. If possible, turn or take apart the frozen food during defrosting.

Defrosting table contains approximate values to help you.













Defrosting table

Please read information about defrosting.

Food	Recommended time	Kg
Sausage	5-6 minutes	500 g
Minced meat	8-10 minutes	500 g
Kidney	8-12 minutes	1 kg
Liver	6-7 minutes	500 g
Lamb chops rib	15-20 minutes	1.5-2 kg
Top round	20-25 minutes	1.5-2 kg
Meat cubes	7-8 minutes	500 g
Fillet of beef	10-12 minutes	1 kg
Veal cutlet	9-10 minutes	500 g
Minced meat (veal)	4-5 minutes	500 g
Veal steak	6-8 minutes	500 g
Lamb roast leg or shoulder	28-30 minutes	2-2.3 kg
Whole chicken	26-30 minutes	1.2-1.5 kg
Chicken pieces	14-17 minutes	1.2-1.5 kg
Chicken breast (with bones)	10-14 minutes	1-1.5 kg
Chicken pieces (drumstick)	9-10 minutes	500 g
Chicken pieces (wing)	8-12 minutes	700 g
Turkey pieces	14-16 minutes	1-1.5 kg
Turkey breast (with bones)	18-22 minutes	2-2.5 kg

4 Operating your product

Heating table

	Food	Power Level	Cooking Time
1 portion	1 plate	()	2-3 minutes
1-2 portion(s)	Main course with sauce	()	7-9 minutes
2-4 portions	Thick meat slices such as hamburger, rolled meatball slices	()	3-5 minutes
2-3 portions	Thin meat slices such as steak fillet	()	2-3 minutes
2-3	Chicken pieces	()	3-4 minutes
2 portions	Casserole	()	9-12 minutes
2 portions	Vegetables	()	3-4 minutes
1-2	Corn	()	3-4 minutes
2-3	Cookies	()	45-60 seconds
1	Whole pie	()	3-7 minutes
1-2 slices	Pie	()	1-2 minute(s)
3-4	Sausage	()	1-2 minute(s)
4	Hot dog	()	1-2 minute(s)

Heating

You can reheat the remaining or cooked food quickly and effectively without losing their freshness and taste.

During heating, cover the food with a lid or cling film suitable for microwave cooking in order to allow the food to remain moist. Covering the food will protect the heat and speed up the heating process. It will also avoid splashes. Wrap the sandwiches and cookies in paper towels in order to allow moisture absorption and prevent them from getting doughy.

Generally spread the food into a shallow vessel. It may be necessary to mix and turn the food from time to time to heat it.

5 Cleaning and Care

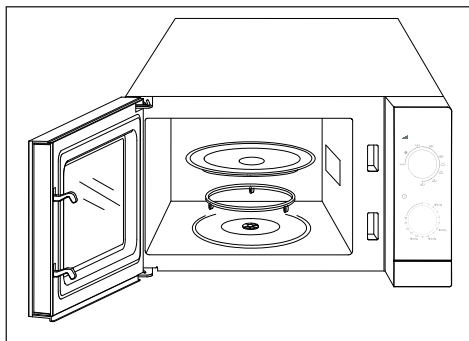

- Unplug your oven before cleaning.
- Do not use abrasive cleaners, steel wools, rough washing clothes or abrasive chemicals such as sulphur or chloride on or at any parts of your microwave oven.

Outer surfaces

- To clean the outer surfaces of the oven, first wipe them with a soft cloth soaked in warm soapy water. Then wipe them dry again with a soft cloth.
- Do not allow water ingress into the ventilation openings in order to avoid damage to the live parts inside the oven. Clean the control panel of your microwave oven only with a damp and soft cloth.
- Do not use cleaning sprays or more soap and water. They may cause problems in control mechanism.
- Failure to maintain the oven in a clean condition could lead to deterioration of the surface that could adversely affect the life of the appliance and possibly result in a hazardous situation.
- Cleaning the door seals and adjacent parts: Use hot soapy water. Clean with a dish cloth, do not scour. Do not use a metal or glass scraper for cleaning.

Inner surfaces

To clean the inner surfaces of the oven:

- To soften the dried stains, place a glass of water inside the microwave oven and heat for 2-3 minutes. The steam created will soften dried stains making cleaning easier.
- Clean the inner surfaces and ceiling with a soft and soapy cloth. And dry again with a soft cloth.
- To remove the odours inside the oven, boil a mixture of water and a few table spoons of lemon juice for a couple of minutes inside the oven.
- To clean the inner base of the oven, remove the roller glass tray and roller support. Wash the roller glass tray and roller support in soapy water. Then, rinse and dry them.
- Before starting the oven, install the roller support and glass tray securely.
- When cleaning the inner surfaces of the oven door, use a non-abrasive soft sponge or cloth.

For transportation;

- Unplug the appliance.
- Pack the glass tray in a way to prevent them from breaking and moving inside the oven. Transport it separately if needed.
- Tape the front door to the body.
- Prevent impact against the front glass, door and panel.
- Transport the product in normal position. Do not lean it aside or back.

6 Guarantee

Product Guarantee

12 months breakdown and repair guarantee

Guarantor: **Beko plc, 1 Greenhill Crescent, Watford, Hertfordshire. WD18 8UF**

The guarantee does not in any way diminish your statutory or legal rights.

Your **microwave** has the benefit of our manufacturer's guarantee which covers the product for 12 months from the date of original purchase.

This gives you reassurance that if within that time, your **microwave** is proven to be defective because of either workmanship or materials, we will at our discretion either repair or replace your **microwave**.

The **microwave** must be correctly installed, located and operated in accordance with the instructions contained in the user manual. The guarantor disclaims any liability for accidental or consequential damage.

The Guarantee is subject to the following conditions:

- Documentary proof of the original purchase date is provided.
- The microwave has been installed and operated correctly and in accordance with our operating and maintenance instructions.
- The microwave is used only on the electricity supply on the rating plate.
- The microwave has only been used for normal domestic purposes.
- The microwave has not been altered, serviced, dismantled or otherwise interfered with by any person.
- The microwave is used in the United Kingdom or Republic of Ireland.
- Any parts removed during repair work or any product that has been replaced becomes our property.
- The guarantee is not transferrable if the product is resold.

The Guarantee does not cover:

- Transit, installation or delivery damage.
- Accidental damage.
- Misuse or abuse.
- Replacement of any consumable item or accessories. These include but are not limited to: plugs, cables, light bulbs, knobs, filters and flaps.
- Repairs or replacements required as a result of unauthorised repairs or inexpert installation that fails to meet the requirements contained in the user guide or instruction book.
- Repairs to products used in commercial or non-residential household premises.

How to obtain after sales service, help or general advice

Please keep your purchase receipt or other proof of purchase in a safe place as you will need to show us this document if your product requires attention within the guarantee period.

Please also record your product details below, which will allow you to access our services more quickly and help us identify your product. The model number is printed on the front of the user guide and the serial and model number is shown on your products rating plate.

Model number	Serial number	Purchased from	Date of purchase

Please call our UK based Customer Service department if you need help or advice from us:

United Kingdom and Northern Ireland: **0333 207 9710**
Republic of Ireland: **01 862 3411**
You can also contact us through our website: **www.beko.co.uk**



Free Manuals Download Website

<http://myh66.com>

<http://usermanuals.us>

<http://www.somanuals.com>

<http://www.4manuals.cc>

<http://www.manual-lib.com>

<http://www.404manual.com>

<http://www.luxmanual.com>

<http://aubethermostatmanual.com>

Golf course search by state

<http://golfingnear.com>

Email search by domain

<http://emailbydomain.com>

Auto manuals search

<http://auto.somanuals.com>

TV manuals search

<http://tv.somanuals.com>