

Steam Station

User Manual



SGA7126P
SGA7124B

EN

01M-8834973200-4116-01
01M-8834593200-4116-01

beko

Please read this manual first!

Dear Customer,

Thank you for selecting a Beko product. We hope that you get the best results from your product which has been manufactured with high quality and state-of-the-art technology. Therefore, please read this user manual and all other accompanying documents carefully before using the product and keep it as a reference for future use. If you handover the product to someone else, give the user manual as well. Follow all warnings and information in the user manual.

Meanings of the symbols

Following symbols are used in the various sections of this manual:

	Important information and useful hints about usage.
--	---

	WARNING: Warnings against dangerous situations concerning the security of life and property.
--	---



This product has been manufactured in environmental friendly modern plants without giving any harm to the nature.



This product does not contain PCB's.

CONTENTS

1 Important safety and environmental instructions 4-6

- 1.1 General safety 4
- 1.2 Compliance with WEEE Directive and Disposing of the Waste Product 5
- 1.3 Compliance with RoHS Directive. 5
- 1.4 Package information 5
- 1.5 Plug Wiring 6

2 Your steam station 7-8

- 2.1 Overview7
- 2.2 Technical data.....7

3 Operation 9-11

- 3.1 Intended use 9
- 3.2 Initial use..... 9
- 3.3 Ironing tips 9
- 3.4 Temperature setting..... 9
- 3.5 Dry ironing 10
- 3.6 Filling the water reservoir..... 10
- 3.7 Steam ironing 11
- 3.8 Vertical steam..... 12
- 3.9 Automatic Shutdown (Auto-Off) 12

4 Cleaning and care 12-14

- 4.1 Cleaning 12
- 4.2 Replacing the lime collecting cartridge ... 13
- 4.3 Lime removing feature (Self-Clean) 13
- 4.4 Transport lock..... 14
- 4.5 Storage..... 14
- 4.6 Moving and transportation 14

5 Guarantee 15

1 Important safety and environmental instructions

This section contains safety instructions that will help protect from risk of personal injury or material damage.

Failure to follow these instructions invalidates the granted warranty.

1.1 General safety

- This appliance complies with the international safety standards.
- This appliance can be used by children aged from 8 years and above and persons with reduced physical, sensory, or mental capabilities or lack of experience and knowledge if they have been given supervision or instruction concerning use of the appliance in a safe way and understand the hazards involved.
- Do not leave the appliance unattended while it is plugged in.
- Unplug the appliance before filling the water reservoir with water.
- Do not open the water refill hole during usage.
- Operate and store the appliance on a stable surface.
- When the appliance is placed on its base plate, ensure that the surface beneath the plate is level.
- If the appliance is dropped or leaks water or has other failures, contact an authorised service center. Do not use the appliance until it is repaired.
- When the appliance is in use or left to cool down, keep the appliance and power cable out of reach of children under 8 years old.
- The appliance is not suitable for outdoor use.
- Only use the original parts or parts recommended by the manufacturer.
- Use the appliance only when it is connected to the steam iron station.
- Do not dismantle the appliance.
- Your mains power supply should comply with the information supplied on the rating plate of the appliance.

1 Important safety and environmental instructions

- The mains plug is fitted with a 13A fuse. Ensure the same rating fused is used should it need replacement.
- Use the appliance with a grounded outlet.
- Do not use the appliance with an extension cable.
- Do not pull the power cable when unplugging the appliance.
- If the power cable is damaged, it should be repaired or replaced by the dealer, service centre, or a specialised and authorised service centre with similar qualifications.
- Unplug the appliance before cleaning.
- Do not wrap the cable around the appliance.
- Do not touch the appliance or its plug with damp or wet hands when the appliance is plugged in.
- The soleplate and the steam station surface may get overheated. Contact with hot surfaces may cause burns.
- Do not use the appliance in or near the areas where combustible or inflammable places and materials exist.
- If you keep the packaging materials, store them out of the reach of children.

1.2 Compliance with WEEE Directive and Disposing of the Waste Product



This product complies with EU WEEE Directive (2012/19/EU). This product bears a classification symbol for waste electrical and electronic equipment (WEEE). This product has been manufactured with high quality parts and materials which can be reused and are suitable for recycling. Do not dispose of the waste product with normal domestic and other wastes at the end of its service life. Take it to the collection center for the recycling of electrical and electronic equipment. Please consult your local authorities to learn about these collection centers.

1.3 Compliance with RoHS Directive

The product you have purchased complies with EU RoHS Directive (2011/65/EU). It does not contain harmful and prohibited materials specified in the Directive.

1.4 Package information



Packaging materials of the product are manufactured from recyclable materials in accordance with our National Environment Regulations. Do not dispose of the packaging materials together with the domestic or other wastes. Take them to the packaging material collection points designated by the local authorities.

1 Important safety and environmental instructions

1.5 Plug Wiring

The moulded plug on this appliance incorporates a 13 A fuse. Should the fuse need to be replaced an ASTA approved BS1362 fuse of the same rating must be used. Do not forget to refit the fuse cover. In the event of losing the fuse cover, the plug must not be used until a replacement fuse cover has been fitted. Colour of the replacement fuse cover must be the same colour as that visible on the pin face of the plug. Fuse covers are available from any good electrical store.

• Fiting a different plug

As the colours of the wires in the mains lead of this appliance may not correspond with the coloured markings identifying the terminals on your plug, proceed as follows:

- Brown cable = L (Live)
- Blue cable = N (Neutral)
- Green/yellow cable must be connected to ground (E) \equiv line

With the alternative plugs a 13 A fuse must be fitted either in the plug or adaptore or in the main fuse box. If in doubt contact a qualified electrician.

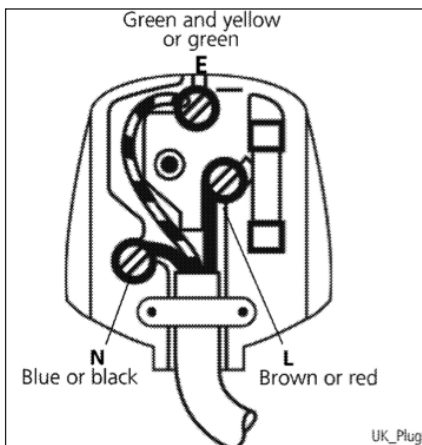

2 Your steam station

2.1 Overview



1. Lime collecting cartridge
2. Steam station
3. Cable winding slot with bracket
4. Water reservoir removal latch
5. Removable water reservoir
6. Water refill lid
7. Steam station surface
8. Soleplate
9. Transport lock
10. Control panel
11. On/off and control button
12. Steam trigger

2.2 Technical data

Power supply : 220-240V~, 50/60 Hz

Power consumption : 2190-2600 W







Pump pressure : 6 bar

Flash steam amount: Up to 110 g/min.

Technical and design modification rights are reserved.

The values which are declared in the markings affixed on your product or the other printed documents supplied with it represent the values which have been obtained in the laboratories pursuant to the pertinent standards. These values may vary according to the usage of the appliance and ambient conditions.

2 Your steam station

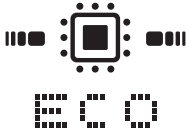
Control panel	Symbols	Descriptions
		Water reservoir is empty
		Steam level
		Lime collecting cartridge should be replaced
		Temperature settings
		Automatic shutdown
		Self-cleaning
		Smart - ECO mode

3 Operation

3.1 Intended use

This appliance is intended only for household use and ironing; it is not suitable for professional use.

3.2 Initial use

1. Remove the package on the lime collecting cartridge (1) which is placed separately in the box.
2. Soak the lime collecting cartridge (1) in the water for 1 minute in order to enhance its performance.

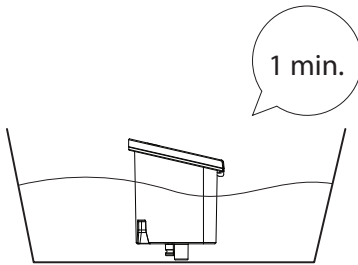

3. Then push the cartridge (1) in its slot.

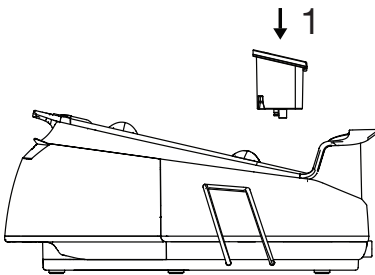

4. Prior to initial use, fill the water reservoir (5) with water (see 3.6) and evaporate the water twice in order to remove the manufacturing residues.



A light odour may arise during the initial use. This condition will return to normal after several uses.

3.3 Ironing tips

- The appliance gets heated in a short time; iron fabrics such as synthetic, silk etc. using low temperature settings.
- Iron fabrics that may luster (silk etc.) by turning them inside out or using the appliance in Smart-ECO mode.
- Use very little pressure when ironing fabrics such as velvet and iron them towards one single direction.
- Steam usage may cause stains on coloured silk fabrics. Do not use steam.
- 100% pure woolen clothes can be ironed by using steam.
- Ironing woolen clothes may cause luster. Iron by turning them inside out.



WARNING: Do not allow the iron to contact with metal parts such as zippers and rivets. This may damage the soleplate of the iron.

3.4 Temperature setting

Set the appropriate temperature for the fabric to be ironed by using the control button (11).

Fabric Type	Temperature Setting	Steam Setting
Synthetic	•	Without steam
Silk	••	With Steam ☞
Cotton	•••	With Steam ☞
Linen - Jean	Max	With Steam ☞

3 Operation



Smart-ECO mode of your appliance is suitable for all types of fabrics that can be ironed. You can iron securely. You can do steam ironing by using the steam trigger (12) in this mode.



WARNING: You can do steam ironing at all temperature levels except for "•". Press the steam trigger (12) for steam ironing.



WARNING: Take the ironing instructions specified on the label of the fabric into consideration for ironing.

3.5 Dry ironing

Your appliance will only produce steam when the steam trigger button (12) is pressed.

In order to use dry ironing, do not press the steam trigger (12).

3.6 Filling the water reservoir



WARNING: When filling the water reservoir with water without removing the iron from the steam station, ensure that the appliance is unplugged.

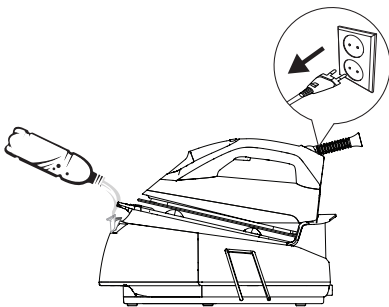

1. Press the on/off button (11), switch off and unplug the appliance.

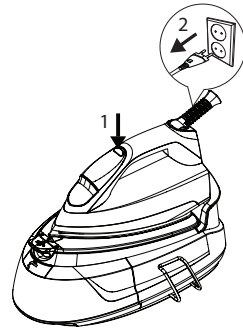

2. Remove the water reservoir (5) by pressing the water reservoir removal latch placed under the water reservoir.

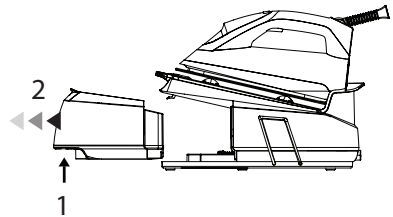

3. Open the water refill lid (6) and fill water up to the MAX level.

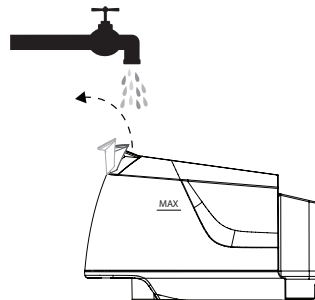

Your appliance is suitable for using with tap water. If your tap water is excessively hard, we recommend you to use a mixture of tap water and produce water.

3 Operation

- Place the water reservoir (5) in its place.
 - You will hear a click when the water reservoir fits into its place.

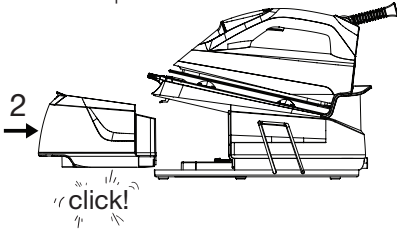

3.7 Steam ironing

- Fill the water reservoir (5) with water (see 3.6).
- Place the appliance on the steam station surface (7).
- Plug in the appliance.

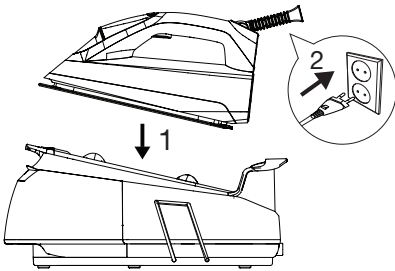

- You will hear a beeping sound when the appliance starts to operate.
 - Control panel (10) flashes once and then goes off.
- Press the on/off button (11).



Operation of the pump may make some noise during the water drawing process; this is normal.



The appliance starts in Smart-ECO mode in the initial use. This level offers safe temperature and steam amount for all the fabrics that can be ironed.

- You can set temperature levels other than the Smart - ECO mode by using the control button (11) (see 3.4).



WARNING: Your selection should be suited for the fabric to be ironed.

- When the symbol of the selected setting flashes consistently on the display, your appliance is ready to iron.



WARNING: If the symbol on the display blinks, this means that the soleplate temperature setting is not at the desired level.



You can do steam ironing by using the steam trigger (12) at all temperature levels except for “.”.

- When the appliance is ready for steam ironing, move the iron horizontally on the fabric to be ironed and press the steam trigger (12). Your iron will produce steam from its soleplate (8) as long as you hold the steam trigger pressed.

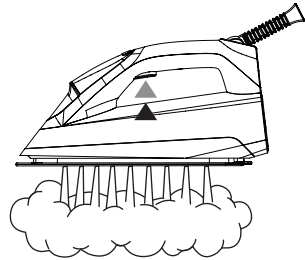

- When the ironing process is over, press the on/off button (11) for a few seconds.
 - The lights on the control panel will go off.
- Unplug the appliance and leave it to cool.

3 Operation

3.8 Vertical steam

You can also use the steam in upright position (see 3.7). You can iron your curtains and hanged garments thanks to the vertical steam feature. Keep the appliance 15-30 cm away from the garment and curtains.

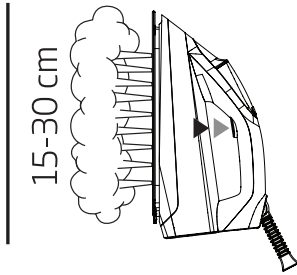

WARNING: Never direct the steam to people or pets.

3.9 Automatic Shutdown (Auto-Off)

If you do not move the appliance or press any of its buttons for 10 minutes, it will be shut down automatically.

- If you move the appliance horizontally or press any of its buttons, it will start to operate.



It may take 60 seconds for the soleplate (8) to reach the previous temperature level.

4 Cleaning and care

4.1 Cleaning



WARNING: Do not soak the steam station (2) in water or other liquids. Never put vinegar, descaling agent, laundry starch, perfume or other auxiliary products that help ironing into the appliance.



WARNING: Do not use gasoline, solvent and abrasive cleaning agents or hard brush to clean the appliance.



WARNING: Do not wash your appliance under running water or do not soak it in water or other liquids.



WARNING: Do not use abrasive cleaning agents to clean the soleplate (8).

1. Switch off and unplug the appliance before cleaning.
2. Wait for the appliance to cool completely.
3. Use a slightly damp cloth to clean the exterior of the appliance. Then wait for it to dry completely.
4. Wipe the sediments and residues on the soleplate (8) with a slightly damp cloth or with a soft, nonabrasive liquid cleaner if necessary.

1

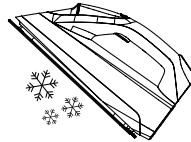

2



4 Cleaning and care

4.2 Replacing the lime collecting cartridge



WARNING: Do not use any descaling agents! They may damage the appliance.



WARNING: Do not purchase cartridge from places other than the dealers and service centers. If you do this, the cartridge will not fit into the cartridge slot and will not operate. This causes a breakdown in your appliance. Faults arising from using wrong cartridge are not covered under warranty.

1. “” symbol will flash on the control panel (10) when the cartridge needs to be replaced.



The cartridge must be replaced after consuming about 30 liters of water.

2. Soak the new cartridge in water for 1 minute in order to enhance its performance.
3. Before removing the old cartridge from its slot, make sure that the sections surrounding the cartridge is cold.
4. Slightly press and release to replace the cartridge.

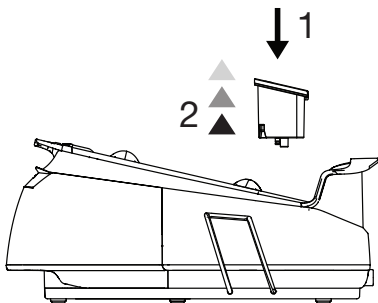



5. Remove the new cartridge from its package, soak it in the water for 1 minute and push it in its slot.

4.3 Lime removing feature (Self-Clean)

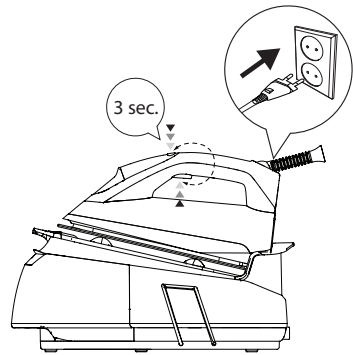
1. When the “” lime removing (self-clean) symbol flashes on the control panel, (10) this means that it is time for lime removing.
2. Fill the water reservoir (5) (see 3.6).
3. Plug in the appliance.
4. Hold and press the control button (11) and steam trigger (12) together for 3 seconds.



The “” symbol will constantly blink on the control panel (10) when the appliance switches to lime removing (self-clean) mode.

5. Then press the control button (11) once.
 - “” symbol will flash on the control panel (10) permanently.
6. Keep the appliance over the sink horizontally and shake it while pressing and holding the steam trigger (12).
7. When the lime removing (self-clean) is over, the appliance automatically returns to the mode before the lime removing process.

4 Cleaning and care

4.4 Transport lock

1. Turn the transport lock (9) in order to be able to move/transport your appliance easily and store it securely.

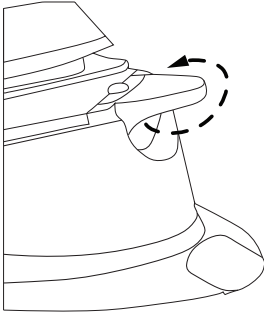

2. Turn the lock again to unlock the transport lock.

4.5 Storage

- If you do not intend to use the appliance for a long time, store it carefully.
- Unplug the appliance and wait for it to cool completely before storing it.
- Discharge the water in the water reservoir (5).
- Wrap the cable around the cable winding slot with bracket (3) and fix it in order to store the steam station.

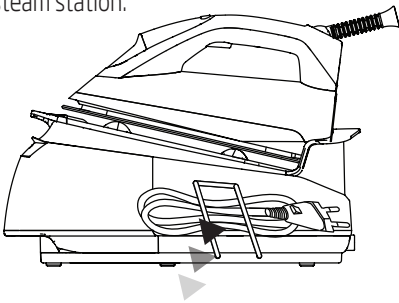

- Store it in a cool and dry place.
- Keep the appliance out of the reach of children.

4.6 Moving and transportation

- Carry the appliance in its original packaging during moving and transportation. The packaging of the appliance protects it against physical damages.
- Do not place heavy loads on the appliance or the packaging. The appliance may be damaged.
- Dropping the appliance may render it non-operational or cause permanent damage.

5 Guarantee

Product Guarantee

12 months breakdown and repair guarantee

Guarantor: **Beko plc, 1 Greenhill Crescent, Watford, Hertfordshire. WD18 8UF**

The guarantee does not in any way diminish your statutory or legal rights.

Your **appliance** has the benefit of our manufacturer's guarantee which covers the product for 12 months from the date of original purchase.

This gives you reassurance that if within that time, your **appliance** is proven to be defective because of either workmanship or materials, we will at our discretion either repair or replace your **appliance**.

The **appliance** must be correctly installed, located and operated in accordance with the instructions contained in the user manual. The guarantor disclaims any liability for accidental or consequential damage.

The Guarantee is subject to the following conditions:

- Documentary proof of the original purchase date is provided.
- The appliance has been installed and operated correctly and in accordance with our operating and maintenance instructions.
- The appliance is used only on the electricity supply on the rating plate.
- The appliance has only been used for normal domestic purposes.
- The appliance has not been altered, serviced, dismantled or otherwise interfered with by any person.
- The appliance is used in the United Kingdom or Republic of Ireland.
- Any parts removed during repair work or any product that has been replaced becomes our property.
- The guarantee is not transferrable if the product is resold.

The Guarantee does not cover:

- Transit, installation or delivery damage.
- Accidental damage.
- Misuse or abuse.
- Replacement of any consumable item or accessories. These include but are not limited to: plugs, cables, light bulbs, knobs, filters and flaps.
- Repairs or replacements required as a result of unauthorised repairs or inexperienced installation that fails to meet the requirements contained in the user guide or instruction book.
- Repairs to products used in commercial or non-residential household premises.

How to obtain after sales service, help or general advice

Please keep your purchase receipt or other proof of purchase in a safe place as you will need to show us this document if your product requires attention within the guarantee period.

Please also record your product details below, which will allow you to access our services more quickly and help us identify your product. The model number is printed on the front of the user guide and the serial and model number is shown on your products rating plate.

Model number	Serial number	Purchased from	Date of purchase

Please call our UK based Customer Service department if you need help or advice from us:

United Kingdom and Northern Ireland: **0845 600 4911 / 0345 600 4911**
Republic of Ireland: **01 862 3411**
You can also contact us through our website: **www.beko.co.uk**



Free Manuals Download Website

<http://myh66.com>

<http://usermanuals.us>

<http://www.somanuals.com>

<http://www.4manuals.cc>

<http://www.manual-lib.com>

<http://www.404manual.com>

<http://www.luxmanual.com>

<http://aubethermostatmanual.com>

Golf course search by state

<http://golfingnear.com>

Email search by domain

<http://emailbydomain.com>

Auto manuals search

<http://auto.somanuals.com>

TV manuals search

<http://tv.somanuals.com>