

Vacuum Blender

User Manual



TBV8106BX

EN	DE	TR	FR	ES
RO	PL	IT	AR	

01M-8813893200-2518-01

beko

Please read this manual first!

Dear Valued Customer,

Thank you for selecting this Beko appliance. We hope that you get the best results from your appliance which has been manufactured with high quality and state-of-the-art technology. For this reason, please read this user manual and all other provided documents carefully before using the appliance and keep it as a reference for future use. If you hand over the appliance to someone else, give the user manual as well. Follow the instructions by paying attention to all the information and warnings in the user manual.

Meanings of the symbols

Following symbols are used in various sections of this manual:



Important information and useful hints about usage.



WARNING: Warnings for dangerous situations concerning the safety of life and property.



Suitable for contact with food.



Do not immerse the appliance, the power cable, or the power plug in water or any other liquid.



This product has been produced in environmentally-friendly, state-of-the-art facilities.

Conforms to the WEEE Directive.



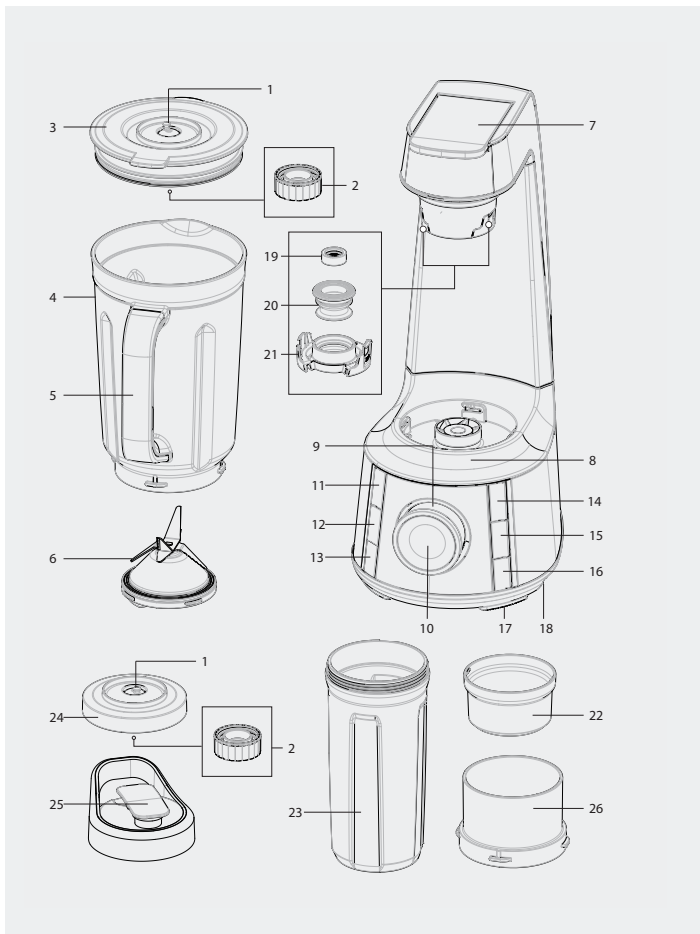

The values which are declared in the markings affixed on your product or the other printed documents supplied with it represent the values which were obtained in the laboratories pursuant to the pertinent standards. These values may vary according to the usage of the appliance and ambient conditions.

1. Vacuum valve
2. Backflow prevention cap
3. Lid
4. Tritan Jug
5. Jug handle
6. Blade unit
7. Lever
8. Motor housing
9. On-Off / Speed adjustment knob
10. Pulse button
11. Smoothie button
12. Ice button
13. Sauce button
14. Vacuum button
15. Vacuum+Blend button
16. Auto-Clean button
17. Non-slip feet
18. Cable storage compartment
19. Filter
20. Vacuum seal
21. Suction head cover
22. Measuring cup / Anti-insect cap
23. Portable bottle
24. Vacuum lid
25. Portable bottle Lid
26. Bottle stand

Technical data

Voltage: 220-240V ~ 50-60 Hz

Power consumption: 1000 W

Rights to make technical and design changes are reserved.

CONTENTS

ENGLISH	06-26
DEUTSCH	27-51
TÜRKÇE	51-70
FRANÇAIS	71-94
ESPAÑOL	95-118
ROMÂNĂ	119-142
POLSKI	143-169
ITALIANO	170-195
04-20	عربي

1 Important safety and environmental instructions

This section contains safety instructions that will help protect from risk of personal injury or material damage.

Failure to follow these instructions voids any grant-ed warranty.

1.1 General safety

- Read all instructions.
- This appliance may be used by people whose physical, perceptive or mental skills are impaired or who are inexperienced or not knowledgeable about the appliance as long as they are supervised or informed and made aware of the safe use of the appliance and the encountered dangers. Children should not play with the appliance.
- Do not operate any appliance with a damaged cord or plug or after the appliance malfunctions, or is dropped or damaged in any manner.

1 Important safety and environmental instructions

Contact the manufacturer at their customer service telephone number for information on examination, repair, or adjustment.

- The use of attachments, including canning jars, not recommended by the manufacturer may cause a risk of injury to persons.
- Do not attempt to dismantle the appliance.
- Do not operate or place any part of this appliance or its parts on or near hot surfaces.
- Do not use the device for hot food.
- Your mains power supply should comply with the information supplied on the rating plate of the appliance.
- Do not use the appliance with an extension cable.
- Do not touch the plug of the appliance with damp or wet hands.

1 Important safety and environmental instructions

- Unplug from outlet when not in use, before putting on or taking off parts, and before cleaning.
- Hold the blending shaft of the appliance carefully during transportation and cleaning.
- Never touch blades while using the appliance. There is the possibility of injury due to incorrect usage.
- Avoid contacting moving parts.
- Do not use outdoors.
- Do not let cord hang over edge of table or counter.
- Keep hands and utensils out of jug while blending to reduce the risk of severe injury to persons or damage to the blender. A scraper may be used but must be used only when the blender is not running.
- Blades are sharp. Handle carefully.
- Always operate blender with cover in place.

1 Important safety and environmental instructions

- Do not blend hot liquids.
- To reduce the risk of electric shock, the plug should only be connected to a proper outlet. If the plug does not fit fully in the outlet, contact a qualified electrician. Do not modify the plug in any way.
- After cleaning, dry the appliance and all parts before connecting it to mains supply and before attaching the parts.
- Do not immerse the appliance, the power cable, or the power plug in water or any other liquid.
- If you keep the packaging materials, store them out of the reach of children.
- Children shall not use the appliance. Keep the appliance out of the reach of children.
- Always disconnect the blender from the supply if it is left unattended and before assembling, disassembling.

1 Important safety and environmental instructions

- Switch off the appliance and disconnect from supply before changing accessories or approaching parts that move in use.
- CAUTION: In order to avoid a hazard due to inadvertent resetting of the thermal cut-out, this appliance must not be supplied through an external switching device, such as a timer, or connected to a circuit that is regularly switched on and off by the utility.
- SAVE THESE INSTRUCTIONS

1.2 Compliance with the WEEE Directive and Disposing of the Waste Product:

This product complies with EU WEEE Directive (2012/19/EU). This product bears a classification symbol for waste electrical and electronic equipment (WEEE).



This product has been manufactured with high quality parts and materials which can be reused and are suitable for recycling. Do not dispose of the waste product with normal domestic and other wastes at the end of its service life. Take it to the collection center for the recycling of electrical and electronic equipment. Please consult your local authorities to learn about these collection centers.

1 Important safety and environmental instructions

1.3 Compliance with RoHS Directive

The product you have purchased complies with EU RoHS Directive (2011/65/EU). It does not contain harmful and prohibited materials specified in the Directive.

1.4 Package information



Packaging materials of the product are manufactured from recyclable materials in accordance with our National Environment Regulations. Do not dispose of the packaging materials together with the domestic or other wastes. Take them to the packaging material collection points designated by the local authorities.

1.5 Plug Wiring

The moulded plug on this appliance incorporates a 13 A fuse. Should the fuse need to be replaced an ASTA approved BS1362 fuse of the same rating must be used. Do not forget to refit the fuse cover. In the event of losing the fuse cover, the plug must not to be used until a replacement fuse cover has been fitted. Colour of the replacement fuse cover must be the same colour as that visible on the pin face of the plug Fuse covers are available from any good electrical store.

- **Fiting a different plug**
- As the colours of the wires in the mains lead of this appliance may not correspond with the coloured markings identifying the terminals on your plug, proceed as follows:
- Brown cable = L (Live)
- Blue cable = N (Neutral)

1 Important safety and environmental instructions

- Green/yellow cable must be connected to ground (E) \equiv line
- With the alternative plugs a 13 A fuse must be fitted either in the plug or adaptor or in the main fuse box. If in doubt contact a qualified electrician.

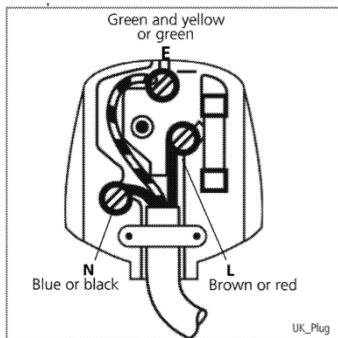

2 Use

2.1 Intended Use

This appliance is intended only for household use; it is not suitable for professional use. It is designed to chop small amounts of solid foods (onions, potatoes, carrots, etc.) and fruit (strawberries, bananas, etc.).

2.2 Initial Use

Clean the parts of the appliance prior to initial use (see 3.1).

2.3 Removing the Chopping Blade



WARNING: Do not touch the blades with your bare hands.

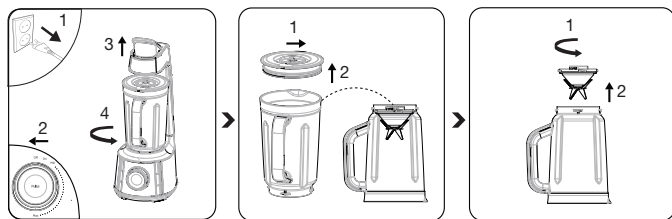

Unplug the appliance and move the speed adjustment knob (9) to "OFF" position. Pull up the lever (7) and unlock the jug (4) anti-clockwise according the "Open" arrow on the motor unit (8).

Open the vacuum valve by rotating it and remove the vacuum from (4) the valve. Remove the lid from the jug and turn the jug over (3, 4).

Remove chopping blade unit (6) by turning clockwise.

2 Use

2.4 Installing the Chopping Blade

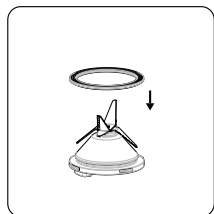

Put the silicone ring in its place on the chopping blade (6) and place the chopping blade under the jug (4).

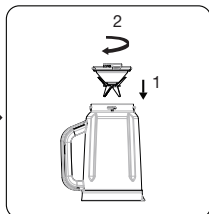

Place it back in the jug (4) by turning anti-clockwise.

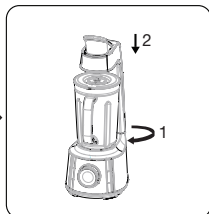

Place the jug onto the motor housing (8).

2.5 Operation



WARNING: Do not operate the appliance when empty.

i

- The maximum temperature of the liquid to be prepared inside the appliance must not exceed 40 C degrees.
- Put soft foods or liquids before adding hard foods or ice.
- Adding some water into the appliance will allow it run smoothly (e.g. 40ml water for 60gr solid food). Add the water before the ingredients.

2 Use

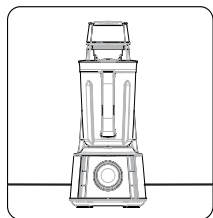

Place your appliance on a solid and flat surface.

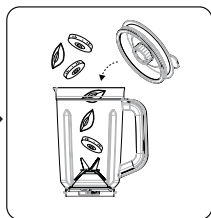

Put the ingredient you want to process into the jug (4) and place the lid (3) on it.

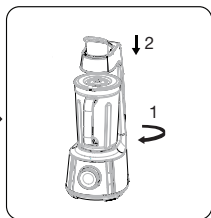

Place the jug onto the motor housing (8) so that the tab on it seats on the slots of the motor housing (8), turn it to the "Lock" position and secure.

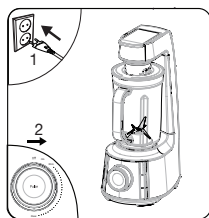

Plug in the appliance and move the speed adjustment knob (9) to "ON" position.

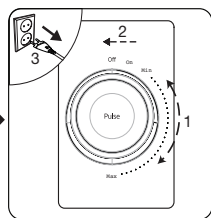

Process the ingredients at the desired speed using the speed adjustment knob (9). When the process is complete, move the speed adjustment knob (9) to "OFF" position and unplug the appliance.

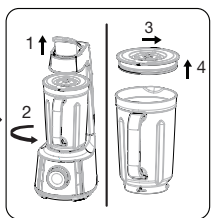

Remove the jug from the motor unit by rotating it counterclockwise (4, 8). Open the lid (3) and take out the food.

2 Use

WARNING:



- Gradually increase the speed of the appliance. Do not operate it at the highest speed suddenly. Otherwise the motor may overheat.
- Do not run the appliance continuously for more than 2 minutes. Let it cool for 5 minute before operating it again.
- Do not insert any foreign objects into the jug (4) when the appliance is in use.
- Do not remove ingredients from the jug (4) before chopping blade (6) has completely stopped.
- Do not use carbonated beverage, crop, frozen food, or sticky food (boiled bean, yam, etc.).



After each use, the jug lid (3, 22) must be washed and remove moisture for next use. Dry it well before use.

2 Use

2.6 Automatic programs with the jug

The appliance is equipped with six automatic programs that you can use: Smoothie (11), Ice (12), Sauce (13), Vacuum (14), Vacuum+Blend (15), and Auto Clean (16).

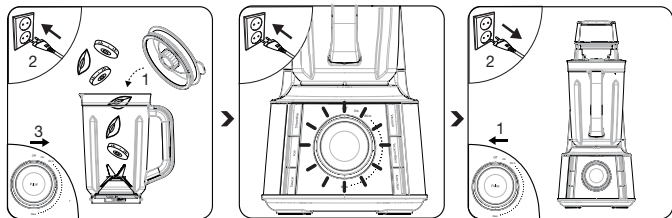

Put the ingredients in the jug (4) and close the lid (3). Plug in the appliance and move the speed adjustment knob (9) to "ON" position.

Select the desired automatic program. The program that you have chosen will turn on and start functioning at various speed settings. If you choose the vacuum program, it will start vacuuming and will stop after 1 minute. If you choose Vacuum+Mixing program, the program will keep on functioning at various speeds after the vacuum has stopped and the program will stop 2 minutes afterwards. The light will flash.

When the process is complete, move the speed adjustment knob (9) to "OFF" position and unplug the appliance.

2 Use

2.7 "Pulse" position

For mixing with high speed short pulses, turn speed adjustment knob (9) to "ON" position and press "pulse" (10). The appliance will stop when you release the button.

2.8 Vacuum program with the bottle

You can use Vacuum program with the storage bottle by assembled it and the bottle stand accessory onto the appliance.

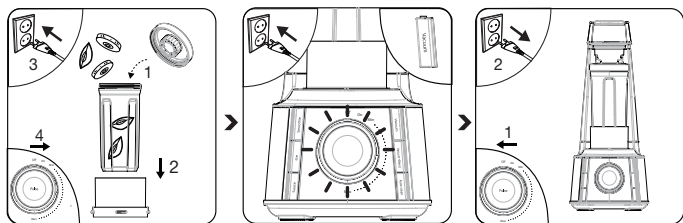

Put the ingredients in the portable bottle (23) and close the vacuum lid (24). Place it into the bottle stand (26) and lock it by turning clockwise on the motor unit (8). Plug in the appliance and move the speed adjustment knob (9) to "ON" position.

Select the Vacuum program. The pump will turn on and stop until the sensor is automatic off or about 1 minute later. The light will blink.

When the process is complete, move the speed adjustment knob (9) to "OFF" position and unplug the appliance.

You can keep blended juice or other foods in vacuum using the storage bottle to keep them fresh for a long time.

2 Use



- Vacuum delays oxidation but does not sterilize the contents. Keep them refrigerated and have them as soon as possible
- If you want to stop the appliance at any time during the operation, move the speed adjustment knob (9) to "OFF" position.



WARNING:

- When you store food in the smoothie bottle by means of vacuum storage, store such in a refrigerator. Do not store this in a freezer.
- When you store food in the smoothie bottle by means of vacuum storage, store such in a refrigerator. Do not store this in a freezer.
- Do not use any jug or part other than those meant for the purpose intended.

2.9 Maximum quantities

Maintain the maximum or the minimum volume for each type of material by the scale on the jug (4).

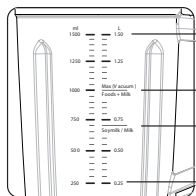

- Maximum level for materials to blend (1,500ml)
- Maximum level for materials including milk products such as milk and soymilk to vacuum (1,000ml)
- Maximum level for milk products such as milk and soymilk to vacuum (700ml)
- Minimum level for materials to blend (250ml)

2 Use



WARNING:

- Do not exceed the maximum level for each food material indicated by the scale on the jug (4). Air bubbles or food materials getting into the pump can cause trouble.
- If there are ingredients stuck between the chopping blades (6), please dismount it from the jug (4) and remove the stuck matter using a long slender utensil, etc.

2.10 Anti-insect prevention for vacuum passage

The measuring cup (22) accessory can be used as an anti-insect cap to prevent insects or bacteria breeding in the vacuum passage.

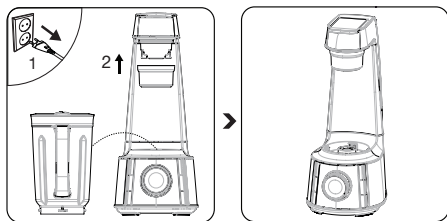

Take out the jug (4) from the motor housing (8) and pull down the lever (7). Place and secure the measuring cup (22) onto the vacuum suction head (21).

If you want to operate the appliance again, remove the measuring cup (22) from the vacuum suction head (21) first before intend to pull up the lever (7).

2 Use



WARNING: Take cautions to make sure the food material does not go into the safety device. Never directly push the safety switch pin with your finger or a rod, etc.

2.11 Motor Protection

Automatic motor protection will get activated and stop the appliance when the appliance overheats. In this case;

- 1 Move the speed adjustment knob (9) to "OFF" position.
2. Unplug the appliance.
3. Let it cool for 15-20 minutes.

3 Cleaning and care

3.1 Cleaning

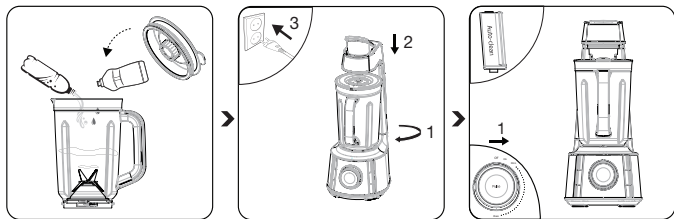

Add 1 or 1 ½ cups of luke warm water and some drops of dish-washing liquid into the jug (4) and close the lid (3).

Place the jug (4) into the motor unit (8). Lock the jug (4) clockwise according to the "Lock" arrow on the motor unit (8) and press down the lever (7). Plug in the appliance.

Use Auto Clean program to operate it for 26 seconds.

3 Cleaning and care

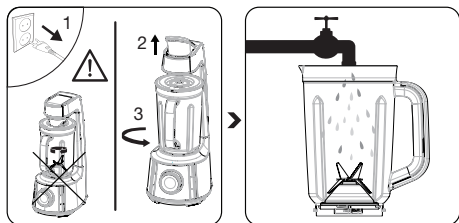

Unplug the appliance before cleaning. Wait for the accessories used to stop completely. Pull up the lever (7) and unlock the jug (4) anticlockwise according to the "Open" arrow on the motor unit (8). Pull up the jug (4) to remove it from the motor unit (8). Then rinse it.



- You can wash the jug, portable bottle (4, 23) and the caps/lids, portable bottle lid (3, 22, 24, 25) in your dish-washer. It is recommended to clean the appliance immediately after using.



WARNING:

- Do not immerse the motor unit (8) in water. You can wipe it with a damp cloth.
- Chopping blade (6) is sharp. Do not hold the sharp edge or immerse in water while cleaning.

3 Cleaning and care

3.2 Washing or replacing the filter

The vacuum suction head (21) on the appliance is assembled with a washable permanent filter to avoid trouble in case the jug lid (3) is spattered with food, as this can block the vacuum passage and cause trouble.

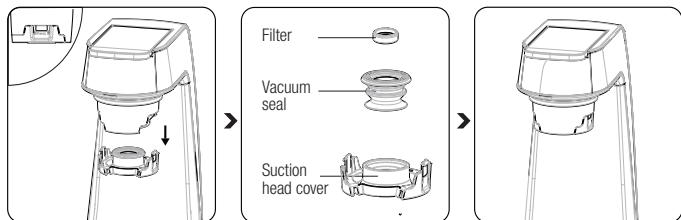

Press the latches of suction head cover (21) at both sides to remove it downward.

Take out the filter (19) from the vacuum seal (20) to wash or rinse it, or replace a new one.

Place and secure the suction head cover (21) back before use.

The jug lid (3) is also assembled with a washable permanent filter.



Turn over the lid (3) and open the backflow prevention cap by turning it anti-clockwise to remove it from the lid (3).

Take out the backflow prevention cap to wash or rinse then to dry it. Make sure there is no water or foods blocked venting holes.

Place and secure the backflow prevention cap back by turning it clockwise before use.

3 Cleaning and care

3.3 Storage

- If you do not intend to use the appliance for a long time, store it carefully.
- Unplug the appliance and wait for it to cool completely before storing it.
- Keep the appliance and its accessories in their original packages.
- Do not wrap the power cord around the appliance.
- Store it in a cool, dry place.
- Always keep the appliance out of the reach of children.

3.4 Handling and transportation

- During handling and transportation, carry the appliance in its original packaging. The packaging of the appliance protects it against physical damages.
- Do not place heavy loads on the appliance or on the packaging. The appliance may get damaged.
- Dropping the appliance may render it non-operational or cause permanent damage.

Vacuum Blender

User Manual



TBV8106BX

AR

beko

01M-8813893200-2518-01

Free Manuals Download Website

<http://myh66.com>

<http://usermanuals.us>

<http://www.somanuals.com>

<http://www.4manuals.cc>

<http://www.manual-lib.com>

<http://www.404manual.com>

<http://www.luxmanual.com>

<http://aubethermostatmanual.com>

Golf course search by state

<http://golfingnear.com>

Email search by domain

<http://emailbydomain.com>

Auto manuals search

<http://auto.somanuals.com>

TV manuals search

<http://tv.somanuals.com>