

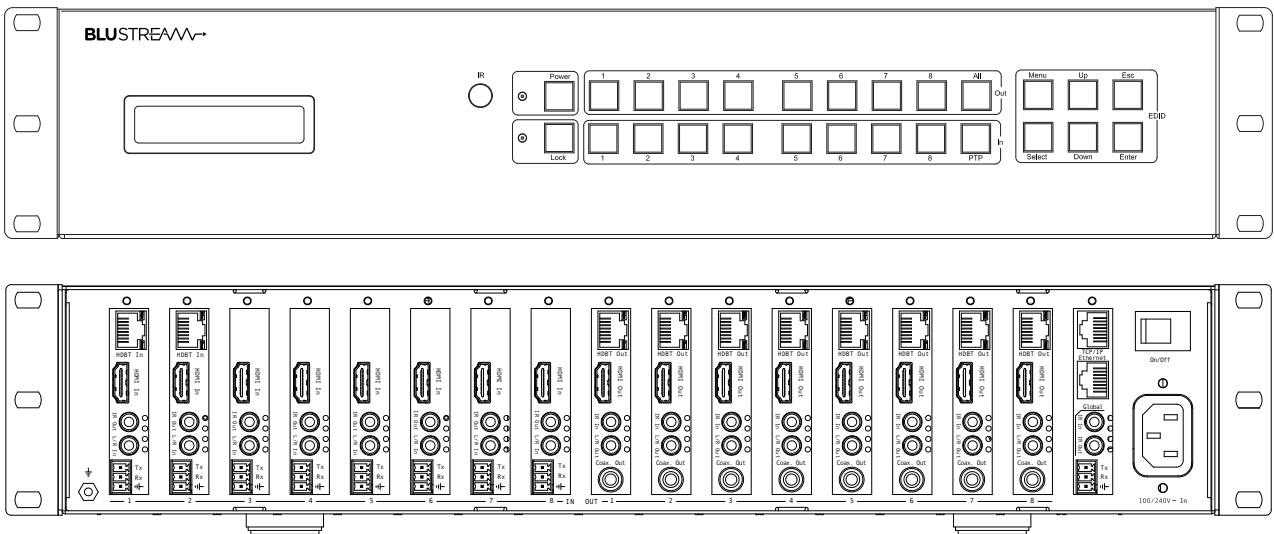

PLATINUM MATRIX SOLUTIONS



PLA88ARC V2

PLA88L V2

PLA66ARC V2

PLA66L V2

User Manual

Thank you for purchasing this product.

For optimum performance and safety, please read these instructions carefully before connecting, operating or adjusting this product. Please keep this manual for future reference.



Surge protection device recommended

This product contains sensitive electrical components that may be damaged by electrical spikes, surges, electric shock, lightning strikes, etc. Use of surge protection systems is highly recommended in order to protect and extend the life of your equipment.

Safety And Performance Notice

The transmission distances of HDMI over UTP cables are measured using TE CONNECTIVITY 1427071-6

EIA/TIA-568-B termination (T568B) of cables is recommended for optimal performance.

To minimize interference of the unshielded twisted pairs in the CAT5e/6/6a cable do not run the HDBaseT / CAT5e/6/6a cabling with or in close parallel proximity to mains power cables.

Do not substitute or use any other power supply other than the enclosed unit, or a Blustream approved replacement.

Do not disassemble either the Transmitter or Receiver units for any reason. Doing so will void the manufacturer's warranty.

Contents

- Introduction.....03
- Features.....03
- Panel Descriptions.....04
- Matrix Main Communication Board.....05
- Matrix HDBaseT Receiver Options.....06
- Matrix HDBaseT Transmitter Options.....07
- Matrix Front Panel Control.....08
- EDID Control.....09
- Audio Breakout.....09
- Terminating HDBaseT Cat Cable.....10
- Understanding the Matrix/Receiver Status Lights.....10
- Infrared Distribution.....11
- Infrared Remote Control.....12
- Application Diagram.....13
- Specifications.....14
- Package Contents.....14
- Maintenance.....14
- Infrared Commands.....15-16
- RS-232 and Telnet Commands.....17-19
- Certifications.....20

Introduction

Our Platinum series of HDBaseT Matrix products offer the very best performance and flexibility for the custom installer. The Platinum Matrix V2 is a 4K HDCP 2.2 compliant Matrix, transmitting HDMI, Bi-directional IR, RS-232 and PoH (PoE) up to lengths of 100m over a single CAT cable. The Matrix also provides advanced features including independent audio routing, Audio Return Channel (ARC), simultaneous HDBaseT/HDMI outputs, HDBaseT inputs and LAN Serving. The Matrix can be controlled and configured using the Blustream software or Web - GUI, allowing the user to define audio channels, designate EDID presets and insert audio delays on outputs to correct any lip sync issues within the system.

PLA88L-V2 Features:

- 8x HDMI inputs which can be independently routed to 8x HDBaseT/HDMI video outputs (quantity dependent on model)
- Simultaneous HDBaseT™ and HDMI outputs to allow connection to dual displays per zone
- Supports 4K UHD video (3840 x 2160 @30Hz 4:4:4, 4096 x 2160 @24Hz 4:4:4, and 4K @60Hz 4:2:0)
- Supports distances of up to 70m @ 1080p & 40m @ 4K on a single CAT cable
- 2x HDBaseT inputs allowing sources to be located remotely using Blustream HDBaseT transmitters (quantity dependent on model)
- Supports POH (Power Over HDBaseT) to power Blustream transmitters and receivers - no local power supplies required
- Integrated 24 Input x 16 output Audio Matrix (16 Input x 12 output on PLA66 models)
- Analog audio L/R embedding onto HDMI outputs with audio delay adjustment
- HDMI audio de-embedding to analog audio L/R + digital coaxial outputs. Please note: Input must be PCM 2CH audio as the Matrix does not down-mix 5.1CH audio signals
- Bi-directional RS-232 and IR from all input and output locations (with compatible Blustream 5V emitters and receivers)
- Web interface module for control & configuration of the matrix
- Advanced EDID management
- HDCP 2.2 Compliant

PLA88ARC-V2 Additional Features:

- Supports distances of up to 100m @ 1080p & 70m @ 4K on a single CAT cable
- LAN serving (Ethernet Switch) with compatible HEX100ARC-RX Blustream HDBaseT receivers
- Audio Return Channel (ARC) via HDMI or Optical with compatible HEX100ARC-RX Blustream HDBaseT receivers

Panel Descriptions

Front Panel

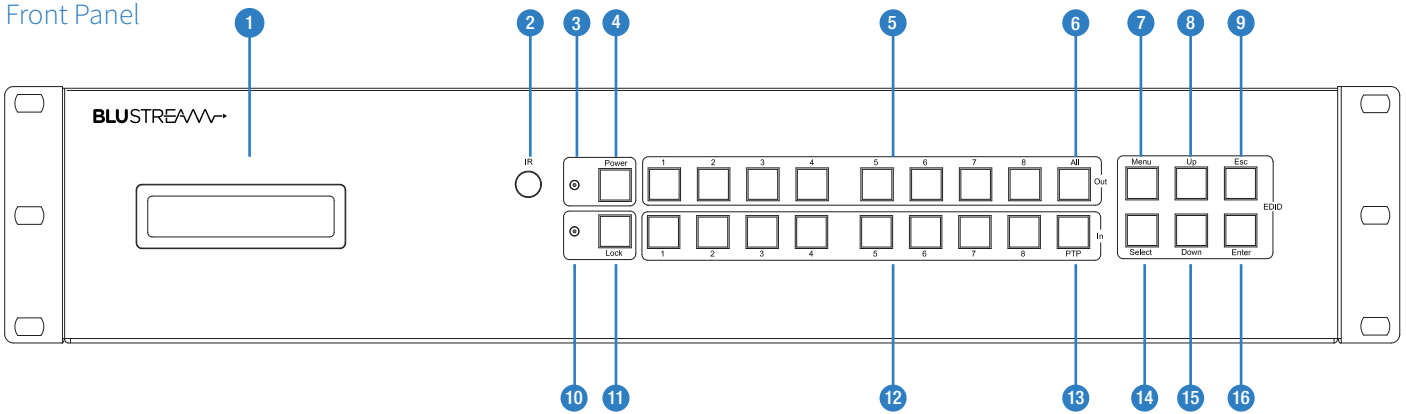

- 1 LCD display – Show the status of input & output selection and EDID info.
- 2 IR receiver window – Receives IR from a hand held remote control or processor.
- 3 Power LED indicator - Indicates the power status of the matrix.
- 4 Power button – Press to toggle power of the matrix on/off.
- 5 HDMI output selection button 1 to 8 – Press to select the output from 1 to 8.
- 6 All button for HDMI outputs – Press to select all of the outputs from 1 to 8.
- 7 Menu button – Press to enter EDID setup.
- 8 Up – Press to change up through the adjustable values.
- 9 ESC - Press to quit EDID set up menu.
- 10 Lock LED indicator - Indicate the status of the key lock.
- 11 Lock button – Press to lock the buttons on the front panel (Press and hold for 2 seconds).
- 12 HDMI input selection button 1 to 8 – Press to select the input from 1 to 8.
- 13 PTP button-Press to mirror all inputs and outputs (e.g. output 1 to input 1, output 2 to input 2 and so on).
- 14 Select – Press to select an EDID parameter to change. Selected segment will blink.
- 15 Down – Press to change down through the adjustable values.
- 16 Enter – Press to set EDID to specified INPUT or copy EDID from specified OUTPUT to specified INPUT.

Rear Panel (PLA88xx model shown)

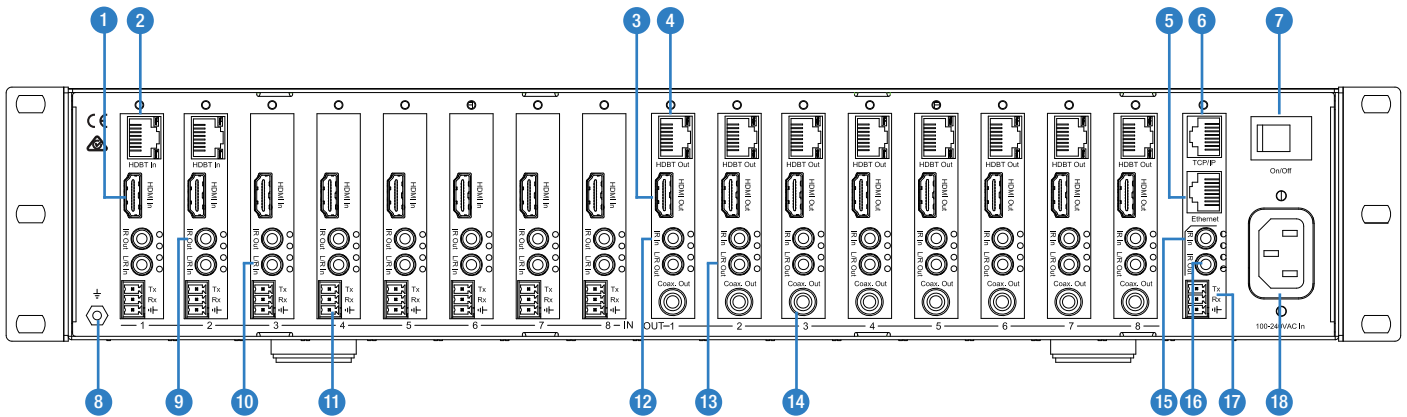

- 1 HDMI inputs 1 to 8 – Connect HDMI sources.
- 2 HDBT inputs 1 & 2 – Connect remote HDBT transmitter.
- 3 HDMI outputs 1 to 8 – Output for displays.
- 4 HDBT outputs 1 to 8 – Output for displays.
- 5 Ethernet-embedded for LAN serving to all connected HDBT transmitters and receivers (ARC models only).
- 6 RJ45 - TCP/IP control.
- 7 Power switch.
- 8 GND – Ground connection.
- 9 IR outputs 1 to 8 – 3.5mm mono jack for routed IR emitter outputs for discrete source control.
- 10 L/R stereo inputs 1 to 8 – 3.5mm stereo jack.
- 11 RS-232 port – Connect to this port for the control of the matrix from a computer or control processor.
- 12 IR Inputs 1 to 8 – 3.5mm stereo jack for integration with a control processor.
- 13 L/R stereo outputs 1 to 8 – 3.5mm stereo jack.
- 14 Coaxial Digital outputs 1 to 8 – RCA connector.
- 15 Global IR Input – 3.5mm stereo jack.
- 16 Global IR Output – 3.5mm mono jack.
- 17 RS-232 Port – 3-pin phoenix terminal.
- 18 AC power input – 100V-240V input.

Matrix Main Communication Board

The Matrix main communication board is located on the rear panel and has the following connections:-

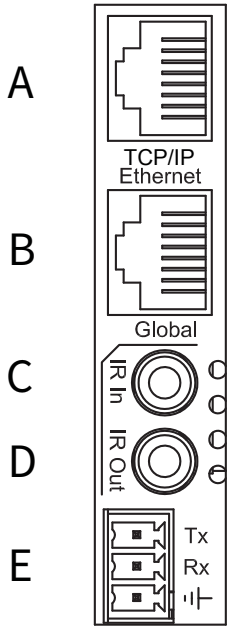

Connections

- A. TCP/IP – For control of Matrix (RJ45 Connector)
- B. Ethernet – Matrix includes a 10/100 Ethernet switch (RJ45 Connector)
- C. Global IR Input 3.5mm stereo jack
- D. Global IR Output 3.5mm mono jack
- E. RS-232 2-way (Phoenix Connector) for 3rd party control of Matrix.

TCP/IP

The Blustream Matrix can be controlled via TCP/IP.

For full list of protocols please see ‘RS-232 & Telnet Commands’ located at the rear of this manual.

A ‘Straight-through’ RJ45 patch lead should be used

RS-232 2-Way

The Blustream matrix can be controlled via supplied 3-pin Phoenix to 9-pin serial cable.

For full list of 3rd party control protocols please see ‘RS-232 & Telnet Commands’ located at the rear of this manual.

Details of RS-232 pin assignment and communication are below:

PLA-XX V2		REMOTE CONTROL CONSOLE	
PIN	Assignment	PIN	Assignment
1	NC	1	NC
2	Tx	2	Rx
3	Rx	3	Tx
4	NC	4	NC
5	GND	5	GND
6	NC	6	NC
7	NC	7	NC
8	NC	8	NC
9	NC	9	NC

Baud Rate: 57600 bps

Data Bit: 8-bit

Parity: None

Stop Bit: 1-bit

Flow Control: None

Matrix HDBaseT Receiver Options

There are four HDBaseT receiver options that are compatible with the HDBaseT outputs of the Blustream Matrix:-

HEX70B-RX

Basic HDBaset Receiver with 2-way IR pass-through. Supports distances up to 70m. Compatible with all Platinum Blustream Matrix products.

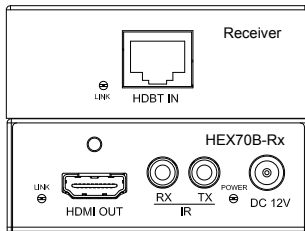

- HDBaseT input
- HDMI output
- IR Output 3.5mm mono jack
- IR Input 3.5mm stereo jack

HEX70ED-RX

Mid-Level HDBaseT receiver which has the same features as the HEX70B-RX receiver but with added 2-way RS-232 control. Compatible with all Platinum Blustream Matrix products.

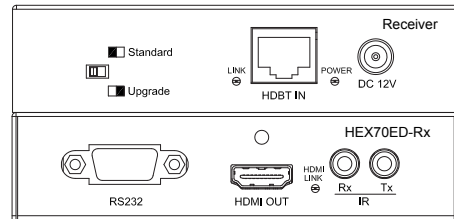

- HDBaseT input
- HDMI output
- 2-way RS-232 (9-pin serial)
- IR Output 3.5mm mono jack
- IR Input 3.5mm stereo jack

HEX100ARC-RX

Premium HDBaseT receiver which features 2-way IR & RS-232, HDMI ARC (when used with associated PLAxARC Matrix) and display distances up to 100m. Only compatible with PLA88ARC and PLA66ARC Blustream Matrix products.

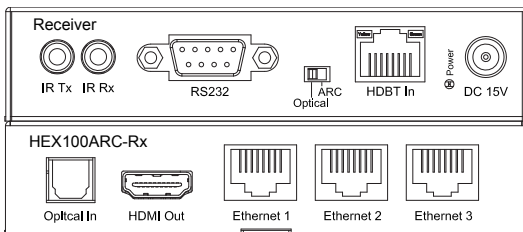

- HDBaseT input
- HDMI Output
- Optical Audio input (Toslink)
- 2-way RS-232 (9-pin serial)
- IR Output 3.5mm Mono Jack
- IR Input 3.5mm Mono Jack
- 3x 10/100 Ethernet connections (RJ45)

RX70AMP

The RX70AMP is a combination of HDBaseT receiver and Class D digital audio amplifier (30W per channel). The unit has local HDMI and Analogue audio inputs as well as supporting HDMI ARC (audio Return Channel) with compatible products. Should you wish to use alternate power amplification the unit has variable analogue outputs. Control of the unit is possible via front panel or by bi-directional RS-232 or IR control. Supports distances up to 70m. Compatible with all Platinum Blustream Matrix products.

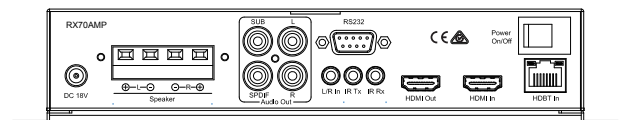

- HDBaseT input
- HDMI output
- HDMI Local input for connection of local source
- 2.1 Stereo audio output @ 30W per channel (capable of drive 4, 6 & 8 Ohm speakers) & analogue Subwoofer output (RCA)
- Variable analogue line level outputs (RCA)
- Digital Coaxial S/PDIF output
- Local analogue L/R audio input 3.5mm Stereo Jack
- 2-way RS232 (9-pin serial)
- IR Output 3.5mm mono Jack
- IR Input 3.5mm stereo Jack
- Built-in IR receiver on front panel of unit

Matrix HDBaseT Transmitter Options

When it is a requirement that source equipment is to be located away from the central Blustream Matrix there are four Blustream HDBaseT Transmitters that that can be partnered with the HDBaseT Inputs and allow hardware to be located at distances up to 100m:-

HEX70B-TX

Basic HDBaset Transmitter with 2-way IR pass-through. Supports distances up to 70m.

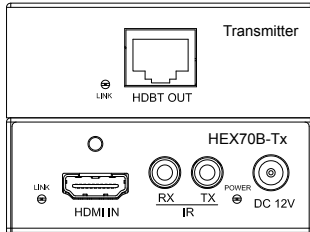

- HDMI input
- HDBaseT output
- IR output 3.5mm mono jack
- IR input 3.5mm stereo jack
- HDCP 1.4 compliant

HEX70ED-TX V2

HDBaseT HDCP 2.2 Transmitter which features HDMI loop-out, 2-way IR & RS-232 and distances up to 70m.

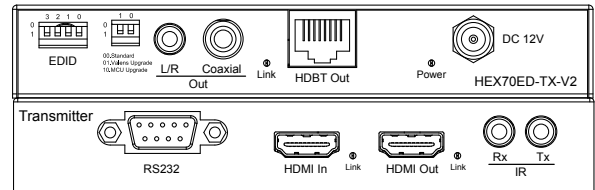

- HDMI input
- HDBaseT output
- HDMI output (loop-out)
- 2-way RS-232 (9-pin serial)
- IR output 3.5mm mono jack
- IR input 3.5mm stereo jack
- HDCP 2.2 compliant

HEX100ARC-TX V2

Premium HDBaseT HDCP 2.2 Transmitter which features HDMI loop-out, 2-way IR & RS-232 and distances up to 100m.

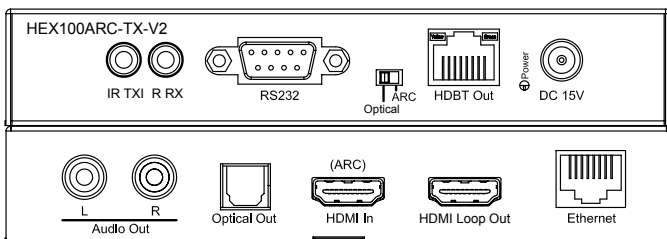

- HDMI input
- HDBaseT output
- HDMI output (loop-out)
- 2-way RS-232 (9-pin serial)
- IR output 3.5mm mono Jack
- IR input 3.5mm stereo jack
- HDCP 2.2 compliant

HEX100HDVGA-TX

Premium HDBaseT Transmitter which features selectable HDMI or VGA+ audio inputs and 2-way IR & RS-232. Supports distances up to 100m.

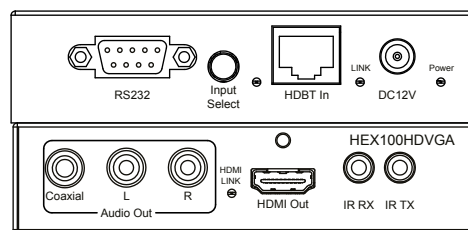

- HDMI & VGA+ audio input
- HDBaseT output
- 2-way RS-232 (9-pin serial)
- IR output 3.5mm mono jack
- IR input 3.5mm stereo jack
- HDCP 1.4 compliant

Matrix Front Panel Control

Front Panel Display - Input/Output selection

The following display shows current source input selection per zone output.

1. To change input selection first press 'OUTPUT' button (1-4)
2. Press desired 'INPUT' button (1-4)
3. An 'X' indicates that the zone output has been turned off.

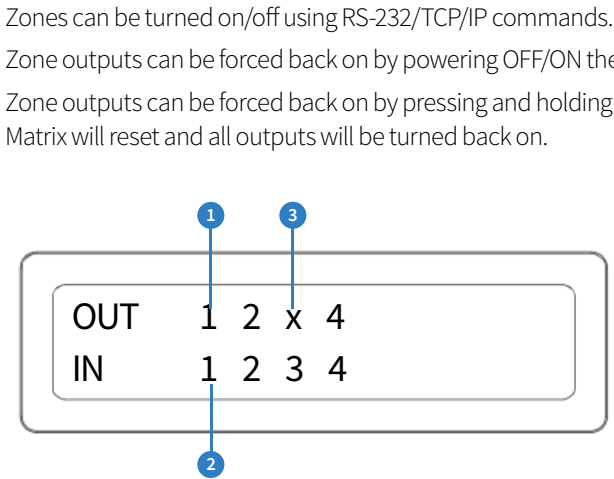

Zones can be turned on/off using RS-232/TCP/IP commands.

Zone outputs can be forced back on by powering OFF/ON the Matrix. All outputs will be turned on when powered up.

Zone outputs can be forced back on by pressing and holding 'OUTPUT 1' button on the front panel for 10 seconds. The Matrix will reset and all outputs will be turned back on.

EDID Management - Global or individual input settings

The following characters show adjusting the EDID for 'All' inputs (Global). Current EDID value is set to 1080P & 2CH audio.

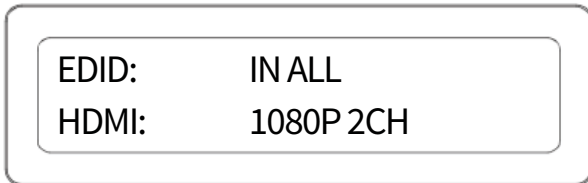

To change the input signal type using the Matrix front panel buttons press the following:-

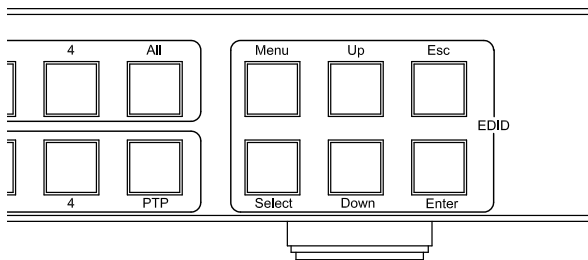

Using Matrix Front Panel Buttons

- a. Press MENU button
- b. Panel will display 'EDID settings'. Press SELECT button
- c. Select the input you wish to fix the EDID on (1-8) or select 'All'. Use UP/DOWN buttons to toggle selection and SELECT button to confirm
- d. Select video resolution required (4K, 1080p, 3D etc). Use UP/DOWN buttons to toggle selection and SELECT button to confirm
- e. Select audio resolution required (2CH, 5.1 or 7.1). Use UP/DOWN buttons to toggle selection and SELECT button to confirm
- f. Press the ESC button to exit

EDID Control

EDID (Extended Display Identification Data) is a data structure that is used between a display and a source. This data is used by the source to find out what audio and video resolutions are supported by the display then from this information the source will discover what the best audio and video resolutions need to be outputted.

While the objective of EDID is to make connecting a digital display to a source a simple plug and play procedure issues do arise when multiple displays or video matrix switching is introduced because of the increased number of variables.

By pre-determining the video resolution and audio format of the source and display device you can reduce the time need for EDID hand shaking thus making switching quicker and more reliable.

Configuration of Matrix EDID settings can be achieved in one of three ways:-

- 1 Using Matrix web browser interface (See 'Blustream Web Browser Interface Guide' for further details available at www.blustream.co.uk)
- 2 Using Matrix Front Panel Buttons (For further details see page 8)
- 3 Using Supplied Blustream Matrix IR Remote Control (For further details see page 12)

Note: EDID settings were revised June 2017 to include independant 4K 4:2:0 and 4K 4:4:4 settings to help with signal management/bandwidth limitations when using HDMI over HDBaseT distribution. For alternate EDID settings and Firmware please visit the Blustream website.

Audio Breakout

The PLAXX V2 Matrix includes both both coaxial digital and 2CH analogue audio outputs. Audio can be selected from:-

- Breakout from selected HDMI/HDBaseT output. Extracted audio will be concurrent with the corresponding HDMI/HDBaseT video output.
- Breakout from selected HDMI/HDBaseT inputs. Extracted audio will be fixed to the selected HDMI/HDBaseT source input.
- Analogue 2CH audio inputs. Audio will be fixed to the selected analogue audio input.
- ARC audio return when used with compatible HDBaseT Receivers (feature only available on PLA88/66ARC models). Extracted audio will be fixed to the selected HDMI/HDBaseT zone output.

The PLAXx V2 analogue outputs include pre-amp line level control allowing you to connect the Blustream Matrix directly into a power amplifier for all your multi-room audio needs.

1. Analogue pre-amp line level output 3.5mm stereo jack - Output 3
2. Coaxial digital output - Output 2

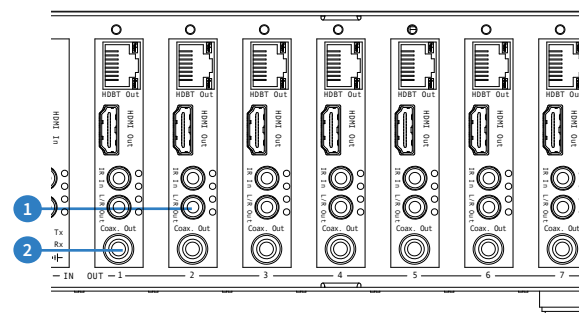

Both coaxial and analogue audio outputs can be adjusted for audio delay.

Control of the pre-amp line level outputs is via the matrix front panel, RS-232, TCP/IP or using the in-built web browser interface. Please see 'RS-232 & Telnet Commands' on page 17 for further details.

Note: Volume control is only available on the analogue audio outputs. Source input must be PCM 2CH audio for analogue audio outputs to work. The PLAXx V2 Matrix do not down-mix 5.1CH audio signals.

Volume control of audio outputs is not possible via Infrared control.

Terminating HDBaseT CAT cable

It is important that the interconnecting CAT cable between the Blustream HDBaseT products is terminated using the correct RJ45 pin configuration. The link CAT cable MUST be a 'straight' (pin-to-pin) CAT cable and it is advised that this is wired to the T568B wiring standard as this format is less prone to EMI (Electro-Magnetic Interference).

When installing CAT cables it is advised that you use the best possible CAT cable quality possible. HDMI distribution products will only work if used with CAT5e standard cable or above. Blustream recommends using a CAT6 cable for your installations, especially when running over longer distances, in areas of high EMI, or for 4K signal distribution. It is advised that using any method of patch panel, wall plate or join in the CAT cable is avoided as these will result in HDBaseT signal degradation. Blustream also recommend using the best quality RJ45 connectors possible.

RJ45 Wiring - T568B

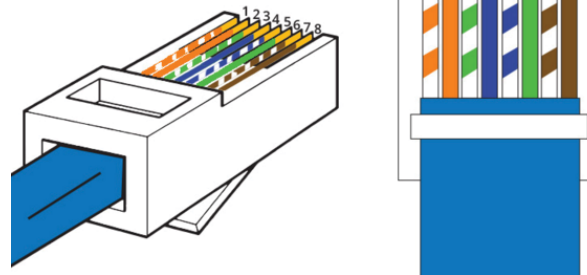

Understanding the Matrix / Receiver HDBaseT status lights

The Blustream Matrix and HDBaseT extender solutions include status LED indicators on both the Matrix and Receiver products to show all connections are active and to help diagnose possible problems.

Understanding the status lights:-

Blustream Matrix:

- The Yellow HDBaseT status link light will be off when the zone output has been turned off or there is a problem with the specific Matrix output.
- The Yellow HDBaseT status link light will blink when the zone output is on and working
- The Green HDBaseT link light will blink if there is an unstable connection between the Blustream Matrix and HDBaseT Receiver
- The Green HDBaseT link light will be lit when a there is an active HDBaseT Receiver connected to the Matrix
- The Green HDBaseT link light will be off when a there is no connection with a HDBaseT receiver

Blustream HDBaseT Receiver:

- The HDMI link light will be off when there is no connection with a display
- The HDMI link light will be on when there is an active connection with a display (NOTE - Not all HDBaseT RX feature a HDMI status LED)
- The HDBaseT link light will be off when there is no CAT cable/active HDBaseT connection on the RJ45 HDBaseT input
- The HDBaseT link light will blink if there is an unstable connection between the Blustream Matrix and HDBaseT receiver
- The HDBaseT link light will be lit when a CAT cable is connected to the HDBaseT RJ45 output on the Matrix and an active connection is achieved with the Blustream HDBaseT Receiver.

Infrared (IR) Distribution

The Blustream range of matrix products include multiple options for control and routing of IR.

IMPORTANT: Blustream Infrared products are all 5v and NOT compatible with alternative manufacturers Infrared solutions. When using third party 12v IR control solutions please use supplied Blustream IRCAB cable for IR conversion.

Each Blustream Matrix and HDBaseT receiver is supplied with all necessary IR hardware required and includes:

IR Emitter - IR1 & IR2 (IR2 sold separately)

Blustream 5V IR Emitter designed for discrete IR control of hardware

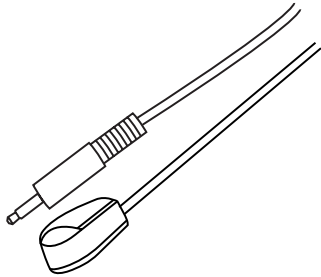

Infrared 3.5mm Pin-Out

IR Emitter - Mono 3.5mm

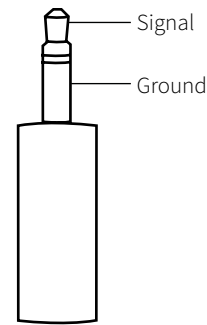

IR Receiver - IRR

Blustream 5V IR receiver to receive IR signal and distribute through Blustream products

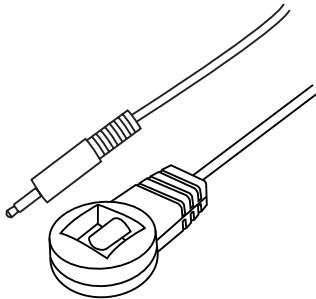

IR Receiver - Stereo 3.5mm

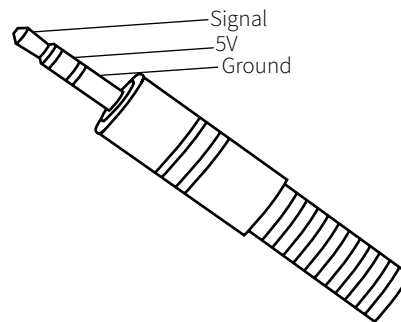

IR Control Cable - IRCAB

Blustream IR Control cable 3.5mm Mono to 3.5mm Stereo for linking third party control solutions to Blustream products.

Compatible with 12v IR third party products.

Note: Cable is directional as indicated

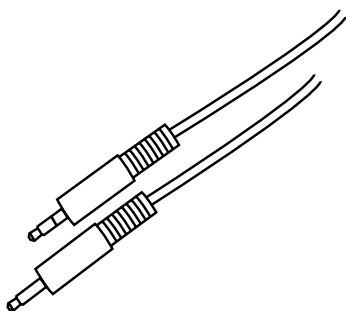

Infrared (IR) Control

The Blustream Platinum Series matrix units are supplied with IR Remote Control for source selection and general setup.

As well as controlling matrix solutions using the original Blustream remote the Blustream products can be controlled using the original Infrared NEC codes shown at the rear of this manual.

Remote Control Description

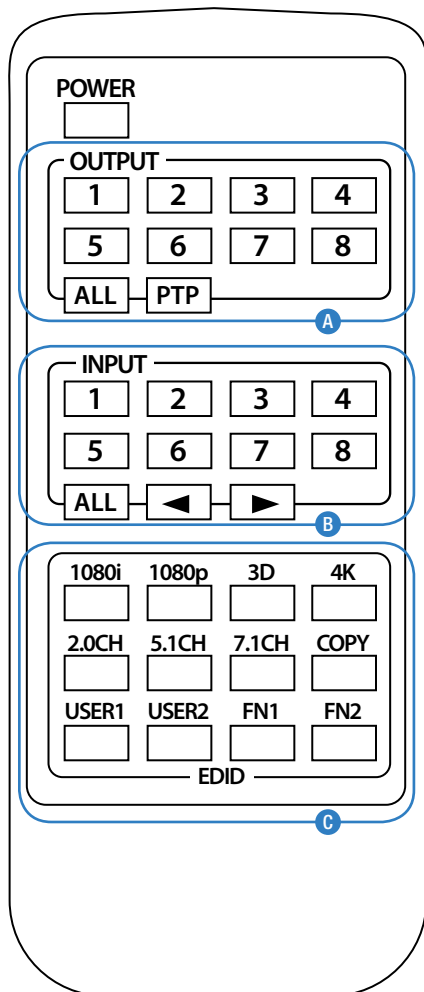

OUTPUT AND INPUT SELECTION

- A Select the zone OUTPUT you wish to change the source on (Numbers 1-8 correspond to the zone outputs 1-8).
- B Select the source INPUT you wish to change on the selected zone to (Numbers 1-8 corresponds to the source inputs 1-8)
- C Press PTP button If you wish to instantly mirror all inputs and outputs (Example - Input 1 to output 1, input 2 to output 2 etc).

EDID SET UP

The PLAXx V2 provides a comprehensive range of EDID settings. Below are three examples of how to deploy the desired EDID setting when using the supplied remote.

- A. Fix EDID to an Input or ALL inputs: Press the desired video resolution button (1080I / 1080P / 3D / 4K), then select the desired audio format (2.0CH / 5.1CH / 7.1CH), then select the source input you want this EDID information allocated to by pressing the INPUT 1 – 4 or the ALL button
- B. Copy EDID of Output-X to an Input or ALL: Press the COPY button then select the OUTPUT you wish to copy the EDID information from, then select the source input you want to copy this EDID to by selecting the INPUT 1-4 or the ALL button.
- C. User defined EDID to an Input or ALL inputs: Press USER1 / USER2 button then select the source you wish to assign this EDID to by select-ing INPUT 1-4 or the ALL button

BLUSTREAM
 Example Schematic
PLA88ARC-V2

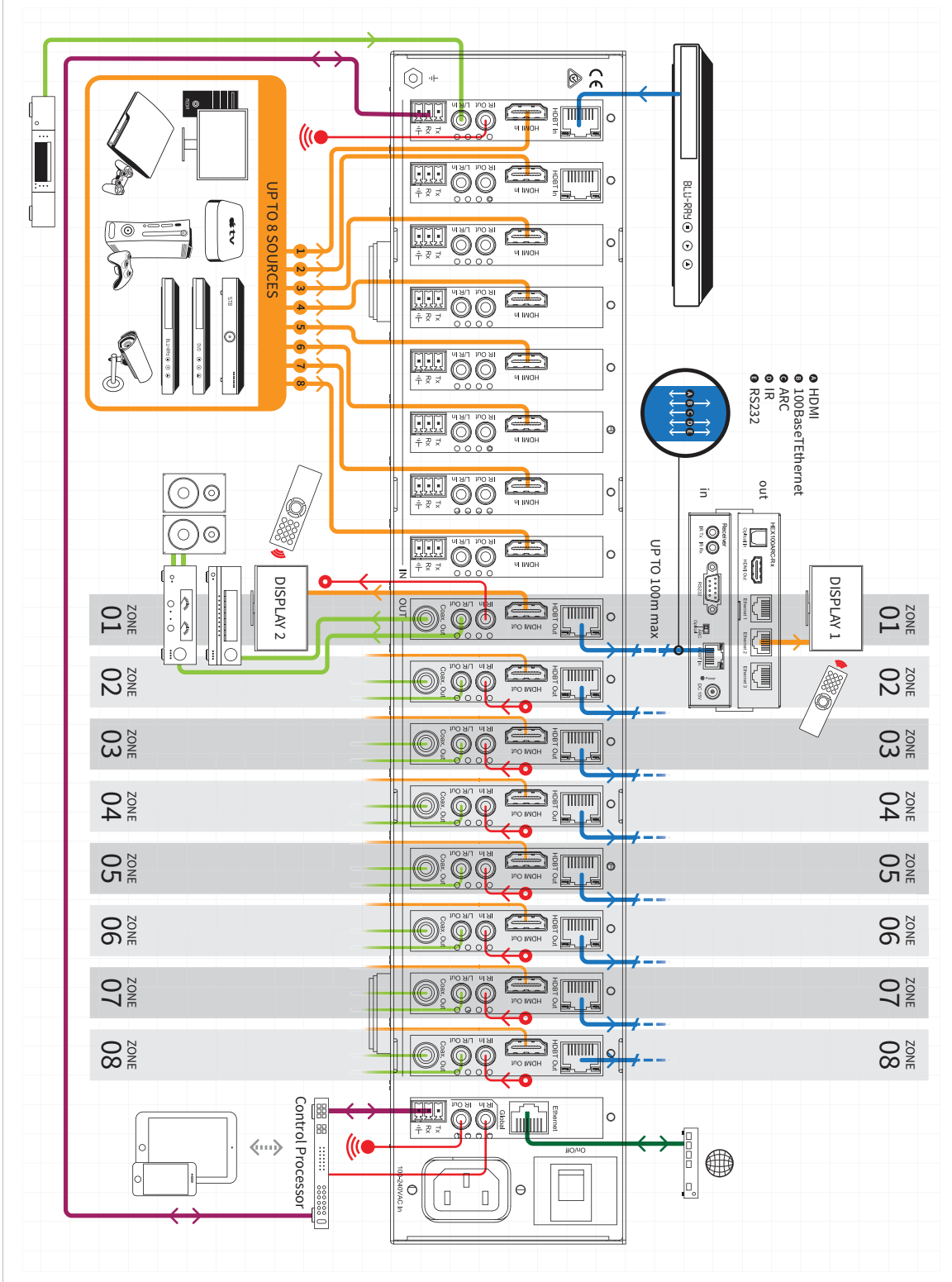
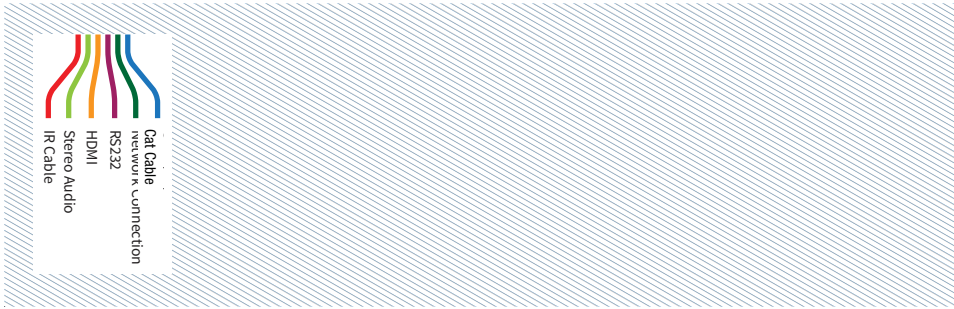

Specifications

Video Input Connections: 8x HDMI Type A, 19-pin, female, 2x HDBaseT RJ45 connector

Video Output Connections: 8x HDMI Type A, 19-pin, female, 8x HDBaseT RJ45 connector

Audio Input Connections: 8x 3.5mm stereo jack (L/R)

Audio Output Connections: 8x RCA (SPDIF), 8x 3.5mm stereo jack (L/R)

RS-232 serial ports: 9x 3-Pin Phoenix connector

TCP/IP Control: RJ45, female

Ethernet/Network: RJ45, female

IR Input ports: 9x 5v 3.5mm stereo jack

IR Output ports: 9x 5v 3.5mm mono jack

Rack-Mountable: 2U rack height, rack ears included

Casing Dimensions (W x H x D): 440mm x 87mm x 361mm, without feet

Dimensions Including Connections (W x H x D): 440mm x 87mm x 369mm, with feet

Shipping Weight: 8.8kg

Operating Temperature: 32°F to 104°F (0°C to 40°C)

Storage Temperature: -4°F to 140°F (-20°C to 60°C)

Input: 100V-250V, 50Hz-60HZ, 13A

NOTE: Specifications are subject to change without notice. Weight details are approximate and will alter per model.

Package Contents:

PLA88L V2 Matrix

- 1x PLA88L V2
- 1x AC power cable
- 1x Remote control
- 9x IR emitter
- 9x IR receiver
- 9x IR 3.5-3.5mm interface cable
- 2x Serial cable – 9-pin DB9 to 3-pin phoenix connector
- 1x Rack mounting kit

PLA88ARC V2 Matrix

- 1x PLA88ARC V2
- 1x AC power cable
- 1x Remote control
- 9x IR emitter
- 9x IR receiver.
- 9x IR 3.5-3.5mm interface cable
- 2x Serial cable – 9-pin DB9 to 3-pin phoenix connector
- 1x Rack mounting kit

PLA66L V2 Matrix

- 1x PLA88L V2
- 1x AC power cable
- 1x Remote control
- 7x IR emitter
- 7x IR receiver
- 7x IR 3.5-3.5mm Interface cable
- 2x Serial cable – 9-pin DB9 to 3-pin phoenix connector
- 1x Rack mounting kit

PLA66ARC V2 Matrix

- 1x PLA88ARC V2
- 1x AC power cable
- 1x Remote control
- 7x IR transmitter,
- 7x IR receiver.
- 7x IR 3.5-3.5mm interface cable
- 2x Serial cable – 9-pin DB9 to 3-pin phoenix connector
- 1x Rack mounting kit

Maintenance

Clean this unit with a soft, dry cloth. Never use alcohol, paint thinner or benzene to clean this unit.

RS232 and Telnet Commands

The Blustream Platinum Matrix products can be controlled via serial and TCP/IP. The following pages list all available serial commands for the Platinum Matrix. Details of RS-232 pin assignment can be found on page 5.

Commonly used Serial commands:

There are several commands that are commonly used for control and testing:-

STATUS	Status will give feedback on Matrix such as zones on, type of connection etc
PON	Power on
POFF	Power off
OUTxxON	(xx is the zone number you wish to turn on)
Example:-	OUT01ON (This would turn output one back on)
OUTxxFRyy	(xx is the zone out, yy is the input)
Example:-	OUT01FR04 (This would switch output 1 to source input 4)

Common Mistakes

- Carriage return – Some programs do not require the carriage return where as other will not work unless sent directly after the string. In the case of some Terminal software the token <CR> is used to execute a carriage return. Depending on the program you are using this token maybe different. Some other examples that other control systems deploy include \r or 0D (in hex)
- Spaces – Blustream commands do not require space between commands unless specified. There may be some programs that require spacing in order to work.
 - How the string should look is as follows OUT01ON
 - How the string may look if spaces are required: OUT{Space}01{Space}ON
- Baud rate or other serial protocol settings not correct - please see Page 5 for Matrix settings

RS-232 and Telnet Commands

NO.	COMAND	ACTION
1	?	Print Help Information
2	HELP	Print Help Information
3	STATUS	Print System Status And Port Status
4	PON	Power On, System Run On Normal State
5	POFF	Power Off, System Run On Power Save State
6	IR ON/OFF	Set System IR Control On Or Off
7	KEY ON/OFF	Set System KEY Control On Or Off
8	APM ON/OFF	Set Advanced Process Mode On Or Off
9	BEEP ON/OFF	Set Onboard Beep On Or Off
10	RESET RESET ALL	Reset System To Default Setting (Should Type "Yes" To Confirm, "No" To Discard) Reset System And Network To Default Setting
11	MXIR xx FR yy Output Port IR:xx From Local IR:yy	xx=[00]: All Output IR, [01...08]: Output IR yy=[01...08] Local IR
12	MXIR GI (+-)xx Global IR_IN Signal To Input/Output IR:xx	xx=[01...08]: Input IR, [09...16]: Local IR xx=[17...24]: Output IR +: Add xx To Current Setting -: Remove xx From Current Setting
13	MXIR GO (+-) xx Global IR_OUT Signal From Input/Output IR:xx	xx=[01...08]: Input IR, [09...16]: Local IR xx=[17...24]: Output IR, [25]: Global IR In +: Add xx To Current Setting -: Remove xx From Current Setting
14	MXRS-232 xx TO yy Local RS-232:xx Connect To Input/Output RS-232:yy	xx=[01...08]: Local RS-232, [09]: Global RS-232 yy=[00]: Disconnect With Any RS-232 yy=[01...08]: Input RS-232, [09...16]: Output RS-232
15	MXSTA	Print Matrix IR And RS-232 Connect State
16	AUD OUT xx ANA yy	Output Port:xx Audio From Input Port:yy Stereo

NO.	COMAND	ACTION
17	AUD OUT xx EXT yy	Output Port:xx Audio From Input Port:yy Extract xx=[00]: All Output Audio, [01...08]: Output Audio yy=[01...08]: Input Port Audio
18	AUD OUT xx ARC tt	Output Port:xx Audio From Output Port:tt ARC xx=[00]: All Output Audio, [01...08]: Output Audio yy=[01...08]: Input Port Audio
19	AUD OUT xx FOANA	Output Port:xx Audio From Select Video Input Stereo xx=[00]: All Output Audio, [01...08]: Output Audio
20	AUD OUT xx FOEXT	Output Port:xx Audio From Select Video Extract xx=[00]: All Output Audio, [01...08]: Output Audio
21	AUD OUT xx DL zz	Set AUDIO:xx Delay zz ms zz=00 ~ 500ms Delay, 50ms per Step
22	AUD STA	Print Input/Output Port Audio Setting State
23	AUD IN xx ORG	Input Port:xx Use Original Receive HDMI/DVI Signal
23	AUD IN xx BPS	Input Port:xx Bypass Receive HDMI/DVI Signal
24	AUD IN xx ANA	Input Port:xx Insert Stereo To HDMI/DVI Signal
25	AUD IN xx AUTO	Input Port:xx Insert Stereo To DVI Signal Only xx=[00]: All Input Port, [01...08]: Input Port
26	IN xx FO yy	INPUT:xx Force Select Source:yy, Stop Auto
27	IN xx AU yy	INPUT:xx Auto Detect Source, Source:yy High Priority xx=[00]: All INPUT Port, [01...08]: INPUT Port yy=[01]: HDMI, [02]: HDBT
28	OUT xx ON/OFF	Set OUTPUT:xx On Or Off
29	OUT xx FR yy	Set OUTPUT:xx From INPUT:yy
30	OUT xx EH/ET	Set OUTPUT:xx Use HDMI/HDBT EDID xx=[00]: All OUTPUT Port, [01...08]: OUTPUT Port yy=[01...08]: INPUT Port

COMMAND	ACTION
EDID xx CP yy	Set Input:xx EDID Copy From Output:yy
EDID xx DF zz	Set Input:xx EDID To Default EDID:zz xx=[00]: All INPUT Port, [01...06]: INPUT Port yy=[01...06]: OUTPUT Port zz=00: HDMI 1080p@60Hz, Audio 2CH PCM zz=01: HDMI 1080p@60Hz, Audio 5.1CH DTS/DOLBY zz=02: HDMI 1080p@60Hz, Audio 7.1CH DTS/DOLBY/HD zz=03: HDMI 1080i@60Hz, Audio 2CH PCM zz=04: HDMI 1080i@60Hz, Audio 5.1CH DTS/DOLBY zz=05: HDMI 1080i@60Hz, Audio 7.1CH DTS/DOLBY/HD zz=06: HDMI 1080p@60Hz/3D, Audio 2CH PCM zz=07: HDMI 1080p@60Hz/3D, Audio 5.1CH DTS/DOLBY zz=08: HDMI 1080p@60Hz/3D, Audio 7.1CH DTS/DOLBY/HD zz=09: HDMI 4K@30Hz 4:4:4, Audio 2CH PCM zz=10: HDMI 4K@30Hz 4:4:4, Audio 5.1CH DTS/DOLBY zz=11: HDMI 4K@30Hz 4:4:4, Audio 7.1CH DTS/DOLBY/HD zz=12: DVI 1280x1024@60Hz, Audio None zz=13: DVI 1920x1080@60Hz, Audio None zz=14: DVI 1920x1200@60Hz, Audio None zz=15: User EDID 1 zz=16: User EDID 2 zz=17: GUI Download EDID zz=18: HDMI 4K@60Hz 4:2:0, Audio 2CH PCM zz=19: HDMI 4K@60Hz 4:2:0, Audio 5.1CH DTS/DOLBY zz=20: HDMI 4K@60Hz 4:2:0, Audio 7.1CH DTS/DOLBY/HD
MUTE ON/OFF OUT yy	Set Output Audio: yy Mute ON or OFF
VOL xx OUT yy	Set Output Audio:yy Volume to xx yy=[00]: All Output Audio, [01...06]: Output Audio xx=[00...30]: Volume Value xx=+: Volume Increase xx=-: Volume Decrease
NET DHCP ON/OFF	Set Auto IP(DHCP) ON Or OFF
NET IP xxx.xxx.xxx.xxx	Set IP Address
NET GW xxx.xxx.xxx.xxx	Set Gateway Address
NET SM xxx.xxx.xxx.xxx	Set Subnet Mask Address
NET RB	Set Network Reboot and Apply New Config!!!
NET TN xxxx	Set Telnet Port

Certifications

FCC Notice

This equipment has been tested and found to comply with the limits for a Class B digital device, pursuant to part 15 of the FCC Rules. These limits are designed to provide reasonable protection against harmful interference in a residential installation. This equipment generates, uses, and can radiate radio frequency energy and, if not installed and used in accordance with the instructions, may cause harmful interference to radio communications. However, there is no guarantee that interference will not occur in a particular installation. If this equipment does cause harmful interference to radio or television reception, which can be determined by turning the equipment off and on, the user is encouraged to try to correct the interference by one or more of the following measures:

- Reorient or relocate the receiving antenna.
- Increase the separation between the equipment and receiver.
- Connect the equipment into an outlet on a circuit different from that to which the receiver is connected.
- Consult the dealer or an experienced radio/TV technician for help.

CAUTION - changes or modifications not expressly approved by the party responsible for compliance could void the user's authority to operate the equipment.

CANADA, INDUSTRY CANADA (IC) NOTICES

This Class B digital apparatus complies with Canadian ICES-003.

Operation is subject to the following two conditions: (1) this device may not cause interference, and (2) this device must accept any interference, including interference that may cause undesired operation of the device.

CANADA, AVIS D'INDUSTRY CANADA (IC)

Cet appareil numérique de classe B est conforme aux normes canadiennes ICES-003.

Son fonctionnement est soumis aux deux conditions suivantes : (1) cet appareil ne doit pas causer d'interférence et (2) cet appareil doit accepter toute interférence, notamment les interférences qui peuvent affecter son fonctionnement.

CORRECT DISPOSAL OF THIS PRODUCT

This marking indicates that this product should not be disposed with other household wastes. To prevent possible harm to the environment or human health from uncontrolled waste disposal, recycle it responsibly to promote the sustainable reuse of material resources. To return your used device, please use the return and collection systems or contact the retailer where the product was purchased. They can take this product for environmentally safe recycling.



Notes

Free Manuals Download Website

<http://myh66.com>

<http://usermanuals.us>

<http://www.somanuals.com>

<http://www.4manuals.cc>

<http://www.manual-lib.com>

<http://www.404manual.com>

<http://www.luxmanual.com>

<http://aubethermostatmanual.com>

Golf course search by state

<http://golfingnear.com>

Email search by domain

<http://emailbydomain.com>

Auto manuals search

<http://auto.somanuals.com>

TV manuals search

<http://tv.somanuals.com>