

# brother®

ENGLISH

**TZ**  
TAPE

*P-touch*®  
ELECTRONIC LABELING SYSTEM

## PT-2730 USER'S GUIDE

Read this User's Guide before you start using your P-touch.  
Keep this User's Guide in a handy place for future reference.

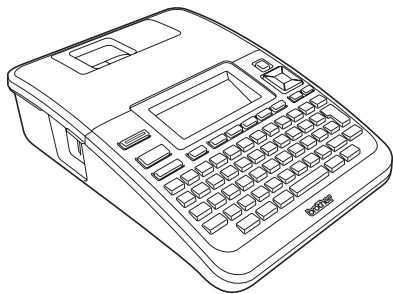

- 1 INTRODUCTION
- 2 GETTING STARTED
- 3 EDITING A LABEL
- 4 LABEL PRINTING
- 5 USING THE FILE MEMORY
- 6 MAINTAINING YOUR P-TOUCH LABELER
- 7 TROUBLESHOOTING
- 8 APPENDIX
- 9 INDEX

# INTRODUCTION

Thank you for purchasing the P-touch labeler PT-2730.

Your new P-touch labeler is an easy to operate, feature packed labeling system that makes creating professional, high quality labels a breeze. In addition to easy label creation via pre-formatted label layouts, the P-touch labeler editing software features advanced label formatting, block formats, bar codes and auto-numbering functions. This manual contains various precautions and basic procedures for using this labeler. Read this manual carefully before using and keep in a handy place for future reference.

## **Federal Communications Commission (FCC) Declaration of Conformity (For USA Only)**

Responsible Party : Brother International Corporation  
100 Somerset Corporate Boulevard  
Bridgewater, NJ 08807-0911 USA  
TEL : (908) 704-1700

declares that the products

Product Name : Brother P-touch Electronic Labeling System  
Model Number : PT-2730

comply with Part 15 of the FCC Rules. Operation is subject to the following two conditions: (1) this device may not cause harmful interference, and (2) this device must accept any interference received, including interference that may cause undesired operation.

This equipment has been tested and found to comply with the limits for a Class B digital device, pursuant to Part 15 of the FCC Rules. These limits are designed to provide reasonable protection against harmful interference in a residential installation. This equipment generates, uses, and can radiate radio frequency energy and, if not installed and used in accordance with the instructions, may cause harmful interference to radio communications. However, there is no guarantee that interference will not occur in a particular installation. If this equipment does cause harmful interference to radio or television reception, which can be determined by turning the equipment off and on, the user is encouraged to try to correct the interference by one or more of the following measures:

- Reorient or relocate the receiving antenna
- Increase the separation between the equipment and receiver.
- Connect the equipment into an outlet on a circuit different from that to which the receiver is connected.
- Consult the dealer or an experienced radio/TV technician for help.

### **Important**

- The enclosed interface cable should be used in order to ensure compliance with the limits for a Class B digital device.
- Changes or modifications not expressly approved by Brother Industries, Ltd. could void the user's authority to operate the equipment.

### **International ENERGY STAR® Compliance Statement**

The purpose of the International ENERGY STAR® Program is to promote the development and popularization of energy-efficient office equipment. As an ENERGY STAR® Partner, Brother Industries, Ltd. has determined that this product meets the ENERGY STAR® guidelines for energy efficiency.



### **Compilation and Publication Notice**

Under the supervision of Brother Industries, Ltd., this manual has been compiled and published, covering the latest product's descriptions and specifications.

The contents of this manual and the specifications of this product are subject to change without notice.

If new versions of the PT-2730 software become available, this manual may not reflect the updated features. Therefore, you may find that the software and the contents in this manual are different.

### **Trademarks and Copyrights**

The Brother logo is a registered trademark of Brother Industries, Ltd.

Brother is a registered trademark of Brother Industries, Ltd.

© 2010 Brother Industries, Ltd. All rights reserved.

Microsoft, Windows Vista, and Windows are registered trademarks of Microsoft Corporation in the United States and other countries.

Apple, Macintosh and Mac OS are trademarks of Apple Inc., registered in the United States and other countries.

The names of other software or products used in this document are trademarks or registered trademarks of the respective companies that developed them.

Each company whose software title is mentioned in this manual has a Software License Agreement specific to its proprietary programs.

Any trade names and product names of companies appearing on Brother products, related documents and any other materials are all trademarks or registered trademarks of those respective companies.

## Brother® Two-Year Limited Warranty and Replacement Service (USA Only)

### Who is covered:

- This limited warranty ("warranty") is given only to the original end-user/retail purchaser (referred to in this warranty as "Original Purchaser") of the accompanying product, consumables and accessories (collectively referred to in this warranty as "this Product").
- If you purchased a product from someone other than an authorized Brother reseller in the United States or if the product was used (including but not limited to floor models or refurbished product), prior to your purchase you are not the Original Purchaser and the product that you purchased is not covered by this warranty.

### What is covered:

- The machine includes a Machine and may include Consumable and Accessory Items. Consumable and Accessory Items include but are not limited to label cassettes, cutters, stamps, power adapters, cases and batteries.
- Except as otherwise provided herein, Brother warrants that the Machine and the accompanying Consumable and Accessory Items will be free from defects in materials and workmanship, when used under normal conditions.
- This warranty applies only to products purchased and used in the United States. For products purchased in, but used outside, the United States, this warranty covers only warranty service within the United States (and does not include shipping outside the United States).

### What is the length of the Warranty Periods:

- Machines: two years from the original purchase date.
- Accompanying Consumable and Accessory Items: 90 days from the original purchase date or the rated life of consumable, whichever comes first.

### What is NOT covered:

#### This warranty does not cover:

- (1) Physical damage to the machine;
- (2) Damage caused by improper installation, improper or abnormal use, misuse, neglect or accident (including but not limited to transporting the machine without the proper preparation and/or packaging);
- (3) Damage caused by another device or software used with the machine (including but not limited to damage resulting from use of non Brother®-brand parts and Consumable and Accessory Items);
- (4) Consumable and Accessory Items that expired in accordance with a rated life; and,
- (5) Problems arising from other than defects in materials or workmanship.

This limited warranty is VOID if the machine has been altered or modified in any way (including but not limited to attempted warranty repair without authorization from Brother and/or alteration/removal of the serial number).

### What to do if you think your Product is eligible for warranty service:

Report your issue to our P-touch Customer Service Hotline at 1-877-BROTHER (1-877-276-8437) or to a Brother Authorized Service Center within the applicable warranty period. Supply Brother or the Brother Authorized Service Center with a copy of your dated bill of sale showing that the machine was purchased within the U.S. For the name of local Brother Authorized Service Center(s), call 1-877-BROTHER (1-877-276-8437).

### What Brother will ask you to do:

After contacting Brother or a Brother Authorized Service Center, you may be required to deliver (by hand if you prefer) or send the Product properly packaged, freight pre-paid, to the Authorized Service Center together with a photocopy of your bill of sale. **You are responsible for the cost of shipping, packing product, and insurance (if you desire). You are also responsible for loss or damage to the machine in shipping.**

### **What Brother will do:**

If the problem reported concerning your Machine and/or accompanying Consumable and Accessory Items is covered by this warranty and if you first reported the problem to Brother or an Authorized Service Center within the applicable warranty period, Brother or its Authorized Service Center will repair or replace the Machine and/or accompanying Consumable and Accessory Items at no charge to you for parts or labor. The decision as to whether to repair or replace the Machine and/or accompanying Consumable and Accessory Items is made by Brother in its sole discretion.

Brother reserves the right to supply a refurbished or remanufactured replacement Machine and/or accompanying Consumable and Accessory Items and use refurbished parts provided such replacement products conform to the manufacturer's specifications for new product/parts.

The repaired or replacement Machine and/or accompanying Consumable and Accessory Items will be returned to you freight prepaid or made available for you to pick up at a conveniently located Authorized Service Center.

If the Machine and/or accompanying Consumable and Accessory Items are not covered by this warranty (either stage), you will be charged for shipping the Machine and/or accompanying Consumable and Accessory Items back to you and charged for any service and/or replacement parts/products at Brother's then current published rates.

**The foregoing are your sole (i.e., only) and exclusive remedies under this warranty.**

### **What happens when Brother elects to replace your Machine:**

When a replacement Machine is authorized by Brother, and you have delivered the Machine to an Authorized Service Center, the Authorized Service Center will provide you with a replacement Machine after receiving one from Brother. If you are dealing directly with Brother, Brother will send to you a replacement Machine with the understanding that you will, after receipt of the replacement Machine, supply the required proof of purchase information, together with the Machine that Brother agreed to replace. You are then expected to pack the Machine that Brother agreed to replace in the package from the replacement Machine and return it to Brother using the pre-paid freight bill supplied by Brother in accordance with the instructions provided by Brother. Since you will be in possession of two machines, Brother will require that you provide a valid major credit card number. Brother will issue a hold against the credit card account number that you provide until Brother receives your original Product and determines that your original Product is entitled to warranty coverage. Your credit card will be charged up to the cost of a new Product only if: (i) you do not return your original Product to Brother within five (5) business days; (ii) the problems with your original Product are not covered by the limited warranty; (iii) the proper packaging instructions are not followed and has caused damage to the product; or (iv) the warranty period on your original Product has expired or has not been sufficiently validated with a copy of the proof of purchase (bill of sale). The replacement Machine you receive (even if refurbished or remanufactured) will be covered by the balance of the limited warranty period remaining on the original Product, plus an additional thirty (30) days. You will keep the replacement Machine that is sent to you and your original Machine shall become the property of Brother. **Retain your original Accessory Items and a copy of the return freight bill, signed by the courier.**

**Limitations:**

Brother is not responsible for damage to or loss of any equipment, media, programs or data related to the use of the machine. Except for that repair or replacement as described above, Brother shall not be liable for any direct, indirect, incidental or consequential damages or specific relief. Because some states do not allow the exclusion or limitation of consequential or incidental damages, the above limitation may not apply to you.

THIS WARRANTY IS GIVEN IN LIEU OF ALL OTHER WARRANTIES, WRITTEN OR ORAL, WHETHER EXPRESSED BY AFFIRMATION, PROMISE, DESCRIPTION, DRAWING, MODEL OR SAMPLE. ANY AND ALL WARRANTIES OTHER THAN THIS ONE, WHETHER EXPRESS OR IMPLIED, INCLUDING IMPLIED WARRANTIES OF MERCHANTABILITY AND FITNESS FOR A PARTICULAR PURPOSE, ARE HEREBY DISCLAIMED.

- This Limited Warranty is the only warranty that Brother is giving for the machine. It is the *final expression and the exclusive and only statement* of Brother's obligations to you. It replaces all other agreements and understandings that you may have with Brother or its representatives.
- This warranty gives you certain rights and you may also have other rights that may vary from state to state.
- This Limited Warranty (and Brother's obligation to you) may not be changed in any way unless you and Brother sign the same piece of paper in which we (1) refer to the machine and your bill of sale date, (2) describe the change to this warranty and (3) agree to make that change.

**Important:**

We recommend that you keep all original packing materials, in the event that you ship the machine.

## Important Information

Should you have questions, or need information about your Brother Product, we have a variety of support options for you to choose from:

USA-Customer Service:  
Customer Service  
1-877-BROTHER (877-276-8437)

Customer Service  
1-901-379-1210 (fax)

World Wide Web  
[www.brother-usa.com](http://www.brother-usa.com)

Supplies / Accessories  
[www.brothermall.com](http://www.brothermall.com)  
or 1-877-552-MALL (6255)

**BROTHER INTERNATIONAL CORPORATION  
100 SOMERSET CORPORATE BLVD.  
BRIDGEWATER, NEW JERSEY 08807-0911**

Please record your model and serial number and your date and location of Purchase below for your records. Keep this information with your proof of purchase (bill of sale) in case your Product requires service.

Model # \_\_\_\_\_

Serial # \_\_\_\_\_

Date of purchase: \_\_\_\_\_

Store where purchased: \_\_\_\_\_

Location of store: \_\_\_\_\_

Important: We recommend that you keep all original packing materials, in the event you ship this product.

**Save Time - Register On-Line!**

Don't stand in line at the post office or worry about lost mail. Visit us on-line at  
**[www.registermybrother.com](http://www.registermybrother.com)**

Your product will immediately be registered in our database and you can be on your way!  
Also, while you're there, look for contests and other exciting information!

## INTRODUCTION

.....

## Contents

How to use the P-touch labeler .....	4
Safety Precautions .....	6
General Precautions .....	9
Symbols Used in this Guide .....	10
<b>GETTING STARTED .....</b>	<b>11</b>
Unpacking Your P-touch labeler .....	11
General Description .....	12
LCD Display & Keyboard .....	13
LCD Display .....	13
Key Names and Functions .....	14
Power Supply .....	16
Battery .....	16
AC Adapter .....	17
Inserting a Tape Cassette .....	18
Turning Power On/Off .....	19
Feeding Tape .....	20
Feed & Cut .....	20
Feed Only .....	20
LCD Display .....	21
LCD Contrast .....	21
Display Mode .....	21
Back Light .....	22
Setting Language and Unit .....	22
Language .....	22
Unit .....	22
<b>EDITING A LABEL .....</b>	<b>23</b>
Entering and Editing Text .....	23
Entering Text from the Keyboard .....	23
Using Text Reminder .....	23
Adding a New Line .....	24
Adding a New Block .....	24
Moving the Cursor .....	24
Inserting Text .....	24
Inserting a Tab .....	24
Deleting Text .....	25
Entering Symbols .....	26
Entering Symbols Using the Symbol Function .....	26
Using Symbol Update Function .....	27



.....	
Entering Accented Characters .....	29
Setting Character Attributes .....	30
Setting Character Attributes by Label .....	30
Setting Character Attributes by Each Line .....	30
Setting Auto Fit Style .....	34
Setting Label Attributes .....	35
Using Auto-Format Layouts.....	38
Using Templates - Example creating an Asset Tag.....	38
Using Block Layouts .....	42
Using Time & Date Function .....	45
Clock Setting .....	45
Time & Date Format Setting .....	46
Time Stamp Setting .....	47
[Timing] .....	47
[Time Stamp Format] .....	48
[Forward] .....	48
Creating a Bar Code Label .....	49
Setting Bar Code Parameters.....	50
Entering Bar Code Data.....	51
Editing and Deleting a Bar Code.....	52
<b>LABEL PRINTING.....</b>	<b>53</b>
Label Preview .....	53
Printing a Label .....	53
Printing a Single Copy .....	54
Printing Multiple Copies .....	54
Auto-numbering Labels.....	55
Mirror Printing .....	56
Tape Cutting Options .....	57
Adjusting the Label Length.....	58
Attaching Labels.....	59
Printing from the Label Collection .....	59
Printing a label from the Label Collection Stored in the Machine .....	59
Downloading a new Label Collection Category (Windows® only ).....	63
Downloading a Label Collection Category to your Labeler .....	63
Downloading a New Label Collection Category to P-touch Editor / Updating P-touch Editor Software.....	66

## INTRODUCTION

---

### USING THE FILE MEMORY ..... 68

---

Storing a Label into Memory .....	68
Opening a Stored Label File .....	68
Printing a Stored Label File .....	69
Deleting a Stored Label File .....	69

### MAINTAINING YOUR P-TOUCH LABELER ..... 70

---

Resetting the P-touch Labeler.....	70
Resetting data to factory settings (Downloaded data is not reset.) .....	70
Resetting data to factory settings (Downloaded data is reset.) .....	70
Maintenance.....	70
Cleaning the Unit .....	70
Cleaning the Print Head.....	70
Cleaning the Tape Cutter.....	71

### TROUBLESHOOTING ..... 72

---

What to do when.....	72
Error Messages.....	74

### APPENDIX ..... 78

---

Specifications .....	78
----------------------	----

### INDEX..... 79

---

## How to use the P-touch labeler

### ■ Create a label with the P-touch labeler

#### 1 | GETTING STARTED

- Prepare the P-touch labeler. **P. 11**

#### 2 | CREATING A LABEL

- Entering and Editing text. **P. 23**
- Entering Symbols. **P. 26**
- Entering Accented Characters. **P. 29**
- Using Auto-Format Layouts. **P. 38**



In addition to entering text, the P-touch labeler has a large range of formatting options.

Create labels like these :



#### 3 | LABEL PRINTING

- Printing a label. **P. 53**
- Tape Cutting Options. **P. 57**
- Printing from the Label collection. **P. 59**



Before printing, you can check the layout of your label using the preview function.

Create labels like these :



1

2

3

4

5

6

7

8

9

## INTRODUCTION

---

### ■ Create a label by connecting your labeler to a PC

#### 1 | GETTING STARTED

This labeler can be used as a stand alone desktop labeler or it can be connected to a PC/Mac and used with the included P-touch Editor software to create more elaborate labels.

To use your labeler connected to a computer, attach your labeler to a computer via the included USB cable and install the P-touch Editor software and drivers.

- Prepare the P-touch labeler.
- Prepare the PC.

[Software Installation Guide](#)

#### 2 | CREATING A LABEL

- Launch the P-touch Editor Software.
- Enter the label text using P-touch Editor.

[Software Help](#)

[Software Installation Guide](#)

Create labels like these:



#### 3 | LABEL PRINTING

- Print the label

[Software Help](#)



[Software Installation Guide](#)

### ■ Printing from the Label Collection









Using the Label Collection function, labels can be created easily by selecting and then printing designs already built into the machine.

## Safety Precautions

To prevent injury and damage, important notes are explained using various symbols. The symbols and their meanings are as follows:

 <b>WARNING</b>	Indicates a potentially hazardous situation which, if not avoided, could result in death or serious injuries.
 <b>CAUTION</b>	Indicates a potentially hazardous situation which, if not avoided, may result in minor or moderate injuries.







The symbols used in this manual are as follows:

	Action NOT allowed		DO NOT disassemble the product.
	DO NOT splash the product with or immerse the product in water.		DO NOT touch a given portion of the product.
	Mandatory action		Unplugging
	Safety alert		Alerts to the possibility of electrical shock

### WARNING

#### P-touch Labeler

Follow these guidelines to avoid fire, electric shock, the risk of injury and/or damage.

-  DO NOT allow the printer to get wet in any way.
-  DO NOT touch any metal parts near the print head. The print head becomes very hot during use and remains very hot immediately after use. Do not touch it directly with your hands.
-  DO NOT disassemble the P-touch labeler. For inspection, adjustment, and repair of the printer, contact the retail outlet where the P-touch labeler was purchased or your local authorized service center.
-  Plastic bags are used in the packaging of your printer. To avoid danger of suffocation, keep these bags away from babies and children.
-  Disconnect the AC adapter and remove batteries immediately and stop using when you notice abnormal odor, heat, discoloration deformation or anything unusual while using or storing it.
-  To prevent damage, do not drop or hit the P-touch labeler.
-  DO NOT use the P-touch labeler with a foreign object in it. If water, metallic substance or any foreign object enters the P-touch labeler, disconnect the AC adapter and remove batteries, and contact the retail outlet where the P-touch labeler was purchased or your local authorized service center.

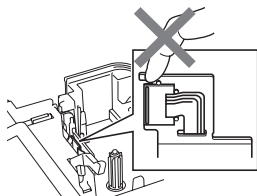

1

2

3

4

5

6

7

8

9

### **WARNING**









#### **Battery**

Follow these guidelines to avoid liquid leakage, heat, rupture of the battery and cause personal injury.

-  DO NOT throw into fire, heat up, short-circuit, recharge, or disassemble the battery

#### **AC adapter**

Follow these guidelines to avoid fire, damage, electric shock, failure or the risk of injury.

-  Always use the specified voltage (120V) and the suggested AC adapter. Failure to observe this may result in an accident or damage. Brother shall not assume any responsibility for any accident or damage resulting from not using the specified AC adapter, adapter cord and USB cable.
-  Don't connect the enclosed AC adapter, adapter cord, power plug and USB cable to other products.
-  Unplug the AC adapter cord immediately and stop using the P-touch labeler during an electrical storm. There may be a remote risk of electric shock from lightning.
-  DO NOT touch the AC adapter or power plug with wet hands.
-  DO NOT use the AC adapter in places of high humidity such as bathrooms.
-  DO NOT use a damaged adapter cord or power plug.
-  DO NOT place heavy objects on, damage or modify the adapter cord or plug. Do not forcibly bend or pull the adapter cord.
-  DO NOT drop, hit or otherwise damage the AC adapter.
-  Make sure that the plug is fully inserted in the power outlet. Do not use an outlet that is loose.

#### **Tape Cutter**

-  DO NOT touch the blade of the cutter unit.

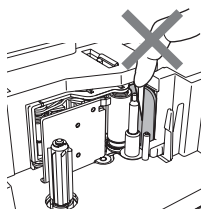

**⚠ CAUTION****Battery**

Follow these guidelines to avoid liquid leakage, heat or rupture of the battery .

- ⊘ DO NOT use old and new batteries together.
- ⊘ DO NOT mix alkaline batteries with other type batteries.
- ⊘ DO NOT set the positive and negative end in the wrong position.
- ⚠ Remove the batteries if you do not intend to use the P-touch labeler for an extended period of time.

**AC adapter**

- ⚠ If you do not intend using the P-touch labeler for an extended period of time, please disconnect the AC adapter from the power outlet.
- ⚠ Always hold the AC adapter when disconnecting from the power outlet.

**Tape Cutter**

Follow these guidelines to avoid minor personal injury and damage to the labeler printer.

- ⊘ DO NOT open the tape compartment cover when operating the cutter unit.
- ⊘ DO NOT apply excessive pressure to the cutter unit.

**P-touch Labeler**

Follow these guidelines to avoid minor personal injury and damage to the P-touch labeler.

- ⚠ Place the P-touch labeler on a flat, stable surface such as a desk.
- ⊘ DO NOT leave the P-touch labeler within reach of children with the tape compartment cover open.
- ⊘ DO NOT place any heavy objects on top of the P-touch labeler.
- ⊘ To prevent injuries, be careful not to put your fingers in the areas shown in the illustrations.

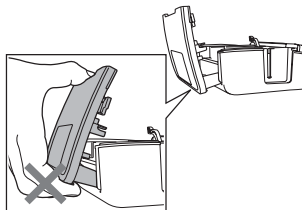

1

2

3

4

5

6

7

8

9



### General Precautions

- DO NOT install this machine near any device that will cause electromagnetic interference. This machine may malfunction if left near a television, radio, etc.
- DO NOT use the P-touch labeler in any way or for any purpose not described in this guide. Doing so may result in accidents or damage the machine.
- DO NOT put any foreign objects into the tape exit slot, AC adapter connector or USB port, etc.
- DO NOT touch the print head with your fingers. Use the optional print head cleaning cassette (TZ-CL4), the self-cleaning function of the printer or a soft wipe (e.g. a cotton swab) when cleaning the print head (refer to "Cleaning the Unit" on page 70.).
- DO NOT clean the machine with alcohol or other organic solvents. Only use a soft, dry cloth.
- DO NOT place the P-touch labeler in direct sunlight, near heaters or other hot appliances, in any location exposed to extremely high or low temperatures, high humidity, or dusty locations. Standard operating temperature range: 50°F to 95°F.
- DO NOT leave any rubber or vinyl on the printer for an extended period of time, otherwise the printer may be stained.
- Depending on the environmental conditions and the applied settings, some characters or symbols may be difficult to read.
- Use only Brother TZ tapes with this machine. Do not use tapes that do not have the  mark.
- DO NOT pull or apply pressure to the tape in the cassette. Otherwise the tape cassette or printer may be damaged.
- DO NOT try to print labels using an empty tape cassette or without a tape cassette set in the P-touch labeler. Doing so will damage the print head.
- DO NOT attempt to cut the tape while printing or feeding since this will damage the tape.
- It is recommended that you use the USB cable supplied with the P-touch labeler. Should another USB cable need to be used, ensure it is of high quality construction.
- Be careful not to scratch the CD-ROM. Do not place the CD-ROM in any location exposed to high or low temperatures. Do not place heavy objects on the CD-ROM or bend it.
- The software on the CD-ROM is intended for use with the P-touch labeler and may be installed on more than one PC.
- We strongly recommend that you read this User's Guide carefully before using your P-touch labeler, and then keep it nearby for future reference.
- Depending on the location, material, and environmental conditions, the label may peel or become irremovable, the color of the label may change or be transferred to other objects. Before applying the label, check the environmental condition and the material.
- DO NOT expose the tape cassettes to direct sunlight, high temperatures, high humidity, or dust. Store tape cassettes in a cool, dark place. Use the tape cassettes soon after opening the tape cassette package.
- Markings made with oil-based or water-based ink may be visible through a label affixed over them. To hide the markings, use two labels layered on top of each other or use a dark-colored label.
- Any data stored in memory will be lost due to failure or repair of the P-touch labeler, or if the battery expires.
- When power is disconnected for more than two minutes, all text and format settings will be cleared. Any text files stored in the memory and clock settings will also be cleared.
- Note that Brother Industries, Ltd does not assume responsibility for any damage, etc. arising from failure to follow the precautions listed.



## Symbols Used in this Guide

The following symbols are used throughout this guide to indicate additional information.

-  : This symbol indicates information or directions that may result in damage or injury if ignored, or operations that will result in errors.
-  : This symbol indicates information or directions that may help you understand and use the P-touch labeler more efficiently.

1

2

3

4

5

6

7

8

9

# GETTING STARTED

---

## Unpacking Your P-touch labeler

Check that the package contains the following before using your P-touch labeler.

### P-touch labeler PT-2730

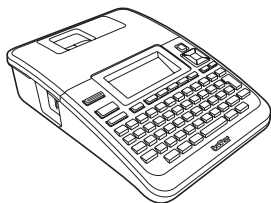

### Starter Tape Cassette

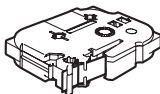

### CD-ROM



### USB cable

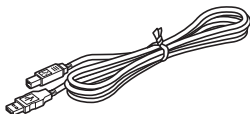

### AC adapter

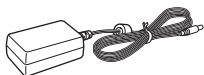

The plug may differ by countries.

### User's Guide

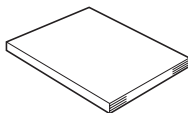

### Software Installation Guide

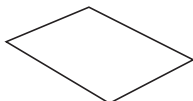

## General Description

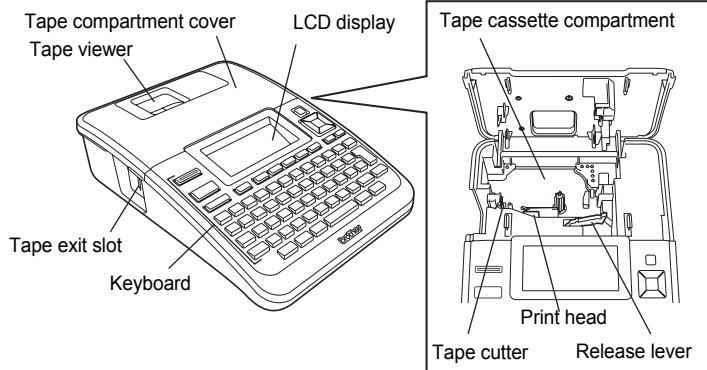

 When shipped from the factory, the LCD display is covered with a protective sheet to prevent damage. Remove this sheet before using the P-touch.

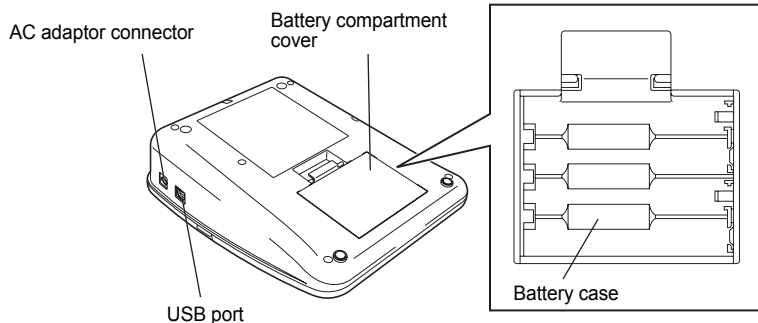

1

2

3

4

5

6

7

8

9

## LCD Display & Keyboard

### LCD Display

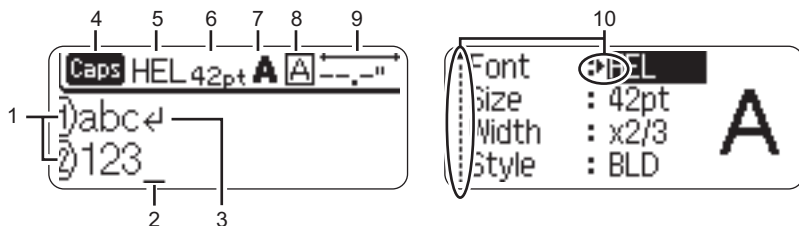

**1. Line number**

Indicates line number within the label layout.

**2. Cursor**

Characters are entered to the left of the cursor. Indicates the current data input position.

**3. Return mark**

Indicates the end of a line of text.

**4. Caps mode**

Indicates that the Caps mode is on.

**5.~8. Style guidance**

Indicates the current font (5), character size (6), character style (7) and frame (8) settings.

**9. Tape length**

Indicates the tape length for the text entered.

**10. Cursor selection**

Use the ▲ and ▼ keys to select menu items and the ◀ and ▶ keys to change the settings.



Refer to “LCD Display” on page 21 for changing the contrast and display mode, and for turning the back light on / off.

## Key Names and Functions

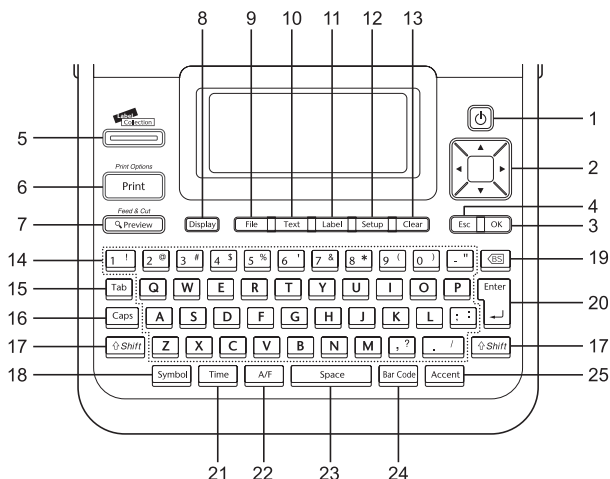

The default language is "English".

1. **Power**  
Turns the P-touch labeler on and off.
2. **Cursor (▲▼◀▶)**
  - Moves the cursor in the direction of the arrow.
  - Use the ▲ and ▼ keys to change clock settings.
3. **OK**  
Selects the displayed option.
4. **Escape**  
Cancels the current command and returns the display to the data entry screen or the previous step.
5. **Label Collection**  
Enables label collections to be selected and printed.
6. **Print**
  - Prints the current label design onto the tape.
  - Opens the Print Options menu when used in combination with the **Shift** key.
7. **Preview**
  - Displays a preview of the label.
  - Feeds 0.92" (23 mm) of blank tape and then automatically cuts the tape when used in combination with the **Shift** key.
8. **Display**  
Use this to change the display patterns of text entry screen and clock display.
9. **File**  
Enables frequently used labels in the file memory to be printed, opened, saved, or deleted.

1

2

3

4

5

6

7

8

9

## GETTING STARTED

---

### 10. **Text**

- Enables character attributes for the label to be set.
- Character attributes can be set for each line of the label when the Text menu is opened in combination with the **Shift** key.

### 11. **Label**

Enables label attributes for the label to be set.

### 12. **Setup**

Enables operating preferences (Bar Code, Time & Date, LCD Contrast, etc.) for the P-touch labeler to be set.

### 13. **Clear**

Clears all text entered, or all text and current label settings.

### 14. **Letter**

- Use these keys to type letters or numbers.
- Uppercase letters and symbols can be entered using these keys in combination with the **Caps** or **Shift** key.

### 15. **Tab**

Inserts a tab to the position of the cursor in the text entry screen.

### 16. **Caps**

Turns Caps mode on and off.

### 17. **Shift**

Use this key in combination with the letter and number keys to type uppercase letters or the symbols indicated on the number keys.

### 18. **Symbol**

Use this to select and enter a symbol from a list of available symbols.

### 19. **Backspace**

Deletes the character to the left of the cursor.

### 20. **Enter**

- Enters a new line when entering text.
- Enters a new block when used in combination with the **Shift** key.

### 21. **Time**

- Enters the selected date / time to the position of the cursor in the text entry screen.
- Clock display appears when used in combination with the **Shift** key.

### 22. **Auto-Format**

Enables labels to be created using pre-defined templates or block formats.

### 23. **Space**

- Enters a blank space.
- Returns a setting to the default value.

### 24. **Bar Code**

- Opens Bar Code Input screen.
- Opens Bar Code Setup screen when used with the **Shift** key.

### 25. **Accent**

Use this to select and enter an accented character.

## Power Supply

### Battery

- 1** After making sure that the power is off, remove the battery compartment cover on the back of the machine. If the batteries are already in the machine, remove them.

! Make sure that the power is turned off when replacing batteries.

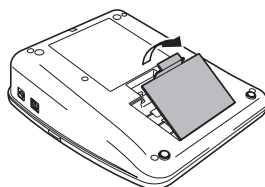

- 2** Insert eight new AA-size alkaline batteries (LR6), making sure that the positive (+) and negative (-) ends of the batteries match the positive (+) and negative (-) marks inside the battery compartment.

! Always replace all eight batteries at the same time using brand new ones.

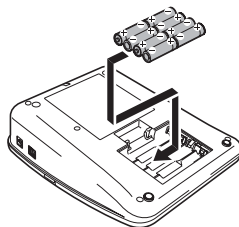

- 3** Attach the battery compartment cover by inserting the three hooks at the bottom into the slots on the machine, then pushing down firmly until it snaps into place.

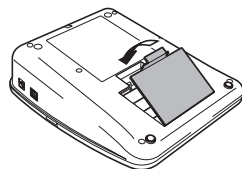

- !
- Remove the batteries if you do not intend to use the P-touch labeler for an extended period of time.
  - When power is disconnected for more than two minutes, all text and format settings will be cleared. Any text files stored in the memory and clock settings will also be cleared.

1

2

3

4

5

6

7

8

9

## GETTING STARTED

---

### AC Adapter

Connect the AC adapter directly to the P-touch labeler.

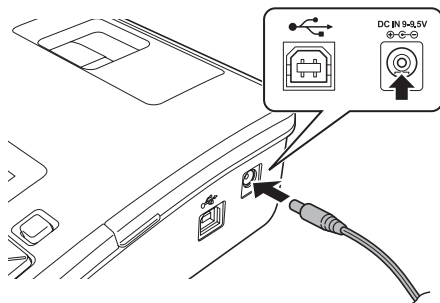

- 1 Insert the plug on the AC adapter cord into the connector marked DC IN 9-9.5V on the P-touch labeler.
- 2 Insert the AC adapter plug into a standard electrical outlet.



- Turn the P-touch labeler off before disconnecting the AC adapter.
- Do not pull or bend the AC adapter cord.



To safeguard and backup the labeler's memory and clock setting, when the AC adapter is unplugged it is recommended to have AA-size alkaline batteries (LR6) installed into the machine.

### WARNING

- Use only the adapter, which is designed exclusively for your P-touch. Failure to observe this may result in an accident or damage. Brother shall not assume any responsibility for any accident or damage resulting from not using the specified AC adapter.
- Do not connect the AC adapter to a non-standard electrical outlet. Failure to observe this may result in an accident or damage. Brother shall not assume any responsibility for any accident or damage resulting from not using a standard electrical outlet.

### CAUTION

- Disconnect the AC adapter from the P-touch and electrical outlet when you do not intend to use the P-touch for an extended period.
- When power is disconnected for more than two minutes, all text and format settings will be cleared. Any text files stored in the memory will also be cleared.



## Inserting a Tape Cassette

Tape cassettes of 0.13", 0.23", 0.35", 0.47", 0.70" or 0.94" (3.5mm, 6mm, 9mm, 12mm, 18mm, or 24mm) width can be used in your P-touch labeler. Use only Brother tape cassettes with the **TZ** mark.

- ❗ If the new tape cassette has a cardboard stopper, be sure to remove the stopper before inserting the cassette.
- If the ink ribbon is loose, use your finger to wind the toothed wheel in the direction of the arrow as shown on the tape cassette.

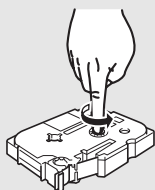
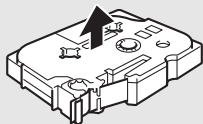

- 1 Check that the end of the tape is not bent and that it passes through the tape guide. If the tape is not passed through, pass it through the tape guide referring to the illustration.

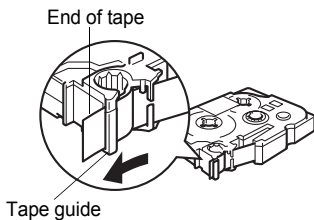

- 2 After making sure that the power is off, lift open the tape compartment cover. If there is already a tape cassette in the machine, remove it by pulling it straight up.



1

2

3

4

5

6

7

8

9

## GETTING STARTED

---

- 3** Insert the tape cassette into the tape compartment, with the end of the tape facing the machine's tape exit slot, and press firmly until you hear a click.

! When inserting the tape cassette, make sure that the tape and ink ribbon do not catch on the print head.

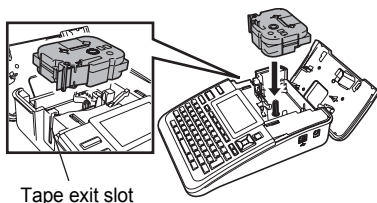

- 4** Close the tape compartment cover.

! Make sure that the release lever is up when closing the tape compartment cover. The tape compartment cover cannot be closed if the release lever is pressed down.



- !
- Be sure to feed tape to remove any slack in the tape and ink ribbon after inserting the tape cassette, by holding down the **Shift** key and pressing the **Preview** key.
  - **Do not pull the label coming out of the tape exit slot. Doing so will cause the ink ribbon to be discharged with the tape.**
  - Store tape cassettes in a cool dark location, away from direct sunlight and high temperature, high humidity, or dusty locations. Use the tape cassette as quickly as possible after opening the sealed package.

## Turning Power On/Off

Press the **Power** key to turn the P-touch labeler on.

Press the **Power** key again to turn the P-touch labeler off.

- 💡
- Your P-touch labeler has a power saving function that automatically turns itself off if no key is pressed within a certain time under certain operating conditions. Refer to the Auto Power-Off Time table below for details.
  - If the batteries are installed or the P-touch labeler is connected to an electrical outlet by the AC adapter, the previous session's information is displayed when the power is turned on.

### ● Auto Power-Off Time ●

	P-touch labeler only	Connected to PC
With AC adapter	8 hours	8 hours
With battery	5 minutes	No operation for 1 hour after connection to USB.

## Feeding Tape

### Feed & Cut

The Feed & Cut function feeds 0.92" (23mm) of blank tape then cuts the tape.

- ❗ • Be sure to feed tape to remove any slack in the tape and ink ribbon after inserting the tape cassette.
- **Do not pull the label coming out of the tape exit slot. Doing so will cause the ink ribbon to be discharged with the tape.**
- Do not block the tape exit slot during printing or when feeding tape. Doing so will cause the tape to jam.

- 1** | Hold down the **Shift** key and press the **Preview** key.  
"Feed & Cut?" will appear on the LCD display.
  - 2** | Using the **▲** or **▼** key to select the "Feed & Cut" option and then press either **OK** or **Enter**.  
The message "Feeding Tape... Please Wait" appears while the tape is fed, and then the tape is cut.
-  To exit or cancel this function press **Escape**.

### Feed Only

This function will advance the tape approximately 0.92" (23 mm) resulting in a blank label sticking out of the tape cassette. This action is recommended when using Fabric and Extra Strength Adhesive tapes, which should be cut using scissors.

- 1** | Hold down the **Shift** key and press the **Preview** key.  
"Feed & Cut?" will appear on the LCD display.
  - 2** | Using the **▲** or **▼** key to select the "Feed Only" option and then press either **OK** or **Enter** key.  
The message "Feeding Tape... Please Wait" appears while the tape is fed.
-  To exit or cancel this function press **Escape**.

1

2

3

4

5

6

7

8

9

## LCD Display

### LCD Contrast

You can change the contrast setting of the LCD display to one of five levels (+2, +1, 0, -1, -2) to make the screen easier to read. The default setting is "0".

- 1 Press the **Setup** key to display the Setup menu, select "LCD Contrast" using the ▲ or ▼ key, and then press the **OK** or **Enter** key.
- 2 Select a contrast level using the ▲ or ▼ key.  
The screen contrast changes each time you press the ▲ or ▼ key, allowing you to set the most suitable contrast.
- 3 Press the **OK** or **Enter** key.



- Press the **Escape** key to return to the previous step.
- Pressing the **Space** key on the contrast setting screen sets the contrast to the default value "0".

### Display Mode

You can change the display mode to your preferable style by pressing the **Display** key repeatedly. You can select from three text entry screens (guidance + 2 text lines, 3 text lines, guidance + 1 line) and clock display.

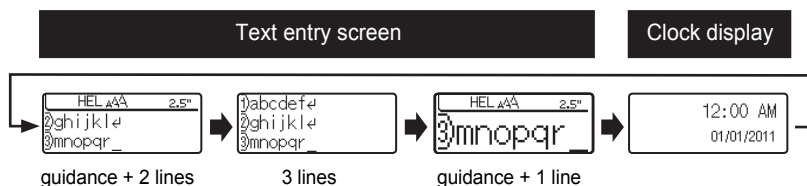

- You can also change the clock display to the text entry screen (guidance + 2 text lines) by pressing any other key on the keyboard besides the **Power** key.
- For adjusting the clock to current date and time, refer to "Clock Setting" on page 45.
- For selecting a desired format for displaying the date and time, refer to "Time & Date Format Setting" on page 46.

## Back Light

You can change the back light setting either to ON or OFF. The display is easier to see with the back light ON. The default setting is "ON".

- 1 Press the **Setup** key to display the Setup menu, select "Backlight" using the ▲ or ▼ key, and then press the **OK** or **Enter** key.
- 2 Select "ON" or "OFF" using the ▲ or ▼ key.
- 3 Press the **OK** or **Enter** key.

! Power can be saved when the back light is turned off.

## Setting Language and Unit

### Language

- 1 Press the **Setup** key to display the Setup menu, select "Language" using the ▲ or ▼ key, and then press the **OK** or **Enter** key.
- 2 Select a language for menu commands and messages shown on the LCD display by using the ▲ or ▼ key.  
The language can be selected from "Český", "Dansk", "Deutsch", "English", "Español", "Français", "Hrvatski", "Italiano", "Magyar", "Nederlands", "Norsk", "Polski", "Português", "Română", "Slovenski", "Slovenský", "Suomi", "Svenska" or "Türkçe".
- 3 Press the **OK** or **Enter** key.

💡 Press the **Escape** key to return to the previous step.

### Unit

- 1 Press the **Setup** key to display the Setup menu, select "Unit" using the ▲ or ▼ key, and then press the **OK** or **Enter** key.
- 2 Select a unit for dimensions shown on the LCD display by using the ▲ or ▼ key. Either "inch" or "mm" can be selected.
- 3 Press the **OK** or **Enter** key.

💡 The default setting is "inch".  
Press the **Escape** key to return to the previous step.

1

2

3

4

5

6

7

8

9

# EDITING A LABEL

---

## Entering and Editing Text

### Entering Text from the Keyboard

- The keyboard of your P-touch labeler can be used in the same way as a standard computer keyboard.

### Using Text Reminder

When a character is entered, the machine remembers character sequences beginning with the character entered from a history of all printed character sequences to date, and displays a list of options from which to select.

---

**1** Enter "c".

---

**2** The machine displays the last word printed beginning with the letter "c" such as "computer".

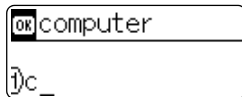

---

**3** Press the **OK** key to display other word options that match the entered character. Press the **▲** or **▼** key to select the desired word.

---

**4** Press the **OK** or **Enter** key.  
The selected character word will then appear on the text line.



- Text Reminder settings can be changed by pressing the **Setup** key.

### Deleting Text Reminder Memory

---

**1** Press the **Setup** key.

---

**2** Press the **▲** or **▼** key to select "Text Reminder", and then press the **OK** or **Enter** key.

---

**3** Press the **▲** or **▼** key to select "Clear Memory", and then press the **OK** or **Enter** key.

---

**4** "Clear All Text Reminder Memory ?" is then displayed.

---

**5** Press the **OK** or **Enter** key.  
All text options in memory will be deleted.

---

## Adding a New Line

- To end the current line of text and start a new line, press the **Enter** key. A return mark appears at the end of the line and the cursor moves to the start of the new line.

- ! • There is a maximum number of lines of text that can be entered for each tape width. A maximum of 7 lines can be entered for 0.94" (24mm) tape, 5 lines for 0.70" (18mm) tape, 3 lines for 0.47" (12mm) tape, 2 lines for 0.35" (9mm) and 0.23" (6 mm) tape, and 1 line for 0.13" (3.5mm) tape.
- If you press the **Enter** key when seven lines already exist, an error message is displayed.
  - To change the character attribute of each line, refer to "Setting Character Attributes by Each Line" on page 30.

## Adding a New Block

- To create a new block of text/lines to the right of your current text, press the **Enter** key while holding down the **Shift** key. A ¶ mark will appear at the end of the block and the cursor moves to the start of the new block.

- ! A maximum of 5 blocks can be entered in one label.

## Moving the Cursor

- Press the ▲, ▼, ◀ or ▶ key to move the cursor one space or line.
- To move the cursor to the beginning or end of the current line, hold down the **Shift** key and then press the ◀ or ▶ key.
- To move the cursor to the very beginning or end of the text, hold down the **Shift** key and then press the ▲ or ▼ key.

## Inserting Text

- To insert additional text into an existing line of text, move the cursor to the character to the right of the position where you want to start inserting text and then enter the additional text. The new text is inserted to the left of the cursor.

## Inserting a Tab

- To insert a tab space between the existing line of text, move the cursor where you wish to add a tab and press the **Tab** key. A ¶ mark appears to indicate the position which the tab space will be entered.

- 💡 • To change the length setting of the tab, refer to "Setting Label Attributes" on page 35.
- The tab space can also be entered by pressing the **Setup** key to open the Setup menu and selecting "Tab" by using ▲ or ▼ key, and then pressing the **OK** or **Enter** key.

1

2

3

4

5

6

7

8

9

## EDITING A LABEL

---

### Deleting Text

#### ■ Deleting one character at a time

- To delete a character from an existing line of text, move the cursor to the character to the right of the position you want to start deleting text and then press the **Backspace** key. The character to the left of the cursor is deleted each time the **Backspace** key is pressed.



If you hold down the **Backspace** key, the characters left of the cursor are deleted continuously.

#### ■ Deleting all text at once

Use the **Clear** key to delete all text at once.

- 1** Press the **Clear** key.  
The Clear options are displayed.

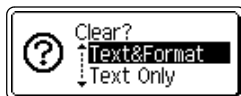

- 2** Using the **▲** or **▼** key, select "Text Only" to delete all text while retaining the current format settings, or select "Text & Format" to delete all text and format settings.

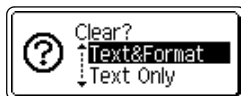

Press the **Escape** key to return to the text entry screen, without erasing (or clearing) text or format.

- 3** Press the **OK** or **Enter** key.  
All text is deleted. All format settings are also deleted if Text & Format was selected.

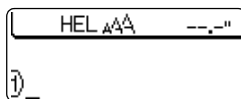



---

## Entering Symbols

In addition to the symbols available on the keyboard, there are various symbols (including international and extended ASCII characters) available with the symbol function.

To enter a symbol, use the Symbol function (see below).

Alternatively, hold down the **Shift** key and then press a key on the keyboard to enter the symbol printed on the selected key's upper-right corner.

### Entering Symbols Using the Symbol Function

---

- 1 Press the **Symbol** key.  
A list of symbol categories and symbols in that category is displayed.



The last symbol entered is selected in the displayed list.

---

- 2 Select a symbol category (Punctuation, Business, Mathematics, etc.) using the ▲ or ▼ key or by pressing the **Symbol** key repeatedly, and then select a symbol using the ◀ or ▶ key.
- 

- 3 Press the **OK** or **Enter** key.  
The selected symbol is inserted into the line of text.
- 



- Press the **Escape** key to return to the previous step.
- 

1

2

3

4

5

6

7

8

9

## EDITING A LABEL

---

### Using Symbol Update Function

You can create your personal category of symbols by using the Symbol Update Function. The "Personal category" will appear first when selecting the symbols to help you locate the desired symbols quickly.

- 1** Press the **Setup** key to display the Setup menu, and then select "Symbol Update" using the  $\blacktriangle$  or  $\blacktriangledown$  key.



- 2** Press the **OK** or **Enter** key to display the Symbol Update screen, and then select "On" to create your personal category by using the  $\blacktriangle$  or  $\blacktriangledown$  key.

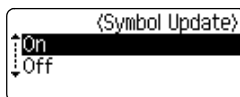

- 3** Press the **OK** or **Enter** key to apply the setting. The screen returns to the text entry screen.

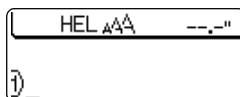

- 4** Enter the symbol you wish to add to your personal Category.



Refer to "Entering Symbols Using the Symbol Function" on page 26 for detail.

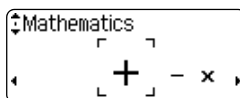

- 5** Press the **Symbol** key. The "Personal category" appears, including the symbol entered in step 4.

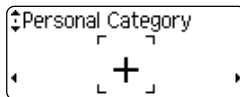

- Up to 20 symbols can be added to the "Personal category". The oldest symbol will be deleted from the category when the symbols added to the "Personal category" exceed 20 symbols.
- To stop using the Symbol Update Function, select "Off" in the Symbol Update screen.



## Entering Accented Characters

The P-touch labeler can display and print a set of accented characters such as other language specific characters.

- 1 Enter the character you wish to change to an accented character.



Caps mode can be used with the Accent function.

- 2 Press the **Accent** key.  
The character you entered will change to an accented character.

- 3 Press the **Accent** key repeatedly until the desired accented character is selected, or select it by using the ◀ or ▶ key.



The order of accented characters displayed will differ depending on the selected LCD language.

- 4 Press the **OK** or **Enter** key.  
The selected accented character is inserted into the line of text.



- Press the **Escape** key to return to the previous step.
- Refer to the Accented Character List table for a complete list of all accented characters available.

### ● Accented Character List ●

Character	Accented Characters	Character	Accented Characters
a	á à â ã ä å ã ä å ã	ñ	ñ ñ ñ ñ
A	Á Â Ã Ä Å Æ Å Å Å Å Å	N	Ñ Ñ Ñ Ñ
c	ç ç ç	o	ó ò ô ø ö õ œ ö
C	Ç Ç Ç	O	Ó Ô Õ Ø Ö Õ Æ Ó
d	d' ð d	r	ř r r
D	Ð Ð	R	Ř Ř Ř
e	é è ê ë ù é è ë	s	š š š š ß
E	É Ê Ë Ì Í Î Ï	S	Š Š Š Š ß
g	g' g	t	ť t t
G	Ĝ Ĝ	T	Ť Ť Ť
i	í î ï ï ï ï ï	u	ú û ü ü ü ü ü
I	Í Î Ï Ï Ï Ï Ï	U	Ú Û Ü Ü Ü Ü Ü
k	k	y	ý ŷ
K	Ɔ	Y	Ÿ Ÿ
l	l' l' l'	z	ž ž ž
L	Ł Ł Ł Ł	Z	Ž Ž Ž

## Setting Character Attributes

### Setting Character Attributes by Label

Using the **Text** key, you can select a font and apply size, width, style, line, and alignment attributes.

- 1 Press the **Text** key.  
The current settings are displayed.
- 2 Select an attribute using the **▲** or **▼** key, and then set a value for that attribute using the **◀** or **▶** key.
- 3 Press the **OK** or **Enter** key to apply the settings.



New settings are NOT applied if you do not press the **OK** or **Enter** key.

- Press the **Escape** key to return to the previous step.
- Press the **Space** key to set the selected attribute to the default value.
- Refer to the Setting Options table for a list of all available settings.
- Small characters may be difficult to read when certain styles are applied (e.g. Shadow + Italic).

### Setting Character Attributes by Each Line

When a label consists two or more lines of text, you can set different value of character attributes (font, size, width, style, line and alignment) for each line.

Move the cursor to the line you wish to change the character attribute by using the **▲** or **▼** key. Next, press the **Text** key while holding down **Shift** key to display the attributes. ( **A** on the screen indicates that you are now applying the attribute for that specific line only.)

Font	▶ HEL	☰
Size	: Auto	A
Width	: x 1	
Style	: Normal	



When different value of attribute is set for each line, the value will be displayed as \*\*\*\* when you press the **Text** key. When you change the setting on this screen by using the **▲** or **▼** key, the same change will be applied to all lines of the label.

Font	▶ *****
Size	: 36pt
Width	: x 1
Style	: Normal

1

2

3

4

5

6

7

8

9

● Setting Options ●

Attribute	Value	Result
Font	HEL (Helsinki)	ABCabc
	BRU (Brussels)	ABCabc
	US (USA)	ABCabc
	FLO (Florida)	<b>ABCabc</b>
	BEL (Belgium)	A <sup>B</sup> Cabc
	SGO (San Diego)	<b>ABCabc</b>
	LA (Los Angeles)	<b>ABCabc</b>
	CAL (Calgary)	<i>A<sup>B</sup>Cabc</i>

Attribute	Value	Result
Size	<b>Auto</b>	When Auto is selected, the text is automatically adjusted to print in the largest size available for each tape width.
	48pt	<b>ABCabc</b>
	42pt	<b>ABCabc</b>
	36pt	<b>ABCabc</b>
	24pt	ABCabc
	18pt	ABCabc
	12pt	ABCabc
	9pt	ABCabc
	6pt	ABCabc
Width	x2	<b>ABCabc</b>
	x3/2	<b>ABCabc</b>
	x1	ABCabc
	x2/3	ABCabc
	x1/2	ABCabc

1

2

3

4

5

6

7

8

9

## EDITING A LABEL

Attribute	Value	Result
Style	Normal	ABCabc
	BLD (Bold)	<b>ABCabc</b>
	OUT (Outline)	ABCabc
	SHD (Shadow)	ABCabc
	SLD (Solid)	<b>ABCabc</b>
	ITL (Italic)	<i>ABCabc</i>
	I+BLD (Italic Bold)	<b><i>ABCabc</i></b>
	I+OUT (Italic Outline)	ABCabc
	I+SHD (Italic Shadow)	ABCabc
	I+SLD (Italic Solid)	<b><i>ABCabc</i></b>
	VRT (Vertical)	◀ m U ∞ Ω ∪
Line	off	ABCabc
	UND (Underline)	<u>ABCabc</u>
	STR (Strikeout)	<del>ABCabc</del>



Attribute	Value	Result
Align (Alignment)	Left	ABCabc
	Center	ABCabc
	Right	ABCabc
	Just (Justify)	A B C a b c

### Setting Auto Fit Style

When "Size" is set to "Auto" and "Length" is set to a specific length, you can select the way of reducing the text size to fit within the label length.

When "Text Size" is selected, the total text size is modified to fit within the label.

When "Text Width" is selected, the text width will be reduced to the size of x1/2 setting. (If further size reduction is required to fit the text into the selected label length, the total text size will be modified after reducing the text width to x1/2 setting.)

- 1** Press the **Setup** key to display the Setup menu. Select "Auto Fit Style" using the **▲** or **▼** key, and then press the **OK** or **Enter** key. The Auto Fit Style screen is displayed.
- 2** Select the style using the **▲** or **▼** key.
- 3** Press the **OK** or **Enter** key to apply the setting.



- Press the **Escape** key to return to the previous step.
- Press the **Space** key to set the style to the default setting ("Text Size").

1

2

3

4

5

6

7

8

9

### Setting Label Attributes

Using the **Label** key, you can create a label with a frame around the text and specify the label length and tab length. (Cut Options which may be needed when printing a label can also be set by using the **Label** key. Refer to “Tape Cutting Options” on page 57.)

- 1** Press the **Label** key.  
The current settings are displayed.

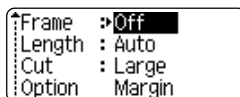

- 2** Select an attribute using the **▲** or **▼** key, and then set a value for that attribute using the **◀** or **▶** key.



- When setting the tab length, hold down the **◀** or **▶** key to change the value faster.
- When setting the label length, refer to “Adjusting the Label Length” on page 58

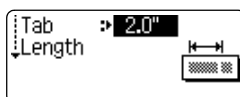

- 3** Press the **OK** or **Enter** key to apply the settings.





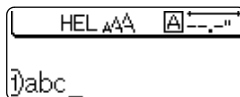







New settings are NOT applied if you do not press the **OK** or **Enter** key.

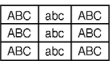

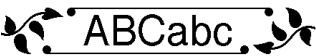
- Press the **Escape** key to return to the previous step.
- Press the **Space** key to set the selected attribute to the default value.
- Refer to the Setting Options table for a list of all available settings.

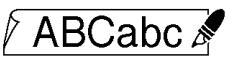
## ● Frames ●

Attribute	Value	Result
Frame	Off	ABCabc
	1	
	2	
	3	
	4	
	5	
	6	
	7	
	8	
	9	
	10	
	11	
12		

1

2

3

4

5









6

7

8

9

## EDITING A LABEL

Attribute	Value	Result
Frame	13	
	14	
	15	
	16	
	17	
	18	
	19	
	20	
Length	The length of the label can be set within the range 1.2" (30mm) - 12.0" (300mm). When <b>Auto</b> is selected, the length of the label is automatically adjusted based on the amount of text entered.	
Tab Length	The length of the tab can be set within the range 0.0" (0mm) - 4.0"(100mm). The default setting is <b>2.0" (50mm)</b> .	

## Using Auto-Format Layouts

Using the Auto-Format function you can quickly and easily create labels for a variety of purposes, such as file tabs, equipment labels, name badges, etc. Simply select a layout from the templates or block layouts, enter the text and apply formatting as desired.

 Symbols and accented characters can also be used in auto-format layouts.

### Using Templates - Example creating an Asset Tag

**1** Press the **Auto-Format** key to display the Auto-Format screen, and then select "Templates" using the **▲** or **▼** key.

**2** Press the **OK** or **Enter** key.  
The last template used is displayed.

**3** Select a template using the **▲** or **▼** key.

**4** Press the **OK** or **Enter** key.  
The Style screen is displayed.

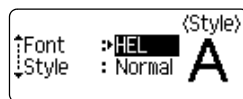

**5** Select an attribute using the **▲** or **▼** key, and then set a value for that attribute using the **◀** or **▶** key.



**6** Press the **OK** or **Enter** key.  
The Bar Code Setup screen is displayed.

 The Bar Code Setup screen is displayed only when a layout containing a bar code is selected.

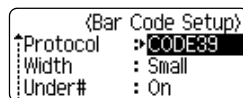

**7** Select an attribute using the **▲** or **▼** key, and then set a value for that attribute using the **◀** or **▶** key.

 The "C-Digit" (Check Digit) attribute is only available for the CODE39, I-2/5 and CODABAR protocols.

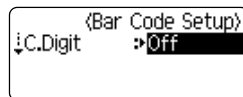

**8** Press the **OK** or **Enter** key.  
The template text entry screen is displayed.

 • Caps mode can be used when entering text.

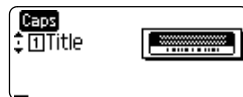

1

2

3

4

5

6

7

8

9

## EDITING A LABEL

---

- 9** Enter the text and then press the **OK** or **Enter** key. Repeat this for each text field. After all text fields are entered, the print menu is displayed when the **OK** or **Enter** key is pressed.

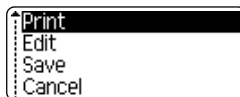

- 10** Select "Print" using the **▲** or **▼** key and then press the **OK** or **Enter** key to print the label.



- Select "Edit" to change the text data or style settings.
- Select "Save" to store the label in a file memory.
- Select "Cancel" to exit the Auto-Format function.
- Select "Print Options" to set the print settings.









- Press the **Escape** key to return to the previous step.
- On the Style and Bar Code Setup screens, press the **Space** key to change the selected attribute to the default value.
- Refer to the Templates table for a list of available templates.
- To print multiple copies, sequentially numbered copies, or a mirror image of the label, with the print menu displayed hold down the **Shift** key and press the **Print** key to display the Print Options menu.

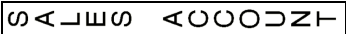
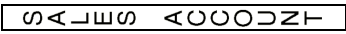

- If the width of the current tape cassette does not match the set width for the selected layout, an error message is displayed when you try to print the label. Press the **Escape** key or any other key to clear the error message, and insert a tape cassette of the correct width.
- If the number of characters entered exceeds the limit, "Text Too Long!" is displayed when the **OK** or **Enter** key is pressed. Press the **Escape** key or any other key to clear the error message, and edit the text using fewer characters.
- When using the Auto-Format function the label is cut with a margin on the left and right ends regardless of the current Tape Cutting Option setting (refer to page 57).
- Cutting is disabled when "Cut Option" is set to Special Tape.

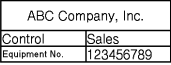
## ● Templates ●

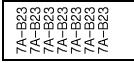
Attribute	Value	Details
Template Name	Binder Spine 1	 (0.94" x 8.6" [24 mm x 219 mm])
	Binder Spine 2	 (0.70" x 8.6" [18mm x 219mm])
	File Folder Tab	 (0.47" x 3.2" [12 mm x 82 mm])
	Divider Tab (Hanging Folder)	 (0.47" x 1.6" [12 mm x 42 mm])
	Asset Tag	 (0.70" x 2.7" [18 mm x 70 mm])
	Bin Box	 (0.70" x 3.0" [18 mm x 76 mm])
	Equipment Label	 (0.94" x 2.2" [24 mm x 58 mm])
	Faceplate (VRT)	 (0.47" x 2.7" [12 mm x 70 mm])
	Cable Wrap 1	 (0.94" x 1.5" [24 mm x 39 mm])
Cable Wrap 2	 (0.70" x 1.5" [18 mm x 39 mm])	

1

2

3

4

5







6

7

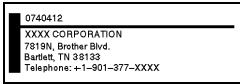
8

9

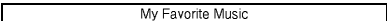
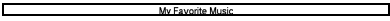
## EDITING A LABEL

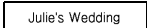
Attribute	Value	Details
Template Name	Address Label 1	 <p>(0.94" x 2.7" [24 mm x 70 mm])</p>
	Address Label 2	 <p>(0.7" x 2.7" [18 mm x 70 mm])</p>
	Name Badge 1	 <p>(0.94" x 2.8" [24 mm x 72 mm])</p>
	Name Badge 2	 <p>(0.70" x 2.8" [18 mm x 72 mm])</p>
	Name Badge 3	 <p>(0.47" x 2.8" [12 mm x 72 mm])</p>
	CD Case Spine 1	 <p>(0.23" x 4.4" [6 mm x 113 mm])</p>
	CD Case Spine 2	 <p>(0.13" x 4.4" [3.5 mm x 113 mm])</p>
	VHS Spine	 <p>(0.70" x 5.5" [18 mm x 140 mm])</p>
	MiniDV Spine	 <p>(0.35" x 1.6" [9 mm x 42 mm])</p>



## Using Block Layouts

- 1 Press the **Auto-Format** key to display the Auto-Format screen, and then select "Block Layouts" using the ▲ or ▼ key.
- 2 Press the **OK** or **Enter** key to display the Tape Width screen, and then select a tape width using the ▲ or ▼ key.
- 3 Press the **OK** or **Enter** key.  
When the tape width has not changed, the last block layout selected is displayed.  
When the tape width has changed, the default layout for the new tape width is displayed.

- 4 Select a block layout using the ▲ or ▼ key.

- 5 Press the **OK** or **Enter** key.  
The Style screen is displayed.

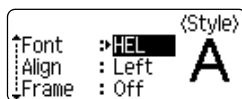

- 6 Select an attribute using the ▲ or ▼ key, and then set a value for that attribute using the ◀ or ▶ key.



Press the **Space** key to set the selected attribute to the default value.

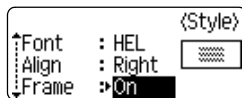

- 7 Press the **OK** or **Enter** key.  
The block layout text entry screen is displayed.



- Caps mode can be used when entering text.
- The "Text Reminder" function (predictive text) is also enabled when entering text with the Auto-Format function. Refer to "Entering and Editing Text" on page 23 for details on predictive text.

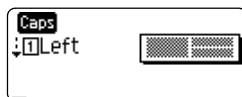

- 8 Enter text and then press the **OK** or **Enter** key.  
Repeat for each text field.  
After all text fields are completed, press the **OK** or **Enter** key to display the print menu.

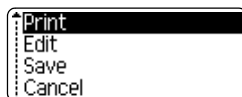

- 9 Select "Print" using the ▲ or ▼ key and then press the **OK** or **Enter** to print the label.



- Select "Edit" to change the text data or style settings.
- Select "Save" to store the label in a file memory.
- Select "Cancel" to exit the Auto-Format function.
- Select "Change Layout" to use a different layout.
- Select "Print Options" to set the print settings.

1

2

3

4

5

6

7

8

9

## EDITING A LABEL













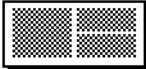
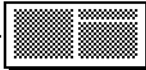





- Press the **Escape** key to return to the previous step.
- Refer to the Block Layouts table for a list of available block layouts.
- To print multiple copies, sequentially numbered copies, or a mirror image of the label, with the print menu displayed hold down the **Shift** key and press the **Print** key to display the Print Options menu.

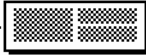

- If the width of the current tape cassette does not match the set width for the selected layout, an error message is displayed when you try to print the label. Press the **Escape** key or any other key to clear the error message, and insert a tape cassette of the correct width.
- If the number of characters entered exceeds the limit, "Text Too Long!" is displayed when the **OK** or **Enter** key is pressed. Press the **Escape** key or any other key to clear the error message, and edit the text using fewer characters.
- When using the Auto-Format function the label is cut with a margin on the left and right ends regardless of the current Tape Cutting Option setting (refer to page 57).
- Cutting is disabled when "Cut Option" is set to Special Tape.

### ● Block Layouts ●

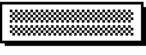
Attribute	Value	Details
Block layout (0.94" [24mm] tape)	2LineA	 ... 12pt ... 36pt
	2LineB	 ... 36pt ... 12pt
	3 Line	 ... 12pt ... 12pt ... 24pt
	1+2Line A	48pt...  ... 24pt ... 24pt
	1+2Line B	48pt...  ... 12pt ... 36pt
	1+3Line	48pt...  ... 12pt ... 12pt ... 24pt
	1+4Line	48pt...  } ... 12pt
	1+5Line	48pt...  } ... 9pt

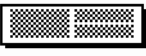
Attribute	Value	Details
Block layout (0.70" [18 mm] tape)	<b>2LineA</b>	 ..... 12pt ..... 24pt
	2LineB	 ..... 24pt ..... 12pt
	3Line	 ..... 9pt ..... 9pt ..... 24pt
	1+2LineA	42pt...  ..... 18pt ..... 18pt
	1+2LineB	42pt...  ..... 12pt ..... 24pt
	1+3Line	42pt...  ..... 12pt
	1+4Line	42pt...  ..... 9pt
	1+5Line	42pt...  ..... 9pt
Block layout (0.47" [12 mm] tape)	<b>2LineA</b>	 ..... 9pt ..... 12pt
	2LineB	 ..... 12pt ..... 9pt
	3Line	 ..... 6pt ..... 6pt ..... 12pt
	1+2Line	24pt...  ..... 12pt ..... 12pt

1

2

3

4

5





6

7

8

9

## EDITING A LABEL

Attribute	Value	Details
Block layout (0.35" [9 mm] tape)	2LineA	
	2LineB	
	1+2Line	18pt... 
Block layout (0.23" [6 mm] tape)	1+2Line	12pt... 

## Using Time & Date Function

You can add time and date to your label by positioning the cursor on the text screen to the position you wish to add time/date and then pressing the **Time** key.

### Clock Setting

The time and date set in the clock setting can be used for the display on the screen, and also for using the Time & Date function which you can add time/date to your label in desired format.

- 1 Press the **Setup** key to display the Setup menu, select "Set Clock" using the ▲ or ▼ keys, and then press the **OK** or **Enter** key.

- 2 The Set Clock screen is displayed.  
Set the year, month, date, hour and minute to the current figure using the ▲ or ▼ key. To move to the next parameter, use the ◀ or ▶ key.

(Set Clock)  
YYYY/MM/DD hh:mm  
2011 / 01 / 01 12:00 AM

 You can also use the Num keys to type in the figure.

- 3 Press the **OK** or **Enter** key to apply the settings.



- Press the **Escape** key to return to the previous step.
- Press the **Space** key to set the format to default setting.
- The clock will activate from when the clock setting is applied.
- For the backup of clock setting, when the AC adapter is unplugged, please use AA-size alkaline batteries.

## Time & Date Format Setting

You can select from various formats of date and time to add to your label. Also, the indication of time can be selected between analog and digital style. The format applied in this setting will also be applied for the clock display which appears on the screen when you press the **Display** key. (Refer to "Display Mode" on page 21 for detail.)

- 1 Press the **Setup** key to display the Setup menu, select "Time & Date Format" using the ▲ or ▼ key, and then press the **OK** or **Enter** key.
- 2 The Time & Date Format screen is displayed. Select date or time using the ▲ or ▼ key, and then set the format using the ◀ or ▶ key.
- 3 Press the **OK** or **Enter** key to apply the settings.



New settings are not applied if you do not press the **OK** or **Enter** key.



- Press the **Escape** key to return to the previous step.
- Press the **Space** key to set the format to default setting.
- Refer to the Format Options for a list of all available formats.

### ● Time & Date Format Options ●

Attribute	Value
D (Date)	12/31/2099
	12.31.2099
	12-31-2099
	December 31, 2099
	Dec. 31, 2099
	2099/12/31
	2099-12-31
	31/12/2099
	31.12.2099
	31-12-2099
	31. December 2099
	31. Dec. 2099

1

2

3

4

5

6

7

8

9

## EDITING A LABEL

---

Attribute	Value
T (Time)	11:59 PM
	23:59



The date and time used for the value is a sample setting. When a format is selected, the date and time set in the clock setting will appear in the selected format style.

### Time Stamp Setting

#### [Timing]

You can select whether to print the date/time of when you press the **Time** key or the date/time of when you press the **Print** key to add to your label.

- 1 Press the **Setup** key to display the Setup menu, select "Time Stamp Setting" using the **▲** or **▼** key, and then press the **OK** or **Enter** key.
- 2 Select "Timing" using the **▲** or **▼** key, and then select the value for the setting using the **◀** or **▶** key.
- 3 Press the **OK** or **Enter** key to apply the settings.



- Press the **Escape** key to return to the previous step.
- Press the **Space** key to set the format to default setting.
- Refer to the Time Stamp: Timing Options for available settings.

#### ● Time Stamp : Timing Options ●

Attribute	Value	Description
Timing	Auto	Press the <b>Time</b> key; a clock icon will be inserted where the cursor is positioned on the text input screen. When you press the <b>Print</b> key, the latest date/time will be printed on the label where the clock icon is positioned on the label layout.
	Fixed	Press the <b>Time</b> key; the current date/time will be inserted where the cursor is positioned on the text input screen. When you press the <b>Print</b> key, the date/time will be printed as shown on the input screen.



When "Auto" is selected for the Timing setting and a clock icon is added to the text by pressing the **Time** key, you can confirm what settings applied for the icon by positioning the cursor under the clock icon, and then pressing the **Time** key.

**[Time Stamp Format]**

You can select which information to use when adding date and time to your label. Four options (Date, Time, Date and Time or Time and Date) are available.

- 1** Press the **Setup** key to display the Setup menu, select "Time Stamp Setting" using the ▲ or ▼ key, and then press the **OK** or **Enter** key.
- 2** Select "Format" using the ▲ or ▼ key, and then select the value for the setting using the ◀ or ▶ key.
- 3** Press the **OK** or **Enter** key to apply the settings.



- Press the **Escape** key to return to the previous step.
- Press the **Space** key to set the value to default setting.
- Refer to the Time Stamp: Format Options for available settings.

● **Time Stamp : Format Options** ●

Attribute	Value	Description
Format	Date	Date only will be printed on the label.
	Date & Time	The date and time will be printed on the label.
	Time	Time only will be printed on the label.
	Time & Date	The time and date will be printed on the label.

**[Forward]**

You can select whether to use a forwarded (future) date and time or the current date and time when using the Time & Date Function.

- 1** Press the **Setup** key to display the Setup menu, select "Time Stamp Setting" using the ▲ or ▼ key, and then press the **OK** or **Enter** key.
- 2** Select "Forward" using the ▲ or ▼ key, and then to specify the amount of date and time to increase, select "On" using the ◀ or ▶ key.

1

2

3

4

5

6

7

8

9

## EDITING A LABEL

---

- 3** Press the **OK** or **Enter** key. The Forward screen is displayed. Set the amount of year, month, week, day, hour, and minute to increase from the currently set clock when using the Time & Date function using the **▲** or **▼** key. To move to the next parameter, use the **◀** or **▶** key.

{Forward}

YY/MM/WW/DD/hh/mm  
00 00 02 000 00 000



You can also use the Num keys to type in the figure.

- 4** Press the **OK** or **Enter** key to apply the settings.



- Press the **Escape** key to return to the previous step.
- Press the **Space** key to set the format to default setting.
- Refer to the Time Stamp: Forward Options for a list of all available formats.

### ● Time Stamp : Forward Options ●

Attribute	Value	Description
Forward	On	The time/date will be increased according to the value selected in the Forward setting.
	Off	Current time/date will be printed.

## Creating a Bar Code Label

Using the Bar Code function you can create labels with one dimensional bar codes for use with cash registers, stock control systems or other bar code reader systems, or even asset control tags used in an asset management system.



- The P-touch labeler is not designed exclusively for creating bar code labels. Always check that bar code labels can be read by the bar code reader.
- For best results, print bar code labels in black ink on white tape. Some bar code readers may not be able to read bar code labels created using colored tape or ink.
- Use the “Large” setting for “Width” whenever possible. Some bar code readers may not be able to read bar code labels created using the “Small” setting.
- Continuously printing a large number of labels with bar codes can overheat the print head, which may affect printing quality.



## Setting Bar Code Parameters

- 1 Press the **Setup** key to display the Setup menu, select "Bar Code Setup" using the ▲ or ▼ key, and then press the **OK** or **Enter** key.  
The Bar Code Setup screen is displayed.

 Pressing **Bar Code** key while holding down the **Shift** key will also allow you to go to "Bar Code Setup".

- 2 Select an attribute using the ▲ or ▼ key, and then set a value for that attribute using the ◀ or ▶ key.

 Characters may not appear below the bar code even when "On" is selected for "Under #", depending on the tape width being used, the number of lines entered, or the current character style settings.

- 3 Press the **OK** or **Enter** key to apply the settings.

 • New settings are NOT applied if you do not press the **OK** or **Enter** key.

-  • The "C-Digit" (Check Digit) attribute is only available for the CODE39, I-2/5 and CODABAR protocols
- Press the **Escape** key to return to the previous step.
  - Press the **Space** key to set the selected attribute to the default value.
  - Refer to the Bar Code Settings table for a list of all available settings.

### ● Bar Code Settings ●

Attribute	Value
Protocol	<b>CODE39</b> , CODE128, EAN-8, EAN-13, GS1-128 (UCC / EAN-128), UPC-A, UPC-E, I-2/5 (ITF), CODABAR
Width	<b>Small</b>
	Large
Under# (characters printed below bar code)	<b>On</b>
	Off
C.Digit (check digit)	<b>Off</b>
	On (only available for the CODE39, I-2/5 and CODABAR protocols)

1

2

3

4

5

6

7

8

9

### Entering Bar Code Data

- 1 Press the **Bar Code** key.  
The Bar Code Input screen is displayed.

 Up to five bar codes can be entered on a label.

- 2 Type in the bar code data.  
Special characters can be entered in the bar code when using the CODE39, CODABAR, CODE128 or GS1-128 (UCC / EAN-128) protocols. When not using special characters, go to step 5.

(Bar Code Input)  
CODE39  
▶\*2010\*◀

- 3 Press the **Symbol** key.  
A list of characters available for the current protocol is displayed.

- 4 Select a character using the ▲ or ▼ key, then press the **OK** or **Enter** key to insert the character in the bar code data.

(Bar Code Input)  
CODE39  
▶\*2010/\*◀

- 5 Press the **OK** or **Enter** key to insert the bar code in the label.  
The bar code is displayed on the text entry screen.

HEL AA 4.7"  
}abc|||\_



- Press the **Escape** key to return to the previous step.
- Refer to the Special Characters List table for a list of all available settings.

### ● Special Character List ●

#### CODE39

Code	Special Character
0	-
1	.
2	(SPACE)
3	\$
4	/
5	+
6	%

#### CODABAR

Code	Special Character
0	-
1	\$
2	:
3	/
4	.
5	+

## CODE128, GS1-128 (UCC / EAN-128)

Code	Special Character	Code	Special Character	Code	Special Character
0	(SPACE)	24	\	48	DC3
1	!	25	]	49	DC4
2	"	26	^	50	NAK
3	#	27	_	51	SYN
4	\$	28	NUL	52	ETB
5	%	29	.	53	CAN
6	&	30	SOH	54	EM
7	'	31	STX	55	SUB
8	(	32	ETX	56	ESC
9	)	33	EOT	57	{
10	*	34	ENQ	58	FS
11	+	35	ACK	59	
12	,	36	BEL	60	GS
13	-	37	BS	61	}
14	.	38	HT	62	RS
15	/	39	LF	63	~
16	:	40	VT	64	US
17	;	41	FF	65	DEL
18	<	42	CR	66	FNC3
19	=	43	SO	67	FNC2
20	>	44	SI	68	FNC4
21	?	45	DLE	69	FNC1
22	@	46	DC1		
23	[	47	DC2		

## Editing and Deleting a Bar Code

- To edit the bar code data position the cursor beneath the bar code mark on the data entry screen and then open the Bar Code Input screen. Refer to "Entering Bar Code Data" on page 51.
- To edit the "Width" and "Under#" settings on a bar code already placed on the screen, position the cursor beneath the bar code mark on the data entry screen and then open the Bar Code Setup screen. Refer to "Setting Bar Code Parameters" on page 50.
- To delete a bar code from a label, position the cursor to the right of the bar code mark on the data entry screen and press the **Backspace** key.

1

2

3

4

5

6

7

8

9

# LABEL PRINTING

---

## Label Preview

Using the Preview function you can check the layout of the label before printing.

**1** Press the **Preview** key.

An image of the label is displayed on the screen.

The length of the label is shown in the lower-right corner of the screen.

Press the ◀ or ▶ key to scroll the preview to the left or right.

Press the ▲ or ▼ key to change the magnification of the preview.



- Press the **Escape**, **OK** or **Enter** key to return to the text entry screen.
- To scroll the preview to the left or right end, hold down the **Shift** key and press the ◀ or ▶ key.
- To print the label directly from the preview screen, press the **Print** key or open the print options screen and select a print option. Refer to "Printing a Label" below for details.
- The print preview is a generated image of the label, and may differ from the actual label when printed.

## Printing a Label

Labels can be printed once text entry and formatting is complete. Printing options include single and multiple copies, sequential numbering and mirror-printing.



- **Do not pull the label coming out of the tape exit slot. Doing so will cause the ink ribbon to be discharged with the tape.**
- Do not block the tape exit slot during printing or when feeding tape. Doing so will cause the tape to jam.
- Be sure to check that there is enough tape remaining when printing several labels continuously. If tape is running low, set fewer copies, print labels one at a time, or replace the tape cassette.
- Striped tape indicates the end of the tape cassette. If this appears during printing, press the **Power** key to turn the P-touch labeler off. Attempting to print with an empty tape cassette may damage the machine.

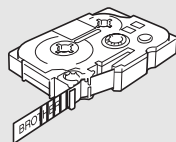

## Printing a Single Copy

- 1 Make sure that the appropriate tape cassette is inserted and ready for printing.
- 2 Press the **Print** key. "Printing...Copies" is displayed while the labels are being printed.



Printing...  
Copies 1/1

 To stop printing, press the **Power** key to turn off the P-touch labeler.

 There are several other messages that may appear when you press the **Print** key. Refer to "Error Messages" on page 74 for further information about error messages.

## Printing Multiple Copies

Using this function you can print up to 99 copies of the same label.

- 1 Make sure that the appropriate tape cassette is inserted and ready for printing.
- 2 Hold down the **Shift** key and press the **Print** key to display the print options screen, and then select "Copies" using the **▲** or **▼** key.
- 3 Press the **OK** or **Enter** key to display the Copies screen, and then select the number of copies to be printed using the **▲** or **▼** key, or type the number using the number keys.

 Hold down the **▲** or **▼** key to change the number of copies faster.

- 4 Press the **OK** or **Enter** key. "Printing...Copies" is displayed while the labels are being printed.

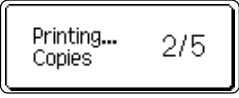

Printing...  
Copies 2/5

-  • Press the **Escape** key to return to the previous step.
- Unless set otherwise, the tape is automatically cut after each copy is printed. Refer to "Tape Cutting Options" on page 57 to change this setting.
  - The figures shown on the screen during printing indicate the "count / number of copies set".
  - Pressing the **Space** key when setting the number of copies resets the value to 1, the default.

1

2

3

4

5

6

7

8

9

### Auto-numbering Labels

Using the numbering function you can create a set of sequentially numbered labels from a single label format.

**1** Make sure that the appropriate tape cassette is inserted and ready for printing.

**2** Hold down the **Shift** key and press the **Print** key to display the print options screen, and then select "Numbering" using the **▲** or **▼** key.

**3** Press the **OK** or **Enter** key.  
The numbering start point screen is displayed.



To apply auto-numbering to a bar code, select the bar code here. After selecting the bar code you will be prompted to enter the number of labels to be printed (step 6).

Start Point? <Numbering>  
|)abc 10

**4** Move the cursor to the first character to be incremented in the numbering sequence and press the **OK** or **Enter** key.  
The numbering end point screen is displayed.

End Point? <Numbering>  
|)abc 10

**5** Move the cursor to the last character to be incremented in the numbering sequence and press the **OK** or **Enter** key.  
The number of labels to be printed is displayed.

<Numbering>  
01  
10 - 10

**6** Select the number of labels to be printed using the **▲** or **▼** key, or type the number using the number key.



Hold down the **▲** or **▼** key to change the number of labels faster.

<Numbering>  
05  
10 - 14

**7** Press the **OK** or **Enter** key.  
The labels are printed.  
As each label is printed the number of copies printed is shown.

- Press the **Escape** key to return to the previous step.
- The tape is automatically cut after each copy is printed. Refer to “Tape Cutting Options” on page 57 to change this setting.
- The figures shown on the screen during printing indicate the “count / number of copies”.
- Pressing the **Space** key when selecting the number of copies resets the value to 1, the default.
- Auto-numbering can also be applied to bar codes. When a bar code contains an auto-numbering sequence, no other fields in the label can contain an auto-numbering sequence.
- The auto-number portion of the label is incremented after each label is printed.
- Only one auto-numbering sequence can be used in a label.
- Any symbols or other non-alphanumeric characters in the auto-numbering sequence are ignored.
- An auto-numbering sequence can only contain a maximum of five characters.

- Letters and numbers increase as shown below:

0	→	1	...	9	→	0	→	...
A	→	B	...	Z	→	A	→	...
a	→	b	...	z	→	a	→	...
A0	→	A1	...	A9	→	B0	→	...

Spaces (shown as underscores “\_” in the example below) can be used to adjust the spacing between characters or to control the number of digits that are printed.

_9	→	10	...	_99	→	00	→	...
_Z	→	AA	...	_ZZ	→	AA	→	...
1_9	→	2_0	...	_9_9	→	0_0	→	...

## Mirror Printing

Using the mirror printing function you can create labels with the text printed in reverse so that they can be read from the opposite side when attached to glass or other transparent material.

- 1** Make sure that the appropriate tape cassette is inserted and ready for printing.
- 2** Hold down the **Shift** key and press the **Print** key to display the print options screen, and then select “Mirror” using the **▲** or **▼** key.
- 3** Press the **OK** or **Enter** key.  
The message “Mirror Print?” is displayed
- 4** Press the **OK** or **Enter** key. “Printing...Copies” is displayed while the labels are being printed.



- Press the **Escape** key to return to the previous step.
- Text should be printed on clear tape when using the mirror printing function.
- The copy and auto-numbering functions cannot be used together with the mirror printing function.

## Tape Cutting Options

The tape cutting options allow you to specify how the tape is fed and cut when printing labels. In particular, the "Chain" and "No Cut" options greatly reduce the amount of wasted tape by using smaller margins and eliminating blank sections cut between labels.

- 1 Press the **Label** key to display the Label menu.
- 2 Select "Cut Option" using the **▲** or **▼** key, and then set the value by using the **◀** or **▶** key.
- 3 Press the **OK** or **Enter** key to apply the settings.



New settings are NOT applied if you do not press the **OK** or **Enter** key.



- Press the **Escape** key to return to the previous step.
- Refer to the Tape Cutting table for a list of all available settings.

### ● Tape Cutting ●

Setting	Description	Example
Large Margin	Automatically cuts the tape after each label is printed, leaving a margin of 0.94" (24 mm) on each end.	 0.94" 0.94" (24 mm) (24 mm)
Small Margin	Automatically cuts a piece of blank tape before printing the first label and then cuts the tape after each label is printed, leaving a 0.16" (4 mm) margin at each end of each label.	0.92" (23 mm)  0.16" 0.16" (4 mm) (4 mm)
Chain	<ul style="list-style-type: none"> <li>• Automatically cuts a piece of blank tape before printing the first label and then cuts the tape after each label is printed, leaving a 0.16" (4 mm) margin at each end of each label.</li> <li>• Once the last label is printed, the tape is not fed and cut.</li> </ul>	0.92" (23 mm)  0.16" 0.16" (4 mm) (4 mm)

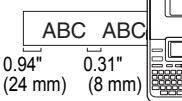
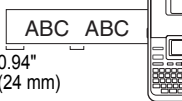

No Cut	<ul style="list-style-type: none"> <li>Prints a strip of labels with no cuts in between.</li> <li>Pressing the <b>Preview</b> while holding down <b>Shift</b> key will feed and cut the last label printed.</li> </ul>	
Special Tape	<ul style="list-style-type: none"> <li>Select this setting when using special tape.</li> <li>When using Fabric Iron-On Tapes or Extra Strength Adhesive Tapes, set "On" for Manual Cutting before printing. After printing, remove the tape cassette from the machine and use scissors to cut the tape.</li> </ul>	

- When using Fabric Iron-On Tapes or Extra Strength Adhesive Tapes, refer to the above "Special Tape".
- The tape is not cut after the last label is printed when "Chain" or "No Cut" is set. Hold down the **Shift** key and press the **Preview** key to feed and cut tape automatically, or cut the tape manually if you are using Fabric Iron-on Tapes or Extra Strength Adhesive Tapes.

## Adjusting the Label Length

You can adjust the length of the printed label in levels of -5 to +5.

- Press the **Setup** key to display the setup menu, select "Adjust Length" using the **▲** or **▼** key, and then press the **OK** or **Enter** key.
- Select "Adjust Length" by using the **▲** or **▼** key, and then set the value by using the **▲** or **▼** key.
 

⬆️ +1      <Adjust Length>
- Press the **OK** or **Enter** key to apply the setting.

- Press the **Escape** key to return to the previous step.
- Press the **Space** key to set the value to default setting.
- Approximately 1% of the total label length will be adjusted by 1 level.

1

2

3

4

5

6

7

8

9

### Attaching Labels

- 1 If necessary, trim the printed label to the desired shape and length using scissors, etc.
- 2 Peel the backing from the label.
- 3 Position the label and then press firmly from top to bottom with your finger to attach the label.



- The backing of some types of tapes may be pre-cut to make it easier to peel the backing. To remove the backing, simply fold the label lengthwise with the text facing inward, to expose the inside edges of the backing. Next, peel off the backing one piece at a time.
- Labels may be difficult to attach to surfaces that are wet, dirty, or uneven. The labels may peel off easily from these surfaces.
- Be sure to read the instructions provided with Fabric Iron-On Tapes, Extra Strength Adhesive Tapes or other special tapes and observe all precautions noted in the instructions.

### Printing from the Label Collection

#### Printing a label from the Label Collection Stored in the Machine

Pages 60 to 63 show the many labels that are stored in your Label Collection. Printing these pre-designed labels saves you time.

- 1 Press the **Label Collection** key.
- 2 Select the language of the label to be printed using the **▲** or **▼** key, and then press the **OK** or **Enter** key.  
The language can be selected from "English(United States)", "French(Canada)", "Portuguese", "Spanish(United States)", or "Turkish".
- 3 Select the category using the **▲** or **▼** key, and then press the **OK** or **Enter** key.



Refer to the Label Collection Lists to view all of the available labels.

- 4 The first label image is displayed.  
Select a label using the **▲** or **▼** key, and then press the **OK** or **Enter** key.













To add the label to your "Favorites", select "Add to Favorites" using the **▲** or **▼** key, and then press the **OK** or **Enter** key to register the selected label image in the Favorites category. Registering your most frequently used label images allows you to quickly and easily display them when needed again.

- 5 Select "Print" using the ▲ or ▼ key, and then press the **OK** or **Enter** key.

 Label Collection categories are pre-set for specific tape widths. Tape widths are referenced after the name of the Label Collection category in parentheses. For example, to create a Shipping Label, 0.70" (18 mm) tape must be loaded in the machine. If the width of the current tape cassette does not match the set width for the selected layout, an error message is displayed when you try to print the label. Press the **Escape** key or any other key to clear the error message, and insert a tape cassette of the correct width.

-  • Using the P-touch Update Software, additional label categories can be downloaded and new label designs added to the machine or P-touch Editor.
- Refer to "Downloading a Label Collection / Updating the Software" on page 63 for details on how to download additional categories of labels.

### ● Label Collection List ●

Category	Label
Files (0.47" [12 mm] tape only)	
	
	 
	  
	 
	 

\* Labels are for illustrative purposes only.

1

2

3

4

5













6

7













8

9

LABEL PRINTING

Category	Label
Office Signage (0.94" [24 mm] tape only)	
	
	
	
	
	
	
	
	
	Caution (0.94" [24 mm] tape only)
	
	
	
	

\* Labels are for illustrative purposes only.

Category	Label
Shipping (0.70" [18 mm] tape only)	
	
ECO (0.70" [18 mm] tape only)	
	
	
	
	
	
Retail (0.94" [24 mm] tape only)	
	
	
	
	

\* Labels are for illustrative purposes only.

- 1
- 2
- 3
- 4
- 5
- 6
- 7
- 8
- 9

Category	Label
Personal (0.47" [12 mm] tape only)	<i>Best Wishes!</i> 
	* * Happy  Birthday! * *
	<b>Congratulations!</b> 
	<b>Thank you</b>  <b>Merry Christmas</b>  <b>Good Luck</b> 

\* Labels are for illustrative purposes only.

## Downloading a new Label Collection Category (Windows® only)

Using the P-touch Update Software, additional label collection categories can be downloaded to your labeler or downloaded to your PC and printed using P-touch Editor. Furthermore, the software can be upgraded to the latest version using this tool.



- To use the P-touch Update Software, it is necessary to install it from the CD-ROM provided.
- Refer to the "Software Installation Guide" for details on how to install the software.
- You must be connected to the internet in order to launch the P-touch Update software.
- Label Collection Designs cannot be edited.
- You may find that the software and the contents in this manual are different.
- Upon installation of the P-touch Update Software, an icon will be installed on your desktop (or other location of your choosing) for your convenience. To check for New Label Collection Designs, simply click the icon to launch the software.

### Downloading a Label Collection Category to your Labeler

The following is the example for Windows Vista®.

In the following steps, you will see XX-XXXX. Read "XX" as your labeler name.

**1** Turn the machine on and connect the USB cable.

**2** Double-click the [P-touch Update Software] icon.



The following method can also be used to start the P-touch Update Software.  
Click [Start], and then select [All Programs] - [Brother P-touch] - [P-touch Update Software].



- 3 Click the [Machine update] icon.

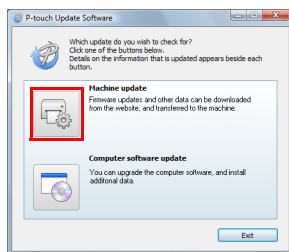

- 4 Select the [Printer], ensure that [The machine is connected correctly.] is displayed, and then click [OK].

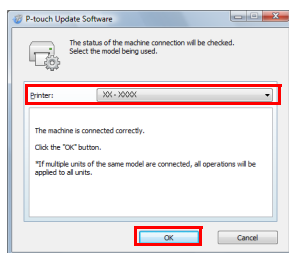

- 5 Select the [Language], select the check box next to the label collection to be downloaded and/or software to be updated, and then click [Transfer].



Click "Click here for details" in the upper right to view a web page with a specific examples of label collection designs.

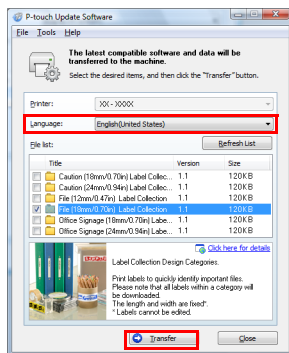

1

2

3

4

5

6

7

8

9

## LABEL PRINTING

---

- 6** Check the content to be updated, and then click [Start] to begin the update.

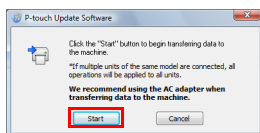

- 7** The screen on the right is displayed on your computer while the software is being updated screen.

The screen on the right appears on the machine's LCD display.

-  Do not turn off the machine during the update process.

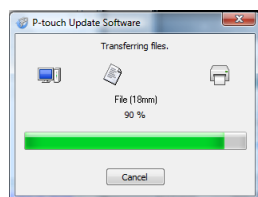

- 8** Click [OK] to complete the update.

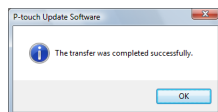

- 9** The display returns to the input screen when the update is complete.
-





- Newly downloaded label collection categories are added to the respective "Category".
- An asterisk "\*" is displayed at the end of the newly added category.
- Downloaded label collections can be deleted using the following procedure.
  1. Press the **Label Collection** key.
  2. Press the **▲** or **▼** key, and then select the language.
  3. Press the **▲** or **▼** key, and then select the category.
  4. Press the **Clear** key.
- If the downloaded label collection was registered in "Favorites", it will also be deleted from here.
- It is not possible to delete individual labels from each "Category".
- When "Download New Labels" is selected, the prompt "Connect PC, and Run P-touch Update" is displayed.



## Downloading a New Label Collection Category to P-touch Editor / Updating P-touch Editor Software

The following is the example for Windows Vista®.

In the following steps, you will see XX-XXXX. Read "XX" as your labeler name.

### 1 Double-click [P-touch Update Software].



- The following method can also be used to start the P-touch Update Software.
- Click [Start], and then select [All Programs] - [Brother P-touch] - [P-touch Update Software].
- If a message is displayed notifying the user that the Editing Software (P-touch Editor) is the latest version when started, click [Yes] and then proceed to step 3.



### 2 Click the [Computer software update] icon.

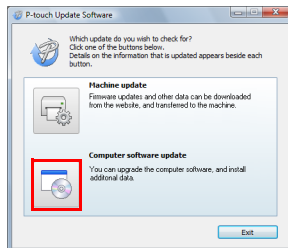

1

2

3

4

5

6

7

8

9

## LABEL PRINTING

- 3 Select the [Printer] and [Language], select the check box next to the label collection to be installed and then click [Install].

 Click "Click here for details" in the upper right to view a web page with a specific examples of label collection designs.

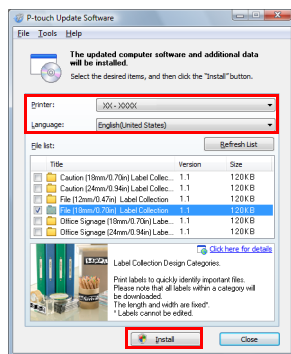

- 4 The installed label collection will be saved to the P-touch Editor [Label Collection] tab.

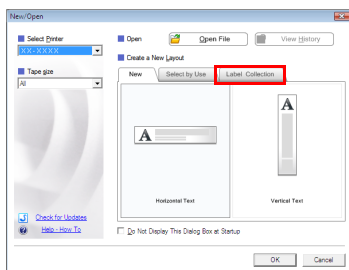

## USING THE FILE MEMORY

You can store up to 99 of your most frequently used labels in the file memory. Each label is stored as a file, allowing you to quickly and easily recall your label when needed again.

- When the file memory is full, each time you save a file you will need to overwrite one of your stored files.

### Storing a Label into Memory

- 1 After entering the text and formatting the label, press the **File** key to display the File screen.
- 2 Select "Save" using the ▲ or ▼ key.
- 3 Press the **OK** or **Enter** key. A file number is displayed. A label text is also displayed if a label is already stored in that file number.
- 4 Select a file number using the ▲ or ▼ key, and then press the **OK** or **Enter** key to save the label under the selected file number. The file is saved and the screen returns to the text entry screen.

- When there is already a stored file in the selected number, the data will be overwritten by the file you try to save.

- Press the **Escape** key to return to the previous step.
- A maximum of 280 characters can be saved in each file. However, this number may depend upon the characters or symbols used. Up to 99 files can be saved.
- To store a label created by using the Auto-Format Layouts, refer to "Using Auto-Format Layouts" on page 38.

### Opening a Stored Label File

- 1 Press the **File** key to display the File screen.
- 2 Select "Open" using the ▲ or ▼ key.
- 3 Press the **OK** or **Enter** key. The file number of a stored label is displayed. The label text is also displayed to identify the label.
- 4 Select a file number using the ▲ or ▼ key, and then press the **OK** or **Enter** key to open the selected file. The file is opened and displayed on the text entry screen.

- Press the **Escape** key to return to the previous step.

1

2

3

4

5

6

7

8

9

### Printing a Stored Label File

- 1** Press the **File** key to display the File screen.
- 2** Select "Print" using the ▲ or ▼ key.
- 3** Press the **OK** or **Enter** key.  
The file number of a stored label is displayed.  
The label text is also displayed to identify the label.
- 4** Select a file number using the ▲ or ▼ key, and then press the **Print**, **OK** or **Enter** key to print the selected label. The label is printed from the machine.



- Press the **Escape** key to return to the previous step.
- The message "No Text!" is displayed when you try to print a file with no text.

### Deleting a Stored Label File

- 1** Press the **File** key to display the File screen.
- 2** Select "Delete" using the ▲ or ▼ key.
- 3** Press the **OK** or **Enter** key.  
The file number of a stored label is displayed.  
The label text is also displayed to identify the label.
- 4** Select a file number using the ▲ or ▼ key, and then press the **OK** or **Enter** key.  
The message "Delete?" is displayed.
- 5** Press the **OK** or **Enter** key to delete the file.  
The file is deleted and the screen returns to the text entry screen.



- Press the **Escape** key to cancel deleting the file and return to the previous screen.

# MAINTAINING YOUR P-TOUCH LABELER

## Resetting the P-touch Labeler

You can reset the internal memory of your P-touch labeler when you want to clear all saved label files, or in the event the P-touch labeler is not operating correctly.

### Resetting data to factory settings (Downloaded data is not reset.)

Turn off the machine. Press and hold down the **Shift** and **R** keys. While holding down the **Shift** and **R** keys, press the **Power** key once and then release the **Shift** and **R** keys.

### Resetting data to factory settings (Downloaded data is reset.)

Turn off the machine. Press and hold down the **Shift** and **Backspace** keys. While holding down the **Shift** and **Backspace** keys, press the **Power** key once and then release the **Shift** and **Backspace** keys.



- Release the **Power** key before releasing the other key.
- All text, format settings, option settings and stored label files are cleared when you reset the P-touch labeler. Language and unit settings will also be cleared

## Maintenance

Your P-touch labeler should be cleaned on a regular basis to maintain its performance and life span.



Always remove the batteries and disconnect the AC adapter before cleaning the P-touch labeler.

### Cleaning the Unit

Wipe any dust and marks from the main unit using a soft, dry cloth. Use a slightly dampened cloth on difficult to remove marks.



Do not use paint thinner, benzene, alcohol or any other organic solvent. These may deform the case or damage the appearance of your P-touch labeler.

### Cleaning the Print Head

Streaks or poor quality characters on printed labels generally indicates that the print head is dirty. Clean the print head using a cotton swab or the optional print head cleaning cassette (TZ-CL4).

Print head

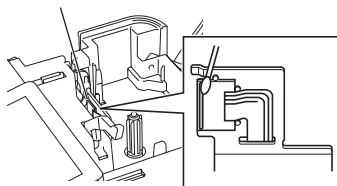

1

2

3

4

5

6

7

8

9

## MAINTAINING YOUR P-TOUCH LABELER

---



- Do not touch the print head directly with your bare hands.
- Refer to the instructions provided with the print head cleaning cassette for directions on how to use it.

### Cleaning the Tape Cutter

Tape adhesive can build up on the cutter blade after repeated use, taking the edge off the blade which may result in the tape jamming in the cutter.



- About once every year, wipe the cutter blade using a cotton swab moistened with Isopropyl alcohol (rubbing alcohol).
- Do not touch the cutter blade directly with your bare hands.

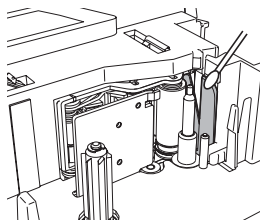

## TROUBLESHOOTING

## What to do when...

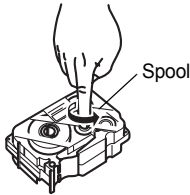
Problem	Solution
The screen 'locks', or the P-touch labeler does not respond normally.	Refer to "Resetting the P-touch Labeler" on page 70 and reset the internal memory to the initial settings. If resetting the P-touch labeler does not solve the problem, disconnect the AC adapter and remove the batteries for more than 10 minutes.
The display remains blank after turning on the power.	Check that the batteries are correctly installed and that the AC adapter designed exclusively for your P-touch labeler (provided) is correctly connected.
The LCD messages are displayed in a foreign language.	Refer to "Setting Language and Unit" on page 22 to select your desired language.
The label is not printed after pressing the Print key.	<ul style="list-style-type: none"> <li>• Check that text has been entered and that the tape cassette is installed correctly with sufficient tape remaining.</li> <li>• If the tape is bent, cut off the bent section and thread the tape through the tape exit slot.</li> <li>• If the tape is jammed, remove the tape cassette and then pull out the jammed tape and cut it. Check that the end of the tape passes through the tape guide before reinstalling the tape cassette.</li> </ul>
The label is not printed correctly.	<ul style="list-style-type: none"> <li>• Remove the tape cassette and reinstall it, pressing it firmly until it clicks into place.</li> <li>• If the print head is dirty, clean it with a cotton swab or optional print head cleaning cassette (TZ-CL4).</li> <li>• Check that the Cut Option setting is not set to Chain or No Cut, as the tape will not be fed after printing the label. Alternatively, hold down the <b>Shift</b> key and press the <b>Preview</b> key to feed and cut the tape.</li> </ul>
The ink ribbon is separated from the ink roller.	<p>If the ink ribbon is broken, replace the tape cassette. If not, leave the tape uncut and remove the tape cassette, then wind the loose ink ribbon onto the spool as shown in the figure.</p> 

1

2

3

4

5

6

7

8

9

## TROUBLESHOOTING

---

Problem	Solution
The P-touch labeler stops while printing a label.	<ul style="list-style-type: none"><li>• <i>Replace the tape cassette if striped tape is visible, as this indicates that you have reached the end of the tape.</i></li><li>• <i>Replace all batteries or connect the AC adapter directly to the P-touch labeler.</i></li></ul>
The label is not cut automatically.	<ul style="list-style-type: none"><li>• <i>Check that the Cut Option setting is not set to Chain or No Cut, as the tape will not be fed after printing the label. Alternatively, hold down the <b>Shift</b> key and press the <b>Preview</b> key to feed and cut the tape.</i></li></ul>
Label files saved previously are now empty.	<i>All files stored in the internal memory are deleted if the batteries are weak or the AC adapter was disconnected.</i>



## Error Messages

When an error message appears on the display, follow the directions provided below.

Message	Cause/Remedy
<b>Battery Weak! *</b>	The installed batteries are getting weak.
<b>Check Battery!</b>	<p>The following are likely causes.</p> <ul style="list-style-type: none"> <li>• The batteries are installed with the negative and positive ends the wrong way round.</li> <li>• Other types of batteries are being used with alkaline batteries.</li> <li>• Old and new batteries are being used together.</li> <li>• The batteries are about to run out.</li> </ul> <p>If the power does not turn off automatically, press any key to clear the error message before turning the unit off. Check that the correct batteries are being used, and are installed the right way round.</p>
<b>Wrong Type Of Adapter Connected!</b>	An incompatible AC adapter is connected. After the power is turned off automatically, use the AC adapter designed exclusively for your P-touch labeler.
<b>Cutter Error! *</b>	<p>The tape cutter is closed when you try to print or feed tape. Turn the P-touch labeler off and then on again before continuing.</p> <p>When tape is tangled in the cutter, remove the tape.</p>
<b>No Text! *</b>	There is no text, symbols or bar code data entered when you try to print or preview a label. Enter data before continuing.
<b>Insert Tape Cassette! *</b>	There is no tape cassette installed when you try to print or preview a label, or feed tape. Install a tape cassette before continuing.
<b>Tape Cassette Changed! *</b>	The tape cassette was changed while printing, etc. Make sure the correct tape cassette is inserted before printing.
<b>Line Limit! Max 7 Lines *</b>	There are already seven lines of text when you press the <b>Enter</b> key. Limit the number of lines to seven.
<b>Tape Width Limit! Max 5 Lines *</b>	There are more than five lines of text when you press the <b>Print</b> or <b>Preview</b> key while using 0.70" (18mm) tape. Limit the number of lines to five, or replace with a larger width tape cassette.
<b>Tape Width Limit! Max 3 Lines *</b>	There are more than three lines of text when you press the <b>Print</b> or <b>Preview</b> key while using 0.47" (12 mm) tape. Limit the number of lines to three, or replace with a larger width tape cassette.

\*Press any key to clear the error message.

1

2

3

4

5

6

7

8

9

## TROUBLESHOOTING

Message	Cause/Remedy
<b>Tape Width Limit! Max 2 Lines *</b>	There are more than two lines of text when you press the <b>Print</b> or <b>Preview</b> key while using 0.35" or 0.23" (9 mm or 6 mm) tape. Limit the number of lines to two, or replace with a larger width tape cassette.
<b>Tape Width Limit! Max 1 Line *</b>	There is more than one line of text when you press the <b>Print</b> or <b>Preview</b> key while using 0.13" (3.5mm) tape. Limit the number of lines to one, or replace with a larger width tape cassette.
<b>Block Limit! Max 5 Blocks *</b>	There are already five blocks of text. Limit the number of blocks to five.
<b>Text Full! *</b>	The maximum number of characters have already been entered. Edit the text and use fewer characters.
<b>Length Limit! *</b>	The length of the label to be printed using the text entered is longer than 39.37" (1 m). Edit the text so that the length of the label is less than 39.37" (1 m).
<b>Insert 0.94" Tape Cassette! *</b>	An 0.94"(24mm) tape cassette is not installed when an Auto-Format for 0.94"(24mm) tape is selected. Install an 0.94"(24mm) tape cassette.
<b>Insert 24mm Tape Cassette! *</b>	
<b>Insert 0.70" Tape Cassette! *</b>	An 0.70" (18 mm) tape cassette is not installed when an Auto-Format for 0.70" (18 mm) tape is selected. Install an 0.70" (18 mm) tape cassette.
<b>Insert 18mm Tape Cassette! *</b>	
<b>Insert 0.47" Tape Cassette! *</b>	An 0.47" (12 mm) tape cassette is not installed when an Auto-Format for 0.47" (12 mm) tape is selected. Install a 0.47" (12 mm) tape cassette.
<b>Insert 12mm Tape Cassette! *</b>	

\*Press any key to clear the error message.

Message	Cause/Remedy
<b>Insert 0.35" Tape Cassette! *</b>	An 0.35" (9 mm) tape cassette is not installed when an Auto-Format for 0.35" (9 mm) tape is selected. Install a 0.35" (9 mm) tape cassette.
<b>Insert 9mm Tape Cassette! *</b>	
<b>Insert 0.23" Tape Cassette! *</b>	An 0.23" (6 mm) tape cassette is not installed when an Auto-Format for 0.23" (6 mm) tape is selected. Install a 0.23" (6 mm) tape cassette.
<b>Insert 6mm Tape Cassette! *</b>	
<b>Insert 0.13" Tape Cassette! *</b>	An 0.13" (3.5mm) tape cassette is not installed when an Auto-Format for 0.13" (3.5mm) tape is selected. Install an 0.13" (3.5mm) tape cassette.
<b>Insert 3.5mm Tape Cassette! *</b>	
<b>Too Much Text For This Layout! *</b>	The maximum number of characters for the selected layout have already been entered. Edit the text to use fewer characters or use a different layout.
<b>Incorrect Value! *</b>	The value entered for setting the tape length, tab length, multiple copies or numbering function is invalid. Enter a valid value for the setting.
<b>Select Other Cut Option! *</b>	The tape length set using the tape length setting is shorter than the total length of the left and right margins applied for the "Large Margin" cutting option. Select a different cutting option.
<b>Text Too Long! *</b>	The length of the label to be printed using the text entered is longer than the length setting. Edit the text to fit within the set length or change the length setting.
<b>Text Too High! *</b>	The text size is too large. Select a different size option.
<b>Memory Full! *</b>	There is not enough internal memory available when you try to save a label file. Delete any unnecessary files to make more memory available for the new label file.

\*Press any key to clear the error message.

1

2

3

4

5

6

7

8

9

## TROUBLESHOOTING

.....

Message	Cause/Remedy
<b>Check # of Digits Entered! *</b>	The number of digits entered in the bar code data does not match the number of digits set in the bar code parameters. Enter the correct number of digits.
<b>Input A,B,C or D At Start&amp;End! *</b>	The bar code data entered does not have the required start/stop code (A, B, C, or D required at the beginning and end of the bar code data for the CODABAR protocol). Enter the bar code data correctly.
<b>Maximum Of 5 Bar Codes Per Label! *</b>	There are already 5 bar codes entered in the text data when you try to enter a new bar code. You can only use up to five bar codes in each label.
<b>Category Full! *</b>	The memory available for categories is full. To make more memory available, delete any unnecessary registered categories by highlighting the category and pressing the <b>Clear</b> key.
<b>Installed tape is not compatible with this machine! *</b>	Tape that is incompatible with the machine has been installed. Use compatible tape.

\*Press any key to clear the error message.

## APPENDIX

## Specifications

## Main Unit

Item	Specification
<b>Display</b>	
Character display	16 characters x 3 lines (128 dot x 48 dot) ,Backlit
Screen contrast	5 levels (+2, +1, 0, -1, -2)
<b>Printing</b>	
Print method	Thermal Transfer
Print head	128 dot / 180 dpi
Print height	0.71" (18mm) max. (when using 0.94" (24mm) tape)
Print speed	Approx. 0.39" (10 mm)/ sec.
Tape cassette	TZ tape cassette (0.13", 0.23", 0.35", 0.47", 0.70", 0.94" [3.5, 6, 9, 12, 18, 24 mm] widths)
No. of lines	0.94" (24mm) tape : 1-7 lines; 0.70" (18 mm) tape : 1 - 5 lines; 0.47" (12 mm) tape : 1 - 3 lines; 0.35" (9 mm) tape : 1 - 2 lines; 0.23" (6 mm) tape : 1 - 2 lines; 0.13" (3.5mm) tape : 1 line
Cut and feed	Large Margin, Small Margin, Chain, No Cut, Special Tape
<b>Memory</b>	
Memory buffer size	Maximum 2800 characters
File storage	Maximum 99 files
<b>Other Features</b>	
Input method	Text Reminder
Templates	Label Collections, Auto-Format, Block Layouts
<b>Power Supply</b>	
Power supply	AC adapter (AD-24ES), Eight AA-size alkaline batteries (LR6).
Auto Power-off	Battery: 5 min.* , AC adapter: 8 hours *When using P-touch labeler only. When connected to a PC, 1 hour.
<b>Size</b>	
Dimensions	Approx.7.0"(W) x 9.4"(D) 2.8"(H) [177.0mm (W) x 237.5mm (D) x 70.4mm (H)]
Weight	Approx.1.94lb (880g) (without tape cassette and batteries)
<b>Other</b>	
Operating temperature / humidity	50 ~ 95°F / 20 ~ 80% humidity (without condensation) Maximum wet bulb temperature: 80.6°F

1

2

3

4

5

6

7

8

9

# INDEX

---

## A

AC adapter .....	17
Accented Character List .....	29
Auto power-off time .....	19

## B

Battery .....	16
Block Layouts .....	43

## C

Caps mode .....	13
contrast .....	21
cursor keys .....	24

## D

deleting	
text and formatting .....	25
text only .....	25

## E

entering	
text .....	23

## F

fonts .....	31
formatting	
character attributes .....	30
label attributes .....	35
Frames .....	36

## K

Keyboard .....	14
----------------	----

## L

Label Collection .....	59
length .....	35
line .....	30
Line number .....	13

## N

new line .....	24
----------------	----

## P

Power Supply .....	16
--------------------	----

## R

Return mark .....	13
-------------------	----

## S

size .....	30
Special Character List .....	51
Specifications .....	78
style .....	30
Symbol List .....	28
symbols .....	26

## T

tape cassettes .....	18
tape length .....	13
Templates .....	40
text	
entering and editing .....	23
lines .....	24
Text Reminder .....	23
Time Stamp	
Format Options .....	48
Forward Options .....	49
Timing Options .....	46, 47

## W

width .....	30
-------------	----

## Contact Information (For USA Only)

---

### Service Center Locations

---

If you need a local service center, please call 1-877-BROTHER (1-877-276-8437) to locate the authorized service center closest to you.

Note: Be sure to call the Service Center before your visit.

Service centers do not provide operational assistance. See "Operational Assistance".

---

### Operational Assistance

---

For technical and operational assistance you may call Brother Customer Service at: Voice 1-877-BROTHER (1-877-276-8437), or Fax 1-901-379-1210

---

### Assistance on the Internet

---

For product information: [www.brother-usa.com](http://www.brother-usa.com)

For downloading the latest drivers: <http://solutions.brother.com>

For purchasing accessories and certain Brother products: <http://www.brothermall.com>

---

### Accessories and Supplies

---

To order Brother accessories or supplies by Visa, MasterCard, Discover or American Express, you may call toll free 1-877-552-MALL (6255), or complete the order form and fax both sides of the form to 1-800-947-1445.

For purchasing accessories on the Internet: <http://www.brothermall.com>

To order by mail or pay by check, please complete the accessory order form and mail it along with payment to:

Brother International Corporation  
Attn: Consumer Accessory Division  
P.O. Box 341332  
Bartlett, TN 38133-1332

**brother**®

Printed in China

LW6057001 (A)





## Free Manuals Download Website

<http://myh66.com>

<http://usermanuals.us>

<http://www.somanuals.com>

<http://www.4manuals.cc>

<http://www.manual-lib.com>

<http://www.404manual.com>

<http://www.luxmanual.com>

<http://aubethermostatmanual.com>

Golf course search by state

<http://golfingnear.com>

Email search by domain

<http://emailbydomain.com>

Auto manuals search

<http://auto.somanuals.com>

TV manuals search

<http://tv.somanuals.com>