

# S-7000DD

## INSTRUCTION MANUAL

---

Please read this manual before using the machine.  
Please keep this manual within easy reach for quick reference.

---

SINGLE NEEDLE STRAIGHT LOCK STITCHER  
WITH THREAD TRIMMER

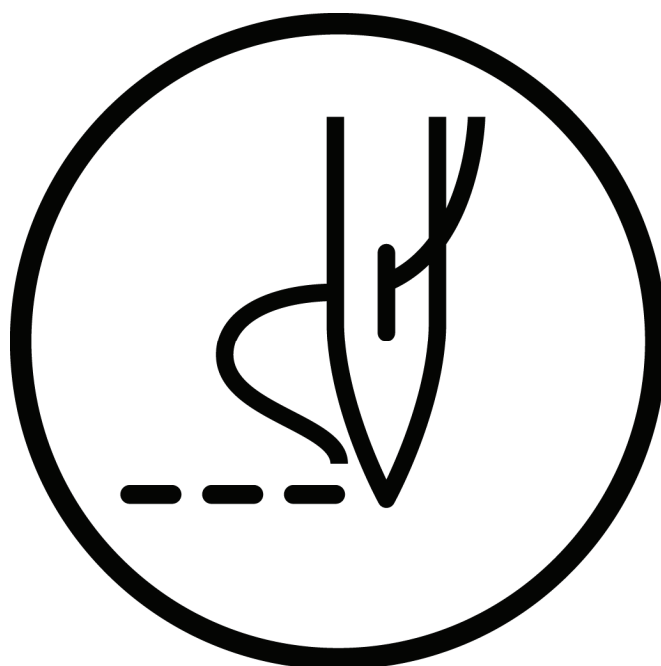

Thank you very much for buying a BROTHER sewing machine. Before using your new machine, please read the safety instructions and the explanations given in the instruction manual.



With industrial sewing machines, it is normal to carry out work while positioned directly in front of moving parts such as the needle and thread take-up, and consequently there is always a danger of injury that can be caused by these parts. Follow the instructions from training personnel and instructors regarding safe and correct operation before operating the machine so that you will know how to use it correctly.

# SAFETY INSTRUCTIONS

## [1] Safety indications and their meanings

This instruction manual and the indications and symbols that are used on the machine itself are provided in order to ensure safe operation of this machine and to prevent accidents and injury to yourself or other people. The meanings of these indications and symbols are given below.

### Indications

 <b>DANGER</b>	The instructions which follow this term indicate situations where failure to follow the instructions will result in death or serious injury.
 <b>WARNING</b>	The instructions which follow this term indicate situations where failure to follow the instructions could result in death or serious injury.
 <b>CAUTION</b>	The instructions which follow this term indicate situations where failure to follow the instructions may result in minor or moderate injury.

### Symbols



.....

This symbol (  ) indicates something that you should be careful of. The picture inside the triangle indicates the nature of the caution that must be taken.  
(For example, the symbol at left means “beware of injury”.)



.....

This symbol (  ) indicates something that you must not do.



.....

This symbol (  ) indicates something that you must do. The picture inside the circle indicates the nature of the thing that must be done.  
(For example, the symbol at left means “you must make the ground connection”.)

## [2] Notes on safety

### **DANGER**



Wait at least 5 minutes after turning off the power switch and disconnecting the power cord from the wall outlet before opening the cover of the control box. Touching areas where high voltages are present can result in severe injury.

### **WARNING**



Do not allow any liquids to get onto this sewing machine, otherwise fire, electric shocks or operating problems may occur.



If any liquid gets inside the sewing machine (machine head or control box), immediately turn off the power and disconnect the power plug from the electrical outlet, and then contact the place of purchase or a qualified technician.

### **CAUTION**

#### Environmental requirements



Use the sewing machine in an area which is free from sources of strong electrical noise such as electrical line noise or static electric noise. Sources of strong electrical noise may cause problems with correct operation.



Any fluctuations in the power supply voltage should be within  $\pm 10\%$  of the rated voltage for the machine. Voltage fluctuations which are greater than this may cause problems with correct operation.



The power supply capacity should be greater than the requirements for the sewing machine's power consumption. Insufficient power supply capacity may cause problems with correct operation.



The ambient temperature should be within the range of 5°C to 35°C during use. Temperatures which are lower or higher than this may cause problems with correct operation.



The relative humidity should be within the range of 45% to 85% during use, and no dew formation should occur in any devices. Excessively dry or humid environments and dew formation may cause problems with correct operation.



In the event of an electrical storm, turn off the power and disconnect the power cord from the wall outlet. Lightning may cause problems with correct operation.

#### Installation



Machine installation should only be carried out by a qualified technician.



Contact your Brother dealer or a qualified electrician for any electrical work that may need to be done.



The sewing machine weighs approximately 32 kg (70lb). The installation should be carried out by two or more people.



Do not connect the power cord until installation is complete. The machine may operate if the treadle is depressed by mistake, which could result in injury.



Turn off the power switch before inserting or removing the plug, otherwise damage to the control box could result.



Be sure to connect the ground. If the ground connection is not secure, you run a high risk of receiving a serious electric shock, and problems with correct operation may also occur.



When securing the cords, do not bend the cords excessively or fasten them too hard with staples, otherwise there is the danger that fire or electric shocks could occur.



If using a work table which has casters, the casters should be secured in such a way so that they cannot move.



Secure the table so that it will not move when tilting back the machine head. If the table moves, it may crush your feet or cause other injuries.













Use both hands to hold the machine head when tilting it back or returning it to its original position. If only one hand is used, the weight of the machine head may cause your hand to slip, and your hand may get caught.







Be sure to wear protective goggles and gloves when handling the lubricating oil and grease, so that they do not get into your eyes or onto your skin, otherwise inflammation can result. Furthermore, do not drink the oil or eat the grease under any circumstances, as they can cause vomiting and diarrhea. Keep the oil out of the reach of children.

# CAUTION











## Sewing

- |   |  |
|---|--|
|  This sewing machine should only be used by operators who have received the necessary training in safe use beforehand.   |  Attach all safety devices before using the sewing machine. If the machine is used without these devices attached, injury may result.   |
|  The sewing machine should not be used for any applications other than sewing.   |  Do not touch any of the moving parts or press any objects against the machine while sewing, as this may result in personal injury or damage to the machine.  |
|  Be sure to wear protective goggles when using the machine.<br>If goggles are not worn, there is the danger that if a needle breaks, parts of the broken needle may enter your eyes and injury may result.   |  Secure the table so that it will not move when tilting back the machine head. If the table moves, it may crush your feet or cause other injuries.  |
|  Turn off the power switch at the following times. The machine may operate if the treadle is depressed by mistake, which could result in injury. <ul style="list-style-type: none"><li>• When threading the needle</li><li>• When replacing the bobbin and needle</li><li>• When not using the machine and when leaving the machine unattended</li></ul> |  Use both hands to hold the machine head when tilting it back or returning it to its original position. If only one hand is used, the weight of the machine head may cause your hand to slip, and your hand may get caught. |
|  If using a work table which has casters, the casters should be secured in such a way so that they cannot move.  |  If an error occurs in machine operation, or if abnormal noises or smells are noticed, immediately turn off the power switch. Then contact your nearest Brother dealer or a qualified technician.                           |
|   |  If the machine develops a problem, contact your nearest Brother dealer or a qualified technician.  |

## Cleaning

- |  |  |
|--|--|
|  Turn off the power switch before carrying out cleaning. The machine may operate if the treadle is depressed by mistake, which could result in injury.   |  Be sure to wear protective goggles and gloves when handling the lubricating oil and grease, so that they do not get into your eyes or onto your skin, otherwise inflammation can result. Furthermore, do not drink the oil or eat the grease under any circumstances, as they can cause vomiting and diarrhea. Keep the oil out of the reach of children. |
|  Secure the table so that it will not move when tilting back the machine head. If the table moves, it may crush your feet or cause other injuries.  |  |
|  Use both hands to hold the machine head when tilting it back or returning it to its original position. If only one hand is used, the weight of the machine head may cause your hand to slip, and your hand may get caught. |  |

## Maintenance and inspection

- |   |  |
|---|--|
|  Maintenance and inspection of the sewing machine should only be carried out by a qualified technician.  |  Secure the table so that it will not move when tilting back the machine head. If the table moves, it may crush your feet or cause other injuries.  |
|  Ask your Brother dealer or a qualified electrician to carry out any maintenance and inspection of the electrical system.  |  Use both hands to hold the machine head when tilting it back or returning it to its original position. If only one hand is used, the weight of the machine head may cause your hand to slip, and your hand may get caught. |
|  Turn off the power switch and disconnect the power cord from the wall outlet at the following times, otherwise the machine may operate if the treadle is depressed by mistake, which could result in injury. <ul style="list-style-type: none"><li>• When carrying out inspection, adjustment and maintenance</li><li>• When replacing consumable parts such as the rotary hook and knife</li></ul> |  When replacing parts and installing optional accessories, be sure to use only genuine Brother parts. Brother will not be held responsible for any accidents or problems resulting from the use of non-genuine parts.       |
|  Always be sure to turn off the power switch and then wait one minute before opening the motor cover. If you touch the surface of the motor, it may cause burns.   |  If any safety devices have been removed, be absolutely sure to re-install them to their original positions and check that they operate correctly before using the machine.   |
|  If the power switch needs to be left on when carrying out some adjustment, be extremely careful to observe all safety precautions.  |  To prevent accidents and problems, do not modify the machine yourself. Brother will not be held responsible for any accidents or problems resulting from modifications made to the machine.                                |

### [3] Warning labels

The following warning labels appear on the sewing machine. Please follow the instructions on the labels at all times when using the machine. If the labels have been removed or are difficult to read, please contact your nearest Brother dealer.

1

	<b>▲ 危険</b>		<b>▲ 危険</b>	
	高電圧部分にふれて、大けがをすることがある。 電源を切り、5分たってからカバーをはずすこと。		触摸高压电部分, 会导致受伤。 在切断电源5分钟后, 再开启盖罩。	
<b>▲ DANGER</b>	<b>▲ GEFAHR</b>	<b>▲ DANGER</b>	<b>▲ PELIGRO</b>	
Hazardous voltage will cause injury. Turn off main switch and wait 5 minutes before opening this cover.	Hochspannung verletzungsgefahr! Bitte schalten sie den hauptschalter aus und warten sie 5 minuten, bevor sie diese abdeckung öffnen.	Un voltage non adapte provoque des blessures. Eteindre l'interrupteur et attendre 5 minutes avant d'ouvrir le capot.	Un voltaje inadecuado puede provocar las heridas. Apagar el interruptor principal y esperar 5 minutos antes de abrir esta cubierta.	

2 Touching areas where high voltages are present can result in severe injury. Turn off the power before opening the cover.

4 Be careful not to get your hands caught when returning the machine head to its original position after it has been tilted.

3

**CAUTION**  
Moving parts may cause injury.

Operate with safety devices\* installed.

Turn off the power before carrying out operations such as threading, changing the needle, bobbin, knives or hook, cleaning and adjusting.

5 Be careful to avoid injury from the moving thread take-up.

6 High temperature warning display

7 Be sure to connect the ground. If the ground connection is not secure, you run a high risk of receiving a serious electric shock, and problems with correct operation may also occur.

8 Direction of operation

\* Safety devices: (A) Finger guard (B) Thread take-up cover (C) Motor cover

9

**brother**  
Lubricating Oil for Machining

**▲ CAUTION**

Lubricating oil may cause inflammation to eye and skin.  
Wear protective glasses and gloves.

Swallowing oil can cause diarrhoea and vomiting.  
Do not swallow.

**Keep away from children.**

**FIRST AID**

Eye contact :  
-Rinse with plenty of cold water.  
-Seek medical help.

Skin contact :  
-Wash with soap and water.

If swallowed :  
-Seek medical help immediately.

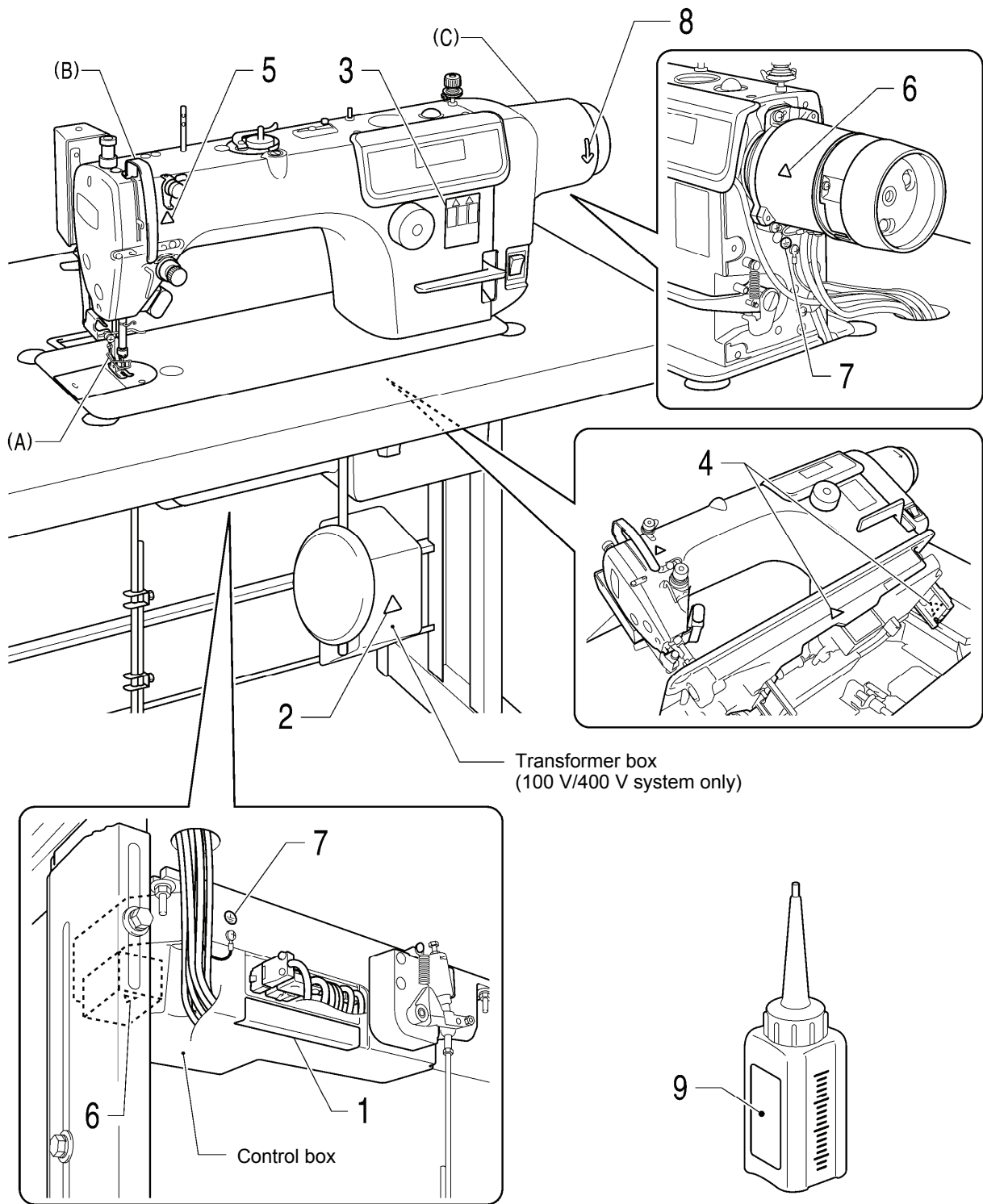

# CONTENTS

<b>1. MACHINE SPECIFICATIONS</b> .....	1	7-8. Adjusting the rotary hook lubrication amount .....	33
<b>2. INSTALLATION</b> .....	2	<b>8. TROUBLESHOOTING</b> .....	34
2-1. Table processing diagram .....	3	8-1. Sewing .....	34
2-2. Installation .....	3	8-2. Error code displays .....	38
2-3. Lubrication .....	6	<b>9. 7-SEGMENT DISPLAY</b> .....	42
2-4. Connecting the cords .....	7		
2-4-1. Connecting the cords .....	7		
2-4-2. Other cords .....	8		
<b>3. USING THE OPERATION PANEL (BASIC OPERATIONS)</b> .....	12		
3-1. Names and functions .....	12		
3-2. Sewing start and end backtack stitches .....	14		
3-3. Sewing continuous backtack stitches .....	15		
<b>4. USING THE OPERATION PANEL (ADVANCED OPERATIONS)</b> .....	16		
4-1. Switching the 4-column display .....	16		
4-2. Setting the sewing speed .....	16		
4-2-1. Setting the maximum sewing speed .....	16		
4-2-2. Setting the start backtack sewing speed .....	17		
4-3. Setting the counters .....	18		
4-3-1. Lower thread counter .....	18		
4-3-2. Thread trimming counter .....	19		
4-3-3. Needle replacement counter .....	20		
4-4. Setting basic functions .....	21		
4-4-1. Changing the needle stop position .....	21		
4-4-2. Correction sewing .....	22		
4-4-3. Setting thread wiping .....	23		
4-5. Adjusting the needle up stop position .....	24		
4-6. Resetting all settings to their defaults .....	25		
<b>5. CLEANING</b> .....	26		
<b>6. REPLACING THE FIXED KNIFE AND MOVABLE KNIFE</b> .....	27		
<b>7. STANDARD ADJUSTMENTS</b> .....	28		
7-1. Adjusting arm thread guide R .....	28		
7-2. Adjusting the presser foot height .....	29		
7-3. Adjusting of the feed dog height .....	30		
7-4. Adjusting the feed dog angle .....	30		
7-5. Adjusting the needle bar height .....	31		
7-6. Adjusting the needle and feed mechanism timing .....	31		
7-7. Adjusting the needle and rotary hook timing .....	32		





# 1. MACHINE SPECIFICATIONS









	3	4
Quick reverse	<input type="radio"/>	<input type="radio"/>
Thread wiper	<input type="radio"/>	<input type="radio"/>

0540D

	3	3A	5
Use	For light to medium-weight materials	For medium-weight materials	For heavy-weight materials
Max. sewing speed	4,500 sti/min	4,500 sti/min	4,000 sti/min
Sewing speed at the time of shipment	4,000 sti/min		
Start backtacking and continuous backtacking speed	220 - 3,000 sti/min		
End backtacking speed	1,800 sti/min		
Max. stitch length	4.2 mm	5 mm	
Presser foot height	6 mm		
	13 mm		
Feed dog height	0.8 mm	1.0 mm	1.2 mm
Needle (DB x 1, DP x 5)	#11 - #18		#19 - #22
Motor	AC servo motor (4-pole, 450 W)		
Control circuit	Microprocessor		

## 2. INSTALLATION

### CAUTION

-  Machine installation should only be carried out by a qualified technician.
  -  Contact your Brother dealer or a qualified electrician for any electrical work that may need to be done.
  -  The sewing machine weighs approximately 32 kg (70lb). The installation should be carried out by two or more people.
  -  Do not connect the power cord until installation is complete. The machine may operate if the treadle is depressed by mistake, which could result in injury.
-  Secure the table so that it will not move when tilting back the machine head. If the table moves, it may crush your feet or cause other injuries.
  -  Use both hands to hold the machine head when tilting it back or returning it to its original position. If only one hand is used, the weight of the machine head may cause your hand to slip, and your hand may get caught.

### About the machine set-up location

- Do not set up this sewing machine near other equipment such as televisions, radios or cordless telephones, otherwise such equipment may be affected by electronic interference from the sewing machine.
- The sewing machine should be plugged directly into an AC wall outlet. Operation problems may result if extension cords are used.

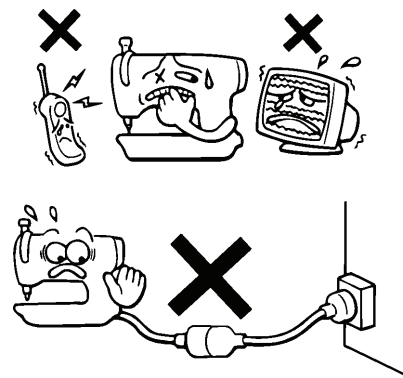

0475D

### Carrying the machine

- The sewing machine should be carried by the arm and the motor cover by two people as shown in the illustration.
- \* Do not hold by any part other than the motor cover. If this is not observed, it may result in damage to the sewing machine.

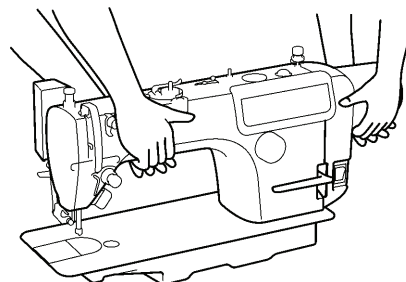

0476D

### Tilting back the machine head

- Hold section (A) with your foot so that the table does not move, and then push the arm with both hands to tilt back the machine head.

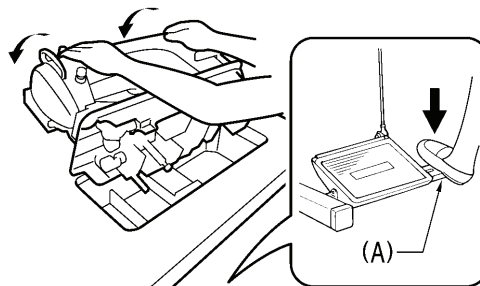

2101B

### Returning the machine head to the upright position

1. Clear away any tools, etc. which may be near the table holes.
2. While holding the face plate with your left hand, gently return the machine head to the upright position with your right hand.

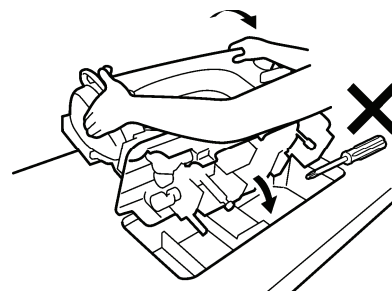

2089M

## 2. INSTALLATION

### 2-1. Table processing diagram

- The top of the table should be 40 mm in thickness and should be strong enough to hold the weight and with-stand the vibration of the sewing machine.
- Drill holes as indicated in the illustration below.

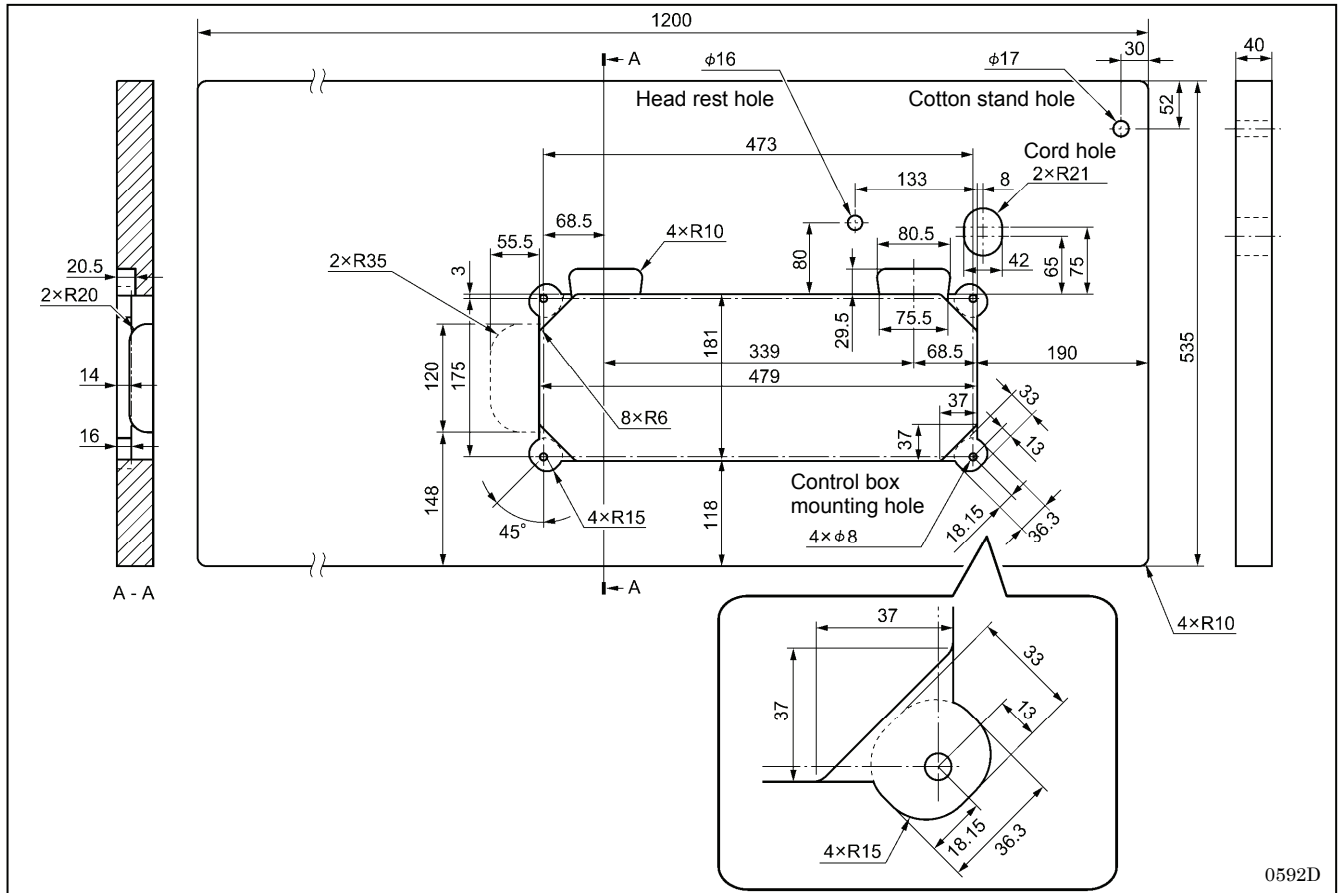

### 2-2. Installation

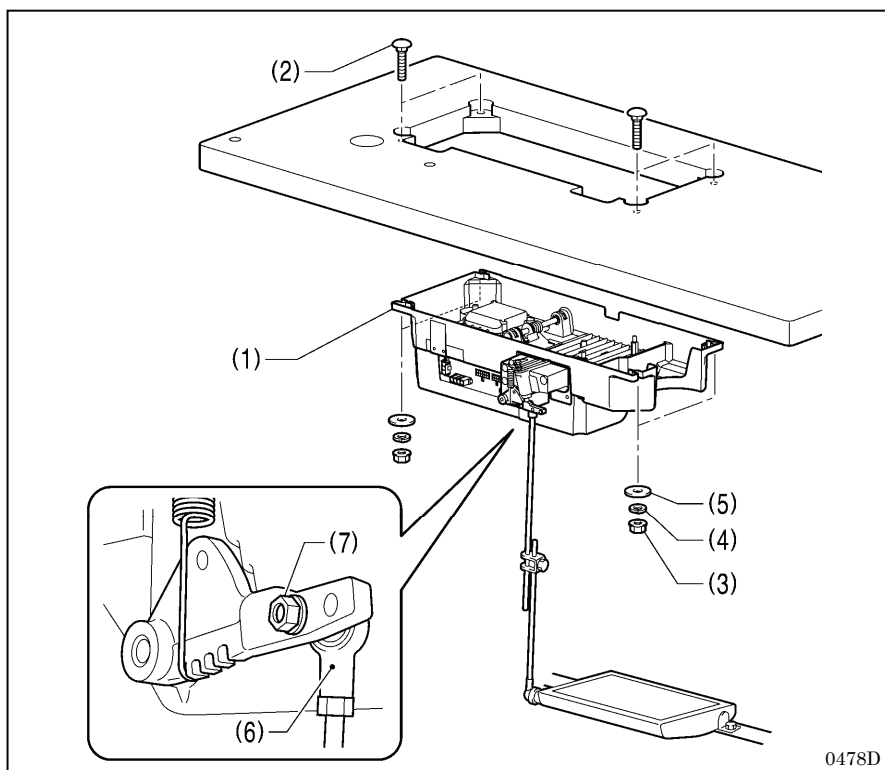

#### 1. Control box + Oil pan

- (1) Control box
- (2) Bolts [4 pcs]
- (3) Nuts [4 pcs]
- (4) Spring washers [4 pcs]
- (5) Washers [4 pcs]

#### 2. Connecting rod

- (6) Connecting rod
- (7) Nut

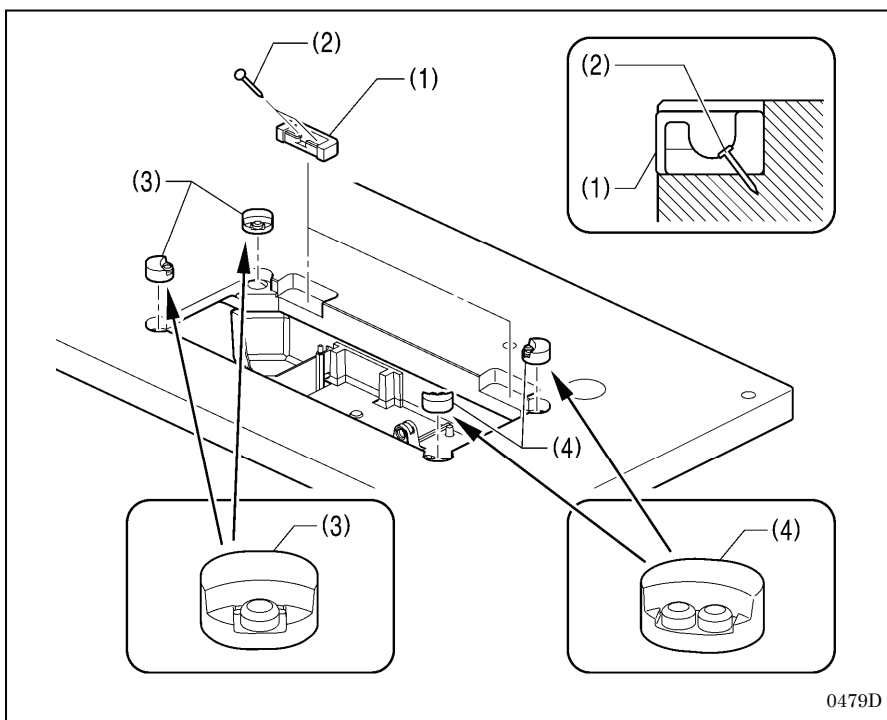

### 3. Rubber cushions

- (1) Rubber cushions [2 pcs]
- (2) Nails [4 pcs]
- (3) Head cushions (left) [2 pcs]
- (4) Head cushions (right) [2 pcs]

0479D

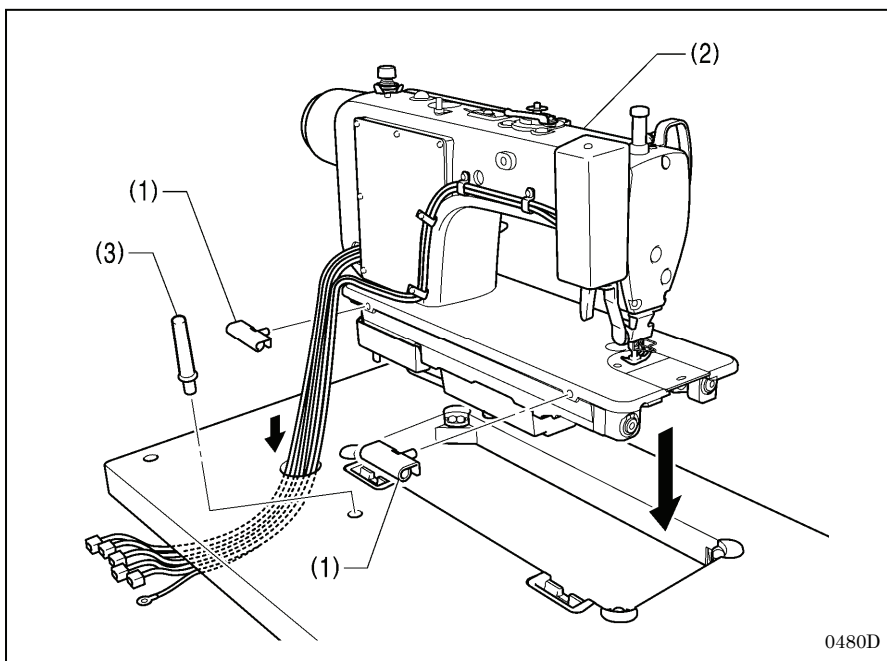

### 4. Machine head

- (1) Hinges [2 pcs]
- (2) Machine head
- (3) Head rest

**NOTE:**

- Bind the cords together and pass them through the cord hole
- Tap the head rest (3) securely into the table hole. If the head rest (3) is not pushed in as far as it will go, the machine head will not be sufficiently stable when it is tilted back.

0480D

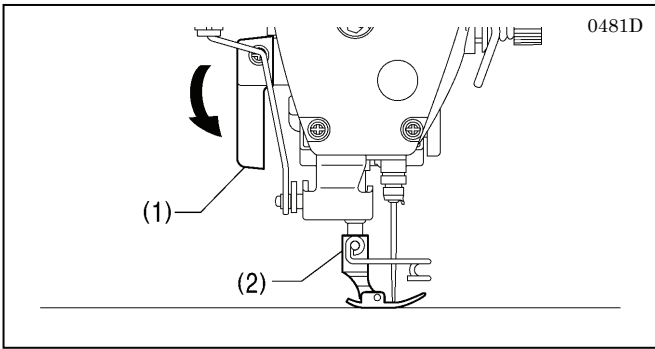

### 5. Knee lifter plate

#### <Knee lifter adjustment>

1. Turn the machine pulley so that the feed dog is below the top of the needle plate.
2. Lower the presser foot (1) by using the lifting lever (2).

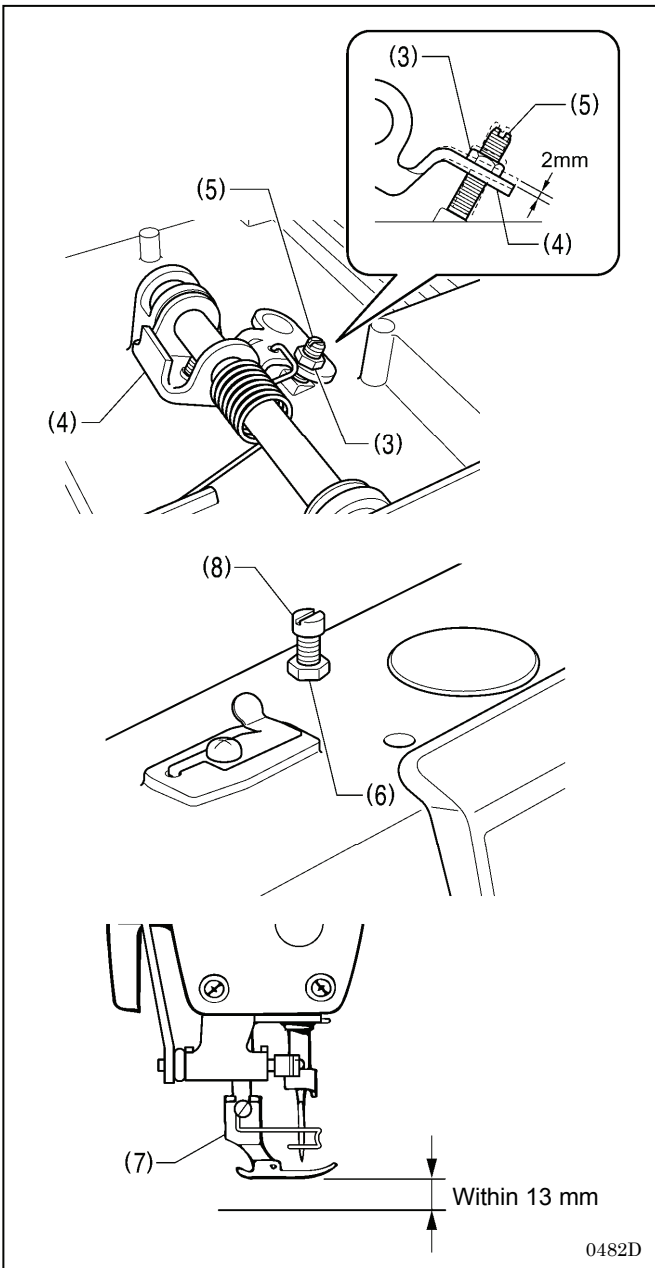



3. Loosen the nut (3).
4. Turn the screw (5) to adjust so that the amount of play in the knee lifter is approximately 2 mm when the knee lifter plate (4) is gently pressed.
5. Securely tighten the nut (3).

6. Loosen the nut (6).
7. Turn the adjusting screw (8) to adjust so that the presser foot (7) is at the desired position within a distance of 13 mm of the needle plate when the knee lifter plate is fully pressed.
8. After adjustment is completed, securely tighten the nut (6).

## 2-3. Lubrication

**CAUTION**

-  Do not connect the power cord until lubrication has been completed, otherwise the machine may operate if the treadle is depressed by mistake, which could result in injury.
-  Be sure to wear protective goggles and gloves when handling the lubricating oil, so that it does not get into your eyes or onto your skin.  
If care is not taken, inflammation can result. Furthermore, do not drink the lubricating oil. Diarrhea or vomiting may result.  
Keep the oil out of the reach of children.
-  When cutting the nozzle of the oil tank, hold the base of the nozzle securely.  
If you hold the end of the nozzle, injury from the scissors may result.

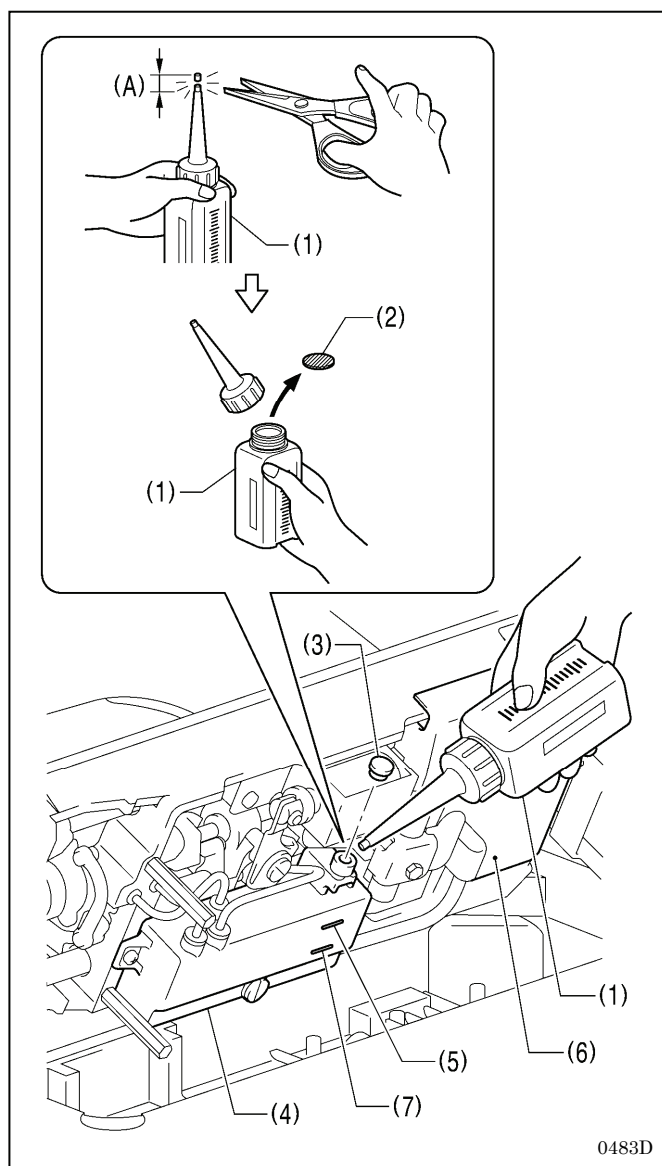

The sewing machine should always be lubricated and the oil supply replenished before it is used for the first time, and also after long periods of non-use.

1. Hold the base of the nozzle of the accessory oil tank (1), and use scissors to cut about half-way along the straight section (A) of the nozzle.
2. Loosen and remove the nozzle, and then remove the seal (2).
3. Tighten the nozzle.
4. Tilt back the machine head.
5. Remove the rubber cap (3), and pour lubricating oil into the oil tank (4) until it reaches the upper reference line (5). (Approx. 150 ml)
6. Replace the rubber cap (3).
7. Return the machine head to its original position.

**NOTE:**

When the machine head is tilted back at times such as the following, lubricating oil may leak out from the oil pan (6).

- 1) If the machine head is tilted back immediately after sewing;
- 2) If the machine head is tilted back a long way when the head rest has been removed;
- 3) If lubricating oil is added until the oil level goes above the upper reference line (5) on the oil tank (4).

**<Lubrication oil replenishment interval>**

If the oil level drops below the lower reference line (7) on the oil tank (4), be sure to replenish the oil.

## 2-4. Connecting the cords

### CAUTION

- ⚠ Contact your Brother dealer or a qualified electrician for any electrical work that may need to be done.
- ⊘ Do not connect the power cord until all cords have been connected.  
The machine may operate if the treadle is depressed by mistake, which could result in injury.

- ⚠ When securing the cords, do not bend the cords excessively or fasten them too hard with staples, otherwise there is the danger that fire or electric shocks could occur.
- ⚡ Be sure to connect the ground. If the ground connection is not secure, you run a high risk of receiving a serious electric shock, and problems with correct operation may also occur.

### 2-4-1. Connecting the cords

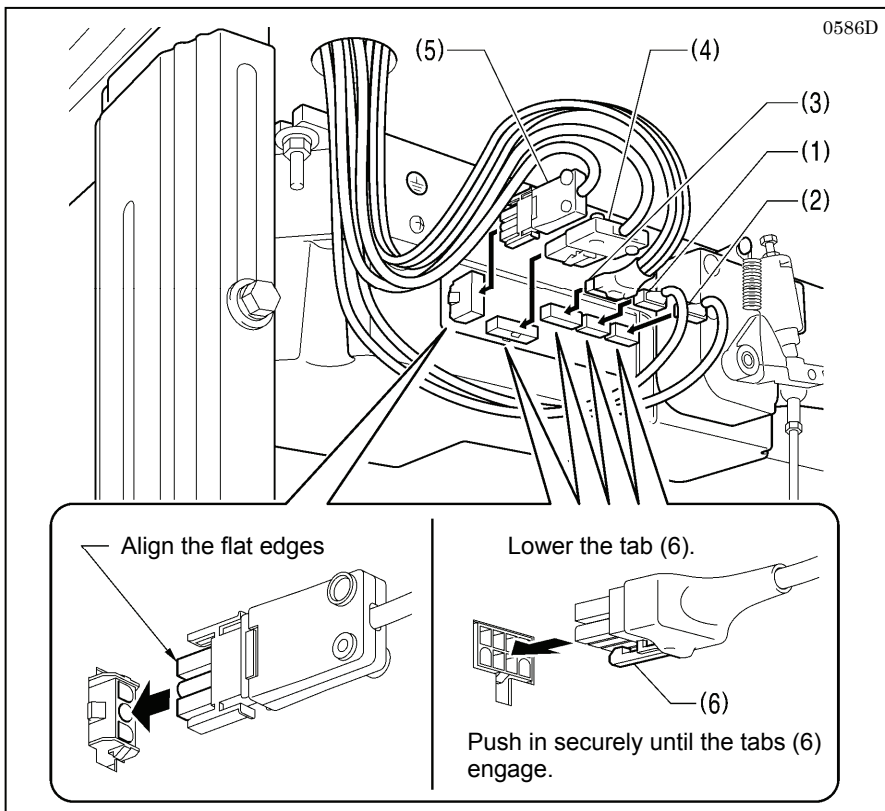

#### 1. Cords

- (1) 8-pin operation panel connector
- (2) 10-pin resolver connector
- (3) 12-pin solenoid connector
- (4) 4-pin motor connector
- (5) 3-pin power supply connector

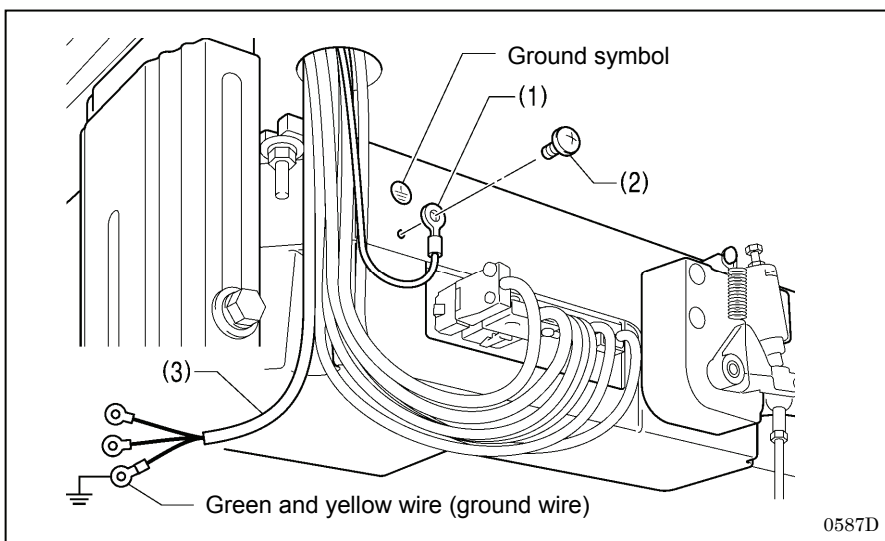

#### 2. Ground wire

- (1) Ground wire
- (2) Screw
- (3) Power cord

1. Attach an appropriate plug to the power cord (3). (The green and yellow wire is the ground wire.)
2. Insert the power plug into a properly-grounded electrical outlet.

#### NOTE:

For Europe specifications, Americas 220 V specifications and 100 V/400 V system specifications, refer to "2-4-2. Other cords".



### 2-4-2. Other cords

For Europe specifications, Americas 220V specifications and 100 V/400 V system specifications, connect the cords according to the respective specifications.

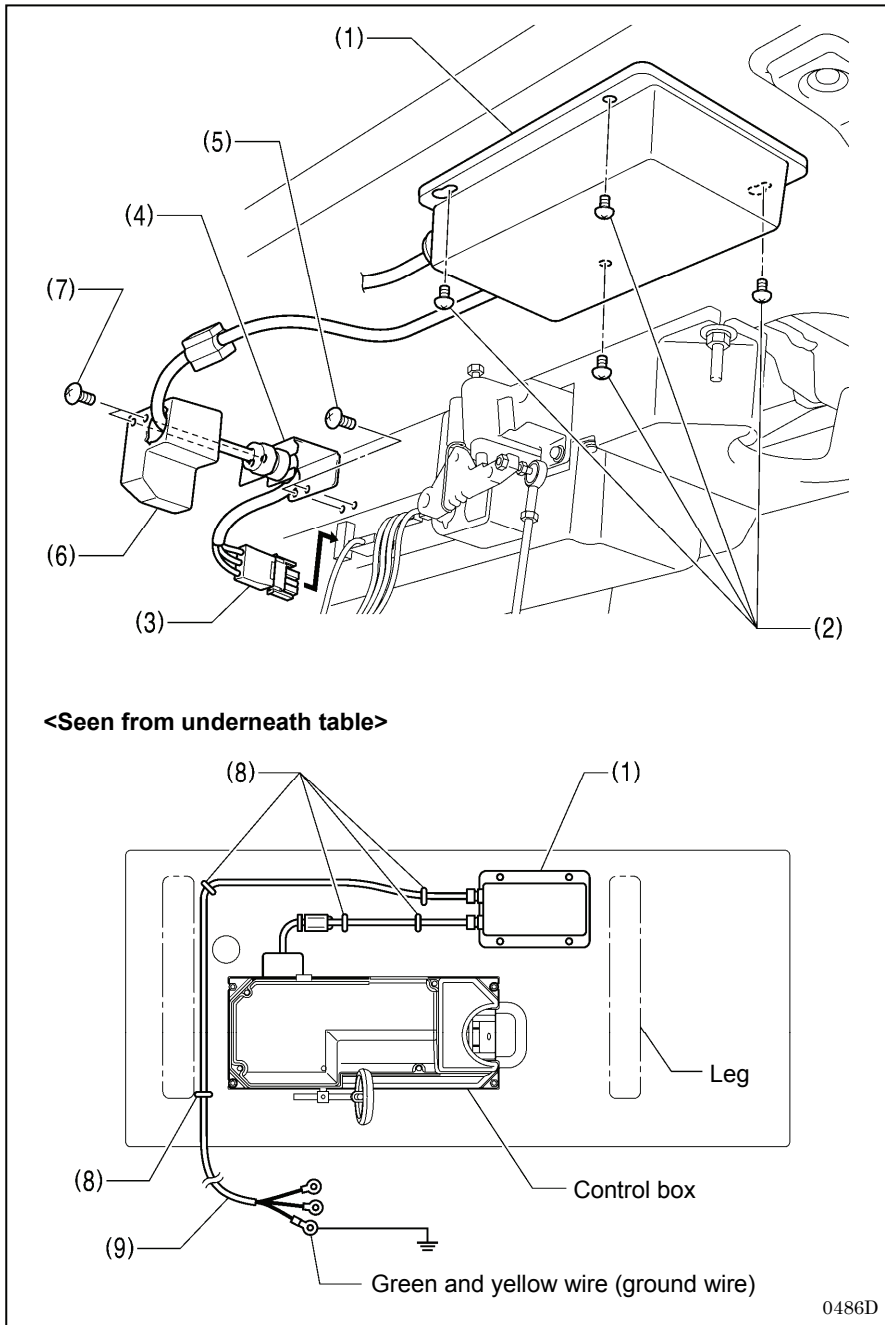

**<Europe specifications>**

- (1) Filter box
- (2) Screws [4 pcs]
- (3) Connector
- (4) CE bush plate
- (5) Screws [2 pcs]
- (6) CE D cord cover
- (7) Screws [2 pcs]
- (8) Staples [5 pcs]
- (9) Power cord

1. Attach an appropriate plug to the power cord (9). (The green and yellow wire is the ground wire.)
2. Insert the power plug into a properly-grounded electrical outlet.

**NOTE:**

- Take care when tapping in the staples (8) to make sure that they do not pierce the cords.
- Do not use extension cords, otherwise machine operation problems may result.

0486D

## 2. INSTALLATION

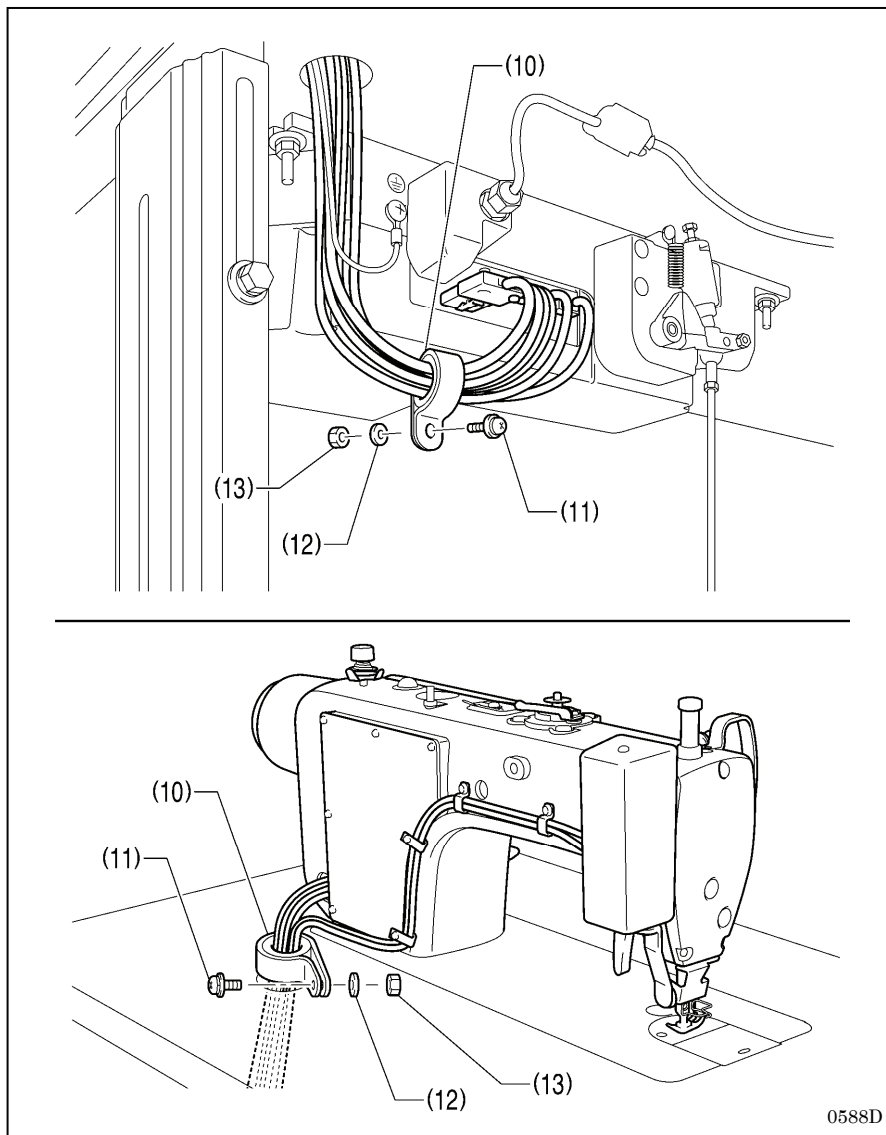

3. Install the cores (10) in the two places shown in the illustration.

- (10) Core [2 pcs]
- (11) Screws [2 pcs]
- (12) Washers [2 pcs]
- (13) Nuts [2 pcs]

0588D

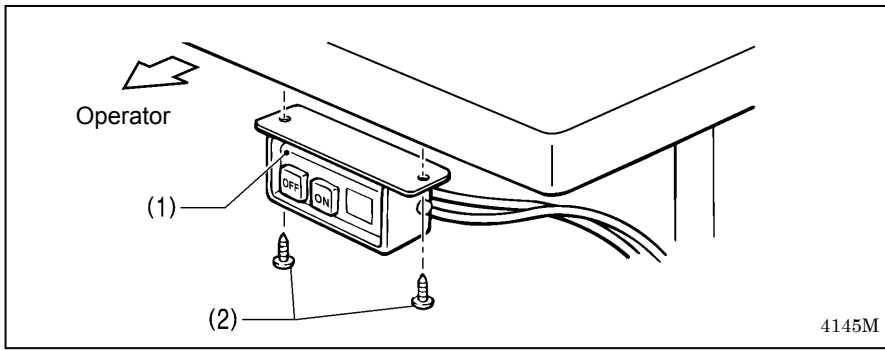

<For Americas 220V specifications>

- (1) Power switch
- (2) Screws [2 pcs]

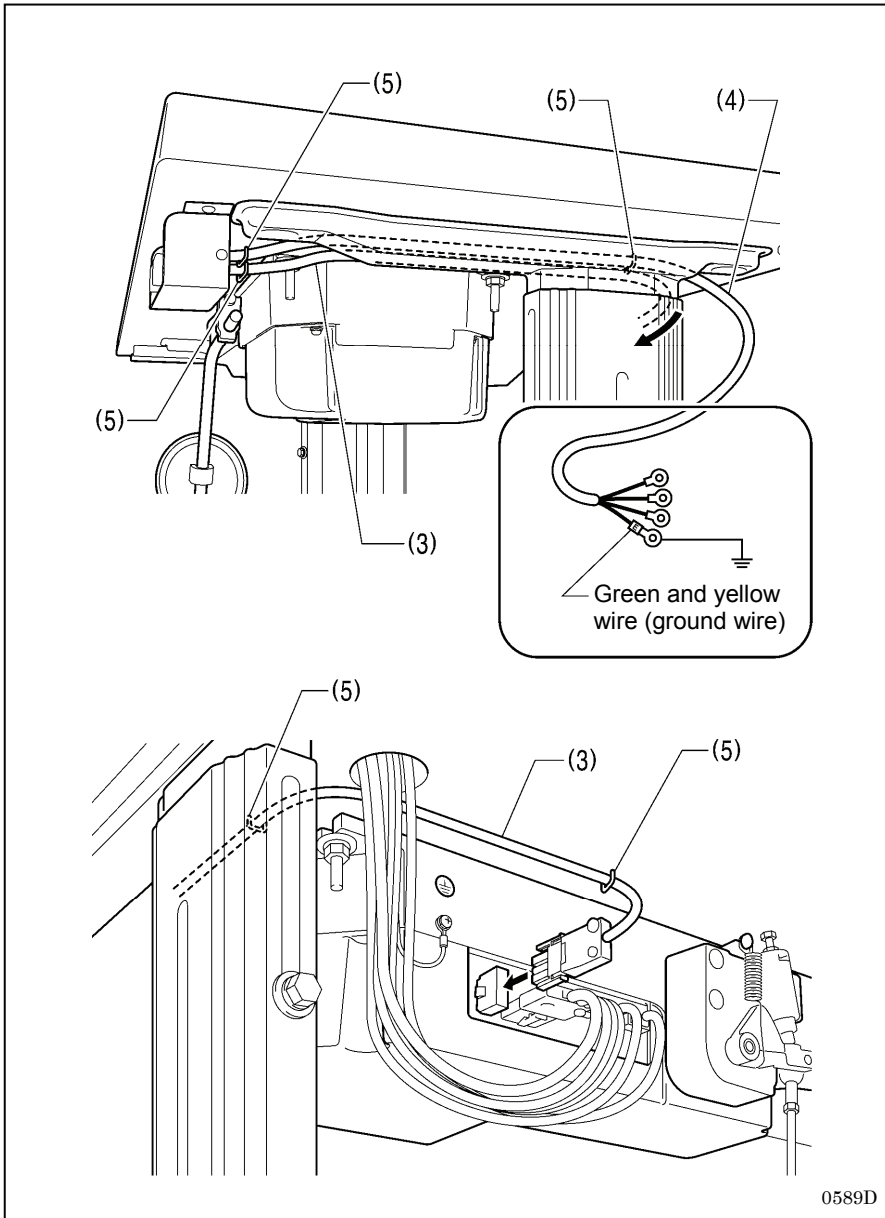

- (3) 3-pin power supply connector
- (4) Power cord
- (5) Staples [5 pcs]

1. Attach an appropriate plug to the power cord (4). (The green and yellow wire is the ground wire.)
2. Insert the power plug into a properly-grounded electrical outlet.

**NOTE:**

- Take care when tapping in the staples (5) to make sure that they do not pierce the cords.
- Do not use extension cords, otherwise machine operation problems may result.

## 2. INSTALLATION

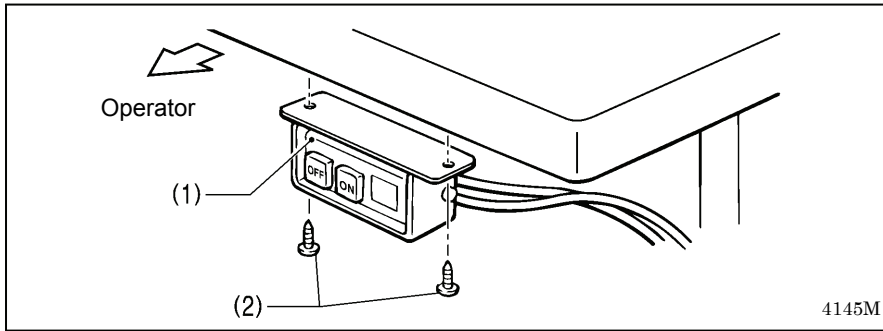

<For 100V/400V system specifications>

- (1) Power switch
- (2) Screws [2 pcs]

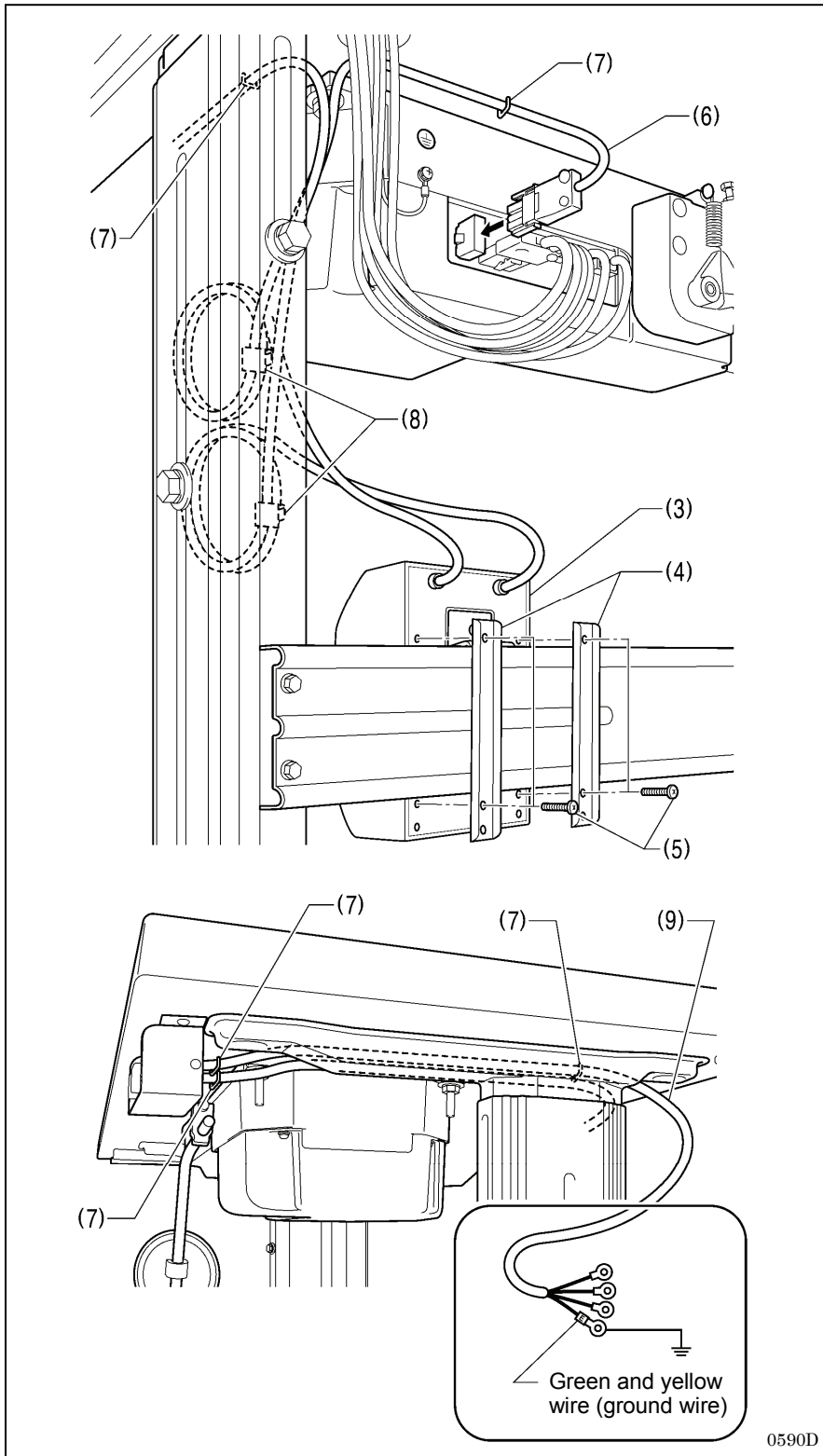

- (3) Transformer box
- (4) Transformer box plates [2 pcs]
- (5) Screw [with washer]
- (6) 3-pin power supply connector
- (7) Staples [5 pcs]
- (8) Cord clamps [2 pcs]
- (9) Power cord

1. Attach an appropriate plug to the power cord (9). (The green and yellow wire is the ground wire.)
2. Insert the power plug into a properly-grounded electrical outlet.

### NOTE:

- Take care when tapping in the staples (7) to make sure that they do not pierce the cords.
- Do not use extension cords, otherwise machine operation problems may result.

## 3. USING THE OPERATION PANEL (BASIC OPERATIONS)

### 3-1. Names and functions

- The operation panel keys cannot be operated while sewing is in progress. Select the keys and set the number of stitches before starting sewing.
- In the case of keys with indicators, the indicator illuminates when that function is operating, and the indicator switches off when the key is pressed once more.

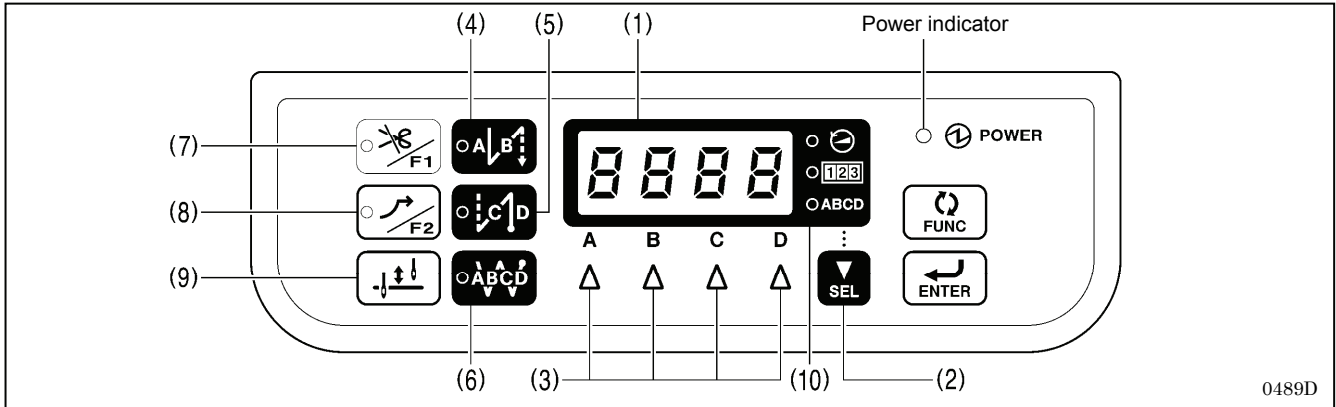

The power indicator illuminates when the power switch is turned on.

#### (1) Display



- When start backtick stitches are being displayed, the indicator of the start backtick key (4) will illuminate, and the number of A stitches will appear in the A column and the number of B stitches will appear in the B column.
- When end backtick stitches are being displayed, the indicator of the end backtick key (5) will illuminate, and the number of C stitches will appear in the C column and the number of D stitches will appear in the D column.
- When continuous backtick stitches are displayed, the indicator of the continuous backtick key (6) will illuminate, and the number of A, B, C and D stitches will appear in order starting from the left column of the display.
- The three indicators on the right side of the window show which value is appearing in the four columns of the display. The four-column display shows the speed, counter and stitches. When the stitches are being displayed, the ABCD indicator (10) will illuminate.

0490D

#### (2) SEL (Select) key



The value in the display (1) can be changed each time this switch is pressed.

0491D

#### (3) Setting keys

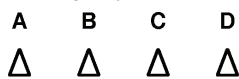

These keys are used to set the number of backtick stitches for A, B, C and D.

- When the  $\Delta$  key is pressed, the setting increases from 0 up to 9.
- If you press the key once more when "9" is displayed, the value will return to "0".

0492D

#### (4) Start backtick key



When this key is pressed so that the indicator illuminates, the number of start backtick stitches (0 - 9) in the A and B columns of the display are sewn.

0493D

#### (5) End backtick key



When this key is pressed so that the indicator illuminates, the number of end backtick stitches (0 - 9) in the C and D columns of the display are sewn. When the treadle is depressed backward, the end backtick stitches are sewn and then the thread is trimmed automatically.

If the treadle has not yet been depressed backward, the end backtick function can be set to ON, the number of stitches can be changed and the function can be set back to OFF.

0494D

#### (6) Continuous backtick key



When this key is pressed so that the indicator illuminates, the number of backtick stitches (0 - 9) in the A, B, C and D columns of the display are sewn continuously. After the sewing machine sews a full cycle of stitches set by A, B, C and D, the thread is trimmed automatically.

0495D

### 3. USING THE OPERATION PANEL (BASIC OPERATIONS)

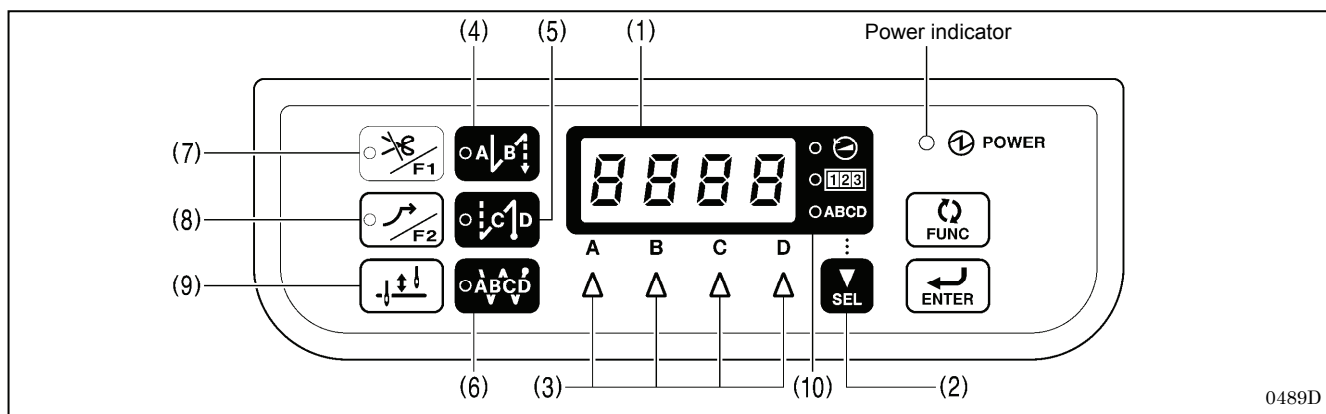

0489D

(7) Thread trimming disable/F1 key

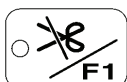

When this key is pressed so that the indicator illuminates, the sewing machine stops in the needle up position without thread trimming being carried out even if the treadle is depressed backward.

0496D

(8) Slow start/F2 key



When this key is pressed so that the indicator illuminates, sewing is carried out at 700 sti/min for the first two stitches at the next sewing start after thread trimming. After this, the sewing speed corresponds to the treadle depression amount.

0497D

(9) Half stitch key

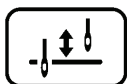

When the sewing machine is stopped, the needle bar can be moved up and down by pressing this key.

0498D

### 3-2. Sewing start and end backtick stitches

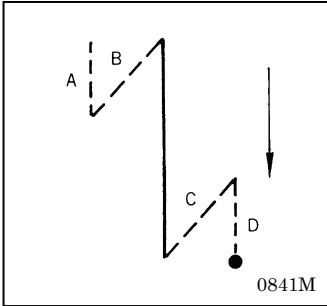

#### 1 Setting start backtick stitches

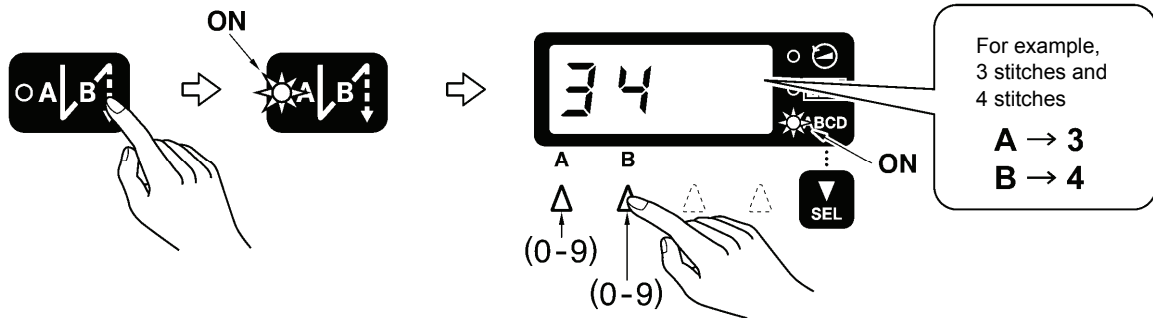

0499D

#### 2 Setting end backtick stitches

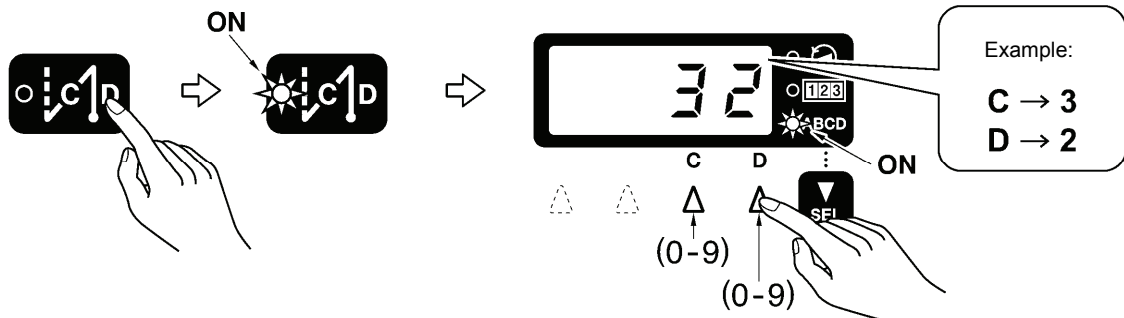

0500D

**3** Start backtacking is carried out. After it has finished, normal sewing continues for as long as the treadle remains depressed.

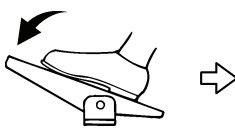

**NOTE:**

If the treadle is returned to the neutral position, the sewing machine will continue operating until the set number of start backtick stitches has been sewn.

2159M

**4** End backtacking is carried out. After it has finished, the thread is trimmed automatically and the sewing machine stops in the needle up position.

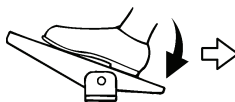

**NOTE:**

- If the treadle is depressed backward before sewing of the set number of start backtick stitches is complete, end backtacking will not be carried out.
- If thread trimming lock is set, the sewing machine will stop in the needle up position without thread trimming being carried out.

2160M

### 3-3. Sewing continuous backtack stitches

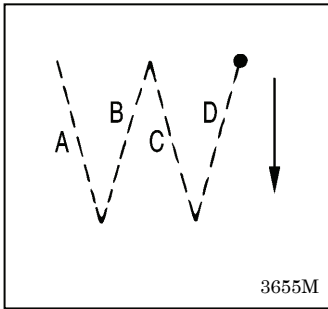

#### 1 Setting continuous backtack stitches

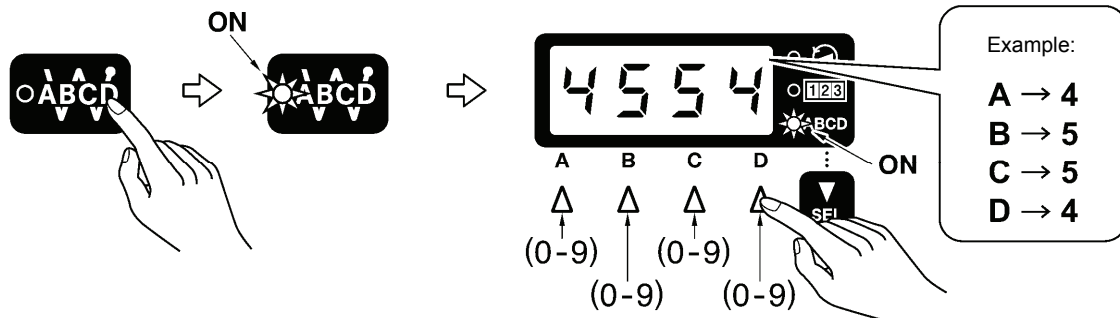

0501D

#### 2

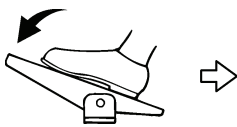

If the treadle is simply depressed continuously, the number of stitches set for A, B, C and D will be sewn in a single cycle, the thread will be trimmed automatically and then the needle bar will stop in the needle up position.

**NOTE:**

- If the treadle is returned to the neutral position while continuous backtacking is being carried out, the sewing machine will stop at the point where the treadle returns to the neutral position. If the treadle is depressed again, operation will resume from the point where it was interrupted.
- If thread trimming lock is set, the sewing machine will stop in the needle up position without thread trimming being carried out.

2159M



# 4. USING THE OPERATION PANEL (ADVANCED OPERATIONS)

The operations described in this section should only be carried out by a technician.

## 4-1. Switching the 4-column display

- The 4-column data in the display can be changed to one of the following three statuses each time the SEL key is pressed. Stitch number display or no display → Sewing speed display → Counter display
- When the sewing speed display/counter display appears, you can press the FUNC key to switch to another display.

Display mode				Four columns display
No display				
Stitch number display			ON	ABCD stitch number display
Sewing speed display	ON			Maximum sewing speed setting value
	ON		ON	Start backtack sewing speed setting value
Counter display		ON		Lower thread counter value
		Flashing		Lower thread counter warning enabled
	ON	ON		Thread trimming counter value
		ON	ON	Needle replacement counter value
		Flashing	Flashing	Needle replacement counter warning enabled

0502D 0503D 0504D

## 4-2. Setting the sewing speed

### 4-2-1. Setting the maximum sewing speed

1

Press the SEL key so that the SPEED indicator is illuminated.

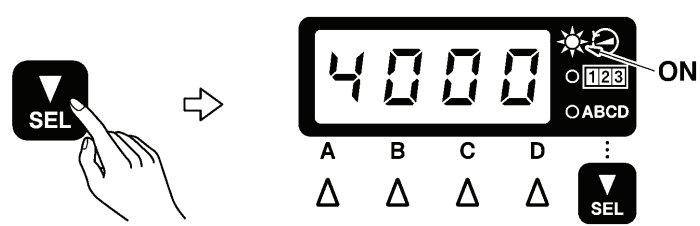

- The maximum sewing speed setting value will appear in the four columns of the display.

0505D

---

2

Press the A or B key to change the setting value.

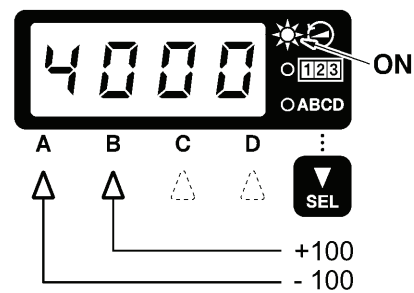

- When the B key is pressed, the setting increases by 100.
- When the A key is pressed, the setting decreases by 100.

**NOTE:**  
The setting range is from 220 to 4000 sti/min.

0506D

### 4-2-2. Setting the start backtack sewing speed

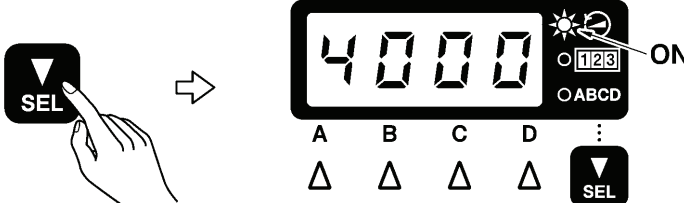
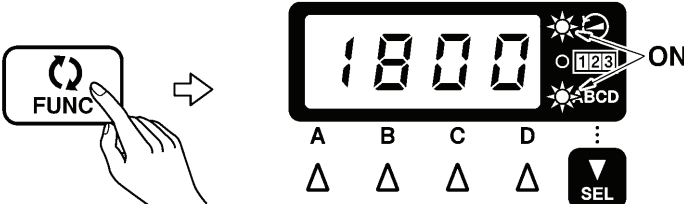
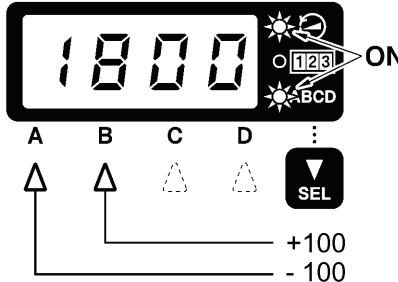
<p><b>1</b></p>	<p>Press the SEL key so that the SPEED indicator is illuminated.</p>  <ul style="list-style-type: none"> <li>• The maximum sewing speed setting value will appear in the four columns of the display.</li> </ul>	<p>0505D</p>
<p><b>2</b></p>	<p>Press the FUNC key.</p>  <ul style="list-style-type: none"> <li>• The ABCD indicator will illuminate and the start backtack sewing speed setting value will appear in the four columns of the display.</li> </ul> <p><b>NOTE:</b> If the FUNC key is pressed once more, the ABCD indicator will switch off and the display will return to the maximum sewing speed setting value.</p>	<p>0507D</p>
<p><b>3</b></p>	<p>Press the A <math>\Delta</math> or B <math>\Delta</math> key to change the setting value.</p>  <ul style="list-style-type: none"> <li>• When the B <math>\Delta</math> key is pressed, the setting increases by 100.</li> <li>• When the A <math>\Delta</math> key is pressed, the setting decreases by 100.</li> </ul> <p><b>NOTE:</b> The setting range is from 220 to 3000 sti/min.</p>	<p>0508D</p>

### 4-3. Setting the counters

The lower thread counter, thread trimming counter and needle replacement counter can be displayed. The three counters can be operated at the same time.

#### 4-3-1. Lower thread counter

The lower thread counter can be used to let you know approximately how much lower thread is remaining.

##### <Setting the lower thread counter initial value>

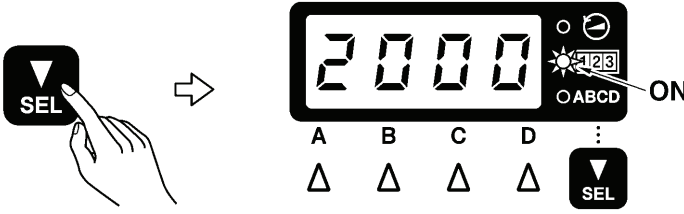
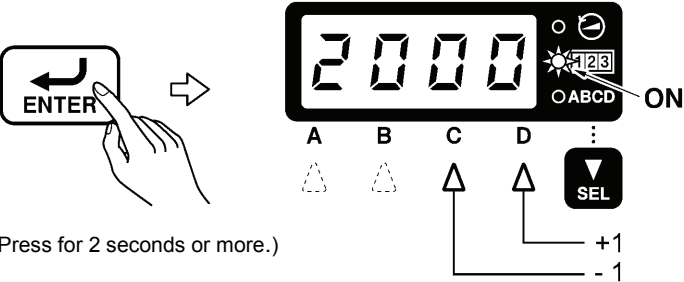
<b>1</b>	<p>Press the SEL key so that the COUNT indicator is illuminated.</p> 	<ul style="list-style-type: none"> <li>The lower thread counter value will appear in the four columns of the display.</li> </ul>
<b>2</b>	<p>Press the ENTER key for 2 seconds or more, and then press the C <math>\Delta</math> or D <math>\Delta</math> key to set the initial value.</p>  <p>(Press for 2 seconds or more.)</p>	<ul style="list-style-type: none"> <li>When the D <math>\Delta</math> key is pressed, the setting increases by 1.</li> <li>When the C <math>\Delta</math> key is pressed, the setting decreases by 1.</li> </ul> <p><b>NOTE:</b></p> <ul style="list-style-type: none"> <li>The setting range is from 0 to 9999.</li> <li>If an initial value of "0" is set, the lower thread counter will not operate.</li> </ul>

##### <Lower thread counter operation>

- The lower thread counter is reduced by 1 from the initial setting value each time the sewing machine sews 10 stitches, and a warning is given when the counter goes below "0".

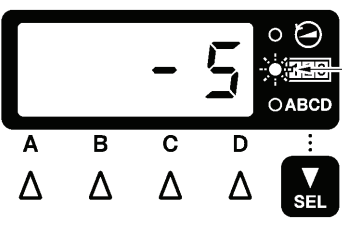

When the warning occurs, the COUNT indicator flashes, and a buzzer sounds for 5 seconds.

- Sewing will be possible even after the treadle is returned to the neutral position and the sewing machine stops. However, after the treadle has been depressed backward and thread trimming has been carried out, sewing using the treadle will no longer be possible.  
If the treadle is depressed at this time, "Ent" will appear in the display. When the treadle is returned to the neutral position, the display will return to the current counter display.
- If the ENTER key is pressed while the lower thread counter is displayed, the COUNT indicator will change to illuminated and sewing can then be carried out using the treadle.  
If the ENTER key is pressed again for 2 seconds or more, the counter display will return to the initial value and counting from the initial value will be possible.

### 4-3-2. Thread trimming counter

The lower thread counter can be used to let you know approximately how many items can be sewn.

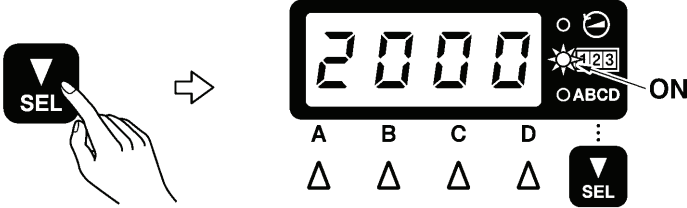
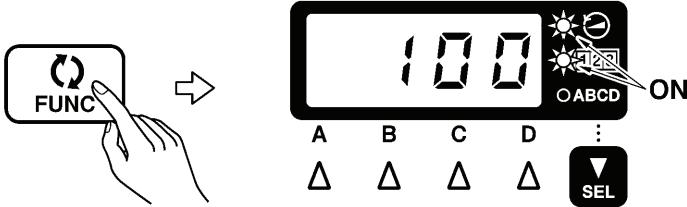
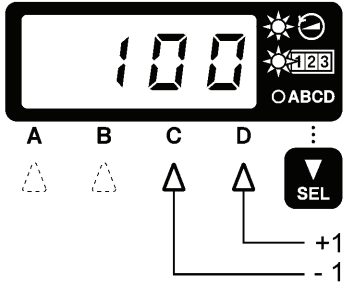
<p><b>1</b></p>	<p>Press the SEL key so that the COUNT indicator is illuminated.</p> 	<ul style="list-style-type: none"> <li>• The lower thread counter value will appear in the four columns of the display.</li> </ul>
<p><b>2</b></p>	<p>When the FUNC key is pressed once, the thread trimming counter display will appear.</p> 	<ul style="list-style-type: none"> <li>• The thread trimming counter will appear in the four columns of the display.</li> </ul>
<p><b>3</b></p>	<p>After the thread trimming operation is complete, the counter will be incremented.</p>	<p><b>NOTE:</b> The counter is incremented even if thread trimming is set to disabled.</p>
<p><b>4</b></p>	<p>When the thread trimming counter is displayed, you can press the C <math>\Delta</math> or D <math>\Delta</math> key to adjust the counter value (0 to 9999).</p> 	<ul style="list-style-type: none"> <li>• When the D <math>\Delta</math> key is pressed, the counter value increases by 1.</li> <li>• When the C <math>\Delta</math> key is pressed, the counter value decreases by 1.</li> </ul>

### 4-3-3. Needle replacement counter

#### <Setting the needle replacement counter initial value>

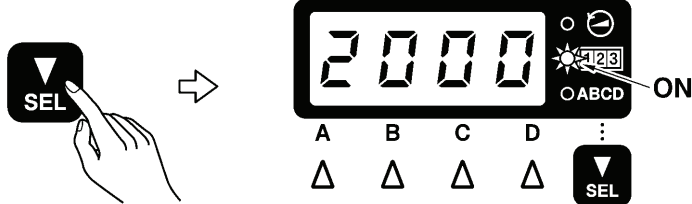
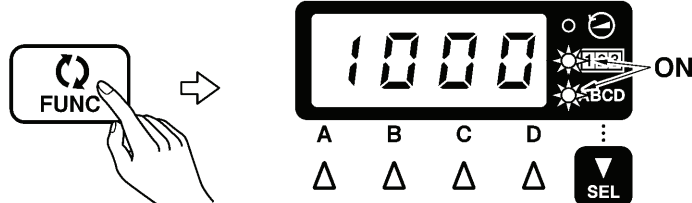
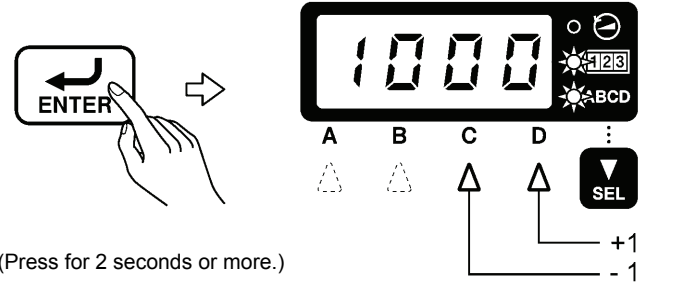
<p><b>1</b></p>	<p>Press the SEL key so that the COUNT indicator is illuminated.</p>  <p>The lower thread counter value will appear in the four columns of the display.</p>	<p>• The lower thread counter value will appear in the four columns of the display.</p>
<p><b>2</b></p>	<p>When the FUNC key is pressed two times, the needle replacement counter display will appear.</p>  <p>(Press two times.)</p> <p>The needle replacement counter value will appear in the four columns of the display.</p>	<p>• The needle replacement counter value will appear in the four columns of the display.</p>
<p><b>3</b></p>	<p>Press the ENTER key for 2 seconds or more, and then press the C <math>\Delta</math> or D <math>\Delta</math> key to set the initial value.</p>  <p>(Press for 2 seconds or more.)</p> <p>When the D <math>\Delta</math> key is pressed, the setting increases by 1. When the C <math>\Delta</math> key is pressed, the setting decreases by 1.</p> <p><b>NOTE:</b></p> <ul style="list-style-type: none"> <li>• The setting range is from 0 to 9999.</li> <li>• If an initial value of "0" is set, the needle replacement counter will not operate.</li> </ul>	<p>• When the D <math>\Delta</math> key is pressed, the setting increases by 1. When the C <math>\Delta</math> key is pressed, the setting decreases by 1.</p> <p><b>NOTE:</b></p> <ul style="list-style-type: none"> <li>• The setting range is from 0 to 9999.</li> <li>• If an initial value of "0" is set, the needle replacement counter will not operate.</li> </ul>

#### <Needle replacement counter operation>

- The needle replacement counter is reduced by 1 from the initial setting value each time the sewing machine sews 100 stitches, and a warning is given when the counter goes below "0".

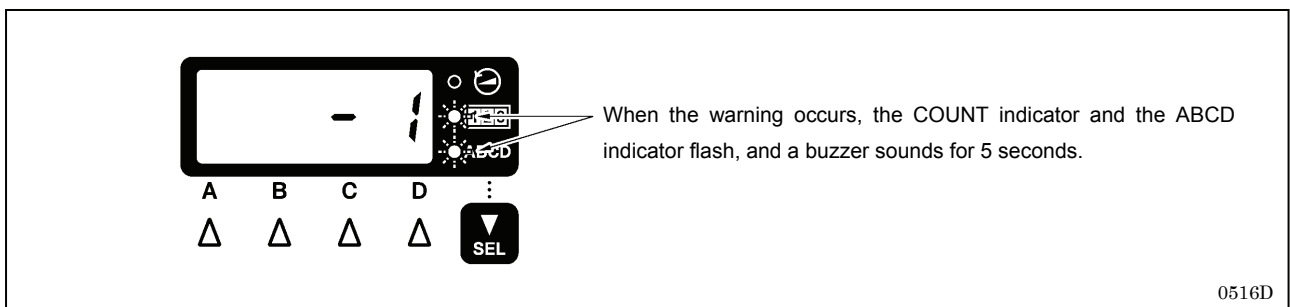

- Sewing will be possible even after the treadle is returned to the neutral position and the sewing machine stops. However, after the treadle has been depressed backward and thread trimming has been carried out, sewing using the treadle will no longer be possible.  
If the treadle is depressed at this time, "Ent" will appear in the display.  
When the treadle is returned to the neutral position, the display will return to the current counter display.
- If the ENTER key is pressed while the needle replacement counter is displayed, the COUNT indicator and the ABCD indicator will change to illuminated and sewing can then be carried out using the treadle.  
If the ENTER key is pressed again for 2 seconds or more, the counter display will return to the initial value and counting from the initial value will be possible.



### 4-4. Setting basic functions

If you turn on the power switch while pressing the thread trimming disable/F1 key, you can then make the following settings.

Setting item	Four columns display	Initial value	Reference item
Needle stop position	<b>Updn</b>	Needle down stop	Refer to "4-4-1".
Correction	<b>Corr</b>	None	Refer to "4-4-2".
Slow start	<b>SLoW</b>	None	Setting can be carried out by pressing the slow start/F2 key.
Thread trimming disable	<b>trdi</b>	None	Setting can be carried out by pressing the thread trimming/F1 key.
Thread wiping	<b>WiP</b>	Enabled	Refer to "4-4-3".
Needle tip illumination lamp brightness adjustment	<b>LAMP</b>	Fully illuminated	Refer to the Service Manual.

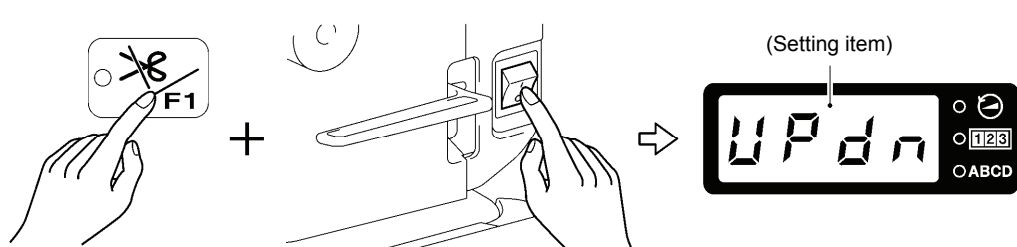
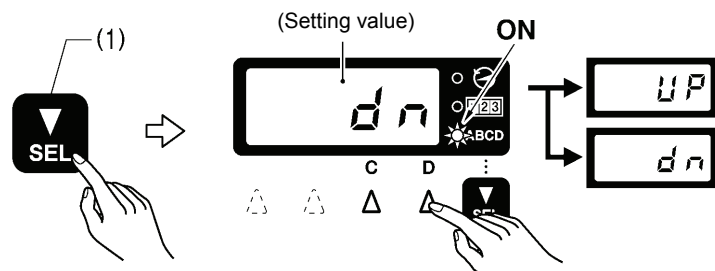
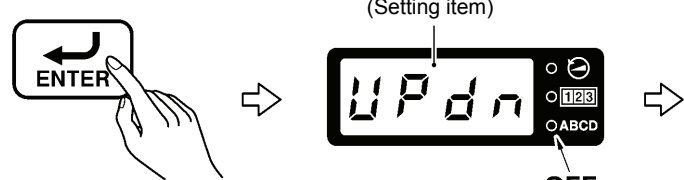

#### 4-4-1. Changing the needle stop position

This sets whether the needle bar stops in the needle up stop position or the needle down stop position when the treadle is returned to the neutral position and sewing stops.

<b>1</b>	<p>Activating setting mode</p>  <p>(Setting item)</p> <p>(While pressing the thread trimming disable/F1 key, turn on the power switch.)</p> <p style="text-align: right;">0517D</p>
<b>2</b>	<p>Setting the needle up stop and needle down stop positions</p>  <p>(Setting value)</p> <ul style="list-style-type: none"> <li>• When the D <math>\Delta</math> key is pressed, the "UP" display will appear.</li> <li>• When the C <math>\Delta</math> key is pressed, the "dn" display will appear.</li> </ul> <p>... Needle up stop</p> <p>... Needle down stop</p> <p><b>NOTE:</b> If the SEL key (1) is pressed once more, the ABCD indicator will switch off and the display will return to the setting item.</p> <p style="text-align: right;">0518D</p>
<b>3</b>	<p>The setting will be stored and the display will return to the setting item.</p>  <p>(Setting item)</p> <p style="text-align: right;">0519D</p>
<b>4</b>	<p>Setting mode will be exited and normal operation will be possible.</p>  <p style="text-align: right;">0520D</p>

### 4-4-2. Correction sewing

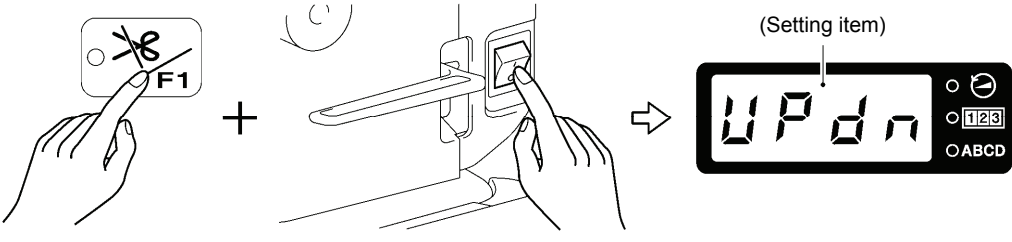
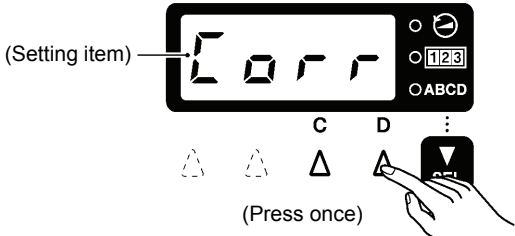
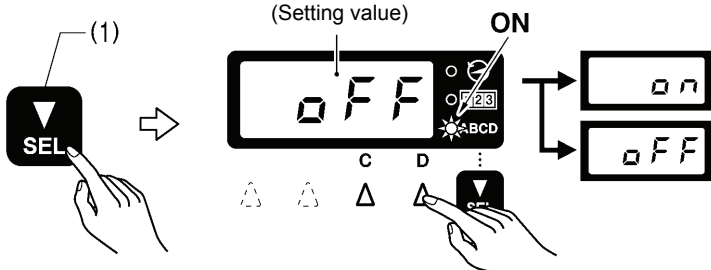
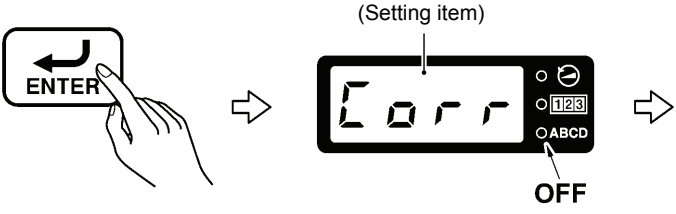

When correction sewing is enabled, sewing will be carried out at slow speed (220 sti/min) while the actuator switch is being pressed when the sewing machine is stopped.

<p><b>1</b></p>	<p>Activating setting mode</p>  <p>(While pressing the thread trimming disable/F1 key, turn on the power switch.)</p> <p style="text-align: right;">0517D</p>
<p><b>2</b></p>	<p>Selecting "Corr" (correction sewing)</p>  <ul style="list-style-type: none"> <li>• When the D <math>\Delta</math> key is pressed, the next setting is displayed.</li> <li>• When the C <math>\Delta</math> key is pressed, the previous setting is displayed.</li> </ul> <p style="text-align: right;">0521D</p>
<p><b>3</b></p>	<p>Enabling and disabling correction sewing</p>  <ul style="list-style-type: none"> <li>• When the D <math>\Delta</math> key is pressed, the "on" display will appear.</li> <li>• When the C <math>\Delta</math> key is pressed, the "oFF" display will appear.</li> </ul> <p>... Correction sewing enabled</p> <p>... Correction sewing disabled</p> <p><b>NOTE:</b> If the SEL key (1) is pressed once more, the ABCD indicator will switch off and the display will return to the setting item.</p> <p style="text-align: right;">0518D</p>
<p><b>4</b></p>	 <p>The setting will be stored and the display will return to the setting item.</p> <p style="text-align: right;">0523D</p>
<p><b>5</b></p>	 <p>Setting mode will be exited and normal operation will be possible.</p> <p style="text-align: right;">0520D</p>

### 4-43. Setting thread wiping

The initial setting value is ON.

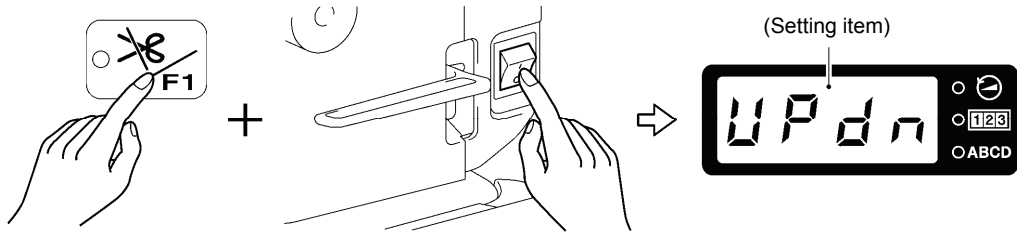
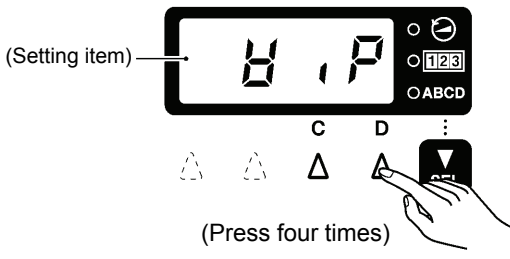
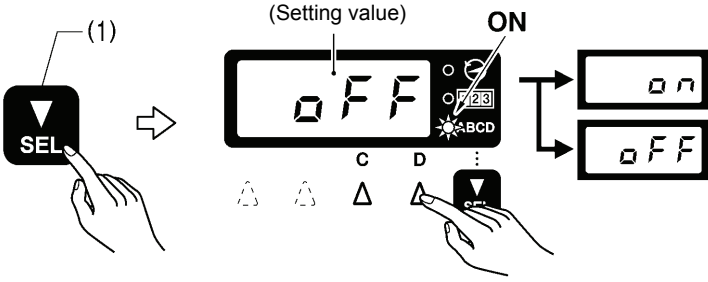
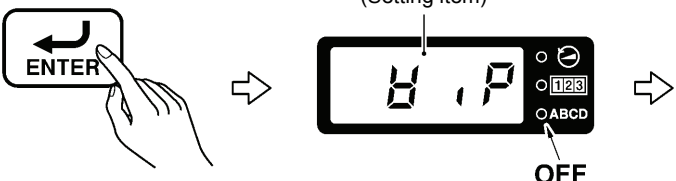
If the thread wiper is connected but thread wiping is not to be carried out, change this setting to OFF.

<p><b>1</b></p>	<p>Activating setting mode</p>  <p>(While pressing the thread trimming disable/F1 key, turn on the power switch.)</p>	<p>(Setting item)</p> <p>0517D</p>
<p><b>2</b></p>	<p>Selecting "WiP" (thread wiping)</p>  <p>(Press four times)</p>	<ul style="list-style-type: none"> <li>• When the D <math>\Delta</math> key is pressed, the next setting is displayed.</li> <li>• When the C <math>\Delta</math> key is pressed, the previous setting is displayed.</li> </ul> <p>0524D</p>
<p><b>3</b></p>	<p>Enabling and disabling thread wiping</p>  <p>(Setting value)</p> <p>ON</p> <p>OFF</p> <p>Thread wiping enabled</p> <p>Thread wiping disabled</p>	<ul style="list-style-type: none"> <li>• When the D <math>\Delta</math> key is pressed, the "on" display will appear.</li> <li>• When the C <math>\Delta</math> key is pressed, the "oFF" display will appear.</li> </ul> <p><b>NOTE:</b> If the SEL key (1) is pressed once more, the ABCD indicator will switch off and the display will return to the setting item.</p> <p>0522D</p>
<p><b>4</b></p>	<p>(Setting item)</p>  <p>OFF</p>	<p>The setting will be stored and the display will return to the setting item.</p> <p>0525D</p>
<p><b>5</b></p>		<p>Setting mode will be exited and normal operation will be possible.</p> <p>0520D</p>





### 4-5. Adjusting the needle up stop position

<p><b>1</b></p>	<p>(1)</p> <p>(2)</p>	<p>(While pressing the <math>\Delta</math> key (1), turn on the power switch.)</p> <p>“MorG” will appear in the display (2).</p> <p>0526D</p>
<p><b>2</b></p>	<p>(Setting item)</p> <p>(Press once)</p>	<p>0527D</p>
<p><b>3</b></p>	<p>(Setting value)</p> <p>Example</p> <p>5</p> <p>ON</p> <p>Becomes higher</p> <p>Becomes lower</p>	<ul style="list-style-type: none"> <li>• If the D <math>\Delta</math> key is pressed, the setting value will increase and the needle up stop position will become lower.</li> <li>• If the C <math>\Delta</math> key is pressed, the setting value will decrease and the needle up stop position will become higher.</li> <li>• The setting range is from -5 to 10.</li> </ul> <p><b>NOTE:</b> A setting value of “10” corresponds to an angle of rotation of approximately 10° for the upper shaft.</p> <p>0528D 0529D</p>
<p><b>4</b></p>	<p>(Setting item)</p> <p>OFF</p>	<p>The setting will be stored and the display will return to the setting item.</p> <p>0530D</p>
<p><b>5</b></p>		<p>Normal sewing machine operation will then be possible.</p> <p>0520D</p>

\* For details on other adjustment items, refer to the Service Manual.

## 4-6. Resetting all settings to their defaults

If the sewing machine stops operating normally, the cause may be that an incorrect setting may have been made for the memory data by means of memory switches, for instance. In such cases, it may be possible to restore normal operation by following the steps given below to initialize the memory setting data.





1. While pressing the continuous backtack key, turn on the power switch.  
The mode will switch to initialization mode and "1. ALL" will appear in the main display.
2. Press the C  or D  key to select an item to be initialized.

Main display	Initialization item
1.ALL	Clear all
2.MEM	Memory switch initialization
3.SPD	Sewing speed initialization
4.SEW	Program initialization

3. Press the ENTER key for 2 seconds or more.  
Once initialization is complete, the main display will change to display "End".
  4. Press the FUNC key.  
Initialization mode will be exited and normal sewing machine operation will then be possible.
- \* For details on initialization items other than "1. ALL", refer to the Service Manual.

## 5. CLEANING

### ! CAUTION

-  Turn off the power switch before carrying out cleaning.  
The machine may operate if the treadle is depressed by mistake, which could result in injury.
-  Be sure to wear protective goggles and gloves when handling the lubricating oil and grease, so that they do not get into your eyes or onto your skin, otherwise inflammation can result.  
Furthermore, do not drink the oil or eat the grease under any circumstances, as they can cause vomiting and diarrhea.  
Keep the oil out of the reach of children.
-  Secure the table so that it will not move when tilting back the machine head. If the table moves, it may crush your feet or cause other injuries.
-  Use both hands to hold the machine head when tilting it back or returning it to its original position. If only one hand is used, the weight of the machine head may cause your hand to slip, and your hand may get caught.

The following cleaning operations should be carried out each day in order to maintain the performance of this machine and to ensure a long service life. Furthermore, if the sewing machine has not been used for a long period of time, carry out the following cleaning procedures before using it again.

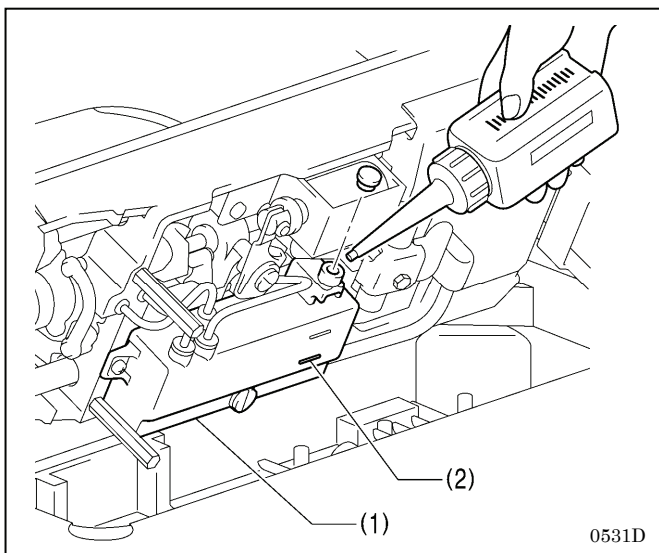

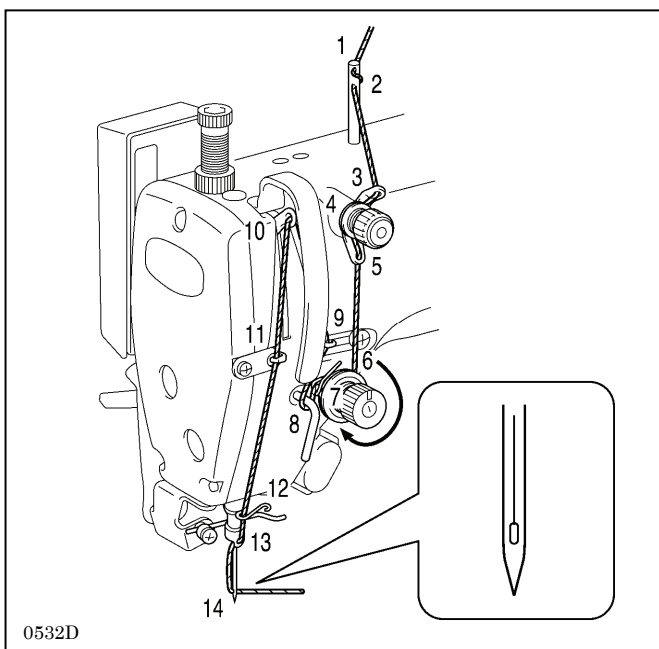

1. If the oil level drops below the lower reference line (2) on the oil tank (1), be sure to replenish the oil. (Refer to "2-3. Lubrication".)



2. Return the machine head to its original position.
3. Replace the needle if it is bent or if the tip is broken.
4. Check that the upper threads have been threaded correctly.
5. Carry out a test sewing.

## 6. REPLACING THE FIXED KNIFE AND MOVABLE KNIFE

### ⚠ CAUTION

-  Replacement of parts should only be carried out by a qualified technician.
-  Turn off the power switch and disconnect the power cord from the wall outlet before replacing any parts, otherwise the machine may operate if the treadle is pressed by mistake, which could result in injury.
-  When replacing parts and installing optional accessories, be sure to use only genuine Brother parts. Brother will not be held responsible for any accidents or problems resulting from the use of non-genuine parts.

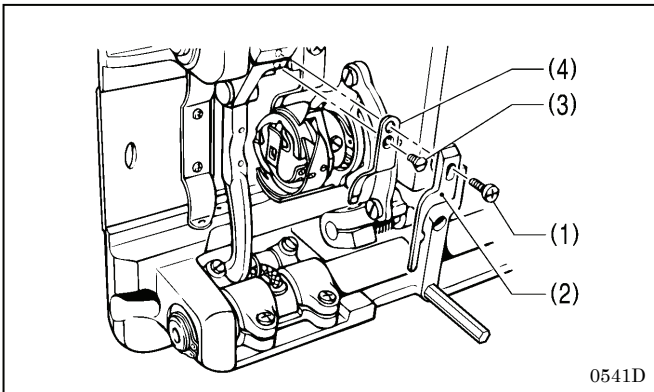

#### <Fixed knife>

1. Tilt back the machine head.
2. Remove the screw (1), and then remove the rotary hook stopper (2).
3. Remove the screw (3), and then remove the fixed knife (4).

#### NOTE:

Carry out the above steps in reverse to install the fixed knife (4).

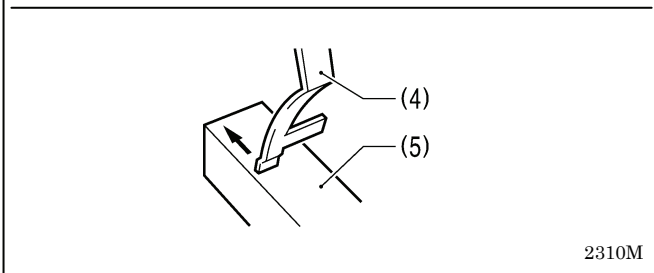

#### Sharpening the fixed knife

If the cutting performance deteriorates, sharpen the fixed knife (4) on a whetstone (5) as shown in the illustration.

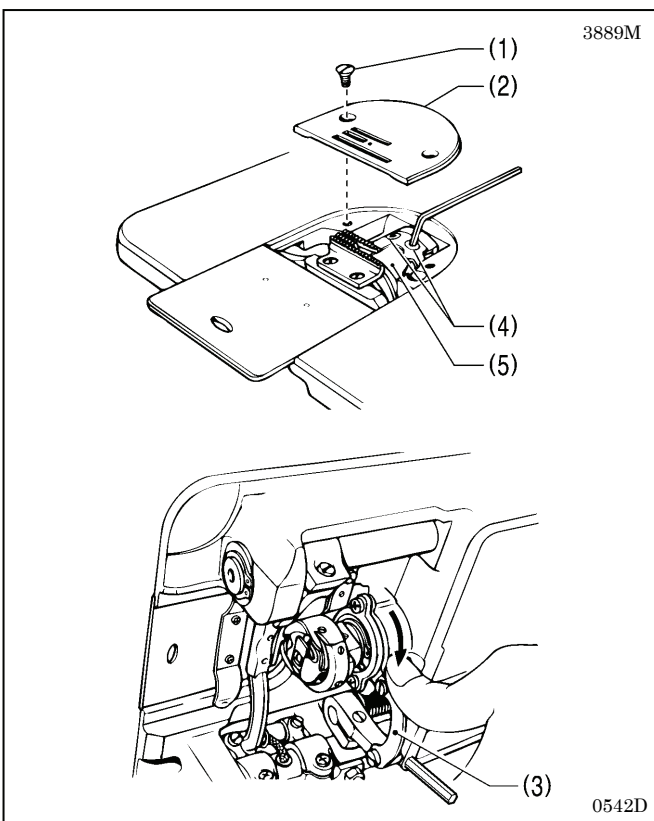

#### <Movable knife>









1. Remove the needle.
2. Lift up the presser foot using the lifting lever.
3. Remove the two screws (1), and then remove the needle plate (2).
4. Turn the machine pulley to raise the needle bar to its highest position.
5. Tilt back the machine head.
6. Push the thread trimmer connecting rod (3) in the direction of the arrow until the two screws (4) can be seen.
7. Remove the two screws (4), and then remove the movable knife (5).

#### NOTE:

Carry out the above steps in reverse to install the movable knife (5).

## 7. STANDARD ADJUSTMENTS

### ⚠ CAUTION

-  Maintenance and inspection of the sewing machine should only be carried out by a qualified technician.
-  Ask your Brother dealer or a qualified electrician to carry out any maintenance and inspection of the electrical system.
-  If any safety devices have been removed, be absolutely sure to re-install them to their original positions and check that they operate correctly before using the machine.
-  Secure the table so that it will not move when tilting back the machine head. If the table moves, it may crush your feet or cause other injuries.
-  Use both hands to hold the machine head when tilting it back or returning it to its original position. If only one hand is used, the weight of the machine head may cause your hand to slip, and your hand may get caught.
-  Turn off the power switch and disconnect the power cord from the wall outlet at the following times, otherwise the machine may operate if the treadle is depressed by mistake, which could result in injury.
  - When carrying out inspection, adjustment and maintenance
  - When replacing consumable parts such as the rotary hook and knife
-  Always be sure to turn off the power switch and then wait one minute before opening the motor cover. If you touch the surface of the motor, it may cause burns.
-  If the power switch needs to be left on when carrying out some adjustment, be extremely careful to observe all safety precautions.

### 7-1. Adjusting arm thread guide R

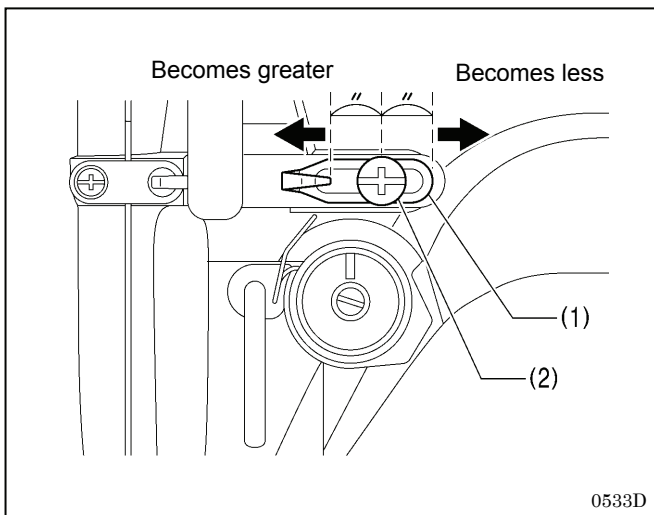

The standard position of arm thread guide R (1) is the position where the screw (2) is in the center of the adjustable range for arm thread guide R (1).

#### NOTE:

To adjust the position, loosen the screw (2) and then move arm thread guide R (1).

- When sewing thick material, move arm thread guide R (1) to the left. (The thread take-up amount will become greater.)
- When sewing thin material, move arm thread guide R (1) to the right. (The thread take-up amount will become less.)

## 7-2. Adjusting the presser foot height

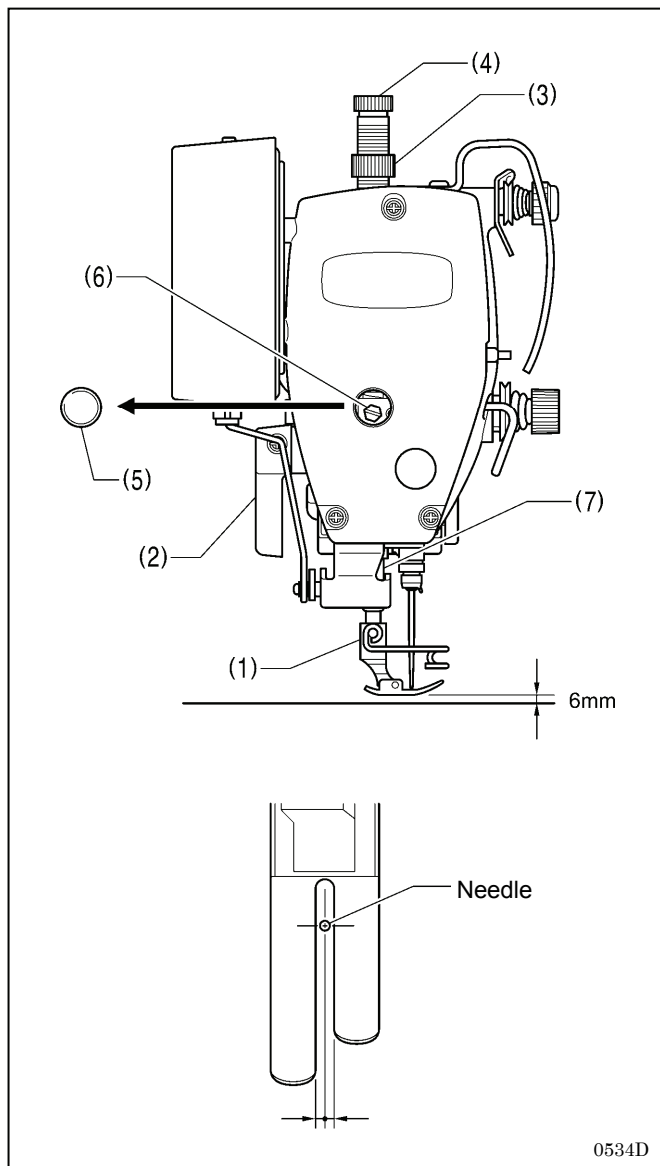

The standard height of the presser foot (1) is 6 mm when the presser foot (1) is raised by means of the lifting lever (2).

1. Loosen the nut (3) of the adjustment screw (4), and then turn the adjustment screw (4) so that there is no pressure applied to the presser foot.
2. Raise the lifting lever (2). The presser foot (1) will also rise.
3. Remove the oil cap (5).
4. Loosen the bolt (6) and then move the presser bar (7) up or down until the presser foot (1) is at the standard height of 6 mm.
5. Tighten the bolt (6).
6. Replace the oil cap (5).
7. Adjust the presser foot pressure using the adjustment screw (4), and then tighten the nut (3).

**NOTE:**

After adjusting, check that the needle moves down into the center of the groove in the presser foot.

0534D

### 7-3. Adjusting of the feed dog height

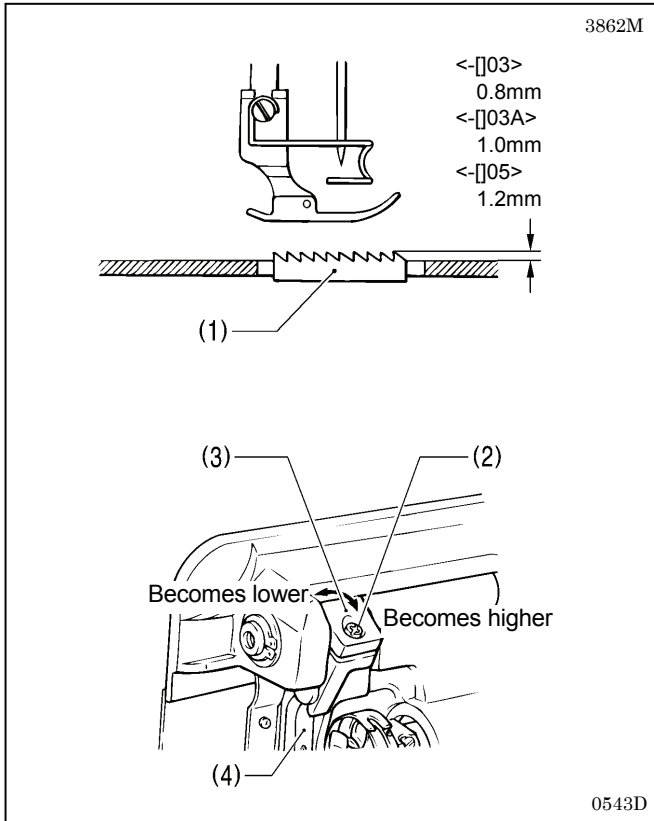

The standard height of the feed dog (1) when it is raised as far as possible above the surface of the needle plate is 0.8 mm for -[]03 specifications, 1.0 mm for -[]03A specifications and 1.2 mm for -[]05 specifications.

1. Turn the pulley until the feed dog (1) rises to the highest position.
2. Tilt back the machine head.
3. Loosen the screw (2).
4. Turn the feed lifting shaft crank (3) to move the feed bracket (4) up and down.
5. Tighten the screw (2).

### 7-4. Adjusting the feed dog angle

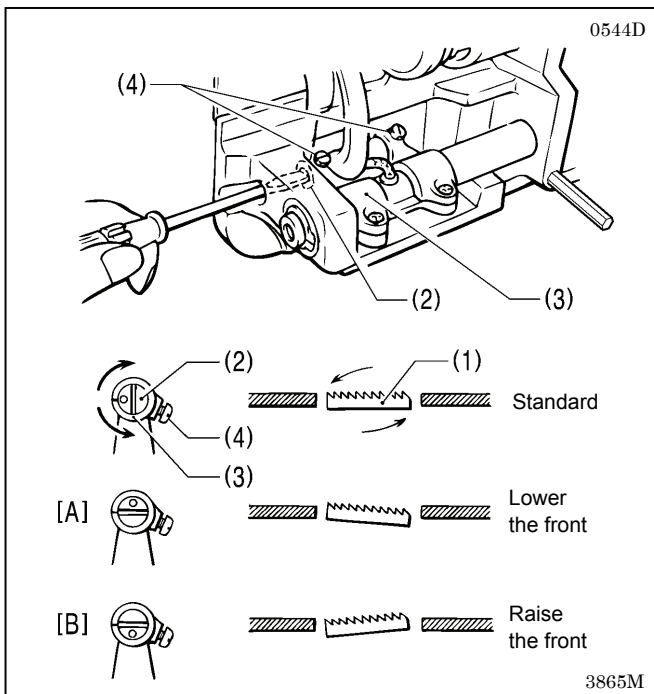

The standard angle for the feed dog (1) when it is at its highest position above the needle plate is when the "O" mark on the shaft (2) is aligned with the feed rocker bracket arm (3) and the feed dog (1) is parallel to the needle plate.

1. Turn the machine pulley to move the feed dog (1) to its highest position above the needle plate.
2. Tilt back the machine head.
3. Loosen the two set screws (4).
4. Turn the shaft (2) in the direction of the arrow within a range of 90° with respect to the standard position.

- In order to prevent puckering, lower the front of the feed dog (1). (Fig. [A])

- In order to prevent the material from slipping, raise the front of the feed dog (1). (Fig. [B])

5. Securely tighten the set screws (4).

**NOTE:**

The height of the feed dog (1) will change after the angle has been adjusted, so it will be necessary to re-adjust the height of the feed dog (1).

### 7-5. Adjusting the needle bar height

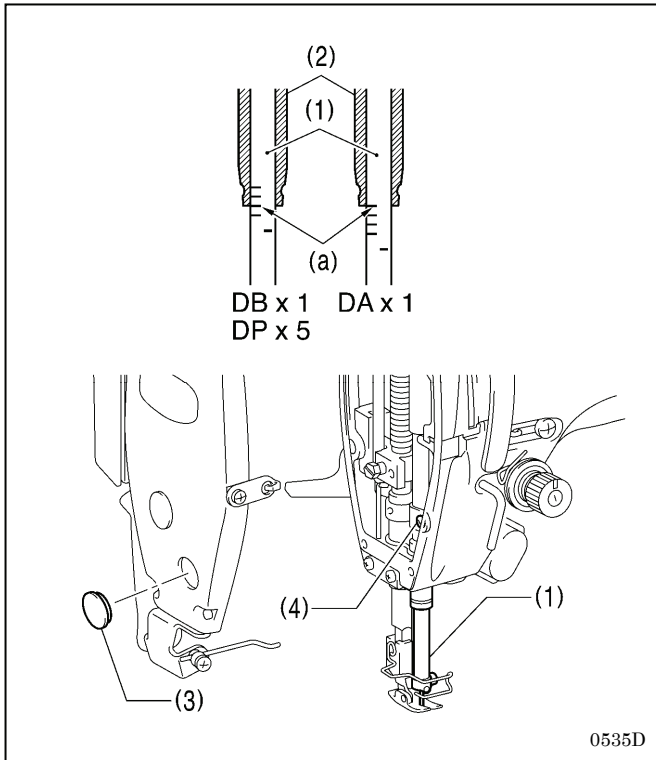

Reference line (a), which is the second line from the bottom of the needle bar (1) (fourth line from the bottom when using a DA x 1 needle) should be aligned with the lower edge of the needle bar bush D (2) as shown in the illustration when the needle bar (1) is at its lowest position.

1. Turn the machine pulley to set the needle bar (1) to its lowest position.
2. Remove the oil cap (3).
3. Loosen the screw (4) and then move the needle bar (1) up or down to adjust its position.
4. Securely tighten the screw (4).
5. Replace the oil cap (3).

### 7-6. Adjusting the needle and feed mechanism timing

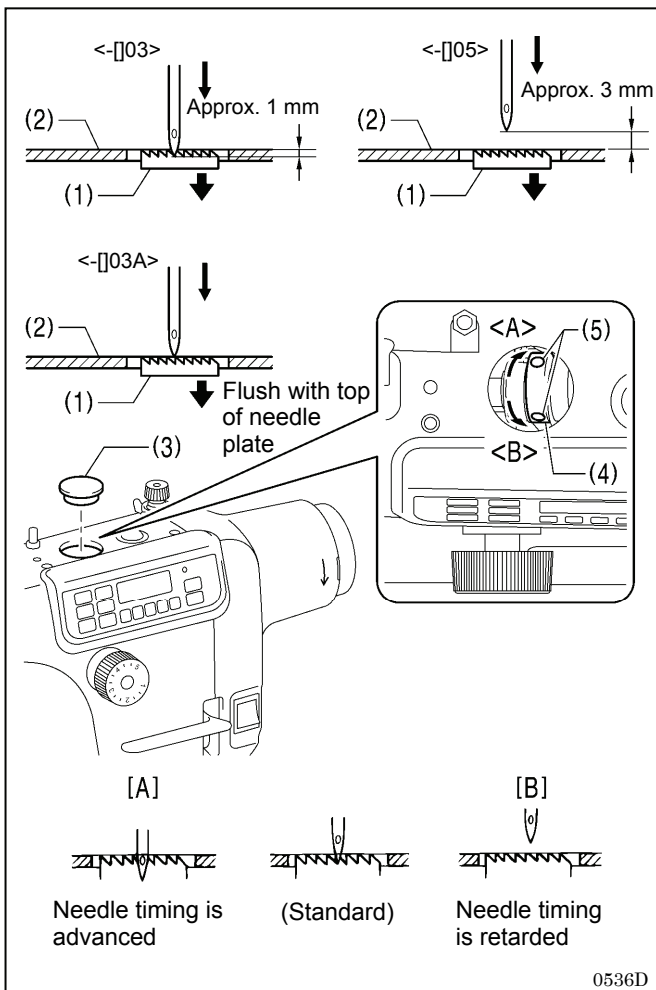

The illustration at left shows the standard position for the needle tip when the feed dog (1) is lowered from its highest position until it is flush with the top of the needle plate (2).

1. Remove the rubber cap (3).
2. Loosen the two set screws (5) of the vertical cam (4), and then turn the vertical cam (4) slightly to adjust the timing.
  - To advance the needle timing, turn in the direction of <A>. To retard the needle timing, turn in the direction of <B>.
  - To prevent material slippage from occurring, retard the needle timing. (Fig. [B])
  - To improve thread tightening, advance the needle timing. (Fig. [A])

**NOTE:**

If the vertical cam (4) is turned too far in the direction of <A>, it may cause the needle to break.

3. After adjusting, securely tighten the set screw (5).
4. Replace the rubber cap (3).



## 7-7. Adjusting the needle and rotary hook timing

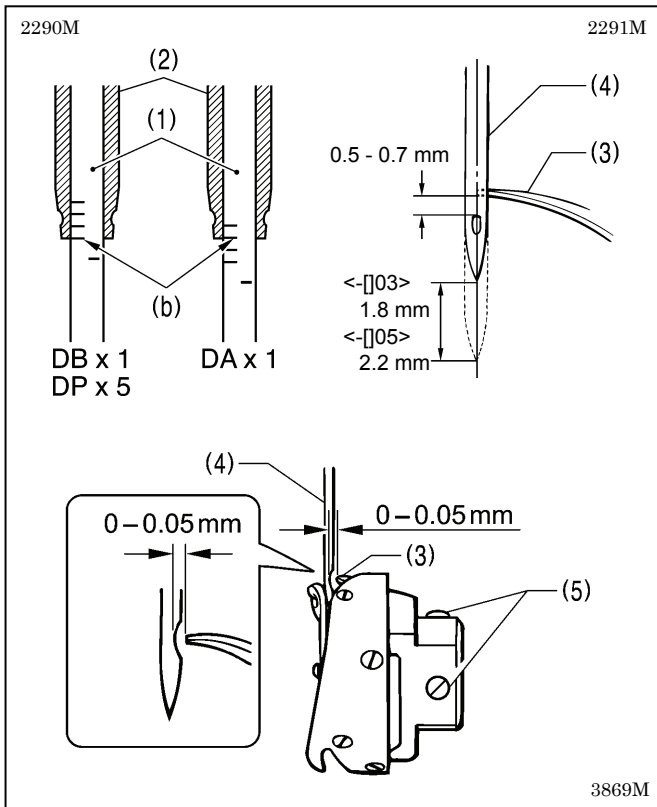

The tip of the rotary hook (3) should be aligned with the center of the needle (4) when the needle bar (1) moves up 1.8 mm (2.2 mm for -[]03A and -[]05 specifications) from its lowest position to the position where reference line (b) is aligned with the lower edge of the needle bar bush (2) as shown in the illustration. (The distance from the upper edge of the needle hole to the rotary hook tip will be 0.5 to 0.7 mm at this time.)

1. Turn the machine pulley to raise the needle bar (1) from its lowest position until reference line (b) is aligned with the lower edge of the needle bar bush D (2) as shown in the illustration.
2. Loosen the set screws (5), and then align the tip of the rotary hook (3) with the center of the needle (4). The distance between the tip of the rotary hook (3) and the needle (4) should be approximately 0 - 0.05 mm.
3. Securely tighten the set screws (5).

## 7-8. Adjusting the rotary hook lubrication amount

### CAUTION



Be careful not to touch your fingers or the lubrication amount check sheet against moving parts such as the rotary hook or the feed mechanism when checking the amount of oil supplied to the rotary hook, otherwise injury may result.

Use the following procedure to check the amount of oil being supplied to the rotary hook when replacing the rotary hook or when changing the sewing speed.

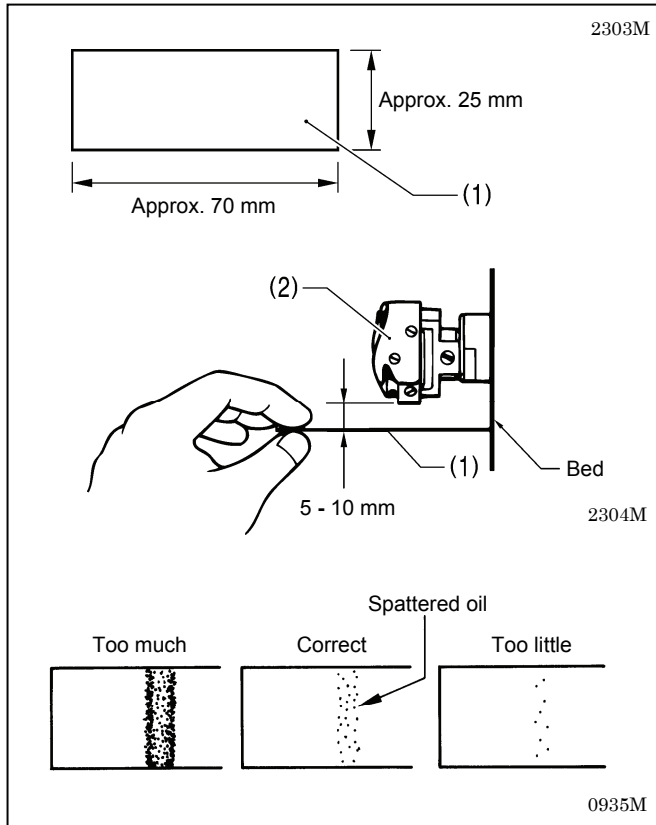

#### <Checking the lubrication amount>

1. Remove the thread from all points from the thread take-up to the needle.
2. Use the lifting lever to lift the presser foot.
3. Run the machine at the normal sewing speed for approximately 1 minute without sewing any material (following the same start/stop pattern as when actually sewing).
4. Place the lubrication amount check sheet (1) underneath the rotary hook (2) and hold it there. Then run the sewing machine at the normal sewing speed for 8 seconds. (Any type of paper can be used as the lubrication amount check sheet (1).)
5. Check the amount of oil which has spattered onto the sheet.

If adjustment is necessary, carry out the following operations in "Adjusting the lubrication amount".

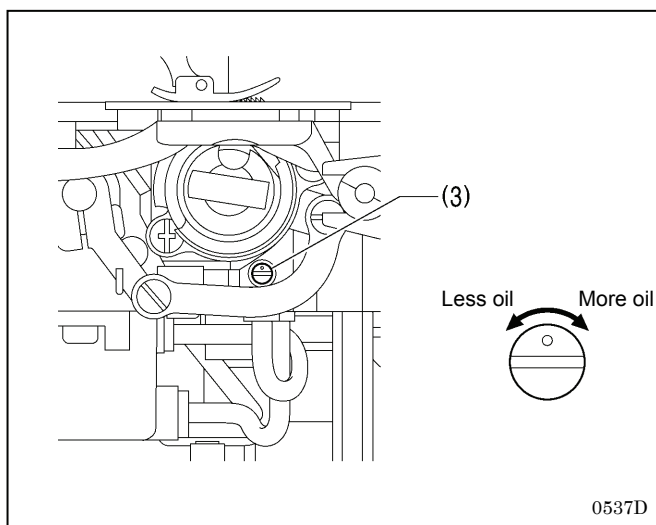

#### <Adjusting the lubrication amount>

1. Tilt back the machine head.
2. Turn the adjusting screw (3) to adjust the lubrication amount.
  - If the rotary hook adjusting screw (3) is turned clockwise, the lubrication amount becomes greater.
  - If the rotary hook adjusting screw (3) is turned counterclockwise, the lubrication amount becomes smaller.
3. Check the lubrication amount again according to the procedure given in "Checking the lubrication amount" above.

#### NOTE:

Turn the adjusting screw (3) and check the lubrication amount repeatedly until the lubrication amount is correct.

4. Check the lubrication amount again after the sewing machine has been used for approximately two hours.

## 8. TROUBLESHOOTING

- Please check the following points before calling for repairs or service.
- If the following remedies do not fix the problem, turn off the power switch and consult a qualified technician or the place of purchase.



### CAUTION





Turn off the power switch and disconnect the power cord before carrying out troubleshooting. The machine may operate if the treadle is depressed by mistake, which could result in injury.

### 8-1. Sewing

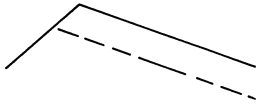
Items with a "\*" in the "Page" column should only be checked by a qualified technician.

	Problem	Possible cause	Page
1	Upper thread is not tight.  0573M	<ul style="list-style-type: none"> <li>• Is the upper thread tension too weak, or is the lower thread tension too strong? Adjust the upper thread tension or lower thread tension.</li> <li>• Is the needle and feed timing correct? Advance the needle timing.</li> </ul>	31*
2	Lower thread is not tight.  0574M	<ul style="list-style-type: none"> <li>• Is the lower thread tension too weak, or is the upper thread tension too strong? Adjust the lower thread tension or upper thread tension.</li> </ul>	
3	Loops appear in seam.  0977M	<ul style="list-style-type: none"> <li>• Is the thread path not smooth enough? Use a file with a fine grain or sandpaper to polish smooth the thread path.</li> <li>• Is the bobbin not turning smoothly? Pull out the lower thread to check that there is no slackness in the thread tension, or replace the bobbin or bobbin case.</li> </ul>	
4	Skipped stitches occur while sewing  0470M	<ul style="list-style-type: none"> <li>• Is the needle tip bent? Is the needle tip blunt? If the needle tip is bent or broken, replace the needle.</li> <li>• Is the needle properly installed? If it is incorrect, install the needle correctly.</li> <li>• Is the machine properly threaded? If it is incorrect, thread the thread correctly.</li> <li>• Is the presser foot pressure too weak? Adjust the presser foot pressure.</li> <li>• Is the needle too thin? Replace the needle with a needle that is one rank thicker.</li> <li>• Is the presser foot too high? Adjust the height of the presser foot.</li> <li>• Is the thread take-up spring too weak? Adjust the tension of the thread take-up spring.</li> <li>• Is the needle and rotary hook timing correct? Adjust the height of the needle bar. Adjust the clearance between the needle and the tip of the rotary hook.</li> </ul>	26          29*  *  31* 32*

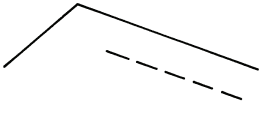
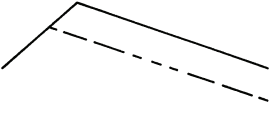
## 8. TROUBLESHOOTING

	Problem	Possible cause	Page
5	<p>Skipped stitches at sewing start Thread unravelling at sewing start</p>  <p style="text-align: right;">0749M</p>	<ul style="list-style-type: none"> <li>• Is the thread take-up spring tension too strong? Reduce the tension of the thread take-up spring.</li> <li>• Is the thread take-up spring operating range too large? Lower the position of the thread take-up spring.</li> <li>• Are the trailing lengths of the upper threads too short after thread trimming? Adjust the pretension.</li> <li>• Are the threads not being trimmed cleanly? Sharpen the fixed knives, or replace the fixed and movable knives if necessary.</li> <li>• Is the needle too thick? Try using a needle with a count that is one lower than the current needle.</li> <li>• Is the length of thread trailing out from the bobbin case after thread trimming too short? If the bobbin is spinning loosely, replace the anti-spin spring in the bobbin case.</li> <li>• Is the sewing speed too fast at the sewing start? Set the operation panel so that slow start is enabled.</li> <li>• Is the needle up stop position too high? Adjust the needle up stop position.</li> </ul>	<p style="text-align: center;">*</p> <p style="text-align: center;">*</p> <p style="text-align: center;">27*</p> <p style="text-align: center;">21*</p> <p style="text-align: center;">24*</p>
6	<p>Uneven seam</p>  <p style="text-align: right;">0473M</p>	<ul style="list-style-type: none"> <li>• Is the presser foot pressure too weak? Adjust the presser foot pressure.</li> <li>• Is the feed dog too low? Adjust the feed dog height.</li> <li>• Is the bobbin scratched? If the bobbin is damaged, smooth it with an oiled grindstone or replace it.</li> </ul>	<p style="text-align: center;">30*</p> <p style="text-align: center;">*</p>
7	<p>Large degree of puckering (excess tension)</p>  <p style="text-align: right;">0978M</p>	<ul style="list-style-type: none"> <li>• Is the upper thread tension too strong? Make the upper thread tension as weak as possible.</li> <li>• Is the lower thread tension too strong? Make the lower thread tension as weak as possible.</li> <li>• Is the needle tip blunt? Replace the needle if it is blunt.</li> <li>• Is the needle too thick? Replace with as thin a needle as possible.</li> <li>• Are the thread take-up spring tensions too strong? Make the thread take-up spring tension as weak as possible.</li> <li>• Is the thread take-up spring operating range too large? Lower the position of the thread take-up spring to as low a position as possible.</li> <li>• Is the presser foot pressure too strong? Adjust the presser foot pressure.</li> <li>• Is the sewing speed too fast? Gradually reduce the maximum sewing speed using the operation panel.</li> <li>• Is the angle of the feed dog correct? Tilt the front of the feed dog down slightly.</li> </ul>	<p style="text-align: center;">*</p> <p style="text-align: center;">*</p> <p style="text-align: center;">16*</p> <p style="text-align: center;">30*</p>

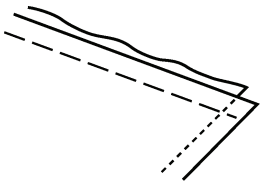
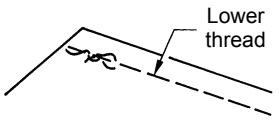
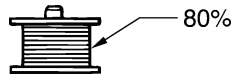
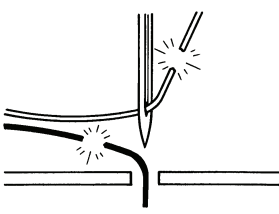
	Problem	Possible cause	Page
8	<p>Material slippage</p>  <p>0750M</p>	<ul style="list-style-type: none"> <li>Is the presser foot pressure too strong? Adjust the presser foot pressure.</li> </ul>	
9	<p>Lower thread is tangled at the sewing start. Spinning of bobbin during thread trimming</p>  <p>0751M</p>	<ul style="list-style-type: none"> <li>Is the bobbin spinning direction correct when the lower thread is being pulled? Set the bobbin so that it turns in the opposite direction to the rotary hook.</li> <li>Is there too much thread wound onto the bobbin? The bobbin winding amount should not be more than 80%.</li> <li>Is the anti-spin spring attached? Attach the anti-spin spring.</li> <li>Is the bobbin turning smoothly? If the bobbin is not turning smoothly, replace the bobbin.</li> <li>Is a bobbin other than the light-alloy bobbins specified by Brother being used? Use only bobbins which are specified by Brother.</li> </ul>  <p>2124M</p>	
10	<p>Upper and lower threads are breaking.</p>  <p>0471M</p>	<ul style="list-style-type: none"> <li>Is the needle bent or is the needle tip broken? Replace the needle if it is bent or broken.</li> <li>Is the needle properly installed? If it is incorrect, install the needle correctly.</li> <li>Is the machine properly threaded? If it is incorrect, thread the thread correctly.</li> <li>Is the upper or lower thread tension too weak or too strong? Adjust the upper thread or lower thread tension.</li> <li>Is the upper thread may be loose because the thread take-up spring operating range is too small? Adjust the position of the thread take-up spring.</li> <li>Is the rotary hook, feed dog or other part damaged? If they are damaged, smooth them with an oiled grindstone or replace the damaged parts.</li> <li>Is the thread path damaged? If the thread path is damaged, smooth it with sandpaper or replace the damaged part.</li> </ul>	<p>26</p> <p>26*</p> <p>*</p> <p>*</p>
11	<p>Incorrect thread trimming (Upper and lower threads are both not being trimmed)</p>	<ul style="list-style-type: none"> <li>Is the fixed knife or movable knife damaged or worn? Replace the fixed knife or the movable knife.</li> </ul>	<p>27*</p>
12	<p>Incorrect thread trimming (Upper thread or lower thread is not being trimmed)</p>	<ul style="list-style-type: none"> <li>Is the needle properly installed? If it is incorrect, install the needle correctly.</li> <li>Is the fixed knife or movable knife blunt? Replace the fixed knife or the movable knife.</li> </ul>	<p>27*</p>

## 8. TROUBLESHOOTING

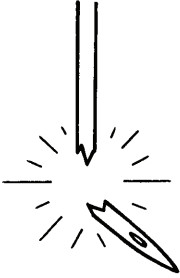
Problem		Possible cause	Page
13	Broken needles   0469M	<ul style="list-style-type: none"> <li>• Is the material being pushed or pulled with excessive force during sewing?</li> <li>• Is the needle properly installed? If it is incorrect, install the needle correctly.</li> <li>• Is the needle bent, is the needle tip broken, or is the needle hole blocked? Replace the needle.</li> <li>• Is the needle and rotary hook timing correct? Adjust the height of the needle bar. Adjust the clearance between the needle and the tip of the rotary hook.</li> <li>• Is the needle timing too advanced with respect to the feed dog? Retard the needle timing.</li> </ul> <div style="border: 1px solid black; padding: 5px; margin-top: 10px;"> <p>Caution</p> <ul style="list-style-type: none"> <li>• It is extremely dangerous to leave any pieces of broken needle sticking in the material. If the needle breaks, search for all pieces until the whole of the needle is found again.</li> <li>• Furthermore, we recommend that through steps be taken to account for such needles to comply with product liability regulations.</li> </ul> </div>	   31* 32*  31*
14	Machine does not operate when power is turned on and treadle is pressed.	<ul style="list-style-type: none"> <li>• Is the power supply connector disconnected from the control box? Insert the connector securely.</li> </ul>	7~11
15	Machine does not operate at high speed.	<ul style="list-style-type: none"> <li>• Is the sewing speed setting or backtack stitch speed setting too slow? Set the maximum sewing speed to a higher speed.</li> </ul>	16*
16	Nothing appears on the operation panel display.	<ul style="list-style-type: none"> <li>• Is the power supply connector disconnected from the control box? Insert the connector securely.</li> <li>• Is the operation panel connector at the control box disconnected? Insert the connector securely.</li> </ul>	7~11  7*

## 8-2. Error code displays

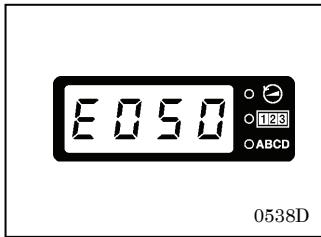

### If an error code appears on the operation panel display

1. Make a note of the error code and then turn off the power.
2. After the operation panel display has turned off, eliminate the cause of the error and then turn the power back on.

- Items with a “ \* ” in the “Page” column should only be checked by a qualified technician.
- For items with “ \*\* ” appearing in the “Page” column, ask the place of purchase for advice.

### <Connector layout diagram>

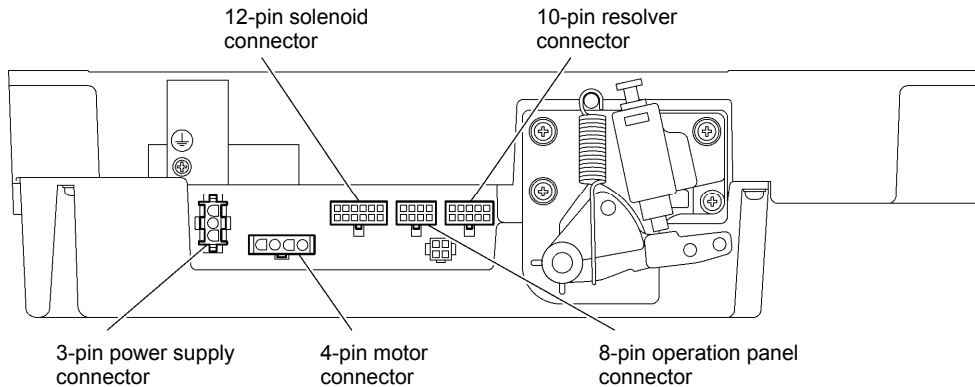

Error code	Possible cause	Page
E050	<ul style="list-style-type: none"> <li>• The machine head was detected as being tilted back when the treadle was depressed. Turn off the power switch and then return the machine head to the upright position. (If tilting back the machine head to carry out any tasks, turn off the power switch first.) Is the 8-pin operation panel connector disconnected?</li> </ul>	*
E051	<ul style="list-style-type: none"> <li>• The machine head was detected as being tilted back during sewing. Turn the power off and then back on again. Is the 8-pin operation panel connector disconnected?</li> </ul>	*
E055	<ul style="list-style-type: none"> <li>• Was the power switch turned on while the machine head was still tilted back? Turn off the power switch and then return the machine head to the upright position.</li> <li>• Is the 8-pin operation panel connector at the control box disconnected? Turn off the power switch, and then check the connection of the 8-pin operation panel connector.</li> </ul>	7*
E065	<ul style="list-style-type: none"> <li>• Was the power switch turned on while an invalid key was being pressed on the operation panel? Turn off the power switch and check that no operation panel keys are being pressed.</li> <li>• There is a malfunction of the operation panel. Replace the operation panel.</li> </ul>	**
E066	<ul style="list-style-type: none"> <li>• Was the actuator switch being pressed when the power switch was turned on? Turn off the power switch and check that the actuator switch is not being pressed.</li> <li>• There is a problem with the actuator switch. Check the connection of the 12-pin solenoid connector. Replace the actuator switch.</li> </ul>	7*

## 8. TROUBLESHOOTING

Error code	Possible cause	Page
<b>E090</b> Treadle connector is not connected.	<ul style="list-style-type: none"> <li>• Is the 3-pin treadle connector inside the control box disconnected? Turn off the power switch, and then check that the 3-pin treadle connector is connected to connector P3 on the main PCB.</li> <li>• Problem with treadle unit. If there is a broken wire in the cord of the treadle connector, replace the treadle unit.</li> </ul>	*  **
<b>E091</b>	<ul style="list-style-type: none"> <li>• The settings in “Setting method for standard depression stroke” may be incorrect. Redo the settings in “Setting method for standard depression stroke”.</li> <li>• Problem with treadle unit. Replace the treadle unit.</li> </ul>	*  **
<b>E095</b>	<ul style="list-style-type: none"> <li>• Was the power switch turned on while the treadle was still depressed? Return the treadle to the neutral position. When the treadle neutral position is detected, the error will be cleared and normal operation will then be possible.</li> <li>• Is the power supply voltage too low? Check the power supply voltage.</li> </ul>	*
<b>E111</b>	<ul style="list-style-type: none"> <li>• The sewing machine could not stop correctly at the needle up stop position after thread trimming. Remove any thread scraps that may be blocking the motor. Turn off the power switch and then turn the machine pulley by hand and check that it turns easily. Check that there are no problems with the thread trimming mechanism.</li> </ul>	*  *  **
<b>E112</b>	<ul style="list-style-type: none"> <li>• The needle bar stops before the needle stop position (needle up or needle down). Turn the pulley by hand and check that it does not turn stiffly. Remove any thread scraps that may be stuck in the area around the rotary hook.</li> <li>• Abnormal needle up signal Turn off the power switch, and then check the connection of the 10-pin resolver connector.</li> </ul>	
<b>E113</b>	<ul style="list-style-type: none"> <li>• Stopping could not be confirmed. This error is displayed when the machine could not be immediately stopped because of an abnormal load causing the machine speed to increase during a stopping operation. Turn the pulley by hand and check that it does not turn stiffly. Remove any thread scraps that may be stuck in the area around the rotary hook.</li> </ul>	
<b>E130</b>	The sewing machine or motor do not operate when the treadle is depressed. <ul style="list-style-type: none"> <li>• Is the 4-pin motor connector of the control box disconnected? Turn off the power switch and check the connection of the 4-pin motor connector.</li> <li>• Has the sewing machine locked up? Turn off the power switch and then turn the machine pulley by hand and check that it turns easily.</li> <li>• Problem with control box. Replace the control box.</li> </ul>	10*  *  **
<b>E131</b> Problem with motor encoder signal.	<ul style="list-style-type: none"> <li>• Is the 10-pin resolver connector at the control box disconnected? Turn off the power switch, and then check the connection of the 10-pin resolver connector.</li> <li>• Problem with motor or main PCB. Replace the motor or the control box.</li> </ul>	10*  **
<b>E132</b> Problem with motor operation.	<ul style="list-style-type: none"> <li>• Problem with motor. Replace the motor.</li> <li>• Problem with main P.C. board Replace the control box.</li> </ul>	**  **
<b>E140</b> Motor reverse operation.	<ul style="list-style-type: none"> <li>• Motor reverse operation was detected. Replace the motor.</li> </ul>	**







































Error code	Possible cause	Page
<b>E150</b> Motor is overheating.	<ul style="list-style-type: none"> <li>• This is displayed when the motor becomes abnormally hot and the temperature protection has activated.                After the temperature has dropped, turn on the power switch and operate the sewing machine as normal.</li> </ul>	
<b>E151</b> Problem with motor overheating sensor.	<ul style="list-style-type: none"> <li>• The connection of the 10-pin resolver connector at the control box is faulty.                Turn off the power switch, and then check the connection of the 10-pin resolver connector.</li> <li>• Problem with motor or main PCB.                Replace the motor or the control box.</li> </ul>	**
<b>E161</b> Motor overload protection	<ul style="list-style-type: none"> <li>• This is displayed when a motor overload operation has occurred.                Turn off the power switch, and then turn the pulley by hand and check that it turns easily.</li> <li>• Problem with motor.                Replace the motor.</li> </ul>	
<b>E190</b> Motor timeout.	<ul style="list-style-type: none"> <li>• This appears on the display when the sewing machine has been operating continuously for 3 minutes or more.                Turn the power switch off and then back on again, and then operate the sewing machine normally.</li> </ul>	
<b>E191</b> Thread trimming solenoid timeout.	<ul style="list-style-type: none"> <li>• This is displayed if the sewing machine motor locks during thread trimming.                Remove any thread scraps that may be blocking the motor.                Check that there are no problems with the thread trimming mechanism.</li> </ul>	* **
<b>E410</b> Error communicating with operation panel.	<ul style="list-style-type: none"> <li>• Is the 8-pin operation panel connector at the control box disconnected?                Turn off the power switch, and then check the connection of the 8-pin operation panel connector.</li> </ul>	7*
<b>E440</b> Error writing data to main PCB.	<ul style="list-style-type: none"> <li>• Problem with main PCB.                Replace the control box.</li> </ul>	**
<b>E441</b> Error reading data from main PCB.	<ul style="list-style-type: none"> <li>• Problem with main PCB.                Replace the control box.</li> </ul>	**
<b>E442</b> Problem with data on main PCB.	<ul style="list-style-type: none"> <li>• The data on the main PCB is corrupted. Corrupt data was initialized.                Turn the power off and then back on again.</li> </ul>	
<b>E451</b> Error writing data to head detector unit.	<ul style="list-style-type: none"> <li>• Data could not be correctly written to the panel when adjusting the needle up stop position.                Repeat the write operation.</li> <li>• Alternatively, turn the power off and then back on again to reset the machine.</li> </ul>	

## 8. TROUBLESHOOTING

Error code	Possible cause	Page
<b>E701</b> Abnormally high power supply voltage.	<ul style="list-style-type: none"> <li>• Does the power supply voltage match the control box voltage specifications?                Check that the voltage matches.                Check the connection of the 5-pin transformer connector inside the control box.                (220 V AC: P12, 230 V AC: P13)</li> <li>• Is the power supply voltage abnormally high?                Check the power supply voltage.</li> <li>• Problem with control box.                Replace the control box.</li> </ul>	*  *  **
<b>E705</b> Abnormally low power supply voltage.	<ul style="list-style-type: none"> <li>• Is the power supply voltage abnormally low?                Check the power supply voltage.                Check the connection of the 5-pin transformer connector inside the control box.                (220 V AC: P12, 230 V AC: P13)</li> <li>• Problem with control box.                Replace the control box.</li> </ul>	*  **
<b>E710</b> Motor overcurrent.	<ul style="list-style-type: none"> <li>• Is the electrical equipment connector inside the control box disconnected?                Turn off the power switch and then turn the machine pulley by hand and check that it turns easily.</li> <li>• This is displayed if the machine pulley moves stiffly when it is turned by hand, or if the sewing machine locks up and an abnormal current is flowing.                Turn off the power switch and then turn the machine pulley by hand and check that it turns easily.</li> <li>• This is displayed if there is some problem with the motor and an abnormal current is flowing.                Replace the motor.</li> <li>• Problem with control box.                Replace the control box.</li> </ul> <div style="border: 1px solid black; padding: 5px; margin-top: 10px;"> <p><b>NOTE:</b> When the power supply voltage is abnormally low, E710 may be displayed instead of E705.</p> </div>	*  *  **  **
<b>E790</b> Problem with solenoid power supply	<ul style="list-style-type: none"> <li>• This is displayed when there is no power for solenoid, or if the power level is abnormally low.                Check the connection of the 2-pin transformer connector inside the control box.</li> <li>• Problem with main P.C. board or transformer.                Replace the control box.</li> </ul>	*  **
<b>E791</b> Solenoid overcurrent.	<ul style="list-style-type: none"> <li>• This is displayed when there is overcurrent in any of the solenoids (thread trimming, thread wiping, quick reverse or presser lifter).                Check the resistances of the solenoids.</li> <li>• Problem with main PCB.                Replace the control box.</li> </ul>	*  **

**If an error code that is not listed above appears or if carrying out the specified remedy does not solve the problem, contact the place of purchase.**

## 9. 7-SEGMENT DISPLAY

0	1	2	3	4	5	6	7	8	9
									
A	B	C	D	E	F	G	H	I	J
									
K	L	M	N	O	P	Q	R	S	T
									
U	V	W	X	Y	Z				
									

4268M

**brother**®

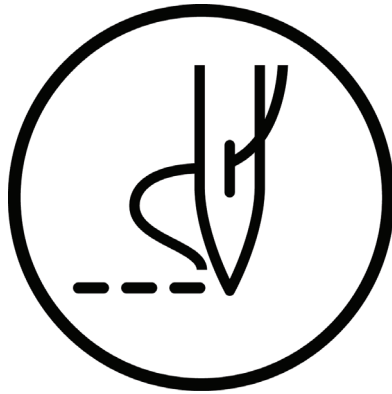

## INSTRUCTION MANUAL

\* Please note that the contents of this manual may differ slightly from the actual product purchased as a result of product improvements.

**BROTHER INDUSTRIES, LTD.** <http://www.brother.com/>

1-5, Kitajizoyama, Noda-cho, Kariya 448-0803, Japan.

---

© 2013 Brother Industries, Ltd. All Rights Reserved.  
This is the original instructions.

S-7000DD  
SB4299-001 E  
2013.05. D (1-1)

## Free Manuals Download Website

<http://myh66.com>

<http://usermanuals.us>

<http://www.somanuals.com>

<http://www.4manuals.cc>

<http://www.manual-lib.com>

<http://www.404manual.com>

<http://www.luxmanual.com>

<http://aubethermostatmanual.com>

Golf course search by state

<http://golfingnear.com>

Email search by domain

<http://emailbydomain.com>

Auto manuals search

<http://auto.somanuals.com>

TV manuals search

<http://tv.somanuals.com>