

S-7250A

INSTRUCTION MANUAL

Please read this manual before using the machine.
Please keep this manual within easy reach for quick reference.

SINGLE NEEDLE DIRECT DRIVE LOCK STITCHER WITH
ELECTRONIC FEEDING SYSTEM AND THREAD TRIMMER



brother

Thank you very much for buying a BROTHER sewing machine. Before using your new machine, please read the safety instructions and the explanations given in the instruction manual.

With industrial sewing machines, it is normal to carry out work while positioned directly in front of moving parts such as the needle and thread take-up, and consequently there is always a danger of injury that can be caused by these parts. Follow the instructions from training personnel and instructors regarding safe and correct operation before operating the machine so that you will know how to use it correctly.



SAFETY INSTRUCTIONS

[1] Safety indications and their meanings

This instruction manual and the indications and symbols that are used on the machine itself are provided in order to ensure safe operation of this machine and to prevent accidents and injury to yourself or other people.

The meanings of these indications and symbols are given below.

Indications

 DANGER	The instructions which follow this term indicate situations where failure to follow the instructions will result in death or serious injury.
 WARNING	The instructions which follow this term indicate situations where failure to follow the instructions could result in death or serious injury.
 CAUTION	The instructions which follow this term indicate situations where failure to follow the instructions may result in minor or moderate injury.

Symbols



. This symbol () indicates something that you should be careful of. The picture inside the triangle indicates the nature of the caution that must be taken.
(For example, the symbol at left means “beware of injury”.)



. This symbol () indicates something that you must not do.



. This symbol () indicates something that you must do. The picture inside the circle indicates the nature of the thing that must be done.
(For example, the symbol at left means “you must make the ground connection”.)

[2] Notes on safety

DANGER



Wait at least 5 minutes after turning off the power switch and disconnecting the power cord from the wall outlet before opening the cover of the control box. Touching areas where high voltages are present can result in severe injury.

WARNING



Do not allow any liquids to get onto this sewing machine, otherwise fire, electric shocks or operating problems may occur.



If any liquid gets inside the sewing machine (machine head or control box), immediately turn off the power and disconnect the power plug from the electrical outlet, and then contact the place of purchase or a qualified technician.

CAUTION

Environmental requirements



Use the sewing machine in an area which is free from sources of strong electrical noise such as electrical line noise or static electric noise. Sources of strong electrical noise may cause problems with correct operation.



Any fluctuations in the power supply voltage should be within $\pm 10\%$ of the rated voltage for the machine. Voltage fluctuations which are greater than this may cause problems with correct operation.



The power supply capacity should be greater than the requirements for the sewing machine's power consumption. Insufficient power supply capacity may cause problems with correct operation.



The ambient temperature should be within the range of 5°C to 35°C during use. Temperatures which are lower or higher than this may cause problems with correct operation.



The relative humidity should be within the range of 45% to 85% during use, and no dew formation should occur in any devices. Excessively dry or humid environments and dew formation may cause problems with correct operation.



In the event of an electrical storm, turn off the power and disconnect the power cord from the wall outlet. Lightning may cause problems with correct operation.



Do not connect anything to the USB port other than the USB memory. If this is not observed, problems with operation may result.

Installation



Machine installation should only be carried out by a qualified technician.



Contact your Brother dealer or a qualified electrician for any electrical work that may need to be done.



The sewing machine weighs approximately 35 kg (77lb). The installation should be carried out by two or more people.



Do not connect the power cord until installation is complete. The machine may operate if the treadle is depressed by mistake, which could result in injury.



Turn off the power switch before inserting or removing the plug, otherwise damage to the control box could result.



Be sure to connect the ground. If the ground connection is not secure, you run a high risk of receiving a serious electric shock, and problems with correct operation may also occur.



When securing the cords, do not bend the cords excessively or fasten them too hard with staples, otherwise there is the danger that fire or electric shocks could occur.



If using a work table which has casters, the casters should be secured in such a way so that they cannot move.



Secure the table so that it will not move when tilting back the machine head. If the table moves, it may crush your feet or cause other injuries.



Use both hands to hold the machine head when tilting it back or returning it to its original position. If only one hand is used, the weight of the machine head may cause your hand to slip, and your hand may get caught.













Be sure to wear protective goggles and gloves when handling the lubricating oil and grease, so that they do not get into your eyes or onto your skin, otherwise inflammation can result.

Furthermore, do not drink the oil or eat the grease under any circumstances, as they can cause vomiting and diarrhea.





Keep the oil out of the reach of children.

CAUTION











Sewing

- | | |
|--|---|
|  <p>This sewing machine should only be used by operators who have received the necessary training in safe use beforehand.</p> |  <p>Attach all safety devices before using the sewing machine. If the machine is used without these devices attached, injury may result.</p> |
|  <p>The sewing machine should not be used for any applications other than sewing.</p> |  <p>Do not touch any of the moving parts or press any objects against the machine while sewing, as this may result in personal injury or damage to the machine.</p> |
|  <p>Be sure to wear protective goggles when using the machine.
If goggles are not worn, there is the danger that if a needle breaks, parts of the broken needle may enter your eyes and injury may result.</p> |  <p>Secure the table so that it will not move when tilting back the machine head. If the table moves, it may crush your feet or cause other injuries.</p> |
|  <p>Turn off the power switch at the following times.
The machine may operate if the treadle is depressed by mistake, which could result in injury.</p> <ul style="list-style-type: none">• When threading the needle• When replacing the bobbin and needle• When not using the machine and when leaving the machine unattended |  <p>Use both hands to hold the machine head when tilting it back or returning it to its original position. If only one hand is used, the weight of the machine head may cause your hand to slip, and your hand may get caught.</p> |
|  <p>If using a work table which has casters, the casters should be secured in such a way so that they cannot move.</p> |  <p>If an error occurs in machine operation, or if abnormal noises or smells are noticed, immediately turn off the power switch. Then contact your nearest Brother dealer or a qualified technician.</p> |
| |  <p>If the machine develops a problem, contact your nearest Brother dealer or a qualified technician.</p> |

Cleaning

- | | |
|---|---|
|  <p>Turn off the power switch before carrying out cleaning. The machine may operate if the treadle is depressed by mistake, which could result in injury.</p> |  <p>Be sure to wear protective goggles and gloves when handling the lubricating oil and grease, so that they do not get into your eyes or onto your skin, otherwise inflammation can result.
Furthermore, do not drink the oil or eat the grease under any circumstances, as they can cause vomiting and diarrhea.
Keep the oil out of the reach of children.</p> |
|  <p>Secure the table so that it will not move when tilting back the machine head. If the table moves, it may crush your feet or cause other injuries.</p> | |
|  <p>Use both hands to hold the machine head when tilting it back or returning it to its original position. If only one hand is used, the weight of the machine head may cause your hand to slip, and your hand may get caught.</p> | |

Maintenance and inspection

- | | |
|--|---|
|  <p>Maintenance and inspection of the sewing machine should only be carried out by a qualified technician.</p> |  <p>Secure the table so that it will not move when tilting back the machine head. If the table moves, it may crush your feet or cause other injuries.</p> |
|  <p>Ask your Brother dealer or a qualified electrician to carry out any maintenance and inspection of the electrical system.</p> |  <p>Use both hands to hold the machine head when tilting it back or returning it to its original position. If only one hand is used, the weight of the machine head may cause your hand to slip, and your hand may get caught.</p> |
|  <p>Turn off the power switch and disconnect the power cord from the wall outlet at the following times, otherwise the machine may operate if the treadle is depressed by mistake, which could result in injury.</p> <ul style="list-style-type: none">• When carrying out inspection, adjustment and maintenance• When replacing consumable parts such as the rotary hook and knife |  <p>When replacing parts and installing optional accessories, be sure to use only genuine Brother parts.
Brother will not be held responsible for any accidents or problems resulting from the use of non-genuine parts.</p> |
|  <p>Always be sure to turn off the power switch and then wait one minute before opening the pulley cover. If you touch the surface of the motor, it may cause burns.</p> |  <p>If any safety devices have been removed, be absolutely sure to re-install them to their original positions and check that they operate correctly before using the machine.</p> |
|  <p>If the power switch needs to be left on when carrying out some adjustment, make sure that you switch the sewing machine to maintenance mode. Pay careful attention to safety.</p> |  <p>To prevent accidents and problems, do not modify the machine yourself.
Brother will not be held responsible for any accidents or problems resulting from modifications made to the machine.</p> |

[3] Warning labels

The following warning labels appear on the sewing machine.

Please follow the instructions on the labels at all times when using the machine. If the labels have been removed or are difficult to read, please contact your nearest Brother dealer.

	⚠ 危険		⚠ 危険	
	高電圧部分にふれて、大けがをすることがある。 電源を切り、5分たってからカバーをはずすこと。		接触高电压部分，会导致受伤。 在切断电源5分钟后，再开启盖罩。	
⚠ DANGER	⚠ GEFAHR	⚠ DANGER	⚠ PERIGRO	
Hazardous voltage will cause injury. Turn off main switch and wait 5 minutes before opening this cover.	Hochspannung verletzungsgefahr! Bitte schalten sie den hauptschalter aus und warten sie 5 minuten, bevor sie diese abdeckung öffnen.	Un voltage non adapte provoque des blessures. Eteindre l'interrupteur et attendre 5 minutes avant d'ouvrir le capot.	Un voltaje inadecuado puede provocar las heridas. Apagar el interruptor principal y esperar 5 minutos antes de abrir esta cubierta.	

2 Touching areas where high voltages are present can result in severe injury. Turn off the power before opening the cover.

4 Be careful not to get your hands caught when returning the machine head to its original position after it has been tilted.

3

CAUTION
Moving parts may cause injury.

Operate with safety devices* installed.

Turn off the power before carrying out operations such as threading, changing the needle, bobbin, knives or hook, cleaning and adjusting.

5 Be careful to avoid injury from the moving thread take-up.

6 High temperature warning display

7 **PE** Be sure to connect the ground. If the ground connection is not secure, you run a high risk of receiving a serious electric shock, and problems with correct operation may also occur.

8 Direction of operation

- * Safety devices:
- (A) Finger guard
 - (B) Thread take-up cover
 - (C) Motor cover
 - (D) Pulse motor cover

9

brother
Lubricating Oil for Machining

CAUTION

Lubricating oil may cause inflammation to eye and skin.
Wear protective glasses and gloves.

Swallowing oil can cause diarrhoea and vomiting.
Do not swallow.

Keep away from children.

FIRST AID

Eye contact :
-Rinse with plenty of cold water.
-Seek medical help.

Skin contact :
-Wash with soap and water.

If swallowed :
-Seek medical help immediately.
-Do not induce vomiting.

10 Do not hold. Problems with operation or injury may occur.

11 Do not place your hands inside the bottom cover. Problems with operation or injury may occur.

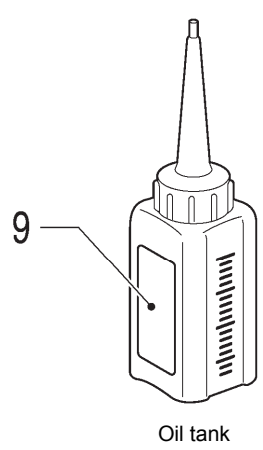
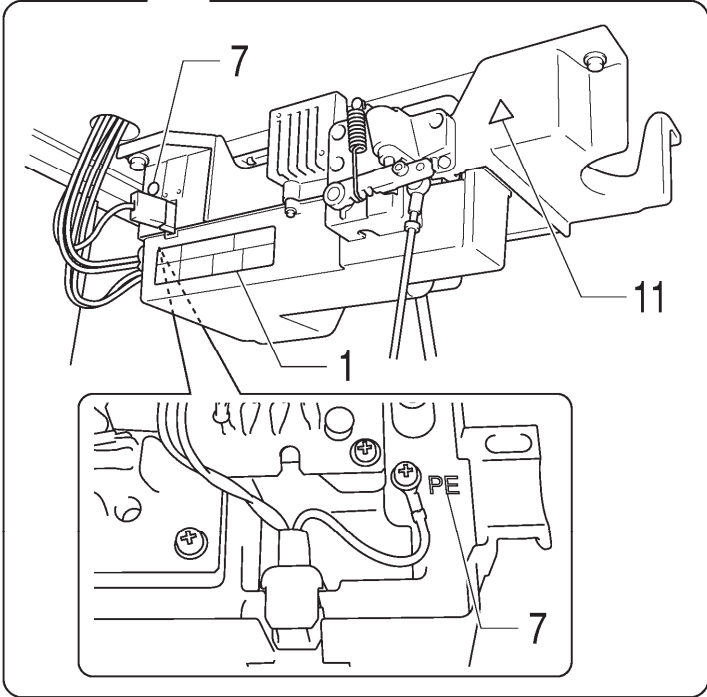
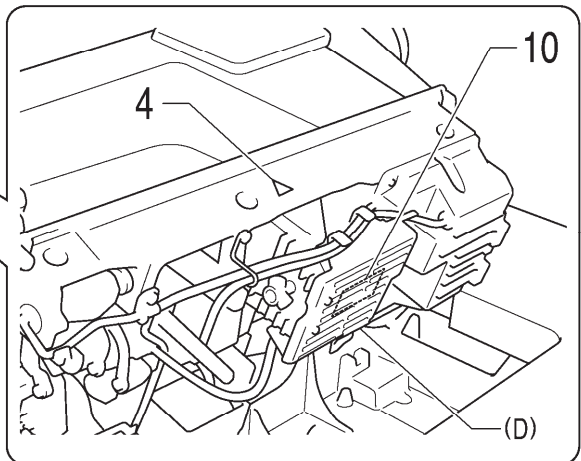
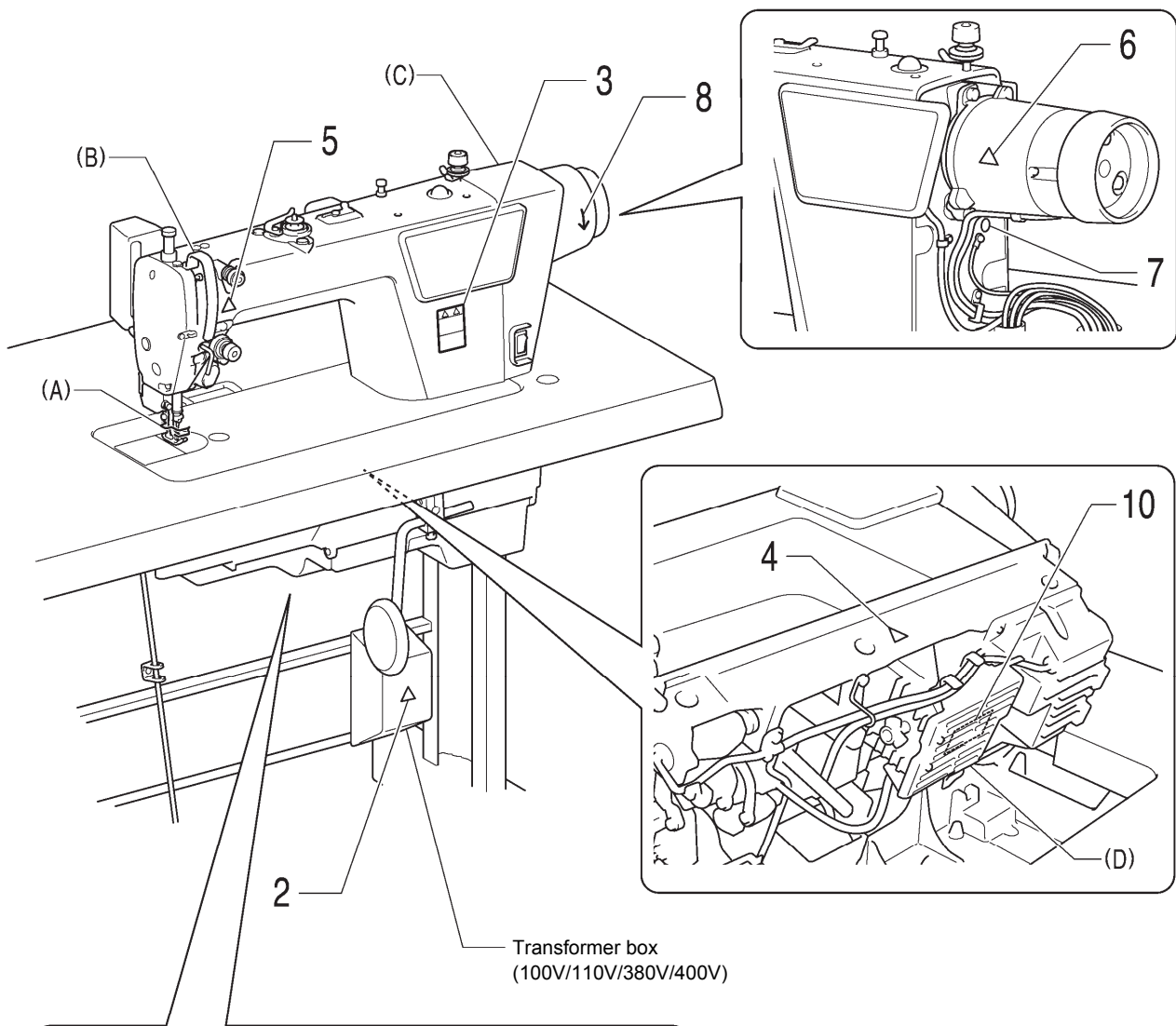

CONTENTS

1. MACHINE SPECIFICATIONS	1
2. INSTALLATION	2
2-1. Table processing diagram	3
2-2. Installation	3
2-3. Lubrication	6
2-4. Connecting the cords.....	7
2-4-1. Connecting the cords	7
2-4-2. Other cords	9
3. USING THE OPERATION PANEL (BASIC OPERATIONS)	13
3-1. Names and functions.....	13
3-2. Sewing start and end backtack stitches	15
3-3. Sewing continuous backtack stitches.....	16
4. USING THE OPERATION PANEL (ADVANCED OPERATIONS)	17
4-1. Sewing pitch setting method	17
4-2. Switching the 4-digit display	18
4-3. Setting the sewing speed	18
4-3-1. Setting the maximum sewing speed	18
4-3-2. Backtack sewing speed setting method	19
4-4. Setting the counters.....	20
4-4-1. Lower thread counter.....	20
4-4-2. Production counter.....	21
4-4-3. Needle replacement counter.....	22
4-5. Sewing locus setting meth.....	23
4-6. Setting basic functions.....	24
4-6-1. Changing the needle stop position	25
4-6-2. Thread trimming disable	26
4-6-3. Thread wiping	27
4-6-4. Correction sewing	28
4-6-5. Slow start	29
4-6-6. Setting the illumination LED light	30
4-6-7. Setting lower thread counter operation .	31
4-6-8. Prev. thread away	32
4-6-9. Short trailing thread.....	33
4-6-10. Correction sewing function (1)	34
4-6-11. Correction sewing function (2)	35
4-7. Memory switch setting method	36
4-8. List of memory switch settings	37
4-9. Reading and writing data using USB media...	41
4-10. Resetting all settings to their defaults.....	42
4-11. Hand switch	43
4-11-1. Hand switch function setting	45
4-11-2. 2nd correction pitch setting.....	46
4-11-3. 2nd pitch setting.....	46
4-11-4. Menu numbers for setting functions for the hand switch	46
5. CLEANING	47
6. STANDARD ADJUSTMENTS	48
6-1. Arm thread guide R.....	48
6-2. Presser foot height.....	49
6-3. Adjusting the feed dog height	50
6-4. Adjusting the feed dog angle	51
6-5. Adjusting the needle bar height	51
6-6. Adjusting the needle and feed mechanism timing.....	52
6-7. Needle and rotary hook timing	53
6-8. ADJUSTING THE ROTARY HOOK LUBRICATION AMOUNT	54
6-9. Thread trimming (Other than short trailing thread specifications)	55
6-10. Thread trimming (Short trailing thread specifications)	58
7. TROUBLESHOOTING	61
7-1. Sewing	61
7-2. Error code displays	68
8. 7-SEGMENT DISPLAY	72

1. MACHINE SPECIFICATIONS

BROTHER INDUSTRIES, LTD.

S-7250A-000

	3	4
Thread wiper		O







1424D

	P
Specifications	Short trailing thread specifications

	3	5
Use	For medium-weight materials	For heavy-weight materials
Max. sewing speed * Standard feed locus	Stitch length 2.0 mm or less/ 5,000 sti/min	4,000 sti/min
Sewing speed at the time of shipment	4,000 sti/min	
Backtack sewing speed * Standard feed locus	Automatic 150 (*1) - 3000 sti/min, Manual 150 (*1) - 4000 sti/min* (*1) Inching setting speed	
Max. stitch length	5 mm	5 mm (can be set to 7 mm)
Presser foot height	Lifting lever	6 mm
	Knee lifter	13 mm
Feed dog height	0.8 mm	1.2 mm
Needle (DB×1, DP×5)	#11 - #18	#19 - #22
Motor	AC servo motor	
Control circuit	Microprocessor	

2. INSTALLATION

CAUTION

-  Machine installation should only be carried out by a qualified technician.
 -  Contact your Brother dealer or a qualified electrician for any electrical work that may need to be done.
 -  The sewing machine weighs approximately 35 kg (77lb). The installation should be carried out by two or more people.
 -  Do not connect the power cord until installation is complete. The machine may operate if the treadle is depressed by mistake, which could result in injury.
-  Secure the table so that it will not move when tilting back the machine head. If the table moves, it may crush your feet or cause other injuries.
 -  Use both hands to hold the machine head when tilting it back or returning it to its original position. If only one hand is used, the weight of the machine head may cause your hand to slip, and your hand may get caught.

About the machine set-up location

- Do not set up this sewing machine near other equipment such as televisions, radios or cordless telephones, otherwise such equipment may be affected by electronic interference from the sewing machine.
- The sewing machine should be plugged directly into an AC wall outlet. Operation problems may result if extension cords are used.

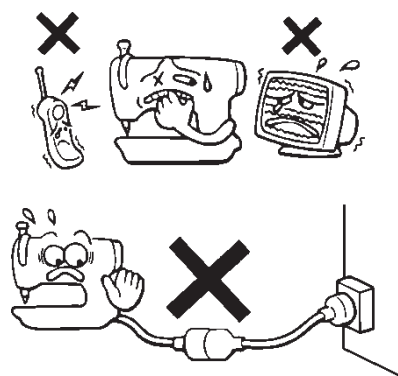

0475D

Carrying the machine

- The sewing machine should be carried by the arm and the motor cover by two people as shown in the illustration.
- * Do not hold by any part other than the motor cover. If this is not observed, it may result in damage to the sewing machine.

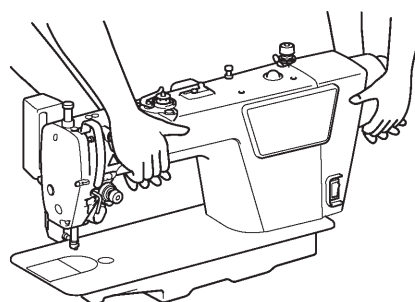

1341D

Tilting back the machine head

- Hold section (A) with your foot so that the table does not move, and then push the arm with both hands to tilt back the machine head.

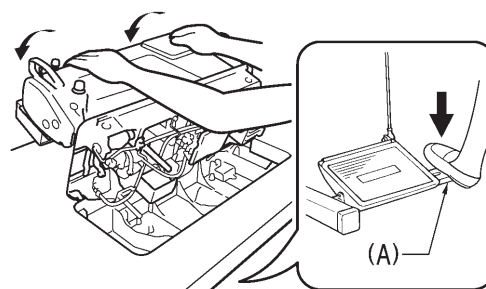

1342D

Returning the machine head to the upright position

1. Clear away any tools, etc. which may be near the table holes.
2. While holding the face plate with your left hand, gently return the machine head to the upright position with your right hand.

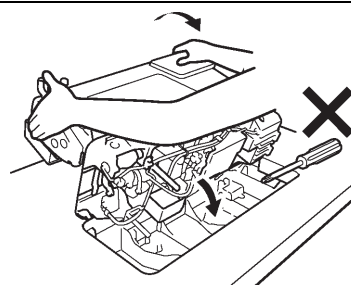

1343D

2. INSTALLATION

2-1. Table processing diagram

- The top of the table should be 40 mm in thickness and should be strong enough to hold the weight and withstand the vibration of the sewing machine.
- Drill holes as indicated in the illustration below.

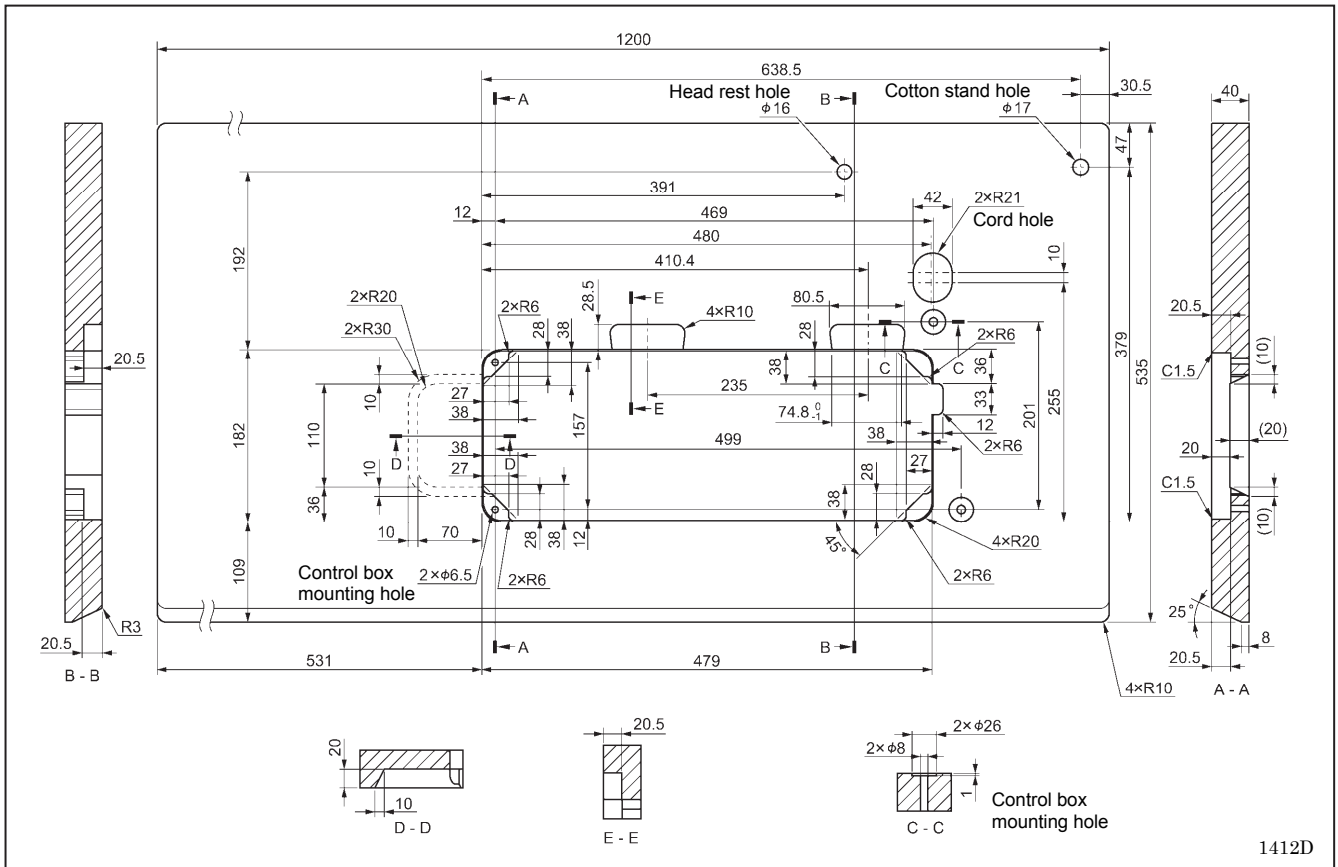

2-2. Installation

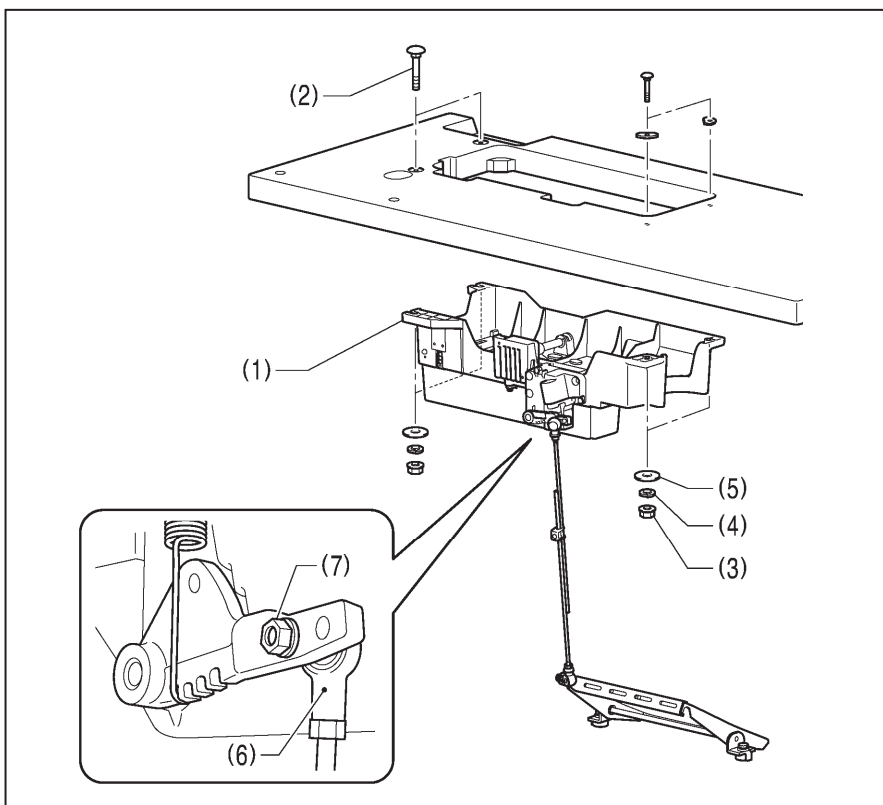

1. Control box + Oil pan

- (1) Control box
- (2) Bolts [4 pcs]
- (3) Nuts [4 pcs]
- (4) Spring washers [4 pcs]
- (5) Washers [4 pcs]

2. Connecting rod

- (6) Connecting rod
- (7) Nut

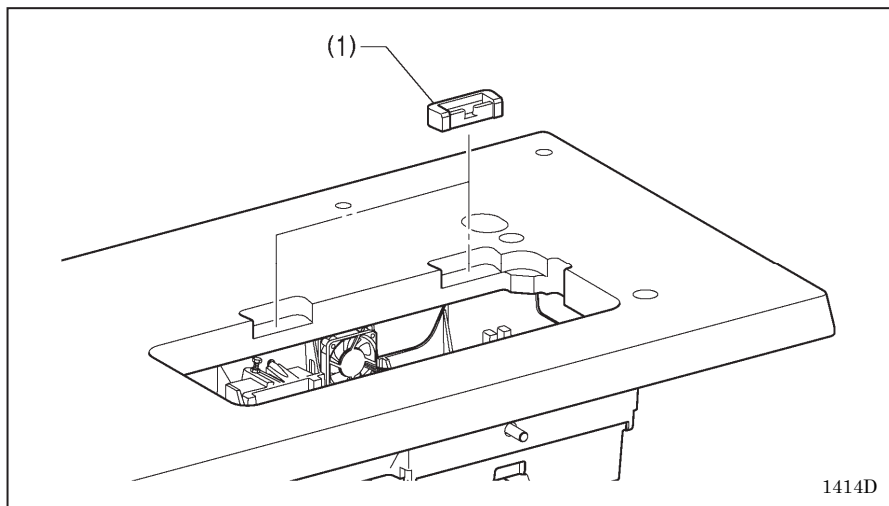

3. Rubber cushions

(1) Rubber cushions [2 pcs]

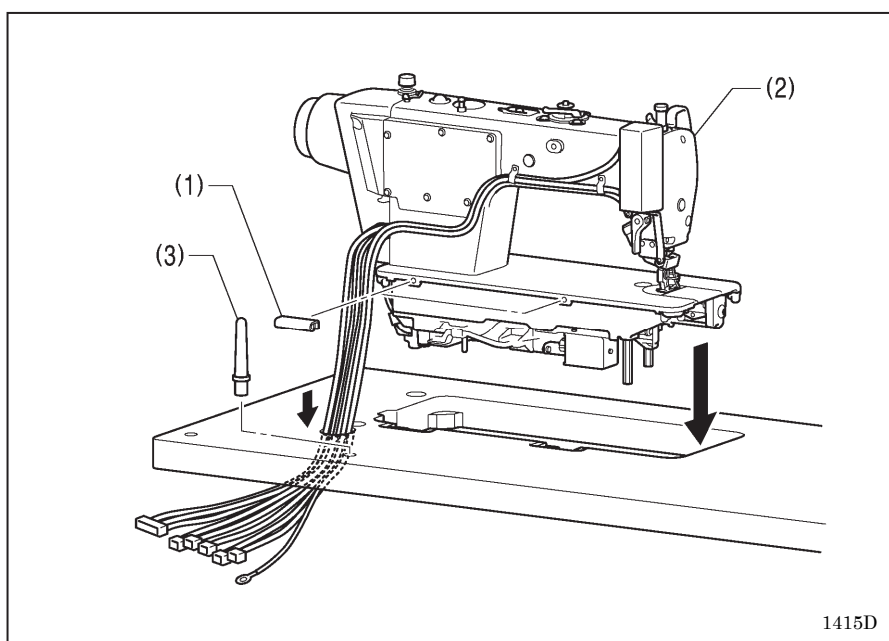

4. Machine head

(1) Hinges [2 pcs]

(2) Machine head

(3) Head rest

NOTE:

- Bind the cords together and pass them through the cord hole.
- Tap the head rest (3) securely into the table hole.
- If the head rest (3) is not pushed in as far as it will go, the machine head will not be sufficiently stable when it is tilted back.

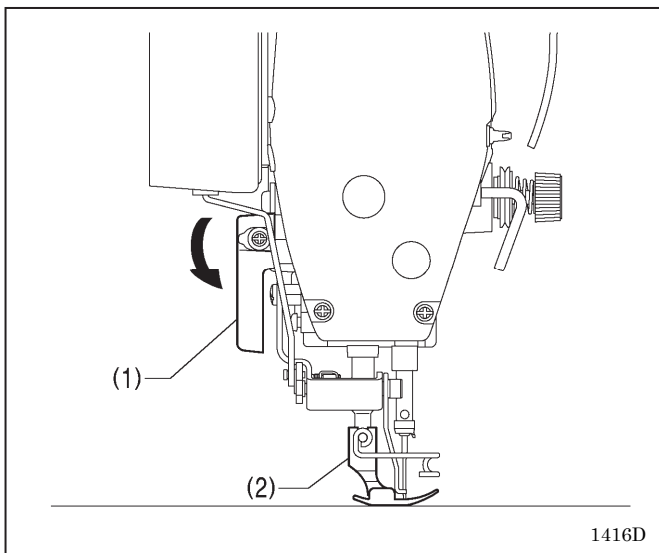

5. Knee lifter plate

<Knee lifter adjustment>

1. Turn the machine pulley so that the feed dog is below the top of the needle plate.
2. Lower the presser foot (1) by using the lifting lever (2).

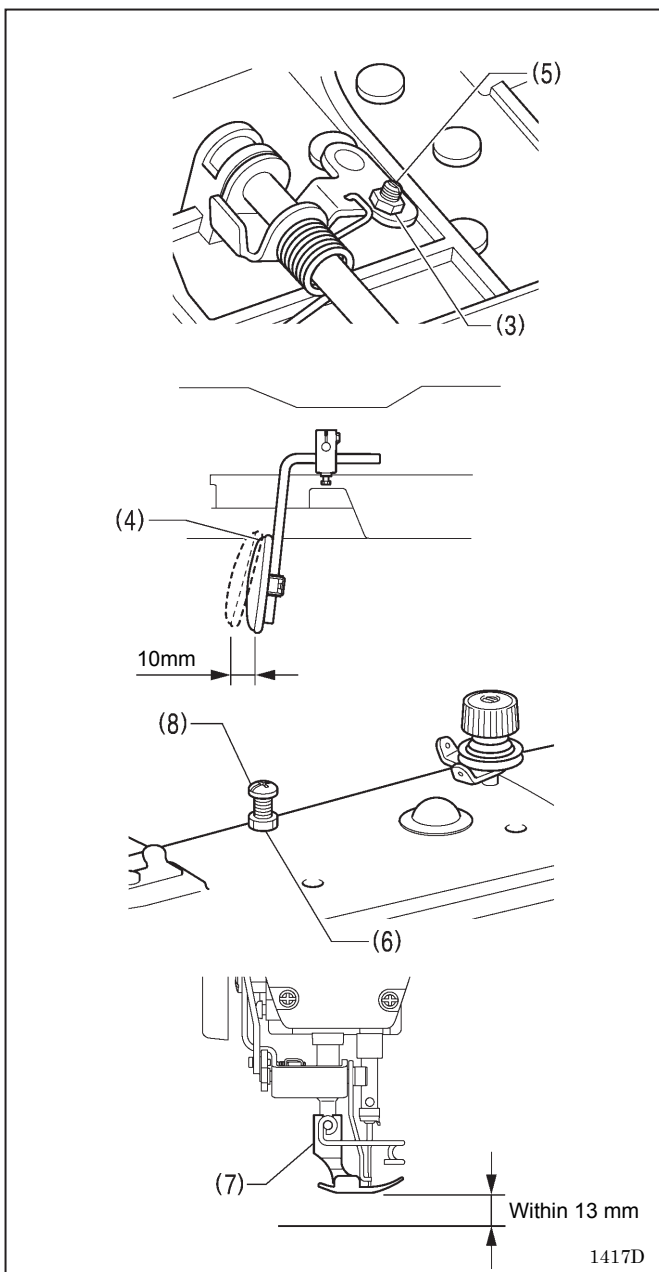



3. Loosen the nut (3).
4. Turn the screw (5) to adjust so that the amount of play in the knee lifter plate (4) is approximately 10 mm.
5. After adjustment is completed, securely tighten the nut (3).

6. Loosen the nut (6).
7. Turn the adjusting screw (8) to adjust so that the presser foot (7) is at the desired position within a distance of 13 mm from the needle plate when the knee lifter plate is fully pressed.
8. After adjustment is completed, securely tighten the nut (6).

2-3. Lubrication

! CAUTION

-  Do not connect the power cord until lubrication has been completed, otherwise the machine may operate if the treadle is depressed by mistake, which could result in injury.
-  Be sure to wear protective goggles and gloves when handling the lubricating oil, so that it does not get into your eyes or onto your skin. If care is not taken, inflammation can result. Furthermore, do not drink the lubricating oil. Diarrhea or vomiting may result. Keep the oil out of the reach of children.
-  When cutting the nozzle of the oil tank, hold the base of the nozzle securely. If you hold the end of the nozzle, injury from the scissors may result.

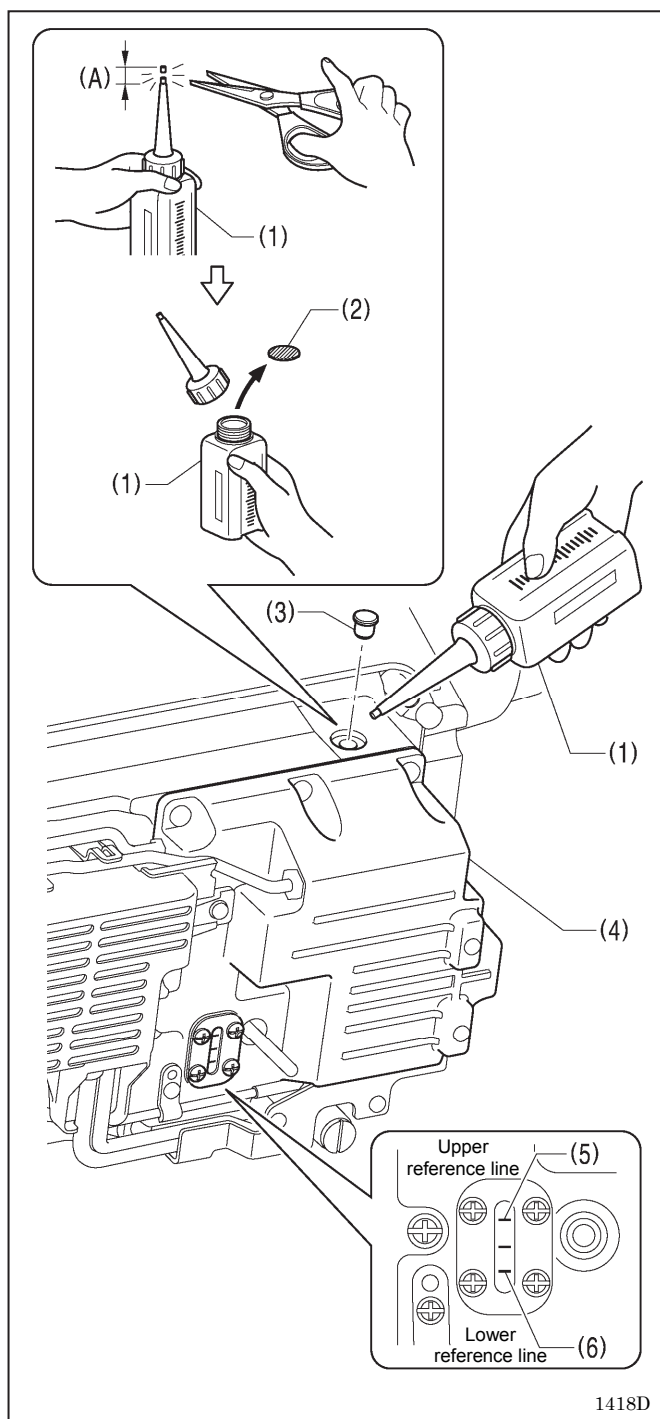

The sewing machine should always be lubricated and the oil supply replenished before it is used for the first time, and also after long periods of non-use.

1. Hold the base of the nozzle of the accessory oil tank (1), and use scissors to cut about half-way along the straight section (A) of the nozzle.
2. Loosen and remove the nozzle, and then remove the seal (2).
3. Tighten the nozzle.
4. Tilt back the machine head.
5. Remove the rubber cap (3), and pour lubricating oil into the oil cover (4) until it reaches the upper reference line (5).
6. Replace the rubber cap (3).
7. Return the machine head to its original position.

NOTE:

When the machine head is tilted back at times such as the following, lubricating oil may leak out from the oil cover (4).

- 1) If lubricating oil is added until the oil level goes above the upper reference line (5) on the oil cover (4).





<Lubrication oil replenishment interval>

If the oil level drops below the lower reference line (6) on the oil cover (4), be sure to replenish the oil.

1418D

2-4. Connecting the cords

CAUTION

-  Contact your Brother dealer or a qualified electrician for any electrical work that may need to be done.
-  Do not connect the power cord until all cords have been connected.
The machine may operate if the treadle is depressed by mistake, which could result in injury.
-  When securing the cords, do not bend the cords excessively or fasten them too hard with staples, otherwise there is the danger that fire or electric shocks could occur.
-   Be sure to connect the ground. If the ground connection is not secure, you run a high risk of receiving a serious electric shock, and problems with correct operation may also occur.

2-4-1. Connecting the cords

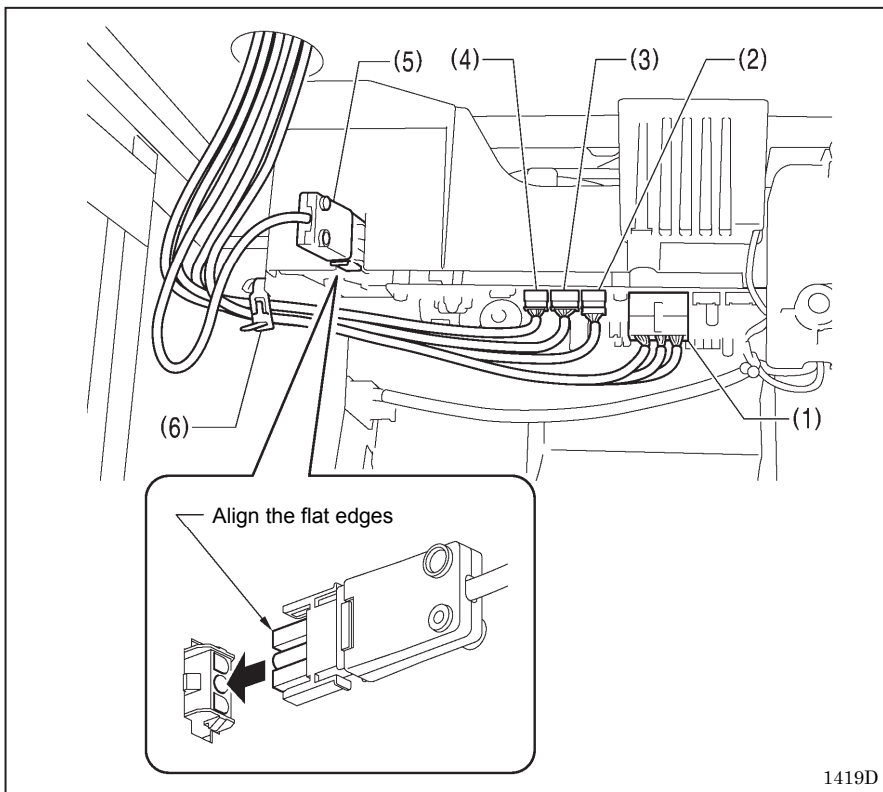

1. Cords (1)

- (1) Solenoid connector 14-pin
- (2) Sewing machine motor encoder connector 10-pin
- (3) Feed motor encoder connector 6-pin
- (4) Operation panel connector 5-pin
- (5) Power connector 3-pin

1. Secure the cords to the control box with the black band (6).

NOTE:

For Europe specifications, Americas 220 V specifications and 100 V/400 V system specifications, refer to "2-4-2. Other cords".

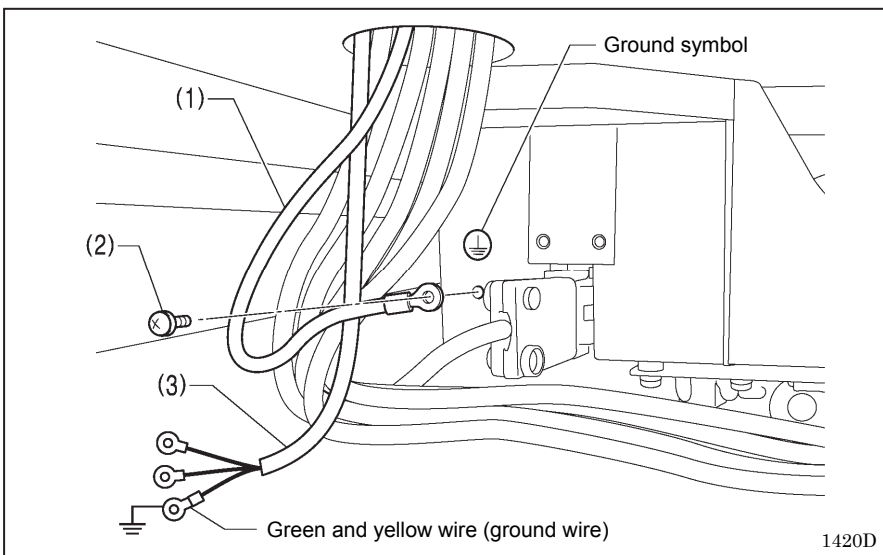

2. Ground wire

- (1) Ground wire
 - (2) Screw
 - (3) Power cord
1. Attach an appropriate plug to the power cord (3).
(The green and yellow wire is the ground wire.)
 2. Insert the power plug into a properly-grounded electrical outlet.

NOTE:

- Make sure that the ground connections are secure in order to ensure safety.
- For Europe specifications, Americas 220 V specifications and 100 V/400 V system specifications, refer to "2-4-2. Other cords".

3. Cords (2)

- (1) Machine motor connector 4-pin
- (2) Feed motor connector 6-pin

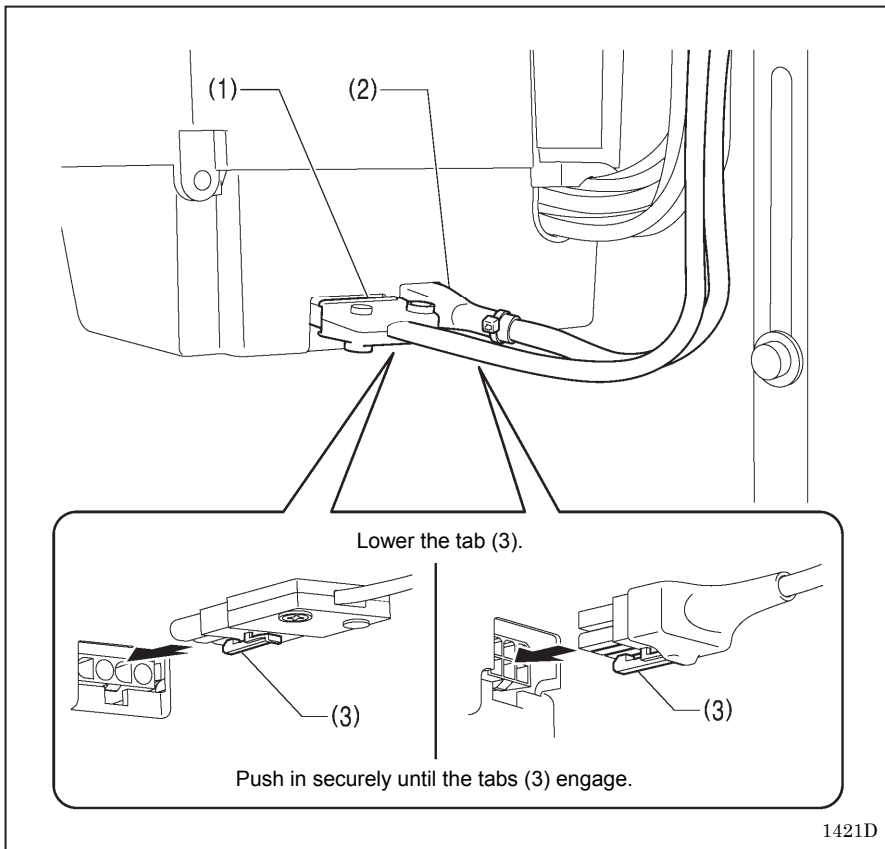

1421D

2. INSTALLATION

2-4-2. Other cords

⚠ DANGER



Wait at least 5 minutes after turning off the power switch and disconnecting the power cord from the wall outlet before opening the cover of the control box. Touching areas where high voltages are present can result in severe injury.

For Europe specifications, Americas 220 V specifications and 100 V/400 V system specifications, connect the cords according to the respective specifications.

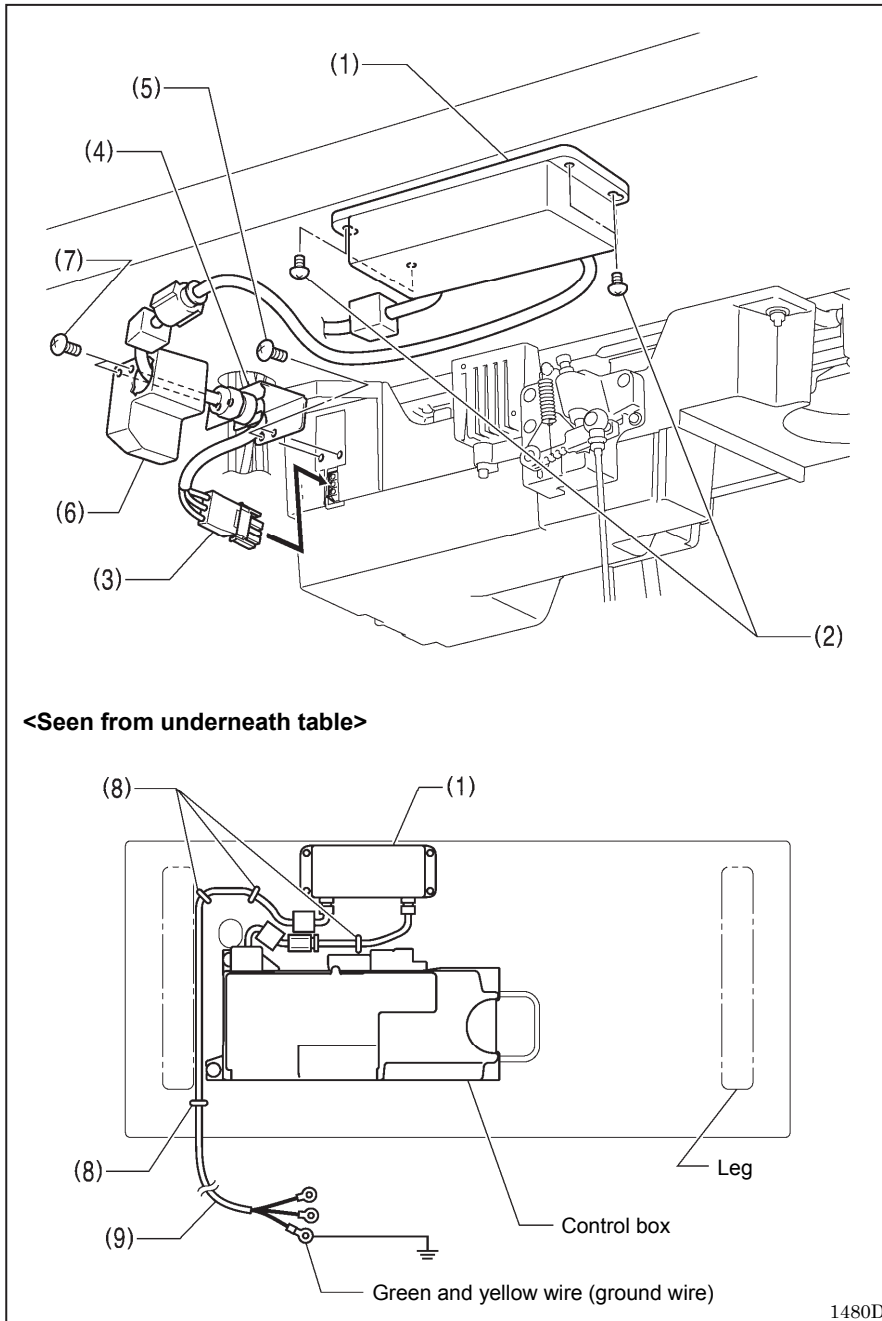

<Europe specifications>

- (1) Filter box
- (2) Screws [4 pcs]
- (3) Connector
- (4) CE bush plate
- (5) Screws [2 pcs]
- (6) CE D cord cover
- (7) Screws [2 pcs]
- (8) Staples [4 pcs]
- (9) Power cord

1. Attach an appropriate plug to the power cord (9). (The green and yellow wire is the ground wire.)
2. Insert the power plug into a properly-grounded electrical outlet.

NOTE:

- Take care when tapping in the staples (8) to make sure that they do not pierce the cords.
- Do not use extension cords, otherwise machine operation problems may result.

For Europe specifications, Americas 220 V specifications and 100 V/400 V system specifications, connect the cords according to the respective specifications.

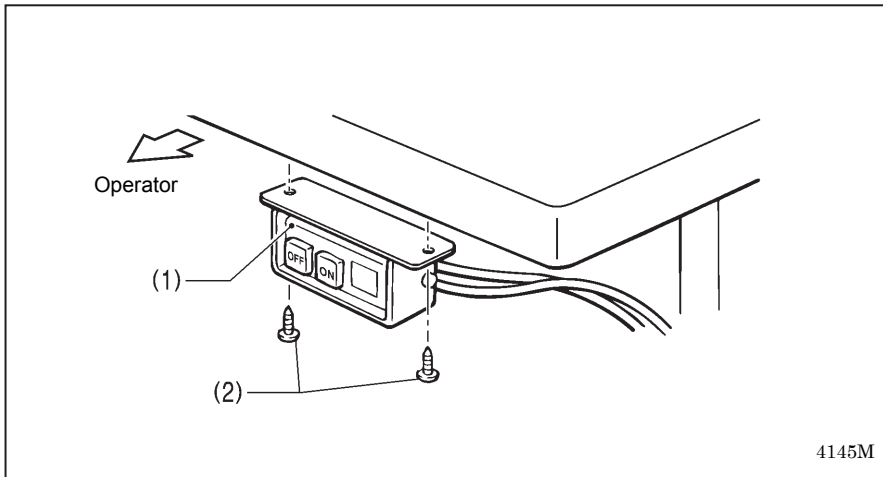

<For 100 V/400 V system specifications>

- (1) Power switch
- (2) Screws [2 pcs]

2. INSTALLATION

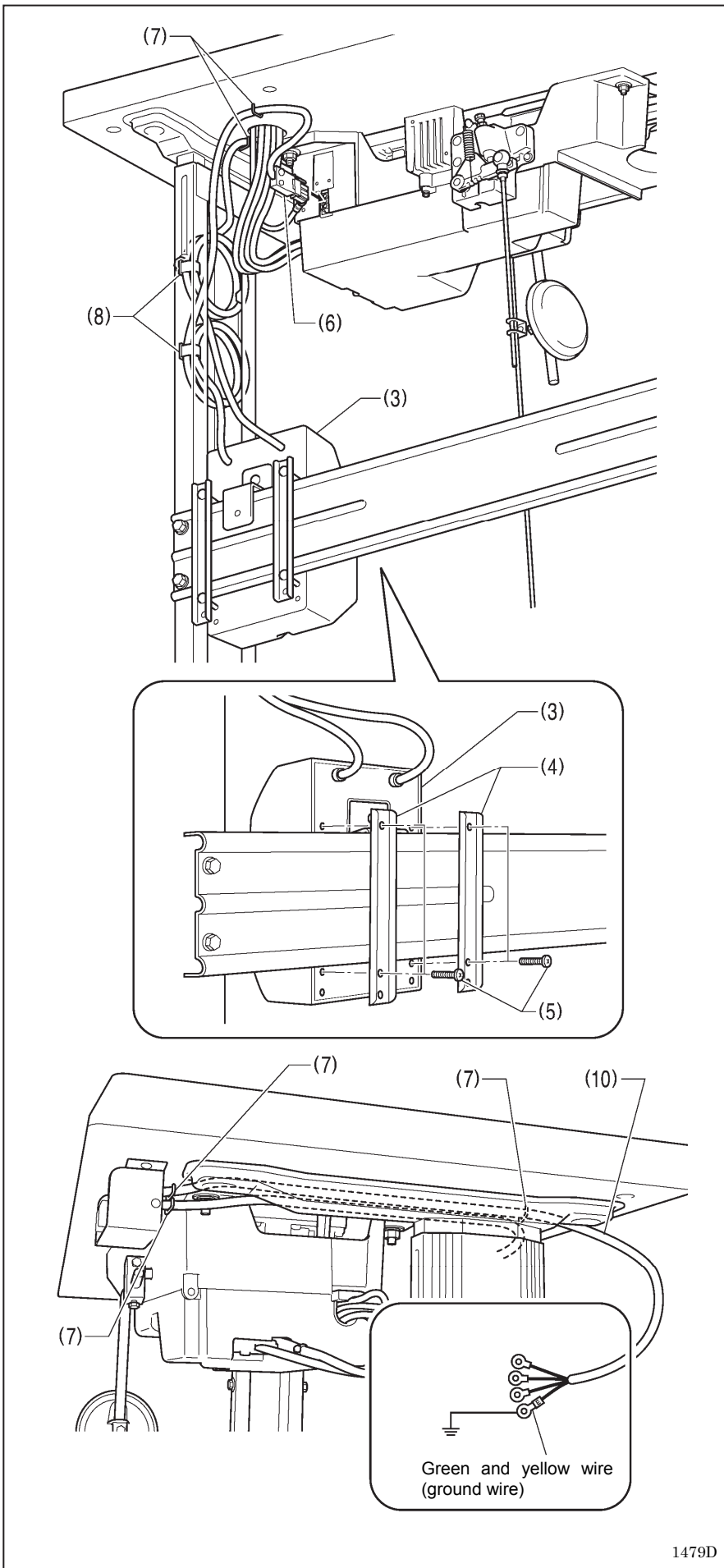

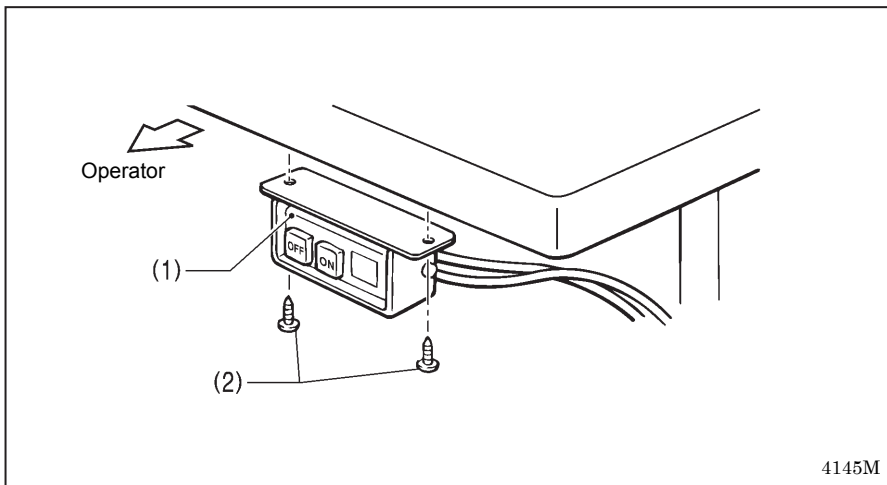

<For Americas 220 V specifications>

- (1) Power switch
- (2) Screws [2 pcs]

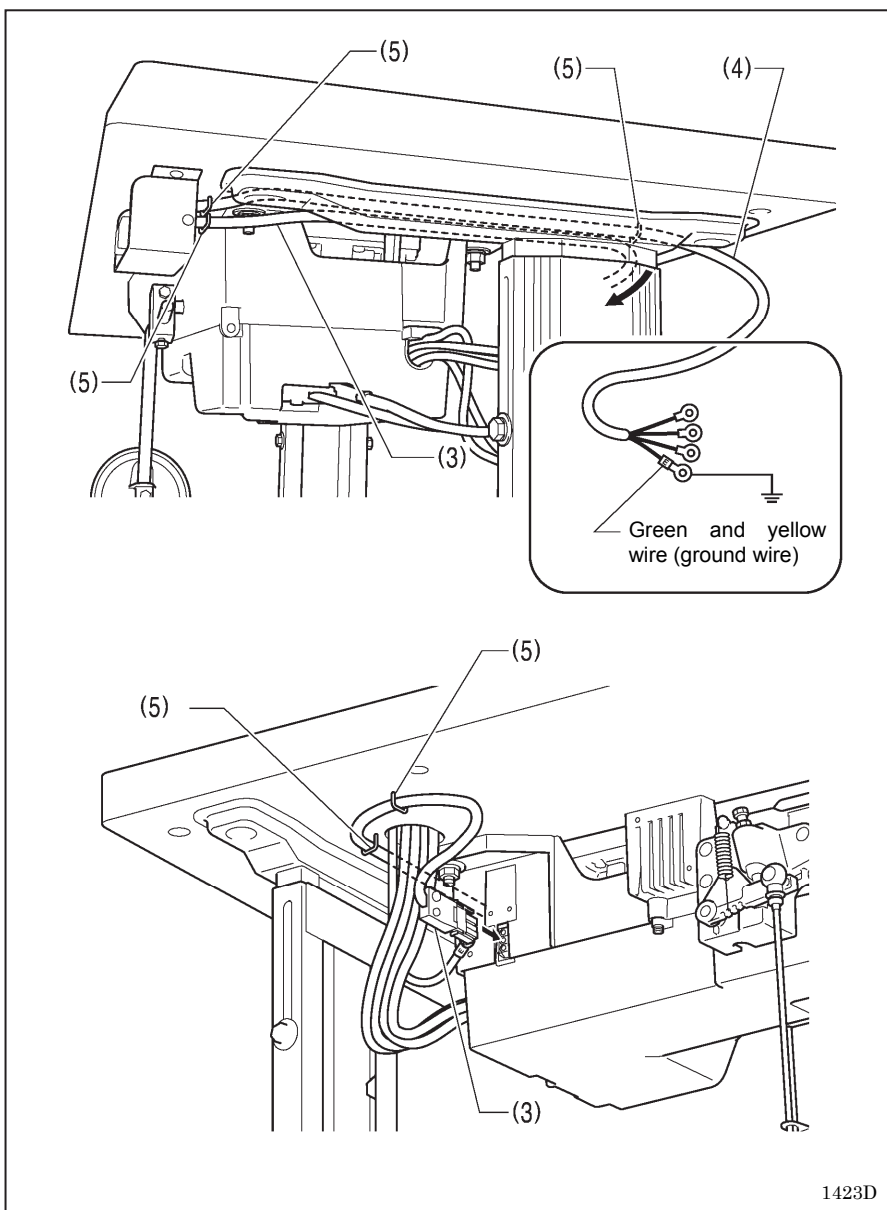

- (3) Power supply connector 3-pin
- (4) Power cord
- (5) Staples [5 pcs]

1. Attach an appropriate plug to the power cord (4).
(The green and yellow wire is the ground wire.)
2. Insert the power plug into a properly-grounded electrical outlet.

NOTE:

- Take care when tapping in the staples (5) to make sure that they do not pierce the cords.
- Do not use extension cords, otherwise machine operation problems may result.

3. USING THE OPERATION PANEL (BASIC OPERATIONS)

3-1. Names and functions

- The operation panel keys cannot be operated while sewing is in progress. Select the keys and set the number of stitches before starting sewing.
- In the case of keys with indicators, the indicator illuminates when that function is operating, and the indicator switches off when the key is pressed once more.

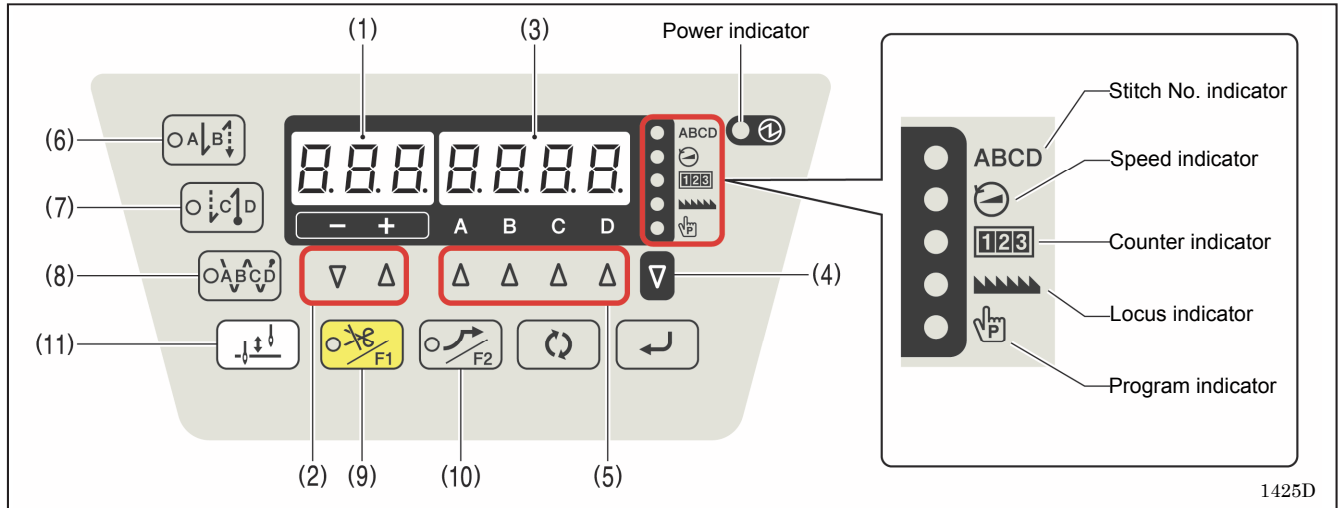

The power indicator illuminates when the power switch is turned on.

(1) 3-digit display



Displays the sewing pitch.

1426D

(2) Pitch setting keys



Use these keys to set the sewing pitch.

- When the - key is pressed, the setting decreases in steps of 0.05 within a range of 0.05 to 5.00.
- When the + key is pressed, the setting increases in steps of 0.05 within a range of 0.05 to 5.00.

1427D

(3) 4-digit display



- When start backtick stitches are being displayed, the indicator of the start backtick key (6) will illuminate, and the number of A stitches will appear in the A column and the number of B stitches will appear in the B column.
- When end backtick stitches are being displayed, the indicator of the end backtick key (7) will illuminate, and the number of C stitches will appear in the C column and the number of D stitches will appear in the D column.
- When continuous backtick stitches are displayed, the indicator of the continuous backtick key (8) will illuminate, and the number of A, B, C and D stitches will appear in order starting from the left column of the display.
- The five indicators on the right side of the window show which value is appearing in the 4-digit display. The 4-digit display shows the number of stitches, speed, counter, locus and program. When the number of stitches is being displayed, the ABCD indicator (Stitch No. indicator) will illuminate.

1428D

(4) SEL (Select) key



The value in the 4-digit display (3) can be changed each time this key is pressed.

1340D

(5) Setting keys



These keys are used to set the number of backtick stitches for A, B, C and D.

- When the Δ key is pressed, the setting increases from 0 up to 9.
- If you press the Δ key once more when "9" is displayed, the value will return to "0".
- If you hold down the Δ key, the value will change continuously.

1429D

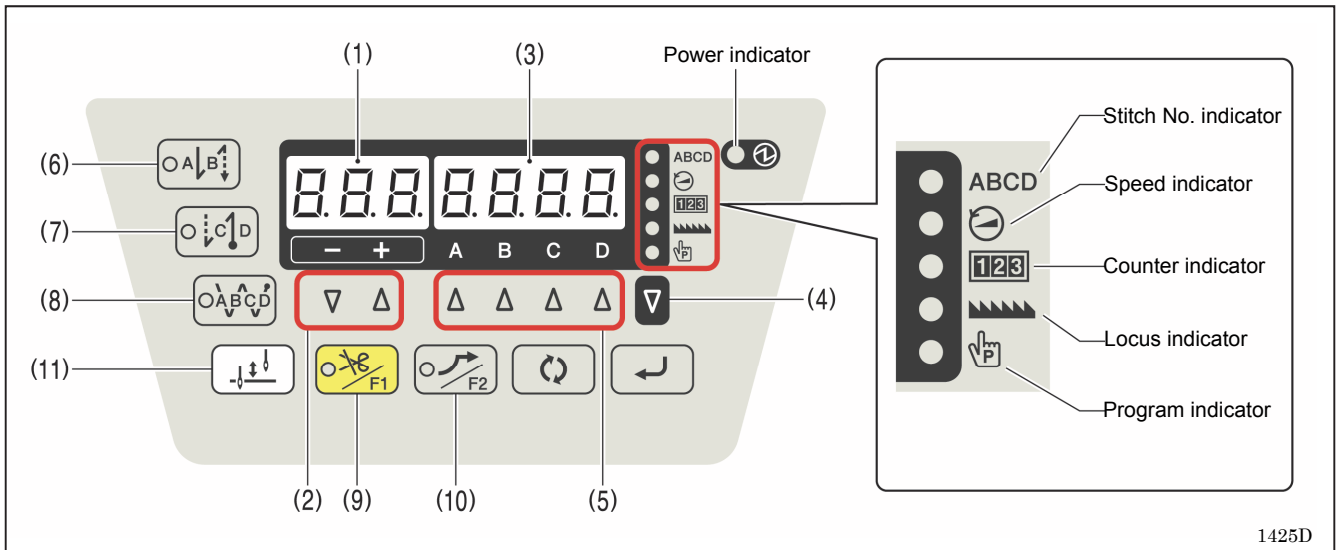

1425D

- (6) Start backtack key



When this key is pressed so that the indicator illuminates, the number of start backtack stitches (0 - 9) in the A and B columns of the display are sewn.

1323D

- (7) End backtack key

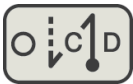

When this key is pressed so that the indicator illuminates, the number of end backtack stitches (0 to 9) in the C and D columns of the display are sewn. When the treadle is depressed backward, the end backtack stitches are sewn and then the thread is trimmed. If the treadle has not yet been depressed backward, the end backtack function can be set to ON, the number of stitches can be changed and the function can be set back to OFF.

1325D

- (8) Continuous backtack key



When this key is pressed so that the indicator illuminates, the number of backtack stitches (0 to 9) in the A, B, C and D columns of the display are sewn continuously. After the sewing machine sews a full cycle of stitches set by A, B, C and D, the thread is trimmed.

1327D

- (9) Thread trimming disable/F1 key



When this key is pressed so that the indicator illuminates, the sewing machine stops in the needle up position without thread trimming being carried out even if the treadle is depressed backward.

1330D

- (10) Slow start/F2 key



When this key is pressed so that the indicator illuminates, sewing is carried out at 700 sti/min for the first two stitches at the next sewing start after thread trimming. After this, the sewing speed corresponds to the treadle depression amount.

1332D

- (11) Half stitch key



When the sewing machine is stopped, the needle bar can be moved up and down by pressing this key.

1329D

3-2. Sewing start and end backtack stitches

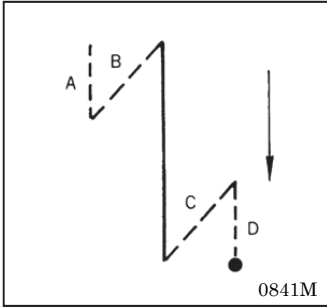

<p>1</p>	<p>Setting start backtack stitches</p>	<p>Press the key so that the ABCD indicator and the keys illuminate.</p> <p>Press the key to set the number of stitches for A and B.</p> <p>For example, to select 3 stitches and 4 stitches: A-3, B-4</p> <p style="text-align: right;">1351D</p>
<p>2</p>	<p>Setting end backtack stitches</p>	<p>Press the key so that the ABCD indicator and the keys illuminate.</p> <p>Press the key to set the number of stitches for C and D.</p> <p>For example, to select 3 stitches and 2 stitches: C-3, D-2</p> <p style="text-align: right;">1351D</p>
<p>3</p>		<p>Start backtacking is carried out. After it has finished, normal sewing continues for as long as the treadle remains depressed.</p> <p>NOTE: If the treadle is returned to the neutral position, the sewing machine will continue operating until the set number of start backtack stitches has been sewn.</p> <p style="text-align: right;">2159M</p>
<p>4</p>		<p>End backtacking is carried out. After it has finished, the thread is trimmed automatically and the sewing machine stops in the needle up position.</p> <p>NOTE:</p> <ul style="list-style-type: none"> • If the treadle is depressed backward before sewing of the set number of start backtack stitches is complete, end backtacking will not be carried out. • If thread trimming lock is set, the sewing machine will stop in the needle up position without thread trimming being carried out. <p style="text-align: right;">2160M</p>

3-3. Sewing continuous backtack stitches

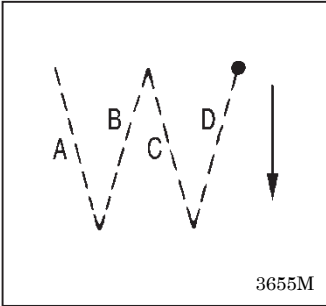

1

Sewing continuous backtack stitches

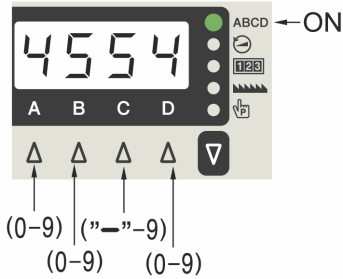

Press the key so that the **ABCD** indicator and the keys illuminate.

Press the key to set the number of stitches for A, B, C and D.

For example, to select 4 stitches for A and 5 stitches for B: A-4, B-5
To select 5 stitches for C and 4 stitches for D: C-5, D-4

1352D

2

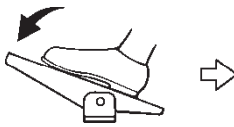

If the treadle is simply depressed continuously, the number of stitches set for A, B, C and D will be sewn in a single cycle, the thread will be trimmed automatically and then the needle bar will stop in the needle up position.

NOTE:

- If the treadle is returned to the neutral position while continuous backtacking is being carried out, the sewing machine will stop at the point where the treadle returns to the neutral position. If the treadle is depressed again, operation will resume from the point where it was interrupted.
- If thread trimming lock is set, the sewing machine will stop in the needle up position without thread trimming being carried out.

2159M

3

If "-" is set as the number of stitches for C, the number of stitches set by AB can be sewn D times.

For example, if D=3: ABA
If D=6: ABABAB



4. USING THE OPERATION PANEL (ADVANCED OPERATIONS)



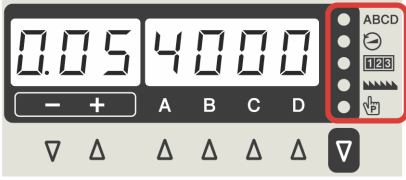
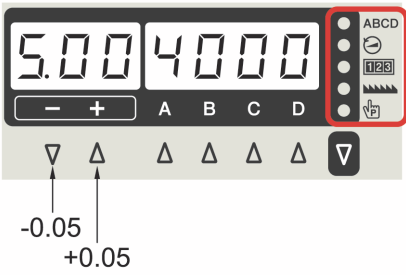
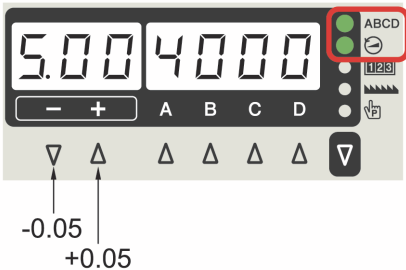

The operations described in this section should only be carried out by a technician.

4-1. Sewing pitch setting method

<p>1</p>	 <p>Any indicator illuminates</p>	<p>Press the ▽ key so that the stitch no., speed, counter, locus or program indicator illuminates.</p> <ul style="list-style-type: none"> The sewing pitch can be set regardless of whether the stitch no., speed, counter, locus or program is being displayed in the 4-digit display. (Refer to the Service Manual for details on programs.) <p style="text-align: right;">1353D</p>
<p>2</p>	 <p>Any indicator illuminates</p> <p>-0.05 +0.05</p>	<p>Press the - ▽ /+ △ keys to change the setting value.</p> <ul style="list-style-type: none"> When the + △ key is pressed, the setting value increases by 0.05. When the - ▽ key is pressed, the setting value decreases by 0.05. <p>NOTE: The setting range is from 0.05 to 5.00.</p> <p style="text-align: right;">1354D</p>
<p>3</p>	 <p>ON</p> <p>-0.05 +0.05</p>	<p>The backtack pitch can only be set when the stitch number and sewing speed indicators are illuminated. (Refer to "4-3-2. Backtack sewing speed setting method".)</p> <p style="text-align: right;">1461D</p>







4-2. Switching the 4-digit display

- The 4-digit display can be changed to one of the following four statuses each time the  key is pressed.
Stitch no. display or no display -> Speed display -> Counter display -> Locus display
- When the speed display or counter display appears, you can press the  key to switch to another display.

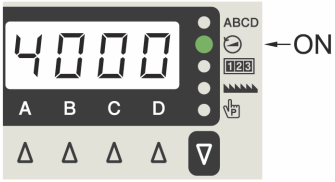

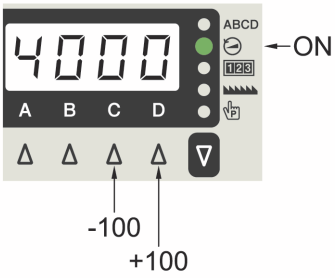



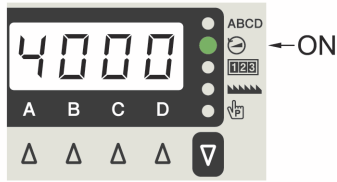

Display mode					4-digit display
Stitch number display	ON				ABCD stitch number display
Sewing speed display		ON			Maximum sewing speed setting value
	ON	ON			Backtack sewing speed setting value
Counter display			ON		Lower thread counter value
			Flashing		Lower thread counter warning enabled
		ON	ON		Production counter value
	ON		ON		Needle replacement counter value
	Flashing		Flashing		Needle replacement counter warning enabled
Locus display				ON	Locus setting value

4-3. Setting the sewing speed

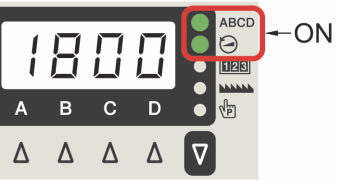
4-3-1. Setting the maximum sewing speed

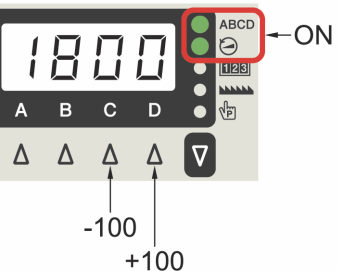
1		<p>Press the  key so that the  indicator illuminates.</p> <ul style="list-style-type: none"> • The maximum sewing speed setting value will appear in the 4-digit display. 	1355D
2		<p>Press the C  /D  keys to change the setting value.</p> <ul style="list-style-type: none"> • When the D  key is pressed, the setting increases by 100. • When the C  key is pressed, the setting decreases by 100. <p>NOTE: The setting range is from 220 to 4000 sti/min.</p>	1356D

4-3-2. Backtack sewing speed setting method

<p>1</p>		<p>Press the  key so that the  indicator illuminates.</p> <ul style="list-style-type: none"> The maximum sewing speed setting value will appear in the 4-digit display. <p style="text-align: right;">1355D</p>
<p>2</p>		<p>Press the  key.</p> <ul style="list-style-type: none"> The ABCD indicator will illuminate and the setting value for the backtack sewing speed will appear in the 4-digit display. <p>NOTE: If you press the  key once more, the ABCD indicator will switch off and the display will return to the maximum sewing speed setting value.</p> <p style="text-align: right;">1357D</p>
<p>3</p>		<p>Press the C  /D  keys to change the setting value.</p> <ul style="list-style-type: none"> When the D  key is pressed, the setting increases by 100. When the C  key is pressed, the setting decreases by 100. <p>NOTE: The setting range is from 220 to 3000 sti/min.</p> <p style="text-align: right;">1358D</p>







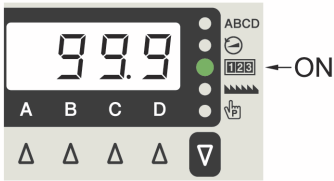

4-4. Setting the counters

The lower thread counter, production counter and needle replacement counter are available. The three counters can be operated at the same time.

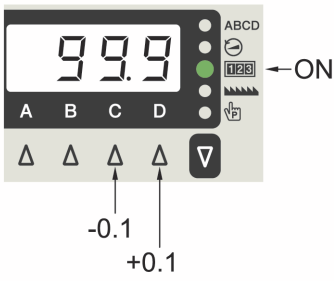
4-4-1. Lower thread counter

The lower thread counter can be used to let you know approximately how much lower thread is remaining.
 * This function is only displayed when "A09: Lower thread counter operation" is set to "ON".
 Refer to "4-6-7. Lower thread counter operation".



<Setting the lower thread counter initial value>

1	 <p>Press the  key so that the  indicator illuminates.</p> <ul style="list-style-type: none"> The lower thread counter value will appear in the 4-digit display. 	1359D
2	 <p>Press the A  key for 2 seconds or more, and then press the C  or D  key to set the initial value.</p> <ul style="list-style-type: none"> When the D  key is pressed, the setting value increases by 0.1. When the C  key is pressed, the setting value decreases by 0.1. <p>NOTE:</p> <ul style="list-style-type: none"> The setting range is from 0.1 to 99.9. 	1360D

<Lower thread counter operation>

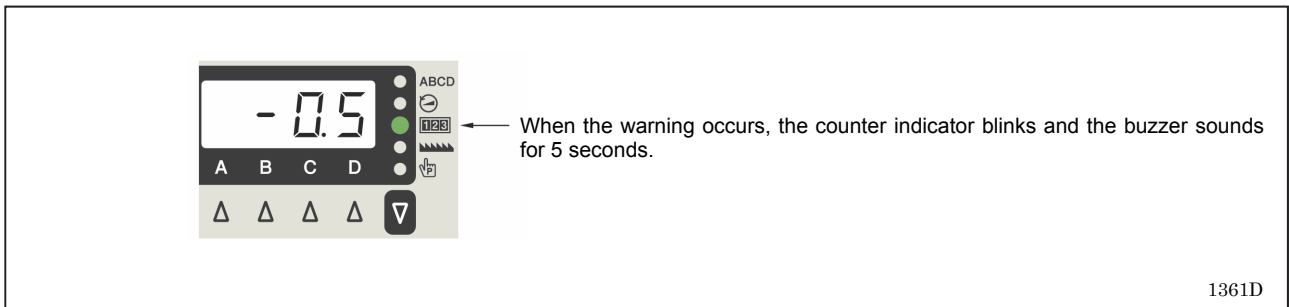
- The lower thread counter can be used to let you know approximately how much lower thread is remaining.
 * The lower thread counter should be used as a guide only.
- The value displayed by the lower thread counter display is reduced by 0.1 from the initial setting value each time the number of stitches x sewing pitch reaches 0.1 m, and a warning is given when the counter goes below 0.











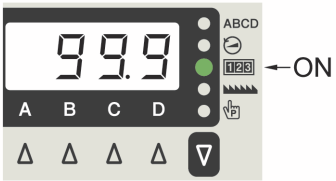

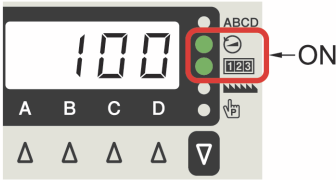
- Sewing will be possible even after the treadle is returned to the neutral position and the sewing machine stops. However, after the treadle has been depressed backward and thread trimming has been carried out, sewing using the treadle will no longer be possible.
 If the treadle is depressed at this time, "Ent" will appear in the display. When the treadle is returned to the neutral position, the display will return to the current counter display.
- If the  key is pressed during a warning, the  indicator will change to illuminated and sewing can then be carried out using the treadle.
 If the A  key is pressed again for 2 seconds or more, the counter display will return to the initial value and counting from the initial value will be possible.

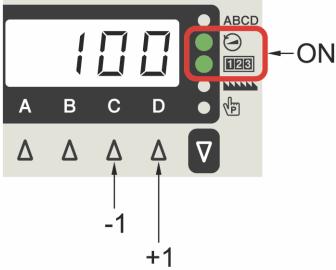
4. USING THE OPERATION PANEL (ADVANCED OPERATIONS)









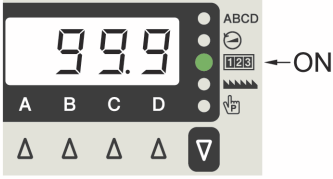

4-4-2. Production counter

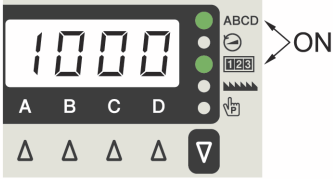
The production counter can be used to let you know how many items have been sewn.

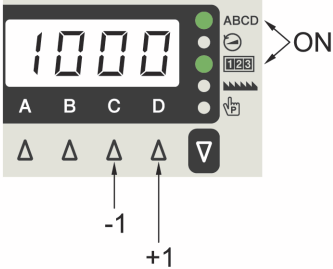
1	 <p>The image shows the operation panel with a digital display showing '999'. To the right of the display, there are four indicator lights labeled A, B, C, and D. The '123' indicator light is illuminated and highlighted with a red box. An arrow points to this indicator with the text '← ON'. Below the display are four arrow keys labeled A, B, C, and D, and a central downward arrow key.</p>	<p>Press the  key so that the  indicator illuminates.</p> <ul style="list-style-type: none">• The lower thread counter value will appear in the 4-digit display. <p style="text-align: right;">1359D</p>
2	 <p>The image shows the operation panel with a digital display showing '100'. The '123' indicator light is illuminated and highlighted with a red box. An arrow points to this indicator with the text '← ON'. Below the display are four arrow keys labeled A, B, C, and D, and a central downward arrow key.</p>	<p>When the  key is pressed once, the production counter will be displayed.</p> <ul style="list-style-type: none">• The production counter value will appear in the 4-digit display. <p style="text-align: right;">1362D</p>
3	<p>After the thread trimming operation is complete, the counter will be incremented.</p> <p>NOTE: The counter is incremented when the treadle is depressed backward even if thread trimming is set to disabled.</p>	
4	 <p>The image shows the operation panel with a digital display showing '100'. The '123' indicator light is illuminated and highlighted with a red box. An arrow points to this indicator with the text '← ON'. Below the display are four arrow keys labeled A, B, C, and D, and a central downward arrow key. Arrows point to the C and D keys with labels '-1' and '+1' respectively.</p>	<p>When the production counter is displayed, you can press the C  or D  key to adjust the counter value (0 to 9999).</p> <ul style="list-style-type: none">• When the D  key is pressed, the counter value increases by 1.• When the C  key is pressed, the counter value decreases by 1.• If you press the A  key for 2 seconds or more, the counter value can be reset to "0". <p style="text-align: right;">1363D</p>

4-4-3. Needle replacement counter



<Setting the needle replacement counter initial value>

<p>1</p>		<p>Press the  key so that the  indicator illuminates.</p> <ul style="list-style-type: none"> • The lower thread counter value will appear in the 4-digit display. <p style="text-align: right;">1359D</p>
<p>2</p>		<p>When the  key is pressed two or more times, the needle replacement counter display will appear.</p> <ul style="list-style-type: none"> • The needle replacement counter value will appear in the 4-digit display. <p style="text-align: right;">1364D</p>
<p>3</p>		<p>Press the A  key for 2 seconds or more, and then press the C  or D  key to set the initial value.</p> <ul style="list-style-type: none"> • When the D  key is pressed, the setting value increases by 1. • When the C  key is pressed, the setting value decreases by 1. <p>NOTE:</p> <ul style="list-style-type: none"> • The setting range is from 0 to 9999. • If an initial value of "0" is set, the needle replacement counter will not operate. <p style="text-align: right;">1365D</p>



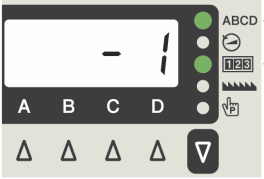

<Needle replacement counter operation>

- The needle replacement counter is reduced by 1 from the initial setting value each time the sewing machine sews 100 stitches, and a warning is given when the counter goes below "0".









When the warning occurs, the  indicator and the  indicator flash, and the buzzer sounds for 5 seconds.

1366D

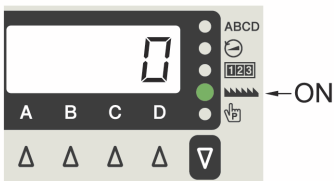

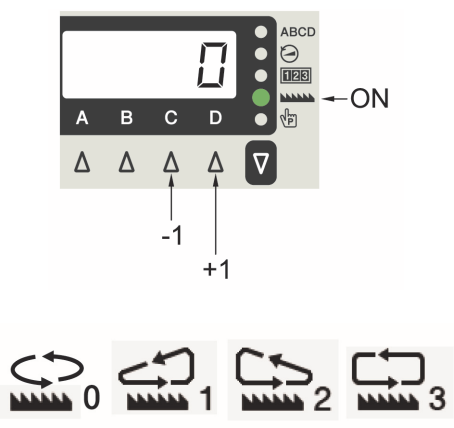
- Sewing will be possible even after the treadle is returned to the neutral position and the sewing machine stops. However, after the treadle has been depressed backward and thread trimming has been carried out, sewing using the treadle will no longer be possible.
If the treadle is depressed at this time, "Ent" will appear in the display. When the treadle is returned to the neutral position, the display will return to the current counter display.
- If the  key is pressed during a warning, the  indicator and the  indicator will change to illuminated and sewing can then be carried out using the treadle.
If the A  key is pressed again for 2 seconds or more, the counter display will return to the initial value and counting from the initial value will be possible.



4-5. Sewing locus setting method

Sewing locus setting method

1		<p>Press the  key so that the  indicator illuminates.</p> <ul style="list-style-type: none"> • The sewing locus setting value will appear in the 4-digit display. 	1367D
2		<p>Press the C  /D  keys to change the setting value.</p> <ul style="list-style-type: none"> • When the D  key is pressed, the setting value increases by 1. • When the C  key is pressed, the setting value decreases by 1. <p>NOTE: The setting range is from 0 to 3. 0: The feed dog moves along the standard locus. 1: The feed dog moves along special locus 1. 2: The feed dog moves along special locus 2. 3: The feed dog moves along special locus 3.</p>	1368D 1478D

4-6. Setting basic functions









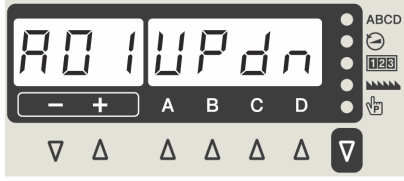

If you hold down the  key and press the  key while the stitch no., speed, counter, locus or program is displayed, the following items can be set.

Setting item	3-digit display	4-digit display	Initial value	Reference item
Needle up/down	『A01』	『UPdn』	Needle down stop	Refer to "4-6-1".
Thread trimming disable	『A02』	『trdi』	None (Thread trimming operation enabled)	Press the  key to make the setting.
Thread wiping	『A03』	『WiP』	Specifications with thread wiper: Enabled Specifications without thread wiper: Disabled	Refer to "4-6-3".
Correction sewing	『A04』	『Corr』	None	
AUTO	『A05』	『AUto』	None	Refer to the Service Manual.
Auto thread trimming	『A06』	『AtiM』	None	Refer to the Service Manual.
Slow start	『A07』	『SLoW』	None	Press the  key to make the setting.
Illumination LED brightness	『A08』	『LEd』	Level 5	
Lower thread counter operation	『A09』	『UtCt』	None	
Prev. thread away	『A11』	『PtA』	None	
Prev. thread away pitch at 1st stitch	『A12』	『PtP1』	3.30	
Prev. thread away pitch at 2nd stitch	『A13』	『PtP2』	2.20	
Short trailing thread	『A21』	『ttSH』	P specifications: Enabled S specifications: Disabled	
Short trailing thread sewing speed at 1st stitch	『A22』	『ttr1』	1400	
Short trailing thread sewing speed at 2nd stitch	『A23』	『ttr2』	400	
Short trailing thread pitch at 1st stitch	『A24』	『ttP1』	0.70	
Short trailing thread pitch at 2nd stitch	『A25』	『ttP2』	0.70	
Short trailing thread pitch at 3rd stitch	『A26』	『ttP3』	1.20	
Short trailing thread direction	『A27』	『ttCS』	Fw: Forward direction	
Standard switch correction sewing function	『A31』	『HSCF』	1: Single correction sewing	
Function other than standard switch correction sewing	『A32』	『HSoF』	1: Reverse	
2nd pitch ratio	『A33』	『2Pt』	50	
Correction 2nd pitch ratio	『A34』	『A2Pt』	50	
Option switch correction sewing function	『A35』	『oSCF』	1: Single correction sewing	
Function other than option switch correction sewing	『A36』	『oSoF』	1: Reverse	

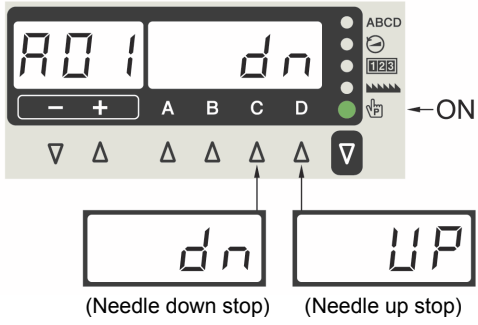
4. USING THE OPERATION PANEL (ADVANCED OPERATIONS)













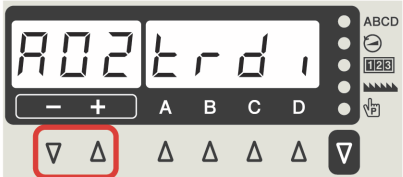

4-6-1. Changing the needle stop position

This sets whether the needle bar stops in the needle up stop position or the needle down stop position when the treadle is returned to the neutral position and sewing stops.

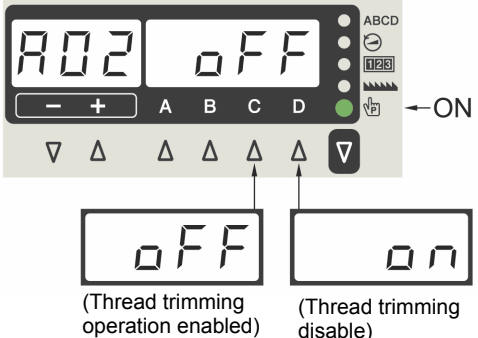
<p>1</p>		<p>In sewing standby mode, press the  key while holding down the  key to switch to function setting mode.</p> <ul style="list-style-type: none"> • "A01 UPdn" will be displayed.
<p>2</p>	<p>Displaying the needle up stop and needle down stop setting values</p>	<ul style="list-style-type: none"> • When the  key is pressed, the setting value is displayed.
<p>3</p>		<ul style="list-style-type: none"> • When the D  key is pressed, the "UP" display will appear. • When the C  key is pressed, the "dn" display will appear. • When the  key is pressed, the initial value will be reset. <p>NOTE: If the  key is pressed once more, the  indicator will switch off and the display will return to the setting item.</p>
<p>4</p>	<p>Press the  key.</p>	<p>Setting mode will be exited and normal operation will be possible.</p>

4-6-2. Thread trimming disable











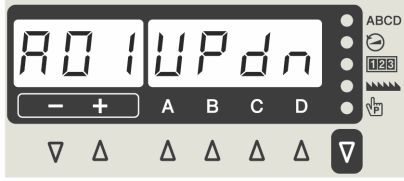

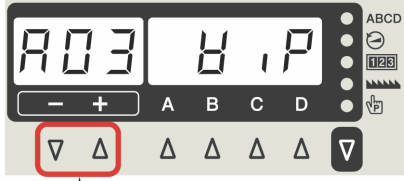

If thread trimming is set to be disabled, thread trimming will not be carried out even when the pedal is depressed backward.

<p>1</p>		<p>In sewing standby mode, press the  key while holding down the  key to switch to function setting mode.</p> <ul style="list-style-type: none"> • "A01 UPdn" will be displayed.
<p>2</p>	<p>Selecting "A02 Trdi" (thread trimming disable)</p>  <p>Press either.</p>	<p>Press the -  / +  keys to select "A02 Trdi".</p> <ul style="list-style-type: none"> • When the +  key is pressed, the next setting is displayed. • When the -  key is pressed, the previous setting is displayed.
<p>3</p>	<p>Displaying the thread trimming disabled setting value</p>	<ul style="list-style-type: none"> • When the  key is pressed, the setting value is displayed.
<p>4</p>	<p>Setting thread trimming to disabled or enabled</p>  <p>(Thread trimming operation enabled) (Thread trimming disable)</p>	<ul style="list-style-type: none"> • When the D  key is pressed, the "on" display will appear. • When the C  key is pressed, the "oFF" display will appear. • When the  key is pressed, the initial value will be reset. <p>NOTE: If the  key is pressed once more, the  indicator will switch off and the display will return to the setting item.</p>
<p>5</p>	<p>Press the  key.</p>	<p>Setting mode will be exited and normal operation will be possible.</p>

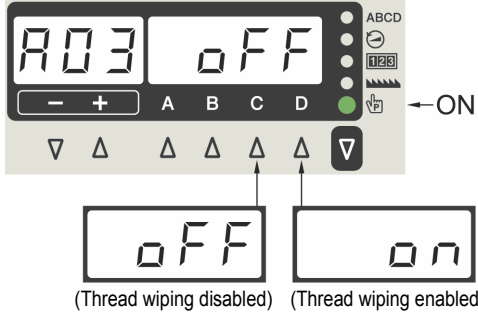
4. USING THE OPERATION PANEL (ADVANCED OPERATIONS)

4-6-3. Thread wiping













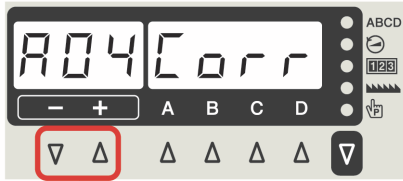

You can set whether thread wiper operation is enabled or disabled.

<p>1</p>		<p>In sewing standby mode, press the  key while holding down the  key to switch to function setting mode.</p> <ul style="list-style-type: none"> • "A01 UPdn" will be displayed.
<p>2</p>	<p>Selecting "A03 Wip" (thread wiping)</p>  <p>Press either.</p>	<p>Press the -  / +  keys to select "A03 Wip".</p> <ul style="list-style-type: none"> • When the +  key is pressed, the next setting is displayed. • When the -  key is pressed, the previous setting is displayed.
<p>3</p>	<p>Displaying the thread wiping setting value</p>	<ul style="list-style-type: none"> • When the  key is pressed, the setting value is displayed.
<p>4</p>	<p>Setting thread wiping</p> 	<ul style="list-style-type: none"> • When the D  key is pressed, the "on" display will appear. • When the C  key is pressed, the "oFF" display will appear. • When the  key is pressed, the initial value will be reset. <p>NOTE: If the  key is pressed once more, the  indicator will switch off and the display will return to the setting item.</p>
<p>5</p>	<p>Press the  key.</p>	<p>Setting mode will be exited and normal operation will be possible.</p>

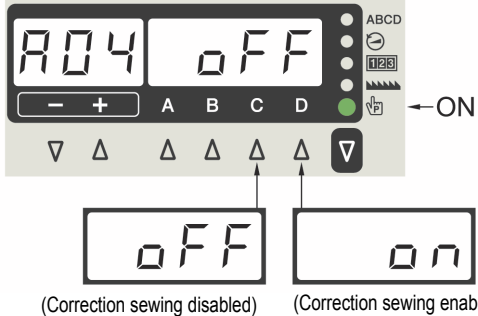
4-6-4. Correction sewing

When correction sewing is enabled, if the hand switch is pressed while sewing is stopped before thread trimming, one stitch will be sewn and sewing will then stop.











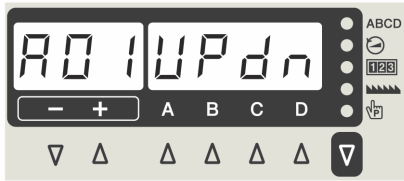



* The function can be changed. (Refer to "4-11. Hand switch".)

<p>1</p>		<p>In sewing standby mode, press the  key while holding down the  key to switch to function setting mode.</p> <ul style="list-style-type: none"> • "A01 UPdn" will be displayed.
<p>2</p>	<p>Selecting "A04 Corr" (correction sewing)</p>  <p>Press either.</p>	<p>Press the -  or +  key to select "A04 Corr".</p> <ul style="list-style-type: none"> • When the +  key is pressed, the next setting is displayed. • When the -  key is pressed, the previous setting is displayed.
<p>3</p>	<p>Displaying the correction sewing setting value</p>	<ul style="list-style-type: none"> • When the  key is pressed, the setting value is displayed.
<p>4</p>	<p>Setting correction sewing</p> 	<ul style="list-style-type: none"> • When the D  key is pressed, the "on" display will appear. • When the C  key is pressed, the "oFF" display will appear. • When the  key is pressed, the initial value will be reset. <p>NOTE: If the  key is pressed once more, the  indicator will switch off and the display will return to the setting item.</p>
<p>5</p>	<p>Press the  key.</p>	<p>Setting mode will be exited and normal operation will be possible.</p>

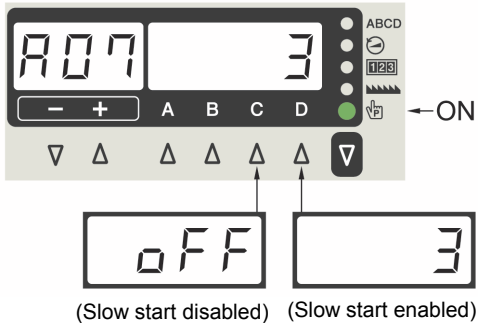
4. USING THE OPERATION PANEL (ADVANCED OPERATIONS)











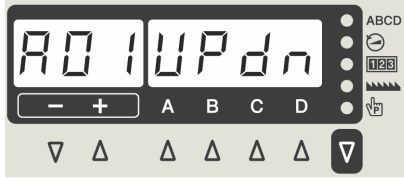



4-6-5. Slow start

If slow start is enabled, occurrences of the thread pulling out can be reduced.

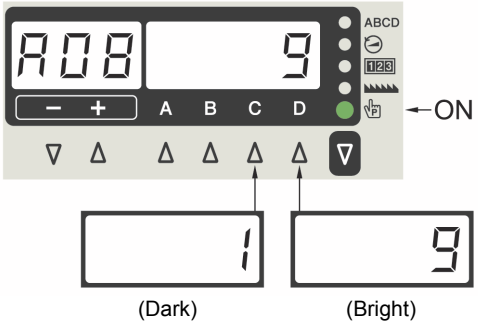
<p>1</p>		<p>In sewing standby mode, press the  key while holding down the  key to switch to function setting mode.</p> <ul style="list-style-type: none"> • "A01 UPdn" will be displayed.
<p>2</p>	<p>Selecting "A07 SLOW" (slow start)</p>  <p>Press either.</p>	<p>Press the -  or +  key to select "A07 SLOW".</p> <ul style="list-style-type: none"> • When the +  key is pressed, the next setting is displayed. • When the -  key is pressed, the previous setting is displayed.
<p>3</p>	<p>Displaying the slow start setting value</p>	<ul style="list-style-type: none"> • When the  key is pressed, the setting value is displayed.
<p>4</p>	<p>Setting slow start</p>  <p>(Slow start disabled) (Slow start enabled)</p>	<ul style="list-style-type: none"> • When the D  key is pressed, the setting value increases in the order "oFF", "1", "2", "3". • When the C  key is pressed, the setting value decreases in the order "3", "2", "1", "oFF". • When the  key is pressed, the initial value will be reset. • Sewing speed for first 4 stitches when slow start is enabled <ul style="list-style-type: none"> 1: 400, 400, 400, 4000* 2: 400, 400, 4000*, 4000* 3: 700, 700, 4000*, 4000* 4: Set using memory switch Nos. 403 to 406. * If the maximum sewing speed is set to 4,000 sti/min <p>NOTE: If the  key is pressed once more, the  indicator will switch off and the display will return to the setting item.</p>
<p>5</p>	<p>Press the  key.</p>	<p>Setting mode will be exited and normal operation will be possible.</p>

4-6-6. Setting the illumination LED light











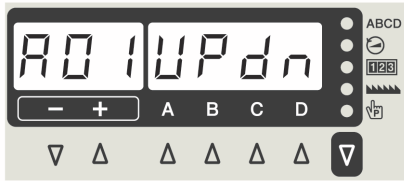



You can set the brightness of the illumination LED light.

<p>1</p>		<p>In sewing standby mode, press the  key while holding down the  key to switch to function setting mode.</p> <ul style="list-style-type: none"> • "A01 UPdn" will be displayed.
<p>2</p>	<p>Selecting "A08 LED" (illumination LED light)</p>  <p>Press either.</p>	<p>Press the -  or +  key to select "A08 LED".</p> <ul style="list-style-type: none"> • When the +  key is pressed, the next setting is displayed. • When the -  key is pressed, the previous setting is displayed.
<p>3</p>	<p>Displaying the illumination LED light setting value</p>	<ul style="list-style-type: none"> • When the  key is pressed, the setting value is displayed.
<p>4</p>	<p>Setting the illumination LED light</p> 	<ul style="list-style-type: none"> • When the D  key is pressed, the setting value increases from "1" through to "9". • When the C  key is pressed, the setting value decreases from "9" through to "1". • When the  key is pressed, the initial value will be reset. <p>NOTE: If the  key is pressed once more, the  indicator will switch off and the display will return to the setting item.</p>
<p>5</p>	<p>Press the  key.</p>	<p>Setting mode will be exited and normal operation will be possible.</p>

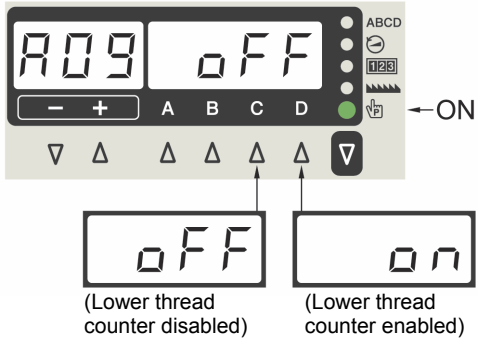
4. USING THE OPERATION PANEL (ADVANCED OPERATIONS)











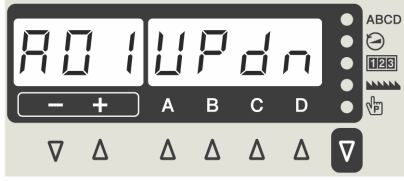

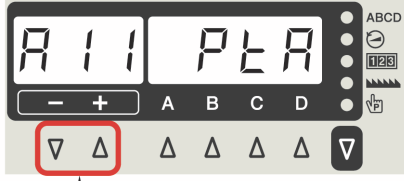

4-6-7. Setting lower thread counter operation

The lower thread counter function can be set to enabled or disabled.

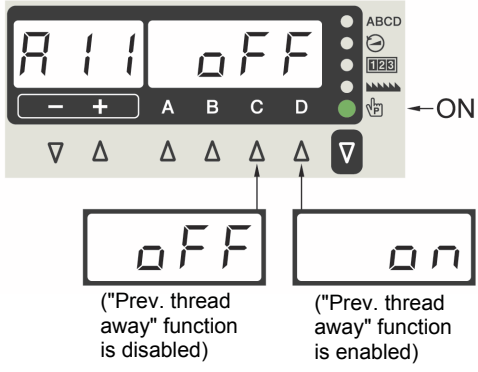
<p>1</p>		<p>In sewing standby mode, press the  key while holding down the  key to switch to function setting mode.</p> <ul style="list-style-type: none"> • "A01 UPdn" will be displayed.
<p>2</p>	<p>Selecting "A09 UtCt" (lower thread counter operation)</p>  <p>Press either.</p>	<p>Press the -  or +  key to select "A09 UtCt".</p> <ul style="list-style-type: none"> • When the +  key is pressed, the next setting is displayed. • When the -  key is pressed, the previous setting is displayed.
<p>3</p>	<p>Displaying the lower thread counter operation setting value</p>	<ul style="list-style-type: none"> • When the  key is pressed, the setting value is displayed.
<p>4</p>	<p>Setting lower thread counter operation</p> 	<ul style="list-style-type: none"> • When the D  key is pressed, the "on" display will appear. • When the C  key is pressed, the "oFF" display will appear. • When the  key is pressed, the initial value will be reset. <p>NOTE: If the  key is pressed once more, the  indicator will switch off and the display will return to the setting item.</p>
<p>5</p>	<p>Press the  key.</p>	<p>Setting mode will be exited and normal operation will be possible.</p>

4-6-8. Prev. thread away











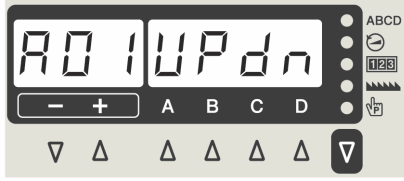

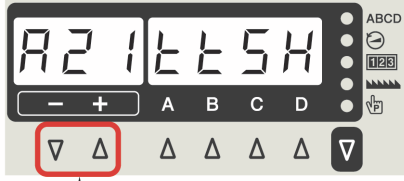

When "Prev. thread away" is enabled, the pitch at the sewing start can be increased in order to reduce cases of the thread pulling out.

<p>1</p>		<p>In sewing standby mode, press the  key while holding down the  key to switch to function setting mode.</p> <ul style="list-style-type: none"> • "A01 UPdn" will be displayed. <p style="text-align: right;">1369D</p>
<p>2</p>	<p>Selecting "A11 PtA" (prev. thread away)</p>  <p>Press either.</p>	<p>Press the -  or +  key to select "A11 PtA".</p> <ul style="list-style-type: none"> • When the +  key is pressed, the next setting is displayed. • When the -  key is pressed, the previous setting is displayed. <p style="text-align: right;">1381D</p>
<p>3</p>	<p>Displaying the "Prev. thread away" setting value</p>	<ul style="list-style-type: none"> • When the  key is pressed, the setting value is displayed.
<p>4</p>	<p>Setting "Prev. thread away"</p> 	<ul style="list-style-type: none"> • When the D  key is pressed, the "on" display will appear. • When the C  key is pressed, the "oFF" display will appear. • When the  key is pressed, the initial value will be reset. <p>NOTE: If the  key is pressed once more, the  indicator will switch off and the display will return to the setting item.</p> <p style="text-align: right;">1382D</p>
<p>5</p>	<p>Press the  key.</p>	<p>Setting mode will be exited and normal operation will be possible.</p>

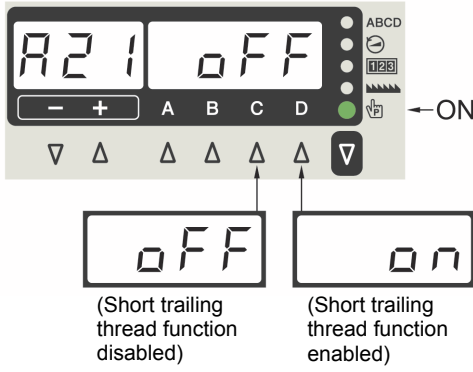
4. USING THE OPERATION PANEL (ADVANCED OPERATIONS)















4-6-9. Short trailing thread

When short trailing thread is enabled, the trailing length of the thread can be made shorter.

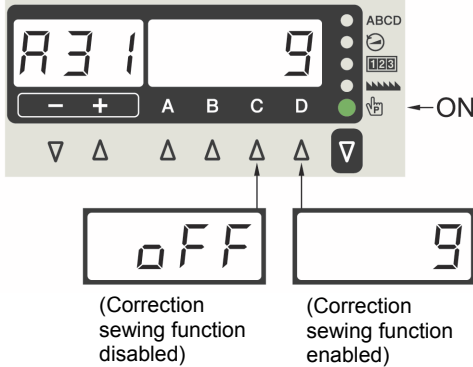
<p>1</p>		<p>In sewing standby mode, press the  key while holding down the  key to switch to function setting mode.</p> <ul style="list-style-type: none"> • "A01 UPdn" will be displayed.
<p>2</p>	<p>Selecting "A21 ttSH" (short trailing thread)</p>  <p>Press either.</p>	<p>Press the -  or +  key to select "A21 ttSH".</p> <ul style="list-style-type: none"> • When the +  key is pressed, the next setting is displayed. • When the -  key is pressed, the previous setting is displayed.
<p>3</p>	<p>Displaying the short trailing thread setting value</p>	<ul style="list-style-type: none"> • When the  key is pressed, the setting value is displayed.
<p>4</p>	<p>Setting short trailing thread</p> 	<ul style="list-style-type: none"> • When the D  key is pressed, the "on" display will appear. • When the C  key is pressed, the "oFF" display will appear. • When the  key is pressed, the initial value will be reset. <p>NOTE: If the  key is pressed once more, the  indicator will switch off and the display will return to the setting item.</p>
<p>5</p>	<p>Press the  key.</p>	<p>Setting mode will be exited and normal operation will be possible.</p>















4-6-10. Correction sewing function (1)

When the correction sewing function (A04) is enabled, the hand switch correction sewing function can be set. For details on the functions which can be set, refer to "4-11. Hand switch" for the settings when the hand switch is set as a correction sewing switch.

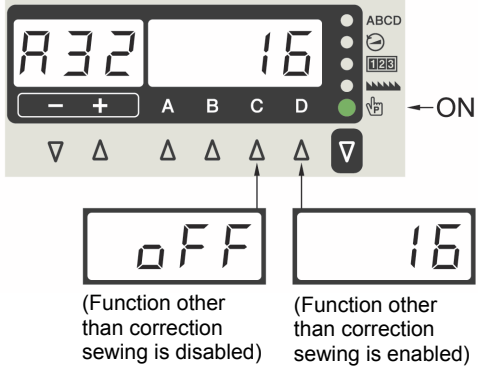









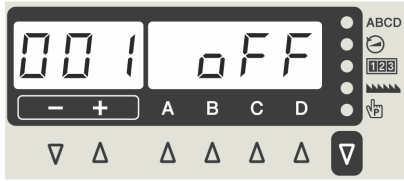

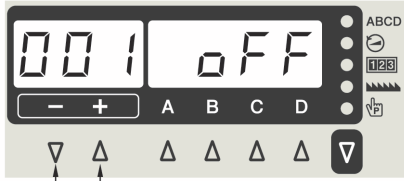



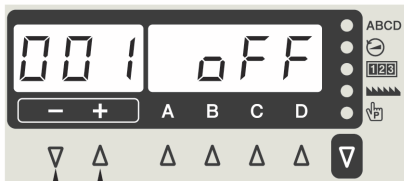



<p>1</p>		<p>In sewing standby mode, press the  key while holding down the  key to switch to function setting mode.</p> <ul style="list-style-type: none"> • "A01 UPdn" will be displayed.
<p>2</p>	<p>Selecting "A31 HSCF" (correction sewing function)</p>  <p>Press either.</p>	<p>Press the -  or +  key to select "A31 HSCF".</p> <ul style="list-style-type: none"> • When the +  key is pressed, the next setting is displayed. • When the -  key is pressed, the previous setting is displayed.
<p>3</p>	<p>Displaying the correction sewing function setting value</p>	<ul style="list-style-type: none"> • When the  key is pressed, the setting value is displayed.
<p>4</p>	<p>Setting the correction sewing function</p> 	<ul style="list-style-type: none"> • When the D  key is pressed, the setting value increases from "oFF" to "1" through to "9". • When the C  key is pressed, the setting value decreases from "9" through to "1" to "oFF". • When the  key is pressed, the initial value will be reset. <p>NOTE: If the  key is pressed once more, the  indicator will switch off and the display will return to the setting item.</p>
<p>5</p>	<p>Press the  key.</p>	<p>Setting mode will be exited and normal operation will be possible.</p>

4-6-11. Correction sewing function (2)

When the correction sewing function (A04) is disabled, the hand switch functions other than correction sewing can be set. For details on the functions which can be set, refer to "4-11. Hand switch" for the settings when the hand switch is set to other than a correction sewing switch.

<p>1</p>		<p>In sewing standby mode, press the  key while holding down the  key to switch to function setting mode.</p> <ul style="list-style-type: none"> • "A01 UPdn" will be displayed.
<p>2</p>	<p>Selecting "A32 HSoF" (correction sewing function)</p>  <p>Press either.</p>	<p>Press the -  or +  keys to select "A32 HSoF".</p> <ul style="list-style-type: none"> • When the +  key is pressed, the next setting is displayed. • When the -  key is pressed, the previous setting is displayed.
<p>3</p>	<p>Displaying the setting value for a function other than correction sewing</p>	<ul style="list-style-type: none"> • When the  key is pressed, the setting value is displayed.
<p>4</p>	<p>Setting a function other than correction sewing</p> 	<ul style="list-style-type: none"> • When the D  key is pressed, the setting value increases from "oFF" to "1" through to "16". • When the C  key is pressed, the setting value decreases from "16" through to "1" to "oFF". • When the  key is pressed, the initial value will be reset. <p>NOTE: If the  key is pressed once more, the  indicator will switch off and the display will return to the setting item.</p>
<p>5</p>	<p>Press the  key.</p>	<p>Setting mode will be exited and normal operation will be possible.</p>

4-7. Memory switch setting method

<p>1</p>		<p>In sewing standby mode, press the  key while holding down the  key to switch to memory switch setting mode.</p> <ul style="list-style-type: none"> • "001" or the memory switch number which was set previously will be displayed.
<p>2</p>	<p>Selecting a memory switch number</p> 	<p>Press the -  / +  keys to select the number for the memory switch to be set.</p> <ul style="list-style-type: none"> • When the +  key is pressed, the next setting is displayed. • When the -  key is pressed, the previous setting is displayed.
<p>3</p>	<p>Selecting a memory switch number which is different from the initial value</p> 	<p>While pressing the  key, press the -  / +  keys to select the number for the memory switch which is different from the initial value.</p> <ul style="list-style-type: none"> • When the +  key is pressed while holding down the  key, the next setting item is displayed. • When the -  key is pressed while holding down the  key, the previous setting item is displayed.
<p>4</p>	<p>Changing the memory switch setting value</p> 	<ul style="list-style-type: none"> • When the D  key is pressed, the setting value increases or it turns ON. • When the C  key is pressed, the setting value decreases or it turns OFF. • When the  key is pressed the initial value will be set.
<p>5</p>	<p>Confirming the memory switch setting value</p>	<ul style="list-style-type: none"> • When the  key is pressed, the setting value is confirmed.
<p>6</p>	<p>Press the  key.</p>	<p>Setting mode will be exited and normal operation will be possible.</p>

4-8. List of memory switch settings

Presser foot lifter and treadle settings (001 to 099)

No.	Setting range	Initial value	Setting units	Setting details
001	ON/OFF	ON : Other than Europe and America / OFF : Europe and America	—	Presser foot condition when treadle is returned to neutral position after thread trimming ON: Presser foot is raised OFF: Presser foot is not raised (*) The presser foot lifts when No.851 is set to "OFF".
002	ON/OFF	OFF	—	Presser foot condition when operation stops at the neutral treadle position ON: Presser foot is raised OFF: Presser foot is not raised
003	ON/OFF	ON	—	Presser foot raising after treadle is returned to neutral position to stop sewing and is then depressed backward to the 1st step ON : Enabled OFF: Disabled
004	ON/OFF	ON	—	Operation when treadle is depressed backward ON: Thread trimming and end backtack sewing operations are enabled (However, if thread trimming operation is locked, needle up operations will be carried out without thread trimming.) OFF: Thread trimming and end backtack sewing operations are disabled (presser foot lifts when the treadle is depressed backward)
010	ON/OFF	OFF	—	Alternating operation of standing operation pedal and treadle (*) For simultaneous operation which includes operation of the presser foot lifter pedal, operation of the standing operation pedal takes priority. ON: Treadle operation is still enabled after standing operation pedal has been used (alternating operation is possible) OFF: Treadle operation is disabled after standing operation pedal has been used
011	0 - 1	0	1	Operation when standing up variable speed pedal is ON 0: Sewing speed corresponds to treadle depression amount 1: Operates at the sewing speed for the main section (constant speed)
012	0 - 500 (ms)	80 (ms)	10 (ms)	Delay time from standing pedal turning on until motor starts operating
013	ON/OFF	ON	—	Stop function using the work clamp pedal during standing operation when the AUTO function is on ON: Sewing is interrupted when presser foot lifter pedal turns on (pause operation) (*) This function is disabled during start backtacking. OFF: No operation
014	ON/OFF	ON	—	Pause function using the high-speed pedal during standing operation when the AUTO function is on ON: When the high-speed pedal turns on, sewing is momentarily stopped, and it is resumed when the pedal turns off. (*) This function is disabled when No. 010 is set to "ON". (*) This function is disabled during start backtacking. OFF: No operation
015	ON/OFF	ON	—	Presser foot lifting operation from thread trimming pedal after thread is trimmed during standing operation ON: Presser foot can be raised and lowered (*) If No.051 is set to "ON", thread trimming pedal operation is disabled after the presser foot lifter pedal has been operated during standing operation. OFF: No operation (only possible using presser foot lifter pedal)

4. USING THE OPERATION PANEL (ADVANCED OPERATIONS)

Sewing machine motor settings (100 to 199)

No.	Setting range	Initial value	Setting units	Setting details
100	OFF, 1 - 3	OFF	1	Pedal response switching settings immediately after sewing has started OFF: No switching 1: Slow start only when sewing starts after thread trimming 2: Slow start only when sewing starts after sewing has been paused 3: Slow start always when sewing starts
101	1 - 5	1	1	Pedal response immediately after sewing has started (The larger the value, the slower the speed when sewing starts.) * When No. 100 is set to "OFF", nothing is displayed. (The setting is disabled.)
102	-20 - 10 (Degrees)	0 (Degrees)	1 (Degrees)	Needle up stop position correction value Needle up stop position = Needle up stop position initial setting value + Upper shaft reference position correction value + Needle up stop position correction value
103	-10 - 10 (Degrees)	0 (Degrees)	1 (Degrees)	Needle down stop position correction value Needle down stop position = Needle down stop position initial setting value + Upper shaft reference position correction value + Needle down stop position correction value

Feed motor settings (200 to 299)

No.	Setting range	Initial value	Setting units	Setting details
200	50 - 150 (%)	100 (%)	1 (%)	Forward direction pitch correction ratio
201	50 - 150 (%)	100 (%)	1 (%)	Reverse direction pitch length correction ratio
202	50 - 150 (%)	100 (%)	1 (%)	Start backtacking B pitch correction ratio
203	50 - 150 (%)	100 (%)	1 (%)	End backtacking C pitch correction ratio
204	50 - 150 (%)	100 (%)	1 (%)	Special locus 1 pitch correction ratio
205	50 - 150 (%)	-3: 100 -5: 97 (%)	1 (%)	Special locus 2 pitch correction ratio
206	50 - 150 (%)	92 (%)	1 (%)	Special locus 3 pitch correction ratio

Panel operation settings (300 to 399)

No.	Setting range	Initial value	Setting units	Setting details
300	1 - 3	1	1	Operation after lower thread counter warning 1: Sewing can continue until thread trimming is carried out 2: After sewing stops, it cannot continue until the [ENTER] key is pressed and the warning is canceled. 3: If the counter goes below "0", sewing stops, and the warning operation for a setting of "2" occurs.
312	0 - 2	0	1	Feed pitch display mode 0: mm display 1: stitch per inch display 2: stitch per 30 mm display

4. USING THE OPERATION PANEL (ADVANCED OPERATIONS)

Sewing program settings (400 to 499)

No.	Setting range	Initial value	Setting units	Setting details
400	ON/OFF	OFF	—	Stopping while start backtacking is in progress, and speed during start backtacking ON: When the treadle is returned to the neutral position, start backtacking can be stopped before it is finished, and the speed during start backtacking becomes the speed corresponding to the treadle depression amount (low speed - start backtacking speed) OFF: When the treadle is returned to the neutral position, start backtacking ends, sewing stops and the sewing speed becomes the start backtacking speed (constant)
401	ON/OFF	ON	—	Feed direction when sewing machine motor is stopped immediately after start backtacking is complete OFF: Sewing machine motor stops after start backtacking is complete (*): If No. 400 is set to "OFF", operation occurs when the treadle is depressed slightly. ON: After start backtack sewing, the feed moves forward, then the sewing machine motor stops. 
403	300 - 4000 (sti/min)	4000 (sti/min)	100 (sti/min)	1st stitch sewing speed for slow start
404	300 - 4000 (sti/min)	4000 (sti/min)	100 (sti/min)	2nd stitch sewing speed for slow start
405	300 - 4000 (sti/min)	4000 (sti/min)	100 (sti/min)	3rd stitch sewing speed for slow start
406	300 - 4000 (sti/min)	4000 (sti/min)	100 (sti/min)	4th stitch sewing speed for slow start
408	2 - 6	2	1	Repeat pattern when start backtacking sewing pattern (AB) is selected 2: A - B 3: B - A - B 4: A - B - A - B *Same as AB (x2) 5: B - A - B - A - B 6: A - B - A - B - A - B *Same as AB (x3)
409	0 - 1	0	1	Operation mode for manual production counter increment function using hand switch 0: Counter can be incremented at any time 1: Counter can only be incremented after sewing stops and thread has been trimmed

4. USING THE OPERATION PANEL (ADVANCED OPERATIONS)

Standard device settings (500 to 599)

No.	Setting range	Initial value	Setting units	Setting details
500	OFF, 1 - 3	1	1	Presser foot lifter SW function OFF: Disabled 1: Presser foot lifter switch 2: Puller switch (switching) 3: Puller switch * Puller operation is enabled when No. 960 is set to "1", and it does not operate when set to other than "OFF".
501	OFF, 1 - 2	OFF	1	Thread holder operation setting OFF: Thread holder does not operate 1: On according to the timing set by No. 502, and off according to the timing set by No. 503 2: On together with starting of machine motor, and off according to the timing set by No. 503
502	90 - 270 (Degrees)	180 (Degrees)	1	Thread presser ON timing (upper shaft angle) (* When No. 501 is set to "OFF" or "2", nothing is displayed. (The setting is disabled.)
503	270 - 430 (Degrees)	320 (Degrees)	1	Thread presser OFF timing (upper shaft angle) (* When No. 501 is set to "OFF", nothing is displayed. (The setting is disabled.)
504	-50 - 50 (Degrees)	0 (Degrees)	1	Feed timing for 1st stitch at sewing start *1
505	-50 - 50 (Degrees)	0 (Degrees)	1	Feed timing for 2nd stitch at sewing start *1
506	-50 - 50 (Degrees)	0 (Degrees)	1	Feed timing for 3rd stitch at sewing start *1
507	-50 - 50 (Degrees)	0 (Degrees)	1	Feed timing for 1st stitch at sewing end *2
508	-50 - 50 (Degrees)	0 (Degrees)	1	Feed timing for 2nd stitch at sewing end *2
509	-50 - 50 (Degrees)	0 (Degrees)	1	Feed timing for 3rd stitch at sewing end *2

4-9. Reading and writing data using USB media

Programs and memory switch data can be copied between sewing machines by means of USB media.

CAUTION



Turn off the power before connecting the USB memory.

Do not connect anything to the USB port other than the USB memory. If this is not observed, problems with operation may result. Attach the cap after use.

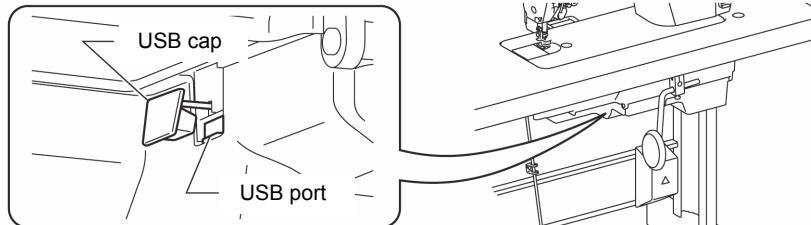

1464D

1

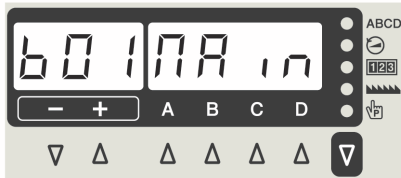

1. First connect the USB media to the sewing machine.
2. While pressing the key, turn on the power switch.
 - "B01 MAIn" will be displayed.

1465D

2

1. Press the - / + keys to select the item to read/write.
2. Press the key to run the selected read/write item.
3. When the key is pressed, normal sewing machine operation will be possible.

The read/write items that can be selected are as follows.

3-digit display	4-digit display	Setting item	Read/write direction
『B81』	『PRGR』	Read all programs	USB media → (Panel) → Sewing machine
『B82』	『PRGW』	Write all programs	USB media ← (Panel) ← Sewing machine
『B83』	『MSWR』	Read all memory switches	USB media → (Panel) → Sewing machine
『B84』	『MSWW』	Write all memory switches	USB media ← (Panel) ← Sewing machine
『B85』	『ADTR』	Read all data	USB media → (Panel) → Sewing machine
『B86』	『ADTW』	Write all data	USB media ← (Panel) ← Sewing machine
『B87』	『PDIW』	Write production information	USB media ← (Panel) ← Sewing machine
『B88』	『ERRW』	Write error log	USB media ← (Panel) ← Sewing machine

Create folders for USB media



Data type	File name	Folder name
Program	ISMUPG.SEW	¥BROTHER¥ISM¥ISMDL** (** is the value for MSW-750) (Refer to the Service Manual for details on MSW-750.)
Memory switches	ISMMSW.SEW	Same as above
Cycle programs	ISMCYC.SEW	Same as above
Program functions in common	ISMCOM.SEW	Same as above
Design stitches	ISM DST.SEW	Same as above
Hand switch	ISMHSW.SEW	Same as above
Error log	E*****.LDT M*****.LDT	¥BROTHER¥ISM¥ISMLDT¥
Production data	P*****.LDT	Same as above

4-10. Resetting all settings to their defaults

If the sewing machine stops operating normally, the cause may be that an incorrect setting may have been made for the memory data by means of memory switches, for instance. In such cases, it may be possible to restore normal operation by following the steps given below to initialize the memory setting data.

1. While pressing the  key, turn on the power switch.

The mode will switch to initialization mode and "C01 ALLC" will appear in the display.

2. Press the -  / +  keys to select the item to be initialized.

3-digit display	4-digit display	Initialization item
『C01』	『ALLC』	Clear all
『C02』	『MSWC』	Memory switch initialization
『C03』	『PGMC』	Program initialization
『C04』	『PDIC』	Production data initialization

3. Press the  key for 2 seconds or more.

When initialization is complete, the 4-digit display will change to show "End", and then after one second it will switch back to the previous display.

4. Press the  key.

Initialization mode will be exited and normal sewing machine operation will then be possible.

* For details on initialization items other than "C01 ALL", refer to the Service Manual.

4-11. Hand switch

The following functions can be set for the hand switch.

When the correction sewing setting is "ON", the hand switch operates as a correction sewing switch, and when the correction sewing setting is "OFF", the hand switch operates as a switch for functions other than correction sewing. (Refer to "4-6-10. Correction sewing function (1)" for details on changing the correction sewing settings.)

<When the optional hand switch is being used>

The hand switch and the optional hand switch cannot be pressed at the same time. (The one which was pressed first will be activated.)

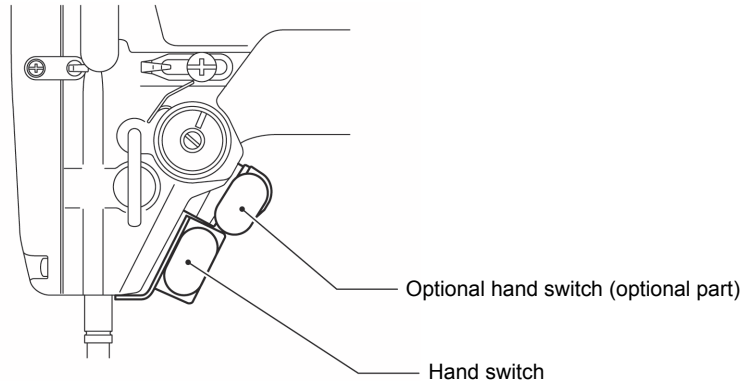

1431D

● Settings for correction sewing switch (This setting is enabled when the correction sewing setting (A04) is "ON".)

	Setting value	Function	Setting details
Settings for correction sewing switch	OFF	Disabled	
	1	Single correction sewing	Stops after sewing a single stitch.
	2	Continuous correction sewing	If the switch is kept pressed, sewing continues.
	3	Single stitch correction sewing at 2nd correction pitch (*1)	Stops after sewing a single stitch.
	4	Continuous correction sewing at 2nd correction pitch (*1)	If the switch is kept pressed, sewing continues.
	5	Reverse single correction sewing	Stops after sewing a single stitch.
	6	Reverse continuous correction sewing	If the switch is kept pressed, sewing continues.
	7	Half stitch correction sewing	Stops after half stitch sewing.
	8	Reverse single stitch correction sewing at 2nd correction pitch (*1)	Stops after sewing a single stitch.
9	Reverse continuous correction sewing at 2nd correction pitch (*1)	If the switch is kept pressed, sewing continues.	

(*1) Set the 2nd correction pitch separately. (Refer to "4-11-2. Setting the 2nd correction pitch".)

4. USING THE OPERATION PANEL (ADVANCED OPERATIONS)













● Settings for other than correction sewing switch (This setting is enabled when the correction sewing setting (A04) is "OFF".)

	Setting value	Function	Setting details
Settings for other than correction sewing switch	OFF	Disabled	
	1	Reverse	Feed moves in reverse while the switch is being pressed.
	2	Second pitch (*2)	Changes to 2nd pitch while the switch is being pressed.
	3	Second Pitch (switching) (*2)	Switches between second pitch and main pitch each time the switch is pressed.
	4	Thread trimming	<ul style="list-style-type: none"> • When the switch is pressed, thread trimming is carried out. • When this function is selected, the hand switch operates as a thread trimming switch even if the correction sewing icon is turned on.
	5	Presser foot lifter	• If the switch is pressed while tread trimming is stopped, the presser foot is raised.
	6	Presser foot lifter (switching)	• While tread trimming is stopped, the presser foot is raised and lowered each time the switch is pressed.
	7	Single end backtack cycle cancel	<ul style="list-style-type: none"> • This is enabled when the end backtack key is on. • If you press the switch and then depress the treadle backward while the sewing machine is stopped, the thread will be trimmed without end backtacking being carried out. • End backtacking is only canceled once.
	8	Standard locus	Changes to standard locus while the switch is being pressed.
	9	Standard locus (switching)	Switches between the locus which is set and the standard locus each time the switch is pressed.
	10	Special locus 1	Changes to special locus 1 while the switch is being pressed.
	11	Special locus 1 (switching)	Switches between the locus which is set and special locus 1 each time the switch is pressed.
	12	Special locus 2	Changes to special locus 2 while the switch is being pressed.
	13	Special locus 2 (switching)	Switches between the locus which is set and special locus 2 each time the switch is pressed.
	14	Special locus 3	Changes to special locus 3 while the switch is being pressed.
	15	Special locus 3 (switching)	Switches between the locus which is set and special locus 3 each time the switch is pressed.
16	Production counter manual count increase (*3)	The production counter increases by 1 each time the switch is pressed while sewing is stopped.	

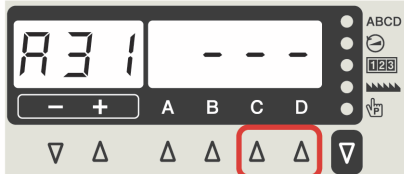
(*2) Set the 2nd pitch separately. (Refer to "4-11-3. Setting the 2nd pitch".)







(*3) When using this setting, "Settings for correction sewing switch" are disabled, even if the correction sewing setting (A04) is ON.

4-11-1. Hand switch function setting

1	<p><Switching to hand switch setting mode></p> 	<p>In sewing standby mode, press the  key while holding down the  key to switch to function setting mode.</p> <ul style="list-style-type: none"> • "A01 UPdn" will be displayed. 	1369D						
2	 <p style="text-align: center;">Set to A31 or A32</p>	<p>Press the -  / +  keys to set to A31 or A32, and then press the  key to select.</p> <table border="1" style="width: 100%; border-collapse: collapse;"> <thead> <tr> <th style="text-align: left;">Menu No.</th> <th style="text-align: left;">Setting details</th> </tr> </thead> <tbody> <tr> <td style="text-align: center;">A31</td> <td>Settings for correction sewing switch</td> </tr> <tr> <td style="text-align: center;">A32</td> <td>Settings for other than correction sewing switch</td> </tr> </tbody> </table>	Menu No.	Setting details	A31	Settings for correction sewing switch	A32	Settings for other than correction sewing switch	1397D
Menu No.	Setting details								
A31	Settings for correction sewing switch								
A32	Settings for other than correction sewing switch								
3	 <p style="text-align: center;">Select the setting</p>	<p>Press the D  / C  keys to select the desired setting value.</p> <ul style="list-style-type: none"> • When the  key is pressed, the initial value will be reset. • When the  key is pressed, the mode returns to function setting mode. • When the  key is pressed, the mode returns to sewing standby mode. 	1398D						

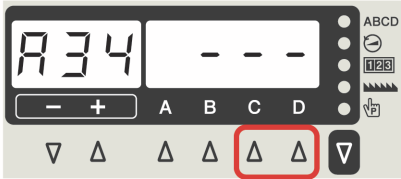





4-11-2. 2nd correction pitch setting

Normally, correction sewing is carried out at the currently-set sewing pitch. However, when "Correction sewing at 2nd correction pitch" or "Reverse correction sewing at 2nd correction pitch" is set for carrying out correction sewing, then correction sewing is carried out at the pitch which is set below.

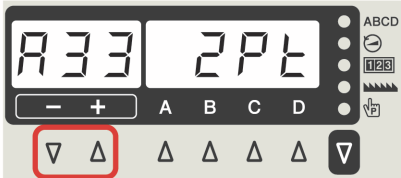
1	<p><Switching to correction 2nd pitch ratio screen></p>  <p style="text-align: center;">Set to A34</p>	<p>In function setting mode, press the - ▽ / + ▲ keys to set A34, and then press the  key to select.</p>
2	 <p style="text-align: center;">Set the ratio.</p>	<p>Press the D ▲ / C ▲ keys to set the ratio with respect to the current pitch.</p> <p>The setting range is from 10% to 250%.</p> <ul style="list-style-type: none"> • When the  key is pressed, the initial value will be reset. • When the  key is pressed, the mode returns to function setting mode. • When the  key is pressed, the mode returns to sewing standby mode.

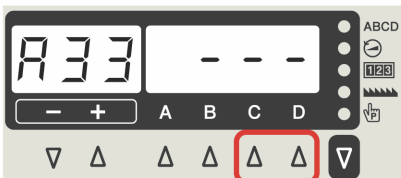
4-11-3. 2nd pitch setting

If "2nd pitch" has been set and the hand switch is pressed during sewing, the stitch pitch will change to the pitch set as follows.

1	<p><Switching to 2nd pitch ratio screen></p>  <p style="text-align: center;">Set to A33</p>	<p>In function setting mode, press the - ▽ / + ▲ keys to set A33, and then press the  key to select.</p>
2	 <p style="text-align: center;">Set the ratio.</p>	<p>Press the D ▲ / C ▲ keys to set the ratio with respect to the current pitch.</p> <p>The setting range is from 10% to 250%.</p> <ul style="list-style-type: none"> • When the  key is pressed, the initial value will be reset. • When the  key is pressed, the mode returns to function setting mode. • When the  key is pressed, the mode returns to sewing standby mode.

4-11-4. Menu numbers for setting functions for the hand switch

When setting functions for the hand switch, the menu numbers and setting contents are as given below.

Menu No.	Setting details	
A31	Hand switch setting	Settings for correction sewing switch
A32		Settings for other than correction sewing switch
A33	2nd pitch setting	Settings for other than correction sewing switch
A34	2nd correction pitch setting	Settings for correction sewing switch
A35	Optional hand switch setting	Settings for correction sewing switch
A36		Settings for other than correction sewing switch

5. CLEANING

! CAUTION



Turn off the power switch before carrying out these operations.
The machine may operate if the treadle is depressed by mistake, which could result in injury.



Be sure to wear protective goggles and gloves when handling the grease so that it does not get into your eyes or onto your skin. Otherwise inflammation can result.
Furthermore, do not drink the oil or eat the grease under any circumstances. Diarrhea or vomiting may result.
Keep the oil out of the reach of children.



Secure the table so that it will not move when tilting back the machine head.
If the table moves, it may crush your feet or cause other injuries.



Use both hands to hold the machine head when tilting it back or returning it to its original position.
If only one hand is used, the weight of the machine head may cause your hand to slip, and your hand may get caught.

The following cleaning operations should be carried out each day in order to maintain the performance of this machine and to ensure a long service life. Furthermore, if the sewing machine has not been used for a long period of time, carry out the following cleaning procedures before using it again.

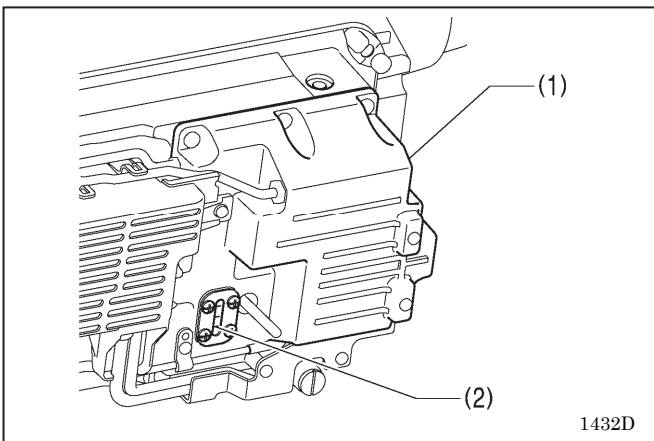



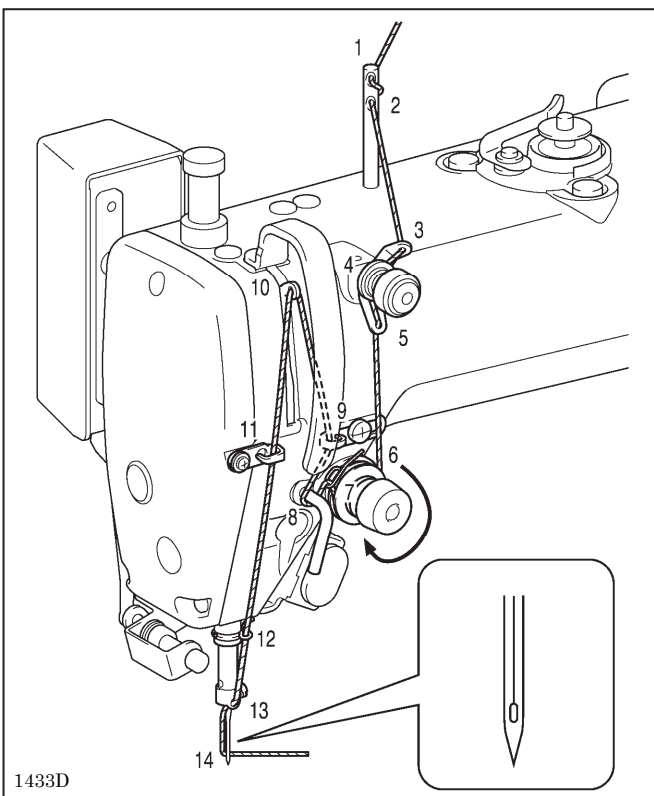





1. If the oil level drops below the lower reference line (2) on the oil cover (1), be sure to replenish the oil. (Refer to "2-3. Lubrication".)



2. Return the machine head to its original position.
3. Replace the needle if it is bent or if the tip is broken.
4. Check that the upper threads have been threaded correctly.
5. Carry out a test sewing.

6. STANDARD ADJUSTMENTS

⚠ CAUTION

-  Maintenance and inspection of the sewing machine should only be carried out by a qualified technician.
-  Ask your Brother dealer or a qualified electrician to carry out any maintenance and inspection of the electrical system.
-  If any safety devices have been removed, be absolutely sure to re-install them to their original positions and check that they operate correctly before using the machine.
-  Secure the table so that it will not move when tilting back the machine head.
If the table moves, it may crush your feet or cause other injuries.
-  Use both hands to hold the machine head when tilting it back or returning it to its original position.
If only one hand is used, the weight of the machine head may cause your hand to slip, and your hand may get caught.
-  Turn off the power switch and disconnect the power cord plug at the following times.
The machine may operate if the treadle is depressed by mistake, which could result in injury.
 - When carrying out inspection, adjustment and maintenance
 - When replacing consumable parts such as the rotary hook and knives
-  Always be sure to turn off the power switch and then wait one minute before opening the motor cover.
If you touch the surface of the motor, it may cause burns.
-  If the power switch needs to be left on when carrying out some adjustment, be extremely careful to observe all safety precautions.

6-1. Arm thread guide R

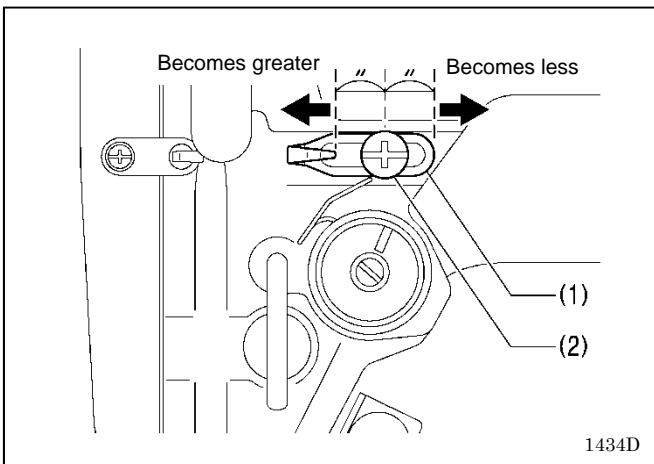

The standard position of arm thread guide R (1) is the position where the screw (2) is in the center of the adjustable range for arm thread guide R (1).

NOTE:

To adjust the position, loosen the screw (2) and then move arm thread guide R (1).

- When sewing heavy-weight material, move arm thread guide R (1) to the left. (The thread take-up amount will become greater.)
- When sewing light-weight material, move arm thread guide R (1) to the right. (The thread take-up amount will become less.)

6-2. Presser foot height

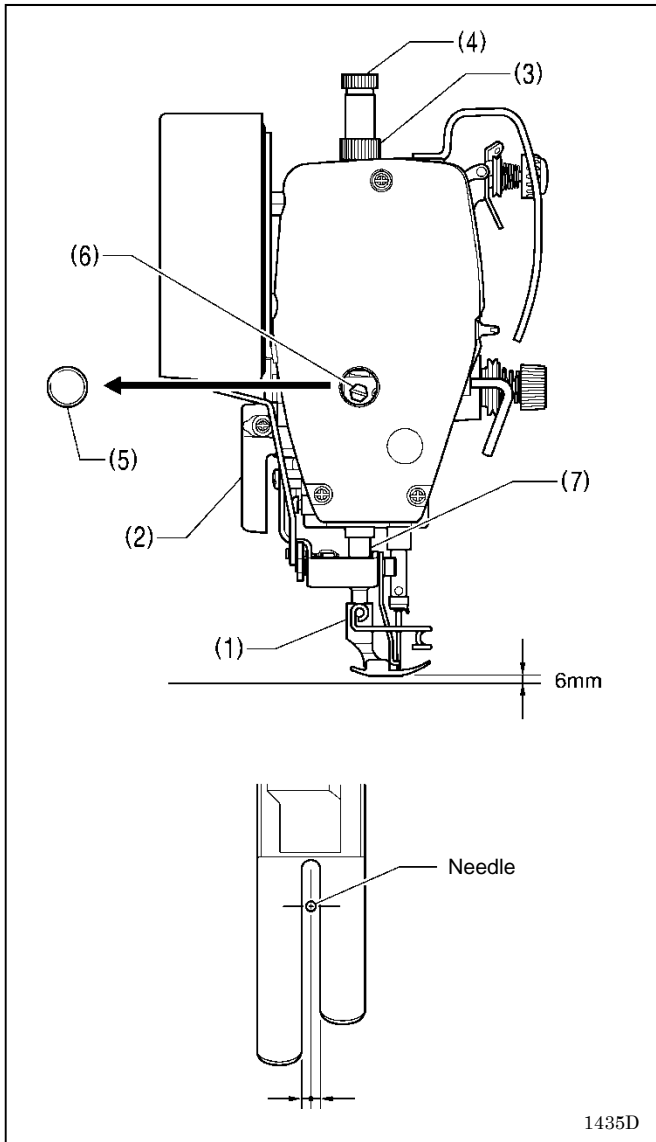

The standard height of the presser foot (1) is 6 mm when the presser foot (1) is raised by means of the lifting lever (2).

1. Loosen the nut (3), and then loosen the adjustment screw (4) so that there is no pressure applied to the presser foot.
2. Raise the presser foot (1) by using the lifting lever (2).
3. Remove the rubber cap (5) from the face plate.
4. Loosen the bolt (6) and then move the presser bar (7) up or down until the presser foot (1) is at the standard height of 6 mm.
5. Tighten the bolt (6).
6. Install the rubber cap (5).
7. Adjust the presser foot pressure using the presser adjusting screw (4), and then tighten the nut (3).

NOTE:

After adjusting, check that the needle moves down into the center of the groove in the presser foot.

6-3. Adjusting the feed dog height

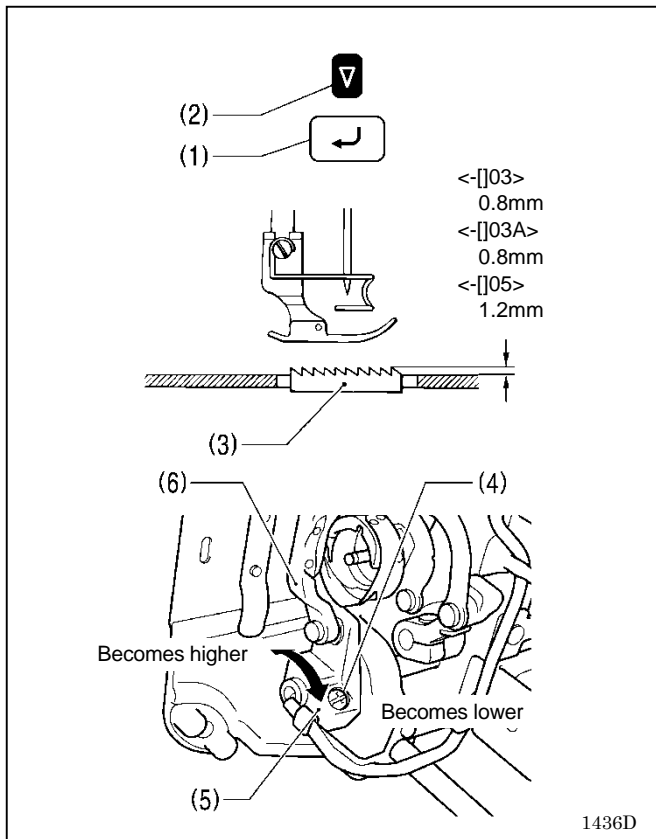

1. Turn on the power.
2. Turn off start backtacking, best PFM mode, slow start and special locus.
3. Set the feed pitch to 5 mm.
4. Press and hold the ENTER key (1) and then press the SEL key (2).

* The standard height of the feed dog (3) when it is raised as far as possible above the surface of the needle plate is 0.8 mm for -[03] specifications, 0.8 mm for -[03A] specifications and 1.2 mm for -[05] specifications.

5. Turn the machine pulley to move the feed dog (3) to its highest position above the needle plate.
6. Tilt back the machine head.
7. Loosen the screw (4).
8. Turn the feed lifting shaft crank (5) to move the feed bracket (6) up and down.
9. Tighten the screw (4).
10. After adjusting, press the SEL key (2).

6-4. Adjusting the feed dog angle

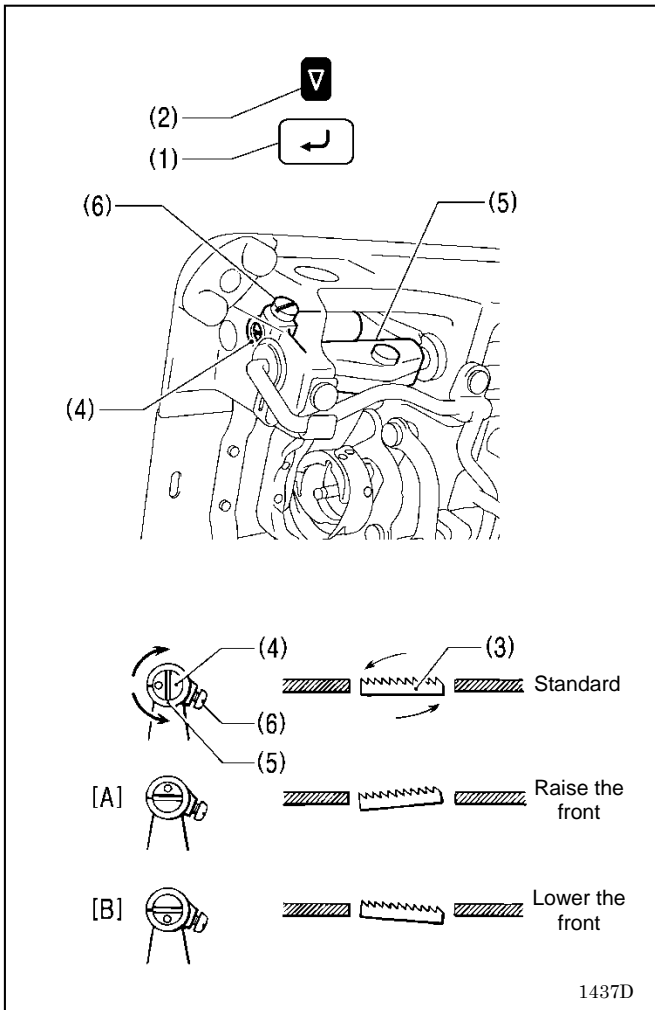

1. Turn on the power.
2. Turn off start backtack sewing, best PFM mode, slow start and special locus.
3. Set the feed pitch to 5 mm.
4. Press and hold the ENTER key (1) and then press the SEL key (2).

* The standard angle for the feed dog (3) when it drops until it is aligned with the top of the needle plate is when the "O" mark on the shaft (4) is aligned with the feed rocker bracket arm (5) and the feed dog (3) is parallel to the needle plate.

5. Turn the machine pulley to move the feed dog (3) to its highest position above the needle plate.
6. Tilt back the machine head.
7. Loosen the set screw (6).
8. Turn the shaft (4) in the direction of the arrow within a range of 90° with respect to the standard position.
 - In order to prevent puckering, lower the front of the feed dog (3). (Fig. [B])
 - In order to prevent the material from slipping, raise the front of the feed dog (3). (Fig. [A])
9. Securely tighten the set screw (6).
10. After adjusting, press the SEL key (2).

NOTE:

The height of the feed dog (3) will change after the angle has been adjusted, so it will be necessary to re-adjust the height of the feed dog (3).

6-5. Adjusting the needle bar height

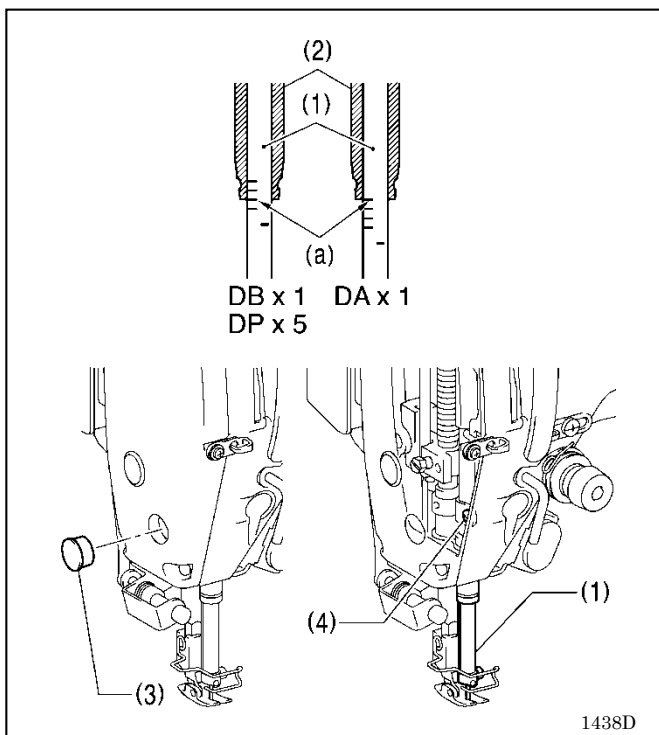

Reference line (a) on the needle bar (1) should be aligned with the lower edge of the needle bar bush (2) as shown in the illustration when the needle bar (1) is at its lowest position.

1. Turn the machine pulley to set the needle bar (1) to its lowest position.
2. Remove the rubber cap (3) from the face plate.
3. Loosen the screw (4) and move the needle bar (1) up or down to adjust its position.
4. Securely tighten the screw (4).
5. Install the rubber cap (3).

6-6. Adjusting the needle and feed mechanism timing

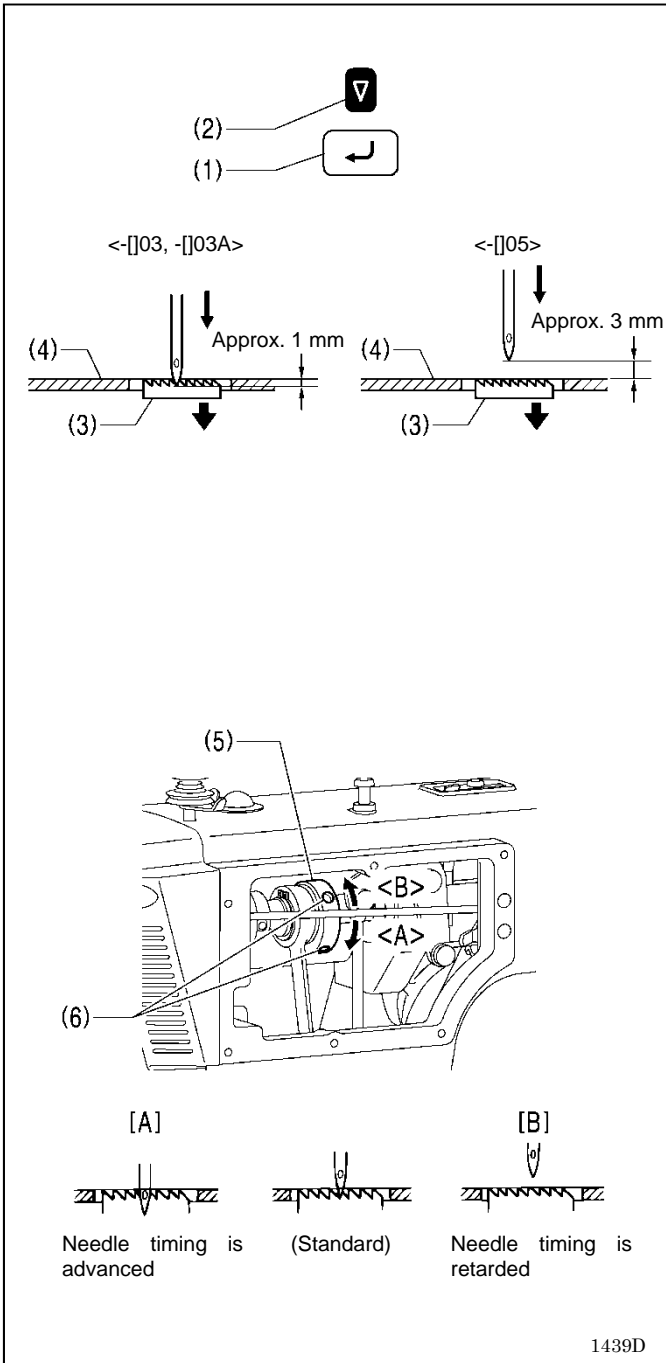

1. Turn on the power.
2. Turn off start backtack sewing, best PFM mode, slow start and special locus.
3. Set the feed pitch to 5 mm.
4. Press and hold the ENTER key (1) and then press the SEL key (2).

* The illustration at left shows the standard position for the needle tip when the feed dog (3) is lowered from its highest position until it is flush with the top of the needle plate (4).

5. Remove the side plate.
6. Loosen the two set screws (6) of the vertical cam (5), and then turn the vertical cam (5) slightly to adjust the timing.
 - To advance the needle timing, turn in the direction of <A>. To retard the needle timing, turn in the direction of .
 - To prevent material slippage from occurring, retard the needle timing. (Fig. [B])
 - To improve thread tightening, advance the needle timing. (Fig. [A])

NOTE:

If the vertical cam (5) is turned too far in the direction of <A>, it may cause the needle to break.

7. After adjusting, securely tighten the set screw (6).
8. Install the side plate.
9. After adjusting, press the SEL key (2).

6-7. Needle and rotary hook timing

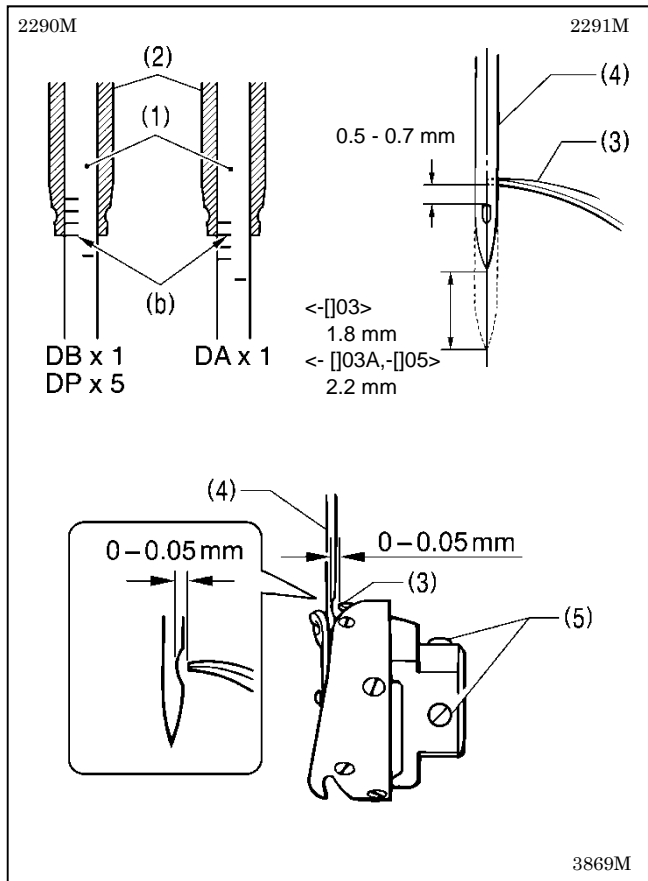

The tip of the rotary hook (3) should be aligned with the center of the needle (4) when the needle bar (1) moves up 1.8 mm (2.2 mm for $\langle -[03A], -[05] \rangle$ specifications) from its lowest position to the position where reference line (b) is aligned with the lower edge of the needle bar bush (2) as shown in the illustration.

(The distance from the upper edge of the needle hole to the rotary hook tip will be 0.5 to 0.7 mm at this time.)

1. Turn the machine pulley to raise the needle bar (1) from its lowest position until reference line (b) is aligned with the lower edge of the needle bar bush (2) as shown in the illustration.
2. Loosen the three set screws (5), and then align the rotary hook tip (3) with the center of the needle (4).
The distance between the tip of the rotary hook (3) and the needle (4) should be approximately 0 - 0.05 mm at this time.
3. Securely tighten the three set screws (5).

6-8. ADJUSTING THE ROTARY HOOK LUBRICATION AMOUNT

CAUTION

Be careful not to touch your fingers or the lubrication amount check sheet against moving parts such as the rotary hook or the feed mechanism when checking the amount of oil supplied to the rotary hook. If care is not taken, injury may result.

Use the following procedure to check the amount of oil being supplied to the rotary hook when replacing the rotary hook or when changing the sewing speed.

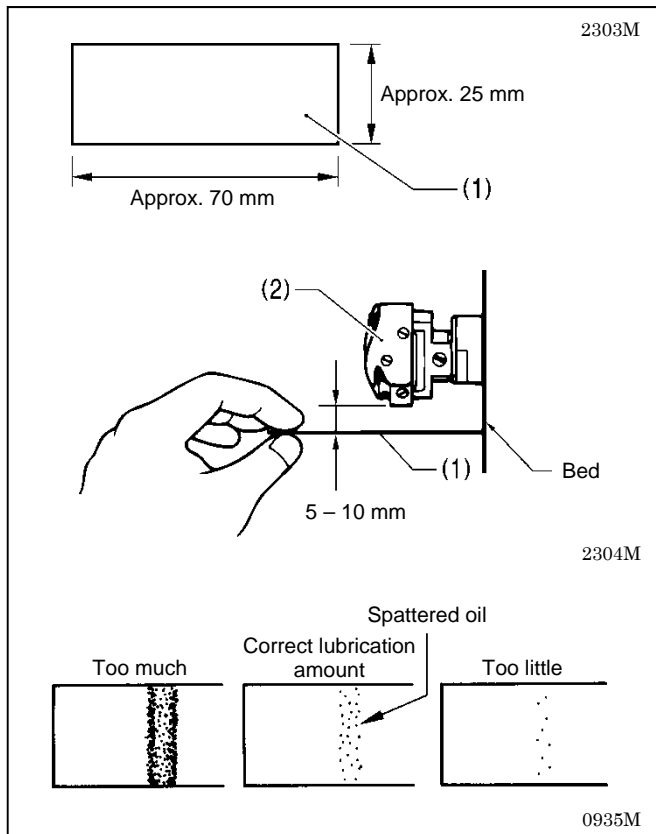
**<Checking the lubrication amount>**

1. Remove the thread from all points from the thread take-up lever to the needle.
2. Use the lifting lever to lift the presser foot.
3. Run the machine at the normal sewing speed for approximately 1 minute without sewing any material (following the same start/stop pattern as when actually sewing).
4. Place the lubrication amount check sheet (1) to the left of the rotary hook (2) and hold it there. Then run the sewing machine at the normal sewing speed for 8 seconds. (Any type of paper can be used as the lubrication amount check sheet (1).)
5. Check the amount of oil which has spattered onto the sheet.

If adjustment is necessary, carry out the following operations in "Adjusting the lubrication amount".

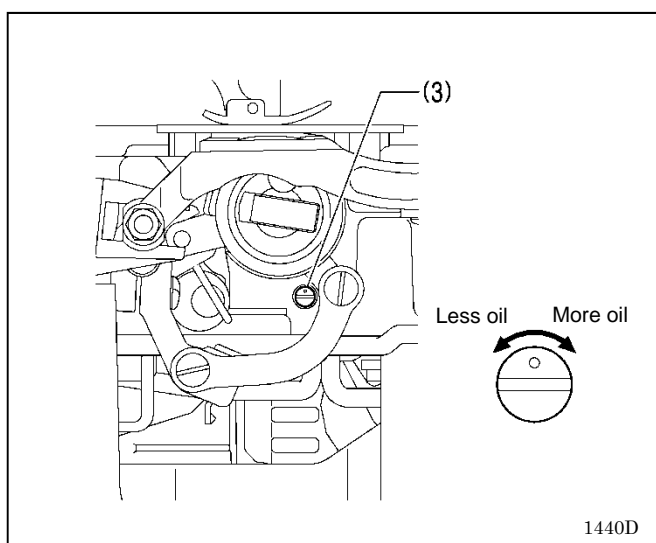
**<Adjusting the lubrication amount>**

1. Tilt back the machine head.
2. Turn the rotary hook adjusting screw (3) to adjust the lubrication amount.
 - If the rotary hook adjusting screw (3) is turned clockwise, the lubrication amount becomes greater.
 - If the rotary hook adjusting screw (3) is turned counterclockwise, the lubrication amount becomes smaller.
3. Check the lubrication amount again according to the procedure given in "Checking the lubrication amount" above.

NOTE:

Turn the rotary hook adjusting screw (3) and check the lubrication amount repeatedly until the lubrication amount is correct.

4. Check the lubrication amount again after the sewing machine has been used for approximately two hours.

6-9. Thread trimming (Other than short trailing thread specifications)

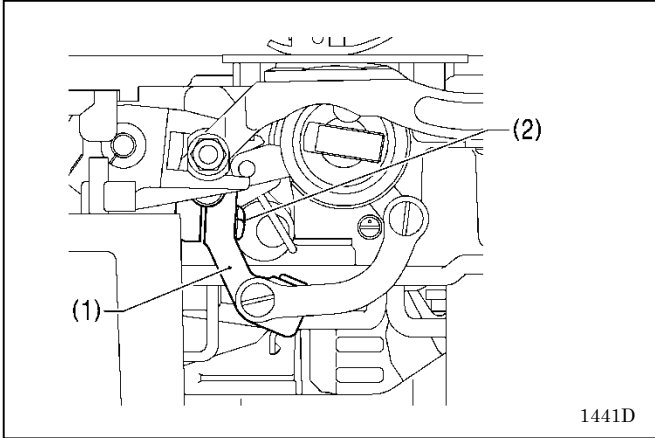

1. Turn off the power switch.
2. Remove the presser foot, needle plate and feed dog.
3. Tilt back the machine head.
4. Loosen the screw (2) of the thread trimmer lever (1).

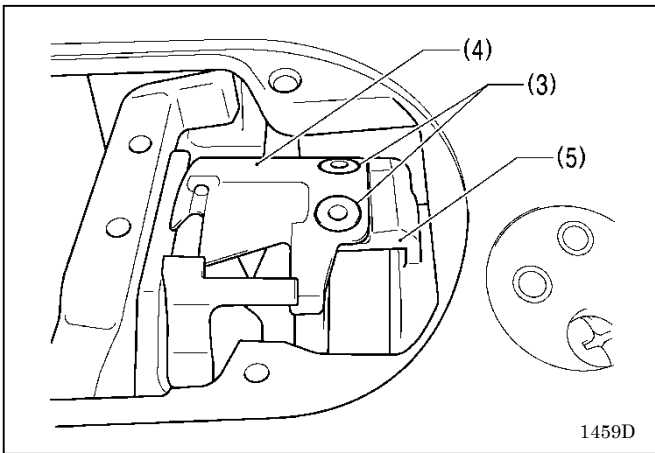

5. Install the movable knife (4) to the movable knife holder (5) with the two screws (3).

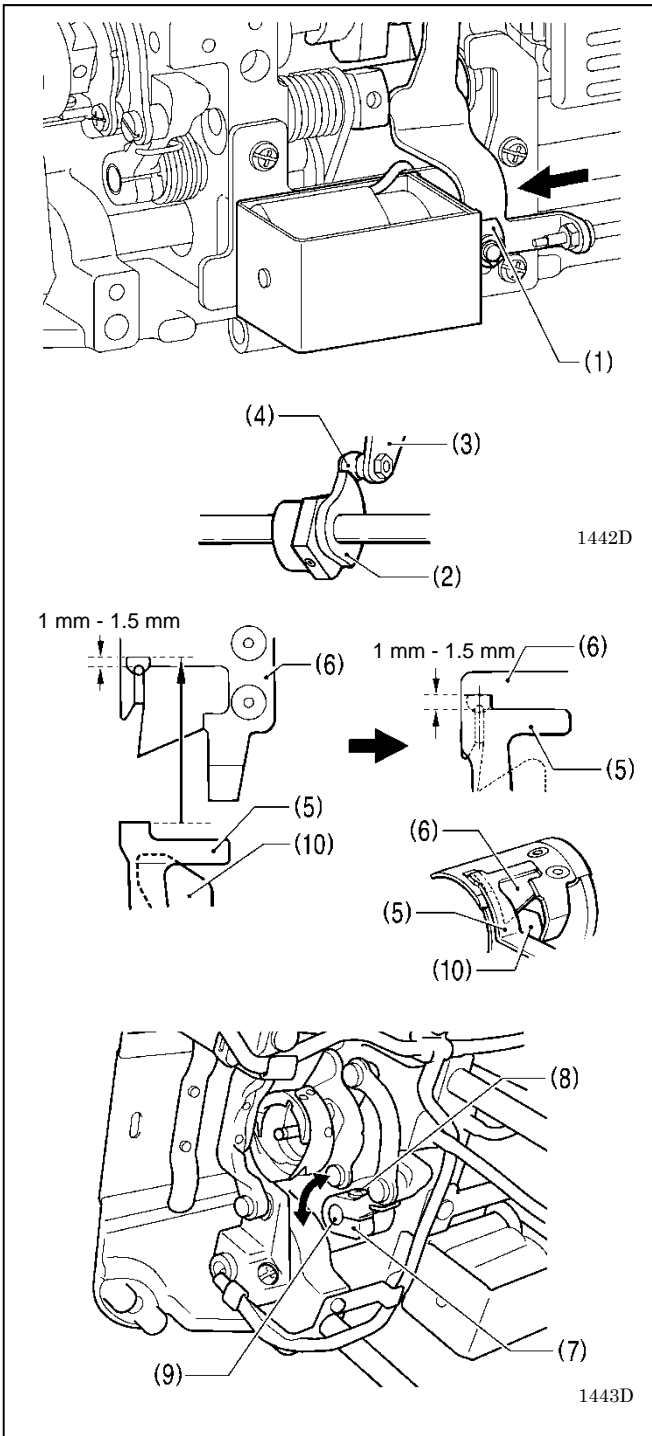
**<Movable knife and fixed knife position adjustment>**

1. Turn the machine pulley, and then push the plunger (1) of the thread trimming solenoid with your finger.
2. In this condition, turn the machine pulley until the roller shaft (4) of the thread trimmer cam lever assembly (3) is sitting on top of the thread trimmer cam (2), then move the thread trimmer lever (7) to adjust its position so that the tip of the fixed knife (5) and the blade of the movable knife (6) are meshed by 1 to 1.5 mm, and then tighten the screw (8).
 - * Tighten the screw (8) so that there is no play in the forked shaft (9).
 - * The lower thread finger (10) must be underneath the movable knife (6).
3. Install the feed dog, needle plate and presser foot.

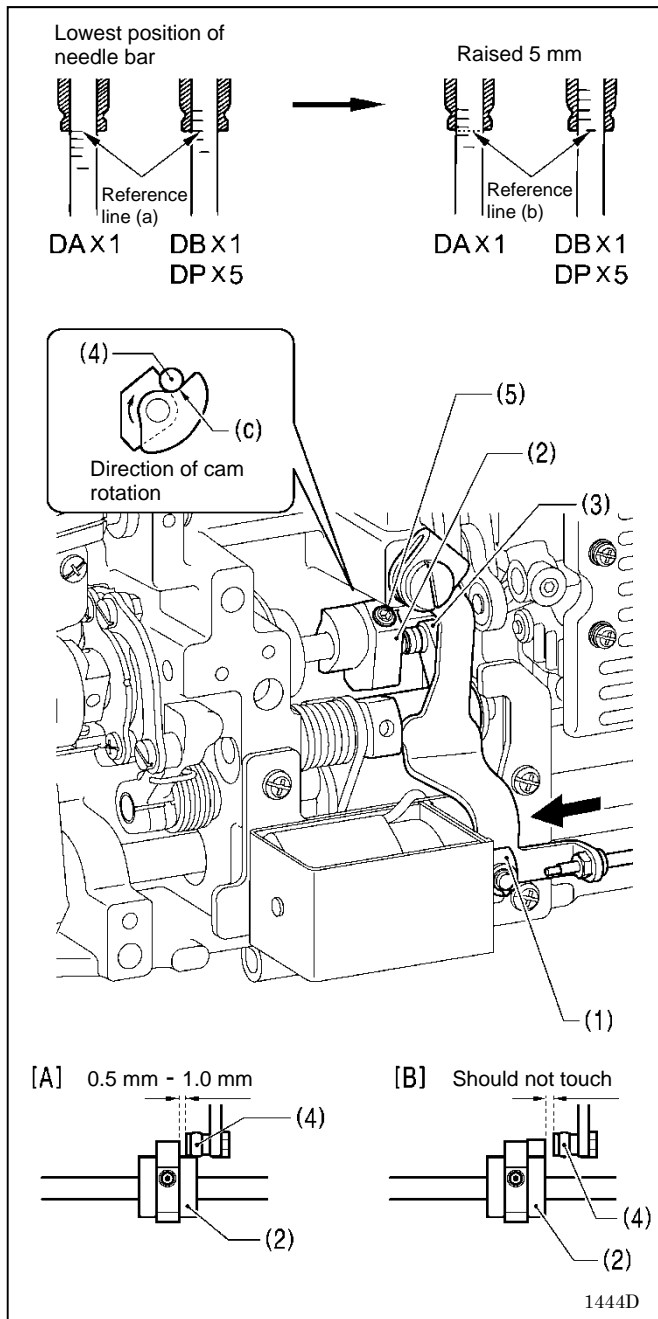

<Thread trimming cam position adjustment>

1. Raise the needle bar 5 mm from its lowest position so that the reference line (b) is aligned with the bottom edge of the needle bar bush, and then push the plunger (1) of the thread trimmer solenoid in the direction of the arrow with your finger.
Adjust the position of the thread trimmer cam (2) at this time so that the roller shaft (4) of the thread trimming cam lever assembly (3) touches the hollow (c) of the thread trimmer cam (2) and so that the clearance between the edge of the thread trimmer (2) and the roller (4) is 0.5 to 1.0 mm, and then tighten the set screw (5). (Fig. [A])
 2. Check that the edge of the thread trimmer cam (2) and the roller shaft (4) do not touch when the roller shaft (4) returns to the right. (Fig. [B])
- * Tighten the two set screws (5) to approximately 4 N.m.

6-10. Thread trimming (Short trailing thread specifications)

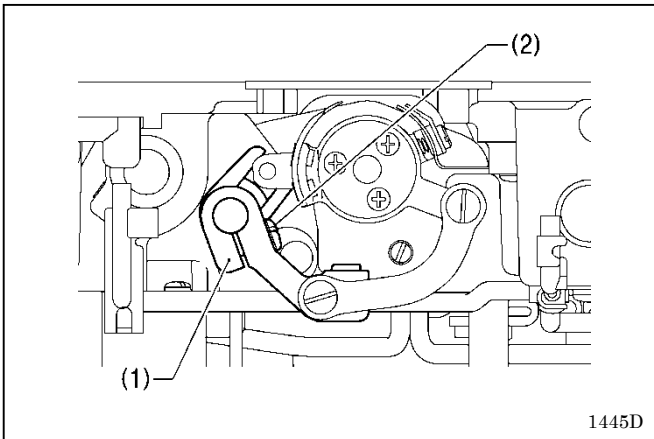

1. Turn off the power switch.
2. Remove the presser foot, needle plate and feed dog.
3. Tilt back the machine head.
4. Loosen the screw (2) of the thread trimmer lever (1).
(This will allow the upper and lower knife holders and the needle bar mechanism to operate independently.)

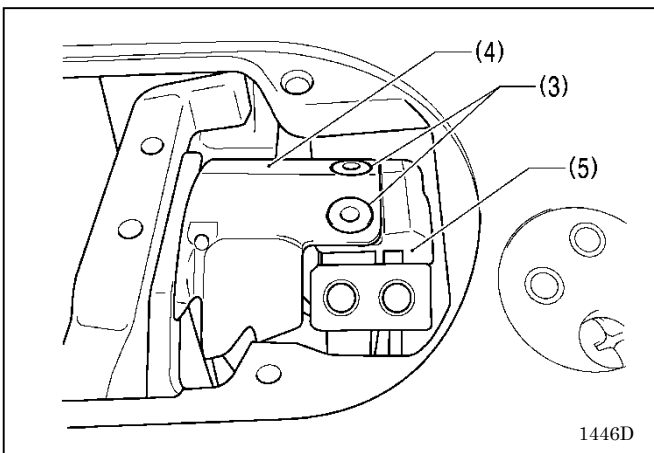

5. Install the lower knife (4) to the lower knife holder (5) with the two screws (3).

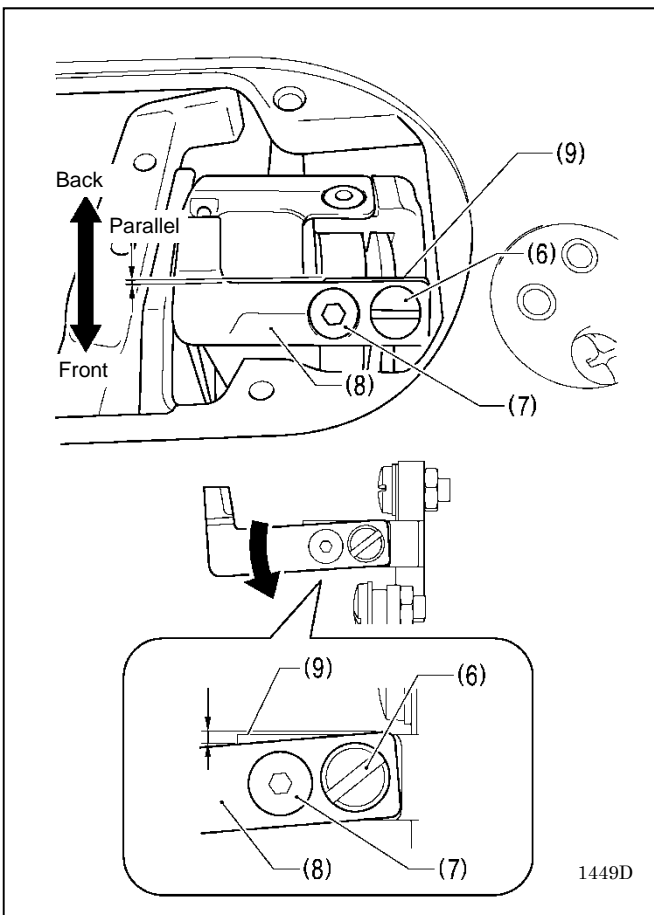

6. Install the upper knife (8) with the two screws (6) and (7).
 - * Install the upper knife (8) so that it is almost parallel to the ridge line on the mounting surface of the upper knife holder (9).
 - * If the upper knife (8) is tilted forward, the knife pressure will increase, and if it is tilted backward, the knife pressure will decrease.
 - * After adjusting, operate the upper and lower knife holders by hand and check that the thread can be trimmed.
- * If using thick thread, or if the thread is not being trimmed, adjust the tilt of the upper knife (8) forward.
- * Tilt the upper knife (8) forward slightly (about 0.3 mm) so that the ridge line on the mounting surface of the upper knife holder (9) is slightly visible.
(The head of the screw (7) is pan-shaped, and so the upper knife (8) can pivot on this screw when it is tilted.)
Be careful not to tilt it too much, otherwise the upper knife will go underneath the lower knife, and damage may result.

6. STANDARD ADJUSTMENTS

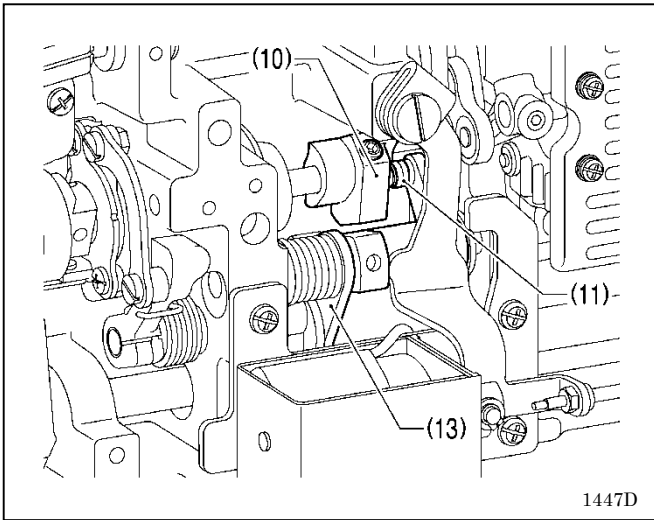

7. Turn the machine pulley while the thread trimmer solenoid is still turned on so that the thread trimmer cam (10) moves the thread trimmer cam roller (11) to its maximum displacement position.
 - * Make sure that the thread trimmer solenoid does not turn off and does not return during this step.

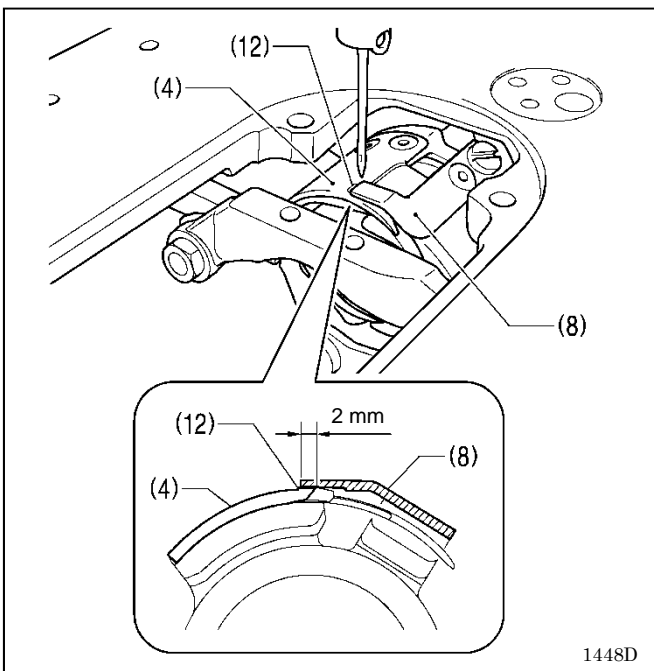

8. Set the maximum meshing amount for the upper and lower knives to 2 mm.
 - * Turn the thread trimmer lever (1) to align the tip of the upper knife (8) with the center of the index mark (12) on the lower knife (4).
 - * Make sure that the tip of the upper knife (8) does not go past the index mark (12).

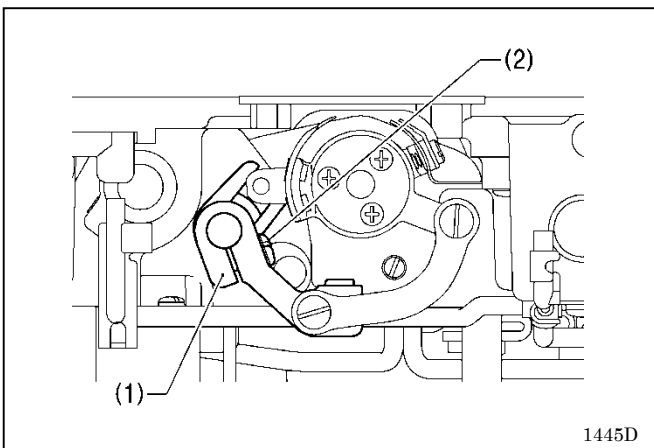

9. Tighten the screw (2) of the thread trimmer lever (1).
 - * Make sure that there is no play in the thrust direction in the forked shaft (13) of the thread trimmer lever (1) (see illustration on page 7).

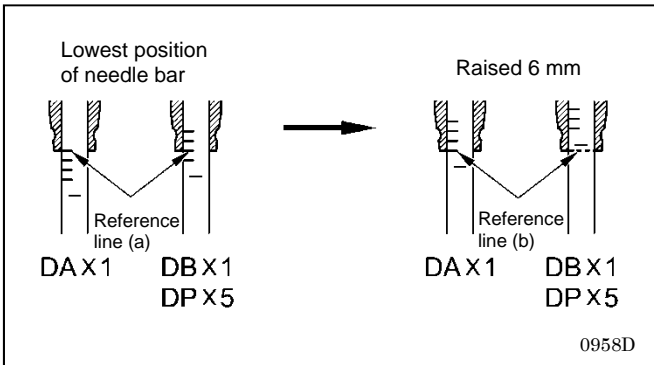

<Thread trimming cam position adjustment>

1. Turn the machine pulley to raise the needle bar 6 mm from its lowest position (reference line (a) position) so that reference line (b) is aligned with the bottom edge of the needle bar bush.

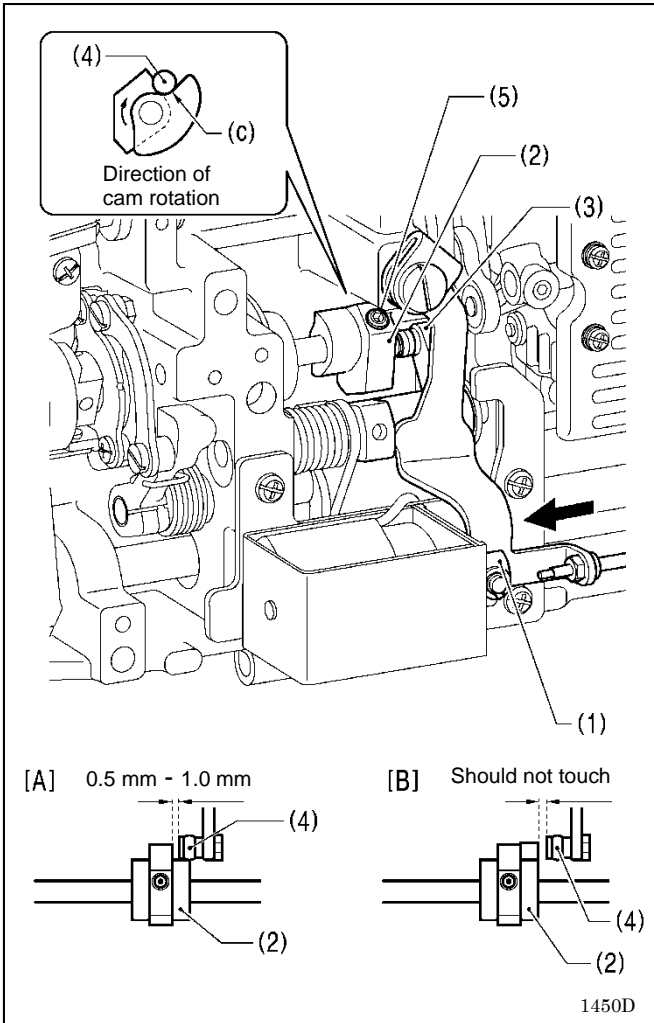

2. At the above position, push the plunger (1) of the thread trimming solenoid with your finger in the direction of the arrow.

Adjust the position of the thread trimmer cam (2) at this time so that the roller shaft (4) of the thread trimming cam lever assembly (3) touches the hollow (c) of the thread trimmer cam (2) and so that the clearance between the edge of the thread trimmer (2) and the roller (4) is 0.5 to 1.0 mm, and then tighten the set screw (5). (Fig. [A])

3. Check that the edge of the thread trimmer cam (2) and the roller shaft (4) do not touch when the roller shaft (4) returns to the right. (Fig. [B])

* Tighten the two set screws (5) to approximately 4 N.m.

7. TROUBLESHOOTING

- Please check the following points before calling for repairs or service.
- Simplified details can be checked on the panel. (Menu → Troubleshooting)
- If the following remedies do not fix the problem, turn off the power switch and consult a qualified technician or the place of purchase.

⚠ DANGER



Wait at least 5 minutes after turning off the power switch and disconnecting the power cord from the wall outlet before opening the control box cover. Touching areas where high voltages are present can result in severe injury.





⚠ CAUTION



Turn off the power switch and disconnect the power cord before carrying out these operations. The machine may operate if the treadle is depressed by mistake, which could result in injury.



7-1. Sewing

Items with a "*" in the "Page" column should only be checked by a qualified technician.

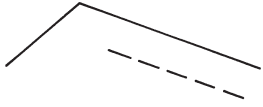
Problem		Possible cause	Page
1	Upper thread is not tight.  0573M	<ul style="list-style-type: none"> • Is the upper thread tension too weak? Is the lower thread tension too strong? Adjust the lower thread tension or upper thread tension. Try pressing the special locus key and selecting No. 1. 	23
2	Lower thread is not tight.  0574M	<ul style="list-style-type: none"> • Is the upper thread tension too strong? Is the lower thread tension too weak? Adjust the lower thread tension or upper thread tension. 	
3	Loops appear in seam.  0977M	<ul style="list-style-type: none"> • Is the thread path not smooth enough? Use a file with a fine grain or sandpaper to polish smooth the thread path. • Is the bobbin turning smoothly? Pull out the lower thread to check that there is no slackness in the thread tension, or replace the bobbin or bobbin case. Try pressing the special locus key and selecting No. 1. 	23
4	Skipped stitches occur while sewing  0470M	<ul style="list-style-type: none"> • Is the needle tip bent? Is the needle tip blunt? If the needle tip is bent or blunt, replace the needle. • Is the needle properly installed? If it is incorrect, install the needle correctly. • Is the machine properly threaded? If it is incorrect, thread the thread correctly. • Is the presser foot pressure too weak? Adjust the presser foot pressure. • Is the needle too thin? Replace the needle with a needle that is one rank thicker. • Is the presser foot too high? Adjust the height of the presser foot. • Is the thread take-up spring too weak? Adjust the tension of the thread take-up spring. • Is the needle and rotary hook timing correct? Adjust the height of the needle bar. • Adjust the clearance between the needle and the tip of the rotary hook. 	47 49* * 51* 53*

	Problem	Possible cause	Page
5	<p>Skipped stitches at sewing start Thread unraveling at sewing start.</p>  <p>0749M</p>	<ul style="list-style-type: none"> • Is the thread take-up spring tension too strong? Reduce the tension of the thread take-up spring. • Is the thread take-up spring operating range too large? Lower the position of the thread take-up spring. • Is the trailing length of the upper thread too short after thread trimming? Adjust the pretension. • Are the threads not being trimmed cleanly? Sharpen the fixed knives, or replace the fixed and movable knives if necessary. Replace the movable knife. • Is the needle too thick? Replace the needle with a needle that is one rank thinner. • Is the length of thread trailing out from the bobbin case after thread trimming too short? If the bobbin is spinning loosely, replace the anti-spin spring in the bobbin case. • Is the sewing speed too fast at the sewing start? Use the slow start key. • Is the needle up stop position too high? Adjust the needle up stop position. • Is the upper thread trailing length too short after thread trimming? Turn on the "Prev. thread away" function. • If the thread is pulling out at the sewing start, try the following remedies. <ol style="list-style-type: none"> 1. Check the upper thread trailing length. 2. Set the slow start number to "3" or less. 3. Re-adjust the upper thread trailing length to make it longer. 4. Select "Prev. thread away PARA" from "Function setting". (Refer to "4-6. Setting basic functions".) <ol style="list-style-type: none"> (1) Set the 2nd stitch pitch to "3". (2) Increase the current stitch pitch settings for the 1st and 2nd stitches by about 0.5 to 1. • Is the needle hole in the needle plate too large for the needle being used? Replace the needle place with one with a needle hole that is one rank thinner. • Is the presser foot groove too wide? Replace the presser foot with one that has a narrower groove so that it presses the material at the needle drop position. • Is the sewing machine starting to sew before the presser foot has dropped? Lower the presser foot before starting sewing. • Is the presser foot being raised before the sewing machine has stopped sewing? Raise the presser foot after the sewing machine has stopped sewing. 	<p style="text-align: center;">*</p> <p style="text-align: center;">*</p> <p style="text-align: center;">55*</p> <p style="text-align: center;">14 · 24 · 29*</p> <p style="text-align: center;">25*</p> <p style="text-align: center;">24</p> <p style="text-align: center;">29*</p> <p style="text-align: center;">24</p> <p style="text-align: center;">*</p>
6	<p>Large bird's nests are forming at the sewing start.</p>	<ul style="list-style-type: none"> • Is the upper thread trailing length too long after thread trimming? Increase the tension of the pre-tension. 	

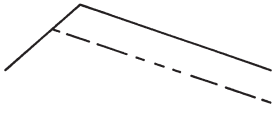
7. TROUBLESHOOTING

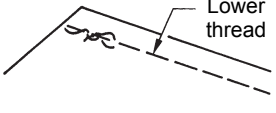
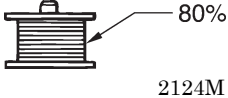
	Problem	Possible cause	Page
7	<p>Uneven seam</p>  <p>0473M</p>	<ul style="list-style-type: none"> • Is the presser foot pressure too weak? Adjust the presser foot pressure. • Is the feed dog too low? Adjust the feed dog height. • Is the bobbin scratched? If the bobbin is damaged, smooth it with an oiled grindstone or replace it. Alternatively, replace the bobbin. 	50*
8	<p>Large degree of puckering (Thread is too tight)</p>  <p>0978M</p>	<ul style="list-style-type: none"> • Is the upper thread tension too strong? Make the upper thread tension as weak as possible. • Is the lower thread tension too strong? Make the lower thread tension as weak as possible. • Is the needle tip blunt? Replace the needle if it is blunt. • Is the needle too thick? Replace with as thin a needle as possible. • Is the thread take-up spring tension too strong? Make the thread take-up spring tension as weak as possible. • Is the thread take-up spring operating range too large? Lower the position of the thread take-up spring to as low a position as possible. • Is the presser foot pressure too strong? Adjust the presser foot pressure. • Is the sewing speed too fast? Gradually reduce the sewing speed. • Is the angle of the feed dog correct? Tilt the front of the feed dog down slightly. 	* * 18* 51*
9	<p>Lower thread is tangled at the sewing start. Bobbin is spinning during thread trimming.</p>  <p>0751M</p>	<ul style="list-style-type: none"> • Is the bobbin spinning direction correct when the lower thread is being pulled? Set the bobbin so that it turns in the opposite direction to the rotary hook. • Is there too much thread wound onto the bobbin? The bobbin winding amount should not be more than 80%. • Is the anti-spin spring attached? Attach the anti-spin spring. • Is the bobbin turning smoothly? If the bobbin is not turning smoothly, replace the bobbin. • Is a bobbin other than the light-alloy bobbin specified by Brother being used? Use only bobbins which are specified by Brother. 	

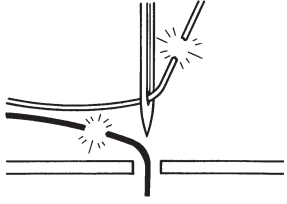
	Problem	Possible cause	Page
10	Upper and lower threads are breaking.  0471M	<ul style="list-style-type: none"> • Is the needle tip bent? Is the needle tip blunt? If the needle tip is bent or blunt, replace the needle. • Is the needle properly installed? If it is incorrect, install the needle correctly. • Is the machine properly threaded? If it is incorrect, thread the thread correctly. • Is the rotary hook sufficiently lubricated? If the oil gauge is down to the lower reference line in the oil gauge window, add more oil. • Is the upper or lower thread tension too weak or too strong? Adjust the upper thread or lower thread tension. • Is the upper thread may be loose because the thread take-up spring operating range is too small? Adjust the position of the thread take-up spring. • Is the rotary hook, feed dog or other part damaged? If the thread path is damaged, smooth it with sandpaper or similar. Alternatively, replace the damaged part. • Is the thread path damaged? If the thread path is damaged, smooth it with sandpaper. Alternatively, replace the damaged part. 	47 6 47* * *
11	Thread breaks during backtack sewing.	<ul style="list-style-type: none"> • Is the backtack sewing speed too fast? Use the panel to reduce the backtack sewing speed. 	19
12	Backtack sewing pitch varies depending on the sewing direction. Backtack edge is not aligned.	Adjust using memory switch No. 201.	38*
13	Thread tightening around X-over seam areas.	<ul style="list-style-type: none"> • Is the height of the feed dog correct? Increase the feed dog height. 	50*
14	Upper thread is pulling out of the needle after thread trimming.	<ul style="list-style-type: none"> • Is the upper thread trailing length after thread trimming appropriate? Decrease the tension of the pre-tension. • Is the thread path not smooth enough? Use a file with a fine grain or sandpaper to polish smooth the thread path. • Does the thread being used slip easily? Turn the needle bar bush thread guide D sideways to increase the resistance. • If the upper thread is pulling out of the needle after thread trimming, check using the method given below. <ol style="list-style-type: none"> 1. Check the upper thread trailing length. 2. Re-adjust the upper thread trailing length to make it longer. 3. Select "T/T short parameter" from "Function setting". (Refer to "4-6. Setting basic functions".) <ol style="list-style-type: none"> (1) Delete the stitch pitch for the previous stitch. (2) Decrease the sewing speed for the final stitch and the stitch before it. 	24*

7. TROUBLESHOOTING

Problem		Possible cause	Page
15	Upper thread is raised above the material surface after thread trimming.	<ul style="list-style-type: none"> Upper thread protrudes from the material surface after thread trimming. Select "T/T short parameter" from "Function setting". (Refer to "4-6. Setting basic functions".) <ol style="list-style-type: none"> Increase the pitch during thread trimming. Set the feed direction for sewing end processing to "bw". 	24*
16	When T/T short is on, skipped stitches occur where they should be sewn at the sewing end.	<ul style="list-style-type: none"> Use the T/T short parameters to delete the the stitch before the final stitch. Use the T/T short parameters to reduce the stitch pitch of the final stitch and the one before it. Use the T/T short parameters to set the feed direction for sewing end processing to "bw". <p>If sewing backtack stitches</p> <ul style="list-style-type: none"> Reduce the number of stitches (D) for backtack sewing by 1 stitch 	24* (65-15) 15*
17	When T/T short is on, condense stitches (the final stitch and the one before it) cannot be sewn neatly before thread trimming.	<ul style="list-style-type: none"> Use the T/T short parameters to increase the stitch pitch. Use the T/T short parameters to reduce the sewing speed. 	24* (65-15)
18	Thread trailing length on underside of material is too long.	<ul style="list-style-type: none"> Turn on the T/T short function. <p>If you would like the trailing length to be even sorter after turning on the T/T short function.</p> <ul style="list-style-type: none"> Is the meshing position of the thread trimming knives directly below the needle hole? Use the T/T short parameters to reduce the stitch pitch of the condense stitches (the final stitch and the one before it) before thread trimming. Use the T/T short parameters to reduce the pitch during thread trimming. 	32* 55* 24* (65-15)
19	When T/T short is on, thread trailing length on underside of material is too short.	<ul style="list-style-type: none"> Use the T/T short parameters to increase the pitch during thread trimming. 	24* (65-15)
20	To prevent fraying at the sewing end	<ul style="list-style-type: none"> Turn on T/T short processing, and then use the T/T short parameters to set the feed direction for sewing end processing to "bw". 	24* (65-15)
21	Incorrect thread trimming (Upper and lower threads are both not being trimmed)	<ul style="list-style-type: none"> Is the fixed knife or movable knife damaged or worn? Replace the fixed knife or the movable knife. Is there not enough of a meshing amount between the upper knife and the lower knife? Adjust the tip of the upper knife to the lower knife index position so that the knives mesh. 	55*

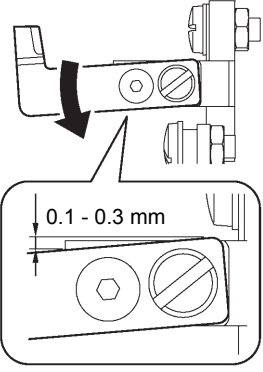
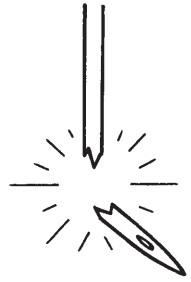
	Problem	Possible cause	Page
22	<p>Incorrect thread trimming (Upper thread is not being trimmed.) (Lower thread is not being trimmed.)</p>  <p>0949D</p>	<ul style="list-style-type: none"> • Is the needle properly installed? If it is incorrect, install the needle correctly. • Is the fixed knife or movable knife blunt? Replace the fixed knife or the movable knife. • Tilt the upper knife forward slightly. (About 0.1 to 0.3 mm) • Is there not enough of a meshing amount between the upper knife and the lower knife? Check that the tip of the upper knife comes to the lower knife index position so that the knives mesh. 	55*
23	<p>Broken needle</p>  <p>0469M</p>	<ul style="list-style-type: none"> • Is the material being pushed or pulled with excessive force during sewing? • Is the needle properly installed? If it is incorrect, install the needle correctly. • Is the needle tip bent? Is the needle tip broken, or is the needle hole blocked? Replace the needle. • Is the needle and rotary hook timing correct? Adjust the height of the needle bar. Adjust the clearance between the needle and the tip of the rotary hook. • Is the needle and feed mechanism timing correct? Adjust to the standard timing. • Try pressing the special locus key and selecting No. 2 or No. 3. <p>NOTE</p> <ul style="list-style-type: none"> • It is extremely dangerous to leave any pieces of broken needle sticking in the material. If the needle breaks, search for all pieces until the whole of the needle is found again. • Furthermore, we recommend that thorough steps be taken to account for such needles to comply with product liability regulations. 	53* * 52* 23

7. TROUBLESHOOTING

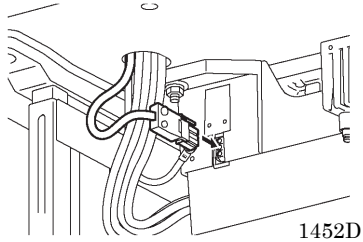
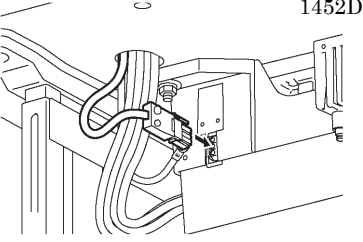
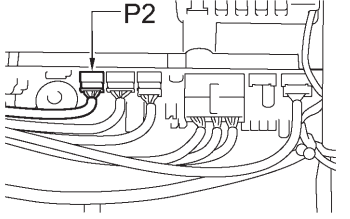
	Problem	Possible cause	Page
24	Machine does not operate when power is turned on and treadle is pressed.	<ul style="list-style-type: none"> • Is the power supply connector disconnected from the control box? Insert the connectors securely.  <p style="text-align: right;">1452D</p>	11 · 12
25	Machine does not operate at high speed.	<ul style="list-style-type: none"> • Is the sewing speed setting or backtack stitch speed setting too slow? Set a higher sewing speed. 	18 · 19
26	Machine stops during sewing.	<ul style="list-style-type: none"> • Is the power supply voltage too low? Check the power supply voltage. (If the power cord is too long or too many appliances are being run from a single outlet, this may cause voltage drops which will in turn cause the reset function to activate and stop the machine, even if the power supply itself is normal.) 	*
27	Nothing appears on the operation panel display.	<ul style="list-style-type: none"> • Is the power supply connector disconnected from the control box? Insert the connectors securely.  <p style="text-align: right;">1452D</p> <ul style="list-style-type: none"> • Is the operation panel connector inside the control box disconnected? Insert the connectors securely.  <p style="text-align: right;">1453D</p>	11 · 12 7
28	The illumination becomes momentarily darker or flickers.	<ul style="list-style-type: none"> • The illumination may become momentarily darker or flicker when the sewing machine starts or stops, depending on the power supply in the environment where the sewing machine is being used. This is not a sign of a malfunction. 	*

7-2. Error code displays

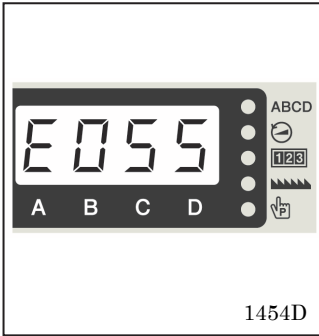

If an error code appears on the operation panel display

1. Make a note of the error code and then turn off the power.
2. After the operation panel display has turned off, eliminate the cause of the error and then turn the power back on.

- Items with a "*" in the "Page" column should only be checked by a qualified technician.
- For items with "*" appearing in the "Page" column, ask the place of purchase for advice.

<Connector layout diagram>

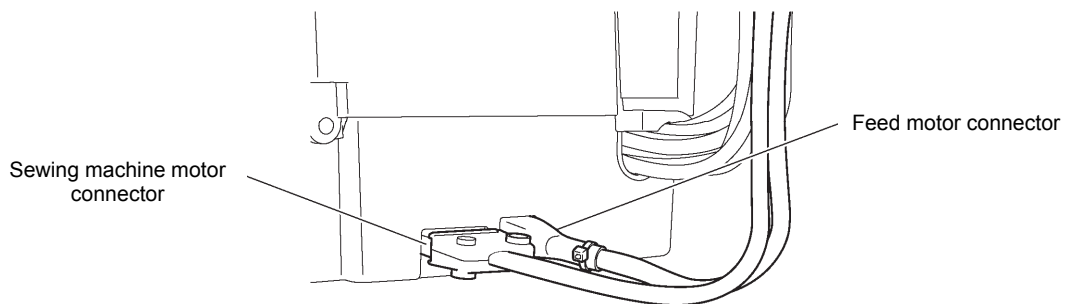
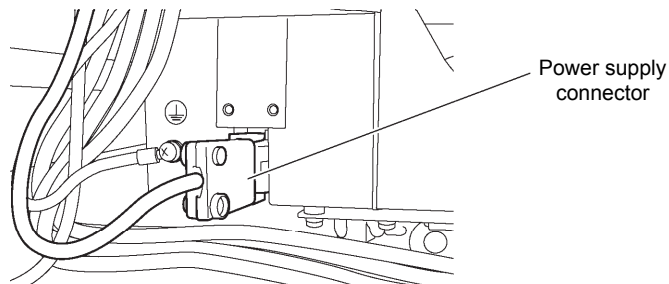
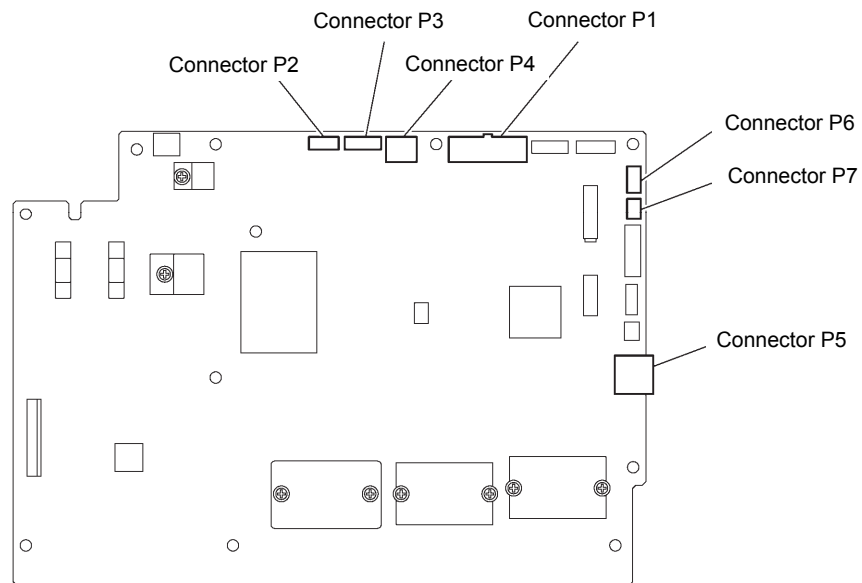

1451D

7. TROUBLESHOOTING

Switch-related errors

Code	Cause	Remedy
E050	Machine head is detected as being tilted back when start sewing.	<ul style="list-style-type: none"> • Turn off the power, and then return the machine head to its original position. • Turn off the power and check the connection of connector P2.
E051	Machine head is detected as being tilted back during sewing.	Turn off the power and check the connection of connector P2.
E055	Machine head is detected as being tilted back when power was turned on.	<ul style="list-style-type: none"> • Turn off the power, and then return the machine head to its original position. • Turn off the power and check the connection of connector P2.
E065	A disabled key was being pressed when the power was turned on.	Turn the power off and then back on again. * Do not press a disabled key while turning on the power.
E066	The hand switch was being pressed when the power was turned on.	Turn the power off and then back on again. * Do not press the hand switch when turning on the power.
E090	Connection of treadle was not detected when power was turned on.	Turn off the power and check the connection of connector P7.
E095	Treadle or standing operation pedal was being pressed when power was turned on.	Return treadle unit or standing up operation pedal to original portion. * Do not press the treadle or the standing operation pedal when turning on the power.

Sewing machine motor-related errors

Code	Cause	Remedy
E111	The needle up stop position exceeded the specified value when the sewing machine motor stopped.	Turn off the power and check if the sewing machine motor or thread trimming mechanism is stiff or not.
E112	The needle up or needle down stop position did not reach the specified value when the sewing machine motor stopped.	Turn off the power and check if the sewing machine motor or thread trimming mechanism is stiff or not.
E113	The needle down stop position exceeded the specified value when the sewing machine motor stopped.	Turn off the power and check if the sewing machine motor or thread trimming mechanism is stiff or not.
E130	Sewing machine motor did not operate at sewing start or during sewing.	<ul style="list-style-type: none"> • Turn off the power and check if the sewing machine motor is stiff or not. • Turn off the power and check the connections of the sewing machine motor connector and connector P4.
E131	Sewing machine motor encoder connection was not detected when power was turned on.	Turn off the power and check the connection of connector P4.
E132	Abnormal sewing speed of sewing machine motor was detected during sewing.	Turn off the power and check the connection of connector P4.
E133	Abnormal signal of sewing machine motor encoder was detected during sewing.	Turn off the power and check the connection of connector P4.
E140	Sewing machine motor ran in opposite direction to the direction specified during sewing.	Turn off the power and check the connection of connector P4.
E150	Abnormal overheating detected in sewing machine motor.	Turn off the power and check the sewing conditions.
E151	Motor overheating sensor connection was not detected.	Turn off the power and check the connection of connector P4.
E161	Sewing machine motor overload was detected during sewing.	Turn off the power and check the sewing conditions.
E190	Sewing machine motor was running continuously for too long during sewing.	Turn the power off and then back on again.
E191	Thread trimming solenoid operation was not completed within the specified period.	Turn off power and check if the thread trimming mechanism is stiff.

Feed mechanism-related errors

Code	Cause	Remedy
E210	Feed motor origin is not detected when power is turned on.	<ul style="list-style-type: none"> • Turn off the power and check that the feed mechanism is not abnormal. • Turn off the power and check the feed motor connector and connector P3.
E211	Abnormal feed motor operation detected during sewing.	<ul style="list-style-type: none"> • Turn off the power and check that the feed mechanism is not abnormal. • Turn off the power and check the feed motor connector and connector P3.
E251	Abnormal feed motor overheating detected or feed motor overheating sensor was not detected.	<ul style="list-style-type: none"> • Turn off the power and check the sewing conditions. • Turn off the power and check the connection of connector P3.

Communication and memory-related errors

Code	Cause	Remedy
E410	Communication error with panel occurred when power was turned on.	Turn off the power and check the connection of connector P2.
E440	Data could not be written to the backup memory (main internal P.C. board).	Turn the power off and then back on again.
E441	Data could not be read from the backup memory (main internal P.C. board).	Turn the power off and then back on again.
E442	Back up memory (main internal P.C. board) data was abnormal, so settings were initialized.	Turn the power off and then back on again.
E450	Model settings could not be read from machine head memory (internal panel).	Turn the power off and then back on again.
E451	Data backup cannot be written to machine head memory (internal panel).	Turn the power off and then back on again.

P.C. board-related errors

Code	Cause	Remedy
E700	Abnormal rise in power supply voltage was detected when power was turned on.	Turn off the power and check the power supply voltage.
E701	Abnormal rise in sewing machine motor power supply voltage was detected.	<ul style="list-style-type: none"> • Turn off the power and check the power supply voltage. • Turn off the power and check the connection of connector P5.
E705	Abnormal drop in power supply voltage was detected.	Turn off the power and check the power supply voltage.
E709	Power supply signal could not be detected when power was turned on.	Turn the power off and then back on again.
E710	Abnormal sewing machine motor current was detected.	Turn off the power and check the connection of connector P4.
E711	Abnormal feed motor current was detected.	Turn off the power and check the connection of connector P3.
E791	Abnormal solenoid mechanism current detected when solenoid was activated.	Turn off the power and check the connection of connector P1.





































7. TROUBLESHOOTING

Version updating errors

Code	Cause	Remedy
E882	No USB media connected when power was turned on.	Turn off the power and check the connection of the USB media.
E883	Version update file could not be detected in USB media when power was turned on.	Turn off the power and then check that the version update file is contained in the USB media.
E884	Problem with version update file detected during version updating.	Turn off the power, and then repeat the version update procedure.
E885	Version update file could not be read from USB media during version updating.	Turn off the power and check the connection of the USB media.
E886	Problem with version update file detected during version updating.	Turn off the power, and then repeat the version update procedure.
E887	Version update file could not be written during version updating.	Turn off the power, and then repeat the version update procedure.
E889	Incorrect data written to flash memory.	Turn off the power, and then repeat the version update procedure.
E890	Error occurred during version update.	Turn off the power, and then repeat the version update procedure.

If an error code that is not listed above appears or if carrying out the specified remedy does not solve the problem, contact the place of purchase.

8. 7-SEGMENT DISPLAY

0	1	2	3	4	5	6	7	8	9
									
A	B	C	D	E	F	G	H	I	J
									
K	L	M	N	O	P	Q	R	S	T
									
U	V	W	X	Y	Z				
									

brother



INSTRUCTION MANUAL

* Please note that the contents of this manual may differ slightly from the actual product purchased as a result of product improvements.

BROTHER INDUSTRIES, LTD. <http://www.brother.com/>
1-5, Kitajizoyama, Noda-cho, Kariya 448-0803, Japan. Phone : 81-566-95-0088

© 2017 Brother Industries, Ltd. All Rights Reserved.
This is the original instructions.

S-7250A
I7081169D E
2017.09.D(3)

Free Manuals Download Website

<http://myh66.com>

<http://usermanuals.us>

<http://www.somanuals.com>

<http://www.4manuals.cc>

<http://www.manual-lib.com>

<http://www.404manual.com>

<http://www.luxmanual.com>

<http://aubethermostatmanual.com>

Golf course search by state

<http://golfingnear.com>

Email search by domain

<http://emailbydomain.com>

Auto manuals search

<http://auto.somanuals.com>

TV manuals search

<http://tv.somanuals.com>