



Quick Reference Guide

TD-2020 TD-2120N TD-2130N

Thank you for purchasing the Brother TD-2020/2120N/2130N. The TD-2020/2120N/2130N (hereafter referred to as "the printer") is a powered desktop thermal printer. Be sure to read the User's Guide (CD-ROM), Product Safety Guide (Printed), Quick Reference Guide (this manual), Software User's Guide (CD-ROM) and Network User's Guide (CD-ROM:TD-2120N/2130N only) before using the printer. We suggest that you keep these documents in a handy place for future reference. To download the latest manuals, please visit the Brother Solutions Center at <http://support.brother.com>, where you can also download the latest drivers and utilities for your printer, get product support and answers to frequently asked questions (FAQs). Options cannot be used with the TD-2020. Options can be used with the TD-2120N/2130N. For details, refer to the User's Guide.

Printed in China
ENG
LBC306001A



Unpacking the TD-2020/2120N/2130N

Check that the package contains the following before using the printer. If any item is missing or damaged, contact your Brother reseller.

- Printer

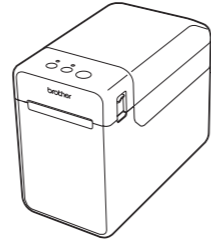

- AC adapter

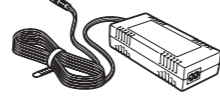

- AC power cord



- USB cable

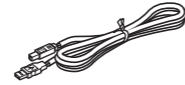

- CD-ROM



- Product Safety Guide



- Quick Reference Guide

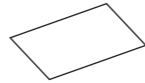

Installing the Printer Driver and Software

The screenshot shown below may differ slightly from that of the actual product.

NOTE

If you are using Windows® 8, make sure that Adobe® Reader® is the default program for opening PDF files and that Internet Explorer is the default web browser.

- 1 Insert the installer CD-ROM into your CD-ROM drive. If the language screen appears, choose your language.
- 2 Click **[Standard Installation]**.
 - You can refer to the User's Guide by clicking **[User's Guides]**.

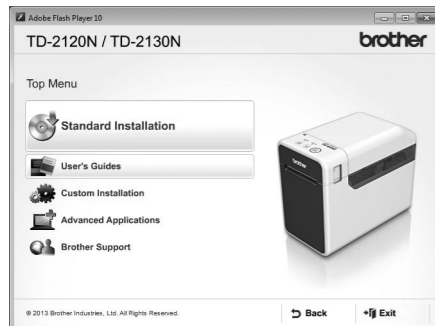

- 3 Read the licence agreement, and click **[Agree]** if you agree to the terms and conditions.
- 4 Click **[Install]** to start the installation, and follow the on-screen instructions to complete the Standard Installation.

For details, see the User's Guide on the CD-ROM.

Inserting the RD Roll

- 1 Press and hold the **(Power)** button to turn the printer off. Press the cover release lever (1) on either side and lift up to open the RD Roll compartment top cover. Open the media guides by lifting up the media guide adjustment lever (2) and pulling the media guide outwards.

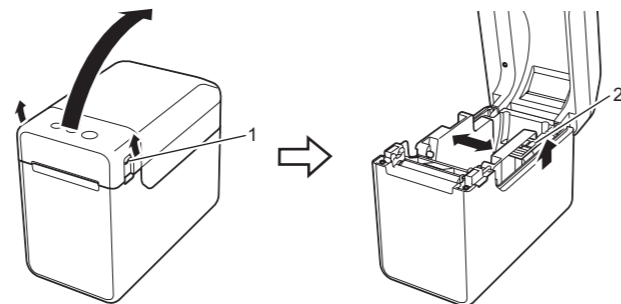

- 2 Insert the RD Roll so that the labels feed with the side to be printed on facing up (1), as shown.

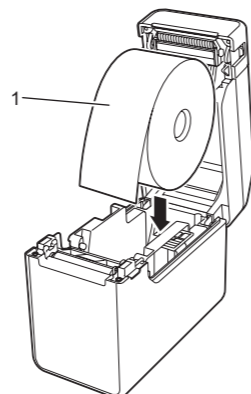

General Description

- Front

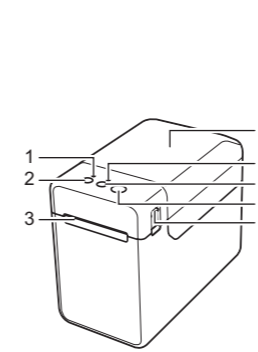

- Back

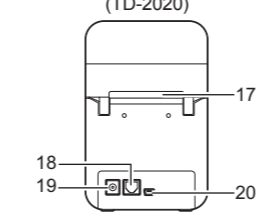

- 1 POWER indicator
- 2 (Power) button
- 3 Media exit
- 4 RD Roll compartment top cover
- 5 STATUS indicator
- 6 (Feed) button
- 7 (Print) button
- 8 Cover release lever
- 9 Tear bar

NOTE: Before using the printer, remove the cover over the tear bar. Do not dispose of the removed cover. In order to avoid injuries when the printer is not being used, attach the cover to the tear bar.

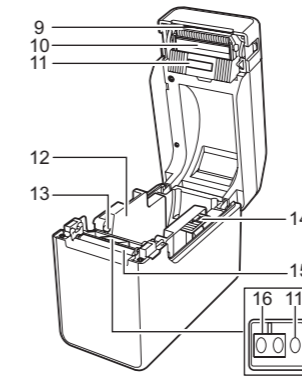

- 10 Print head
- 11 Transmissive/gap sensor
- 12 Media guide
- 13 Media tip guide
- 14 Media guide adjustment lever
- 15 Platen roller
- 16 Reflective/black mark sensor
- 17 External media feed slot
- 18 Serial port
- 19 Power connector
- 20 Mini-USB port
- 21 USB host port (TD-2120N/2130N only)
- 22 Ethernet network port (TD-2120N/2130N only)

Inserting the RD Roll (continued)

- 3 While lifting up the media guide adjustment lever (1), push in both the media guides (2) to fit the width of the paper. Feed the end of the RD Roll under the media tip guides (3).

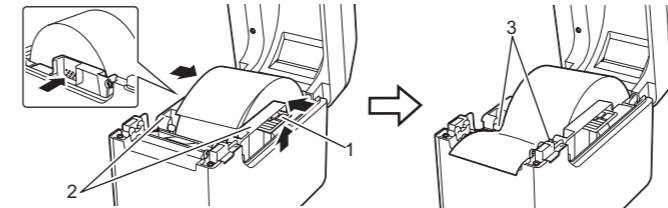

- 4 Position the end of the paper centred over the platen roller and slightly out of the media exit.
- 5 Close the RD Roll compartment top cover by pressing down on the centre, until it clicks into place. Press the **(Power)** button to turn the printer on.

After loading the paper, check that the transmissive/gap sensor and triangle on the printer are aligned, or if there is a black mark on the paper, check that the black mark is aligned with the centre line of the reflective/black mark sensor.

Printing

- 1 Install the printer driver and the software.
- 2 Check that the printer has the correct power source. (Make sure that the AC adapter is connected to an AC power socket or that a fully charged rechargeable Li-ion battery is installed.)
- 3 Turn on the printer. The POWER indicator lights in green.
- 4 Connect the printer to a computer.
- 5 Insert the RD Roll.
- 6 Print receipts or labels.
- 7 Hold one edge of the ejected media and pull it up and diagonally toward the other edge.

For details, see the User's Guide on the CD-ROM.

Connecting the Printer to an AC Power Socket

Connect the AC adapter to the printer, and then plug the AC power cord into an AC power socket to power the printer.

- 1 Connect the AC adapter to the printer.
- 2 Connect the AC power cord to the AC adapter.
- 3 Connect the AC power cord to a nearby AC power socket (100 - 240 V, 50 - 60 Hz).

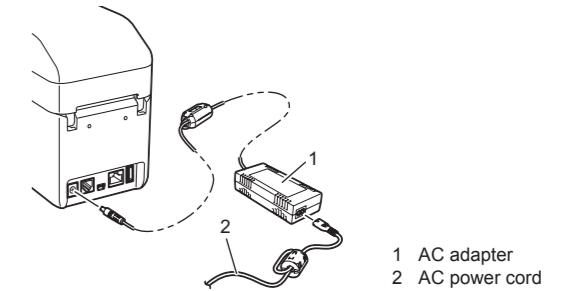

Printing the Printer Setup Information

You can use the **(Print)** button to print a report that lists the following printer settings:

- Program version
- Printer usage history
- Missing dot test pattern
- List of transferred data
- Communication settings

NOTE

- You can use **[Device settings]** of "Printer Setting Tool" to set, in advance, which items will be printed.
- The node name will also appear in the communication settings. The default node name is "BRWxxxxxxxxxxxx". ("xxxxxxxxxxxx" is based on your printer's MAC address/Ethernet address.)

- 1 Make sure that a roll of 58mm receipt paper has been loaded, and the RD Roll compartment top cover is closed.
- 2 Turn on the printer.
- 3 Hold down (for at least 1 second) the **(Print)** button until the POWER indicator starts blinking in green and the printer setup information is printed.

NOTE

- For printing the printer setup information, we recommend using 58mm receipt paper. The length required for printing differs depending on the information to be printed.
- The printer setup information can also be printed from **[Device settings]** of "Printer Setting Tool".

For details, see the User's Guide on the CD-ROM.

Troubleshooting

<p>The POWER indicator is not lit.</p> <ul style="list-style-type: none"> Is the AC power cord inserted correctly? Check that the AC power cord is inserted correctly. If it is, try plugging it into another AC power socket. Be sure to use a genuine Brother AC adapter. Is the rechargeable Li-ion battery (optional) installed correctly? If the rechargeable Li-ion battery (optional) is being used, check that it is installed correctly. If the POWER indicator still does not light up, contact Brother customer service.
<p>The indicators show that the printer is in boot mode.</p> <ul style="list-style-type: none"> The AC adapter was unplugged while the firmware was being updated, and the printer started up in boot mode the next time it was started. This issue must be resolved. Contact your reseller or Brother customer service for assistance.
<p>The indicators show that the printer is cooling.</p> <ul style="list-style-type: none"> The print head or motor is too hot. <p>Print head: If the print head becomes too hot, it may produce imaging on the paper in areas not intended to be printed. This condition is normal when printing a large number of documents with a high print density. The printer will stop, then resume printing after the print head has cooled down. To avoid or delay the onset of this condition, print using a lighter density setting, reduce the amount of black areas being printed (for example, remove background shading and colours in graphs and presentation documents). Also, make sure that the printer has adequate ventilation and is not located in an enclosed space.</p> <p>Motor: If the printer is used continuously, the motor will become too hot. In this case, the printer will stop and resume printing after the motor has cooled down. NOTE: This condition may occur more often when the printer is used at a high altitude (above 3,048 m (10,000 feet)) due to the lower air density available to cool the printer.</p>
<p>The indicators show that a system error has occurred.</p> <p>If this condition occurs, turn off the printer, and then contact your reseller or Brother customer service.</p>
<p>The printer does not print.</p> <ul style="list-style-type: none"> Is a cable loose? Check that the cables are connected securely. Is the STATUS indicator blinking? An error occurred. Check the error details in "Indicators" below, and then see "If the STATUS indicator was blinking in red".
<p>Media is not fed correctly.</p> <ul style="list-style-type: none"> Is the print head or platen roller dirty? Although the print head generally remains clean under normal use, dust or dirt from the platen roller may become stuck to the print head. If this occurs, clean the print head or platen roller. Are the sensors in the correct position? Check that the sensors are correctly positioned. Has the paper size information been registered with the printer? If the paper size information has not been registered with the printer, the media will not be fed correctly.

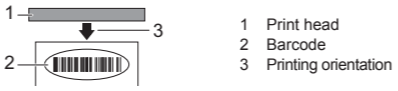
<p>A data transmission error appears on your computer.</p> <ul style="list-style-type: none"> Is the correct port selected? Check that the correct port is selected. Is the printer in cooling mode (the POWER indicator is blinking in orange)? Wait until the indicator stops blinking, and then try printing again. Is someone printing via the network? If you try to print while other users are printing large amounts of data, the printer will be unable to accept your print job until the ongoing printing is finished. In such a situation, execute the print job again after the other jobs are completed.
<p>Media is jammed / Media is not ejected correctly after printing.</p> <ul style="list-style-type: none"> Is there dust or dirt on the platen roller preventing it from turning freely? Check that the media exit path is not blocked. Is there adhesive on the media exit, or has a media misfeed occurred? Remove the RD Roll, and then reinstall it. Check that the RD Roll compartment top cover is firmly closed. If the label peeler (optional) is being used, check that printer driver settings for the Peeler function have been specified correctly.
<p>The print quality is poor / Printed labels contain white streaks.</p> <ul style="list-style-type: none"> Adjust the printing density. The print density can be specified in the printer driver's dialog box or "Printer Setting Tool". Is there dust or dirt on the print head or platen roller preventing it from turning freely? Clean the print head or platen roller.
<p>Printed barcodes cannot be read.</p> <ul style="list-style-type: none"> Print labels so that barcodes are aligned with the print head as shown below. <div style="display: flex; align-items: center; justify-content: center;">  </div> <ul style="list-style-type: none"> Try using another scanner. We recommend printing the barcodes with [Give priority to quality] selected from the [Quality] options.
<p>I want to reset the printer/delete the data transferred from the computer.</p> <p>To reset the printer, perform the following procedure.</p> <ol style="list-style-type: none"> Press and hold the (Power) button to turn the printer off. Press and hold the (Feed) button and the (Power) button until the POWER, indicator lights in orange and the STATUS indicator blinks in green. While holding down the (Power) button, press the (Feed) button 6 times. Release the (Power) button. <p>All the transferred data from the computer will be deleted, and the printer will be reset to its factory settings.</p>
<p>I want to cancel the current print job.</p> <p>Make sure that this printer is turned on, and then press the (Power) button.</p>

<p>I want to reset the incrementing field.</p> <p>Hold down the (Print) button for at least 5 seconds, until the POWER and STATUS indicators blink 3 times in orange.</p>
<p>The media cannot be fed to the beginning of a label / An error occurred.</p> <ul style="list-style-type: none"> If a feed error occurred, use the Custom Label Tool to apply the correct paper settings to the printer. Are the sensors in the correct position? Check that the sensors are correctly positioned.
<p>Even though data is being sent to the printer, the POWER indicator is not blinking in green.</p> <p>Make sure that the USB cable is connected firmly and correctly. Try using another USB cable. If a connection is being made using the WLAN interface (optional) or Bluetooth interface (optional), check that the slide switch for each unit has been turned on.</p>
<p>The labels are not being peeled off correctly (when using the optional label peeler).</p> <ul style="list-style-type: none"> Make sure that the paper is correctly fed through the label peeler. Has the peeler option setting been specified in the printer driver and "Printer Setting Tool"?
<p>The media is not ejected correctly (when using the optional label peeler).</p> <p>Has the sensor of the label peeler been exposed to direct sunlight? If the sensor of the label peeler has been exposed to direct sunlight, loaded media may not be detected correctly. Use the printer in a location not exposed to direct sunlight.</p>
<p>The printer does not operate according to the operations performed with the touch panel display (when using the optional touch panel display).</p> <ul style="list-style-type: none"> Does the touch panel name (A or B) printed in the upper-right corner of the touch panel match the specified touch panel name, which appears in the lower-right corner of the main screen on the LCD? If they do not match, select [Set Panel] from the touch panel display, and then select the correct setting. Has the type of data assigned to one-touch keys been correctly specified? If the correct setting has not been selected, select [Keys Function] from the touch panel display, and then correctly select [Template] or [Database].
<p>Although no key in the touch panel display was pressed, data was unintentionally entered (when using the optional touch panel display)./The data that was entered is different than the data for the touch panel key that was pressed (when using the optional touch panel display).</p> <ul style="list-style-type: none"> Since foreign material, such as dust, caught between the touch panel, protective sheet and touch panel holder may cause a malfunction. Make sure that no foreign material is attached. Has the touch panel been folded? When a folded touch panel is used, the fold may press on the touch panel holder. Therefore, do not use a touch panel that has been folded.

If the STATUS indicator was blinking in red

If the STATUS indicator was blinking in red, perform the following procedures to clear the error.





Press the (Power) button once.

If the error is still not cleared, turn the printer off, then on again.



















If the error appears, even after performing the procedures described above, contact Brother customer service.















<p>The STATUS indicator is blinking.</p> <ul style="list-style-type: none"> An error occurred. Check the error details in "Indicators", and then see below.
<p>The indicators show that error 1 has occurred.</p> <ul style="list-style-type: none"> Is the correct RD Roll installed? Check that the correct media, for example, type (die-cut label or continuous length tape) and die-cut label size, is installed. Is the RD Roll installed correctly? If not, remove the RD Roll, and then reinstall it. Are the media guides not touching the side of the RD Roll? Move the media guides against the side of the RD Roll. Is there enough of the roll remaining? If not, install a new RD Roll. Is the RD Roll compartment top cover open? Check that the RD Roll compartment top cover is closed. After the specified length of time (120 seconds) has passed, either the access point could not be found or two or more access points were found. Otherwise, the received packet is incorrect (when using the optional WLAN interface). If the error still occurs, check for the following: Tape exceeding 1 m or incompatible files cannot be printed. When sending a template as a BLF file, an error is indicated if the model name in the file is different. When printing a template, an error is indicated if the specified template does not exist. An error is indicated if the search of a template with a linked database fails. An error is indicated if data is transferred, causing the capacity of the user storage area to be exceeded. In these cases, turn off the printer, and then turn it on again. If the error still occurs, contact Brother customer service.
<p>The indicators show that error 2 has occurred.</p> <ul style="list-style-type: none"> Has a device been connected that is not supported by the USB host port? An overcurrent was detected by the USB host port, or the connection of an unsupported device was detected. Turn off the printer, and then check the connected device. If a USB hub is connected, the printer will automatically turn off after a certain length of time has passed. Is the printer in mass storage mode? An error is indicated if the file system becomes corrupted or a file is copied while a mass storage file is being processed. Turn off the printer. Does the rechargeable battery have a low charge? (when using the optional rechargeable Li-ion battery). Use the AC adapter. Has the rechargeable battery failed to recharge? (when using the optional rechargeable Li-ion battery). If the battery has not been recharged after a certain length of time, recharging has failed. Use the AC adapter. Has the wireless LAN or Bluetooth connection been interrupted? (when using the optional WLAN or Bluetooth interfaces). The wireless LAN or Bluetooth connection established while the printer is on was interrupted. Turn off the printer, check that the slide switch for the WLAN interface or Bluetooth interface has been turned on, and then turn the printer on again.

Indicators

-  = Indicator is lit
 -  = Indicator is blinking
 -  = Indicator blinks 1 or 3 times, then turns off
 -  = Indicator is lit or blinking in any colour or pattern
 - (off) = Indicator is off
- G = Green
O = Orange
R = Red

Example:  = Indicator is blinking in green

POWER	STATUS	Description
		Printer turned on Initialising
		RD Roll compartment top cover open
		Receiving data Transferring/importing data
		Now cooling
		Resetting the incrementing field
		Initialising complete
		Error 1 See "Troubleshooting" above.
		Error 2 See "Troubleshooting" above.
		System error
	(off)	In boot mode

POWER	STATUS	Description
		Now resetting
		In mass storage mode
		Processing file in mass storage mode
		<ul style="list-style-type: none"> Wireless LAN on and connected* (when using the optional WLAN interface) Bluetooth on* (when using the optional Bluetooth interface) USB host port connected to a supported device
		Wireless LAN on but not connected* (when using the optional WLAN interface)
		Now setting WPS* (when using the optional WLAN interface)
		Bluetooth switched* (when using the optional Bluetooth interface)

*TD-2120N/2130N only

Internet Addresses

Brother Global website: <http://www.brother.com>

Brother Developer Center: <http://www.brother.com/product/dev/>

For Frequently Asked Questions (FAQs), Product Support and Technical Questions, and Driver Updates and Utilities: <http://support.brother.com>

Maintaining the Printer

Maintenance of the printer may be carried out as required. However, some environments require that maintenance must be done more frequently (for example, in dusty conditions). If dirt or dust is not removed, the printed labels may contain white streaks, or media may become jammed.

Print Head Maintenance

Use a dry cotton swab to wipe the print head (1).

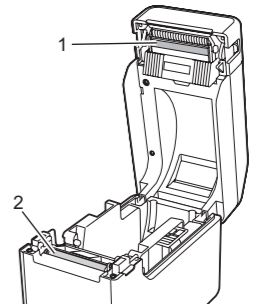

Platen Roller Maintenance

Use a piece of cellophane tape to remove dirt from the platen roller (2).

Media Exit Maintenance

If adhesive accumulates at the media exit (3) and media becomes jammed, disconnect the printer from the AC power socket, and then clean the media exit with a cloth slightly moistened with isopropyl alcohol.

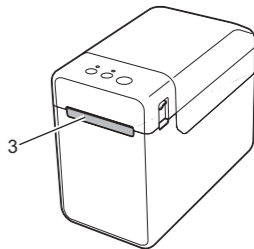

Free Manuals Download Website

<http://myh66.com>

<http://usermanuals.us>

<http://www.somanuals.com>

<http://www.4manuals.cc>

<http://www.manual-lib.com>

<http://www.404manual.com>

<http://www.luxmanual.com>

<http://aubethermostatmanual.com>

Golf course search by state

<http://golfingnear.com>

Email search by domain

<http://emailbydomain.com>

Auto manuals search

<http://auto.somanuals.com>

TV manuals search

<http://tv.somanuals.com>