

Canon

DVD Camcorder
Instruction Manual

Caméscope DVD
Manuel d'instruction

Videocámara DVD
Manual de Instrucciones

PUB. DIM-890

DC410

DC420

•

•

English

Français

Español



NTSC

PictBridge

DC420

Important Usage Instructions

WARNING!



TO REDUCE THE RISK OF FIRE OR ELECTRIC SHOCK, DO NOT EXPOSE THIS PRODUCT TO RAIN OR MOISTURE.

WARNING!



TO REDUCE THE RISK OF ELECTRIC SHOCK AND TO REDUCE ANNOYING INTERFERENCE, USE THE RECOMMENDED ACCESSORIES ONLY.

COPYRIGHT WARNING:

Unauthorized recording of copyrighted materials may infringe on the rights of copyright owners and be contrary to copyright laws.

DVD Camcorder, DC420 A/DC410 A systems

This device complies with Part 15 of the FCC Rules. Operation is subject to the following two conditions: (1) This device may not cause harmful interference, and (2) this device must accept any interference received, including interference that may cause undesired operation.

Note: This equipment has been tested and found to comply with the limits for class B digital device, pursuant to Part 15 of the FCC Rules. These limits are designed to provide reasonable protection against harmful interference in a residential installation. This equipment generates, uses and can radiate radio frequency energy and, if not installed and use in accordance with the instructions, may cause harmful interference to radio communications. However, there is no guarantee that interference will not occur in a particular installation. If this equipment does cause harmful interference to radio or television reception, which can be determined by turning the equipment off and on, the user is encouraged to try to correct the interference by one or more of the following measures:

- Reorient or relocate the receiving antenna.
- Increase the separation between the equipment and receiver.
- Connect the equipment into an outlet on a circuit different from that to which the receiver is connected.
- Consult the dealer or an experienced radio/TV technician for help.

The cable with the ferrite core provided with the digital video camcorder must be used with this equipment in order to comply with Class B limits in Subpart B of Part 15 of the FCC rules.

Do not make any changes or modifications to the equipment unless otherwise specified in the manual.

If such changes or modifications should be made, you could be required to stop operation of the equipment.

Canon U.S.A. Inc.

One Canon Plaza, Lake Success, NY 11042, U.S.A.

Tel No. (516)328-5600

CAUTION:

TO PREVENT ELECTRIC SHOCK, MATCH WIDE BLADE OF PLUG TO WIDE SLOT, FULLY INSERT.

The Mains plug is used as the disconnect device. The Mains plug shall remain readily operable to disconnect the plug in case of an accident.

Important Warning



The lightning flash with arrowhead symbol, within an equilateral triangle, is intended to alert the user to the presence of uninsulated "dangerous voltage" within the product's enclosure, that may be of sufficient magnitude to constitute a risk of electric shock to persons.

CAUTION:

TO REDUCE THE RISK OF ELECTRIC SHOCK, DO NOT REMOVE COVER (OR BACK). NO USER-SERVICEABLE PARTS INSIDE. REFER SERVICING TO QUALIFIED SERVICE PERSONNEL.



The exclamation point, within an equilateral triangle, is intended to alert the user to the presence of important operating and maintenance (servicing) instructions in the literature accompanying the product.

IMPORTANT SAFETY INSTRUCTIONS

In these safety instructions the word “product” refers to the Canon DVD Camcorder DC420 A/DC410 A and all its accessories.

- 1 Read these instructions.
- 2 Keep these instructions.
- 3 Heed all warnings.
- 4 Follow all instructions.
- 5 Do not use this apparatus near water.
- 6 Clean only with dry cloth.
- 7 Do not install near any heat sources such as radiators, heat registers, stoves, or other apparatus (including amplifiers) that produce heat.
- 8 Do not defeat the safety purpose of the polarized or grounding-type plug. A polarized plug has two blades with one wider than the other. A grounding type plug has two blades and a third grounding prong. The wide blade or the third prong are provided for your safety. If the provided plug does not fit into your outlet, consult an electrician for replacement of the obsolete outlet.
- 9 Protect the power cord from being walked on or pinched particularly at plugs, convenience receptacles, and the point where they exit from the apparatus.
- 10 Only use attachments/accessories specified by the manufacturer.
- 11 Unplug this apparatus during lightning storms or when unused for long periods of time.
- 12 Refer all servicing to qualified service personnel. Servicing is required when the apparatus has been damaged in any way, such as power-supply cord or plug is damaged, liquid has been spilled or objects have fallen into the apparatus, the apparatus has been exposed to rain or moisture, does not operate normally, or has been dropped.
- 13 Read Instructions — All the safety and operating instructions should be read before the product is operated.
- 14 Retain Instructions — The safety and operating instructions should be retained for future reference.
- 15 Heed Warnings — All warnings on the product and in the operating instructions should be adhered to.
- 16 Follow Instructions — All operating and maintenance instructions should be followed.
- 17 Cleaning — Unplug this product from the wall outlet before cleaning. Do not use liquid or aerosol cleaners. The product should be cleaned only as recommended in this manual.
- 18 Accessories — Do not use accessories not recommended in this manual as they may be hazardous.
- 19 Avoid magnetic or electric fields — Do not use the camera close to TV transmitters, portable communication devices or other sources of electric or magnetic radiation. They may cause picture interference, or permanently damage the camera.
- 20 Water and Moisture — Hazard of electric shock — Do not use this product near water or in rainy/moist situations.
- 21 Placing or Moving — Do not place on an unstable cart, stand, tripod, bracket or table. The product may fall, causing serious injury to a child or adult, and serious damage to the product. A product and cart combination should be moved with care. Quick stops, excessive force, and uneven surfaces may cause the product and cart combination to overturn.
- 22 Power Sources — The CA-570 Compact Power Adapter should be operated only from the type of power source indicated on the marking label. If you are not sure of the type of power supply to your home, consult your product dealer or local power company. Regarding other power sources such as battery power, refer to instructions in this manual.
- 23 Polarization — The CA-570 Compact Power Adapter is equipped with a polarized 2-prong plug (a plug having one blade wider than the other).
The 2-prong polarized plug will fit into the power outlet only one way. This is a safety feature. If you are unable to insert the plug fully into the outlet, try reversing the plug. If the plug still fails to fit, contact your electrician to replace your obsolete outlet. Do not defeat the safety purpose of the polarized plug.
- 24 Power Cord Protection — Power cords should be routed so that they are not likely to be walked on or pinched by items placed upon or against them. Pay particular attention to plugs and the point from which the cords exit the product.



- 25 Outdoor Antenna Grounding** — If an outside antenna is connected to the product, be sure the antenna is grounded so as to provide some protection against voltage surges and built-up static charges. Section 810 of the National Electrical Code, ANSI / NFPA No. 70—1984, provides information with respect to proper grounding of the mast and supporting structure, grounding of the lead-in wire to an antenna discharge unit, size of grounding conductors, location of antenna discharge unit, connection to grounding electrodes, and requirements for the grounding electrode. See figure 1.

Fig. 1 EXAMPLE OF ANTENNA GROUNDING AS PER NATIONAL ELECTRICAL CODE

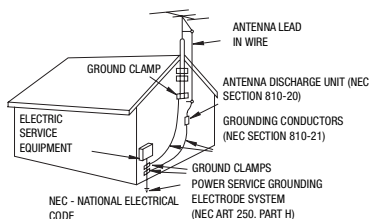

- 26 Lightning** — For added protection of this product during a lightning storm, or when it is left unattended and unused for long periods of time, disconnect it from the wall outlet and disconnect the antenna. This will prevent damage to the product due to lightning and power-line surges.
- 27 Overloading** — Do not overload wall outlets and extension cords as this can result in a risk of fire or electric shock.
- 28 Objects and Liquid Entry** — Never push objects of any kind into this product through openings as they may touch dangerous voltage points or short out parts that could result in a fire or electric shock. Be careful not to spill liquid of any kind onto the product.
- 29 Servicing** — Do not attempt to service this product yourself as opening or removing covers

may expose you to dangerous voltage or other hazards. Refer all servicing to qualified service personnel.

- 30 Damage Requiring Service** — Disconnect this product from the wall outlet and all power sources including battery, and refer servicing to qualified service personnel under the following conditions:
- When the power-supply cord or plug is damaged.
 - If any liquid has been spilled onto, or objects have fallen into, the product.
 - If the product has been exposed to rain or water.
 - If the product does not operate normally even if you follow the operating instructions. Adjust only those controls that are covered by the operation instructions. Improper adjustment of other controls may result in damage and will often require extensive work by a qualified technician to restore the product to its normal operation.
 - If the product has been dropped or the cabinet has been damaged.
 - When the product exhibits a distinct change in performance. This indicates a need for service.
- 31 Replacement Parts** — When replacement parts are required, be sure the service technician has used replacement parts that are specified by Canon or that have the same characteristics as the original part. Unauthorized substitutions may result in fire, electric shock or other hazards.
- 32 Safety Check** — Upon completion of any service or repairs to this product, ask the service technician to perform safety checks to determine that the product is in safe operating order.
- 33 Heat** — The product should be situated away from heat sources such as radiators, heat registers, stoves, or other products (including amplifiers) that produce heat.

When replacement of the power supply is required, please return it to the responsible nearest Canon Service Center and please replace it with the same type number CA-570.

The Adapter can be used with a power supply between 100 and 240 V AC. For areas where 120 V AC power is not used, you will need a special plug adapter. Contact your nearest Canon Service Center for further information.

This Class B digital apparatus complies with Canadian ICES-003.

How to Select a DVD Disc

There are many types of DVD discs but this camcorder uses only the following three types of 8 cm mini DVD discs: DVD-R, DVD-R DL and DVD-RW. Read the differences between them and select the disc that best fits your needs.

DVD-R

Best for Compatibility

DVD-Rs can be recorded only once – you cannot edit or delete the recordings. On the other hand, these discs are comparatively cheaper and can be played back on most DVD players.

DVD-R DL

Best for Recording Time

Dual-layered discs allow writing up to 80% more data (approx. 2.6 GB) on a single recording side. However, you cannot edit or delete the recordings.

Dual-layered discs have two recording layers. The camcorder will record on layer 1 and then continue to layer 2. During the playback of a recording spanning both layers, you may notice a brief stop (about 1 second) at the point where the camcorder switches to the second layer. The switch to layer 2 will break the recording into 2 separate scenes.

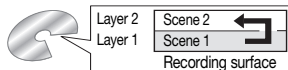

DVD-RW

Best for Reusability

Recordings made on a DVD-RW disc can be edited or deleted. Also, the disc can be initialized. Initializing a DVD-RW disc clears all the recordings and restores the free space on the disc to its initial value so you can use the same disc again.

Disc specification on DVD-RWs

DVD-RW discs can be recorded using either one of two disc specifications: VIDEO mode or VR mode. When you first insert a brand new DVD-RW disc, the camcorder will automatically display the initialization screen where you can select the disc specification for the disc.

VIDEO mode: Once finalized, discs recorded in VIDEO mode can be played back on most common DVD players offering the best compatibility. However, recordings cannot be edited (deleted, rearranged, etc.).

VR mode: You can easily edit the recordings. However, discs recorded in VR mode can be played back only with DVD players compatible with DVD-RWs in VR mode.

Note: DVD-R and DVD-R DL discs can be recorded only in VIDEO mode.

Enjoying your DVDs

After selecting the type of disc that is best for your needs, complete the rest of the preparations (□ 18) to get your camcorder ready to start recording.

Enjoy Shooting Video (□ 28)

Take it easy recording movies in **EASY** mode or have fun trying out more advanced functions (□ 36).

Finalize the Disc (□ 48)

Do not forget to finalize your disc with this camcorder to play it back on a DVD player or other external device.

Play back your finalized disc on your DVD player (□ 49)

You can also connect the camcorder to the TV and play back the disc with your camcorder (□ 65).

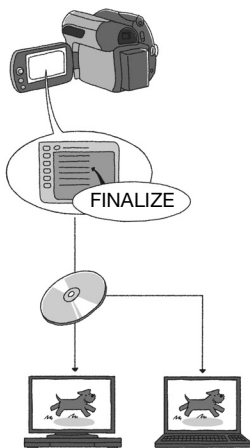

Playback on external devices

Make sure to finalize discs (□ 48) before you play them back on external DVD devices. The disc's type will affect its compatibility with external devices. Refer to the instruction manual of the external device and make sure it is compatible before inserting the disc.

For the highest compatibility with external DVD devices we recommend using VIDEO mode.

Available features depend on the DVD disc used

Disc type	DVD-R	DVD-R DL	DVD-RW	
	VIDEO		VIDEO	VR
Editing scenes with this camcorder (deleting scenes, dividing scenes, etc.) (□□45)	-	-	-	● ¹
Deleting a scene while reviewing it after recording it (□□33)	-	-	●	●
Initializing the disc in order to use it again for recording (□□47)	-	-	●	●
Giving a title to the disc (□□47)	●	●	●	●
Finalizing the disc in order to play it with an external DVD device (□□48) ²	●	●	●	●
Adding recordings to a disc already finalized (□□49)	-	-	● ³	●
Recording more video on a single recording side (□□30)	-	●	-	-

¹ Only scenes in the playlist can be divided.

² To finalize a DVD-R DL disc, the camcorder has to process both layers. Therefore, and depending on the amount of free space on the disc, this process may be lengthy.

³ You will need to unfinalize the disc first.

Approved discs

The camcorder's performance was tested and its correct operation was verified using the following types of discs (as of November 2008*). Single-layered: Hitachi-Maxell HG-series discs; dual-layered: Canon DVD-R DL54 and Verbatim DVD-R DL discs. For further details, contact directly the customer support center of the disc's manufacturer. Note that attempting to record or play back with this camcorder DVD discs that were recorded, initialized or finalized with a device other than this camcorder can result in damage to the camcorder or in the permanent loss of the recordings.

* For the latest information, visit your local Canon Web site or contact your nearest Canon office. The use of DVD-R DL discs that have not been tested by Canon may result in incorrect recording/playback or in not being able to remove the disc.

Table of contents

Introduction

- 5 How to Select a DVD Disc
- 6 Enjoying your DVDs
- 11 About this Manual
- 12 Getting to Know the Camcorder**
- 12 Supplied Accessories
- 13 Components Guide
- 15 Screen Displays



Preparations

18 Getting Started

- 18 Charging the Battery Pack
- 20 Preparing the Accessories

20 Basic Operation of the Camcorder

- 20 Power Switch
- 21 Joystick and Joystick Guide
- 21 Using the Menu

23 First Time Settings

- 23 Setting the Date and Time
- 23 Changing the Language
- 24 Changing the Time Zone

24 Getting Ready to Start Recording

- 24 Opening the Lens Cover and Adjusting the LCD screen
- 25 Inserting and Removing a Disc
- 27 Inserting and Removing a Memory Card



Video

28 Basic Recording

- 28 Shooting Video
- 30 Selecting the Video Quality (Recording Mode)
- 30 Changing the Aspect Ratio of the Recordings (Widescreen / 4:3)
- 30 Zooming: Optical, Advanced and Digital Zoom
- 32 Quick Start Function
- 32 Reviewing and Deleting the Last Scene Recorded

33 Basic Playback

- 33 Playing Back the Video
- 35 Deleting Scenes

36 Additional Functions

- 36 [P]: Special Scene Recording Programs
- 38 [P] Flexible Recording: Changing the Shutter Speed
- 39 LCD Video Light
- 39 Self Timer
- 40 Manual Exposure Adjustment
- 40 Manual Focus Adjustment
- 41 White Balance
- 42 Image Effects
- 42 Digital Effects
- 43 On-Screen Displays and Data Code
- 44 **DC410** Using an External Microphone

45 Editing the Playlist and Disc Operations

- 45 Creating a Playlist
- 45 Deleting Scenes from the Playlist
- 46 Dividing Scenes in the Playlist
- 46 Moving Scenes in the Playlist
- 47 Initializing the Disc

47 Disc Playback on an External Device

- 47 Changing the Disc Title
- 48 Finalizing the Disc
- 49 Disc Playback on External Devices
- 49 Unfinalizing the Disc - Additional Recordings on a Finalized Disc



Photos

51 Basic Recording

- 51 Taking Photos
- 52 Selecting Photo Size and Quality
- 53 Erasing a Photo Right After Recording It

53 Basic Playback

- 53 Viewing Photos
- 54 Magnifying Photos during Playback
- 55 Slideshow
- 55 Erasing Photos

56 Additional Functions

- 56 **DC420** Drive Mode: Continuous Shooting and Exposure Bracketing
- 56 Histogram Display

- 57 Protecting Photos
- 57 Initializing the Memory Card
- 58 Printing Photos**
- 58 Printing Photos from the Memory Card
- 58 **DC420** Direct Print
- 59 **DC420** Selecting the Print Settings
- 61 Print Orders



External Connections

63 Terminals on the Camcorder

- 64 Connection Diagrams
- 65 Playback on a TV Screen
- 65 Copying your Recordings to an External Video Recorder



Additional Information

66 Appendix: Menu Options Lists

- 66 FUNC. Menu
- 68 Setup menus
- 68 Camera Setup (Advanced Zoom, Image Stabilizer, etc.)
- 69 Disc Operations (Initialization, Finalization etc.)
- 70 Still Image Operations (Card Initialization, etc.)
- 70 Display Setup (LCD Brightness, Language, etc.)
- 71 System Setup (Volume, Beep, etc.)
- 72 Date/Time Setup

73 Trouble?

- 73 Troubleshooting
- 76 List of Messages

80 Do's and Don'ts

- 80 Handling Precautions
- 84 Using the Camcorder Abroad

86 General Information

- 86 System Diagram
- 87 Optional Accessories
- 90 Product Codes
- 91 Specifications
- 94 Index

About this Manual

Thank you for purchasing the Canon DC420/DC410. Please read this manual carefully before you use the camcorder and retain it for future reference. Should your camcorder fail to operate correctly, refer to *Troubleshooting* (□ 73).

Conventions Used in this Manual

- **!** **IMPORTANT:** Precautions related to the camcorder's operation.
- **i** **NOTES:** Additional topics that complement the basic operating procedures.
- **⚠** **POINTS TO CHECK:** Restrictions that apply if the function described is not available in all operating modes (the operating mode to which the camcorder should be set, the type of disc required, etc.).
- □: Reference page number.
- **DC420**: Text that applies only to the model(s) shown in the icon.
- The following terms are used in this manual:
 - “Screen” refers to the LCD and the viewfinder screen.
 - “Scene” refers to one movie unit from the point you press **Start/Stop** to start recording until you press again to pause the recording.
 - The terms “photo” and “still image” are used interchangeably with the same meaning.
- The photos included in this manual are simulated pictures taken with a still camera.
- Note that unless indicated otherwise, screenshots and illustrations in this manual refer to the **DC420** model.

The camcorder's operating mode is determined by the **POWER** switch and the position of the **Ⓜ** / **📷** switch. In this manual, **📷** indicates that a function is available and **Ⓜ** indicates that the function is not available. When no operating mode icons are given, the function is available in all operating modes.

Brackets [] and capital letters are used to refer to menu options as they are displayed on screen. In menu option lists and option tables the default value is shown in boldface. For example **[ON]**, [OFF].

Names of buttons and switches other than the joystick are indicated within a “button” frame. For example **[FUNC.]**.

In this manual, the **➤** arrow is used to abbreviate menu selections. For a detailed explanation refer to *Using the Menus* (□ 21).

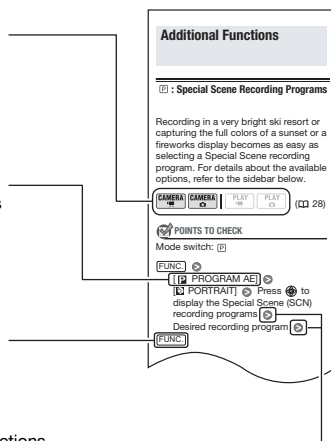

Supplied Accessories

CA-570 Compact Power Adapter (incl. power cord)



NB-2LH Battery Pack

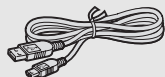
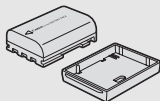

IFC-300PCU USB Cable
(DC420 only)



STV-250N Stereo Video Cable
Yellow • Red • White plugs

Online product registration for U.S.A. Customers only.

Register your product online at www.registercanon.com

✓ **Protect your product**

We will keep the model number and date of purchase of your new Canon product on file to help you refer to this information in the event of an insurance claim such as loss or theft.

✓ **Receive information on new products and promotions**

Upon your request, we will send you information on Canon new products and promotions.

The serial number of this product can be found at the battery attachment unit of the camcorder. Write down the number and other information here and retain this book as a permanent record of your purchase to aid identification in case of theft.

Date of Purchase:

Model Name: DC420 A/DC410 A

Purchased From:

Serial No.:

Dealer Address:

Dealer Phone No.:

Components Guide

Left side view

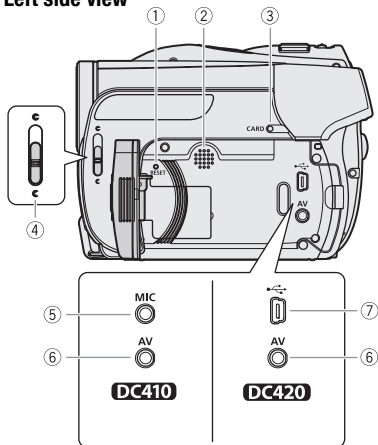

- ① RESET button (☞ 75)
- ② Speaker
- ③ CARD access indicator (☞ 51)
- ④ Lens cover switch (☞ 28, 51)
(☺ open, ☹ closed)
- ⑤ MIC terminal* (☞ 44)
- ⑥ AV terminal (☞ 63)
- ⑦ USB terminal** (☞ 63)
- ⑧ DISC access indicator (☞ 28)
- ⑨ Mode switch (☞ 29)
EASY Easy recording
P Recording programs
- ⑩ Disc compartment cover (☞ 25)
- ⑪ **POWER** switch (☞ 20)
- ⑫ Lock button
- ⑬ Strap mount (☞ 89)
- ⑭ Grip belt (☞ 20)
- ⑮ Stereo microphone

Right side view

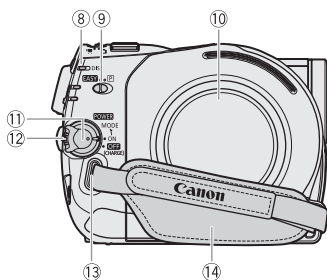

- * **DC410** only.
- ** **DC420** only.

Front view

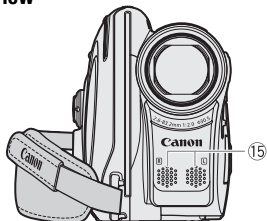

Back view

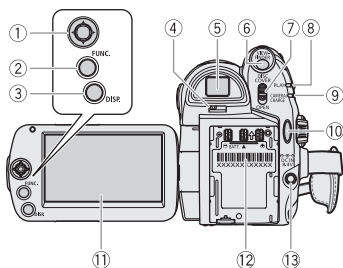

Top view

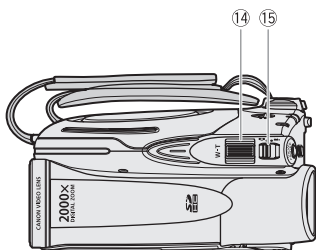

Bottom view

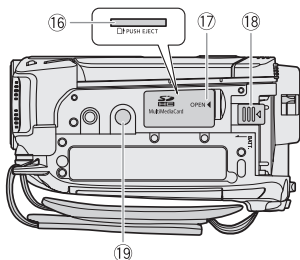



- ① Joystick (21)
- ② FUNC. button (22, 66)
- ③ DISP. button (43)
- ④ Dioptric adjustment lever (29)
- ⑤ Viewfinder (29)
- ⑥ VIEWFINDER button (29)
- ⑦ DISC COVER switch (25)
- ⑧ PLAY indicator (green) (21)
- ⑨ CAMERA indicator (green) (21)/
CHARGE indicator (red) (18)
- ⑩ Start/Stop button (28)
- ⑪ LCD screen (24)
- ⑫ Battery attachment unit (18)/
Serial number
- ⑬ DC IN terminal (18)
- ⑭ Zoom lever (30)
- ⑮ / (movies/still images) switch
(21)
- ⑯ Memory card slot
(open the cover to access) (27)
- ⑰ Memory card slot cover
- ⑱ BATT. (battery release) switch (18)
- ⑲ Tripod socket (80)

Screen Displays

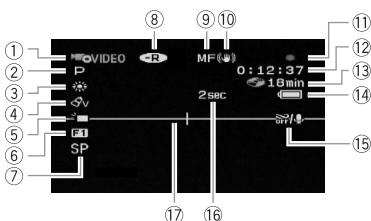
CAMERA Recording movies



- ① Operating mode (21) / Disc specification (5)
- ② Recording program (36, 38)
- ③ White balance (41)
- ④ Image effects (42)
- ⑤ LCD video light (39)
- ⑥ Digital effects (42)
- ⑦ Recording mode (30)
- ⑧ Disc type  DVD-R,  DVD-R DL,  DVD-RW (5)
- ⑨ Manual focus (40)
- ⑩ Image stabilizer (68)
- ⑪ Disc operation



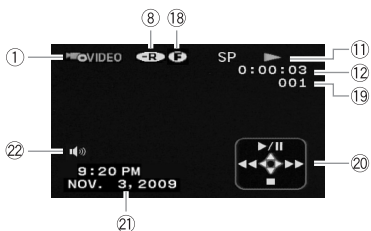





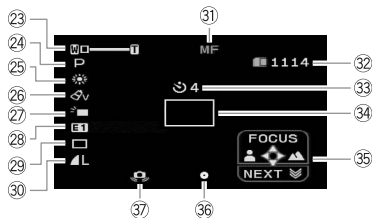



PLAY Playing movies (during playback)



- ⑫ Time code/Playback time (hours : minutes : seconds)
- ⑬ Remaining recording time on the disc
- ⑭ Remaining battery charge (17)
- ⑮ Wind screen off (69)
- ⑯ Recording reminder
- ⑰ Level marker (70)
- ⑱ Finalized disc mark (48)
- ⑲ Scene number
- ⑳ Joystick guide (21)
- ㉑ Data code (43)
- ㉒ Speaker volume (34)







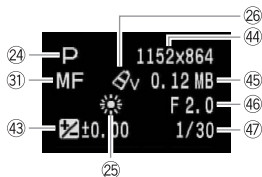
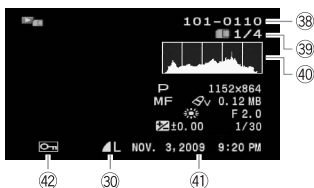

CAMERA · Recording still images



- 23 Zoom ( 30), Exposure  ( 40)
- 24 Recording program ( 36, 38)
- 25 White balance ( 41)
- 26 Image effects ( 42)
- 27 LCD video light ( 39)
- 28 Digital effects ( 42)
- 29 **DC420** Drive mode ( 56)
- 30 Still image quality/size ( 52)
- 31 Manual focus ( 40)
- 32 Number of still images available on the memory card
- 33 Self timer ( 39)

PLAY · Viewing still images



- 34 AF frame ( 69)
- 35 Joystick guide ( 21)
- 36 Focus/exposure automatically set and locked ( 51)
- 37 Camcorder shake warning ( 68)
- 38 Image number ( 17, 71)
- 39 Current image / Total number of images
- 40 Histogram ( 56)
- 41 Date and time of recording
- 42 Image protection mark ( 57)
- 43 Manual exposure ( 40)
- 44 Image size ( 52)
- 45 File size
- 46 Aperture value
- 47 Shutter speed (38)

⑪ Disc operation

- Record, ● ■■ Record pause,
- ▶ Playback, ■■ Playback pause,
- ▶▶, ▶▶▶ Fast playback,
- ◀◀, ◀◀◀ Fast reverse playback,
- ▶ Slow playback,
- ◀ Slow reverse playback

⑬ Remaining recording time

When there is no more disc space available, “END” will be displayed and the recording will stop.

⑭ Remaining battery charge estimate

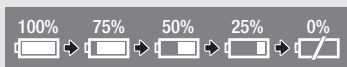





- When  is displayed in red, the battery pack is exhausted. Replace the battery pack with a fully charged one.
- Depending on the conditions under which the camcorder and the battery pack are used, the actual battery charge may not be indicated accurately.

⑯ Recording reminder

The camcorder counts from 1 to 10 seconds when you start recording. This is helpful to avoid scenes that are too short.

⑳ Number of still images available on the card

-  displayed in red: No card
-  in green: 6 or more images
-  in yellow: 1 to 5 images
-  in red: No more images can be recorded
- When viewing the still images, the display will always be in green.
- Depending on the recording conditions, the number of available still images displayed may not decrease even after a recording has been made, or may decrease by 2 still images at once.

Card access display

▶  is displayed next to the number of images available while the camcorder is writing on the memory card.

㉑ Image number

The image number indicates the name and location of the file on the memory card. For example, the file name of image 101-0107 is “IMG_0107.JPG”, stored under the folder “DCIM\101\CANON”.



Preparations

This chapter describes basic operations, such as navigating the menus, and first time settings to help you learn more about your camcorder.

Getting Started

Charging the Battery Pack

The camcorder can be powered with a battery pack or directly using the compact power adapter. Charge the battery pack before use.

For approximate charging times and recording/playback times with a full battery pack, refer to the tables on pages 87-88.

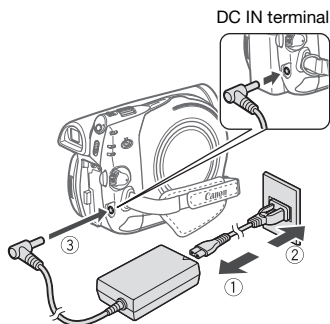

- 1 Connect the power cord to the compact power adapter.
- 2 Plug the power cord into a power outlet.

- 3 Connect the compact power adapter to the camcorder's DC IN terminal.

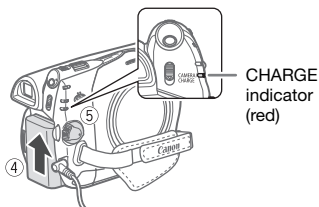

- 4 Attach the battery pack to the camcorder.

Press the battery pack lightly and slide it up until it clicks.

- 5 Charging will start when the **POWER** switch is turned to **OFF (CHARGE)**.

The red CHARGE indicator starts flashing. The indicator goes out when charging is completed.



TO REMOVE THE BATTERY PACK

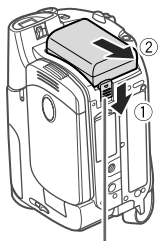

BATT. switch

- 1 Slide **BATT.** in the direction of the arrow and hold it pressed down.
- 2 Slide the battery pack down and then pull it out

! IMPORTANT

- Turn off the camcorder before connecting or disconnecting the compact power adapter. After you turn the **POWER** switch to **OFF**, important file allocation data is updated on the disc. Be sure to wait until the CAMERA green indicator goes out.
- We recommend charging the battery pack in temperatures between 10 °C and 30 °C (50 °F and 86 °F). Outside the temperature range of 0 °C to 40 °C (32 °F to 104 °F), the charging will not start.
- Do not connect to the camcorder's DC IN terminal or to the compact power adapter any electrical equipment that is not expressly recommended for use with this camcorder.
- To prevent equipment breakdowns and excessive heating, do not connect the supplied compact power adapter to voltage converters for overseas travels or special power sources such as those on aircraft and ships, DC-AC inverters, etc.

i NOTES

- The battery pack will be charged only when the camcorder is off.
- If remaining battery time is an issue, you can power the camcorder using the compact power adapter so the battery pack will not be consumed.
- The CHARGE indicator also serves as a rough estimate of the charge status.
 - Two quick flashes at 1-second intervals: Battery pack at least 50% charged. If the indicator flashes quickly but not exactly in this pattern, refer to *Troubleshooting* (□ 73).
 - One flash at 1-second intervals: Battery pack less than 50% charged.
- Charged battery packs continue to discharge naturally. Therefore, charge them on the day of use, or the day before, to ensure a full charge.
- We recommend that you prepare battery packs to last 2 to 3 times longer than you think you might need.
- **USA and Canada only:** The Lithium ion/polymer battery that powers this product is recyclable. Please call 1-800-8-BATTERY for information on how to recycle this battery.



Preparing the Accessories

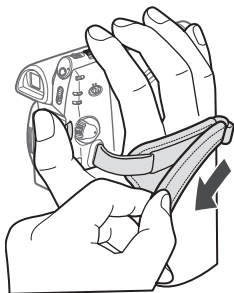

Fasten the grip belt.

Adjust the grip belt so that you can reach the zoom lever with your index finger, and the **Start/Stop** button with your thumb.

TO ATTACH A SHOULDER STRAP

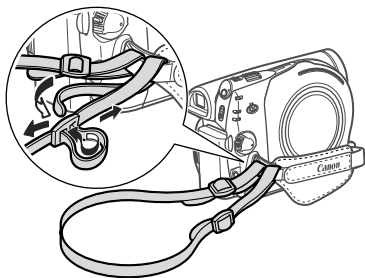

Pass the ends of the shoulder strap through the strap mount on the grip belt and adjust the length of the strap.

Basic Operation of the Camcorder

Power Switch

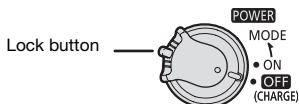

In addition to turning the camcorder on and off, the **POWER** switch also toggles the camcorder's operating mode.

To turn on the camcorder: Hold the lock button pressed down and turn the **POWER** switch to ON.

To change the operating mode: From the ON position, turn the **POWER** switch momentarily toward **MODE** and release it. This action will toggle the operating mode between recording (**CAMERA** indicator on) and playback (**PLAY** indicator on).

Joystick and Joystick Guide

Use the joystick to operate the camcorder's menus.

Push the joystick up, down, left or right (▲▼, ◀▶) to select an item or change settings.

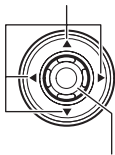

Press the joystick itself (⊗) to save the settings or confirm an action. On menu screens, this is indicated by the icon **SET**.

Press ⊗ to display/hide the joystick guide. The functions that appear on the joystick guide will change depending on the operating mode.

Using the Menus

Many of the camcorder's functions can be adjusted from the menus that open after pressing the FUNC. button (FUNC.).

For details about the available menu options and settings, refer to the appendix *Menu Options Lists* (66).

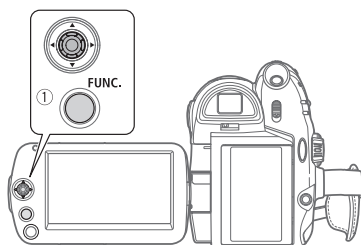

Operating mode	Operating mode indicator	⏪ / 📷 switch	Icon display	Operation	📖
CAMERA 📷	CAMERA 📷	📷 (movies)	📷	Recording movies on a disc	28
CAMERA 📷		📷 (still images)	📷	Recording still images on a memory card	51
PLAY 📺	PLAY 📺	📷 (movies)	📺	Playing movies from a disc	33
PLAY 📷		📷 (still images)	📺	Viewing still images from a memory card	53

Selecting an Option from the FUNC. menu

Following is an example of selecting an option from the FUNC. menu in a recording mode.



1 Press [FUNC.] .

2 Select (▲▼) the icon of the function you want change from the left side column.

Menu items not available will appear grayed out.

3 Select (◀▶) the desired setting from the available options at the bottom bar.

- The selected option will be highlighted in light blue.
- With some settings, you will need to make further selections and/or press . Follow the additional operation guides that will appear on the screen (such as the icon, small arrows, etc.).

4 Press [FUNC.] to save the settings and close the menu.

You can press [FUNC.] to close the menu at any time.

Selecting an Option from the Setup Menus



1 Press [FUNC.] .

In the index screen (VIDEO mode) and still image index screen, the setup menus will open. Continue with step 3.

2 Select (▲▼) [MENU] and press to open the setup menus.

- You can also hold [FUNC.] pressed down for more than 1 second to open directly the setup menu screen.
- In the index screen (DVD-RW discs in VR mode), push the joystick (◀▶) to select [MENU].

3 Select (▲▼) the desired menu from the left side column and press .

- The title of the selected menu appears on top of the screen and under it the list of settings.
- Push the joystick (◀) to return to the menu selection screen.

4 Select (▲▼) the setting you want to change and press .

The orange selection bar indicates the menu setting currently selected. Items not available appear in black.

5 Select (▲▼) the desired option and press to save the setting.

6 Press [FUNC.] .

You can press [FUNC.] to close the menu at any time.



First Time Settings

Setting the Date and Time

You will need to set the date and time of the camcorder before you can start using it. If the camcorder's clock is not set, the [DATE/TIME] screen will appear automatically when the camcorder is turned on.

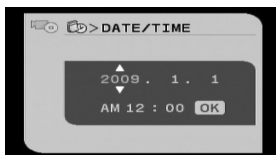

When the [DATE/TIME] screen appears, the year will be displayed in orange and indicated with up/down arrows.

- 1 Change (▲▼) the year and move (▶) to the month.
- 2 Change the rest of the fields (month, day, hour and minutes) in the same way.
- 3 Select (▶) [OK] and press to start the clock and close the setup screen.

! IMPORTANT

- When you do not use the camcorder for about 3 months, the built-in rechargeable battery may discharge completely and the date and time setting may be lost. In such case, recharge the built-in battery (☐ 83) and set the time zone, date and time again.
- The date appears in a year-month-day format only in the first setup screen. In subsequent screen displays the date and time will appear as month-day-year

(for example, [JAN. 1, 2009 12:00 AM]). You can change the date format (☐ 72).

- You can also change the date and time later on (not during the initial setup). Open the [DATE/TIME] screen from the setup menu:

[FUNC.]
 [MENU]
 [DATE/TIME SETUP]
 [DATE/TIME]

Changing the Language

Options

♦ Default value

[ČEŠTINA]	[MELAYU]	[العربية]
[DEUTSCH]	[NEDERLANDS]	[فارسی]
[ΕΛΛΗΝΙΚΑ]	[POLSKI]	[ภาษาไทย]
[ENGLISH]♦	[PORTUGUÊS]	[简体中文]
[ESPAÑOL]	[ROMÂNĂ]	[繁體中文]
[FRANÇAIS]	[TÜRKÇE]	[한국어]
[ITALIANO]	[РУССКИЙ]	[日本語]
[MAGYAR]	[УКРАЇНСЬКА]	

[FUNC.]
 [MENU]
 [DISPLAY SETUP]
 [LANGUAGE]
 Desired language

[FUNC.]





i NOTES

- If you changed the language by mistake, follow the mark next to the menu item to change the setting.
- The display **SET** that appears in some menu screens refers to the name of the button on the camcorder and will not change, regardless of the language selected.

Changing the Time Zone









In addition to your local date and time, the camcorder can keep a second clock (for example, the time at a travel destination). The default time zone is New York.

TO SET THE HOME TIME ZONE

FUNC. 
[ MENU] 
[ DATE/TIME SETUP] 
[T.ZONE/DST]   
Your local time zone* 

FUNC.

WHEN YOU TRAVEL

FUNC. 
[ MENU] 
[ DATE/TIME SETUP] 
[T.ZONE/DST]   
Local date and time in your destination* 

FUNC.

* To adjust for daylight saving time, select the area name marked with a .

Getting Ready to Start Recording

Opening the Lens Cover and Adjusting the LCD screen

Before you start recording, open the lens cover.

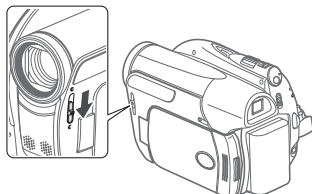

Move the lens cover switch down to  to open the lens cover.

Rotating the LCD Panel

Open the LCD panel 90 degrees.

You can rotate the panel 90 degrees downward.

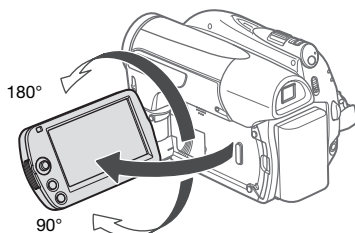

- You can rotate the panel 180 degrees toward the lens (allowing the subject to monitor the LCD screen while you use the viewfinder (□ 29)). Rotating the LCD panel 180 degrees can be useful in the following cases:



- To allow the subject to monitor the LCD screen while you use the viewfinder.
- To include yourself in the picture when recording with the self timer.

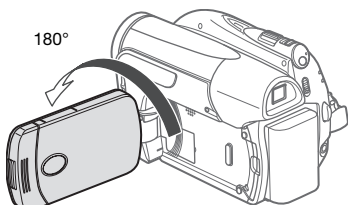

180°

Subject can monitor the LCD screen

i NOTES

About the LCD and viewfinder screen: The screens are produced using extremely high-precision manufacturing techniques, with more than 99.99% of the pixels operating to specification. Less than 0.01% of the pixels may occasionally misfire or appear as black, red, blue or green dots. This has no effect on the recorded image and does not constitute a malfunction.

LCD Backlight

You can set the brightness of the LCD screen to normal or bright.

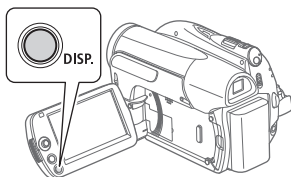

Hold **DISP.** pressed down for more than 2 seconds.

Repeat this action to toggle between the normal and bright settings.

i NOTES

- This setting does not affect the brightness of the recordings.
- Using the bright setting will shorten the effective usage time of the battery pack.

Inserting and Removing a Disc

Use only 8 cm (3 in.) mini DVD discs marked with the DVD-R **DVD** logo (including DVD-R DL) or the DVD-RW **DVD** logo. Refer also to *Approved discs* (□ 7).

Before inserting the disc, be sure to check that the recording surface is clean. If necessary, use a soft lens-cleaning cloth to remove any fingerprints, dirt buildup or smudges from the disc surface.

Inserting the Disc

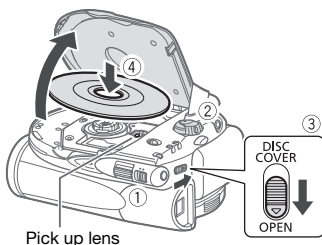

- 1 Move the **MOVIE** / **DISP.** switch to **MOVIE** (movies).
- 2 Turn the **POWER** switch to **ON** to set the camcorder in **CAMERA** mode.

3 Slide DISC COVER fully toward OPEN and gently open the disc cover completely until it stops.

Retract the grip belt under the camcorder so it will not get in the way of the disc cover.

4 Insert the disc and press its center firmly until it clicks in place.



- Insert the disc with the recording side facing down (single sided discs – label side facing out).
- Be careful not to touch the recording surface of the disc or the pick up lens.



5 Close the disc cover.

Do not force the cover closed if the disc is not correctly inserted and firmly set in place.





i NOTES







The process of recognizing a disc may take a moment. The  display will move while the disc is being read. Wait until the camcorder finishes recognizing the disc ( stops moving and turns green) before you start recording.

WHEN USING DVD-R/DVD-R DL DISCS

You can start recording movies once the record pause  indicator appears.

WHEN USING DVD-RW DISCS

You need to initialize new discs before you can start recording. The disc initialization screen will appear when a new DVD-RW disc is first inserted if the  /  switch is set to  (movies). If the disc is already initialized, you can start recording movies once the record pause  indicator appears. Otherwise, perform the following steps to initialize the disc.

- ① Select () the desired disc specification and press . For a comparison between the VIDEO and VR specifications, see *How to Select a DVD Disc* (□ 5).
- ② A confirmation message will appear on the screen. Select () [YES] and press  to start the disc initialization, or select [NO] and press  to return and select a different disc specification.
 - The disc initialization will take approximately one minute. Avoid moving the camcorder while the operation is in progress.
 - You can start recording movies once the record pause  indicator appears.

Removing the Disc

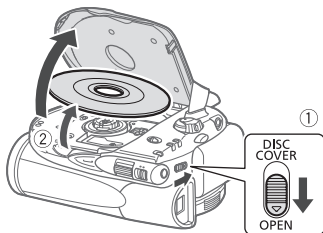



1 Slide **DISC COVER fully toward OPEN and gently open the disc cover completely until it stops.**

- Do not subject the camcorder to strong impacts while the DISC access indicator is on or flashing.
- Retract the grip belt under the camcorder so it will not get in the way of the disc cover.
- It may take a moment after sliding **DISC COVER** for the disc cover to open.

2 Grab the edge of the disc and gently pull it out.

Be careful not to touch the recording surface of the disc or the pick up lens.

3 Close the disc cover.

! IMPORTANT

When you slide **DISC COVER** after making a recording, important file allocation data is updated on the disc before the disc cover opens. While the DISC access indicator is on or flashing do not subject the camcorder to shocks such as forcefully laying it on a table.

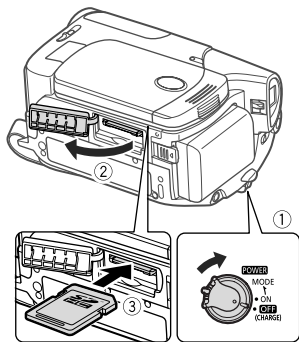

- 1 Turn off the camcorder.**
- 2 Open the memory card slot cover.**
- 3 Insert the memory card straight, with the label facing up, all the way into the memory card slot until it clicks.**
- 4 Close the memory card slot cover.**
Do not force the cover closed if the memory card is not correctly inserted.

Inserting and Removing a Memory Card

You can use commercially available SDHC (SD High Capacity) memory cards, SD memory cards or MultiMedia Cards (MMC) with this camcorder.

Make sure to initialize all memory cards before using them with this camcorder (□ 57).

TO REMOVE THE MEMORY CARD

Push the memory card once to release it. When the memory card springs out, pull it all the way out.

! IMPORTANT

Memory cards have front and back sides that are not interchangeable. Inserting a memory card facing the wrong direction can cause a malfunction of the camcorder. Be sure to insert the memory card as described in step 3.

i NOTES

Compatibility with all SD, SDHC or MMC memory cards cannot be guaranteed.



Video

This chapter covers functions related to shooting movies, including recording, playback, advanced manual adjustments and playlist and scene operations.

Basic Recording

Shooting Video

Before You Begin Recording

Make a test recording first to check if the camcorder operates correctly. Since recordings made on a DVD-R or DVD-R DL disc cannot be deleted, we recommend you use a DVD-RW disc to make the test recordings.

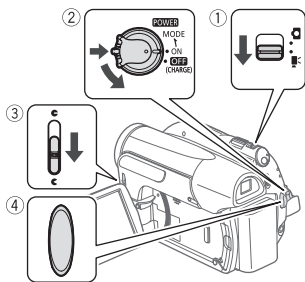

1 Move the / switch to (movies).

2 Turn the **POWER** switch to **ON** to set the camcorder in **CAMERA** mode.

The green CAMERA indicator will turn on.

3 Move the lens cover switch down to to open the lens cover.

4 Press **[Start/Stop]** to begin recording.

- Recording starts; press **[Start/Stop]** again to pause the recording.
- The DISC access indicator will flash while recording and will stay on briefly after pausing while the scene is recorded on the disc.

WHEN YOU HAVE FINISHED RECORDING

1 Make sure that the **DISC** access indicator is off.

2 Turn off the camcorder.

3 Close the lens cover and the LCD panel.

4 Remove the disc.



Using the viewfinder

When recording in bright places it may be difficult to use the LCD screen. In such case, change the brightness of the LCD screen (□ 25) or use the viewfinder instead. Press **VIEWFINDER** to activate the viewfinder along with the LCD panel. Close the LCD panel to use only the viewfinder.

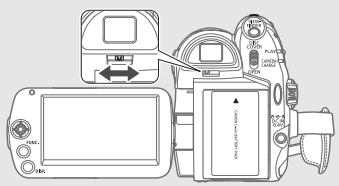

Adjust the viewfinder as necessary with the dioptic adjustment lever.

i NOTES

- **About the Power Save mode:** If [POWER SAVE] is set to [ON ON] (□ 71), the camcorder will shut off automatically to save power when it is powered by a battery pack and is left without any operation for 5 minutes. To restore the power, turn the **POWER** switch toward **MODE** and release it, or turn the camcorder off and then on again.
- When recording in very loud places (such as fireworks shows or concerts), sound may become distorted or it may not be recorded at the actual levels. This is not a malfunction.
- The following may take longer with a disc in VR mode than a disc in VIDEO mode.
 - The time between turning on the camcorder and being able to start recording.
 - The time between turning the **POWER** switch to **OFF** and the camcorder shutting off.

! IMPORTANT

Observe the following precautions while the DISC access indicator is on or flashing. Failing to do so may result in permanent data loss.

- Do not subject the camcorder to vibrations or strong impacts.
- Do not open the disc cover and do not remove the disc.
- Do not disconnect the power source or turn off the camcorder.
- Do not change the operating mode.

About the mode switch and recording programs

Set the mode switch to **EASY** to let the camcorder adjust all the settings for you, allowing you to just point the camcorder and start shooting.



Set the mode switch to **P** to select one of the recording programs. The Special Scene recording programs (□ 36) offer a convenient way to select the optimal settings to match special recording conditions; and with the flexible recording programs (□ 38) you can set the shutter speed manually, or enjoy the flexibility to change other settings.



Selecting the Video Quality (Recording Mode)

The camcorder offers 3 recording modes. Changing the recording mode will change the recording time available on the disc. Select XP mode for better movie quality; select LP mode for longer recording times.

The following table gives approximate recording times with a brand new DVD disc (on a single recording side).

◆ Default value

Recording mode	Disc type	
	DVD-R, DVD-RW	DVD-R DL
XP	20 min.	36 min.
SP ◆	30 min.	54 min.
LP	60 min.	108 min.



FUNC. [SP STANDARD PLAY 6 Mbps] Desired recording mode

FUNC.

NOTES

- In LP mode, recordings are more liable to be affected by imperfections of the disc used or recording conditions and you may experience some anomalies (blocky video artifacts, banding, skipping audio, etc.) during playback. We recommend using XP or SP mode for important recordings.
- The camcorder uses a variable bit rate (VBR) to encode video so the actual recording times will vary depending on the content of the scenes.

Changing the Aspect Ratio of the Recordings (Widescreen / 4:3)

The default aspect ratio of movies is 16:9 (widescreen). Follow the procedure below to change it to 4:3.



FUNC. [MENU] [CAMERA SETUP] [WIDESCREEN] [OFF OFF]

NOTES

- Playing back a widescreen recording:** TV sets compatible with the Video ID-1 system will switch automatically to 16:9 mode. Otherwise, change the aspect ratio of the TV manually.
- To play back on a TV with normal aspect ratio (4:3) change the [TV TYPE] setting accordingly.

Zooming: Optical, Advanced and Digital Zoom

The camcorder offers three types of zoom when recording movies: optical, advanced and digital zoom (In **CAMERA** mode, only the optical zoom is available.) You can also change the zoom speed.



Selecting the Zoom Type



Options

◆ Default value

[OPTICAL] (37x)
The zoom range is limited to the optical magnification ratio of the lens.
[ADVANCED]◆ (Advanced Zoom)
In addition to the optical zoom range, the camcorder processes the image digitally to obtain a larger zoom range without any deterioration in image quality. When recording movies with a 16:9 aspect ratio, the angle of view will change. Refer to the table in the NOTES section.
[DIGITAL] (2000x)
When this option is selected, the camcorder will switch to digital zoom (light blue area on the zoom indicator) when you zoom in beyond the optical zoom range (white area on the zoom indicator). With the digital zoom the image is processed digitally so image quality will deteriorate the more you zoom in.

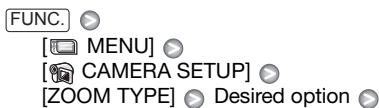

FUNC.

i NOTES

- The range of the advanced zoom will change depending on the aspect ratio of the scene (□ 30).
- **DC410** Advanced zoom cannot be selected if [WIDESCREEN] is set to [OFF OFF].

[WIDESCREEN] set to [ON ON] (16:9)

DC420 48x*

DC410 41x**

* The angle of view will be wider at both full telephoto and full wide-angle.

**The angle of view will be wider at full wide-angle.

[WIDESCREEN] set to [OFF OFF] (4:3)

DC420 55x

DC410 Not available

Using the Zoom

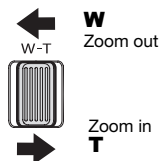

Move the zoom lever toward W to zoom out (wide-angle). Move it toward T to zoom in (telephoto).

Press gently for slower zooms; press harder for faster zooms. You can also set [ZOOM SPEED] (□ 68) to one of three constant speeds (3 is the fastest, 1 the slowest).

i NOTES

- Keep at least 1 m (3.3 ft.) away from the subject. At full wide-angle, you can focus on a subject as close as 1 cm (0.39 in.).
- When [ZOOM SPEED] is set to [VAR VARIABLE], the zoom speed will be faster in record pause mode than when actually recording.

Quick Start Function

When you close the LCD panel with the camcorder set to a recording mode, the camcorder enters the standby mode. In standby mode the camcorder consumes only about half the power used when recording, saving energy when you are using a battery pack. Additionally, when you open the LCD panel, the camcorder is ready to start recording in approximately 1 second*, ensuring you do not miss important shooting opportunities.

* The actual time required varies depending on the shooting conditions.



1 With the camcorder on and the CAMERA indicator lit up in green, close the LCD panel.

- If you are using the viewfinder and the LCD panel is closed, press **VIEWFINDER** to enter the standby mode.
- A beep will sound and the CAMERA indicator will change to orange to indicate the camcorder entered the standby mode.

2 When you wish to resume recording, open the LCD panel.

- The CAMERA indicator turns back green and the camcorder is ready to record.
- You can also press **VIEWFINDER** to resume recording using the viewfinder with the LCD panel closed.

! IMPORTANT

Do not disconnect the power source while the camcorder is in standby mode (CAMERA indicator is lit in orange).

i NOTES

- If you close the LCD panel under some circumstances (for example, while the DISC access indicator is flashing or a menu is being displayed), the camcorder may not enter standby mode. Check that the CAMERA indicator changes to orange.
- The camcorder will shut off if left in standby mode for 10 minutes, regardless of the [POWER SAVE] setting (□ 71). To restore the power if the camcorder shut off, turn the **POWER** switch toward MODE and release it, or turn the camcorder off and then on again.
- You can select the length of time until shut-off or turn off the Quick Start function altogether with the [QUICK START] setting (□ 71).
- Performing any of the following actions while the camcorder is in standby mode will reactivate the camcorder.
 - Opening the disc compartment cover.
 - Changing the position of the switch.
 - Turning the **POWER** switch toward MODE.

Reviewing and Deleting the Last Scene Recorded

Even in **CAMERA** mode you can play back the last scene recorded in order to check it. If you are using a DVD-RW disc, you can also delete the scene while reviewing it.





1 Press to display the joystick guide.

If does not appear on the joystick guide, repeatedly push the joystick () toward [NEXT] to display it.

2 Push the joystick () toward .

The camcorder plays back the last scene (but without sound) and returns to record pause mode.

Deleting a Scene After Recording It

POINTS TO CHECK

Disc type: DVD-RW

After recording a scene:

1 Review the scene as described in the previous section.

2 While reviewing the scene, select and press .

3 Select [YES] and press .

NOTES

- Avoid any other operations on the camcorder while the scene is being deleted.
- You will not be able to delete the last scene if after the scene was recorded you changed the operating mode, turned off the camcorder or removed the disc.

Basic Playback

Playing Back the Video

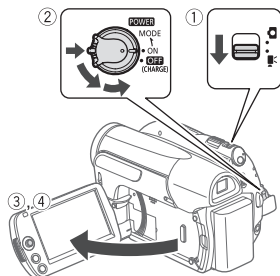

1 Move the switch to (movies).

2 Turn the **POWER** switch to **ON**, then turn it toward **MODE** and release it to set the camcorder in **PLAY** mode.

- The green PLAY indicator will turn on.
- The scene index screen appears.

3 Move (,) the selection frame to the scene you want to play back.

4 Press to begin the playback.

- Playback will start from the scene selected and continue until the end of the last scene recorded.
- Push the joystick () toward to pause the playback.

- Push the joystick (▼) toward ■ to stop the playback and return to the scene index screen.

TO ADJUST THE VOLUME

During the playback of a scene:

FUNC. 

[] SPEAKER VOL. 

Adjust (◀▶) the volume 

FUNC.

NOTES

- Depending on the recording conditions, you may notice brief stops in video or sound playback between scenes.
- This camcorder can play back discs recorded with this camcorder. You may not be able to correctly play back discs recorded with other camcorders or discs created with a computer.
- When playing back a finalized disc, depending on the number of scenes, it may take a few seconds before the index screen appears.
- Sound from the speaker will be muted when the LCD panel is closed in order to use the viewfinder for playback.

Special playback modes

Use the joystick guide to enter the special playback modes. There is no sound during the special playback modes.

Fast playback

During normal playback, push the joystick (◀) toward ◀◀ or (▶) toward ▶▶. Push it in the same direction again to increase the playback speed.

Slow playback

In playback pause mode, push the joystick (◀) toward ◀◀ or (▶) toward ▶▶. Push it in the same direction again to increase the playback speed 1/8 → 1/4 the normal speed.

Ending special playback modes

During any special playback mode, push the joystick (▲) toward ▶/||.

NOTES

During some special playback modes, you may notice some anomalies (blocky video artifacts, banding, etc.) in the playback picture.



Deleting Scenes

If you are using a DVD-RW disc, you can delete those scenes that you are not interested in keeping.

Deleting a Single Scene



POINTS TO CHECK

Disc type: DVD-RW • VR mode

From the original index screen, select (,) the scene to delete.

FUNC.
[DELETE] [YES]

Deleting All Scenes



POINTS TO CHECK

Disc type: DVD-RW • VR mode

To delete all the scenes from the original index screen, perform the following procedure. This will delete also the entire playlist.

FUNC.
[MENU]
[DISC OPERATIONS]
[DEL.ALL MOVIES] [YES]
FUNC.

IMPORTANT

Be careful when deleting original recordings. Once deleted, original scenes cannot be recovered.

NOTES

- You may not be able to delete scenes shorter than 5 seconds. To delete such scenes you must initialize the disc (47), in the process deleting all the recordings on the disc.
- Do not change the position of the **POWER** switch or the / switch while the scene is being deleted (while the DISC access indicator is on or flashing).

Additional Functions

: Special Scene Recording Programs

Recording in a very bright ski resort or capturing the full colors of a sunset or a fireworks display becomes as easy as selecting a Special Scene recording program. For details about the available options, refer to the sidebar on page 37.







POINTS TO CHECK

Mode switch: 

FUNC. 











[ PROGRAM AE] 

[ PORTRAIT]  Press  to display the Special Scene (SCN) recording programs 

Desired recording program 

FUNC.

NOTES

- [ PORTRAIT] / [ SPORTS] / [ BEACH] / [ SNOW]
 - The picture may not appear smooth during playback.
- [ PORTRAIT]
 - The blur effect of the background increases the more you zoom in ().
- [ NIGHT]
 - Moving subjects may leave a trailing afterimage.
 - Picture quality may not be as good as in other modes.
 - White points may appear on the screen.
 - Autofocus may not work as well as in other modes. In such case, adjust the focus manually.
- [ SNOW] / [ BEACH]
 - The subject may become overexposed on cloudy days or in shaded places. Check the image on the screen.
- [ FIREWORKS]
 - To avoid camcorder shake, we recommend using a tripod. Make sure to use a tripod especially in  mode, as the shutter speed slows down.
- Do not set the mode switch to **EASY** during the actual recording of a scene; the brightness of the picture may change abruptly.

[👤] PORTRAIT

The camcorder uses a large aperture, achieving a focus on the subject while blurring other distracting details.



[🎾] SPORTS

Use this mode to record sports scenes such as tennis or golf.



[🌙] NIGHT

Use this mode to record in dimly lit places.



[👷] SNOW

Use this mode to record in bright ski resorts. It prevents the subject from being underexposed.



[🏖️] BEACH

Use this mode to record on a sunny beach. It prevents the subject from being underexposed.



[🌅] SUNSET

Use this mode to record sunsets in vibrant colors.



[🎯] SPOTLIGHT

Use this mode to record spotlit scenes.



[🎆] FIREWORKS

Use this mode to record fireworks.



P Flexible Recording: Changing the Shutter Speed

Select the [**P** PROGRAM AE] recording program to use functions like the white balance or image effects, or use [**TV** SHUTTER-PRIO.AE] to give priority to the shutter speed.

Use faster shutter speeds to record subjects moving quickly; use slower shutter speeds to add motion blur, emphasizing the feel of movement.



POINTS TO CHECK

Mode switch: **P**

Options

◆ Default value

[P PROGRAM AE]◆
The camcorder automatically adjusts the aperture and shutter speed to obtain the optimal exposure for the subject.
[TV SHUTTER-PRIO.AE]
Set the shutter speed value. The camcorder automatically sets the appropriate aperture value.

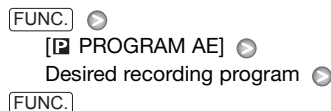

TO SET THE SHUTTER SPEED

When you select [**TV** SHUTTER-PRIO.AE], a numeric value will appear next to the recording program icon.

1 If the joystick guide appears on the screen, press  to hide it.

2 Adjust (**▲▼**) the shutter speed to the desired value.

Shutter speed guidelines

Note that on screen only the denominator is displayed – [**TV** 250] indicates a shutter speed of 1/250 second, etc.

1/2*, 1/4*, 1/8, 1/15, 1/30
To record in dimly lit places.
1/60
To record under most ordinary conditions.
1/100
To record indoor sports scenes.
1/250, 1/500, 1/1000**
To record from within a moving car or train or to shoot fast-moving subjects such as roller coasters.
1/2000**
To record outdoor sports scenes on sunny days.

*  mode only.

**  mode only.

i NOTES

- [**TV** SHUTTER-PRIO.AE]
 - When setting the shutter speed, the number displayed will flash if the shutter speed selected is not appropriate for the recording conditions. In such case, select a different value.
 - If you use a slow shutter speed in dark places, you can obtain a brighter image, but the image quality may be lower, and the autofocus may not work well.
 - The image may flicker when recording with fast shutter speeds.



- **Recording movies under fluorescent lights:**
If the screen starts to flicker, select [TV SHUTTER-PRIO.AE] and set the shutter speed to 1/100.
- Do not set the mode switch to **EASY** during the actual recording of a scene; the brightness of the picture may change abruptly.

LCD Video Light

You can use the brightness of the LCD screen (LCD video light) to record in completely dark places. For a brighter picture, we recommend keeping a distance of about 20 cm – 60 cm (8 in. – 2 ft.) from the subject and/or using the [NIGHT] recording program.



1 Turn on the LCD video light.

- [FUNC.]
- [LCD LIGHT OFF]
- [LCD LIGHT ON]
- Press
- [FUNC.]

2 Rotate the LCD panel toward the lens and point it in the direction of the subject.

3 Press [VIEWFINDER] to turn on the viewfinder.

Use the viewfinder to continue recording.

TO TURN OFF THE LCD VIDEO LIGHT

1 Using the viewfinder, repeat step 1 above, selecting [LCD LIGHT OFF] instead.

Closing the LCD panel will also turn off the LCD video light.

2 Press [VIEWFINDER] to turn off the viewfinder's display.

Self Timer



1 Activate the self timer.

- [FUNC.]
- [MENU]
- [CAMERA SETUP]
- [SELF TIMER] [ON ON]
- Set [SELF TIMER] to [OFF OFF] to cancel the self timer.

2 Press [FUNC.] to close the menu.

☺ appears.

3 Press [Start/Stop] on the camcorder to start recording.

The camcorder starts recording video (CAMERA mode) or records a still image (CAMERA mode) after a 10-second countdown. The countdown appears on the screen.

i NOTES

Once the countdown has begun, you can press [Start/Stop] again or turn off the camcorder to cancel the self timer.

Manual Exposure Adjustment

At times, backlit subjects may appear too dark (underexposed) or subjects under very strong lights may appear too bright or glaring (overexposed). To correct this, you can manually adjust the exposure.



POINTS TO CHECK

Mode switch: [P] (except for the [FIREWORKS] recording program).



1 Press to display the joystick guide.



If [EXP] does not appear on the joystick guide, repeatedly push the joystick () toward [NEXT] to display it.

2 Push the joystick () toward [EXP].

- The exposure adjustment indicator  and the neutral value “±0” appear on the screen.
- The adjustment range and the length of the exposure adjustment indicator will vary depending on the initial brightness of the picture.
- If you operate the zoom, the brightness of the image may change.

3 Adjust () the brightness of the image as necessary and press .

- The exposure adjustment indicator  will change to white and the exposure will be locked.

- During exposure lock, press  and push the joystick () toward [EXP] again to return the camcorder to automatic exposure.

Manual Focus Adjustment

Autofocus may not work well on the following subjects. In such case, focus manually.

- Reflective surfaces
- Subjects with low contrast or without vertical lines
- Fast moving subjects
- Through wet windows
- Night scenes



POINTS TO CHECK

Adjust the zoom before you start the procedure.

Mode switch: [P]



1 Press to display the joystick guide.

If [FOCUS] does not appear on the joystick guide, repeatedly push the joystick () toward [NEXT] to display it.



2 Push the joystick () toward [FOCUS].

“MF” appears.

3 Adjust () the focus as necessary and press .

- The focus will be locked.





- During focus lock, press  and push the joystick () toward [FOCUS] again to return the camcorder to autofocus.

Infinity Focus

Use this function when you wish to focus on faraway subjects such as mountains or fireworks.

Instead of step 2 in the previous procedure:

Push the joystick () toward [FOCUS] and hold it for more than 2 seconds.

- ∞ appears.
- Push the joystick () toward [FOCUS] again to return the camcorder to autofocus.
- If you operate the zoom or joystick (), ∞ changes to “MF” and the camcorder returns to manual focus.

White Balance



The white balance function helps you to accurately reproduce colors under different lighting conditions so that white objects will always look truly white in your recordings.





POINTS TO CHECK

Mode switch:  (except for the Special Scene recording programs).

Options  Default value



[ AUTO] 
The camcorder automatically sets the white balance for natural looking colors.

[ DAYLIGHT]
For recording outdoors on a bright day.
[ TUNGSTEN]
For recording under tungsten and tungsten type (3-wavelength) fluorescent lighting.
[ SET]
Use the custom white balance setting to make white subjects appear white under colored lighting.





[FUNC.] 
 [ AUTO]  Desired option* 
 [FUNC.]

* When you select [ SET], do not press [FUNC.] and continue instead with the following procedure.

TO SET THE CUSTOM WHITE BALANCE

- 1 Point the camcorder at a white object, zoom in until it fills the whole screen and press .**
When the adjustment is completed,  stops flashing and stays on.
- 2 Press [FUNC.] to save the setting and close the menu.**
The camcorder retains the custom setting even if you turn off the camcorder.

NOTES

- **When you select the custom white balance:**
 - Set the custom white balance in a sufficiently illuminated place.
 - Select a zoom type other than [ DIGITAL] ( 30).
 - Reset the white balance when the lighting conditions change.
 - Depending on the light source,  may keep flashing. The result will still be better than with [ AUTO].

- In the following cases, if the colors on the screen do not look natural using the [AWB AUTO] setting, try using the custom white balance.
 - Changing lighting conditions
 - Close-ups
 - Subjects in a single color (sky, sea or forest)
 - Under mercury lamps and certain types of fluorescent lights

Image Effects

You can use the image effects to change the color saturation and contrast to record movies and still images with special color effects.



POINTS TO CHECK

Mode switch: [P] (except for the Special Scene recording programs).

Options ♦ Default value

[OFF] IMAGE EFFECT OFF] ♦
Records with no image enhancing effects.
[VIVID]
Emphasizes the contrast and color saturation.
[NEUTRAL]
Tones down the contrast and color saturation.
[SOFT SKIN DETAIL]
Softens the details in the skin tone area for a more complimentary appearance.

[FUNC.]
 [OFF] IMAGE EFFECT OFF]
 Desired option
 [FUNC.]

Digital Effects



POINTS TO CHECK

Mode switch: [P]

Options ♦ Default value

[OFF] D.EFFECT OFF] ♦
Select this setting when you do not intend to use the digital effects.
[FADE-T] (fade trigger), [WIPE]
Select one of the faders to begin or end a scene with a fade from or to a black screen.
[BLK&WHT]*
Records movies and still images in black and white.
[SEPIA]*
Records movies and still images in sepia tones for an "old" look.
[ART], [MOSAIC]
Select one of these digital effects to add "flavor" to your recordings.

* Only these digital effects are available in mode.

Setting

[FUNC.]
 [OFF] D.EFFECT OFF]
 Desired fader/effect*
 [FUNC.]**

* You can preview the digital effect on the screen.

** The icon of the selected digital effect appears.



Applying



1 Press to display the joystick guide.

If  does not appear on the joystick guide, repeatedly push the joystick (▼) toward [NEXT] to display it.

2 Push the joystick (▲) toward .

- The icon of the selected digital effect turns green.
- Push the joystick (▲) toward  again to deactivate the digital effect (its icon will turn white again).

TO FADE IN



Activate the selected fader in record pause mode (●||), then press  to start recording with a fade in.

TO FADE OUT

Activate the selected fader while recording (●), then press  to fade out and pause the recording.

TO ACTIVATE AN EFFECT

 mode: Activate the selected effect while recording or in record pause mode.

 mode: Activate the selected effect and then press  to record the still image.

NOTES

- When you apply a fader, not only the picture but also the sound will fade in or out. When you apply an effect, the sound will be recorded normally.
- The camcorder retains the last setting used even if you turn off the digital effects or change the recording program.

On-Screen Displays and Data Code

You can turn most on-screen displays on or off.

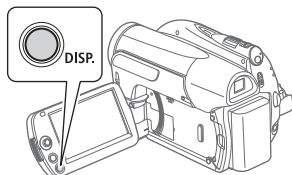

Repeatedly press  to turn the on-screen displays on/off in the following sequence:

,  mode:



- All displays on
- Most displays off*

 mode:

- All displays on
- Data code only
- All displays off

 mode:

- All displays on
- Regular displays only (removes the histogram and information icons)
- All displays off

- * The following icons will appear even when all other on-screen displays are turned off: The icons  and  (in **CAMERA** mode), the  icon and AF frames when the autofocus is locked (in **CAMERA** mode), screen markers (both recording modes).

About the Data Code

With every scene or still image recorded, the camcorder keeps a data code (date/time of recording, information about the camera setup, etc.). In **PLAY** mode, this information is displayed on the bottom bar and as information icons; in **PLAY** mode, you can select the information to be displayed with the [DATA CODE] setting (p. 70).

DC410 Using an External Microphone

You can use a commercially available microphone, for example to record audio more accurately.



Connect the external microphone to the MIC terminal.

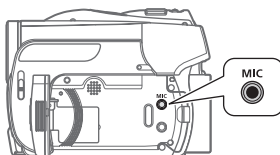

NOTES

- Use commercially available condenser microphones with their own power supply. You can connect almost any stereo microphone with a \varnothing 3.5 mm plug but audio recording levels may vary.
- When an external microphone is connected to the camcorder, [WIND SCREEN] will automatically be set to [OFF OFF ].



Editing the Playlist and Disc Operations

Creating a Playlist

Create a playlist to play back only the scenes you prefer and in the order of your choice. Deleting, dividing or moving scenes in the playlist will not affect the original recordings.

Adding Scenes to the Playlist

You can choose to add to the playlist all the original scenes at once or only the selected scene.



1 Select (▲▼, ◀▶) the scene you want to add to the playlist.

To add all scenes, there is no need to select any particular scene.

2 Add the scene(s) to the playlist.

[FUNC.] ➤
[ADD TO PLAYLIST] ➤
Desired option ➤ [YES]

- To check the playlist, in the original index screen:

[FUNC.] ➤ [TO PLAYLIST].

- To return to the original index screen, in the playlist index screen:

[FUNC.] ➤ [TO ORIGINAL].



Deleting Scenes from the Playlist

Deleting scenes from the playlist will not affect your original recordings.



POINTS TO CHECK

Disc type: DVD-RW • VR mode

Deleting a Single Scene

1 Select the playlist index screen.

[FUNC.] ➤ [TO PLAYLIST]

2 Select (▲▼, ◀▶) the scene you want to delete.

3 Delete the scene.

[FUNC.] ➤ [DELETE] ➤
[YES]

Deleting the Entire Playlist

1 Select the playlist index screen.

[FUNC.] ➤ [TO PLAYLIST]

2 Delete the playlist.

[FUNC.] ➤ [MENU] ➤
[DISC OPERATIONS] ➤
[DEL.PLAYLIST] ➤ [YES] ➤
[FUNC.]

Dividing Scenes in the Playlist

You can divide scenes (in the playlist only) in order to leave only the best parts and later cut out the rest. Remember that when you divide scenes in the playlist, you do not affect your original recordings.



POINTS TO CHECK

Disc type:  DVD-RW • VR mode

1 Select the playlist index screen.

[FUNC.]  [ TO PLAYLIST]



2 Select (,) the scene you want to divide.

3 Press [FUNC.], select () [DIVIDE] and press .

Playback of the scene selected will start. Pause the playback at the point where you want to divide the scene.*

4 Press [FUNC.], select () [YES] and press .

The video from the division point to the end of the scene will appear as a new scene in the playlist index screen.

* You can use the /||/||> (Frame reverse/advance) icons and fast playback ( 34) to bring the scene to a precise point.

NOTES

Very short scenes (shorter than 2 seconds) cannot be divided.

Moving Scenes in the Playlist

Move the scenes in the playlist to play them back in the order of your choice.



POINTS TO CHECK

Disc type:  DVD-RW • VR mode

1 Select the playlist index screen.

[FUNC.]  [ TO PLAYLIST]

2 Select (,) the scene you want to move.

3 Press [FUNC.], select () [MOVE] and press .

4 Move (,) the orange marker to the desired position of the scene and press .

The original position of the scene and the current position of the marker are displayed at the bottom of the screen.

5 Select () [YES] and press to move the scene.

Initializing the Disc

You need to initialize all new DVD-RW discs when you first insert them into the camcorder and you may have to initialize them if you get the message [UNABLE TO RECOGNIZE THE DATA]. You can also initialize a DVD-RW disc when you want to completely erase the disc to reuse it or in order to change the disc specification.



POINTS TO CHECK

Disc type: DVD-RW

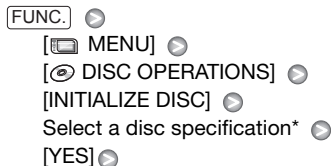

- FUNC.****
- * For details about disc specifications, refer to *Disc specification on DVD-RWs.* (□ 5)
 - **Close the menu only after the screen display returns to the [DISC OPERATIONS] menu.

! IMPORTANT

Initializing the disc will permanently erase all recordings. Lost original recordings cannot be recovered.

Disc Playback on an External Device

Changing the Disc Title

Before you finalize your disc, you can give it a title*. The disc title will be displayed on the index screen when playing the finalized disc in most DVD players. You can check the disc's title with the [DISC INFO] menu option (□ 69).

* You can change the title of DVD-RW discs recorded in VR mode also after having finalized them.

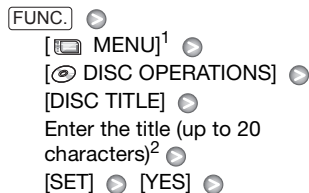

FUNC.

¹ Only when using a DVD-RW recorded in VR mode. Otherwise, pressing **FUNC.** will open the menu directly on the setup menu screen.

² Select one character at a time and press to add it to the title. Select [BACKSPACE] and press to delete the character to the left of the cursor's position.

Finalizing the Disc

To play the disc you recorded on a DVD player, a computer's DVD drive or other digital device, **you need to finalize it first.**









1 Power the camcorder using the compact power adapter or a fully charged battery pack.



2 Set the camcorder to  mode.

The green PLAY indicator will turn on.

3 Start the disc's finalization.



[FUNC.] 
[ MENU] 
[ DISC OPERATIONS] 
[FINALIZE]  [YES]

- A progress bar and the time remaining will be displayed on the screen.
- Selecting [ MENU] is only necessary when using a DVD-RW recorded in VR mode. Otherwise, pressing [FUNC.] will open the menu directly on the setup menu screen.

4 When the process is completed ([OK] appears), press  and wait until the [ DISC OPERATIONS] menu is displayed again.

Depending on the number of scenes, this may take a moment.

5 Press [FUNC.] to close the menu.

During playback and in  mode, the  icon will indicate that the disc is finalized.

IMPORTANT

- **Be sure to finalize the disc in normal room temperatures. If the procedure was not completed correctly due to high temperature, let the camcorder cool off before resuming operation.**
- **Place the camcorder on a table or other stable surface before starting the procedure. Subjecting the camcorder even to slight impacts (for example to place it on a table or to disconnect a cable) after the finalization process started may result in permanent data loss.**
- Do not disconnect the power source while the operation is in progress. Doing so can interrupt the process and result in permanent data loss.
- Depending on the type of disc and the disc specification, after finalizing the disc you may not be able to initialize the disc, edit your recordings or add new recordings to the disc. Refer to the table on page 49.
- Do not use this camcorder to finalize discs that were not recorded with it.

NOTES

The time required to finalize the disc depends on the scenes recorded and the remaining free space on the disc.

Restrictions after disc finalization

	Additional recordings	Editing recordings	Initializing the disc	Unfinalizing the disc
DVD-R/DVD-R DL in VIDEO mode	–	–	–	–
DVD-RW in VIDEO mode	● ¹	–	●	●
DVD-RW in VR mode	●	● ²	●	–

¹ You will need to unfinalize the disc first.

² Only scenes in the playlist can be divided.

Disc Playback on External Devices

After finalizing the disc, you can play it on DVD players compatible with the type of disc used (DVD-R, DVD-R DL or DVD-RW). You cannot play back discs on an external DVD device if the discs have not yet been finalized.

Refer to the instruction manual of the DVD player or DVD drive to confirm that it is compatible with the type/specification of the disc you want to play back.

ON A DVD PLAYER

- 1 Turn on the TV and DVD player.
- 2 Insert the finalized disc in the DVD player.
- 3 Select the scene you want to play from the index screen.

ON A COMPUTER'S DVD DRIVE

- 1 Insert the finalized disc in the DVD drive.
- 2 Run the DVD playback software. Refer also to the instruction manual of your DVD playback software.

NOTES

- DVD-RW discs recorded in VR mode can be played back only on VR mode-compatible DVD players.
- Depending on your DVD device you may not be able to play back the disc.
- In order to play back the disc on a computer you need to have DVD playback software installed and running. Also, in order to play back a DVD-R DL you must have a DVD drive capable of reading dual-layered DVD discs.

Unfinalizing the Disc - Additional Recordings on a Finalized Disc

Unfinalize a disc to allow recording additional movies on the disc even after it was finalized.



POINTS TO CHECK

Disc type: DVD-RW •
VIDEO mode • Finalized

- 1 Power the camcorder using the compact power adapter or a fully charged battery pack.

2 Set the camcorder to  mode.

The green PLAY indicator will turn on.

3 Start the disc's unfinalization.

 DISC OPERATIONS 

UNFINALIZE  [YES]

- A progress bar will be displayed on the screen.

4 When the process is completed ([OK] appears), press .

5 Press  to close the menu.

Discs that can be unfinalized

Only DVD-RW discs recorded in VIDEO mode and finalized with this camcorder can be unfinalized. DVD-R and DVD-R DL discs cannot be unfinalized at all, whereas DVD-RW discs recorded in VR mode do not need to (you can record additional scenes without unfinalizing the disc).

 IMPORTANT

- **Be sure to unfinalize the disc in normal room temperatures. If the procedure was not completed correctly due to high temperature, let the camcorder cool off before resuming operation.**
- **Place the camcorder on a table or other stable surface before starting the procedure. Subjecting the camcorder even to slight impacts (for example to place it on a table or to disconnect a cable) after the unfinalization process started may result in permanent data loss.**
- Do not disconnect the power source while the operation is in progress. Doing so can interrupt the process and result in permanent data loss.
- Only discs that were finalized using this camcorder can be unfinalized with it.



Photos

Refer to this chapter for details on shooting photos – from recording and playing back still images to printing them.

Basic Recording

Taking Photos

Before using a memory card for the first time, be sure to initialize it with this camcorder (□ 57).



(□ 21)

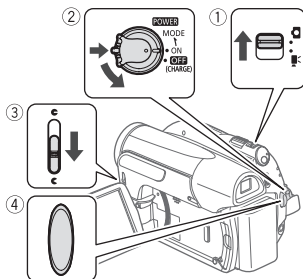

1 Move the **VIDEO/PHOTO** switch to **PHOTO** (still images).

2 Turn the **POWER** switch to **ON** to set the camcorder in **CAMERA** mode.

The green **CAMERA** indicator will turn on.

3 Move the lens cover switch down to **C** to open the lens cover.

4 Press **[Start/Stop]**.

- Once the focus is automatically adjusted, **AF** will turn green and one or more AF frames will appear.
- The **CARD** access indicator will flash as the still image is being recorded.

IMPORTANT

Observe the following precautions while the card access display (**▶** □) appears on screen, and while the **CARD** access indicator is on or flashing. Failing to do so may result in permanent data loss.

- Do not subject the camcorder to vibrations or strong impacts.
- Do not open the memory card slot cover and do not remove the memory card.
- Do not disconnect the power source or turn off the camcorder.
- Do not change the position of the **VIDEO/PHOTO** switch or the operating mode.

NOTES

If the subject is not suitable for autofocus, **AF** turns yellow. Adjust the focus manually (□ 40).

Selecting Photo Size and Quality

Still images are recorded on the memory card as JPG files. As a general rule, select a larger image size for higher quality.

DC420 Select the [LW 1152x648] size for still images with an aspect ratio of 16:9.



Options

Image size options and the approximate number of still images that can be recorded on memory cards of various sizes are given in the table below.

FUNC. [L 1152x864] (**DC420** only) or
 [L 1024x768] (**DC410** only)
 Desired image size*
 Desired image quality*

FUNC.

* Press to move back and forth between size and quality selection. The number displayed on the right corner indicates the approximate number of images that can be recorded with the current quality/size setting.

NOTES

When printing still images, use the following guidelines as a reference for selecting the print size.

- **LW 1152x648**: To print photos with a 16:9 aspect ratio. (Wide photo paper is required.)
- **L 1152x864** (or 1024x768): To print photos up to L size (9 x 13 cm, 3.5 x 1.5 in.) or postcard size (10 x 14.8 cm, 4 x 6 in.)
- **S 640x480**: To send images as e-mail attachments or post them on the Web.

Approximate number of still images on a memory card

◆ Default value

Memory card	128 MB			512 MB			1 GB		
LW 1152x648 (DC420 only)	245	360	695	970	1,435	2,745	1,945	2,875	5,490
L 1152x864 (DC420 only)◆	185	280	545	735	1,115	2,155	1,470	2,235	4,315
L 1024x768 (DC410 only)◆	235	345	695	940	1,370	2,745	1,885	2,745	5,490
S 640x480	585	850	1,530	2,320	3,355	6,040	4,645	6,715	12,085 ²

¹ : [SUPER FINE], : [FINE], : [NORMAL]

² Approximate number of still images that can actually be recorded on the memory card. (The maximum number of remaining still images displayed on the screen is 9999.)



Erasing a Photo Right After Recording It

You can erase the still image recorded last while reviewing it within the time set for the [REVIEW] option (or immediately after recording it, if [REVIEW] is set to [OFF OFF]).



While reviewing the still image immediately after recording:

- 1 Push the joystick (▼) toward .
- 2 Select (◀▶) [ERASE] and press .

Basic Playback

Viewing Photos

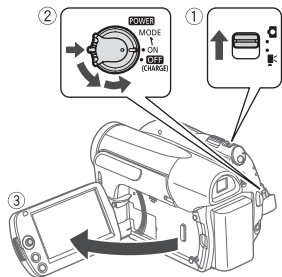

- 1 Move the switch to (still images).
- 2 Turn the **POWER** switch to ON, then turn it toward **MODE** and release it to set the camcorder in **PLAY** mode.
The green PLAY indicator will turn on.
- 3 Push the joystick (◀▶) to move between still images.
Push the joystick (◀▶) and hold it down to run quickly through the still images.

Image Jump Function

When you have recorded a large number of still images, you can jump 10 or 100 images at a time.

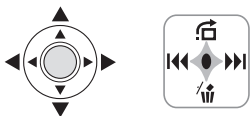

- 1 Press to display the joystick guide.
- 2 Push the joystick () toward .

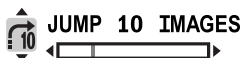

- 3 Select () [$\frac{10}{100}$ JUMP 10 IMAGES] or [$\frac{100}{100}$ JUMP 100 IMAGES].
- 4 Jump () the number of images selected and press . Press again to hide the joystick guide.

Index Screen

1 Move the zoom lever toward **W**.

The still images index screen appears.

2 Select (,) an image.

- Move the green selection frame to the image you want to view.
- When you have recorded a large number of still images, you may find it easier to browse entire index pages instead. Move the zoom lever toward **W** to extend the green selection frame to the whole page, and move () between index pages. Move the zoom lever toward **T** to return to moving between single images.

3 Press .

The index screen closes and the selected image is displayed.

! IMPORTANT

- Observe the following precautions while the card access display () appears on screen, and while the CARD access indicator is on or flashing. Failing to do so may result in permanent data loss.
 - Do not subject the camcorder to vibrations or strong impacts.
 - Do not open the memory card slot cover and do not remove the memory card.
 - Do not disconnect the power source or turn off the camcorder.
 - Do not change the position of the switch or the operating mode.
- The following may not be displayed correctly.
 - Images not recorded with this camcorder.
 - Images edited on a computer.
 - Images whose file names have been changed.

Magnifying Photos during Playback

During playback, still images can be magnified up to 5 times. will appear for images that cannot be enlarged.



1 Move the zoom lever toward **T**.

- The image is magnified by 2 times and a frame appears indicating the position of the magnified area.



- To further enlarge the image, move the zoom lever toward **T**. To reduce the magnification to less than 2 times, move the zoom lever toward **W**.

2 Move (▲▼, ◀▶) the frame to the part of the image you want to see enlarged.

To cancel the magnification, move the zoom lever toward **W** until the frame disappears.

Slideshow

You can play a slideshow of all the still images on the memory card. Play the slideshow on a TV screen to share your memories with family and friends.

- Select (◀▶) the first still image of the slideshow.
- Start the slideshow.

[FUNC.] ➤ [SLIDESHOW] ➤
[START]

- Images are played back one after another.
- Press [FUNC.] to stop the slideshow.

Erasing Photos

You can erase those still images that you are not interested in keeping.

[CAMERA] [CAMERA] | [PLAY] [PLAY] (21)

Erasing a Single Still Image

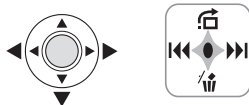

- Select (◀▶) the image you want to erase.
- Press to display the joystick guide.
- Push the joystick (▼) toward .
- Select (◀▶) [ERASE] and press .

Erasing All Still Images

[FUNC.] ➤
[MENU] ➤
[STILL IMG OPER.] ➤
[ERASE ALL IMAGES] ➤
[YES] ➤
[FUNC.]

! IMPORTANT

Be careful when erasing still images. Erased images cannot be recovered.

i NOTES

Protected still images cannot be erased.

Additional Functions

DC420 Drive Mode: Continuous Shooting and Exposure Bracketing

Take a series of pictures of a moving subject or record the same picture in 3 levels of exposure in order to choose later the picture you like the best.



POINTS TO CHECK

Mode switch: (except for the FIREWORKS) recording program).

Options

Default value

<input type="checkbox"/> SINGLE [*]
Records a single still image.
CONT.SHOOT.] (Continuous Shooting), HISPEED CONT.SHOOT.] (High-Speed Continuous Shooting)
Captures a series of up to 20 still images (image size L or LW) or 60 still images (image size S) as long as you hold pressed down. There are two continuous shooting speed settings: normal (approx. 3 images/second) and high speed (approx. 5 images/second).
AEB] (Auto Exposure Bracketing)
The camcorder records 3 still images using 3 different exposures (dark, normal, light in 1/2 EV steps), allowing you to choose the still image you like the best.

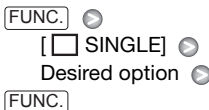

CONTINUOUS SHOOTING/ HIGH-SPEED CONTINUOUS SHOOTING

Press and hold it pressed down.

Once the focus is automatically adjusted, will turn green and the still images will be recorded.

AUTO EXPOSURE BRACKETING

Press .

Once the focus is automatically adjusted, will turn green and the still images will be recorded.

NOTES

- Continuous shooting speeds are approximate and vary depending on recording conditions and subjects.
- Continuous shooting speeds will decrease when (camcorder shake warning) appears on the screen.

Histogram Display

When viewing still images you can display the histogram and the icons of all the functions used at the time of recording. Use the histogram as a reference to verify the correct exposure of the still image.





The area to the right of the histogram represents highlights and the left side represents shadows. A still image whose histogram skews to the right is relatively bright; while one whose histogram peaks to the left, is relatively dark.

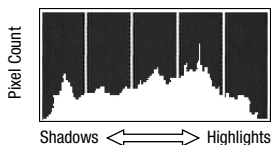

i NOTES

- The histogram will appear also after recording a still image, unless you pressed [DISP.] while reviewing the still image immediately after recording it.
- In [PLAY] mode, press [DISP.] repeatedly to turn the histogram and other onscreen displays on and off ([43]).

Protecting Photos

You can protect still images from accidental erasure.



(21)

[FUNC.] [PROTECT]

[PROTECT]: The image selection screen appears.

FROM THE IMAGE SELECTION SCREEN

- 1 Select (◀▶) the still image you want to protect.

- 2 Press [PROTECT] to protect the still image.

[PROTECT] appears on the bottom bar and the image cannot be erased. Press [PROTECT] again to remove the image protection.

- 3 Repeat steps 1-2 to protect additional images or press [FUNC.] twice to close the menu.

! IMPORTANT

Initializing the memory card ([57]) will permanently erase all still images, including protected ones.

Initializing the Memory Card

Initialize memory cards when you use them with this camcorder for the first time, or to erase all the still images on them.

Options

[INITIALIZE]
Clears the file allocation table but does not physically erase the stored data.
[COMPL.INIT.]
Erases all data completely.



(21)

[FUNC.] [MENU]

[STILL IMG OPER.] [INITIALIZE CARD]

Select the card initialization method [YES]* [YES]*

[FUNC.]











- * Press  to cancel the complete initialization while it is in progress. All the image files will be erased and the memory card can be used without any problem.

IMPORTANT

Initializing the memory card will permanently erase all still images, including protected ones. Lost original still images cannot be recovered.

You can also use the following functions...

The following functions and features of the camcorder can be used either for shooting video or for taking photos. The way to set and use them was already explained in detail, so we refer you to the relevant page in the “Video” section.

- Zoom ( 30)
- Quick Start ( 32)
- Special Scene recording programs ( 36)
- Flexible recording programs ( 38)
- LCD video light ( 39)
- Self timer ( 39)
- Manual exposure adjustment ( 40)
- Manual focus ( 40)
- White balance ( 41)
- Image effects ( 42)
- Digital effects ( 42)

Printing Photos

Printing Photos from the Memory Card

You can print still images recorded on the memory card by inserting it into the memory card slot of a printer compatible with DPOF* (Digital Print Order Format). You can mark in advance the still images you want to print and set the desired number of copies as a print order ( 61).

- * DPOF is a standard that allows you to specify the still images and information to be printed.

Direct Print

The camcorder can be connected to any PictBridge-compatible printer. You can set print orders ( 61) also when using Direct Print. Mark the still images in advance and print them after connecting the camcorder directly to a compatible printer.

PictBridge

Canon printers: SELPHY printers of the CP, DS and ES series and PIXMA printers marked with the PictBridge logo.

Connecting the Camcorder to the Printer



- 1 Insert the memory card that contains the still images you want to print.**



2 Turn on the printer.

3 Connect the camcorder to the printer using the supplied USB cable.

- Connection [2]. Refer to *Connection Diagrams* (□ 64).
- ↔ appears and changes to ↗.

! IMPORTANT

- If ↔ continues to flash (for more than 1 minute) or if ↗ does not appear, the camcorder is not correctly connected to the printer. In such case, disconnect the USB cable and turn off the camcorder and the printer. After a short while, turn them on again, set the camcorder to **PLAY** mode and restore the connection.
- If the printer is connected to the camcorder while all still images or all print orders are being erased, the printer will not be recognized correctly.

i NOTES

- ⚠ will appear for images that cannot be printed.
- We recommend powering the camcorder using the compact power adapter.
- Refer also to the printer's instruction manual.
- Connection to a PictBridge-compatible printer will not work when the memory card contains 1,800 still images or more. For best performance, we recommend keeping the number of still images on the memory card under 100.

DC420 Selecting the Print Settings

You can select the number of copies and other settings for printing. The setting options vary depending on your printer model.



Options

[PAPER]
[] PAPER SIZE: Available paper sizes vary depending on the printer model.
[] PAPER TYPE: Select [PHOTO], [FAST PHOTO], [PLAIN] or [DEFAULT].
[] PAGE LAYOUT: Select [DEFAULT], [BORDERED] or one of the following available page layouts. [BORDERLESS]: The still image is enlarged and may be slightly cropped at the edges to fit the paper.
[2-UP], [4-UP], [8-UP], [9-UP], [16-UP]: Refer to the sidebar on page 60.
[] (Date print)
Select [ON], [OFF] or [DEFAULT].
[] (Print Effect)
Available only with printers compatible with the Image Optimize function. Select [ON], [OFF] or [DEFAULT]. Canon PIXMA/SELPHY DS printers: You can also select [VIVID], [NR] and [VIVID+NR].
[] (Number of Copies)
Select 1-99 copies.

i NOTES

Print setting options and [DEFAULT] settings vary depending on the printer model. For details, refer to the printer's instruction manual.

Printing after Changing the Print Settings



- 1 Press to display the joystick guide.
- 2 Push the joystick () toward . The print settings menu appears.

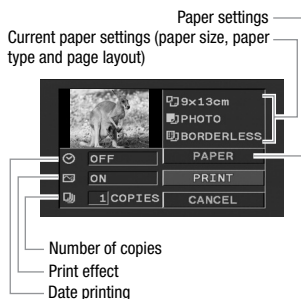

- 3 In the print settings menu, select (,) the setting you want to change and press .

- 4 Select () the desired setting option and press .

- 5 Select (,) [PRINT] and press .

- Printing starts. The print settings menu disappears when the printing is completed.
- To continue printing, select () another still image.

Printing multiple images on the same sheet [2-UP], [4-UP], etc.

When using Canon printers you can print the same still image multiple times on the same sheet of paper. Use the following table as a guideline for the recommended number of copies depending on the [PAPER SIZE] setting.

[PAPER SIZE]→	[CREDITCARD]	[9 x 13 cm]	[10 x 14.8 cm]	[A4]
Canon printer ↓				
PIXMA SELPHY DS	–	–	2, 4, 9 or 16 ¹	4
SELPHY CP/ES	2, 4 or 8 ²	2 or 4	2 or 4	–

¹ You can also use the special sticker sheets.

² With the [8-UP] setting, you can also use the special sticker sheets.

SELPHY CP: When you use the wide-sized photo paper with the [DEFAULT] setting, you can also use [2-UP] or [4-UP].



TO CANCEL THE PRINTING

- 1 Press while printing.
- 2 Select (◀▶) [OK] and press .

WHEN YOU HAVE FINISHED PRINTING

Disconnect the cable from the camcorder and printer and turn off the camcorder.

PRINT ERRORS

If an error occurs while printing, an error message (for example, [NO PAPER]) will appear on the camcorder's screen. Solve the problem referring to the error message list (□ 78) and to the printer's instruction manual.

- **Canon's PictBridge-compatible printers:** If printing does not resume automatically after you solved the problem, select [CONTINUE] and press to resume printing. If that option is not available, select [STOP] and press and then restart printing from the beginning.
- **Other printers or if the error still persists with a Canon printer:** If printing does not resume automatically, disconnect the USB cable and turn off the camcorder. After a short while, turn on the camcorder and restore the USB connection.

! IMPORTANT

- You may not be able to print correctly with a PictBridge-compatible printer still images whose file names have been changed or that were recorded, created, edited or changed with any device other than this camcorder.
- Observe the following precautions while printing:
 - Do not turn off the camcorder or the printer.
 - Do not change the position of the / switch.

- Do not disconnect the USB cable.
- Do not open the memory card slot cover and do not remove the memory card.
- If [BUSY] does not disappear, disconnect the USB cable and restore the connection after a short while.

Print Orders

You can mark in advance the still images you want to print and set the desired number of copies as a print order. Later, you can easily print out the print orders in one of the following ways:

- Insert the memory card into the memory card slot of a DPOF-compatible printer. Refer to printer's instruction manual for the correct procedure.
- **DC420** Connect the camcorder directly to a PictBridge-compatible printer (□ 58).

You can set print orders for up to 998 still images.



Selecting Still Images for Printing (Print Order)

DC420 Set the print orders before connecting the supplied USB cable to the camcorder.

[FUNC.] [PRINT ORDER]

[0]: The image selection screen appears.

FROM THE IMAGE SELECTION SCREEN

- 1 Select (◀▶) the still image you want to mark with a print order.
- 2 Press to set the print order. The number of copies appears in orange.

3 Set (▲▼) the number of copies desired and press .

To cancel the print order, set (▲▼) the number of copies to 0.

4 Repeat steps 1-3 to mark additional images with print orders or press [FUNC.] twice to close the menu.

DC420 Printing the Still Images Marked with Print Orders Using Direct Print

1 Connect the camcorder to the printer using the supplied USB cable.

Connection [2]. Refer to *Connection Diagrams* (□ 64).

2 Open the print menu.

[FUNC.] ◀ [CAM MENU] ▶

[▶] [PRINT]

- The print menu appears.
- If there are no photos marked with print orders, [SET] [PRINT ORDER] appears.
- Depending on the connected printer, you may be able to change some print settings (□ 59).

3 Select (▲▼, ◀▶) [PRINT] and press .

Printing starts. The print menu disappears when the printing is completed.

i NOTES

- To cancel the printing, refer to page 61.
- **Restarting Printing:** Open the print settings menu as explained in step 2. In the print settings menu, select [PRINT]* or [RESUME] and press . The remaining images will be printed.

Printing cannot be restarted when the print order settings have been changed or if you deleted a still image with print order settings.

* In case the print order was interrupted after the first still image.

Erasing All Print Orders

[FUNC.] ◀
[CAM MENU] ▶
[STILL IMG OPER.] ▶
[ERASE ALL] [ORD] ▶
[YES] ▶
[FUNC.]



4



External Connections

This chapter explains how to connect your camcorder to an external device such as a TV, VCR or (in the case of a **DC420** only) a printer.

Terminals on the Camcorder

DC420

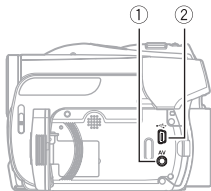

Open the LCD panel to access.

DC410

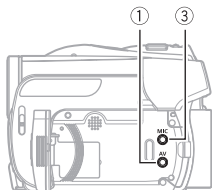

AV



① **AV Terminal**

Sound from the built-in speaker will be muted while the STV-250N Stereo Video Cable is connected to the camcorder.



② **USB Terminal**

DC420 only.

MIC



③ **MIC Terminal**

DC410 only. Use to connect an external microphone (□ 44).

Connection Diagrams

In the following connection diagrams, the left side shows the terminals on the camcorder and the right side shows (for reference only) an example of terminals on a connected device.

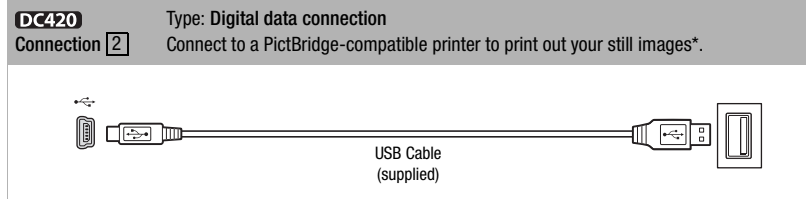
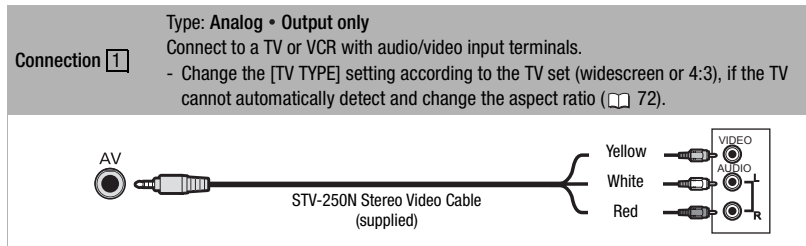

* Users of Windows Vista, Windows XP and Mac OS X: Your camcorder is equipped with the standard Picture Transfer Protocol (PTP) allowing you to transfer still images (JPEG only) by connecting the camcorder to a computer using the supplied USB cable.



Playback on a TV Screen

This section explains how to play back the disc or still images with this camcorder by connecting it to a TV. To play back the disc with another DVD device refer to *Disc Playback on an External Device* (□ 47).



- 1 Turn off the camcorder and the TV.**
- 2 Connect the camcorder to the TV.**
Connection **1**. Refer to *Connection Diagrams* (□ 64).
- 3 Turn on the connected TV.**
On the TV, select as the video input the same terminal to which you connected the camcorder.
- 4 Turn on the camcorder and start the playback of movies (□ 33) or still images (□ 53).**

NOTES

- Sound from the built-in speaker will be muted while the STV-250N Stereo Video Cable is connected to the camcorder.
- We recommend powering the camcorder using the compact power adapter.
- Refer also to the instruction manual of the connected TV.

Copying your Recordings to an External Video Recorder

You can copy your recordings by connecting the camcorder to a VCR or a digital video device with analog audio/video input terminals.



Connecting

Connect the camcorder to the VCR or digital device using connection **1**. Refer to *Connection Diagrams* (□ 64).

Recording

- 1 External device: Load a blank cassette or disc and set the device to record pause mode.**
- 2 Camcorder: Locate the scene you wish to copy and pause playback shortly before the scene.**
- 3 Camcorder: Resume the movie playback.**
By default, on-screen displays will be embedded in the output video signal. You can change the displays by repeatedly pressing **[DISP.]** (□ 43).
- 4 External device: Begin recording when the scene you wish to copy appears. Stop recording when copying is complete.**
- 5 Camcorder: Stop playback.**

NOTES

We recommend powering the camcorder using the compact power adapter.



Additional Information

This chapter contains troubleshooting advice, screen messages, handling and maintenance tips, and other information.

Appendix: Menu Options Lists

Menu items not available appear grayed out in the FUNC. menu or in black in the setup menus. For details about how to select an item, refer to *Using the Menus* (□ 21). For details about each function, see the reference page. Menu options without a reference page are explained below the tables.

FUNC. Menu

Menu item	Setting options	CAMERA		PLAY		□
Recording programs ¹	[] PROGRAM AE], [] SHUTTER-PRIO.AE], [] PORTRAIT], [] SPORTS], [] NIGHT], [] SNOW], [] BEACH], [] SUNSET], [] SPOTLIGHT], [] FIREWORKS]	●	●	–	–	36, 38
White balance ¹	[] AUTO], [] DAYLIGHT], [] TUNGSTEN], [] SET]	●	●	–	–	41
Image effects ¹	[] IMAGE EFFECT OFF], [] VIVID], [] NEUTRAL], [] SOFT SKIN DETAIL]	●	●	–	–	42
LCD video light	[] LCD LIGHT OFF], [] LCD LIGHT ON]	●	●	–	–	39
Digital effects ¹	[] D.EFFECT OFF], [] FADE-T], [] WIPE], [] BLK&WHT], [] SEPIA], [] ART], [] MOSAIC]	●	–	–	–	42
	[] D.EFFECT OFF], [] BLK&WHT], [] SEPIA]	–	●	–	–	
Recording mode	[] HIGH QUALITY 9 Mbps], [] STANDARD PLAY 6 Mbps], [] LONG PLAY 3 Mbps]	●	–	–	–	30
DC420 Drive mode ¹	[] SINGLE], [] CONT.SHOOT.], [] HISPEED CONT.SHOOT.], [] AEB]	–	●	–	–	56



FUNC. Menu (cont.)

Menu item	Setting options	CAMERA		PLAY		Bookmarks
Still image size/quality	Size: DC420 [LW 1152x648], [L 1152x864], [S 640x480] DC410 [L 1024x768], [S 640x480] Quality: [SUPER FINE], [FINE], [NORMAL]	-	●	-	-	52
[TO PLAYLIST] ²	-	-	-	●	-	45
[TO ORIGINAL] ³	-	-	-	●	-	45
[ADD TO PLAYLIST] ²	[ALL SCENES], [ONE SCENE], [CANCEL]	-	-	●	-	45
[MOVE] ³	-	-	-	●	-	46
[DIVIDE] ³	-	-	-	●	-	46
[DELETE] ⁴	[NO], [YES]	-	-	●	-	35
[SPEAKER VOL.] ⁵	-.....+++++	-	-	●	-	34
[SLIDESHOW]	[CANCEL], [START]	-	-	-	●	55
[PROTECT]	-	-	-	-	●	57
[PRINT ORDER]	[0 - 99]	-	-	-	●	61

¹ Option available only when the mode switch is set to .







² Option available only in the original index screen with DVD-RW discs in VR mode.

³ Option available only in the playlist index screen with DVD-RW discs in VR mode.

⁴ Option available only with DVD-RW discs in VR mode.

⁵ Option available only during playback.

CAMERA SETUP

Menu item	Setting options	CAMERA		
				
[A.SL SHUTTER] ¹	[ON ON], [OFF OFF]	●	●	–
[ZOOM TYPE]	DC420 [37x OPTICAL], [48x ADVANCED] ² , [2000x DIGITAL] DC410 [37x OPTICAL], [41x ADVANCED] ³ , [2000x DIGITAL]	●	–	30
[ZOOM SPEED]	[VAR VARIABLE], [>>> SPEED 3], [>> SPEED 2], [> SPEED 1]	●	●	31
[IMG STAB] ⁴	[ON ON ()], [OFF OFF]	●	–	–
[FOCUS PRI.] ⁴	[AiAF ON:AiAF], [ ON:CENTER], [OFF OFF]	–	●	–
[REVIEW]	[OFF OFF], [2sec 2 sec], [4sec 4 sec], [6sec 6 sec], [8sec 8 sec], [10sec 10 sec]	–	●	–
[WIDESCREEN]	[ON ON], [OFF OFF]	●	–	30
[SELF TIMER]	[ON ON ()], [OFF OFF]	●	●	39
[WIND SCREEN] ⁴	[A AUTO], [OFF OFF ()]	●	–	–



¹ Option available only when the mode switch is set to **EASY** or **P** (only in the **P** PROGRAM AE recording program).

² [**55x** **ADVANCED**] when [WIDESCREEN] is set to [**OFF** OFF].

³ Not available when [WIDESCREEN] is set to [**OFF** OFF].

⁴ Option available only when the mode switch is set to **P**.

[A.SL SHUTTER]: The camcorder automatically uses slow shutter speeds to obtain brighter recordings in places with insufficient lighting.

- The camcorder uses shutter speeds down to 1/30 (1/15 in **CAMERA** -  mode).
- If a trailing afterimage appears, set the slow shutter to [**OFF** OFF].
- If  (camcorder shake warning) appears, we recommend stabilizing the camcorder, for example, by mounting it on a tripod.

[IMG STAB]: The image stabilizer compensates for camcorder shake even at full telephoto.

- The image stabilizer is designed to compensate for a normal degree of camcorder shake. **DC410** The image stabilizer may not be able to successfully eliminate all blur if the camcorder or the subject is moving too much.
- The image stabilizer may not be effective when recording in dark places with [A.SL SHUTTER] set to [**ON** ON] or using the [] NIGHT recording program.
- **DC410** The image stabilizer may not work well on subjects with low contrast, with a recurring, repetitive pattern or without vertical lines.
- The image stabilizer cannot be turned off when the mode switch is set to **EASY**.
- We recommend setting the image stabilizer to [**OFF** OFF] when using a tripod.



[FOCUS PRI.]: When the focus priority is activated, the camcorder records a still image only after the focus has been adjusted automatically. You can also select which AF frames to use.

[ON: AiAF]: One or more AF frames out of the nine frames available are automatically selected and the focus is fixed on them.

[ON: CENTER]: A single focusing frame appears in the center of the screen and the focus is automatically fixed on it.

[OFF]: No AF frame will appear and the still image will be recorded immediately after pressing [Start/Stop].

- When the recording mode is set to [FIREWORKS], focus priority is automatically set to [OFF].

[REVIEW]: Selects the time to display a still image after it has been recorded.

• **[DC420]** This menu item will not be available when the drive mode (56) is set to [CONT.SHOOT.], [HISPEED CONT.SHOOT.] or [AEB].

- If you press [DISP.] while reviewing a still image it will continue to be displayed indefinitely. Press [Start/Stop] to return to the normal display.

[WIND SCREEN]: The camcorder automatically reduces the background sound of wind when recording outdoors.

- Some low-frequency sounds will be suppressed along with the sound of wind. When recording in surroundings unaffected by wind or if you want to record low-frequency sounds, we recommend setting the wind screen to [OFF].

DISC OPERATIONS

Menu item	Setting options	CAMERA	PLAY	
[DISC INFO]	–	●	●	–
[INITIALIZE DISC] ¹	[VIDEO], [VR], [CANCEL]	●	●	47
[FINALIZE]	[NO], [YES]	–	●	48
[UNFINALIZE] ²	[NO], [YES]	–	●	49
[DEL.ALL MOVIES] ³	[NO], [YES]	–	●	35
[DEL.PLAYLIST] ⁴	[NO], [YES]	–	●	45
[DISC TITLE]	–	–	●	47

¹ Option available only with DVD-RW discs.

² Option available only with finalized DVD-RW discs in VIDEO mode.



³ Option available only in the original index screen with DVD-RW discs in VR mode.

⁴ Option available only in the playlist index screen with DVD-RW discs in VR mode.



















[DISC INFO]: Displays a screen where you can check the disc's details.

- Disc information includes the disc title, the disc type (DVD-R, DVD-R DL or DVD-RW), the disc specification (VIDEO mode or VR mode), and an icon to indicate whether the disc is finalized (). Additionally, the total recorded time is displayed for non-finalized discs.
- The remaining recording time of finalized discs will appear as [--min].

STILL IMG OPER.

Menu item	Setting options	PLAY	
			
[ERASE ALL  ORD]	[NO], [YES]	●	62
[ERASE ALL IMAGES]	[NO], [YES]	●	55
[INITIALIZE CARD]	[INITIALIZE], [COMPL.INIT.], [CANCEL]	●	57

DISPLAY SETUP

Menu item	Setting options	CAMERA		PLAY		
						
[BRIGHTNESS]		●	●	●	●	–
[TV SCREEN]	[ ON], [ OFF]	●	●	–	–	–
[DATA CODE]	[ DATE], [ TIME], [ DATE & TIME], [ CAMERA DATA]	–	–	●	–	–
[MARKERS]	[ OFF] OFF], [ W LEVEL(WHT)], [ G LEVEL(GRY)], [ GRID(WHT)], [ G GRID(GRY)]	●	●	–	–	–
[LANGUAGE]	[ČEŠTINA], [DEUTSCH], [ΕΛΛΗΝΙΚΑ], [ENGLISH], [ESPAÑOL], [FRANÇAIS], [ITALIANO], [MAGYAR], [MELAYU], [NEDERLANDS], [POLSKI], [PORTUGUÊS], [ROMÂNĂ], [TÜRKÇE], [РУССКИЙ], [УКРАЇНСЬКА], [العربية], [فارسی], [ภาษาไทย], [简体中文], [繁體中文], [한국어], [日本語]	●	●	●	●	23
[DEMO MODE]	[ ON], [ OFF]	●	●	–	–	–

[BRIGHTNESS]: Adjust (◀▶) the brightness of the LCD screen.

- Changing the brightness of the LCD screen does not affect the brightness of the recordings or that of the playback picture on a connected TV.

[TV SCREEN]: When set to [ ON], the camcorder's on-screen displays will appear also on the screen of a connected TV or monitor.

[DATA CODE]: Displays the date and/or time when the scene was recorded.

[ CAMERA DATA]: Displays the aperture (f-stop) and shutter speed used when recording the scene.

[MARKERS]: You can display a grid or a horizontal line at the center of the screen. Use the markers as a reference to make sure your subject is framed correctly (vertically and/or horizontally).

- Using the markers will not affect the recordings.



[DEMO MODE]: The demonstration mode displays the camcorder's main features. It starts automatically when the camcorder is powered with the compact power adapter if you leave it turned on without loading a disc or memory card for more than 5 minutes.

- To cancel the demo mode once it started, press any button, turn off the camcorder or load a disc.

SYSTEM SETUP

Menu item	Setting options	CAMERA		PLAY		
[SPEAKER VOL.]		-	-	●	-	-
[BEEP]	[HIGH VOLUME], [LOW VOLUME], [OFF OFF]	●	●	●	●	-
[POWER SAVE]	[ON ON], [OFF OFF]	●	●	●	●	-
[QUICK START]	[OFF OFF], [10min 10 min], [20min 20 min], [30min 30 min]	●	●	-	-	-
[IMG NUMBERS]	[RESET], [CONTINUOUS]	-	●	-	-	-
[TV TYPE]	[4:3 NORMAL TV], [16:9 WIDE TV]	●	●	●	●	-
[FIRMWARE]	-	-	-	-	●	-

[SPEAKER VOL.]: Adjust () the volume of the playback.

[BEEP]: A beep will accompany some operations like turning on the camcorder, the self-timer countdown, etc. It also serves as a warning beep under unusual conditions.

[POWER SAVE]: In order to save power when the camcorder is powered by a battery pack, it will automatically shut off if left without any operation for 5 minutes.

- Approximately 30 seconds before the camcorder shuts off, [AUTO POWER OFF] will appear.
- In standby mode, the camcorder will shut off after the time selected for the [QUICK START] setting.

[QUICK START]: Select whether to activate the Quick Start function when you close the LCD panel in a recording mode (32) and the length of time after which the camcorder will end the standby mode and shut off automatically.

[IMG NUMBERS]: Select the image numbering method to be used when you insert a new memory card. Still images are automatically assigned consecutive image numbers from 0101 to 9900, and stored in folders containing up to 100 images. Folders are numbered from 101 to 998.

[RESET]: Image numbers will restart from 101-0101 every time you insert a new memory card.

[CONTINUOUS]: Image numbers will continue from the number following that of the last image recorded with the camcorder.

- If the memory card you insert already contains an image with a larger number, a new image will be assigned a number, one higher than that of the last image on the memory card.
- We recommend using the [CONTINUOUS] setting.

[TV TYPE]: In order to display the picture in full and in the correct aspect ratio, select the setting according to the type of television to which you will connect the camcorder.





[4:3 NORMAL TV]: TV sets with 4:3 aspect ratio.

[16:9 WIDE TV]: TV sets with 16:9 aspect ratio.

- If the camcorder is connected to a widescreen TV with the TV type set to **[4:3 NORMAL TV]**, during the playback of video originally recorded with an aspect ratio of 16:9, the picture will not be displayed full screen.

[FIRMWARE]: You can verify the current version of the camcorder's firmware. This menu option is usually unavailable.

DATE/TIME SETUP

Menu item	Setting options	CAMERA		PLAY		
						
[T.ZONE/DST]	List of world time zones.	●	●	●	●	24
[DATE/TIME]	–	●	●	●	●	23
[DATE FORMAT]	[Y.M.D (2009.1.1 AM 12:00)], [M.D,Y (JAN. 1, 2009 12:00 AM)], [D.M.Y (1.JAN.2009 12:00 AM)]	●	●	●	●	–

[DATE FORMAT]: Changes the date format for on-screen displays and, if this option is selected, for the date printed on photos using Direct Print (**DC420** only).



Troubleshooting

If you have a problem with your camcorder, refer to this section. Sometimes what you think is a malfunction of the camcorder may have the simplest of solutions - please read the “CHECK THIS FIRST” box before going on to the more detailed problems and solutions. Consult your dealer or a Canon Service Center if the problem persists.

CHECK THIS FIRST

Power supply

Is the battery charged? Is the compact power adapter correctly connected to the camcorder? (□ 18)

Recording

Did you turn the camcorder on and set and set it to **CAMERA** (with battery icon) or **CAMERA** (with camera icon) mode? Is the CAMERA indicator lit up in green? Was the disc or memory card correctly inserted into the camcorder? (□ 25, 27)

Playback

Did you turn the camcorder on and set and set it to **PLAY** (with battery icon) or **PLAY** (with camera icon) mode? Is the PLAY indicator on? Was the disc or memory card correctly inserted into the camcorder? (□ 25, 27) Does it contain any recordings?

Power Source

The camcorder will not turn on or it turns off by itself.

- The battery pack is exhausted. Replace or charge the battery pack (□ 18).
- Remove the battery pack and reattach it correctly.

Cannot charge the battery pack.

- Charge the battery pack in temperatures between 0 °C and 40 °C (32 °F and 104 °F).
- The battery pack is too hot. Charging will start once the battery pack temperature is below 40 °C (104 °F).
- The battery pack is damaged. Use a different battery pack.

After using the camcorder for a long time, it becomes hot.

- This is not a malfunction. Turn off the camcorder and let it cool down before resuming use.

Recording

Pressing **Start/Stop** will not start recording.

- Use a disc whose performance has been tested with this camcorder (□ 7).
- The disc is full (“END” appears on the screen). Delete some recordings (DVD-RW in VR mode) to free some space (□ 35) or replace the disc.
- Unfinalize (□ 49) the disc (DVD-RW in VIDEO mode).
- The camcorder has exceeded its operational temperature. Turn off the camcorder and let it cool down before resuming use.

The point where **Start/Stop** was pressed does not match the beginning/end of the recording.

- There is a slight interval between pressing **Start/Stop** and the actual start of recording. This is not a malfunction.

The recording suddenly stops shortly after starting recording.

- The disc is dirty. Clean the disc with a soft lens-cleaning cloth (□ 81). If the problem persists replace the disc.
- The camcorder has exceeded its operational temperature. Turn off the camcorder and let it cool down before resuming use.

The camcorder will not focus.

- Autofocus does not work on the subject. Focus manually (□ 40).
- Adjust the viewfinder with the diopter adjustment lever (□ 29).
- The lens is dirty. Clean the lens with a soft lens-cleaning cloth (□ 83). Never use tissue paper to clean the lens.

Playback

Cannot play back the disc.

- You may not be able to play with this camcorder, discs recorded or edited with other DVD recorders or computer DVD drives.
- If using a single-sided disc, check that the disc is inserted with the label side facing up.
- The camcorder has exceeded its operational temperature. Turn off the camcorder and let it cool down before resuming use.

• During playback there is video noise and the sound is distorted.

• The disc cannot be recognized.

- The disc is dirty. Clean the disc with a soft lens-cleaning cloth (□ 81).
- You may not be able to play with this camcorder, discs recorded or edited with other DVD recorders or computer DVD drives.

Cannot add scenes to the playlist.

- The disc is full (“END” appears on the screen). Delete some recordings to free some space (□ 35).
- The playlist can contain a maximum of 999 scenes.

Cannot divide the scene.

- You cannot edit or delete scenes on a disc that was recorded using another digital device.

- You cannot divide the scene if there are already 999 scenes on the disc.
- You cannot divide original scenes.
- You cannot divide the scene if it is too short (2 seconds or less).

Cannot edit the disc title.

- You cannot add a title to a DVD-R/DVD-R DL disc after it was finalized (□ 48).
- Unfinalize (□ 49) the disc first (DVD-RW in VIDEO mode).
- You may not be able to edit the title if you entered it using another digital device.

Cannot edit or delete scenes.

- You cannot edit or delete scenes on a disc that was protected using another digital device.
- Scenes cannot be deleted in a DVD-R/DVD-R DL disc or a DVD-RW disc recorded in VIDEO mode.

Cannot finalize the disc.

- The camcorder has exceeded its operational temperature. Turn off the camcorder and let it cool down before resuming use.
- Power the camcorder using the compact power adapter or use a fully charged battery pack.

Cannot delete a still image.

- The still image is protected. Remove the protection (□ 57).

Indicators and Onscreen Displays

lights up in red.

- Battery pack is exhausted. Replace or charge the battery pack (□ 18).

appears on the screen.

- Load a disc (□ 25).

lights up in red.

- A memory card error occurred. Turn off the camcorder. Remove and reinsert the memory card. Initialize the memory card (□ 57) if the display does not change back to normal.

lights up in red.

- The camcorder has exceeded its operational temperature. This is not a malfunction. Turn off the camcorder and let it cool down before resuming use.



Even after stopping recording, the DISC access indicator does not go out.

- The scene is being recorded on the disc. This is not a malfunction.

The CHARGE indicator flashes rapidly.



- (one flash at 0.5-second intervals)
Charging has stopped because the compact power adapter or the battery pack is faulty. Consult a Canon Service Center.

The CHARGE indicator flashes very slowly.

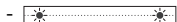

- (one flash at 2-second intervals)
The battery pack is too hot. Charging will start once the battery pack temperature is below 40 °C (104 °F).
- Charge the battery pack in temperatures between 0 °C and 40 °C (32 °F and 104 °F).
- The battery pack is damaged. Use a different battery pack.

Picture and Sound

Screen displays turn on and off repeatedly.

- The battery pack is exhausted. Replace or charge the battery pack (□ 18).
- Remove the battery pack and reattach it correctly.

Abnormal characters appear on the screen and the camcorder does not operate properly.

- Disconnect the power source and reconnect it after a short time. If the problem still persists, disconnect the power source and press the RESET button with a pointed item. Pressing the RESET button resets all settings.

Video noise appears on screen.

- Keep a distance between the camcorder and devices that emit strong electromagnetic fields (plasma TVs, cellular phones, etc.).

A vertical light bar appears on the screen.

- Bright light in a dark scene may cause a vertical light bar (smear) to appear. This is not a malfunction.

No picture appears on the viewfinder.

- Press [VIEWFINDER] to activate the viewfinder (□ 29).

Viewfinder picture is blurred.

- Adjust the viewfinder with the diopter adjustment lever (□ 29).

Sound is distorted or is recorded at lower levels.

- When recording near loud sounds (such as fireworks, shows or concerts), sound may become distorted or it may not be recorded at the actual levels. This is not a malfunction.

Even without a disc loaded, when closing the disc compartment cover a motor sound can be heard.

- The camcorder is checking if a disc is loaded or not. This is not a malfunction.

• The disc's rotation can be heard faintly.

• Occasionally, the camcorder's operation sound can be heard.

- The disc is activated from time to time. This is not a malfunction.

The picture is displayed correctly but there is no sound from the built-in speaker.

- Open the LCD panel.
- Speaker volume is turned off. Adjust the volume (□ 34).
- If the STV-250N Stereo Video Cable is connected to the camcorder, disconnect it.

The camcorder vibrates.

- The camcorder may vibrate occasionally. This is not a malfunction.

Memory Card and Accessories

Cannot open the disc cover to remove the disc.

- Turn off the camcorder, disconnect the compact power adapter and remove the battery pack. Restore the power supply and try again.
- The camcorder has exceeded its operational temperature. Turn off the camcorder and let it cool down before resuming use.

The disc cannot be recognized.

- The disc is dirty. Clean the disc with a soft lens-cleaning cloth (□ 81). If the problem persists replace the disc.
- The disc is not correctly loaded. Check the disc (□ 25).
- Verify that the camcorder supports the type of DVD disc you inserted (□ 5).

Cannot insert the memory card.

- The memory card was not facing the correct direction. Turn the memory card over and insert it (□ 27).

Cannot record on the memory card.

- The memory card is full. Erase some still images (□ 55) to free some space or replace the memory card.
- Initialize the memory card (□ 57) when you use it with the camcorder for the first time.
- The LOCK switch on an SD or SDHC memory card is set to prevent accidental erasure. Change the position of the LOCK switch (□ 82).
- The folder and file numbers have reached their maximum value. Set [IMG NUMBERS] to [RESET] (□ 71) and insert a new memory card.

Connections/Playback with External Devices

There is a brief stop between scenes.

- Depending on the DVD player, there might be a very short stop between scenes during playback.

The disc cannot be recognized by the device. Or, even though the disc is read, cannot play back the disc or the picture is distorted.

- Finalize the disc using the camcorder (□ 48).
- The disc is dirty. Clean the disc with a soft lens-cleaning cloth (□ 81).
- DVD-RW discs in VR mode can only be played back with VR mode-compatible DVD players. Refer to the instruction manual of your DVD device.

Cannot edit my recordings or add recordings to the disc with the DVD device.

- It may not be possible to edit or add recordings with an external DVD recorder on a disc recorded using this camcorder.

Video noise appears on the TV screen.

- When using the camcorder in a room where a TV is located, keep a distance between the compact power adapter and the power or antenna cables of the TV.

The disc is running but there is no image on the TV screen.

- The video input on the TV is not set to the video terminal to which you connected the camcorder. Select the correct video input.
- You attempted to play back an incompatible disc. Stop playback.

DC420 The computer doesn't recognize the camcorder even though the camcorder is connected correctly.

- Disconnect the USB cable and turn off the camcorder. After a short while, turn it on again and restore the connection.
- Connect the camcorder to a different USB port on the computer.

DC420 The printer is not working even though the camcorder and printer are connected correctly.

- Disconnect the USB cable and turn off the printer. After a short while turn it on again and restore the connection.

List of Messages (in alphabetical order)**CANNOT ENTER THE STANDBY MODE NOW**

- The camcorder cannot enter standby mode (□ 32) while the disc is being recognized after it was inserted or if the remaining battery charge is too low.

CANNOT PLAY BACK

- The disc is dirty or scratched, or you attempted to play back a disc type not supported by this camcorder (not DVD-R/RW).



- This message can also appear if condensation has formed. Wait until the camcorder dries completely before resuming use (□□ 84).

CANNOT READ THE DISC CHECK THE DISC

- Disc could not be recognized. Try cleaning it (□□ 81) or replace the disc.
- This message can also appear if the camcorder has exceeded its operational temperature. Turn off the camcorder and let it cool down before resuming use.
- This message can also appear if condensation has formed. Wait until the camcorder dries completely before resuming use (□□ 84).
- The disc may not be loaded correctly. Try removing the disc and reinserting it (□□ 25).

CANNOT RECORD

- There is a problem with the disc.
- This message can also appear if condensation has formed. Wait until the camcorder dries completely before resuming use (□□ 84).
- The disc's recording surface may be dirty or scratched.
- This message may appear when the camcorder is repeatedly subjected to vibrations.

CANNOT USE DISC USE OF A RECOMMENDED DISC IS ADVISED

- The disc cannot be used. We recommend that you use a disc whose performance has been tested with this camcorder (□□ 7).

CARD ERROR

- A memory card error occurred. The camcorder cannot record or display the image. The error may be temporary. If the message disappears after 4 seconds and □□ appears in red, turn the camcorder off, remove the card and reinsert the card. If □□ changes to green, you can resume recording/playback.

CARD FULL

- The memory card is full. Erase some still images (□□ 55) to free some space or replace the memory card.

CHANGE THE BATTERY PACK

- The battery pack is exhausted. Replace or charge the battery pack (□□ 18).

DISC ACCESS FAILURE CHECK THE DISC

- There was an error when reading the disc or attempting to write onto it. Try cleaning the disc (□□ 81) or replace it.
- This message can also appear if condensation has formed. Wait until the camcorder dries completely before resuming use (□□ 84).
- The disc may not be loaded correctly. Try removing the disc and reinserting it (□□ 25).

DISC COVER IS OPEN

- Verify the disc is correctly inserted and close the disc cover (□□ 25).

DISC FULL

- The disc is full (“END” appears on the screen). Delete some recordings (DVD-RW in VR mode) to free some space (□□ 35) or replace the disc.

DISC IS FINALIZED CANNOT RECORD

- You cannot record additional scenes on a finalized DVD-R/DVD-R DL disc.
- You cannot record additional scenes or unfinalize a DVD-RW disc in VIDEO mode that was finalized using another digital device.

DISC MUST BE FINALIZED (MODE) TO PLAY BACK IN COMPATIBLE PLAYERS

- Be sure to finalize the disc and check the compatibility of the device before playing back the disc on external DVD devices (□□ 48).

LOADING THE DISC

- The disc is being recognized. Wait before you start recording.

NAMING ERROR

- The folder and file numbers have reached their maximum value. Set [IMG NUMBERS] to [RESET] and erase all the images on the memory card (□□ 55) or initialize it (□□ 57).

NO CARD

- There is no memory card in the camcorder (□□ 27).

NO DISC

- There is no disc in the camcorder. Insert a disc (□ 25).
- This message can also appear if condensation has formed. Wait until the camcorder dries completely before resuming use (□ 84).

NO IMAGES

There are no still images on the memory card.

PRINT ORDER ERROR

- You attempted to set more than 998 still images in the print order (□ 61).

REACHED THE MAXIMUM NUMBER OF SCENES

- The maximum number of scenes has been reached. Delete some recordings (DVD-RW in VR mode) to free some space (□ 35) or replace the disc.

RECOVERING DATA PLEASE WAIT...

- Data on the disc is being recovered. Wait until this message disappears before resuming use.

TASK IN PROGRESS DO NOT DISCONNECT THE POWER SOURCE

- The camcorder is updating important file allocation data on the disc. Do not disconnect the compact power adapter or remove the battery pack under any circumstances.

• TEMPERATURE TOO HIGH CANNOT RECORD

• TEMPERATURE TOO HIGH CANNOT REMOVE DISC

- The camcorder has exceeded its operational temperature. Disconnect the compact power adapter and remove the battery pack. Let the camcorder cool down before resuming use.

DC420 TOO MANY STILL IMAGES DISCONNECT USB CABLE

- Disconnect the USB cable. Try using a memory card reader or decrease the number of still images on the memory card (Windows: fewer than 1,800 still images, Macintosh: fewer than 1,000 still images). If a dialog box appeared on the computer screen, close it and then reconnect the supplied USB cable.

UNABLE TO RECOGNIZE THE DATA

- The disc may not be recognized by this camcorder if it was initialized with a different device.
- You inserted a disc recorded in a different television system (PAL or SECAM).

UNABLE TO RECOVER DATA

- Could not recover a corrupted file.
- This message can also appear if condensation has formed. If you suspect condensation is the reason, do not initialize the disc and wait until the camcorder dries completely before resuming use (□ 84).

UNFINALIZE THE DISC

- You cannot record additional scenes on a finalized DVD-RW in VIDEO mode. Unfinalize the disc first (□ 49).

USE OF A RECOMMENDED DISC IS ADVISED

- The disc can be used but performance is not guaranteed. We recommend that you use a disc whose performance has been tested with this camcorder (□ 7).

DC420 Direct Print Related Messages

About Canon PIXMA/ SELPHY DS Printers: If the printer's error indicator flashes or an error message appears on the printer's operation panel, refer to the printer's instruction manual.

CANNOT PRINT!

- You attempted to print a still image that was recorded with another camcorder, has a different compression, or was edited on a computer.

COMMUNICATION ERROR

- The printer is experiencing a data transfer error. Cancel printing. Disconnect the USB cable and turn off the printer. After a while, turn the printer back on and reconnect the supplied USB cable.



- You attempted to print from a memory card that contains a large number of still images. Reduce the number of still images. Reduce the number of still images.

COULD NOT PRINT X IMAGES

- You attempted to use the print order settings to print X images that were recorded with another camcorder, with a different compression or were edited on a computer.

FILE ERROR

- You attempted to print an image that was recorded with another camcorder, has a different compression, or was edited on a computer.

HARDWARE ERROR

- Cancel printing. Turn off the printer and turn it back on. Check the printer status. If the printer is equipped with a battery, it might be exhausted. In such case, turn off the printer, replace the battery and turn it back on.
- Ink tank errors have occurred. Replace the ink tank.

INCOMPATIBLE PAPER SIZE

- The paper settings of the camcorder conflict with the printer's settings.

INK ABSORBER FULL

- Select [CONTINUE] to resume printing. Consult a Canon Service Center (refer to the list included with the printer) to replace the ink absorber.

INK ERROR

- There is a problem with the ink. Replace the ink cartridge.

LOW INK LEVEL

- The ink cartridge needs to be replaced soon. Select [CONTINUE] to restart printing.

NO INK

- The ink cartridge is not inserted or is out of ink.

NO PAPER

- Paper is not correctly inserted or there is no paper.

NO PRINTHEAD

- No print head is installed in the printer or the print head is defective.

PAPER ERROR

- There is a problem with the paper. The paper is not correctly loaded or the paper size is wrong. Alternatively, if the paper output tray is closed, open it to print.

PAPER JAM

- The paper jammed during printing. Select [STOP] to cancel printing. After removing the paper, set some paper again and retry printing.

PAPER LEVER ERROR

- Paper lever error occurred. Adjust the paper selection lever to the proper position.

PRINT ERROR

- Cancel printing, disconnect the USB cable and turn off the printer. After a while, turn the printer back on and reconnect the supplied USB cable. Check the printer status.

PRINTER COVER OPEN

- Close the printer cover securely.

PRINTER ERROR

- A malfunction has occurred that may require repairs. (Canon PIXMA printers: the printer's green power lamp and orange error lamp flash alternately.)
- Disconnect the USB cable and turn off the printer. Unplug the printer's power cord from the power outlet and contact the appropriate customer support center or service center.

PRINTER IN USE

- The printer is in use. Check the printer status.

SET PRINT ORDER

- No still images have been marked with a print order.

Handling Precautions

Camcorder

- Do not touch the pick up lens.
- Do not subject the camcorder to vibrations or strong impacts while the DISC access indicator is on or flashing. The data may not be correctly recorded on the disc, and the recording may be permanently lost.
- Do not carry the camcorder by the LCD panel or the disc cover. Be careful when closing the LCD panel.
- Do not leave the camcorder in places subject to high temperatures (like the inside of a car under direct sunlight), or high humidity.
- Do not use the camcorder near strong electromagnetic fields such as above TVs, near plasma TVs or mobile phones.
- Do not point the lens or viewfinder at strong light sources. Do not leave the camcorder pointed at a bright subject.
- Do not use or store the camcorder in dusty or sandy places. The camcorder is not waterproof – avoid also water, mud or salt. If any of the above should get into the camcorder it may damage the camcorder and/or the lens. Be sure to close the disc compartment cover after use.
- Be careful of heat generated by lighting equipment.
- Do not disassemble the camcorder. If the camcorder does not function properly, consult qualified service personnel.

- Handle the camcorder with care. Do not subject the camcorder to shocks or vibration as this may cause damage.
- When mounting the camcorder on a tripod, make sure that the tripod's fastening screw is shorter than 5.5 mm (0.2 in.). Using other tripods may damage the camcorder.

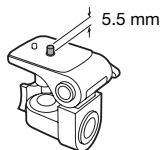

- **When recording movies, try to get a calm, stable picture.**
Excessive camcorder movement while shooting and extensive use of fast zooms and panning can result in jittery scenes. In extreme cases, the playback of such scenes may result in visually induced motion sickness. If you experience such a reaction, immediately stop the playback and take a rest break as necessary.

Long-term storage

If you do not intend to use the camcorder for a long time, store it in a place free of dust, in low humidity, and at temperatures not higher than 30 °C (86 °F).



Battery Pack

DANGER!

Treat the battery pack with care.

- Keep it away from fire (or it might explode).
- Do not expose the battery pack to temperature higher than 60 °C (140 °F). Do not leave it near a heater or inside a car in hot weather.
- Do not try to disassemble or modify it.
- Do not drop it or subject it to shocks.
- Do not get it wet.

CAUTION:

Danger of explosion if battery is incorrectly attached. Attach only with the same type.

- Attach the terminal cover whenever a battery pack is not in use. Contact with metallic objects may cause a short circuit and damage the battery pack.
- Dirty terminals may cause a poor contact between the battery pack and the camcorder. Wipe the terminals with a soft cloth.

Long-term storage

- Store battery packs in a dry place at temperatures no higher than 30 °C (86 °F).
- To extend the battery life of the battery pack, discharge it completely before storing it.
- Charge and discharge all your battery packs fully at least once a year.

About the battery terminal cover

The battery terminal cover has a [□]-shaped hole. This is useful when you wish to differentiate between charged and uncharged battery packs.

Back side of the battery pack

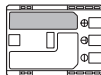

Terminal cover attached



Charged



Uncharged

Mini DVD Disc

The recording surface of DVD discs is extremely delicate. If handled or stored in an incorrect manner, the camcorder may stop recognizing or may not be able to play back the disc. Be sure to observe the following precautions when storing/handling your discs.

- **Always remove the disc from the camcorder after you finish recording.**
 - Do not store the camcorder with a disc left inside.
- Keep the disc clean of dust, dirt or smudges. Even very small smudges or particles of dust can lead to problems when recording or playing back the disc. Carefully inspect the recording surface of the disc before inserting it in the camcorder. If the disc gets dirty use a dry, soft lens-cleaning cloth to remove any fingerprints, dirt buildup or smudges from the disc surface. Clean the disc in a radial motion from its center outwards.
- Never use a chemically treated cloth or flammable solvents such as paint thinner to clean the disc.
- Do not bend, scratch or wet the disc and do not subject it to strong shocks.

- Do not attach any labels or stickers on the disc surfaces. The disc may not rotate in a stable manner and this may cause malfunctions.
- To protect the disc, return it to its case for storage.
- When writing on the label side of the disc, avoid hard tip pens. Use waterproof soft-tipped felt pens instead.
- Moving a disc rapidly between hot and cold temperatures may cause condensation to form on its surfaces. If condensation forms on the disc, put it aside until the water droplets have evaporated completely.
- Never expose the disc to direct sunlight and do not store it in places subject to high temperatures or high humidity.
- Always finalize a disc before inserting it into an external DVD device. Failing to do so can result in the loss of the recorded data.

- Check the direction before inserting the memory card. Forcing a memory card into the slot if it is not correctly oriented may damage the memory card or the camcorder.
- Do not attach any labels or stickers on the memory card.
- SD/SDHC memory cards have a physical switch to prevent writing on the card so as to avoid the accidental erasure of the card's content. To write-protect the memory card set the switch to the LOCK position.



Memory Card

- We recommend backing up the still images recorded on the memory card onto your computer. Data may be corrupted or lost due to memory card defects or exposure to static electricity. Canon shall not be liable for lost or corrupted data.
- Do not touch or expose the terminals to dust or dirt.
- Do not use memory cards in places subject to strong magnetic fields.
- Do not leave memory cards in places subject to high humidity and high temperature.
- Do not disassemble, bend, drop, or subject memory cards to shocks and do not expose them to water.

Disposal

When you erase still images or initialize the memory card, only the file allocation table is altered and stored data is not physically erased. Take the necessary precautions when you dispose of the memory card, for example by physically damaging it to prevent the leakage of private data.

If giving the memory card to another person, initialize it using the [COMPL.INIT.] option (□ 57). Fill it up with unimportant still images, and then initialize it again using the same option. This makes recovering the original still images very difficult.



Built-in Rechargeable Lithium Battery

The camcorder has a built-in rechargeable lithium battery to keep the date/time and other settings. The built-in lithium battery is recharged while you use the camcorder; however, it will become totally discharged if you do not use the camcorder for about 3 months.

To recharge the built-in lithium battery:

Connect the compact power adapter to the camcorder and leave it connected for 24 hours with the **POWER** switch set to **OFF**.

Maintenance/Others

Cleaning

Camcorder Body

- Use a soft, dry cloth to clean the camcorder body. Never use chemically treated cloths or volatile solvents such as paint thinner.

Pick Up Lens

- Remove any dust or dirt particles using a non-aerosol type blower brush. Never touch the pick up lens directly to clean it.

Lens and Viewfinder

- If the lens surface is dirty, the autofocus may not work properly.
- Remove any dust or dirt particles using a non-aerosol type blower brush.
- Use a clean, soft lens-cleaning cloth to gently wipe the lens or viewfinder. Never use tissue paper.

LCD Screen

- Clean the LCD screen using a clean, soft lens-cleaning cloth.
- Condensation may form on the surface of the screen when the temperature changes suddenly. Wipe it with a soft dry cloth.

Condensation

Moving the camcorder rapidly between hot and cold temperatures may cause condensation (water droplets) to form on its internal surfaces. Stop using the camcorder if condensation is detected. Continued use may damage the camcorder.

Condensation may form in the following cases:

- When the camcorder is moved quickly from cold to warm places
- When the camcorder is left in a humid room
- When a cold room is heated rapidly

TO AVOID CONDENSATION

- Do not expose the camcorder to sudden or extreme changes in temperature.
- Remove the disc and memory card and the camcorder in an airtight plastic bag. Let the camcorder adjust to temperature changes slowly before removing it from the bag.

WHEN CONDENSATION IS DETECTED

- If a disc is loaded, remove the disc immediately and leave the disc cover open. Leaving the disc in the camcorder may damage it.
- A disc cannot be loaded when condensation is detected.

RESUMING USE

The precise time required for water droplets to evaporate will vary depending on the location and weather conditions. As a general rule, wait for 2 hours before resuming use of the camcorder.

Using the Camcorder Abroad

Power Sources

You can use the compact power adapter to operate the camcorder and charge battery packs in any country with power supply between 100 and 240 V AC, 50/60 Hz. Consult a Canon Service Center for information on plug adapters for overseas use.

Playback on a TV Screen

You can only play back your recordings on TVs compatible with the NTSC system. NTSC is used in the following regions/countries:

Americas: All of North America and Central America; most Caribbean islands (except in French territories like Guadeloupe and Martinique); most of South America (except in Argentina, Brazil and Uruguay). **Asia:** Only in Japan, the Philippines, South Korea, Taiwan and Myanmar. **Oceania:** US territories (Guam, American Samoa, etc.) and some Pacific islands like Micronesia, Samoa and Tonga.



Trademark Acknowledgements

- The SD logo is a trademark. The SDHC logo is a trademark.
- Microsoft, Windows and Windows Vista are trademarks or registered trademarks of Microsoft Corporation in the United States and/or other countries.
- Macintosh and Mac OS are trademarks of Apple Inc., registered in the U.S. and other countries.
-  is a trademark of DVD Format/Logo Licensing Corporation.
- Manufactured under license from Dolby Laboratories.
"Dolby" and the double-D symbol are trademarks of Dolby Laboratories.
- Other names and products not mentioned above may be trademarks or registered trademarks of their respective companies.
- ANY USE OF THIS PRODUCT OTHER THAN CONSUMER PERSONAL USE IN ANY MANNER THAT COMPLIES WITH THE MPEG-2 STANDARD FOR ENCODING VIDEO INFORMATION FOR PACKAGED MEDIA IS EXPRESSLY PROHIBITED WITHOUT A LICENSE UNDER APPLICABLE PATENTS IN THE MPEG-2 PATENT PORTFOLIO, WHICH LICENSE IS AVAILABLE FROM MPEG LA, L.L.C., 250 STEELE STREET, SUITE 300, DENVER, COLORADO 80206.



System Diagram (Availability differs from area to area)

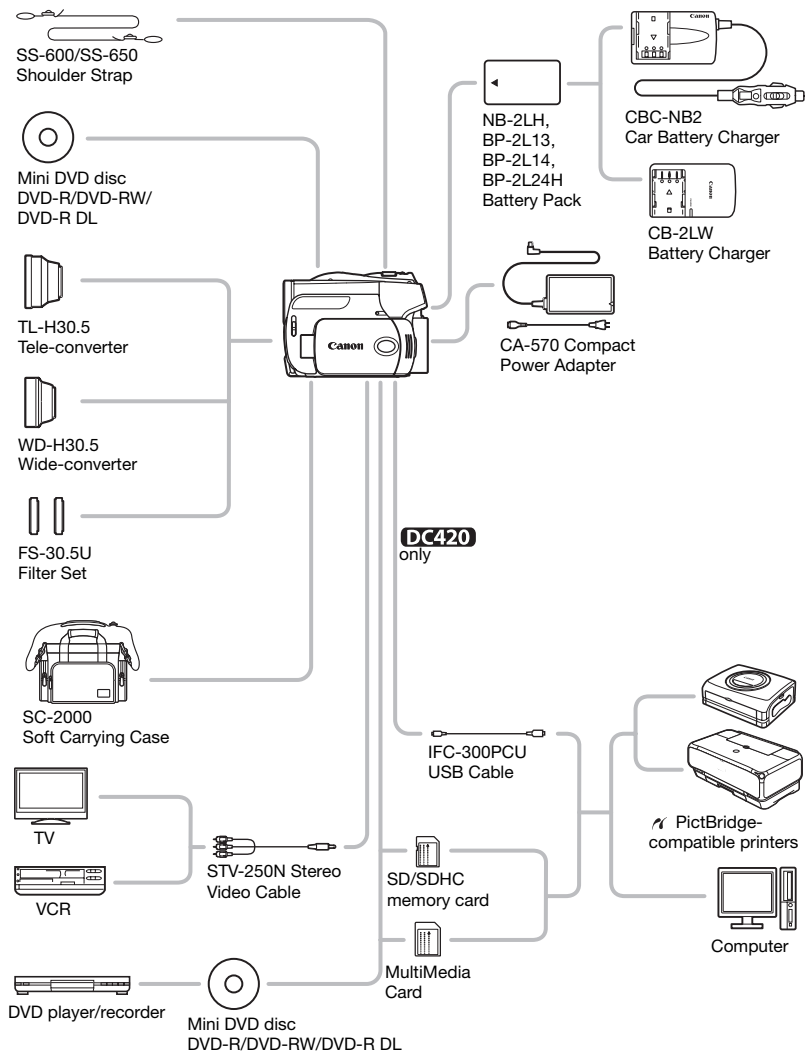

Optional Accessories

Call or visit your local retailer/dealer for genuine Canon video accessories. You can also obtain genuine accessories for your Canon camcorder by calling: 1-800-828-4040, Canon U.S.A. Information Center.

Use of genuine Canon accessories is recommended.

This product is designed to achieve excellent performance when used with genuine Canon accessories. Canon shall not be liable for any damage to this product and/or accidents such as fire, etc., caused by the malfunction of non-genuine Canon accessories (e.g., a leakage and/or explosion of a battery pack). Please note that this warranty does not apply to repairs arising out of the malfunction of non-genuine Canon accessories, although you may request such repairs on a chargeable basis.

Battery Packs

When you need extra battery packs, select one of the following models: NB-2LH, BP-2L13, BP-2L14 or BP-2L24H*.

* Attaching the BP-2L24H battery pack will make using the viewfinder more difficult.

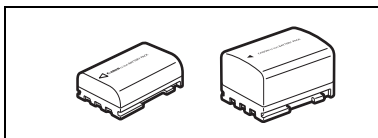

CB-2LW Battery Charger

Use the battery charger to charge the battery packs. It plugs directly into a power outlet without a cable.

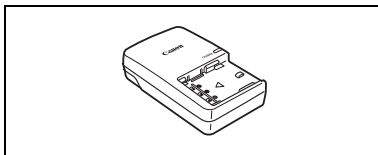

Charging Times

The charging times given in the following table are approximate and vary according to charging conditions and initial charge of the battery pack.

Battery pack →	NB-2LH	BP-2L13	BP-2L14	BP-2L24H
Charging conditions ↓				
Using the camcorder	135 min.	225 min.	240 min.	370 min.
Using the CB-2LW Battery Charger	105 min.	175 min.	195 min.	330 min.

Recording and Playback Times

The recording and playback times given in the following table are approximate and vary according to recording mode and charging, recording or playback conditions. The effective usage time of the battery pack may decrease when recording in cold surroundings, when using the brighter screen settings, etc.

DC420

Battery pack	NB-2LH		BP-2L13		BP-2L14		BP-2L24H	
Screen used	Viewfinder	LCD	Viewfinder	LCD	Viewfinder	LCD	Viewfinder	LCD
Maximum Recording Time								
XP	115 min.	115 min.	205 min.	205 min.	245 min.	245 min.	415 min.	410 min.
SP	135 min.	135 min.	235 min.	235 min.	280 min.	280 min.	485 min.	475 min.
LP	140 min.	140 min.	245 min.	240 min.	295 min.	295 min.	500 min.	495 min.
Typical Recording Time*								
XP	65 min.	65 min.	110 min.	110 min.	135 min.	130 min.	220 min.	220 min.
SP	70 min.	70 min.	120 min.	120 min.	145 min.	145 min.	245 min.	240 min.
LP	70 min.	70 min.	125 min.	120 min.	150 min.	145 min.	250 min.	245 min.
Playback Time								
XP	–	155 min.	–	270 min.	–	315 min.	–	515 min.
SP	–	180 min.	–	305 min.	–	370 min.	–	620 min.
LP	–	190 min.	–	325 min.	–	390 min.	–	650 min.

DC410

Battery pack	NB-2LH		BP-2L13		BP-2L14		BP-2L24H	
Screen used	Viewfinder	LCD	Viewfinder	LCD	Viewfinder	LCD	Viewfinder	LCD
Maximum Recording Time								
XP	120 min.	115 min.	215 min.	205 min.	260 min.	245 min.	425 min.	415 min.
SP	135 min.	135 min.	235 min.	235 min.	285 min.	280 min.	485 min.	475 min.
LP	140 min.	140 min.	245 min.	240 min.	295 min.	295 min.	500 min.	500 min.
Typical Recording Time*								
XP	65 min.	65 min.	115 min.	110 min.	135 min.	130 min.	220 min.	220 min.
SP	70 min.	70 min.	120 min.	120 min.	145 min.	145 min.	245 min.	240 min.
LP	70 min.	70 min.	125 min.	120 min.	150 min.	145 min.	250 min.	245 min.
Playback Time								
XP	–	155 min.	–	270 min.	–	325 min.	–	550 min.
SP	–	180 min.	–	305 min.	–	370 min.	–	635 min.
LP	–	190 min.	–	325 min.	–	395 min.	–	665 min.

* Approximate times for recording with repeated operations such as start/stop, zooming, and power on/off.



TL-H30.5 Tele-converter

This Tele-converter lens increases the focal length of the camcorder lens by a factor of 1.9.

- The image stabilizer is not as effective when the Tele-converter is attached.
- The minimum focusing distance with the TL-H30.5 attached is 3 m (9.8 ft.) at full telephoto; 3 cm (1.2 in.) at full wide angle.

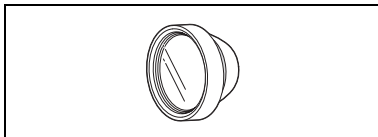

WD-H30.5 Wide-converter

This lens decreases focal length by a factor of 0.7, giving you a wide perspective for indoor shots or panoramic views.

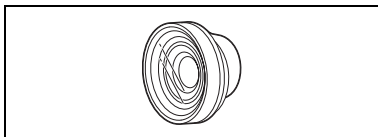

FS-30.5U Filter Set

Neutral density and MC protector filters help you to control difficult lighting conditions.

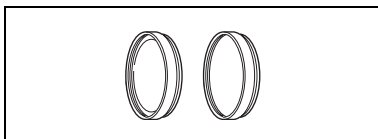

CBC-NB2 Car Battery Charger

Use the car battery charger to charge battery packs while you are on the go. The car battery cable plugs into your car's cigarette lighter and runs off a 12-24 V DC negative ground battery.

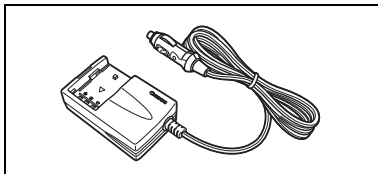

Shoulder Strap

You can attach a shoulder strap for more security and portability. Pass the ends through the strap mount and adjust the length of the strap.

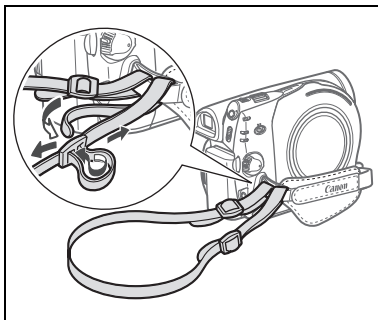

SC-2000 Soft Carrying Case

A handy camcorder bag with padded compartments and plenty of space for accessories.



This mark identifies genuine Canon video accessories. When you use Canon video equipment, we recommend Canon-brand accessories or products bearing the same mark.



Product Codes

Provided Accessories

CA-570 Compact Power Adapter	8468A002AA
NB-2LH Battery Pack	9612A001AA
DC420 STV-250N Stereo Video Cable	3067A001BA (D82-0590-001)
DC410 STV-250N Stereo Video Cable	D82-0590-002
DC420 IFC-300PCU USB Cable	6906A001AA (D82-0590-001)

Optional Accessories

BP-2L13 Battery Pack	2069B002AA
BP-2L14 Battery Pack	9582A002AA
BP-2L24H Battery Pack	2383B002AA
CB-2LW Battery Charger	0763B001AA
CBC-NB2 Car Battery Charger	7873A002AA
WD-H30.5 Wide-converter	9065A001AA
TL-H30.5 Tele-converter	9064A001AA
FS-30.5U Filter Set	6738A002AA
SS-650 Shoulder Strap	3123A001AA
SS-600 Shoulder Strap	3122A001AA
SC-2000 Soft Carrying Case	9389A001AA



Specifications

DC420/DC410

System

Disc Recording System	DVD-VIDEO (all disc types), DVD-VR (only with DVD-RW discs) Video Compression: MPEG-2, Audio Compression: Dolby Digital 2ch
Television System	EIA standard (525 lines, 60 fields) NTSC color signal
Compatible Media	8 cm (3 in.) mini DVD discs marked with the DVD-R, DVD-R DL or DVD-RW logo 
Maximum Recording Time	1.4 GB single sided 8 cm mini DVD disc: XP: 20 min., SP: 30 min., LP: 60 min. 2.6 GB single sided dual-layered 8 cm mini DVD disc: XP: 36 min., SP: 54 min., LP: 108 min. (All times given are approximate figures)
Image Sensor	DC420 1/6-inch CCD, approx. 1,070,000 pixels Effective pixels ¹ (all figures are approximate values) 16:9 Movies (advanced zoom) 410,000 (T) / 710,000 (W) pixels (optical zoom) 550,000 pixels 4:3 Movies (advanced zoom) 310,000 (T) / 690,000 (W) pixels (optical zoom) 690,000 pixels 16:9 Still images 600,000 pixels 4:3 Still images 800,000 pixels DC410 1/6-inch CCD, approx. 680,000 pixels Effective pixels ¹ (all figures are approximate values) 16:9 Movies (advanced zoom) 360,000 (T) / 450,000 (W) pixels (optical zoom) 360,000 pixels 4:3 Movies 340,000 pixels Still images 450,000 pixels
LCD Screen	2.7 in., wide, TFT color, approx. 112,000 dots
Viewfinder	0.27 in., wide, TFT color, approx. 123,000 dots
Microphone	Stereo electret condenser microphone
Lens	DC420 f=2.6-96.2 mm, F/2.0-5.2, 37x power zoom 35 mm equivalent (all figures are approximate values) 16:9 Movies (advanced zoom) 41.7-2,002 mm (optical zoom) 47.1-1,743 mm 4:3 Movies (advanced zoom) 44.6-2,453 mm (optical zoom) 44.6-1,650 mm 16:9 Still images 45.2-1,672 mm 4:3 Still images 41.5-1,536 mm DC410 f=2.6-96.2 mm, F/2.0-5.2, 37x power zoom 35 mm equivalent (all figures are approximate values) 16:9 Movies (advanced zoom) 41.3-1,695 mm (optical zoom) 45.8-1,695 mm 4:3 Movies 49.8-1,843 mm Still images 43.6-1,613 mm
Lens Configuration	10 elements in 8 groups (1 double-sided, aspheric element)

¹ When two values are given, the first indicates the value at full telephoto (T) and the second indicates the value at full wide-angle (W).

AF System	TTL autofocus, manual focus available
Filter Diameter	30.5 mm
Minimum Focusing Distance	1 m (3.3 ft); 1 cm (0.39 in.) at full wide angle
White Balance	Auto white balance, preset white balance (DAYLIGHT, TUNGSTEN) or custom white balance
Minimum Illumination	[NIGHT] recording program, Shutter speed at 1/8: DC420 1.7 lx, DC410 1.3 lx Auto slow shutter [ON], Shutter speed at 1/30: DC420 6.5 lx, DC410 5 lx
Recommended Illumination	More than 100 lx
Image Stabilization	Electronic

Memory Card

Recording Media	SDHC (SD High Capacity) memory card, SD memory card, MultiMedia Card (MMC)*
Size of Still Images	DC420 1,152 x 648 / 1,152 x 864 / 640 x 480 pixels DC410 1,024 x 768 / 640 x 480 pixels
File Format	Design rule for Camera File system (DCF), Exif 2.2 compliant**, DPOF compliant
Image Compression Method	JPEG (compression: Super Fine, Fine, Normal)

* This camcorder has been tested with SD/SDHC cards up to 32 GB. Performance cannot be guaranteed for all memory cards.

** This camcorder supports Exif 2.2 (also called "Exif Print"). Exif Print is a standard for enhancing the communication between camcorders and printers. By connecting to an Exif Print-compliant printer, the camcorder's image data at the time of shooting is used and optimized, yielding extremely high quality prints.

Terminals

AV Terminal	∅ 3.5 mm minijack, output only Video: 1 Vp-p/75 Ω unbalanced Audio: -10 dBV (47 kΩ load/3 kΩ or less)
DC420 USB Terminal	mini-B, USB 2.0 (Hi-Speed USB)
DC410 MIC terminal	∅ 3.5 mm stereo minijack -57 dBV (with 600 Ω microphone) / 5 kΩ or more

Power/Others

Power supply (rated)	7.4 V DC (battery pack), 8.4 V DC (compact power adapter)
Power consumption (SP mode)	DC420 2.2 W (viewfinder/LCD screen, normal brightness) DC410 2.1 W (viewfinder); 2.2 W (LCD screen, normal brightness)
Operating temperature	0 – 40 °C (32 – 104 °F)
Dimensions (W x H x D)	66 x 90 x 123 mm (2.6 x 3.5 x 4.8 in.) excluding the grip belt
Weight (camcorder body only)	380 g (13.4 oz.)



CA-570 Compact Power Adapter

Power supply	100 – 240 V AC, 50/60 Hz
Rated output / consumption	8.4 V DC, 1.5 A / 29 VA (100 V) – 39 VA (240 V)
Operating temperature	0 – 40 °C (32 – 104 °F)
Dimensions	52 x 29 x 90 mm (2.1 x 1.1 x 3.5 in.)
Weight	135 g (4.8 oz.)

NB-2LH Battery Pack

Battery type	Rechargeable Lithium Ion Battery
Rated voltage	7.4 V DC
Operating temperature	0 – 40 °C (32 – 104 °F)
Battery capacity	720 mAh
Dimensions	33.3 x 16.2 x 45.2 mm (1.3 x 0.64 x 1.8 in.)
Weight	43 g (1.5 oz.)

Weight and dimensions are approximate. Errors and omissions excepted.
The information in this manual is verified as of November 2008. Subject to change without notice.

Index

A

- Abroad, using the camcorder 84
- AEB - Auto exposure bracketing¹ 56
- Approved discs 7
- Aspect ratio
 - of a connected TV (TV type) 72
 - of movies (Widescreen) 30
- Auto slow shutter 68
- Autofocus: AF frame (9-point AiAF/Center point) 69
- AV terminal 63

B

- Battery pack
 - Charging 18
 - Remaining charge indicator 17
- Beach (recording program) 37
- Beep 71
- Built-in backup battery 83

C

- Compact power adapter 18
- Condensation 84
- Connections to external devices 63
- Continuous shooting¹ 56

D

- Data code 43, 70
- Date and time 23
 - Date format 72
 - Daylight saving time 24
 - Time zone 24
- Deleting/erasing
 - Movies 45
 - Still images 55
- Digital effects 42
- Direct print¹ 58
- Disc specifications (DVD-VIDEO, VR) 5
- Disc title 47
- Disc types (DVD-R, DVD-R DL, DVD-RW) 5

- Drive mode¹ 56

E

- EASY (recording program) 29
- Error messages 76
- Exposure 40

F

- Finalizing the disc 48
- Fireworks (recording program) 37
- Focus priority 69
- FUNC. menu 22, 66

H

- Histogram 56

I

- Image effects 42
- Image jump 53
- Image numbers 71
- Image stabilizer 68
- Index screen 33, 54
- Initialization
 - Disc 47
 - Memory card 57

J

- Joystick and joystick guide 21

L

- Language 23
- LCD screen 24
- LCD video light 39
- LP mode (recording mode) 30

M

- Magnifying a still image 54
- Maintenance 83
- Manual exposure adjustment 40
- Manual focus 40
- Markers 70
- Memory card 27, 82
- MIC terminal² 44
- Microphone² 44
- Mode switch 29

¹ **DC420** only. ² **DC410** only.



N	
Night (recording program)	37
O	
Onscreen display selection	43
Original recordings	45
P	
P (recording program)	38
Playback	
Movies	33
Still images	53
Playlist	45
Portrait (recording program)	37
Power save	71
Print order	61
Printing still images	58
Protecting still images	57
Q	
Quick Start function	32
R	
Recording	
Movies	28
Still images	51
Recording mode	30
Recording programs	38
Recording reminder	17
RESET	75
Reviewing	
Movies (Record review)	32
Still images (Review)	69
S	
Screen icons	15
SD/SDHC memory card	27
Self timer	39
Serial number	13
Setup menus	22, 68
Shutter speed	38
Slideshow	55
Snow (recording program)	37
SP mode	30
Special scene (recording programs)	36

Sports (recording program)	37
Spotlight (recording program)	37
Still image quality	52
Still image size	52
Sunset (recording program)	37

T	
Telephoto	31
Tripod	80
Troubleshooting	73
Tv (recording program)	38

U	
USB terminal ¹	63

V	
VIDEO mode (disc specification)	5
Viewfinder	29
Volume	34
VR mode (disc specification)	5

W	
White balance	41
Wide angle	31
Widescreen 16:9	30
Wind screen	69

X	
XP mode	30

Z	
Zoom	
Advanced zoom	31
Zoom speed	68
Zoom type	31

¹ **DC420** only. ² **DC410** only.

U.S.A.

CANON CONSUMER DIGITAL VIDEO EQUIPMENT LIMITED WARRANTY FOR THE UNITED STATES

The limited warranty set forth below is given by Canon U.S.A., Inc. ("Canon USA") with respect to Canon Consumer Digital Video Equipment (the "Equipment") purchased in the United States. This limited warranty is only effective upon presentation of your Bill of Sale or other proof of purchase.

The Equipment is warranted under normal, non-commercial, personal use, against defective materials or workmanship as follows:

Parts: Defective parts will be exchanged for new parts or comparable rebuilt parts for a period of ONE YEAR from the date of original purchase, except for a defective Video Head, which will be exchanged for a period of three months from the date of purchase.

Labor: For a period of ONE YEAR from the date of original purchase, labor will be provided free of charge by our factory service centers or designated service facilities located in the United States.

When returning Equipment under this warranty, you must pre-pay the shipping charges, and you must enclose the Bill of Sale or other proof of purchase with a complete explanation of the problem. During the ONE-YEAR warranty period, repairs will be made and the Equipment will be return-shipped to you free of charge. For repairs after the warranty period is over, you will be given an estimate of the cost of repair and an opportunity to approve or disapprove of the repair expense before it is incurred. If you approve, repairs will be made and the Equipment will be return-shipped to you. (shipping charges apply). If you disapprove, we will return-ship the equipment at no charge to you.

Non-Canon brand peripheral equipment and software which may be distributed with, or factory loaded on, the Equipment, are sold "AS IS" without warranty of any kind by Canon USA, including any implied warranty regarding merchantability or fitness for a particular purpose. The sole warranty with respect to such non-Canon brand items is given by the manufacturer or producer thereof. If the Equipment contains a hard disk drive, Canon USA recommends that data stored on that drive be duplicated or backed up to prevent its loss in the event of failure or other malfunction of such drive.

Canon USA shall have no responsibility under this limited warranty for use of the Equipment in conjunction with incompatible peripheral equipment and incompatible software.

In order to obtain warranty service, contact the authorized Canon retail dealer from whom you purchased the Equipment or call the CANON INFORMATION CENTER AT 1-800-OK-CANON). You will be directed to the nearest service facility for your Equipment.

This Limited Warranty covers all defects encountered in normal use of the Equipment and does not apply in the following cases:

- A) Loss or damage to the Equipment due to abuse, mishandling, accident, improper maintenance, or failure to follow operating instructions;
- B) If the Equipment is defective as a result of leaking batteries, sand, dirt or water damage;
- C) If defects or damages are caused by the use of unauthorized parts or by service other than by Canon USA's factory service centers or authorized service facilities;
- D) If the Equipment is used for commercial or industrial use.

This Limited Warranty does not cover cabinet (exterior finish), video cassette tape, head cleanings, nor does it apply to Equipment purchased outside the United States. This warranty does not cover units sold to rental firms, military operations, hotels, schools, hospitals or for other commercial, industrial, or institutional applications. These uses are covered only by such specific warranty as Canon may issue with such sales.

This Limited Warranty does not apply to accessories or consumables for the Equipment, which are sold "AS IS", without warranty of any kind by Canon USA.

Please retain this warranty card and your Bill of Sale as a permanent record of your purchase. This card is most important in order to be sure you are contacted right away should there be a safety inspection, modification or product recall under applicable laws or regulations.

NO IMPLIED WARRANTY, INCLUDING MERCHANTABILITY AND FITNESS FOR A PARTICULAR PURPOSE APPLIES TO THIS EQUIPMENT AFTER THE APPLICABLE PERIOD OF EXPRESS WARRANTY OR GUARANTY, EXCEPT AS MENTIONED ABOVE, GIVEN BY ANY PERSON, FIRM OR CORPORATION WITH RESPECT TO THIS EQUIPMENT SHALL BIND THE UNDERSIGNED (SOME STATES DO NOT ALLOW LIMITATIONS ON HOW LONG AN IMPLIED WARRANTY LASTS, SO THE ABOVE LIMITATION OR EXCLUSION MAY NOT APPLY TO YOU). CANON USA SHALL NOT BE LIABLE FOR LOSS OF REVENUES OR PROFITS, EXPENSE FOR SUBSTITUTE EQUIPMENT OR SERVICE, STORAGE CHARGES, LOSS OR CORRUPTION OF DATA, INCLUDING WITHOUT LIMITATION, LOSS OR CORRUPTION OF DATA STORED ON THE EQUIPMENT'S HARD DRIVE, OR ANY OTHER SPECIAL, INCIDENTAL OR CONSEQUENTIAL DAMAGES CAUSED BY THE USE, MISUSE OR INABILITY TO USE THE EQUIPMENT, REGARDLESS OF THE LEGAL THEORY ON WHICH THE CLAIM IS BASED, AND EVEN IF CANON USA HAS BEEN ADVISED OF THE POSSIBILITY OF SUCH DAMAGES. NOR SHALL RECOVERY OF ANY KIND AGAINST CANON USA BE GREATER THAN THE PURCHASE PRICE OF THE EQUIPMENT SOLD BY CANON USA AND CAUSING THE ALLEGED DAMAGE. WITHOUT LIMITING THE FOREGOING, YOU ASSUME ALL RISK AND LIABILITY FOR LOSS, DAMAGE OR INJURY TO YOU AND YOUR PROPERTY AND TO OTHERS AND THEIR PROPERTY ARISING OUT OF USE, MISUSE OR INABILITY TO USE THE EQUIPMENT NOT CAUSED DIRECTLY BY THE NEGLIGENCE OF CANON USA. (SOME STATES DO NOT ALLOW THE EXCLUSION OR LIMITATION OF INCIDENTAL OR CONSEQUENTIAL DAMAGES, SO THE ABOVE LIMITATION MAY NOT APPLY TO YOU). THIS WARRANTY SHALL NOT EXTEND TO ANYONE OTHER THAN THE ORIGINAL PURCHASER OF THIS EQUIPMENT OR THE PERSON FOR WHOM IT WAS PURCHASED AS A GIFT.

This warranty gives you specific legal rights, and you may also have other rights which vary from state to state.
CANON U.S.A., INC.

CANADA

CANON CONSUMER DIGITAL VIDEO EQUIPMENT LIMITED WARRANTY

The limited warranty set forth below is given by Canon Canada Inc. ("Canon Canada") with respect to Canon Consumer Digital Video Equipment (the "Equipment") purchased in Canada. This limited warranty is only effective upon presentation of a bill of sale or other proof of purchase for this Equipment to a Canon Service Facility when repairs are required.

The Equipment is warranted under normal, non-commercial, personal use, against defective materials or workmanship as follows:

Parts: Defective parts will be exchanged for new parts or, at Canon Canada's option, comparable rebuilt parts for a period of one year from the date of original purchase, except Video Heads which will be exchanged for a period of 3 months from the date of purchase.

Labour: For a period of one year from the date of original purchase, labour will be provided free of charge by our Canon Service Facilities in Canada.

This limited warranty covers all defects except where:

(a) The loss or damage to the product results from:

- i) accident, natural disaster, mishandling, abuse, neglect, unauthorized product modification or failure to follow instructions contained in the instruction manual;
- ii) the use of accessories, attachments, products, supplies, parts or devices with the Equipment that do not conform to Canon specifications or that cause abnormally frequent service problems;
- iii) repairs or services performed by any party other than a Canon Service Facility;
- iv) defective batteries or any exposure to water, sand or dirt;
- v) shipping (claim must be presented to the shipper);

(b) Any serial number on the video Equipment is altered or removed.

(c) The Equipment is used for commercial, professional or industrial purposes.

This limited warranty does not cover the cabinet (exterior finish) of the Equipment, media, nor does it apply to Equipment purchased outside Canada. If the Equipment contains a hard disk drive, Canon Canada recommends that data stored on that drive be duplicated or backed up to prevent its loss in the event of a failure or other malfunction of such drive.

TO OBTAIN WARRANTY SERVICE

Ship your Equipment in its original carton, box or equivalent, properly packed, fully insured with shipping charges prepaid, together with a copy of your bill of sale or other proof of purchase and a description of the problem to any of the Canon Service Facilities in Canada.

LIMITATIONS

Except as otherwise required by applicable legislation, this warranty is in lieu of all other warranties, conditions, guarantees or representations, express or implied, statutory or otherwise, relative to the Equipment, including implied warranties or conditions of merchantability or fitness for a particular purpose.

Canon Canada assumes no liability for special, consequential or incidental damages, loss or corruption of data including, without limitation, data stored on the hard disk drive of the Equipment or loss that may arise, whether on account of negligence or otherwise, from the use, misuse or inability to use the Equipment (including loss of profit, revenue, media or enjoyment) or from failure to conform to any express or implied warranties, conditions, guarantees or representations. Any recovery under this limited warranty shall not exceed the purchase price of the equipment. Canon Canada does not assume or authorize any other person to assume for Canon Canada any other liability with respect to this equipment.

This warranty does not extend to any person other than the original purchaser of the Equipment or the person for whom it was purchased as a gift and states your exclusive remedy.

NOTICE TO CONSUMER

If you plan to take important videos or if the product has not been used for some time, please check all functions with the instruction book before using it.

USA**CANON U.S.A., INC. NEW JERSEY OFFICE**

100 Jamesburg Road, Jamesburg, NJ 08831 USA

CANON U.S.A., INC. CHICAGO OFFICE

100 Park Blvd., Itasca, IL 60143 USA

CANON U.S.A., INC. LOS ANGELES OFFICE

15955 Alton Parkway, Irvine, CA 92618 USA

CANON U.S.A., INC. HONOLULU OFFICE

210 Ward Avenue, Suite 200, Honolulu, HI 96814 USA

- ❖ If you have any questions, call the Canon U.S.A. Information Center toll-free at 1-800-828-4040 (U.S.A. only).
-

CANADA**CANON CANADA INC.**

6390 Dixie Road, Mississauga, ON L5T 1P7

CANON CANADA INC. CALGARY

2828 16th Street NE, Calgary, AB T2E 7K7

CANON CANADA INC. MONTREAL

8801 Route Transcanadienne, Saint-Laurent, QC H4S 1Z6

- ❖ If you have any questions, call the Canon Canada Information Center toll free (in Canada only) at 1-800-OK-CANON (1-800-652-2666).
 - ❖ Si vous avez des questions, veuillez téléphoner 1-800-OK-CANON (1-800-652-2666, sans frais au Canada seulement).
-

MÉXICO**CANON MEXICANA, S DE RL DE CV**

Bld. Manuel Ávila Camacho No. 138, Piso 17

Col. Lomas de Chapultepec

C.P. 11000 México, D.F., México

CANON U.S.A., INC. NEW JERSEY OFFICE

100 Jamesburg Road, Jamesburg, NJ 08831 USA

**CENTRO Y
SURAMÉRICA****CANON LATIN AMERICA, INC.**

703 Waterford Way, Suite 400, Miami, FL 33126 USA

ASIA**CANON HONGKONG COMPANY LTD.**

19/F, The Metropolis Tower, 10 Metropolis Drive,

Hunghom, Kowloon, Hong Kong

Tel: +852 3191 2333, Fax: +852 2428 3963



Free Manuals Download Website

<http://myh66.com>

<http://usermanuals.us>

<http://www.somanuals.com>

<http://www.4manuals.cc>

<http://www.manual-lib.com>

<http://www.404manual.com>

<http://www.luxmanual.com>

<http://aubethermostatmanual.com>

Golf course search by state

<http://golfingnear.com>

Email search by domain

<http://emailbydomain.com>

Auto manuals search

<http://auto.somanuals.com>

TV manuals search

<http://tv.somanuals.com>