

Canon

EOS-1 Ds

DIGITAL

INSTRUCTION MANUAL



Be sure to read these Instruction Manual before using your camera for the first time. Keep this booklet handy for easy reference.

Exif Print

E
English Edition

Canon

EOS-1 Ds

DIGITAL

INSTRUCTION MANUAL

EOS-1 Ds

DIGITAL

E

Thank you for purchasing a Canon product.

The EOS-1Ds is a high-performance, digital AF SLR camera with a large, 36x24mm (approx.), 11.1-megapixel CMOS sensor and high-precision Area AF. The camera is compatible with all Canon EF lenses and has many features for all types of photography, from fully automatic snapshotting to professional-level, creative work.

It uses CompactFlash cards (CF Type I and II) as the recording medium.

Be sure to read these Instruction Manual to familiarize yourself with the features and proper operation of this camera.

* Using CF cards made by Canon is recommended.

Radio and Television Interference (VCCI Statement)

This camera is an information technology device that does not exceed Class B limits for electromagnetic interference (EMI) in compliance with standards set by Japan's Voluntary Control Council for Interference by Information Technology Equipment (VCCI). This device may still cause interference with radio or television reception when placed near such an appliance. Read these Instruction Manual to learn how to avoid reception interference of other appliances.

Test the Camera Before Shooting

Before using the camera, be sure to test it first. Check that the images are properly recorded on the CF card. If the camera or CF card is faulty and the images cannot be recorded or read by a personal computer, Canon cannot be held liable for any loss or inconvenience caused.

About Copyrights

Copyright laws in your country may prohibit the use of images of people and certain subjects for anything but private enjoyment. Photographing public performances or exhibitions may also be prohibited.

- Canon and EOS are trademarks of Canon Inc.
- Adobe and Photoshop are trademarks of Adobe Systems Incorporated.
- CompactFlash is a trademark of SanDisk Corporation.
- IBM PC/AT is a trademark or registered trademark of International Business Machines.
- Macintosh is a registered trademark of Apple Corporation in the United States and other countries.
- All other trademarks are the property of their respective owners.

Equipment Check List

Be sure all the following equipment and accessories have been included with your camera. If anything is missing, contact your dealer.

-
- EOS-1Ds camera body** (with body cap, battery compartment cover, and lithium CR2025 battery for the date and time)
 - Eyecup Ec-II**
 - Ni-MH Pack NP-E3** (with protective cover)
 - Ni-MH Charger NC-E2**
 - DC Coupler Kit DCK-E1**
 - Neck Strap L4**
 - Hand Strap E1**
 - Interface Cable IFC-450D6**

-
- EOS DIGITAL Solution Disk**
 - Adobe Photoshop LE Disk**

-
- EOS-1Ds Instruction Manual** (which you are reading now)
This describes how to use the camera.
 - Ni-MH Pack NP-E3 Instructions**
 - Ni-MH Charger NC-E2 Instructions**
 - DC Coupler Kit DCK-E1 Instructions**
 - EOS DIGITAL Software User's Manual**
Explains how to install and use the driver software which enables you to transfer images from the camera to a personal computer, edit RAW images, set image-processing parameters, and customize camera functions.

-
- Warranty card**
 - Quick Operation Guide**
 - EOS-1Ds Accessories**
Introduces major accessories for the EOS-1Ds.

* No CF card is included. Please purchase it separately. CF cards made by Canon are recommended.

This digital camera supports Exif 2.2 (also called "Exif Print"). Exif Print is a standard for enhancing the communication between digital cameras and printers. By connecting to an Exif Print-compliant printer, the camera's image data at the time of shooting is used and optimized, yielding extremely high quality prints.

Contents

Introduction

Equipment Check List	3
Handling Cautions	10
Quick Start Guide	12
Nomenclature	14
Conventions Used in this Manual	20

1 Before You Start 21

Recharging the Battery	22
Installing and Removing the Battery	23
Installing the Battery	23
Checking the Battery Level	23
Removing the Battery	24
Using an AC Outlet	25
Mounting and Detaching a Lens	26
Mounting a Lens	26
Detaching the Lens	26
Installing and Removing the CF Card	27
Installing a CF Card	27
Removing the CF Card	28
Basic Operation	29
Main Switch	29
Shutter Button	29
Using the Electronic Dials	30
Vertical Shooting	31
MENU Menu Operations	32
Basic Menu Navigation	32
Detailed Menu Navigation	32
About the LCD Monitor	34
Reverting to the Default Settings	34
Dioptic Adjustment	35
Holding the Camera	35
Attaching the Neck Strap and Hand Strap	36

2 Settings for Images 37

MENU Image-Recording Quality	38
Processing	39
MENU Simultaneous Capture in RAW and JPEG Formats	40
WB Selecting the White Balance	41
About White Balance	41
White Balance Settings	42
MENU Custom White Balance	43
MENU Setting the Color Temperature	44
Selecting Personal White Balance	45
White Balance Auto Bracketing	46
Canceling White Balance Auto Bracketing	47

MENU Selecting the Color Maxtrix	48
Setting the ISO Speed	49
MENU Setting the Processing Parameters	50
MENU Reviewing Images	52
Image Review	52
Changing the Review Time	53
Automatic Playback After Continuous Shooting	53
■ Creating and Selecting a Folder	54
Creating a Folder with the Camera	54
Selecting a Folder	55
MENU File Numbering Methods	56
Auto Reset	56
Continuous Numbering	57
Manual Reset	58
Creating a Folder with a Personal Computer	58

3 Using Autofocus (AF) 59

Selecting AF Mode	60
One-Shot AF for Still Subjects	61
Focusing an Off-Center Subject	61
AI Servo AF for Moving Subjects	62
Area AF Ellipse and AF Points	63
 Selecting AF Point	64
Basic Procedure for AF Point Selection	64
Automatic Selection	65
Manual Selection	65
Registering and Switching AF Point	68
Registering an AF Point	68
Switching to the Registered AF Point	69
AF Point Activation Area	70
AF Sensitivity and the Lens' Maximum Aperture	71
When Autofocus Fails (Manual Focusing)	73
Manual Focusing	74

4 Metering Modes 75

 Selecting a Metering Mode	76
Metering Modes	76
Multi-Spot Metering	78

5 Exposure Control 81

P Program AE	82
Tv Shutter-Priority AE	84
Av Aperture-Priority AE	86
Depth-of-field Preview	87
DEP Depth-of-field AE	88
M Manual Exposure	90
 Setting Exposure Compensation	92

Exposure Compensation with the Dial .. 92
 Exposure Compensation with the Button and Dial 93
 Auto Exposure Bracketing 94
 AEB with the Shutter Speed or Aperture 94
 AEB with the ISO Speed 95
 Canceling AEB 97
 AE Lock 98
 Drive Mode Selection 99
 Self-timer Operation 100
 Using the Eyepiece Shutter 101
 Bulb Exposures 102
 LCD Panel Illumination 103
 Mirror Lockup 104

6 Flash Photography 105

Flash Photography with Speedlite 550EX 106
 E-TTL Autoflash 107
 E-TTL Autoflash in Other Shooting Modes .. 107
 High-Speed Sync (FP Flash) 108
 FEB (Flash Exposure Bracketing) 108
 FEL FE Lock 109
 Flash Exposure Compensation 110
 Modeling Flash 111
 Wireless, Multi-Speedlite System 111
 Metered Manual Flash Photography 112
 About TTL and A-TTL Autoflash Speedlites .. 113
 Using Non-Canon Flash Units 114

7 Playback Images 115

Playback Images 116
 Enlarging the image 117
 Image with Shooting Information 118
 About the Histogram 118
 Highlight Alert 118
 AF point 118
 Image Protection 119
 Protecting a Single Image 119
 Protecting All Images in a Folder or CF Card 120
 Clearing Protection for All Images 120
 Sound Recording for an Image 121
 Erasing an Image 122
 Erasing a Single Image 122
 Erasing All Images in a Folder 123
 Erasing All Images on the CF Card . 125
 Formatting a CF Card 126

8 Menu Settings 127

Menu Settings 128
 Setting a Custom Function 132
 Custom Function Settings 133
 Clearing All Custom Functions 139
 Registering Custom Function Groups ... 140
 Registering Custom Function Groups ... 140
 Using a Custom Function Group 142
 Personal Functions 144
 Clearing and Resetting Personal Functions .. 145
 Clearing All Personal Functions 146

9 Maintenance 147

Setting the Date and Time 148
 Replacing the Back-up Battery 149
 Cleaning the CMOS Sensor 150

10 Reference 153

Basic Terminology 154
 Exposure Warning List 157
 Program Line 158
 Shutter Speed and Aperture Display 159
 Error Codes 160
 On-screen Message 160
 Troubleshooting Guide 162
 Changing the Focusing Screen 164
 Major Accessories (optional) 166
 System Map 168
 Specifications 170
 Index 174



1

2

3

4

5

6

7

8

9

10

EOS-1Ds

This device complies with Part 15 of the FCC Rules. Operation is subject to the following two conditions: (1) This device may not cause harmful interference, and (2) this device must accept any interference received, including interference that may cause undesired operation.

Note: This equipment has been tested and found to comply with the limits for class B digital devices, pursuant to Part 15 of the FCC Rules. These limits are designed to provide reasonable protection against harmful interference in a residential installation. This equipment generates, uses and can radiate radio frequency energy and, if not installed and used in accordance with the instructions, may cause harmful interference to radio communications. However, there is no guarantee that interference will not occur in a particular installation. If this equipment does cause harmful interference to radio or television reception, which can be determined by turning the equipment off and on, the user is encouraged to try to correct the interference by one or more of the following measures:

- Reorient or relocate the receiving antenna.
- Increase the separation between the equipment and receiver.
- Connect the equipment into an outlet on a circuit different from that to which the receiver is connected.
- Consult the dealer or an experienced radio/TV technician for help.

The cable with the ferrite core provided with the digital camera must be used with this equipment in order to comply with Class B limits in Subject B of Part 15 on the FCC rules.

Do not make any changes or modifications to the equipment unless otherwise specified in the manual. If such changes or modifications should be made, you could be required to stop operation of the equipment.

Canon U.S.A. Inc.
One Canon Plaza, Lake Success, NY 11042, U.S.A.
Tel No. (516)328-5600



The **CE** Mark is a directive conformity mark of the European Community (EC).



This mark indicates that the product complies with Australia's EMC regulations.

SAFETY PRECAUTIONS

- Before using the camera, please ensure that you have read and understood the safety precautions described below. Always ensure that the camera is operated correctly.
- The safety precautions noted as follows are intended to instruct you in the safe and correct operation of the camera and its accessories to prevent injuries or damage to yourself, other persons and equipment.
- The term “equipment” refers primarily to the camera and its power supply accessories.

WARNINGS

- Do not aim the camera or detached lens only directly into the sun or at other intense light sources that could injure your eyesight.
- Store this equipment out of the reach of children and infants. Accidental damage to the camera or batteries by a child could result in serious injury. In addition, placement of the neck strap around a child’s neck could result in asphyxiation.
- Be particularly careful to keep the lithium battery CR2025 used in the camera out of the reach of children. Seek medical assistance immediately if a child swallows the battery.
- Do not attempt to disassemble or alter any part of the equipment. Disassembly or alteration may result in high-voltage electrical shock. Internal inspections, alterations and repairs should be conducted by qualified service personnel authorized by your camera distributor or Canon Customer Support.
- To avoid the risk of high-voltage electrical shock, do not touch internal portions of the equipment that become exposed as a result of damage. Please take the first opportunity to consult your camera distributor or Canon Customer Support immediately.
- Stop operating the equipment immediately if it should emit smoke or noxious fumes. Failure to do so may result in fire or electrical shock. Set the camera’s main switch to the OFF position and remove the camera battery or unplug the power cord from the electrical outlet immediately. Please consult your camera distributor or the closest Canon Customer Support.
- Stop operating the equipment if it is dropped or the casing is damaged. Failure to do so may result in fire or electrical shock. Set the camera’s main switch to the OFF position and remove the camera battery or unplug the power cord immediately. Please consult your camera distributor or the closest Canon Customer Support.
- Prevent the equipment from immersion in, water or other liquids. Do not allow liquids to enter the interior. The camera is not waterproof. If the exterior contacts with liquids or salt air, wipe it dry with a soft, absorbent cloth. If water or other foreign substances enter the interior, immediately set the camera’s main switch to the OFF position and remove the camera battery or unplug the power cord immediately. Continued use of the equipment may result in fire or electrical shock. Please consult your camera distributor or the closest Canon Customer Support.
- Do not use substances containing alcohol, benzene, thinners or other organic solvent substances to clean or maintain the equipment.
- Do not cut, damage, alter or place heavy items on the power cord. Any of these actions may cause an electrical short circuit, which may lead to fire or electrical shock. Replace a broken or damaged power cord.

-
- Do not handle the power cord if your hands are wet. Handling it with wet hands may lead to electrical shock. When unplugging the cord, ensure that you hold the rigid portion of the plug. Pulling the cord may damage or expose the wire and short-circuit, fires or electrical shocks.
-
- Use of power sources not expressly recommended for this equipment may lead to overheating, distortion of the equipment, fire, electrical shock or other hazards. Use only the recommended power accessories.
-
- Use of batteries not expressly recommended for this equipment may cause explosions or leaks, resulting in fire, injury and damage to the surroundings. Use only recommended batteries and accessories.
-
- Use only Ni-MH Charger NC-E2 to charge the NP-E3. Use of chargers not expressly recommended may result in overheating, distortion, fire or electrical shock.
-
- Do not place the batteries near heat or in water. Such exposure may damage the batteries and lead to the leakage of corrosive liquids, fire, electrical shock, explosion or serious injury.
-
- Do not attempt to disassemble, alter, or apply heat to the batteries. There is serious risk of injury due to an explosion. Immediately flush with water any area of the body, including the eyes and mouth, or clothing, that comes into contact with the inner contents of a battery. If the eyes or mouth contact these substances, immediately flush with water and seek medical assistance.
-
- Avoid dropping or subjecting the batteries to severe impacts that could damage the casings. This could lead to leakage and injury.
-
- Do not short-circuit the battery terminals with metal, such as key holders. This could lead to overheating, burns and other injuries. Use the supplied protective cover to transport or store the battery.
-
- Before you discard a battery, cover the terminals with tape or other insulators to prevent direct contact with other objects. Contact with the metallic components of other materials in waste containers may lead to fire or explosions. Discard batteries in specialized waste facilities if available in your area.
-
- Disconnect Ni-MH Charger NC-E2 from electrical outlet after recharging and when the camera is not in use to avoid fires and other hazards.
-
- The camera terminal of the DC Coupler Kit DCK-E1 is designed for exclusive use with the EOS-1Ds. Do not use it with other products or batteries. There is a risk of fire and other hazards.

IMPORTANT

-
- Do not remove the CF card from the camera while the CF card access lamp is blinking. A blinking access lamp indicates that data on the CF card is being written or read. Removing the card at such a time will destroy the data.
-
- When connecting the camera to a personal computer, do not use any interface cable other than the one provided with the camera. Using the wrong cable may result in malfunction.

CAUTIONS

- Avoid using, placing or storing the equipment in places subject to strong sunlight or high temperatures, such as the dashboard or trunk (boot) of a car. Exposure to intense sunlight and heat may cause the batteries to leak, overheat or explode, resulting in fire, burns or other injuries. High temperatures may also cause deformation of the casing. Ensure that there is good ventilation when using Ni-MH Charger NC-E2 to charge NP-E3.
- Do not store the equipment in humid or dusty areas. Storage in these areas could lead to fire, electrical shock or other damage.
- Be careful not to bang the camera or subject it to strong impacts or shocks that could lead to injury or damage the equipment when wearing or holding it by the neck strap.

PREVENTING MALFUNCTIONS

Avoid Strong Electromagnetic Fields

Never place the camera near electric motors or other equipment generating strong electromagnetic fields. Exposure to strong electromagnetic fields may cause malfunctions or corrupt image data.

Avoid Condensation

Moving the equipment rapidly between hot and cold temperatures may cause condensation (water droplets) to form on its external and internal surfaces. You can avoid this by placing the equipment in an airtight, resealable plastic bag and letting it adjust to temperature changes slowly before removing it from the bag.

If Condensation Forms Inside the Camera

Stop using the camera immediately if you detect condensation. Continued use may damage the equipment. Remove the CF card and battery or DC Coupler Kit (if connected) from the camera and wait until the moisture evaporates completely before resuming use.

Extended Storage

When not using the camera for extended periods of time, remove the battery (except the lithium battery CR2025) and store the equipment in a safe place. Storing the camera for extended periods with a battery installed will run down the battery and may damage the camera.

PREVENTING MALFUNCTIONS

- When the CF Card Access Lamp is blinking, do not open the CF card slot cover. Since the card is reading and writing data when the lamp is blinking opening the CF card slot cover at this time will damage the image data.
- Do not use any cable other than that supplied with the camera. Use the supplied interface cable to connect the camera to a computer. Use of any other cable may lead to a malfunction.

SKIN BURN HAZARD

- When the camera's main switch is <ON> for a prolonged period, the camera body may become hot. Although this is not a malfunction, holding the camera for a long period may cause low-degree skin burns. Take care to avoid skin burns.

Handling Cautions

Camera Care

- (1) The camera is a precision instrument. Do not drop it or subject it to physical shock.
- (2) This camera is not waterproof and cannot be used underwater. If you drop the camera into water, promptly consult your nearest Canon Service Center. Wipe off any water droplets with a dry cloth. If the camera has been exposed to salty air, wipe with a well-wrung damp cloth.
- (3) Never leave the camera near anything having a strong magnetic field such as a magnet or electric motor. Also avoid using or leaving the camera near anything emitting strong radio waves such as a large antenna. Strong magnetic fields and radio waves can cause camera misoperation or destroy image data.
- (4) Do not leave the camera in places of excessive heat such as in a car on a sunny day. The heat can cause the camera to malfunction.
- (5) The camera contains precision electronic circuitry. Never attempt to disassemble the camera.
- (6) Use only a blower brush to blow away dust on the lens, viewfinder eyepiece, mirror, focusing screen, etc. Do not use any organic solvents to clean the camera body or lens. For stubborn dirt, consult your nearest Canon Service Center.
- (7) Do not touch the electrical contacts with your fingers. Corrosion may develop on the contacts, resulting in improper camera operation.
- (8) If the camera is suddenly brought into a warm environment from a cold one, condensation (water droplets) may form on the camera and internal parts. To avoid this, first put the camera in a vinyl bag and let it adjust gradually to the warmer temperature.
- (9) If condensation develops on the camera, do not use the camera. Remove the CF card and battery and wait until the condensation evaporates.
- (10) If the camera is not to be used for an extended period, remove the battery. Store the camera in a well-ventilated, cool, dry place. During the storage period, release the shutter a few times once in a while.
- (11) Avoid storing the camera in a laboratory, cabinet, etc., where corrosive chemicals are present.
- (12) If the camera has not been used for an extended period or if the camera is to be used for an important event, check the operation of all the camera controls or take it to your nearest Canon Service Center.

LCD Monitor and LCD Panels

- (1) The color LCD monitor is manufactured with very high precision technology. There may be a few dead pixels where a black, red, or green pixel is always displayed. They number no more than 0.02 percent (standard tolerance) of all effective pixels. They also do not affect the images recorded.
- (2) Do not press hard against the LCD monitor or LCD panel or subject it to physical shock. Doing so may result in a warped display or malfunction.
- (3) If the LCD monitor or LCD panels become dirty, use a blower brush or soft cloth to clean. For stubborn dirt, take the camera to a Canon Service Center.
- (4) At low temperatures, the liquid-crystal display response may become slower. And at high temperatures, the display may blacken. In either case, the display will return to normal at room temperature.

CF Cards

- (1) CF cards are precision appliances. Do not subject the card to physical shock or vibration. Doing so may destroy the data it contains.
- (2) Do not store or use a CF card near anything having a strong magnetic field such as a magnet or in places prone to having static charge. Doing so may destroy the image data.
- (3) To prevent deformation due to heat, do not leave any CF cards in direct sunlight or near a heat source.
- (4) Do not spill any liquids on the CF card.
- (5) To protect the data, be sure to store the CF card in the dedicated case.
- (6) A CF card incompatible with the camera will not be able to record or display any images. Be sure to use only compatible CF cards.
- (7) Do not bend or exert any excessive force or physical shock on the CF card.
- (8) Do not store CF cards in hot, dusty, or humid places. Also avoid places prone to generate static charge or an electromagnetic field.

Lens Electrical Contacts

After detaching the lens from the camera, attach the lens caps or put down the lens with the rear end up to avoid scratching the lens surface and electrical contacts.

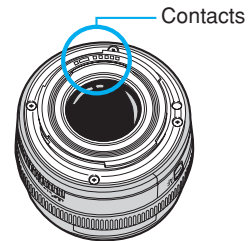

Quick Start Guide

For detailed instructions, see the reference page indicated in parentheses.

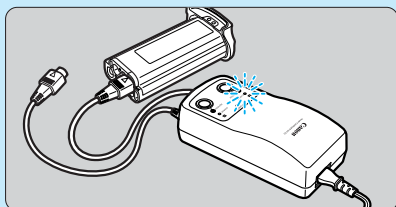

- 1 Recharge the battery.**
Connect the battery to the battery charger with the power cord. The CHARGE lamp remains lit while the battery is recharged. When the battery is fully recharged (taking about 2 hours), the CHARGE lamp will start blinking. (→p.22)

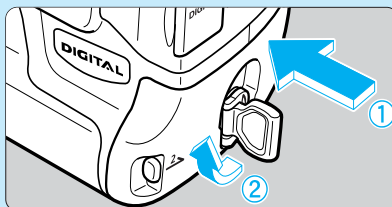

- 2 Load the battery.**
Insert the battery into the battery compartment and turn the release handle as shown by the arrow while pushing in the battery. (→p.23)

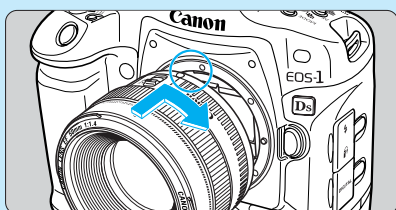

- 5 Attach a lens.**
Align the red dots on the lens and camera and turn the lens as shown by the arrow until it snaps in place. (→p.26)

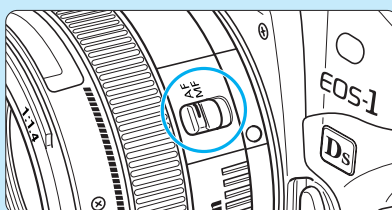

- 6 On the lens, set the focus mode switch to <AF>.**
(→p.26)



- 9 Focus the subject.**
Aim the Area AF over the subject and press the shutter button halfway to autofocus. (→p.59)

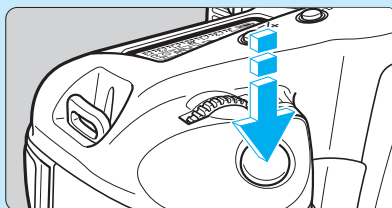

- 10 Take the picture.**
Press the shutter button fully to take the picture. (→p.29)

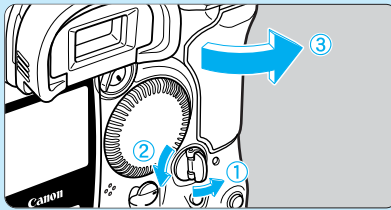

3 Open the CF card slot cover.
 Flip up the cover handle and turn it as shown by the arrow to open the cover. (→p.27)

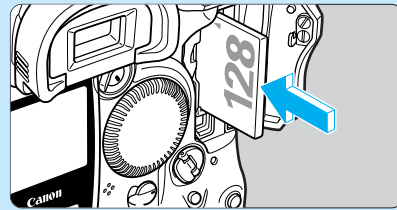

4 Insert a CF card.
 After inserting a CF card, close the cover. (→p.27)

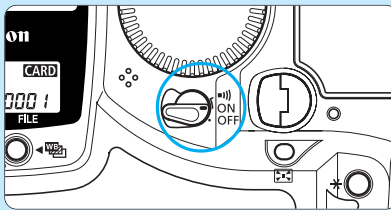

7 Turn the <ON> main switch to <ON>.
 (→p.29)

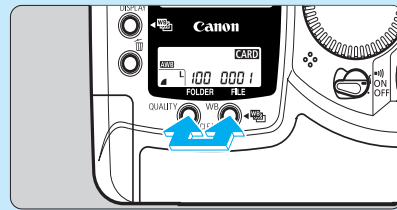

8 Set the camera to the default settings.
 (→34)
 Press the <QUALITY> and <WB> buttons simultaneously for 2 sec.



11 Review the picture on the LCD monitor.
 The picture you just took will be displayed for about 2 sec. This display time can also be changed. (→p.53)

- To review previous images, see “Playback Images” on page 116.
- To erase an image, see “Erasing an Image” on page 122.

Nomenclature

The reference page is in parentheses.

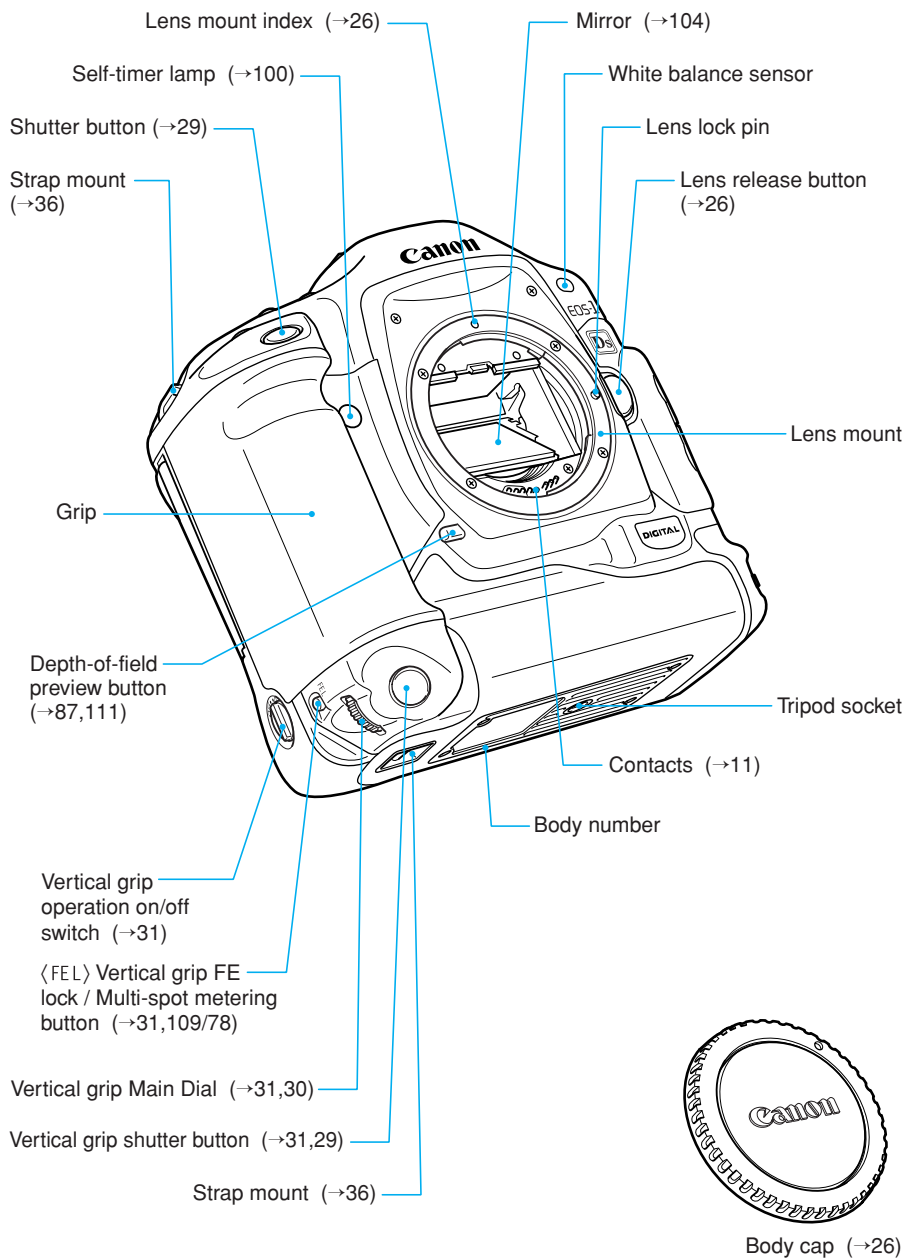

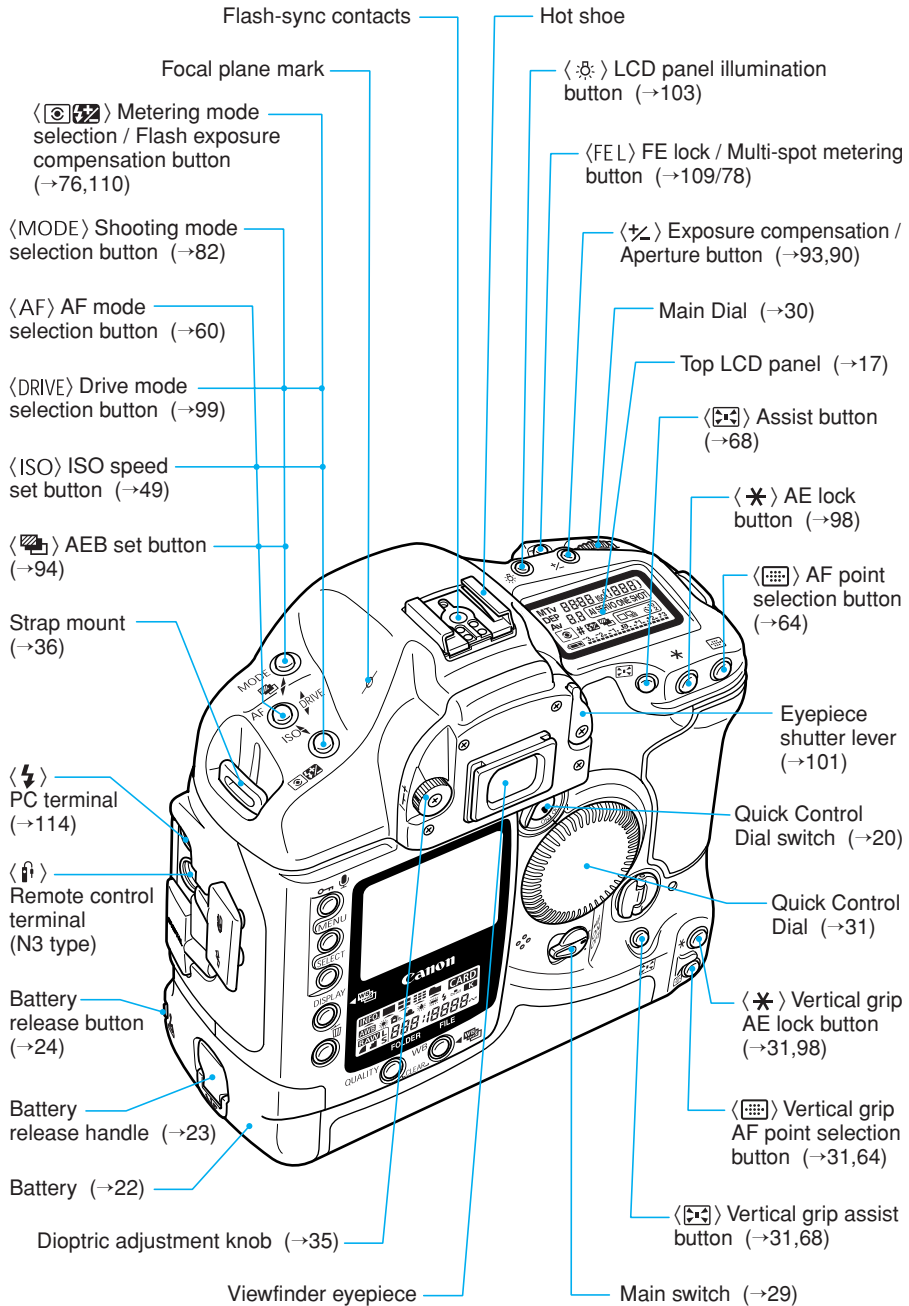

Nomenclature

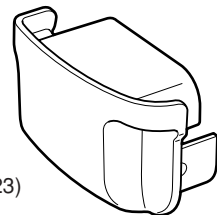
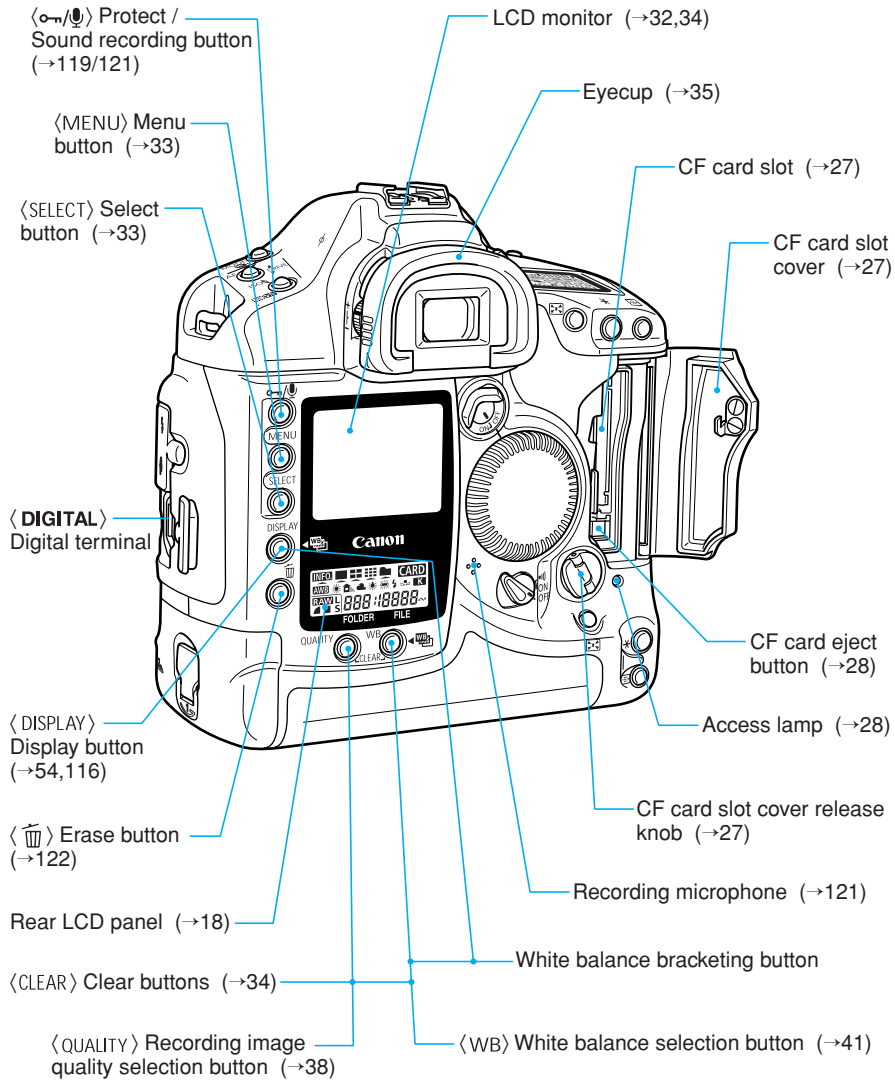

Battery compartment cap (→23)

Top LCD Panel

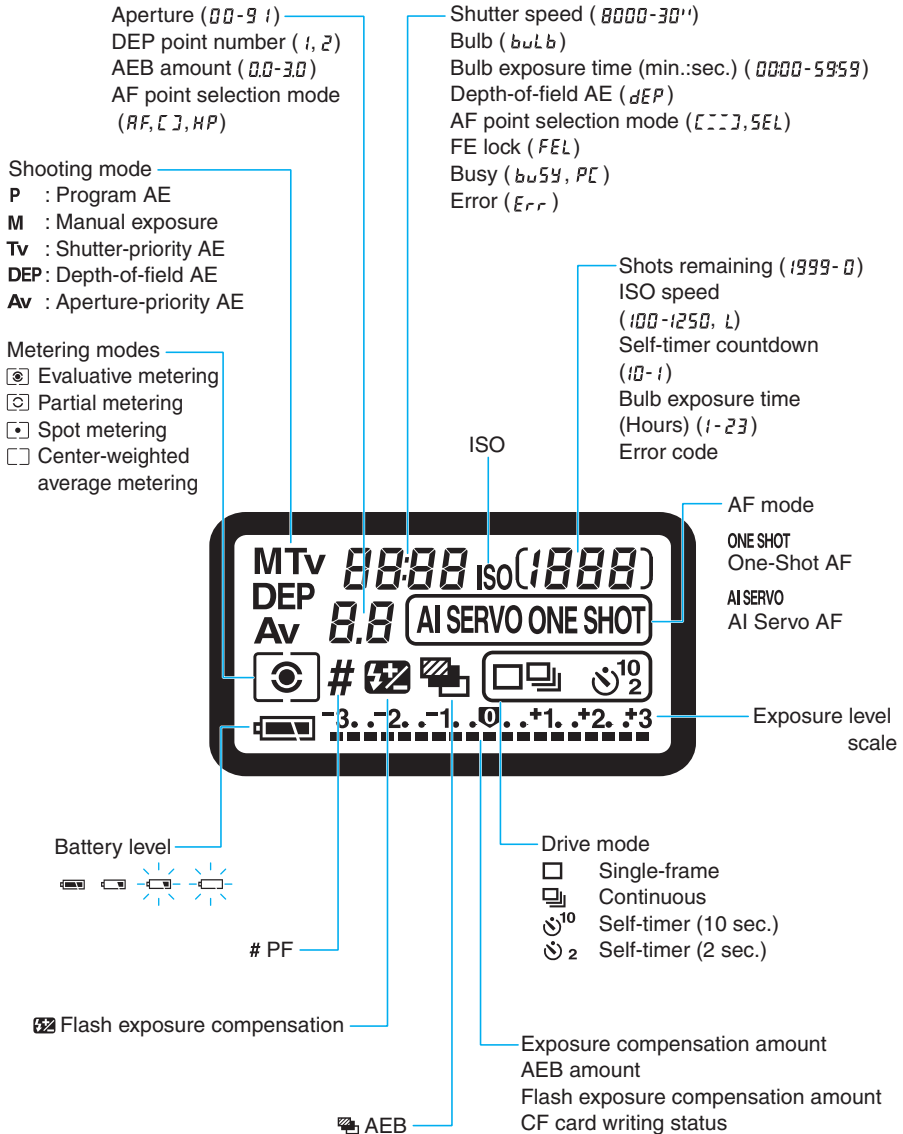

The LCD panel illustration above shows all the icons and indicators displayed. During actual use, only the relevant icons and indicators are displayed.

Rear LCD Panel

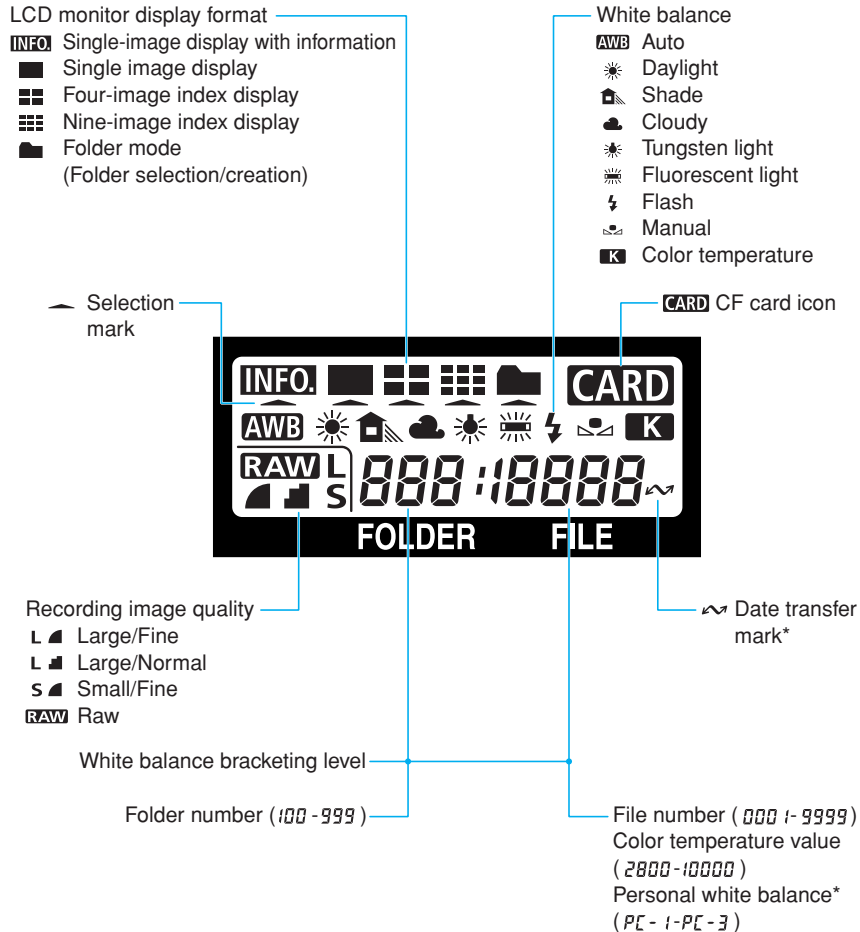

The LCD panel illustration above shows all the icons and indicators displayed. During actual use, only the relevant icons and indicators are displayed.

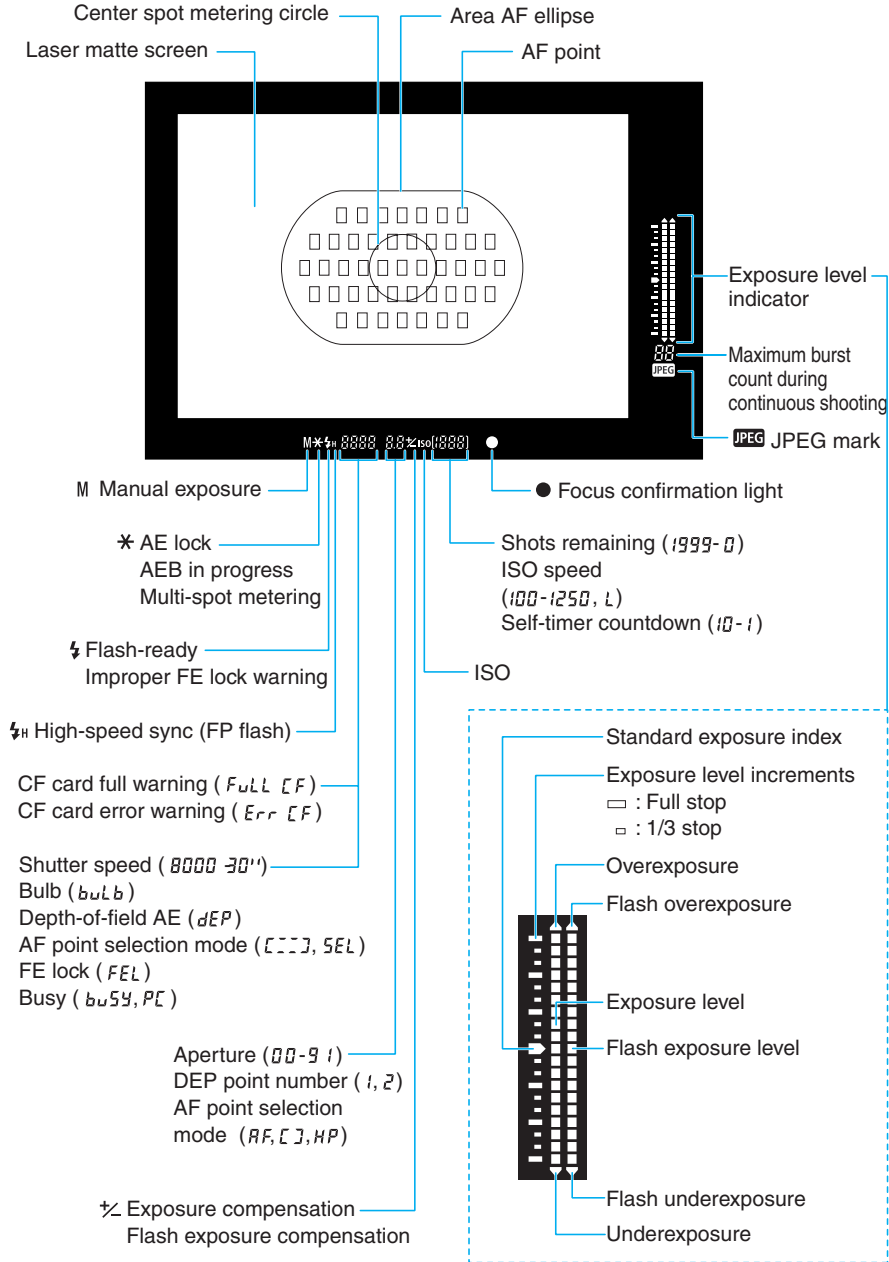

Asterisked items are related to the driver software bundled with the camera.

Viewfinder Information

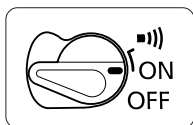

Conventions Used in this Manual ■



- In the text, the  icon indicates the main switch. All operations described in these Instruction Manual assume that the  switch is already set to <ON>. Before proceeding with any operation, first turn the  switch to <ON> or <■||>.

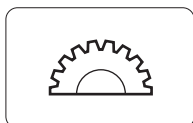



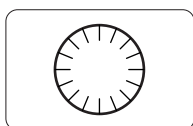



- The  icon indicates the Main Dial.



- The  icon indicates the Quick Control Dial.



- The  icon indicates the Quick Control Dial switch. Operations with the  dial assume that the  switch is already set to <ON>. Be sure it is set to <ON>.

- In these Instruction Manual, the icons and markings indicating the camera's buttons, dials, and settings correspond to the actual icons and markings found on the camera. See "Nomenclature" on page 14.
- For more information, reference page numbers are provided in parentheses (→p.00).
- The Canon EF 50mm f/1.4 USM lens is used as the demonstration lens in these Instruction Manual.
- The procedures assume that the Menu and Custom Functions are set to the default settings.
- Ⓞ6 or Ⓞ16 indicates that the function described remains in effect for 6 sec. or 16 sec. respectively after you let go of the button.
- The sample photographs were taken with a 35mm SLR camera.
- These Instruction Manual use the following alert symbols:
 -  : The Caution symbol indicates a warning to prevent shooting problems.
 -  : The Note symbol gives supplemental information.
 -  : The Light bulb symbol gives a helpful tip for operating your camera or taking pictures.
-  : The Custom Function symbol indicates that there is a relevant Custom Function. For details, see "Custom Functions" on page 133.

1

Before You Start

This chapter explains a few preliminary steps and the basic operation of the EOS-1Ds camera.

Recharging the Battery

First, recharge the battery.

- For details on the battery, refer to the instructions for the Ni-MH Pack NP-E3.
- For details on how to recharge and discharge the battery, refer to the instructions for the Nickel-Hydride Charger NC-E2.

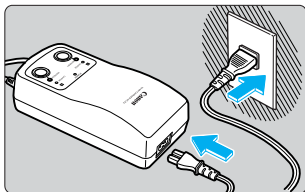

1 Connect the power cord.

- Connect the power cord to the charger.
- Connect the power plug to an AC outlet.
- ▶ The <POWER> lamp will light.

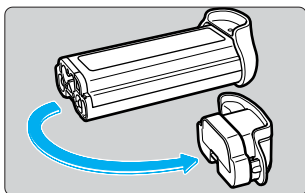

2 Detach the protective cover.

- Attach the cover to the battery compartment cap and retain it.
- Whenever the battery is out of the camera, be sure to attach the protective cover to prevent short circuit.

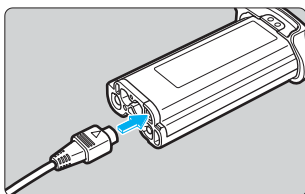

3 Connect the battery.

- Connect the charging plug to the battery's charging terminal.
- The charging plug can be connected to either terminal A or B.

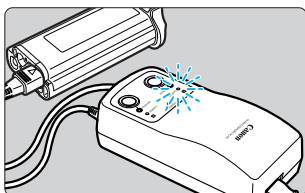

4 Battery recharging starts.

- ▶ When the battery is connected, recharging starts automatically and the <CHARGE> lamp lights.
- ▶ When the battery is completely recharged, the lamp will start blinking (twice per second).
- ▶ **A completely exhausted battery takes about 2 hours to fully recharge.**
- After recharging the battery, disconnect it and unplug the power cord from the AC outlet.

Installing and Removing the Battery

Installing the Battery

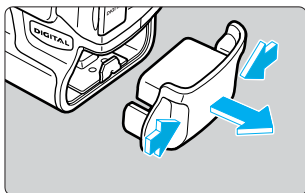

- 1 Detach the battery compartment cap.**
- Grasp both sides of the cap and pull it off.
 - The battery's protective cover can be attached to the battery compartment cap. Keep the cap and cover in a safe place.

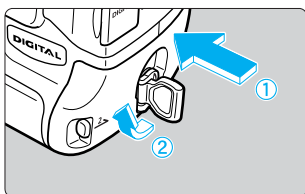

- 2 Insert the battery.**
- Insert the battery and while pushing it in, turn the release handle as shown by the arrow.



If the battery's rubber lining (for water resistance) is not clean, use a moist cotton swab to wipe it clean.

Rubber lining

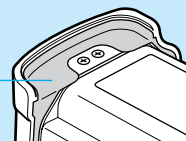

1

Before You Start

Checking the Battery Level

After replacing the battery or before using the camera, check the battery level.

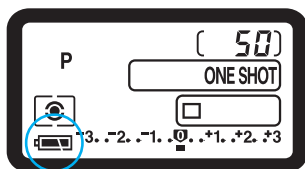

Turn the <ON> switch to <ON>.

- ▶ When the <ON> switch is turned on, the battery check is executed automatically and the battery level is displayed on the top LCD panel.

 : Battery level OK.

 : Battery running low.

 : Battery will be exhausted soon.

 : Recharge the battery.

Battery Life

Temperature	Number of Shots
At 20°C / 68°F	Approx. 600
At 0°C / 32°F	Approx. 450

- The table shows the number of shots that can be taken with a fully-charged battery at the specified temperature. It is based on Canon's testing conditions (w/EF 50mm f/1.4 USM lens, review turned on, reviewing time of 2 sec., and "RAW + L" image quality).



- The actual number of shots will vary depending on your shooting conditions.
- Using the LCD monitor more frequently will reduce the number of shots.
- Pressing the shutter button halfway for a prolonged period or activating the autofocus without taking a picture will also reduce the number of shots.
- At 0°C, the number of shots may actually be less than indicated in the above table.

Removing the Battery

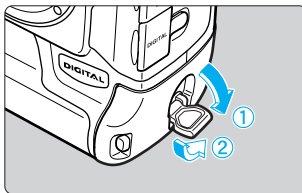

- 1** Flip up and turn the battery release handle as shown by the arrow.

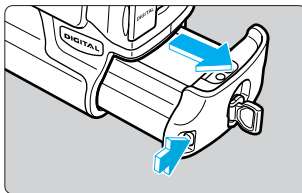

- 2** Press the battery release button and pull out the battery.

Using an AC Outlet

With the DC Coupler Kit, you can connect the camera to an AC outlet to supply power. Then you do not have to worry about exhausting the battery.

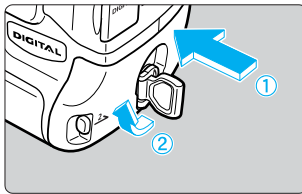

1 Insert the DC Coupler.

- Insert the coupler and while pushing it in, turn the release handle as shown by the arrow.

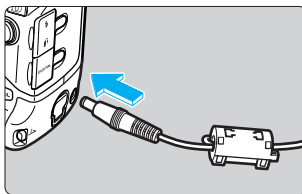

2 Connect the AC adapter's plug to the DC terminal.

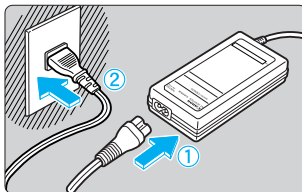

3 Connect the power cord.

- Connect the power cord to the AC adapter.
- Connect the power cord's plug to the AC outlet.
- After you finish using the camera, set the <⏻> switch to <OFF> and remove the plug from the AC outlet.

1

Before You Start



- When connecting the camera to an AC outlet, do not use any adapter other than the dedicated DC Coupler Kit.
- Do not use the DC Coupler Kit with any incompatible camera.
- Do not get the DC coupler wet, as when using it outdoors, since it is not water resistant.
- Do not remove the plug or DC adapter power cord from AC outlet with the <⏻> switch set to <ON>, because it may cause the camera stop operating. If the camera stops operation, remove the DC coupler from the camera and reinstall it. Then the camera will return to normal conditions.

Mounting and Detaching a Lens

Mounting a Lens

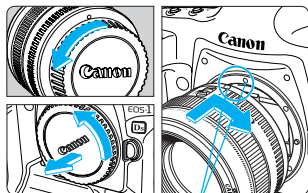

Lens mount index

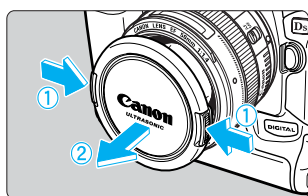
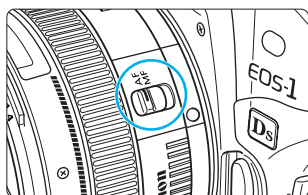

1 Remove the caps.

- Remove the rear lens cap and the body cap by turning them as shown by the arrow.

2 Attach the lens.

- Align the red dots on the lens and camera and turn the lens as shown by the arrow until it snaps in place.

3 On the lens, set the focus mode switch to <AF>.

- If the focus mode switch is set to <MF> (or <M> on older lenses), autofocus will not operate.

4 Remove the front lens cap.

Detaching the Lens

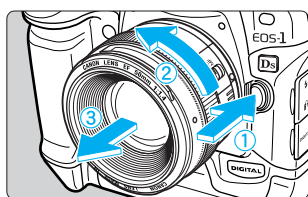

While pressing the lens release button, turn the lens as shown by the arrow.

- Turn the lens until the red dot is at the top, then detach the lens.



- **AF** stands for autofocus.
- **MF** or **M** stands for manual focus.
- Be careful not to lose the lens caps and body cap.

Installing and Removing the CF Card

The pictures you take are recorded on the CF card. The camera is compatible with Type I and Type II CompactFlash (CF) cards. If you want to capture images in the Large/Fine or higher quality mode, a 128 MB or larger capacity CF card is recommended.

Installing a CF Card

1 Before You Start

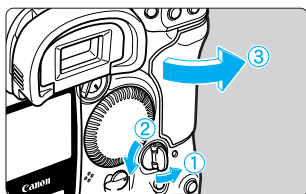

- 1 Open the CF card slot cover.**
- Flip up and turn the cover release knob as shown by the arrow.

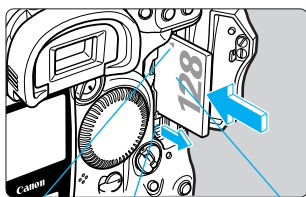

<> arrow Label side
CF card eject button

- 2 Insert the CF card.**
- Make sure the arrow << is on the left side of the card and push the card all the way in.
 - ▶ The CF card eject button will then pop-up.

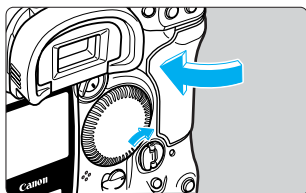

- 3 Close the cover.**
- Push in the cover until the cover release knob returns to its original position.
 - When the <☺> switch is set to <ON>, the top LCD panel and viewfinder will show the number of remaining shots. The rear LCD panel will also display the file number.

Top LCD panel

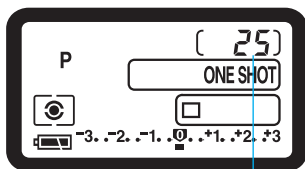

Number of remaining shots

Rear LCD panel



Folder number

File number



- The number of remaining shots depends on how much capacity remains in the CF card and the ISO speed setting.
- The file number is displayed in accordance with the file numbering method you set. (→p.56) If auto reset has been set, the highest file number in the current folder will be displayed. If continuous numbering has been set, the file number of the last captured image will be displayed.

C.Fn C.Fn-08, instead of displaying the number of remaining shots, you can display the ISO speed. And instead of displaying the file number, you can display the number of remaining shots.(→p.135)

Removing the CF Card

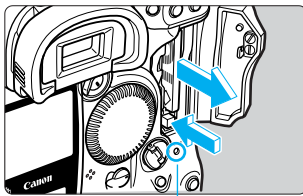

Access lamp

1 Before opening the CF card slot cover:

- Set the $\langle \text{S} \rangle$ switch to $\langle \text{OFF} \rangle$.
- Make sure “busy” is not displayed on the top LCD panel.
- Make sure the access lamp is off, then open the cover.

2 Press the CF card eject button to pop up the CF card, then take out the card.

- Close the cover.





- **While the access lamp is blinking (“busy” is displayed in the viewfinder and on the top LCD panel), do not shake or hit the camera, remove battery, or open the CF card slot cover. Such actions may destroy the image data or damage the camera.**
- After the picture is taken, menu operations will not work during the processing and writing to the CF card (access lamp blinks). If you press the $\langle \text{MENU} \rangle$ button during this time, “Busy” will be displayed on the LCD monitor.
- If a CF card is used for the first time or “Err LF” is displayed on the top LCD panel, see “Formatting a CF Card” on page 126 to format the card.
- Do not use a low-capacity CF card. If the image file size is large, the CF card may not be able to save it.
- A microdrive is a recording medium using a hard disk. It has a large capacity and the price per megabyte is low. However, compared to a CF card equipped with a flash memory, it is vulnerable to vibration and physical shock. If you use a microdrive, be careful not to subject the camera to vibration, shake, or physical shock while it is recording or displaying images.

Basic Operation

Main Switch

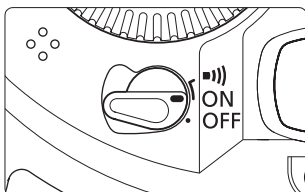
The camera can operate only after the  switch is turned on. This switch has three settings:



- <OFF> : The camera does not operate. Set to this position when not using the camera.
- <ON> : To turn on the camera, set to this position.
- <> : This is the same as <ON> and it also enables the beeper to sound in the following cases:
 - Focus is achieved in One-Shot AF mode.
 - Focus is achieved with manual focus.



- To save battery power, the camera turns off automatically after 1 minute of non-operation. (→p.130) To turn on the camera again, just press the shutter button halfway.
- If you turn the  switch to <OFF> immediately after taking a picture, the access lamp may continue blinking for a few seconds while the CF card records the image data. After the image is recorded, the access lamp will stop blinking and the camera will turn off.

Shutter Button

You can press the shutter button halfway or all the way.

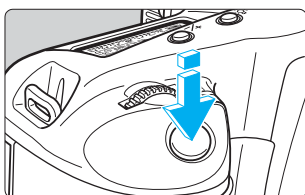

Halfway pressing (Ⓞ6)

When you press the shutter button halfway, autofocus (AF) is activated to focus the subject and auto exposure metering is used to set the correct shutter speed and aperture.

The shutter speed and aperture settings are displayed in the viewfinder and on the top LCD panel.

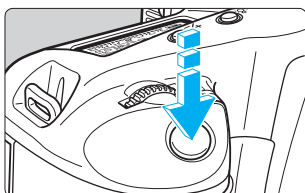

Full pressing

This releases the shutter and takes the picture.



If you press the shutter button halfway and (Ⓞ6) elapse, press it halfway again and wait a moment before pressing it fully to take a picture. If you press the shutter button fully without pressing it halfway first or if you press the shutter button halfway and then press it fully immediately, the camera will still take a moment before it takes the picture.



Pressing the shutter button halfway will also make the camera standby to take a picture at any time. Therefore, even while you are playing back images on the LCD monitor or operating the on-screen menu or if the camera is recording image data, you can go back to taking pictures on the spot.

1

Before You Start

Using the Electronic Dials

Operating the <☀> Dial

The <☀> dial is used to set various settings for taking pictures.

There are three ways to operate this dial:

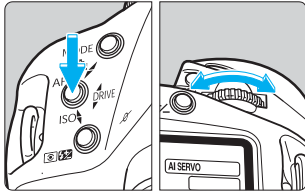

- (1) **While pressing a button, you turn the <☀> dial until the desired setting appears on the top LCD panel.**

When the button is released, the respective setting takes effect and the camera can be used to take pictures.

- In this way, you can set the shooting mode, AF mode, metering mode, drive mode, ISO speed, or AEB amount.

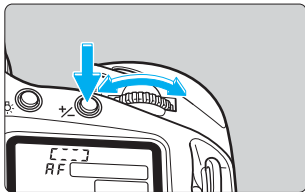

- (2) **After pressing and releasing a button, you turn the <☀> dial.**

When you press a button, its function turns on for 6 sec. During this time, you can turn the <☀> dial to set the desired setting. After the timer turns off or when you press the shutter button halfway, the camera can be used to take pictures.

- In this way, you can set select the AF point or press the <⌂> button and set the exposure compensation amount.

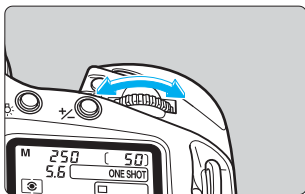

- (3) **Just turn the <☀> dial.**

While referring to the top LCD panel, you turn the <☀> dial to set the desired setting.

- In this way, you can set the shutter speed, aperture, etc.

Operating the <DIAL> Dial

The <DIAL> dial is used for AF point selection, menu operations on the LCD monitor, and other settings. This <DIAL> dial works only when the <ON/OFF> switch is set to <ON>. There are three ways to use the <DIAL> dial:

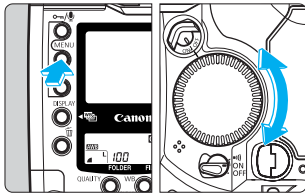

(1) While pressing a button, you turn the <DIAL> dial.

- In this way, you can set the flash exposure compensation amount or select and set various menu settings. When you let go of the button, the selected setting takes effect.
- In this way, you can set the review and select images on the LCD monitor.

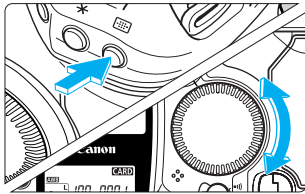

(2) After pressing and releasing a button, you turn the <DIAL> dial.

When you press a button, its function turns on for 6 seconds. During this time, you can turn the <DIAL> dial to set the desired setting. After the button turns off or when you press the shutter button halfway, the camera can be used to take pictures.

- In this way, you can select the AF point or set the exposure compensation amount.

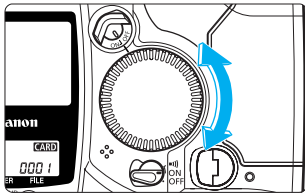

(3) Just turn the <DIAL> dial.

While turning the <DIAL> dial, look at the setting in the viewfinder or on the top LCD panel.

- In this way, you can set the aperture manually.

Vertical Shooting

For vertical shooting, the vertical grip (camera bottom) has a shutter button, Main Dial, AF point selection button, AE lock button, Assist button, and FE lock/multi-spot metering button.

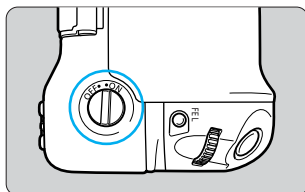

- Before using the vertical-grip controls, turn on the vertical grip operation on/off switch.
- When you are not using the vertical grip, be sure to turn off the vertical grip operation on/off switch to prevent inadvertent operation of the vertical-grip controls.

Menu Operations

By setting various options with the on-screen menus, you can record an image simultaneously in both the RAW and JPEG formats, set the date and time, set Custom Functions, etc. While looking at the LCD monitor, you use the <MENU> button, <SELECT> button, and <ZOOM> dial as explained below.

For details on the various menu settings, see “Menu Settings” on page 127.

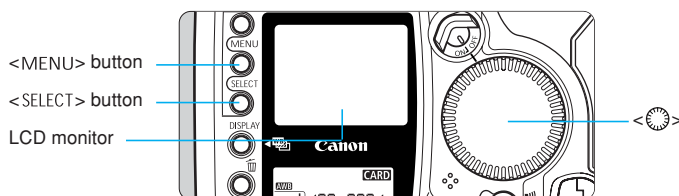

Basic Menu Navigation

- 1 Press the <MENU> button to display the menu.
- 2 Hold down <MENU> and turn the <ZOOM> dial to select a menu tab (📷 🎞️ ⚙️ 🏠).
- 3 Hold down <SELECT> and turn the <ZOOM> dial to select a menu item. After selecting the menu item, let go of the <SELECT> button.
- 4 Hold down <SELECT> and turn the <ZOOM> dial to select a setting. When the desired menu setting is selected, let go of the <SELECT> button. The setting will then take effect immediately. To exit the menu, press the <MENU> button.

📷	Recording menu
🎞️	Playback menu
⚙️	Set-up menu
🏠	Custom / Personal Functions menu



Whenever this MENU icon is displayed, you can press the <MENU> button to go back to the upper level menu screen.

Menu tab name

Detailed Menu Navigation

- 1 Press the <MENU> button to display the menu.
 - To turn off the menu, press the button again.
 - With the menu displayed, follow the procedure below.

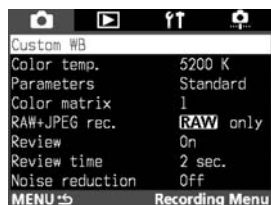

2 Select a menu tab (CAMERA, PLAYBACK, SHOOTING, CUSTOM).

- Hold down the <MENU> button and turn the <DISP.> dial to select a tab, then let go of the button.

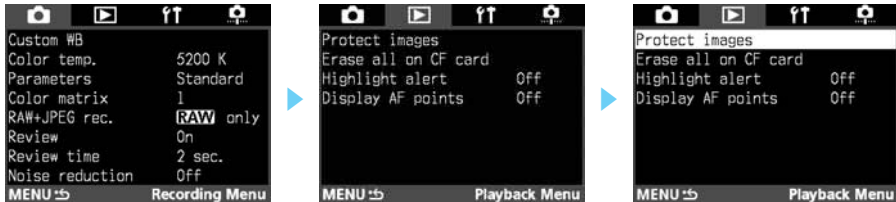

3 Select a menu item.

- Hold down the <SELECT> button and turn the <DISP.> dial to select a menu item, then let go of the button.

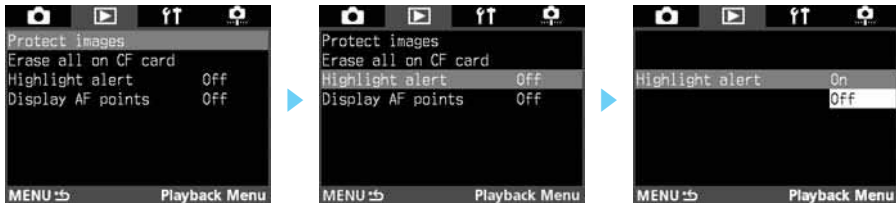

4 Select the menu setting.

- Hold down the <SELECT> button and turn the <DISP.> dial to select the desired setting, then let go of the button. The setting will take effect immediately.

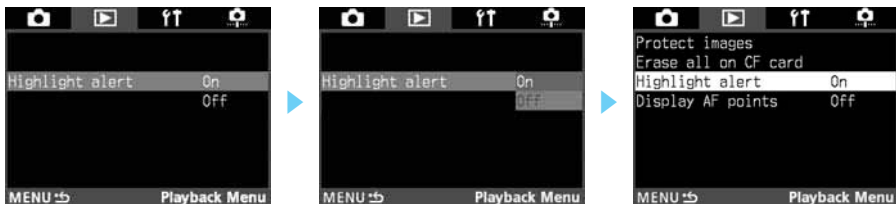

5 Press the <MENU> button to exit the menu.

- The LCD monitor will turn off.
- You can also exit the menu by pressing the shutter button halfway.



- In step 1, you can also hold down the <MENU> button and when the menu appears, you can turn the <DISP.> dial to select a menu tab. (Keep pressing the <MENU> button while turning the <DISP.> dial.)
- Even while the menu is displayed, you can immediately go back to taking pictures by pressing the shutter button halfway.
- The menu can be displayed in one of five languages (English, French, German, Spanish, and Japanese). (→p.131)
- Check that the date and time has been set correctly. Each image will be recorded with the current date and time. (→p.148)

1

Before You Start

About the LCD Monitor

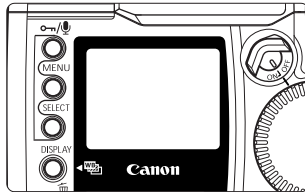

The color LCD monitor on the back of the camera enables you to review and select recorded images and set various menu settings.

- With the LCD monitor, you can use the dial even while the switch is <OFF>.
- The LCD monitor cannot be used as a viewfinder to take pictures.



You can change the brightness of the LCD monitor. (→p.130)

Reverting to the Default Settings

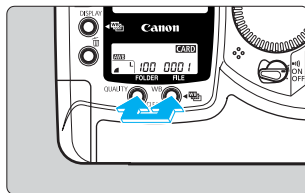

To revert to the camera's default settings, press the <QUALITY> button and <WB> button simultaneously for 2 sec.

- ▶ The camera's default settings are shown below.

Shooting Settings

Shooting mode	<P> Program AE
AF mode	One-Shot AF
Metering mode	Evaluative
Drive mode	Single frame
AF point selection	Automatic
Exposure compensation	0 (Zero)
Flash exposure compensation	0 (Zero)
AE lock	Canceled
FE lock	Canceled
AEB	Canceled
Custom Functions	Settings retained
AF point registration	Center AF point

Image Recording Settings

Image quality	L (Large/Fine)
White balance	(Auto)
White balance bracketing	Canceled
Image processing parameters	Standard
Color Matrix	1



The camera will be ready to work fully automatic after this operation. (→p.82)

Dioptric Adjustment

By adjusting the diopter to suit your eyesight (with or without eyeglasses), the viewfinder image will look clearer. The camera's adjustable dioptic range is -3 to $+1$ dpt.

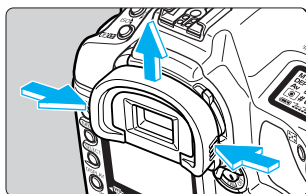

- 1 Remove the eyecup.**
 - While grasping both sides of the eyecup, slide it upward to remove.

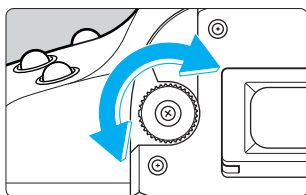

- 2 Turn the dioptic adjustment knob.**
 - Turn the knob to the right or left until the AF point or the center spot metering circle looks sharp in the viewfinder.

- 3 Reattach the eyecup.**



If the camera's dioptic adjustment still cannot provide a clear viewfinder image, using Dioptic Adjustment Lens E (10 types) is recommended. (→p.167)

1

Before You Start

Holding the Camera

To obtain sharp pictures, hold the camera still to minimize camera shake.

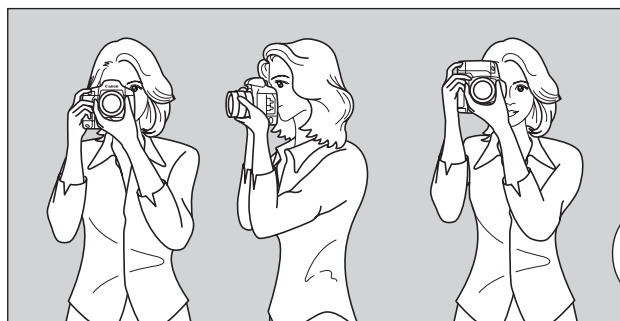

Horizontal shooting

Vertical shooting

- Firmly grasp the camera grip with your right hand, and press your both elbows lightly against your body.
- Hold the lens at the bottom with your left hand.
- Press the camera against your face and look through the viewfinder.
- To maintain a stable stance, place one foot in front of the other instead of lining up both feet.

Attaching the Neck Strap and Hand Strap

Attaching the Hand Strap

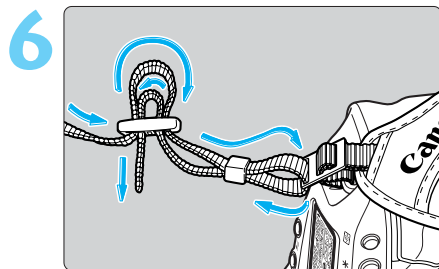
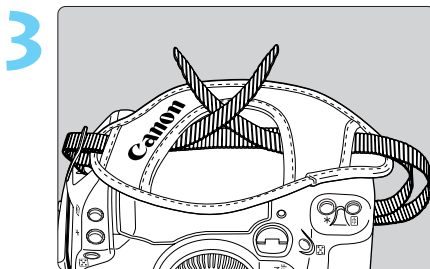
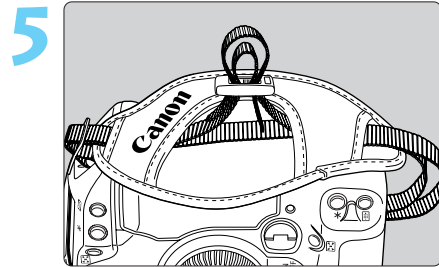
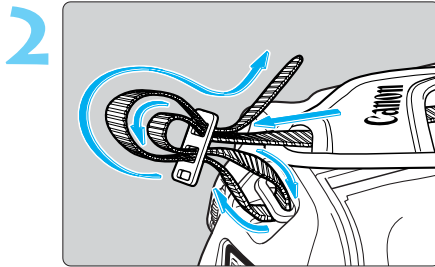
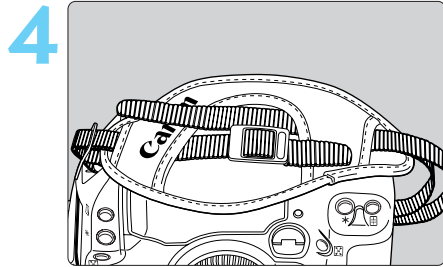
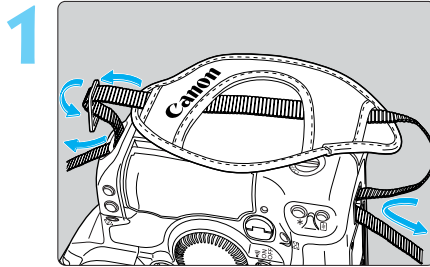

Attaching the Neck Strap

 After attaching the strap, pull it to make sure it does not loosen at the buckle.



Settings for Images

This chapter explains the specific settings for shooting with a digital camera: Image-recording quality, white balance, ISO speed, and image-processing parameters. You will also learn how to review and organize the recorded images.

MENU Image-Recording Quality

Four image-recording quality settings are provided. Images recorded in the <L ▀>, <L ▀▀>, or <S ▀> mode do not require processing afterward. However, an image recorded in the <RAW> mode will require processing with a personal computer.

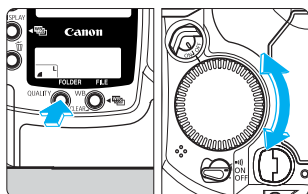

Select the image-recording quality.

- While pressing the <QUALITY> button, turn the <QUALITY> dial to select the desired image-recording quality. Then let go of the <QUALITY> button.
- If you select the <L ▀>, <L ▀▀>, or <S ▀> JPEG format, the <JPEG> icon will be displayed in the viewfinder's lower right corner.

L ▀ Large/Fine

Records an 11-megapixel image with low-compression JPEG. It saves the JPEG image with the highest image quality. Note that due to the large file size, fewer images can be recorded on the CF card.

L ▀▀ Large/Normal

Records an 11-megapixel image with high-compression JPEG. It saves the JPEG image with a relatively high image quality while enabling more images to be recorded on the CF card.

S ▀ Small/Fine

Records an 11-megapixel image with low-compression JPEG after conversion to a 2.7-megapixel image. It maximizes the number of images that can be recorded on the CF card.

RAW RAW

Records the image with lossless compression resulting in about 11 megapixels. Use this mode when you want to use a personal computer to process the image afterward. Due to the large file size, fewer images can be recorded on the CF card.

Processing

Processing is the alteration of the raw image data captured with the camera's CMOS imaging element. For example, the digital image's white balance and image quality can be altered. Images recorded in the <L [mountain]>, <L [mountain]>, or <S [mountain]> mode undergo processing by the camera before being saved as a JPEG image. <RAW> images are processed according to the color matrix, white balance and processing parameters set at the time of shooting. A <RAW> image can be processed repeatedly using the provided software.

Image File Size and CF Card Capacity According to Image-Recording Quality

Image-Recording Quality	Image Size (Pixels)	Format	Compression Rate	Image File Size (Approx.)	Max. Capacity (Approx.)
L [mountain] Large/Fine	4064 x 2704 (Approx. 11.0 million)	JPEG	Low	4.1 MB	25 images
L [mountain] Large/Normal			High	1.7 MB	65 images
S [mountain] Small/Fine	2032 x 1352 (Approx. 2.7 million)		Low	1.4 MB	80 images
RAW Raw	4064 x 2704 (Approx. 11.0 million)	Lossless RAW		11.4 MB	8 images
RAW + L [mountain]	-	RAW + JPEG		15.3 MB	4 images
RAW + L [mountain]				12.9 MB	6 images
RAW + S [mountain]				12.6 MB	7 images

- The maximum capacity applies to a 128 MB CF card (optional FC-128M).
- The image file size and CF card's maximum capacity are based on Canon's testing standards (with ISO 100 and "Standard" processing parameter).
- The image file size and the CF card's maximum capacity depend on the processing parameter, subject, shooting mode, and ISO speed.
- The CF card's number of remaining shots is displayed on the top LCD panel. (→p.27)
- In the RAW + L [mountain], L [mountain], and S [mountain] mode, you can record the image in both the RAW and JPEG formats simultaneously. (→p.40)



- To open images recorded in the RAW format, you must use the dedicated driver software that came with the camera. For details, see "EOS DIGITAL Software User's Manual."
- With higher ISO speeds (→p.49), the image will contain more noise and the file size will be larger. Therefore, fewer images can be recorded on the CF card. On the top LCD panel, you can check the number of images the CF card can record. (→p.27)

MENU Simultaneous Capture in RAW and JPEG Formats

In the <RAW> image-recording quality mode, you can capture the an image in both the RAW and JPEG formats simultaneously. This is convenient when you want both RAW and JPEG versions of the same image. The RAW image can undergo optimal processing, while the JPEG image enables you to use the image as is without any processing.

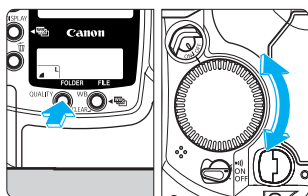

1 Select RAW on the rear LCD panel.

- While pressing the <QUALITY> button, turn the <Q> dial to select <RAW> displayed on the rear LCD panel. Then let go of the <QUALITY> button.

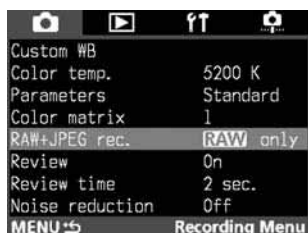
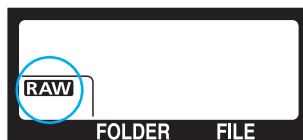

2 On the LCD monitor menu, select “RAW+JPEG rec.”

- Press the <MENU> button.
- While pressing the <MENU> button, turn the <Q> dial to select <Q>.
- While pressing the <SELECT> button, turn the <Q> dial to select “RAW+JPEG rec.” Then let go of the <SELECT> button.



3 Select the JPEG image quality.

- While pressing the <SELECT> button, turn the <Q> dial to select the desired JPEG image quality. Then let go of the <SELECT> button.
- ▶ The menu will reappear.
- When you take a picture, it will be recorded in both the RAW and JPEG formats simultaneously.
- To stop recording the image in both formats, select “RAW only” on the LCD monitor menu.



- When the image is recorded in both the RAW and JPEG formats, the <JPEG> icon will not be displayed in the viewfinder. The rear LCD panel will also not display the JPEG image quality (<L L>, <L L> or <S L>).
- The RAW and JPEG images captured simultaneously will have the same image file number but a different extension. The JPEG image will have the .JPG extension and the RAW image will have .TIF.
- The <L L>, <L L> or <S L> image-recording quality selection with the procedure explained on the preceding page will remain in effect even during the simultaneous RAW and JPEG image capture.

WB Selecting the White Balance

The following white balance settings are provided: Auto, daylight, shade, overcast, tungsten, fluorescent, flash, custom, color temperature, and personal white balance (set with the bundled driver software, →p.45).

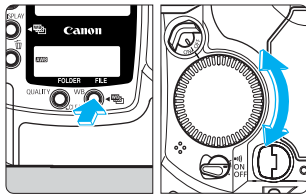

1 Select the white balance setting.

- While pressing the <WB> button, turn the <MODE> dial to select the desired white balance setting. Then let go of the <WB> button.

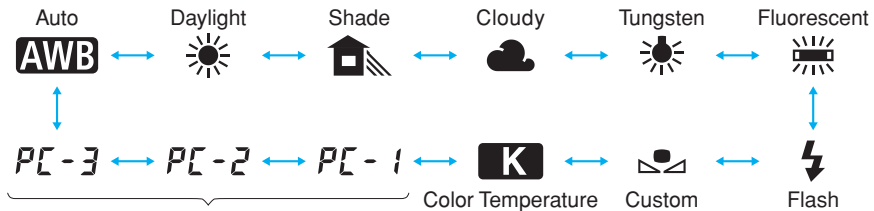

Personal white balance settings (→p.45)
Not displayed if not registered in the camera.









About White Balance

The three R (red), G (green), and B (blue) primary colors exist in varying proportions in a light source depending on its color temperature. When the color temperature is high, there is more blue. And when the color temperature is low, there is more red. As the color temperature increases from low to high, the color cast changes in the following sequence: red, orange, yellow, white, and bluish white. For example, if you have a white object under a lit tungsten light bulb, it will look red or orange in the photograph. If it is under fluorescent light, it will look greenish.

To the human eye, a white object still looks white regardless of the type of lighting. The human eye is highly adaptive to different types of lighting and color temperatures. With a film-based camera, you can attach a color correction filter to the lens or use tungsten film to compensate for the color cast caused by the light source's color temperature. With a digital camera's white balance setting, you can digitally compensate (based on a standard white color) the color temperature so that the colors in the image look more natural.

When <AWB> is set, auto white balance is obtained with the CMOS sensor and external white balance sensor. If the external white balance sensor is obstructed, an auto white balance reading will still be taken. However, it will be a different reading from when the sensor is not obstructed. If you cannot obtain the image with the desired white balance setting, use a white balance setting other than <AWB>.

White Balance Settings

Icon	Application	Color Temperature (Kelvin)
	The camera sets the white balance automatically.	Approx. 3000-7000 K
	For sunny daylight outdoors.	Approx. 5200 K
	For shaded areas outdoors.	Approx. 7000 K
	For cloudy or hazy days and during sunsets.	Approx. 6000 K
	For tungsten (light bulb) light.	Approx. 3200 K
	For fluorescent light.	Approx. 4000 K
	When flash is used.	Approx. 6000 K
	First you photograph a white object to be used as the standard for the white balance setting. By using the white balance data from this image, you can set the optimum white balance. (→p.43)	Approx. 2000-10000 K
	You can manually set white balance for 2800-10000 K (in 100 K increments). (→p.45)	Approx. 2800-10000 K
<i>P</i> [- 1	You can set and save up to three custom white balance settings with the dedicated driver. (→p.45) (Not displayed if no personal white balance settings have been registered.)	-
<i>P</i> [- 2		
<i>P</i> [- 3		

MENU Custom White Balance

With custom white balance, you photograph a white object that will serve as the standard for the white balance. By selecting this image, you import its white balance data for the white balance setting.

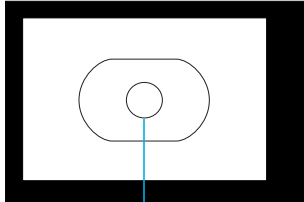

Center spot metering circle

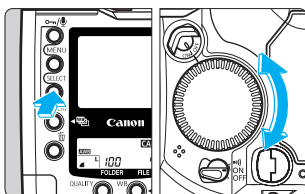
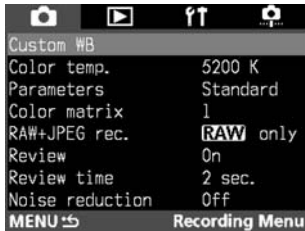

1 In the <P> Program AE mode (→p.82), photograph a white object.

- Make sure the white subject fills the entire center spot metering circle.
- Shoot the white subject with standard exposure. Correct white balance might not be obtained if the subject is over- or under-exposed.

2 On the LCD monitor menu, select “Custom WB.”

- Press the <MENU> button.
 - While pressing the <MENU> button, turn the <SELECT> dial to select <CAM>.
 - While pressing the <SELECT> button, turn the <SELECT> dial to select “Custom WB.” Then let go of the button.
- ▶ An index of nine images will appear.

3 Select an image.

- While pressing the <SELECT> button, turn the <SELECT> dial to select an image. Then let go of the <SELECT> button.
- Images not taken with the EOS-1Ds cannot be selected.



4 Import the white balance data.

- While pressing the <SELECT> button, turn the <SELECT> dial to select “OK.” Then let go of the <SELECT> button.
- ▶ The image's white balance data will be imported.

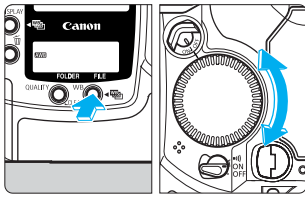

5 Select the custom white balance.

- While pressing the <WB> button, turn the <DIAL> dial to select <CUSTOM>. Then let go of the <WB> button.
- ▶ The custom white balance will be set.



- For the standard white object, a sheet of plain, white paper is recommended.
- You can store on the CF card the images of the standard white object photographed under various lighting. Then while shooting, you can select one of these images with the “Custom WB” menu command to easily set the white balance best suited for the current lighting condition.

MENU Setting the Color Temperature

You can set the white balance color temperature from 2800 K to 10000 K (in 100 K increments).

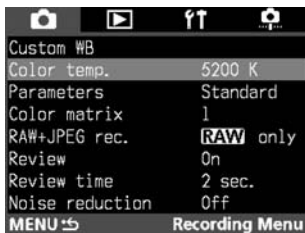

1 On the menu, select “Color temp.”

- Press the <MENU> button.
- While pressing the <MENU> button, turn the <DIAL> dial to select <CAMERA>.
- While pressing the <SELECT> button, turn the <DIAL> dial to select “Color temp.” Then let go of the <SELECT> button.



2 Set the color temperature.

- While pressing the <SELECT> button, turn the <DIAL> dial to select the desired color temperature. Then let go of the <SELECT> button.
- The color temperature can be set from 2800 K to 10000 K in 100 K increments.
- ▶ After you set the color temperature, the menu will reappear.
- To exit the menu and turn off the LCD monitor, press the <MENU> button.

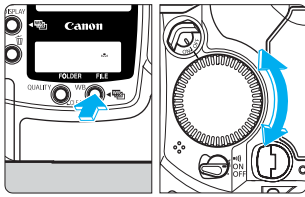

3 Select the color temperature.

- While pressing the <WB> button, turn the <mode> dial to select <K>. Then let go of the <WB> button.
- ▶ The color temperature will take effect.



- Use <K> to set the color temperature of natural light. If <K> is used to set the color temperature of artificial light, correct white balance might not be obtained.
- For <K>, if you want to use the reading taken with a color temperature meter, take test shots and adjust the setting to compensate for the difference between the color temperature meter's reading and the camera's color temperature reading.

Selecting Personal White Balance

You can set your own white balance with the dedicated driver software provided with the camera. You can thereby obtain a more accurate white balance in the image. It is ideal when you have to take many pictures under the same lighting conditions such as in a photo studio. For details, see the “EOS DIGITAL Software User’s Manual.”

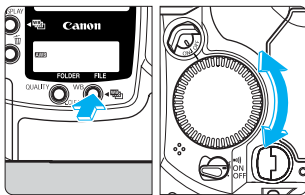

Select a registered personal white balance setting.

- While pressing the <WB> button, turn the <mode> dial to select “PC-1”, “PC-2” or “PC-3”. Then let go of the <WB> button.
- ▶ The selected personal white balance setting will take effect.



White Balance Auto Bracketing

You can bracket the white balance of three consecutive shots automatically within ± 3 stops in full-stop increments. For each shot, the camera changes the color temperature automatically vis-à-vis the current white balance setting. One stop is equivalent to 5 mired as provided by a color conversion filter. The three-shot bracketing sequence will be as follows: standard color temperature, bluish (minus), and reddish (plus). The current drive mode (\rightarrow p.99) is used during the bracketing sequence.

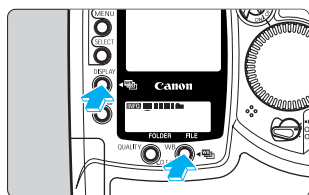

1 Press the <DISPLAY> and <WB> buttons simultaneously.

- ▶ The rear LCD panel will display the <---!--->.

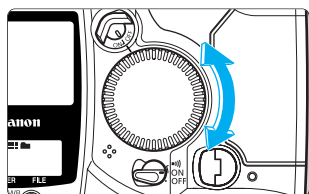
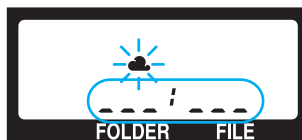

Standard amount

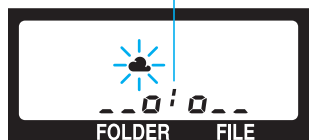

± 1 stop



± 2 stops



Bracketing amount
 ± 3 stops

2 Set the bracketing amount.

- Let go of the <DISPLAY> button or <WB> button, then turn the <DIAL> dial.
- ▶ The rear LCD panel will display the bracketing amount, and the icon for the current white balance setting will blink.
- After selecting the desired bracketing amount, let go of the <DISPLAY> button and <WB> button.
- ▶ While white balance bracketing is active, the icon for the current white balance setting will blink on the rear LCD panel.

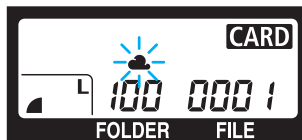

Indicator for the standard shot



Bluish (minus) compensation



Reddish (plus) compensation



3 Take the pictures.

- ▶ The bracketed shots will be taken in the following sequence: standard color temperature, bluish (minus), and reddish (plus). During this sequence, the next bracketing level is indicated (by blinking) on the LCD monitor.
- The current drive mode is used when you take the bracketed shots. (→p.99)
- If continuous shooting is used, holding down the shutter button fully will capture all three bracketed shots continuously and then the shooting will stop.
- If the self-timer is also set, all three bracketed shots will be taken continuously after the self-timer delay of 2 sec. or 10 sec. elapses.

Canceling White Balance Auto Bracketing

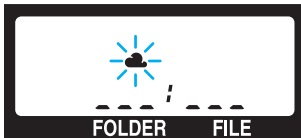

- Follow steps 1 and 2 above to set the bracketing amount to <--- ' --->. Then let go of the <DISPLAY> and <WB> buttons.
- White balance auto bracketing will also be canceled automatically after any of the following actions: the CF card is replaced, the battery is replaced, a bulb exposure is set, the flash is ready, the <CLEAR> button is pressed, or the <☺> switch is set to <OFF>.



- White balance auto bracketing cannot be used together with flash, bulb exposures, or auto exposure bracketing (AEB).
- If C.Fn-12-1 (mirror lockup) is used during white balance auto bracketing, the bracketed shots will not be taken continuously even if the drive mode is set to continuous shooting.



If the drive mode is single-frame shooting, press the shutter button once for each of the three bracketed shots.

C.Fn

- With C.Fn-09-2/3, you can change the white balance auto bracketing sequence. (→p.135)
- With C.Fn-9-1/3, you can prevent the white balance auto bracketing from being canceled when you change the lens, replace the CF card, replace the battery, or set the <☺> switch to <OFF>. (→p.135)
- With C.Fn-01-1, you can still display the viewfinder information during continuous shooting. (→p.133)

MENU Selecting the Color Matrix

The color matrix enables you to select the preferred hue, chroma, and color gamut (range of reproducible colors). These are equivalent to color film characteristics.

The camera provides five color matrixes to suit the required application.

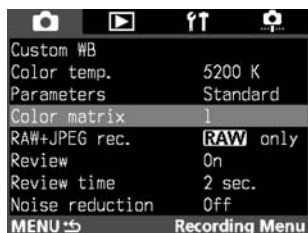

1 On the menu, select “Color matrix.”

- Press the <MENU> button.
- While pressing the <MENU> button, turn the <DIAL> dial to select <CAMERA>.
- While pressing the <SELECT> button, turn the <DIAL> dial to select “Color matrix.” Then let go of the <SELECT> button.



2 Select the color matrix.

- While pressing the <SELECT> button, turn the <DIAL> dial to select the desired color matrix setting number. Then let go of the <SELECT> button. A description of each setting is provided in the table below.
- ▶ After you set the color matrix, the menu will reappear.
- To exit the menu and turn off the LCD monitor, press the <MENU> button.

Setting No.	Description
1	Sets a natural-looking hue and chroma. Effective for bringing out the subject's natural colortone.
2	Sets a hue and chroma suitable for portraits. Effective for rendering nice skin tones.
3	Sets a hue and chroma similar to high-chroma slide film. Effective for making the colors clear.
4	The image corresponding to Adobe RGB color space is created. It is useful for profile conversion to Adobe RGB or fine-tuning of chroma, because the color reproduction range is much wider than the standard sRGB setting. Adobe RGB must be selected for profile conversion, because the ICC profile is not attached to the images shot by this camera. Also, chroma adjustment is required as chroma is lowered under sRGB circumstance.
5	Sets an image low-chroma. Effective for making color tone moderate.



The color space for the color matrix 1, 2, 3 and 5 is set to sRGB.

Setting the ISO Speed

The ISO speed is a numeric indication of the sensitivity to light. (→p.154)

A higher ISO speed number indicates a higher sensitivity to light. Therefore, a high ISO speed is suited for moving subjects or taking pictures in low-light conditions. However, the image will contain more noise to make it look coarse or grainy. On the other hand, a low ISO speed will make the image look finer, but it is not suited for freezing motion or shooting in low light.

The camera can be set to any of the following ISO speeds: ISO 100, 125, 160, 200, 250, 320, 400, 500, 640, 800, 1000, or 1250.

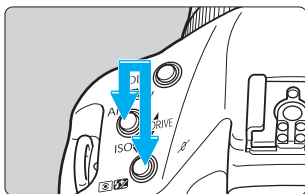

1 Hold down the <AF> and <ISO> buttons simultaneously.

- ▶ The <ISO> icon and current ISO speed will be displayed on the top LCD panel.

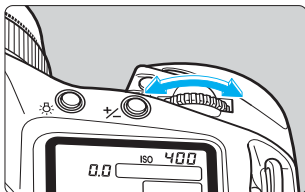
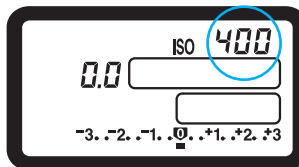

2 While still pressing the two buttons, turn the <ISO> dial to select the desired ISO speed displayed.

3 Let go of the buttons.

- ▶ The new ISO speed will be set.



When higher ISO speed is set or the camera is used under higher temperature, more noise will appear in the image. In this case, image file size will grow and fewer images will be recorded on the CD card. Number of shots remaining can be confirmed on the top LCD panel. (→p.27)

C.Fn

- With C.Fn-03-1, you can set sensitivity at ISO 50. (→p.133)
- With C.Fn-08-1/2, you can display the ISO speed instead of the number of remaining shots. (→p.135)

MENU Setting the Processing Parameters

The image you capture can be processed automatically by the camera according to one of three sets of processing parameters (tone curve, sharpness, and JPEG quality) you set. **Regarding the tone curve, you must use the dedicated software to set it in the camera beforehand. The setting procedure is described in the “EOS DIGITAL Software User’s Manual.”**

Parameter	Description	Setting	Effect
Tone Curve	Adjusts the image brightness and color properties.	Standard TCD 1 2 3	You can change the image brightness and color balance as desired.
Sharpness Level	Adjusts the sharpness level.	0 1 2 3 4 5	A higher number will result in a sharper image.
	Selects the pattern type to be sharpened. (pattern sharpness)	Fine	“Fine” will sharpen the fine patterns of the image. “Rough” will sharpen the rough patterns of the image.
		Moderately fine	
		Standard	
		Moderately rough	
		Rough	
JPEG Quality	Sets the image quality of the (Fine) mode.	6 7 8 9 10	A higher number will result in a higher image quality.
	Sets the image quality of the (Normal) mode.	1 2 3 4 5	

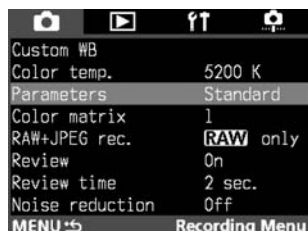

1 On the menu, select “Parameters.”

- Press the <MENU> button.
- While pressing the <MENU> button, turn the dial to select <CAMERA>.
- While pressing the <SELECT> button, turn the dial to select “Parameters.” Then let go of the <SELECT> button.



2 Select “Setting.”

- While pressing the <SELECT> button, turn the dial to select “Setting.” Then let go of the <SELECT> button.
- ▶ The processing parameter setting screen will appear.



- 3 Select the set No.**
- While pressing the <SELECT> button, turn the <DIAL> dial to select Set 1, 2, or 3. Then let go of the <SELECT> button.

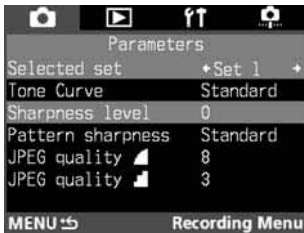

- 4 Select the parameter to be set.**
- While pressing the <SELECT> button, turn the <DIAL> dial to select the parameter. Then let go of the <SELECT> button.

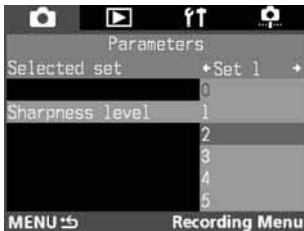

- 5 Set the parameter.**
- While pressing the <SELECT> button, turn the <DIAL> dial to set the desired parameter setting. Then let go of the <SELECT> button.
 - Repeat steps 4 and 5 to set the other parameters.
 - To select another Set No., hold down the <SELECT> button and turn the <DIAL> dial to select the Set No. Then do step 3.
 - Pressing the <MENU> button will return you to step 2.

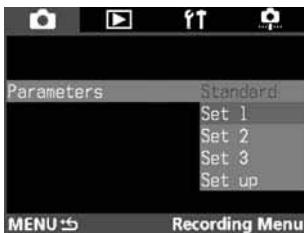

- 6 Select the Set No. which was set.**
- While pressing the <SELECT> button, turn the <DIAL> dial to select Set 1, 2, or 3. Then let go of the <SELECT> button.
 - ▶ When the Set No. is set, the menu will reappear.
 - Pressing the <MENU> button will quit the menu and turn off the LCD monitor.



- The “Standard” parameter setting cannot be modified.
- For the tone curve setting, “TCD *” stands for Tone Curve Data.

MENU Reviewing Images

Image Review

The image can be displayed on the LCD monitor immediately after you take the picture. You can set one of three image review options: “On” to display the image, “On (Info)” to display both the image and shooting information, and “Off” to not display the image.

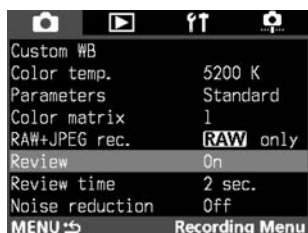

1 On the menu, select “Review.”

- Press the <MENU> button.
- While pressing the <MENU> button, turn the <DISP> dial to select <CAM>.
- While pressing the <SELECT> button, turn the <DISP> dial to select “Review.” Then let go of the <SELECT> button.



2 Set the desired Review setting.

- While pressing the <SELECT> button, turn the <DISP> dial to select the desired setting. Then go of the <SELECT> button.
 - ▶ The menu will reappear.
- To exit the menu and turn off the LCD monitor, press the <MENU> button.

3 Take a picture.

- ▶ The picture will be displayed on the LCD monitor.

Review “On” setting



Review “On (Info)” setting (→p.118)

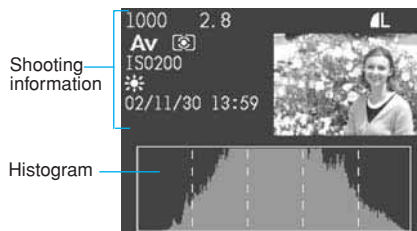

- You can also change the number of seconds the image is displayed (review time). (→p.53)
- After continuous shooting, only the last shot will be displayed. For the displayed image, you can protect it from deletion (→p.119), make a sound recording (→p.121), or erase it. (→p.122)

Changing the Review Time

You can change the number of seconds the image is displayed on the LCD monitor after it is captured.

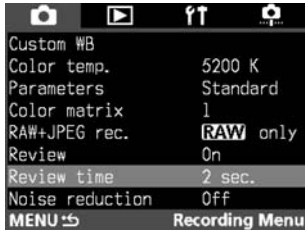

- 1 On the menu, select “Review time”.**
- Press the <MENU> button.
 - While pressing the <MENU> button, turn the <◁/▷> dial to select <CAM>.
 - While pressing the <SELECT> button, turn the <◁/▷> dial to select “Review time.” Then let go of the <SELECT> button.



- 2 Set the desired Review time.**
- While pressing the <SELECT> button, turn the <◁/▷> dial to select the desired review time. Then go of the <SELECT> button.
 - ▶ The menu will reappear.
 - To exit the menu and turn off the LCD monitor, press the <MENU> button.

Settings for Images



The “Hold” setting will set the review time to half of the auto power off time. (→p.130) If auto power off is “Off,” the review time will be 15 min.

Automatic Playback After Continuous Shooting

- After continuous shooting when the access lamp is blinking, you can press the <DISPLAY> button to playback the image that is currently being saved on the CF card. When you press the button, you will not see the images shot continuously from the beginning, but from the image currently being saved on the CF card.
- To turn off the LCD monitor, press the <DISPLAY> button.



- After the last shot in the continuous shooting burst is taken, the image will be saved onto the CF card as the access lamp blinks. Be sure not to open the CF card slot cover or remove the battery while the access lamp is blinking.
- If the selection mark is positioned under the <▶> icon on the rear LCD panel, automatic playback is not possible.

Creating and Selecting a Folder

You can create folders to organize your images according to shooting date or subjects. You can select any folder to store the images captured with the camera.

Creating a Folder with the Camera

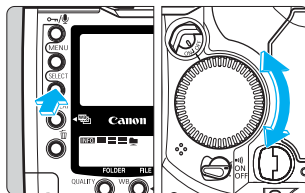
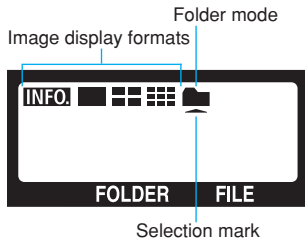
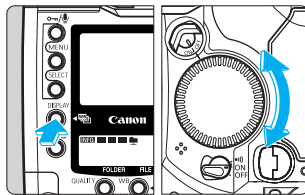

1 Set the folder mode.

- While pressing the <DISP> button, turn the <DIAL> dial to select <FOLDER> on the rear LCD panel.
- ▶ The LCD monitor will switch to the folder mode.



2 Display the “Create folder” screen.

- While pressing the <SELECT> button, turn the <DIAL> dial to select “Create folder.” Then let go of the <SELECT> button.
- ▶ The “Create folder” screen will appear.

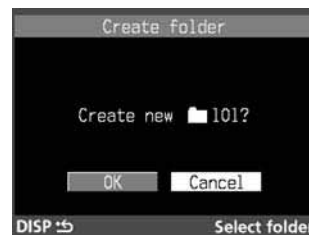

- If there are nine or more folders listed on the screen, you might not be able to see the “Create folder” command on the LCD monitor. In such a case, hold down the button and turn the dial until “Create folder” appears.
- When RAW+JPEG is set and both RAW and JPEG images are recorded simultaneously, they will be counted as only one image in the folder.



3 Create a new folder.

- While pressing the <SELECT> button, turn the <DIAL> dial to select "OK." Then let go of the <SELECT> button.
- ▶ A new folder will be created.
- To exit the folder mode and turn off the LCD monitor, press the <DISPLAY> button.



A folder cannot be created beyond number 999.

Selecting a Folder

You can select the folder where subsequent images are to be stored. You can also select any folder to erase all the images it contains. (→p.123)

1 Set the folder mode.

- Follow step 1 in "Creating a Folder with the Camera" on the previous page.



2 Select a folder.

- While pressing the <SELECT> button, turn the <DIAL> dial to select a folder. Then let go of the <SELECT> button.
- ▶ The folder will be selected.
- To exit the folder mode and turn off the LCD monitor, press the <DISPLAY> button.



How the file number changes when a folder is selected: (→p.56)

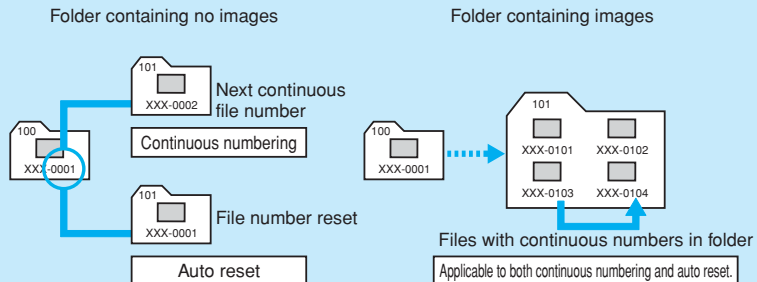

MENU File Numbering Methods

The pictures you take are automatically assigned a file number from 0001 to 9999. The images are saved in the folder you selected. Auto reset and continuous numbering are two automatic file numbering methods that you can use. The initial setting is continuous numbering.



1 On the menu, select “File numbering.”

- Press the <MENU> button.
- While pressing the <MENU> button, turn the <DISP> dial to select <fT>.
- While pressing the <SELECT> button, turn the <DISP> dial to select “File numbering.” Then let go of the <SELECT> button.



2 Select the desired numbering method.

- While pressing the <SELECT> button, turn the <DISP> dial to select the desired numbering method. Then go of the <SELECT> button.
- ▶ The menu will reappear.
- To exit the menu and turn off the LCD monitor, press the <MENU> button.

Auto Reset

This resets the file numbering to **XXX-0001** whenever you use a new folder to store images you capture or whenever you replace the CF card with a new one. Thus, the images in each folder will start from file number **0001**. For example, you can create a folder for each day of shooting and see how many images you shot each day. Note that if you change to a folder or CF card which already contains images, the file number of subsequent images will start after the last file number that the folder or CF card already contains.

File numbering after changing the folder

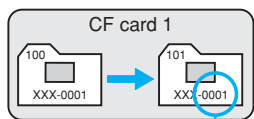

File number reset

File numbering after changing the CF card

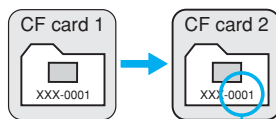

File number reset



If the last file number in the folder reaches **9999**, the message on the right will appear on the LCD monitor and you will not be able to take any more pictures even if the CF card still has room. To continue taking pictures, hold down the <SELECT> button and turn the <DISP> dial to select "OK." A new folder will then be created and you can continue taking pictures which will be stored in the new folder. To avoid this disruption in picture-taking, create a new folder and select it from the start (→p.54) or do a manual reset of the file numbering (→p.58) and select another folder to store subsequent images.

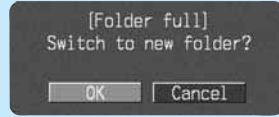

Continuous Numbering

This method enables the file numbering to continue in numeric sequence even after you change the folder for storing subsequent images or after you replace the CF card. This prevents any images from having the same file number. Therefore you can manage the images with a personal computer without confusion.

Note that if you start to store subsequent images into a another folder or CF card which already contains images captured with the camera, the file numbering will start after the highest file number in that folder or CF card.

File numbering after changing the folder

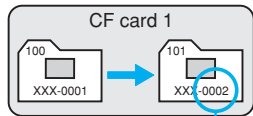

Next sequential file number

File numbering after changing the CF card

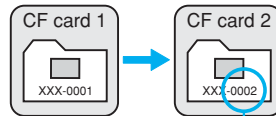

Next sequential file number



If the last file number in the folder reaches **9999**, the message on the right will appear on the LCD monitor and you will not be able to take any more pictures even if the CF card still has room. To continue taking pictures, hold down the <SELECT> button and turn the <DISP> dial to select "OK." A new folder will then be created and you can continue taking pictures. The continuous file numbering will start from **0001**, and the subsequent images will be stored in the new folder. To avoid this disruption in picture-taking, do a manual reset of the file numbering (→p.58) beforehand or use auto reset and select another folder to store the images.

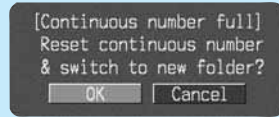

Manual Reset

This creates a new folder and starts the file numbering from XXX-0001. Subsequent images you capture are stored in this new folder. File numbering method (auto reset / continuous numbering) is the one you set before manual reset.



- The file numbers are like the frame numbers on a roll of film.
- For details on file names, see “Basic Terminology.” (→p.155)

Creating a Folder with a Personal Computer

You can also use a personal computer to create a new folder to store images.

With the CF card open on the screen, create a new folder named “Dcim.”

Open the Dcim folder and create new folders within it. Create as many folders as necessary to organize your images. Name the folders with a name like 100ABC_D where the first three numbers range from 100 to 999 followed immediately by five letters. The five letters can be a combination of upper or lower case letters from A to Z and an underbar. There can be no space.



- The camera will not recognize folder names such as “100ABC” (insufficient letters) or “001ABC_F” (the number must be 100 to 999). Also, folder names cannot have the same three-digit number such as “100ABC_C” and “100ABC_D” even if the letters are different.
- It is recommended that you start numbering folders from “100.” If the last file number inside the folder reaches 9999, create a new folder with the camera to store subsequent images. If you create only one folder in the CF card and number it 999, you will not be able to take more pictures after reaching file number 9999 in that folder.

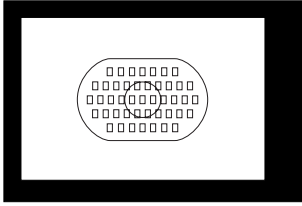

Using Autofocus (AF)

The Area AF ellipse has 45 AF points. By selecting the optimum AF point, autofocusing can be executed while you maintain the desired subject framing. You can also set the AF mode to suit the subject or intended effect.



First set the <AF> switch and <AF> switch to <ON>.

Selecting AF Mode

AF stands for 'autofocus'. The camera has two AF modes: One-Shot AF for still subjects, and AI Servo AF for moving subjects. (AI is an abbreviation for Artificial Intelligence.) Select the AF mode that suits the subject.

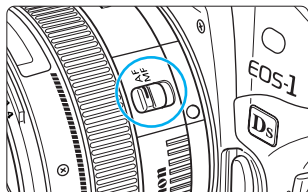

- 1 Set the lens focus mode switch to <AF>.

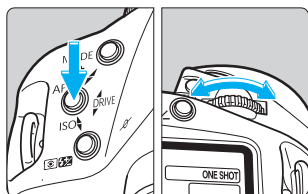

- 2 Set the AF mode.

- While pressing the camera's <AF> button, turn the <AF> dial until the desired AF mode is displayed on the LCD panel. Then release the <AF> button.

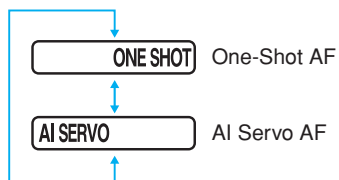
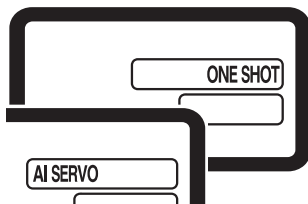

One-Shot AF for Still Subjects

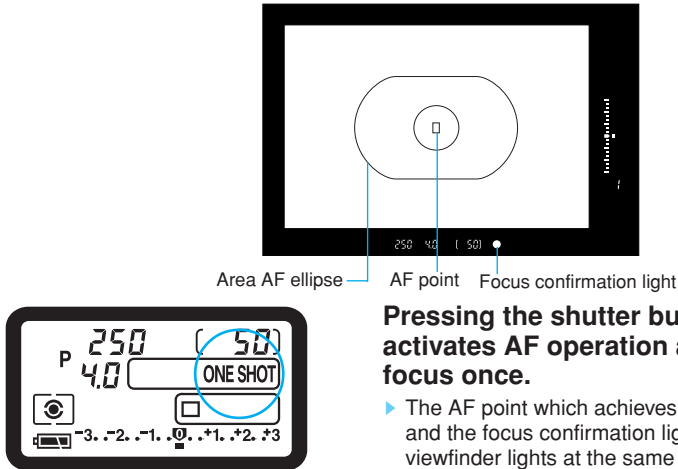

Pressing the shutter button halfway activates AF operation and achieves focus once.

- ▶ The AF point which achieves focus flashes briefly and the focus confirmation light <●> in the viewfinder lights at the same time.
- With evaluative metering, the exposure setting (shutter speed and aperture) will be set when focus is achieved. The exposure setting and focus will be locked as long as the shutter button is pressed halfway. You can then recompose the shot while retaining the exposure setting and point of focus.

3

Using Autofocus (AF)

Focusing an Off-Center Subject

To focus a subject not covered by the Area AF ellipse, follow the procedure below. This technique is called focus lock.

- Focus lock works only in the One-Shot AF mode.

- 1** Aim the Area AF or AF point over the subject and press the shutter button halfway to focus.
- 2** Keep pressing the shutter button halfway and recompose the picture as desired.
- 3** Take the picture.



- When the <AF-ON> switch is set to <AF-ON>, the beeper will sound when focus is achieved.
- If focus cannot be achieved, the focus confirmation light <●> in the viewfinder will blink. If this occurs, a picture cannot be taken even if the shutter button is pressed fully. Reframe the shot and focus again. Also see “When Autofocus Fails (Manual Focusing)” on page 73.

AI Servo AF for Moving Subjects

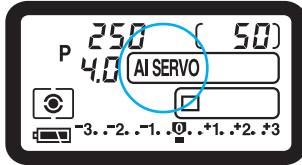

While you press the shutter button halfway, the camera focuses continuously.

- This AF mode suits moving subjects when the focusing distance keeps changing.
- With predictive AF*, the camera can also focus track a subject which steadily approaches or retreats from the camera.
- The exposure settings are set immediately before the picture is taken.



- When focus is achieved in the AI Servo AF mode, the viewfinder's focus confirmation light does not light and the beeper does not sound.
- If the viewfinder's focus confirmation light blinks, focus has not been achieved.
- The focus cannot be locked (except when Custom Function C.Fn-04 is set to 2.)

* About Predictive AF

If the subject approaches or retreats from the camera at a constant rate, the camera tracks the subject and predicts the focusing distance immediately before the picture is taken. This is for obtaining correct focus at the moment of exposure.

With a manually selected AF point, the AF point will flash in red and focus track the subject.

When the AF point selection is automatic, the camera first uses the center AF point to focus. If the subject later moves away from the center AF point, focus tracking continues as long as the subject is covered by another AF point in the Area AF ellipse. The active AF point does not light.

C.Fn

- You can also change the AI Servo AF's subject tracking sensitivity with C.Fn-20. (→p.138)
- With Custom Function C.Fn-04-2, you can lock the focus momentarily by pressing the <⌘> button even while the AI Servo AF is active. (→p.133)
- Custom Function C.Fn-11-2 enables you turn the <⊙> dial to change the AF point to track the subject in the AI Servo AF mode. (→p.136)

Area AF Ellipse and AF Points

The Area AF ellipse is the area where the camera can focus the subject. The Area AF ellipse has 45 AF points, making autofocus possible over a wide area in the viewfinder. You can concentrate on composing the picture without worrying about whether an AF point is covering the subject. As long as the subject is within the Area AF ellipse, the camera will focus the subject automatically.

AF points in the Area AF ellipse

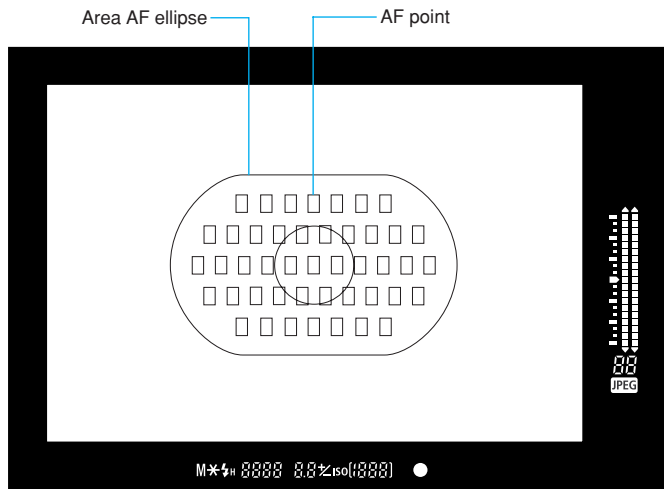

Everything is displayed above. Normally, only part of the above is displayed.

Selecting AF Point

The AF point can be selected automatically or manually.

- **Automatic Selection**

From among the 45 AF points, the camera selects the AF point automatically to suit the subject.

- **Manual Selection** (One of three groups of selectable AF points can be used)

(1) You can select one of the 45 AF points manually.



(2) You can select one of eleven AF points (C.Fn-13-1/2)

(3) You can select one of nine AF points (C.Fn-13-3)

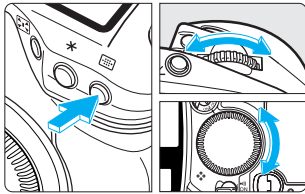

* C.Fn-13 enables (2) and (3) (→p.136). To set a Custom Function, see "Setting a Custom Function" on page 132.

Basic Procedure for AF Point Selection







- To select an AF point, press the > button, then turn the > or > dial.

Selecting a horizontal AF point

- Press the > button and turn the > dial.
- ▶ The selected AF point will shift horizontally.

Selecting a vertical AF point

- Press the > button and turn the > dial.
- To select a vertical AF point, you can also press the > button, then hold down the > button and turn the > dial.
- ▶ The selected AF point will shift vertically.
- The camera will be ready for picture-taking when the shutter button is pressed halfway or when (⓪6) elapses.

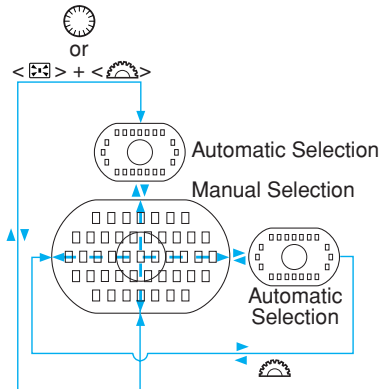

Automatic Selection

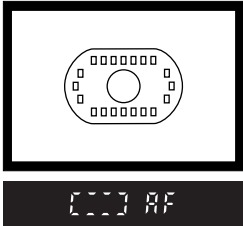

Press the button and turn the dial.

- ▶ Turn the dial until the viewfinder display is as shown on the left. You can also turn the dial instead.
- While in the manual selection mode, shifting the AF point beyond the peripheral AF point will set the automatic selection mode. The automatic selection mode can also be set while C.Fn-13-1/2/3 has been set.

Manual Selection

(1) Manual selection of 45 AF points

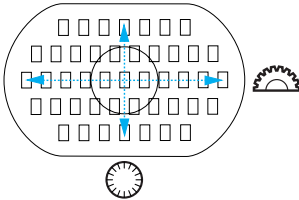

- Select the AF point as described in “Basic Procedure for AF Point Selection.”
- When selecting a vertical AF point, the selection will alternate between one (□) and double AF points (□□).

Center AF point selected.

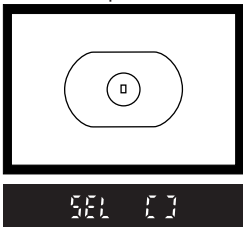

Off-center AF point selected.

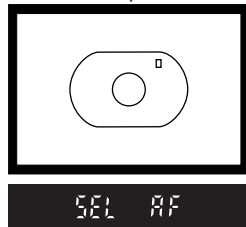

Double AF points selected.

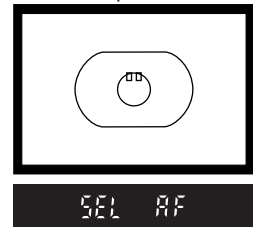

If double AF points are selected, both AF points will be used for shooting. If you then select the left or right AF point turning dial, only one AF point will be active.

(2) Manual selection limited to 11 AF points

C.Fn-13-1, 2 (→p.136)

Since the selectable AF points are limited to 11, you can better concentrate on framing the subject. Although you select the AF point in the same way as with the 45 AF points, having fewer selectable AF points makes it faster to select an AF point.

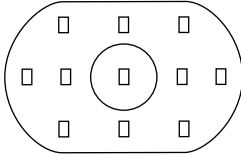

- You can select one of 11 AF points.
- Select the AF point as described in “Basic Procedure for AF Point Selection.”

C.Fn C.Fn-13-1 enables spot metering linked to the selected AF point. (→p.77, 136)

(3) Manual selection limited to 9 AF points

C.Fn-13-3 (→p.136)

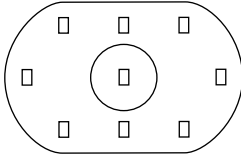

The center AF point and 8 peripheral AF points are selectable. Turning the Quick Control Dial  makes it very fast to select one of the 8 peripheral AF points.

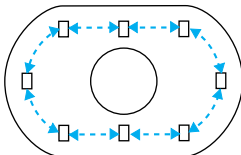

- You can select one of 9 AF points.
- Select a horizontal AF point as described in “Basic Procedure for AF Point Selection.”
While in the manual selection mode, shifting the AF point beyond the peripheral AF point will set the automatic selection mode.





Selecting a peripheral AF point

- Press the  button and turn the  dial. Turn the  to quickly select a peripheral AF point.

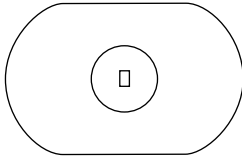
C.Fn A peripheral AF point can also be selected with the  dial alone. (C.Fn-11-2→p.136)



Selecting the center AF point

- Press the  button and press the  button.
- ▶ The center AF point will be selected.









When you select spot metering, it will be linked to the selected AF point. (→p.77)

C.Fn

With C.Fn-18, you can select the center AF point by pressing or during holding down the  button. (→p.138)

C.Fn

The manual selection method can be altered as follows: (→p.136)

- (1) C.Fn-11-1 gives the  button the function of the  button.
- (2) C.Fn-11-2 gives the  button the function of the  button. The  dial can also be used by itself.
- (3) C.Fn-11-2 can switch manual AF point selection to automatic selection.
- (4) C.Fn-11-3 gives the  button the function of the  button.

Registrating and Switching AF Point

By registering the AF point you often use, you can switch to it instantly. You can register an off-center AF point which suits your preferred framing or automatic selection for the picture-taking moment priority. Any of the 45 AF points can be registered. Only one AF point can be registered.

Registrating an AF Point

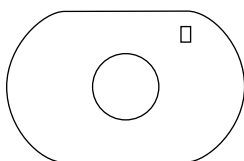

- 1 Press the button which remains active for (0.6). Then turn the or dial to select the AF point to be registered.

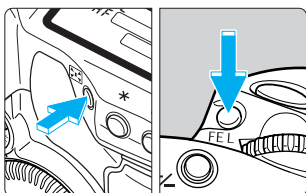

- 2 While pressing the button, press the button.

- ▶ This registers the selected AF point.
- When the AF point is registered, the LCD panel display will differ depending on the selected AF point. The same display will also appear when the registered AF point is selected.

Automatic selection

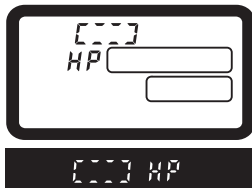

Off-center AF point



Center AF point





When using a Speedlite and spot metering, first press the button. If you press the button first, the AF point selection will be canceled.





- An AF point can be registered even when C.Fn-13-1/2 has been set to limit the selectable AF points to 11. (→p.66)
- When C.Fn-13-3 has been used to limit the selectable AF points to 9, an AF point cannot be registered. (→p.66)
- “SEL” stands for Select, and “HP” stands for “Home Position.”

Switching to the Registered AF Point

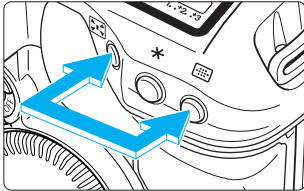
Normally, you press the  button and  button simultaneously to switch to the registered AF point. However, with C.Fn-18-1/2 (→p.138), you can just press the  button to switch to the registered AF point. See “Setting a Custom Function” on page 132.



- Press the  button and  button simultaneously.**

- This is the default method with C.Fn-18-0.

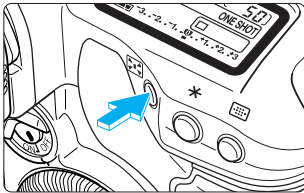

- Press only the  button to switch to the registered AF point.**

C.Fn-18-1 (→138)

- Switch to the registered AF point only while pressing the  button.**

C.Fn-18-2 (→138)

- When the  button is released, it will return to the original AF point.



- If no AF point has been registered, the above steps will switch it to the center AF point.
- If you set or cancel C.Fn-13, the center AF point will become the registered AF point. This does not apply if you change C.Fn-13-1 to C.Fn-13-2 (or vice versa). The registered AF point will not change in this case.



If C.Fn-18-1/2 and C.Fn-04-1/3 have been set, you can press only the  button to switch to the registered AF point and start autofocusing at the same time.

AF Point Activation Area C.Fn-17

C.Fn-17 can be set to expand the AF point's activation area to include more than one active AF point. (→p.137) See “Setting a Custom Function” on page 132.

• C.Fn-17-1 Expanding the activation area to 7 points

C.Fn-17-1 (→p.137)

This larger activation area makes it easier to focus subjects moving irregularly.

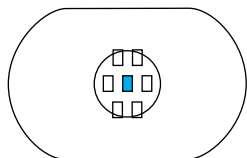

- : Selected AF point.
- : AF points in expanded activation area.

- The expanded AF point activation area is not displayed in the viewfinder.
- When focus is achieved in the One-Shot AF mode, the selected AF point and the AF point(s) achieving focus will light.

• C.Fn-17-2 Expanding the activation area to 7 or 13 points automatically

C.Fn-17-2 (→p.137)

As shown below, the AF point activation area expands automatically to 7 or 13 points depending on the lens focal length, AF mode, and the subject's speed in the AI Servo AF mode. This is effective when the subject's movement is unpredictable.

AF Mode	Lens Focal Length	
	Shorter than 300mm	300mm or Longer
One-Shot AF	<p>The activation area does not expand automatically.</p>	<p>The activation area expands by one point.</p>
AI Servo AF	<p>For a slow-moving subject For a fast-moving subject</p>	<p>For a slow-moving subject For a fast-moving subject</p>

* To set the Custom Function, see “Setting a Custom Function” on page 132.

AF Sensitivity and the Lens' Maximum Aperture



The EOS-1Ds's AF points are all horizontal-line sensitive. However, bright lenses with a large maximum aperture enable certain AF points to work as cross-type sensors for higher AF precision.

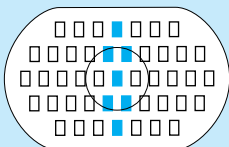

(1) With lenses whose maximum aperture is $f/2.8$ or faster (lower f /number), the AF points highlighted in the illustration will be cross-type sensors sensitive to both vertical and horizontal lines. The remaining 38 AF points will only be horizontal-line sensitive. The cross-type sensor's vertical-line sensitivity is three times higher than the horizontal-line sensitivity.

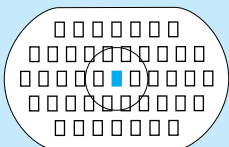

(2) With the following L-series lenses whose maximum aperture is brighter than $f/4$ by lens only or with Extenders, the center AF point will be a cross-type sensor for high-precision AF. The remaining 44 focusing points will only be horizontal-line sensitive (except with EF 70-200mm $f/2.8$ L USM + Extender EF 1.4x).

- EF 28-80mm $f/2.8$ -4L USM
- EF 300mm $f/4$ L USM
- EF 300mm $f/4$ L IS USM
- EF 400mm $f/4$ DO IS USM
- EF 500mm $f/4$ L IS USM
- EF 600mm $f/4$ L USM
- EF 600mm $f/4$ L IS USM
- EF 70-200mm $f/4$ L USM

- With Extender EF 1.4x or EF 1.4x II:
 - EF 200mm $f/2.8$ L USM
 - EF 200mm $f/2.8$ L II USM
 - EF 300mm $f/2.8$ L USM
 - EF 300mm $f/2.8$ L IS USM
 - EF 400mm $f/2.8$ L USM
 - EF 400mm $f/2.8$ L II USM
 - EF 400mm $f/2.8$ L IS USM
 - EF 70-200mm $f/2.8$ L IS USM

- With Extender EF 2x or EF 2x II:
 - EF 135mm $f/2$ L USM
 - EF 200mm $f/1.8$ L USM

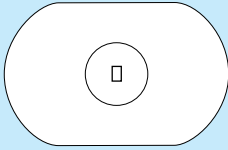

(3) With the following Extenders and L-series lenses whose maximum aperture is faster than $f/8$, the center AF point will be horizontal-line sensitive only. The other AF points cannot be used for AF.

- With Extender EF 1.4x or EF 1.4x II:
EF 400mm $f/5.6L$ USM
EF 500mm $f/4.5L$ USM
EF 100-400mm $f/4.5-5.6L$ IS USM
- With Extender EF 2x or EF 2x II:
EF 300mm $f/4 L$ USM
EF 300mm $f/4L$ IS USM
EF 400mm $f/4 DO$ IS USM
EF 500mm $f/4L$ IS USM
EF 600mm $f/4L$ USM
EF 600mm $f/4L$ IS USM
EF 70-200mm $f/4L$ IS USM
- When the  button is pressed, the display shown on the right will appear on the top LCD panel.

- 0 -
AF



The EF 70-200mm $f/2.8L$ USM lens (without IS) used together with Extender EF 1.4x or EF 1.4x II will enable the center AF point to work as a cross-type sensor. However, do not autofocus with the other AF points because they may cause a focusing error.

When Autofocus Fails (Manual Focusing)

Autofocus can fail to achieve focus (the focus confirmation light blinks) with certain subjects such as the following:

- (a) Low-contrast subjects (blue sky, solid-color walls, etc.).
- (b) Subjects in low light.
- (c) Extremely backlit reflective subjects (car with a reflective body, etc.).
- (d) Overlapping near and far objects (animal in a cage, etc.).

In such cases, do one of the following:

1. Focus an object at the same distance as the subject and lock the focus before recomposing.
2. Set the lens focus mode switch to <MF> (or <M> on older lenses) and focus manually.
(→p.26)



If focus cannot be achieved with the AF-assist light of a Speedlite or ST-E2, select the center AF point. An off-center AF point might not be able to achieve focus.

Manual Focusing

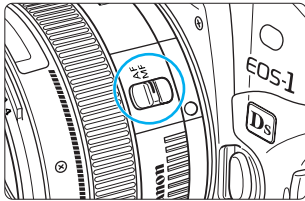

1 Set the lens focus mode switch to **<MF>** (or **<M>** on older lenses).

- The AF mode indicator on the LCD panel turns off.

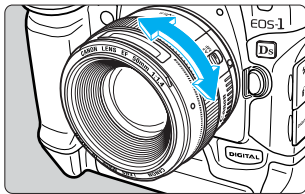

2 Focus by turning the lens focusing ring until the subject is in focus in the viewfinder.



- Select the desired AF point and press the shutter button halfway while manual focusing. When focus is achieved, the selected AF point will flash and the focus confirmation light will light.
- When the AF point is selected automatically and the center AF point achieves focus, it will flash and the focus confirmation light will light.
- With USM (Ultrasonic Motor) lenses (except those not having a distance scale), you can use the focusing ring to fine focus after focus is achieved in the One-Shot AF mode (full-time manual focusing).

C.Fn For USM lenses with an electronic focusing ring (such as the EF 200mm f/1.8L USM), Custom Function C.Fn-07 can require the lens focus mode switch to be set to **<MF>** (or **<M>**) before manual focus is enabled. (→p.134)

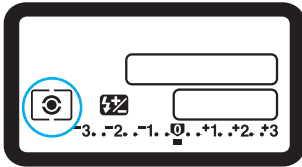

- Evaluative metering
- Partial metering
- Spot metering
- Centerweighted average metering

4

Metering Modes



Evaluative, partial, spot, and centerweighted average metering modes are provided. Center spot metering, AF point-linked spot metering, and multi-spot metering can also be set. Select the metering mode that suits the subject or your photographic intention.



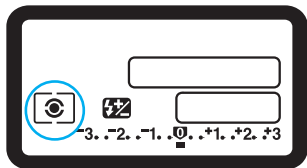
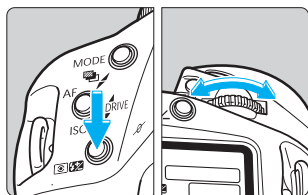

First set the switch to <ON>.

Selecting a Metering Mode

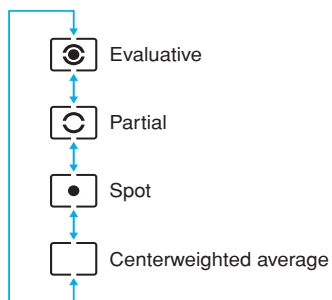

- 1 While pressing the  button, turn the  dial until the desired metering mode icon appears.



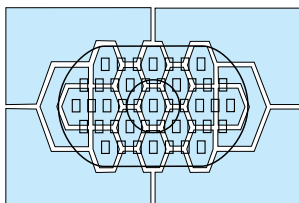

- 2 Release the  button.

Metering Modes



Evaluative Metering

This is an all-around metering mode suited even for backlit subjects. The viewfinder is divided into 21 metering zones to which any AF point can be linked for evaluative metering. After detecting the main subject's size, position, brightness, background, front and back lighting, etc., the camera sets the proper exposure.

- During manual focusing, evaluative metering is based on the center AF point.
- If the subject brightness and background light level are very different (there is a strong backlight or spotlight), use partial metering () or spot metering () instead.

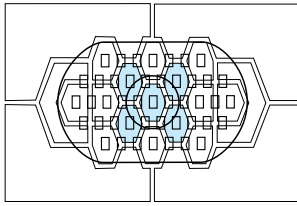

Partial Metering

This mode is effective when the background is much brighter than the subject (due to backlighting, etc.). The metering is weighted at the center covering 8.5% of the viewfinder area.

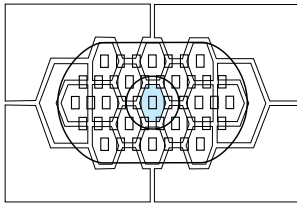

Spot Metering

This is for metering a particular part of the subject or scene. The metering is weighted at the center covering 2.4% of the viewfinder area.

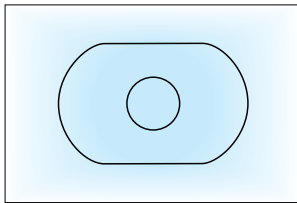

Centerweighted Average Metering

The metering is weighted at the center and then averaged for the entire scene.

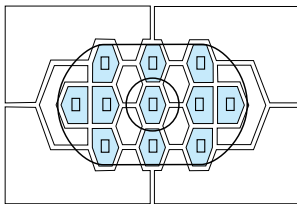

AF Point-Linked Spot Metering

To make AF point selection faster, the selectable AF points can be limited to 11 (C.Fn-13-1) or 9 (C.Fn-13-3). When C.Fn-13-1 or C.Fn-13-3 has been set, the manually-selected AF point is linked to 2.4% spot metering. (→p.66, 136)



During continuous shooting in the spot metering mode, AE lock is set automatically without the < * > indicator displayed in the viewfinder.



C.Fn-13-2 can limit the manually-selectable AF points to only 11 while keeping the spot metering linked to the center AF point. (→p.66, 136)

Multi-Spot Metering

With multiple spot meter readings, you can see the relative exposure levels of multiple areas in the picture and set the exposure to obtain the desired result.

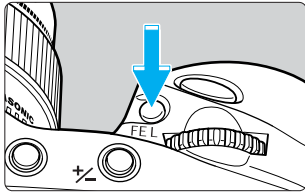

1 Set the metering mode to spot metering. (→p.76)

2 Aim the AF point over the midtone area (the ceiling ①) and press the <FEL> button.

▶ This obtains the first spot meter reading.

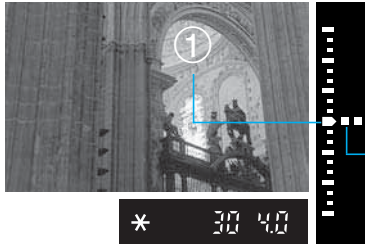

Exposure level of the first spot meter reading

The moving exposure level indicator indicates the current exposure level relative to the first spot meter reading taken at ①.

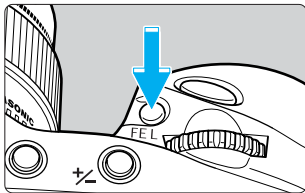

3 Next, aim the AF point over a highlight area (the window ②) and press the <FEL> button. Do the same for the shadow area (the wall ③).

▶ After the three spot meter readings are taken, the averaged exposure setting and the relative exposure levels of the three readings are displayed in the viewfinder.

Exposure level indicator before the second spot meter reading

Current exposure level at ② relative to ①.

Exposure level indicator after the second spot meter reading

Exposure level indicator before the third spot meter reading

Current exposure level at ③ relative to ① and ②.

Exposure level of the third spot meter reading

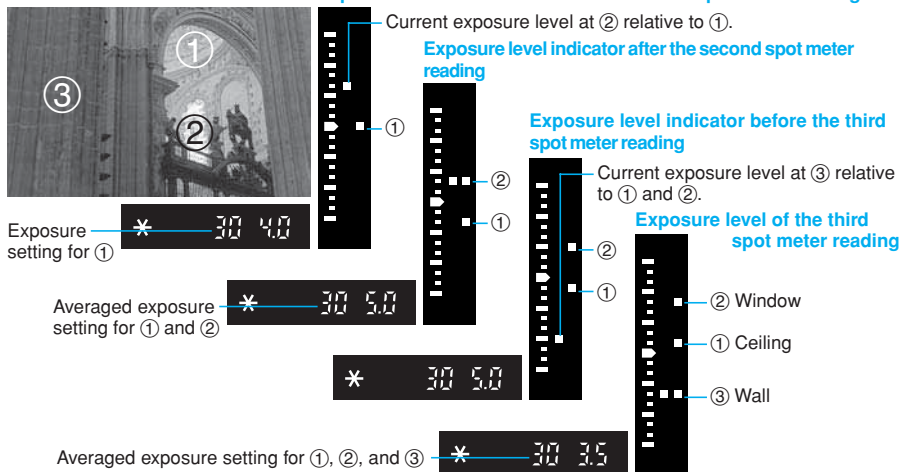

Exposure level indicator after taking three spot meter readings

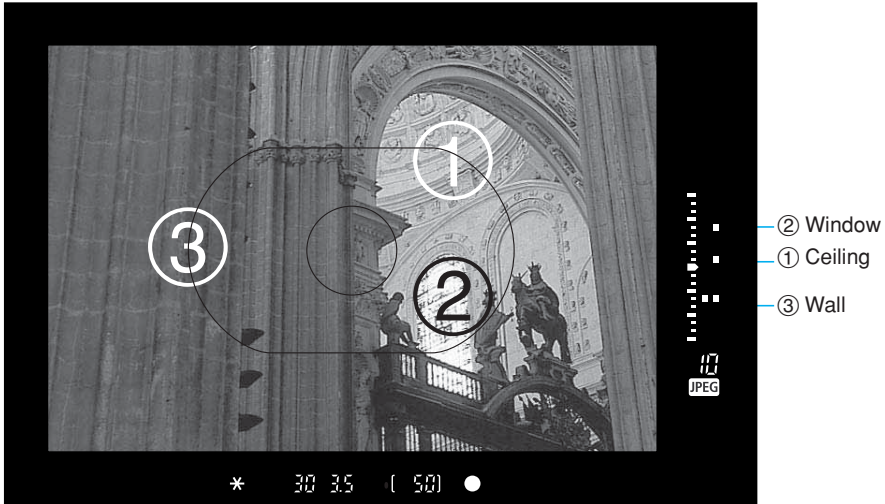

- While referring to the exposure level indicator's three spot metering marks, you can set exposure compensation to obtain the desired result.

4

Metering Modes



You can take up to eight spot meter readings for one picture. If you press the <FEL> button to try and take a ninth spot meter reading, no spot meter reading will register.



- The exposure setting obtained with multi-spot meter readings will be canceled in the following cases:
 1. After taking the last spot meter reading, 16 seconds elapse.
 2. You press the <[RECALL]>, <MODE>, or <AF> button.
 3. After taking the picture, you let go of the shutter button.
- Multi-spot metering can be fixed at the center or linked to the active AF point.

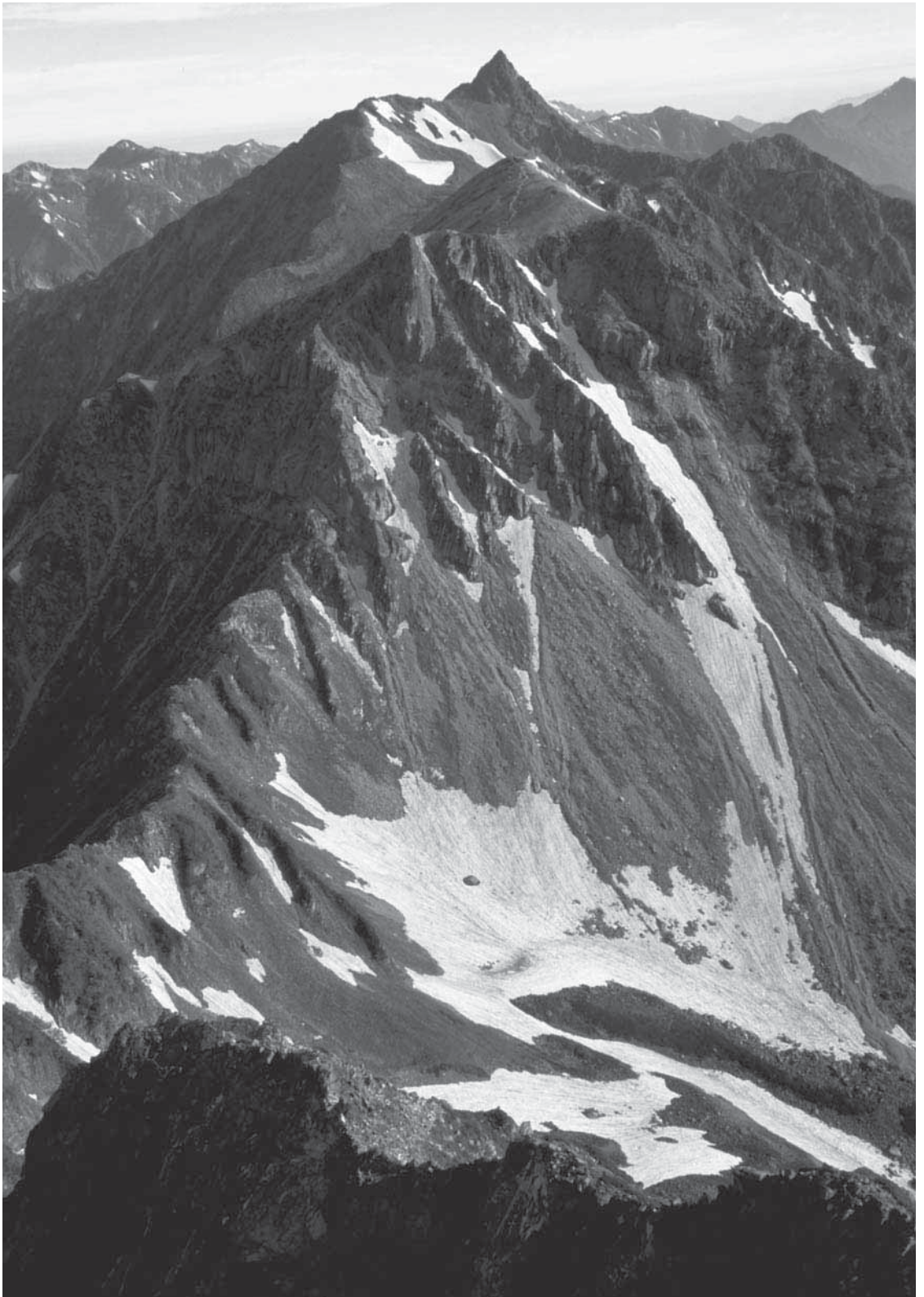

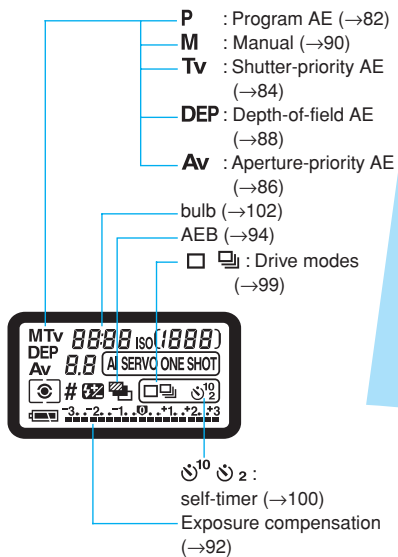

Exposure Control

You can set the shooting mode which best suits the subject or situation. Other convenient features are also provided.



First set the switch to <ON>. If necessary, also set the switch to <ON>.

P Program AE

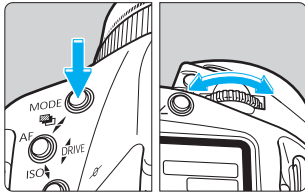

1 Select <P> on the LCD panel.

- While pressing the <MODE> button, turn the <MODE> dial to select <P>. Then release the <MODE> button.

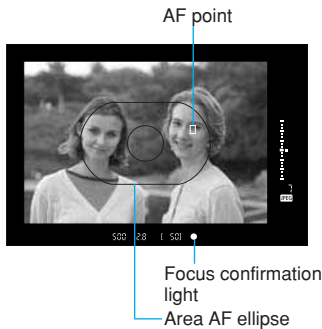
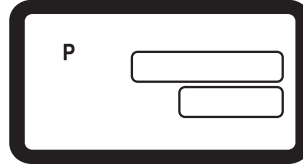

2 Focus the subject.

- Look through the viewfinder and aim the Area AF ellipse over the subject. Then press the shutter button halfway.
 - ▶ The AF point which achieves focus flashes briefly. At the same time, the green focus confirmation light <●> in the viewfinder is displayed.
 - ▶ The exposure setting will be displayed on the LCD panel and in the viewfinder.
- If the focus confirmation light <●> in the viewfinder blinks, the shutter will lock and a picture cannot be taken. See “When Autofocus Fails (Manual Focusing)” on page 73.

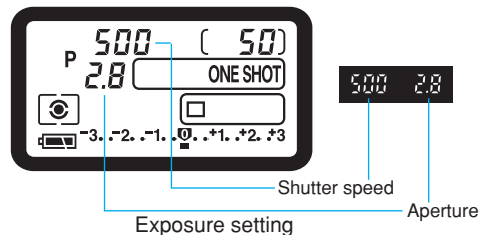

3 Make sure the exposure setting is not blinking, then press the shutter button fully to take the picture.



AE is an abbreviation for Auto Exposure.



The Program AE mode is set automatically as the camera's initial shooting mode. (→p.34)

Exposure Warnings

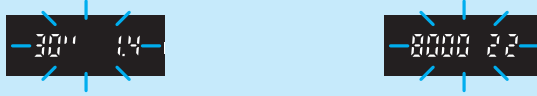

If the shutter speed or aperture blinks, it means a correct exposure cannot be obtained. Although the picture can be taken, it may come out too bright or too dark. For details, see “Exposure Warning List” on page 157.



- The AF point which achieves focus flashes briefly. If the AF point has been selected manually (→p.65), it will light dimly while it is active for (♫6).
- If automatic AF point selection (→p.65) has been set, all the AF points that achieve focus will light.

Shifting the Program

In the Program AE <P> mode, you can freely change the shutter speed and aperture combination (program) set by the camera while retaining the same exposure value. This is called shifting the program.

To shift the program, press the shutter button halfway and turn the <☀> dial until the desired shutter speed or aperture is displayed.

Tv Shutter-Priority AE

In this mode, you set the desired shutter speed and the camera sets the aperture automatically to suit the subject brightness.

A fast shutter speed can freeze motion, and a slow shutter speed can blur it.

* **Tv** is an abbreviation for Time value.

With a fast shutter speed



With a slow shutter speed

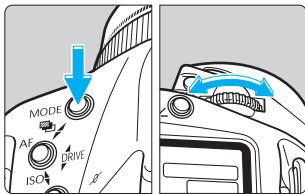

- 1 While pressing the **<MODE>** button, turn the **<mode dial>** until **<Tv>** appears on the LCD panel. Then release the **<MODE>** button.

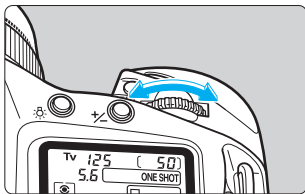
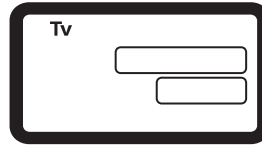

- 2 Turn the **<mode dial>** to set the desired shutter speed.

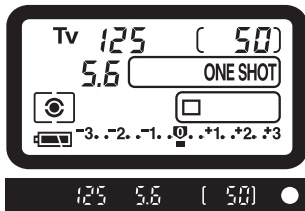

- 3 Press the shutter button halfway and focus the subject.
 - ▶ The shutter speed and aperture will be displayed.

- 4 Take the picture.
 - As long as the aperture display is not blinking, a standard exposure will be obtained.

Exposure Warnings

- If the lens' maximum aperture (lowest f/number like f/1.4) blinks, it indicates underexposure. Turn the  dial to set a slower shutter speed until the aperture display stops blinking.



- If the lens' minimum aperture (highest f/number like f/22) blinks, it indicates overexposure. Turn the  dial to set a faster shutter speed until the aperture display stops blinking.



C.Fn

- C.Fn-16 enables the safety shift feature. (→p.137)
In the shutter-priority AE mode, if a correct exposure cannot be obtained with any aperture set by the camera, the camera automatically sets a faster or slower shutter speed. This feature is called safety shift.
- C.Fn-06 enables the shutter speed to be set in full-stop or 1/2-stop increments instead of the standard 1/3-stop increments. (→p.134)

Av Aperture-Priority AE

In this mode, you set the desired aperture and the camera sets the shutter speed automatically to suit the subject brightness.

The larger or brighter the aperture (lower f/number) the more blurred the background will become. This effect is ideal for portraits. The smaller or darker the aperture (higher f/number), the clearer the focus will be for both near and far objects (wider depth of field).

* **Av** is an abbreviation for Aperture value.

With a large aperture



With a small aperture

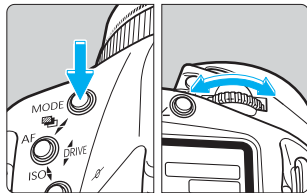
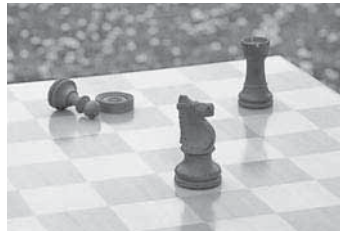

- 1 While pressing the **<MODE>** button, turn the **<aperture dial>** until **<Av>** appears on the LCD panel. Then release the **<MODE>** button.

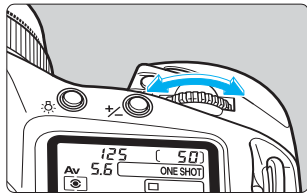

- 2 Turn the **<aperture dial>** to set the desired aperture.

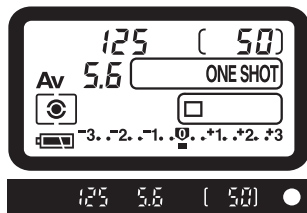

- 3 Press the shutter button halfway and focus the subject.

▶ The shutter speed and aperture will be displayed.

- 4 Take the picture.

- As long as the shutter speed is not blinking, a standard exposure will be obtained.
- If the shutter speed is slower than the reciprocal of the lens focal length (i.e. 1/200 for a 200mm lens), camera shake may cause a blurred picture.

Exposure Warnings

- If the 30" shutter speed blinks, it indicates underexposure. Turn the dial to set a larger aperture (lower f/number) until the shutter speed stops blinking.



- If the 8000 shutter speed blinks, it indicates overexposure. Turn the dial to set a smaller aperture (higher f/number) until the shutter speed stops blinking.



C.Fn

- C.Fn-16 enables the safety shift feature. (→p.137)
If a correct exposure cannot be obtained in the aperture-priority AE mode with any shutter speed set by the camera, the camera automatically sets a larger or smaller aperture. This feature is called safety shift.
- C.Fn-06 enables the aperture to be set in full-stop or 1/2-stop increments instead of the standard 1/3-stop increments. (→p.134)
- For aperture-priority AE, C.Fn-05-2/3 enables the aperture to be set with the camera even while the lens is detached. (→p.134)

5

Depth-of-field Preview

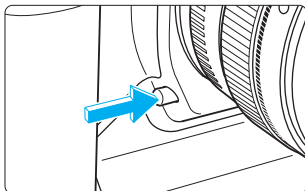

The depth of field is the range of acceptable focus in front of and behind the point of focus. (→p.156) The depth of field changes depending on the aperture. Press the depth-of-field preview button to stop down the aperture and see the range of acceptable focus in the viewfinder.



- Pressing the depth-of-field preview button also sets AE lock.
- The depth-of-field preview button does not function during AF operation.

DEP Depth-of-field AE

This mode is effective when you want a wide depth of field to keep everything in focus near and far.

* **DEP** stands for “depth of field.”

- This mode will not work if the lens focus mode switch is set to <MF> (or <M>). First set the lens focus mode switch to <AF>.

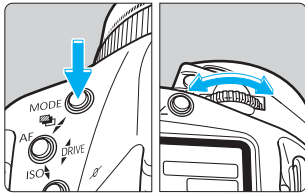

1 Select <DEP> on the top LCD panel.

- While pressing the <MODE> button, turn the <MODE> dial to select <DEP>. Then let go of the <MODE> button.

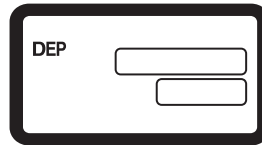

2 Specify the first subject you want in focus.

- Focus the first desired subject. (⊙6)
- ▶ The focus confirmation light <●> and “dEP 1” is displayed.



3 Specify the second subject you want in focus.

- Focus the second desired subject. (⊙6)
- ▶ The focus confirmation light <●> and “dEP 2” is displayed.

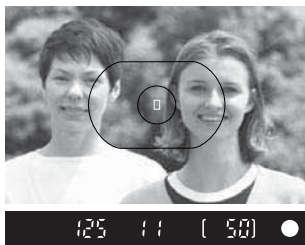

4 Compose the picture, press the shutter button halfway and check the exposure setting, then take the picture.

- ▶ The point of focus and aperture required to achieve the desired depth of field between the two dEP points are set automatically. The shutter speed is also set automatically to suit the brightness.
- Before taking the picture, check that the shutter speed or aperture display is not blinking.

Exposure Warnings

- If the aperture blinks, the desired depth of field cannot be obtained. (However, you can still take the picture and obtain a proper exposure.) Use a wide-angle lens or move away from the subject and repeat steps 2 to 4.
- If both the shutter speed and aperture blink, you can still take the picture, but the picture will be too dark or too bright. For details, see the “Exposure Warnings” table (→p.157).
- If the 30” shutter speed and the lens’ maximum aperture (lowest f/ number) blink, underexposure will result and depth-of-field AE will not work.
- If the 8000 shutter speed and the lens’ minimum aperture (highest f/ number) blink, overexposure will result. Use a neutral density (ND) filter to reduce the amount of light entering the camera.

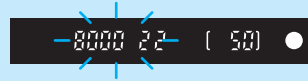

- When using a zoom lens, do not change the zoom focal length while using the depth-of-field AE mode.
- After setting one or two dEP points, do not select a different AF point. Otherwise, the dEP point(s) that you already set will be canceled and you will have to start over with the newly selected AF point.
- Using flash with the depth-of-field AE mode will obtain the same result as using Program AE with flash.
- If depth-of-field AE is used with a lens having a focusing limiting switch (like the EF 300mm f/2.8L IS USM lens), set the switch to the maximum focusing distance range.



- With automatic AF point selection in the depth-of-field AE mode, only the center AF point will be used for focusing.
- If a slow shutter speed has been set, use a tripod to prevent camera shake.
- If (⌚) elapse before you complete the DEP procedure, the dEP point(s) set so far will be canceled. In such a case, you must start over again.
- To cancel the depth-of-field AE mode midway, press the <MODE> button, <AF> button, or <Ⓜ/Ⓜ> button.



- To further increase the depth of field, use a wide-angle lens.
- Setting dEP points 1 and 2 at the same point on the subject will make the depth of field shallow. The foreground and background will then be blurred, making the subject stand out. Using a telephoto lens enhances this effect.

M Manual Exposure

In this mode, you set both the shutter speed and aperture for total exposure control. You can refer to the exposure level indicator in the viewfinder or use a handheld exposure meter to determine the shutter speed and aperture.

Using the Built-in Exposure Meter

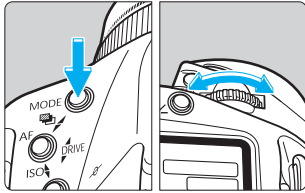

- 1 While pressing the **<MODE>** button, turn the **<☀>** dial until **<M>** appears on the LCD panel. Then release the **<MODE>** button.

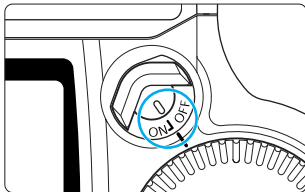
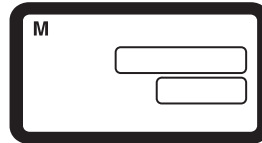

- 2 Set the **<☺>** switch to **<ON>**.

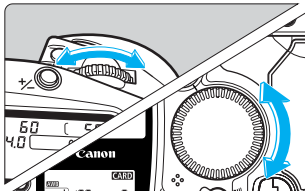

- 3 Turn the **<☀>** dial to set the shutter speed and turn the **<☀>** dial to set the aperture.
 - To set the aperture, you can also press the **<⚡>** button and turn the **<☀>** dial.

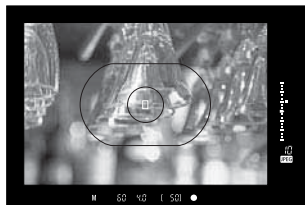

- 4 **Focus the subject.**
 - ▶ The shutter speed and aperture will be displayed.
 - On the right of the viewfinder, the exposure level indicator **<□>** indicates the current exposure level relative to the standard exposure index.

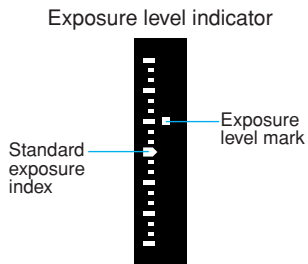

5 Refer to the exposure level indicator and set the shutter speed and aperture to obtain the desired exposure level.

6 Take the picture.

5

Exposure Control

- C.Fn**
- C.Fn-05 can reverse the functions of the dial and dial. (→p.134)
 - C.Fn-06 can set the shutter speed and/or aperture increments to full stops or half stops instead of the standard 1/3 stops. (→p.134)
 - C.Fn-05-2/3 enables the aperture to be set manually even when the lens has been detached. (→p.134)

+/- Setting Exposure Compensation

The exposure compensation amount you set will be effective until it is canceled manually. To cancel the exposure compensation amount, turn the to set the exposure compensation amount to 0, according to procedure 3 on this page.

Exposure compensation is used to alter the camera's standard exposure setting. To set the exposure compensation amount, you can either turn the dial while looking through the viewfinder or press the button and turn the dial while looking at the LCD panel. The exposure compensation amount can be set up to +/-3 stops in 1/3-stop increments.

Exposure Compensation with the Dial

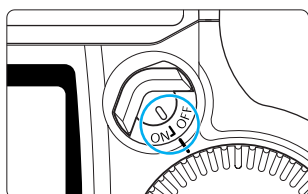

1 Set the switch to <ON>.

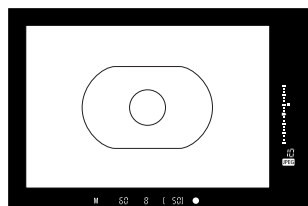

2 Focus the subject and check the exposure level.

Exposure level indicator

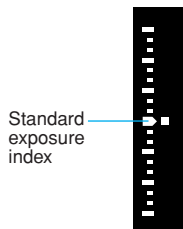

Standard exposure index

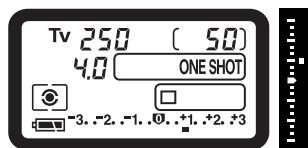

Increased exposure

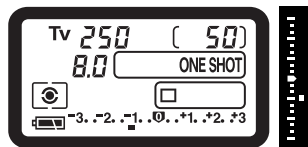

Decreased exposure

3 Turn the dial to set the desired exposure compensation amount.

- ▶ The exposure compensation icon and the exposure level indicator will be displayed in the viewfinder, while the exposure level indicator will be displayed on the LCD panel.
- Turn the dial while pressing the shutter button halfway or within (Ⓔ6) after releasing the shutter button.
- On the viewfinder's exposure level scale, any position above the standard exposure index indicates increased exposure and any position below it indicates decreased exposure. On the LCD panel, any position on the + side indicates increased exposure and any position on the - side indicates decreased exposure.
- To cancel exposure compensation, set the amount to the standard exposure index (or .

4 Take the picture.

C.Fn Custom Function C.Fn-06-2 enables the exposure compensation amount to be set in 1/2-stop increments. (→p.134)



The exposure compensation amount's 1/2-stop increments enabled with C.Fn-06 are indicated in the viewfinder and on the LCD panel as shown below.

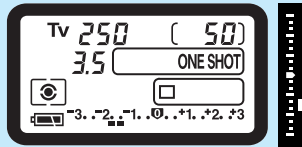

-1 1/2 exposure compensation

Exposure Compensation with the <+/-> Button and <Sun> Dial

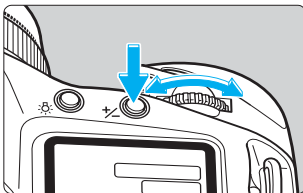

Press the <+/-> button and turn <Sun> dial within (⊖6) to set the desired exposure compensation amount.

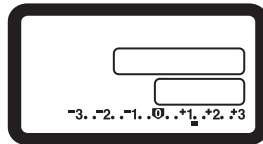

5

Exposure Control



- The exposure compensation amount will remain in effect even after the <OFF> switch is set to <OFF>.
- To prevent the <Sun> dial from turning inadvertently and changing the exposure compensation amount, set the <OFF> switch to <OFF>.

Auto Exposure Bracketing

With auto exposure bracketing, the camera brackets the exposure automatically up to ± 3 stops in 1/3-stop increments for three successive frames. You can bracket the exposures by changing the shutter speed or aperture. Or you can use a fixed shutter speed and aperture and change the ISO speed.



Standard exposure (0)



Decreased exposure ($-1/3$ stop)



Increased exposure ($+1/3$ stop)

AEB with the Shutter Speed or Aperture

In the **<P>** mode, AEB is executed by changing both the shutter speed and aperture.

In the **<Tv>** mode, AEB is executed by changing the aperture.

In the **<Av>**, **<M>**, or **<DEP>** mode, AEB is executed by changing the shutter speed.

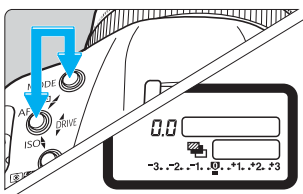

1 Press the **<MODE>** button and **<AF>** button simultaneously.

- ▶ The  icon appears on the top LCD panel.

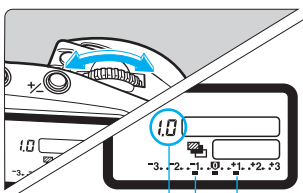

2 Turn the **<AEB>** dial to set the desired AEB amount.

- ▶ On the top LCD panel, the AEB amount is indicated in stops and the AEB range **<AEB>** is also displayed. The illustration on the left shows an AEB amount of ± 1 stop centering on the standard exposure level.
- ▶ After setting the AEB amount, let go of the **<MODE>** button and **<AF>** button.
- ▶ The AEB range will be displayed on the top LCD panel.

AEB amount AEB range

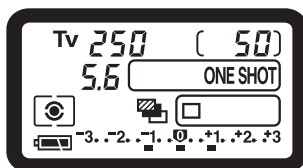

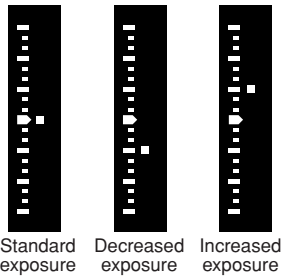

3 Take the pictures.

- ▶ The AEB sequence will be standard exposure, decreased exposure, and increased exposure.
- ▶ The viewfinder's exposure level indicator will indicate the respective bracketing amount as each shot is taken.
- ▶ The current drive mode will be used. (→p.99)
- In the continuous shooting mode, holding down the shutter button will take all three bracketed shots continuously. The shooting will then stop automatically.
- When AEB is used with the self-timer, the three bracketed shots will be taken in succession after the 2- or 10-second self-timer delay.

AEB with the ISO Speed

In any shooting mode (<P>, <Av>, <Tv>, <M>, etc.), you can use a fixed shutter speed and aperture and change the ISO speed automatically for AEB.

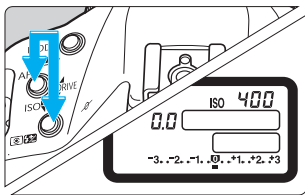

1 Press the <AF> button and <AEB> button simultaneously.

- ▶ The ISO speed can now be set.
- Set the ISO speed that is to be the standard AEB exposure. (→p.49) For example, if you want AEB with ISO 200, 400, and 800, set the ISO speed to 400.

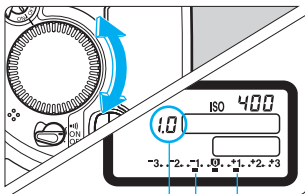

2 Turn the <AEB> dial to set the desired AEB amount.

- ▶ On the top LCD panel, the AEB amount will be indicated in stops and the AEB range <AEB> will be displayed.

The illustration on the left shows an AEB amount of +/-1 stop centering on the standard exposure level.

- After setting the AEB amount, let go of the <AF> button and <AEB> button.
- ▶ The AEB range will be displayed on the top LCD panel.

AEB amount AEB range

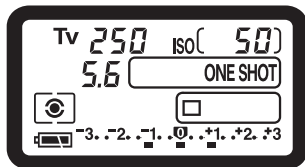

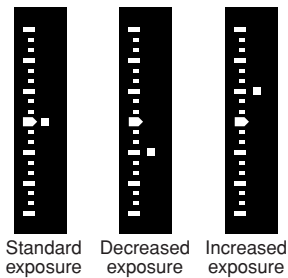

3 Take the pictures.

- ▶ The AEB sequence will be standard exposure, decreased exposure, and increased exposure.
- ▶ The viewfinder's exposure level indicator will indicate the respective bracketing amount as each shot is taken.
- In the continuous shooting mode, holding down the shutter button will take all three bracketed shots continuously. The shooting will then stop automatically.
- When AEB is used with the self-timer, the three bracketed shots will be taken in succession after the 2- or 10-second self-timer delay.



- The following shooting modes cannot be set together: white balance bracketing, flash photography, bulb exposures, and AEB with a changing shutter speed, aperture, or ISO speed.
- If C.Fn-12-1 is set for mirror lockup and AEB is set, only one bracketed shot will be taken at a time even in the continuous shooting mode.
- The AEB range possible by changing the shutter speed is 30 sec. to 1/8000 sec. By changing the aperture, the AEB range ranges from the lens' maximum aperture (lowest f/number) to the lens' minimum aperture (highest f/number).
- The AEB range possible by changing the ISO speed is ISO 100 to 1250. If you set the AEB outside of this range, you can still take the picture, but the AEB amount will not go beyond the ISO 100-1250 range.
- If you use C.Fn-06-2 to set the exposure setting to 1/2-stop increments, you will not be able to set AEB with the ISO speed.



- If you set the drive mode to single-frame shooting, press the shutter button once for each AEB shot.
- After setting the AEB amount, you can also set exposure compensation to obtain decreased exposed or increased exposed bracketing. If the combined AEB amount and exposure compensation amount exceeds the display limits of the exposure level scale, it will look like as shown below. However, the AEB shots will still be taken according to the AEB and exposure compensation amounts you set.

-3. -2. -1. 0. +1. +2. +3

- During AEB shooting with a changing shutter speed or aperture, the <AEB> icon on the top LCD panel and the <AEB> indicator in the viewfinder will blink to indicate that AEB shooting is in effect.
- During AEB shooting with a changing ISO speed, the <ISO> icon on the top LCD panel and the <ISO> <AEB> indicators in the viewfinder will blink to indicate that AEB shooting is in effect.

- C.Fn
 - C.Fn-06-2 enables the AEB amount to be set in 1/2-stop increments with the shutter speed or aperture. (→p.134)
Also, C.Fn-05-1 enables a manual exposure to be set with a fixed shutter speed and varying aperture. (→p.134)
 - C.Fn-09-2/3 changes the bracketing sequence to decreased exposure, standard exposure, and increased exposure. (→p.135)
 - C.Fn-01-1 enables the viewfinder information to be displayed during continuous shooting of the bracketed shots. (→p.133)

Canceling AEB

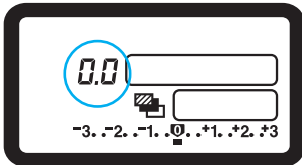

Canceling shutter speed AEB or aperture AEB

- While pressing the <MODE> and <AF> buttons, turn the <AEB> dial to set the AEB amount to “0.0”. Then let go of the <MODE> and <AF> buttons. This will cancel AEB.

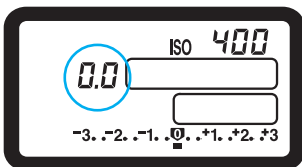

Canceling ISO speed AEB

- While pressing the <AF> and <ISO> buttons, turn the <AEB> dial to set the AEB amount to “0.0”. Then let go of the <AF> and <ISO> buttons. This will cancel AEB.
- After canceling ISO speed AEB, set the ISO speed as necessary. (→p.49)



AEB will also be canceled if you change lenses, replace the CF card, replace the battery, set a bulb exposure, have a flash-ready Speedlite, press the <CLEAR> button, or set the <AEB> switch to <OFF>.

- C.Fn
 - C.Fn C.Fn-9-1/3 prevents AEB from being canceled when you change lenses, replace the CF card, replace the battery, set a bulb exposure, have the flash ready to fire, press the <CLEAR> button, or set the <AEB> switch to <OFF>. (→p.135)

* AE Lock

AE lock enables you to lock the exposure at a different place from the point of focus. After locking the exposure, you can recompose the shot while maintaining the desired exposure level. This feature is useful for backlit and spotlighted subjects.



1 Focus at the point where you want to lock the exposure reading.

- ▶ The exposure setting (shutter speed and aperture) will be displayed on the LCD panel and in the viewfinder.

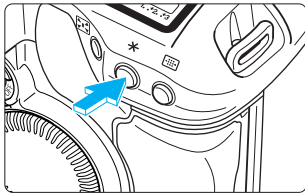

2 Press the <*> button (Ⓢ6).

- ▶ <*> lights in the viewfinder to indicate that the exposure setting is locked.
- Each time you press the <*> button, it locks the current exposure setting.
- AE lock cancels 6 seconds after <*> lights in the viewfinder or if you press the <AF> button, <Ⓢ6> button, or <MODE> button.



AE lock indicator

3 Recompose the shot and take the picture.

- When the shot is recomposed, the exposure level indicator will show the new exposure level in real-time relative to the locked exposure level.

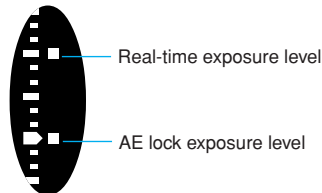

If One-Shot AF and evaluative metering are set, pressing the shutter button halfway to focus will automatically set AE lock at the same time.



Partial or spot metering is recommended for AE lock over a specific point. (→p.76)

C.Fn

C.Fn-04-1 enables AE lock with the shutter button pressed halfway (instead of the <*> button) and focusing with the <*> button. (→p.133)

Drive Mode Selection

Three drive modes are provided:

- Single-frame: Only one shot is taken.
- 📷 Continuous: Continuous shots are taken while you press the shutter button fully. The maximum number of continuous shots in a single burst depends on the image recording quality. See the table below.
- ⌚ Self-timer: The self-timer starts when you press the shutter button fully. The picture is taken 10 sec. or 2 sec. later. (→p.100)

Image Recording Quality		Max. Continuous Burst (Approx.)	📷 Continuous (Approx.)
L (Large)	▲ (Fine)	10 shots	3 fps
	■ (Normal)		
S (Small)	▲ (Fine)		
RAW (Raw)			
RAW + L	▲ (Fine)		
	■ (Normal)		
RAW + S		▲ (Fine)	

- The continuous shooting speeds and maximum shots per burst in the above table are based on Canon's testing standards (1/250 sec. or faster shutter speed, at ISO 100).
- The maximum shots per burst depends on the subject, shooting mode, and ISO speed.

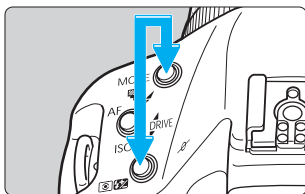

1 Press the <MODE> button and <📷📷> button simultaneously.

- ▶ The drive mode will be displayed.

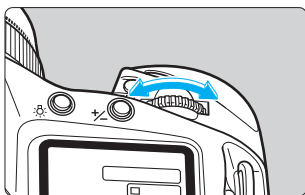

2 While pressing the two buttons, turn the <📷> dial.

- Select the desired drive mode, then let go of the buttons.

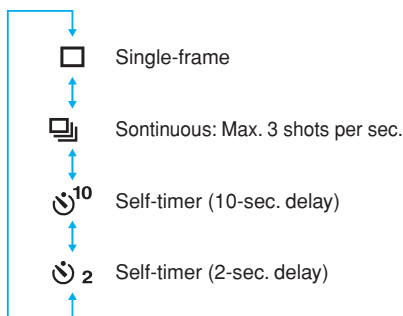
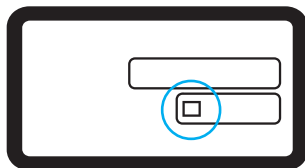







- When you take a picture, the image is first stored in the camera's internal memory and then transferred to the CF card. When the internal memory becomes full during continuous shooting, the camera cannot continue to take more pictures until the images are transferred to the CF card and the internal memory gain some space. During continuous shooting, check the maximum burst count displayed in the viewfinder on the lower right corner. This is the number of continuous shots that you can take before the camera must stop to transfer the images to the CF card. This number is displayed even when a CF card is not in the camera. Make sure that a CF card is loaded before taking a picture.
- When "FULL CF" is displayed in the viewfinder and on the top LCD panel, replace the CF card after the access lamp stops blinking.

C.Fn C.Fn-01 enables the viewfinder information to be displayed during continuous shooting. (→p.133)

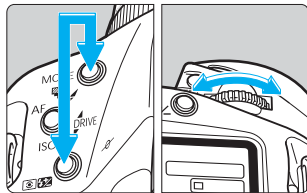

Self-timer Operation

The self-timer can be set to either a 2-second or 10-second delay. When using the self-timer, you should mount the camera on a tripod.



- 1 While pressing the <MODE> button and < < > button, turn the < > dial and set the desired self-timer delay time.**



 ¹⁰ : 10-second delay
 ² : 2-second delay

- 2 Look through the viewfinder and press the shutter button halfway to focus.**

- Check that the focus confirmation light <●> and exposure setting are displayed.

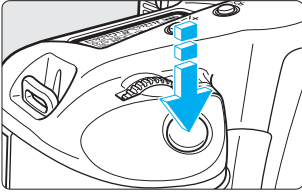

3 Press the shutter button fully.

- The self-timer lamp will start blinking to indicate that the self-timer has started. The lamp blinks faster during the last two seconds before the picture is taken.
- To cancel the self-timer after it starts, set the  switch to <OFF>.



Do not stand in front of the camera when you press the shutter button to start the self-timer. Doing so will throw off the focus.



When using the self-timer to photograph yourself only, first lock the focus (→p.61) on an object at about the same distance where you will be.



The 2-second delay is effective for close-ups or photo duplicating work to prevent camera shake (camera movement while the shutter button is pressed).

Using the Eyepiece Shutter

If you take a picture without looking through the viewfinder, stray light may enter the eyepiece and affect the exposure. To prevent this, use the built-in eyepiece shutter before taking the picture.

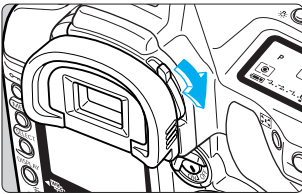

To cover the eyepiece with the eyepiece shutter, turn the lever as shown by the arrow.

To open the eyepiece shutter, turn the lever in the opposite direction.

Bulb Exposures

When bulb is set, the shutter is open during the time you keep pressing the shutter button completely. Bulb is useful when a long exposure is necessary for capturing night scenes, fireworks, the night sky, etc.

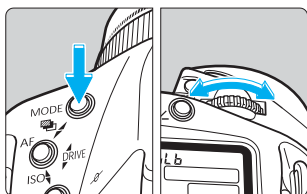

- 1 While pressing the <MODE> button, turn the <bulb> dial until “bulb” is displayed. Then release the <MODE> button.

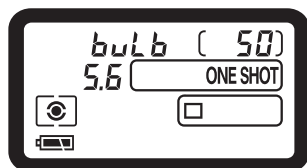
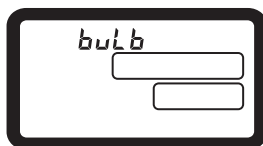

- 2 Set the <ON/OFF> switch to <ON>, then turn the <aperture> (or <shutter speed>) dial to set the desired aperture.

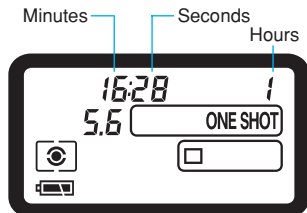

- 3 Start the bulb exposure.
 - ▶ The elapsed exposure time will be displayed on the LCD panel.
 - The bulb exposure will continue while you keep pressing the shutter button fully.



If the exposure is 1 sec. or longer, the resulting image may look somewhat grainy or rough due to picture noise.





- Bulb exposures may result in rough-looking images due to picture noise. However, picture noise can be reduced with menu (noise reduction for bulb exposures). (→p.129)
- With a fully charged battery, a single bulb exposure can last as long as about 2.5 hours.

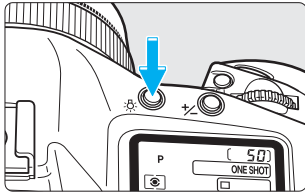

By connecting Remote Switch RS-80N3 or Timer Remote Controller TC-80N3 (both optional) to the camera's remote control terminal, you need not keep pressing the shutter button with your finger during bulb exposures.

LCD Panel Illumination



The top and rear LCD panels are provided with illumination so you can read the panels in the dark. The  button turns the illumination of both panels on or off. The illumination stays on for 6 sec. If you take a picture while the panel is illuminated, the illumination will turn off 2 seconds after the picture is taken. If you take a bulb exposure while the panel is illuminated, the illumination will turn off immediately.



Pressing any button while the LCD panel is illuminated prolongs the illumination.

Mirror Lockup

Mirror lockup is enabled with C.Fn-12. (→p.136) This prevents mirror-caused vibrations which may blur the image during close-ups or when a super telephoto lens is used. To set this Custom Function, see “Setting a Custom Function” on page 132. When mirror lockup is set, the camera operates as follows.

- When using mirror lockup, Remote Switch RS-80N3 (optional) is recommended. (→p.167)

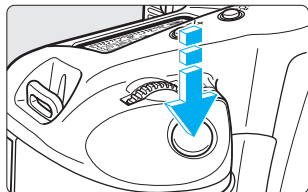

1 Press the shutter button fully and release it.

- ▶ The mirror locks up, and after 30 seconds, it will go back down automatically. Pressing the shutter button fully again locks up the mirror again.

2 Press the shutter button fully again to take the picture.

- ▶ The picture is taken and then the mirror goes back down.



- In very bright light such as at the beach or ski ground on a sunny day, take the picture promptly after mirror lockup.
- During mirror lockup, do not point the camera lens at the sun. The sun's heat can scorch and damage the shutter curtains.
- If you use mirror lockup with the self-timer for a bulb exposure, there will be a shutter release sound when you release the shutter button during self-timer operation. This is not the sound of the shutter release.



- During mirror lockup, the drive mode will be set to single-frame shooting (□) to override the current drive mode (single or continuous).
- If mirror lockup is used with the self-timer, pressing the shutter button fully the first time will lock up the mirror and release the shutter 10 seconds or 2 seconds later (depending on the delay time selected).

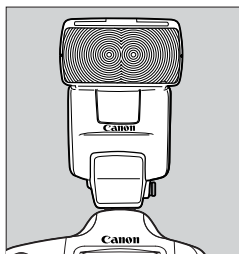



6

Flash Photography

An EOS-dedicated, EX-series Speedlite makes flash photography as easy as any AE mode. EX-series Speedlites enable E-TTL autoflash photography as well as E-TTL wireless autoflash photography with multiple Speedlites.

Speedlite 550EX will be used to explain the flash photography features possible with the EOS-1Ds. For details on Speedlite 550EX, see the instructions booklet that came with it.



First set the  switch to <ON>. If necessary, also set the  switch to <ON>.

Flash Photography with Speedlite 550EX

With Speedlite 550EX, flash photography is easy as any AE mode, and you can use the following features:

- **E-TTL autoflash**

With E-TTL autoflash (preflash evaluative metering), optimum flash exposure is obtained for the subject in focus. In the aperture-priority AE mode, a slow sync speed is set automatically in low-light situations to obtain a natural-looking, balanced exposure between the subject and background.



- **High-Speed Sync (FP Flash)**

High-speed sync (FP or focal-plane flash) enables flash synchronization with all shutter speeds from 30 sec. to 1/8000 sec.

- **FE (Flash Exposure) Lock**

FE lock obtains and locks the correct flash exposure for any part of the subject. This is the flash equivalent of AE lock.

- **Flash exposure compensation**

Like normal exposure compensation, flash exposure compensation can be used to set the flash output up to ± 3 stops in 1/3-stop increments.

- **FEB (Flash Exposure Bracketing)**

As with AEB (autoexposure bracketing), flash exposures can be bracketed up to ± 3 stops in 1/3-stop increments.

- **E-TTL wireless autoflash with multiple Speedlites**

E-TTL autoflash can also be implemented with multiple wireless Speedlites. All the features listed above can be used, and no connections codes are required. Sophisticated lighting effects can be obtained as easily as using a Speedlite directly attached to the camera.



- E-TTL is an abbreviation for Evaluative-Through-The-Lens.
- With autofocus, the flash exposure is always based on the aperture (set automatically or manually) and autoflash metering is weighted at the current AF point.
- When it is difficult to autofocus, the 550EX's built-in AF-assist beam is emitted automatically. The beam is linked to the active AF point in the Area AF.

E-TTL Autoflash

Using E-TTL autoflash in the <P> Program AE mode is described below. For details on using Speedlite 550EX, see the instructions booklet that came with it.

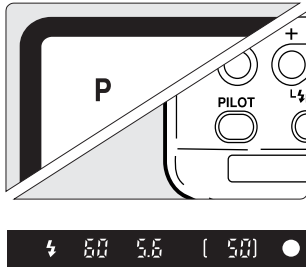

- 1 Set the camera's shooting mode to <P>.
- 2 Check that the 550EX's pilot lamp is lit.
- 3 Focus the subject.
- 4 Take the picture.
 - Make sure the flash-ready indicator <⚡> is on, and check the shutter speed and aperture before taking the picture.

E-TTL Autoflash in Other Shooting Modes

Even in the <Tv>, <Av>, and <M> modes, E-TTL autoflash is as easy as normal picture-taking without flash.



- (1) When you press the shutter button halfway, the shutter speed and aperture are set by the camera as with normal picture-taking without flash.

Mode	Shutter Speed Setting	Flash Aperture Setting
Tv (Shutter-priority AE)	Manual (30 sec. - 1/250 sec.)	Auto
Av (Aperture-priority AE)	Auto (30 sec. - 1/250 sec.)	Manual
M (Manual)	Manual (30 sec. - 1/250 sec.)	Manual

* Since using the <Av> mode in low light will result in a slow shutter speed, use a tripod to prevent camera shake.

- (2) When you press the shutter button fully, preflash evaluative metering based on the aperture set in (1) is used for the E-TTL autoflash exposure.
- (3) The background exposure is set by the shutter speed and aperture combination.

High-Speed Sync (FP Flash)

When the Speedlite 550EX is set to the high-speed sync mode () , it can synchronize at all shutter speeds, even those faster than 1/250 sec. When high-speed sync is enabled,  is displayed in the viewfinder to indicate high-speed sync.

High-speed sync is effective in the following cases:

- (1) **When you want to use daylight sync for a portrait and maintain background blur with a large aperture.**
- (2) **When you want to produce a catchlight in the subject's eyes.**
- (3) **When you want to use daylight sync to eliminate shadows**

FEB (Flash Exposure Bracketing)

With the Canon Speedlite 550EX, three successive flash shots can be bracketed automatically up to +/-3 stops in 1/3-stop increments. The flash output is changed for the three shots while the background exposure remains the same.



Standard exposure (0). Decreased exposure (-2/3 stop). Increased exposure (+2/3 stop).

- Flash exposure bracketing is set with the 550EX. For details, see the 550EX's Instructions booklet.
- The flash exposure bracketing amount set with the 550EX is indicated by the flash exposure level indicator in the camera's viewfinder.
- Make sure the Speedlite 550EX is ready before taking the next bracketed shot. Single-frame shooting () is recommended.

C.Fn C.Fn-06-2 enables the flash exposure bracketing amount to be set in 1/2-stop increments. (→p.134)

FEL FE Lock

FE (flash exposure) lock obtains and locks the correct flash exposure reading for any part of the scene.

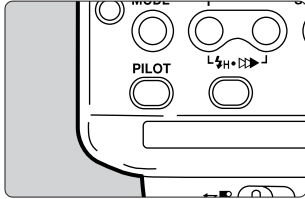

1 Check that the Speedlite's pilot lamp is lit.

- The flash mode can be either normal or high-speed sync. FE lock works with either mode.

2 Focus the subject.

- Focus at the point where you want to lock the flash exposure.

Spot metering circle

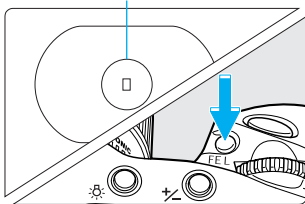

3 Aim the spot metering circle over the part where you want to lock the flash exposure, then press the <FEL> button (16).

- ▶ The Speedlite fires a preflash and stores the required flash output in memory.
- ▶ In the viewfinder, the AF point achieving FE lock flashes in red.
- ▶ Below the viewfinder, the display shown by ① appears for 0.5 sec. followed by the display shown by ②.

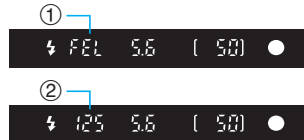

4 Compose the shot and take the picture.



If the subject is too far away, resulting in underexposure, the <f> icon will blink. In such a case, increase the ISO speed or get closer to the subject and repeat steps 3 and 4.

C.Fn C.Fn-13-1/3 enables FE lock with the manually-selected AF point. (→p.136)

Flash Exposure Compensation

With the camera, you can set the EOS-dedicated Speedlite's flash exposure compensation amount up to +/-3 stops in 1/3-stop increments.

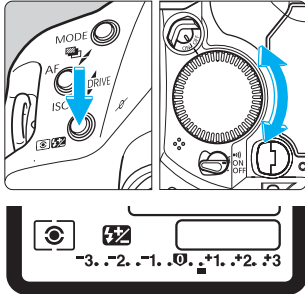

1 While pressing the $\langle \text{Fn} \rangle$ button, turn the $\langle \text{Q} \rangle$ dial to set the desired flash exposure compensation amount.

- On the LCD panel, the plus side of the scale indicates increased exposure and the minus side indicates decreased exposure. The sample display shows +2/3 stop flash exposure compensation.

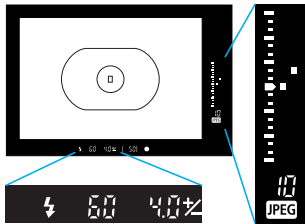

2 Take the picture.

- Press the shutter button halfway to display the flash exposure compensation amount on the viewfinder's exposure level scale.
- Press the $\langle \text{Fn} \rangle$ button to display the flash exposure compensation amount on the LCD panel.
- To cancel flash exposure compensation, set the flash exposure compensation amount to $\langle 0 \rangle$.



- The flash exposure compensation amount will be retained even after the $\langle \text{Fn} \rangle$ switch is set to $\langle \text{OFF} \rangle$.
- You can also set flash exposure compensation with certain EOS-dedicated Speedlites. If you set flash exposure compensation with both the Speedlite and camera, the flash exposure compensation set with the Speedlite will override the one set with the camera.

C.Fn C.Fn-06-2 enables the flash exposure compensation amount to be set in 1/2-stop increments. (→p.134)

Modeling Flash

By firing a modeling flash, you can see the shadows and other flash lighting effects produced by one or more Speedlites.

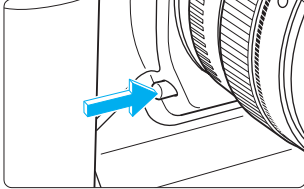

1 Make sure the camera and Speedlite are properly set for flash photography.

2 Press the camera's depth-of-field preview button.

▶ The Speedlite 550EX fires at 70 Hz for 1 second.

Wireless, Multi-Speedlite System

Speedlite 550EX has the following three features:

- (1) **E-TTL autoflash**
- (2) **Slave unit feature**
- (3) **Master unit feature for wireless control of 550EX slave units**

By using the above features, you can set up a wireless E-TTL autoflash system with multiple Speedlite 550EXs.

You can also set a flash output ratio for up to three Speedlites grouped as main and sub Speedlites to create the desired flash lighting effect.

- For details, see the 550EX and ST-E2's Instructions booklet.

Metered Manual Flash Photography

With manual flash exposures, you can set the correct flash exposure by referring to the flash exposure level indicator in the viewfinder. This is useful for close-up flash photography. You will need a standard 18% gray card and an E-TTL autoflash Speedlite (such as the MR-14EX) capable of manual flash exposures.

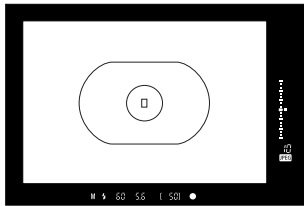

Spot metering circle

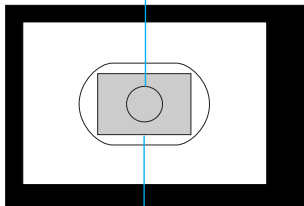

Standard gray card

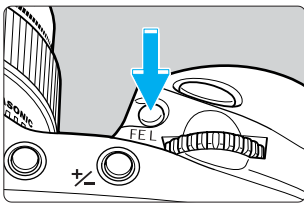

- 1 Set the camera and Speedlite settings.**
 - Set the shooting mode to **<M>** or **<Av>** and select the center AF point.
 - Set the Speedlite for manual flash exposures.

- 2 Focus the subject.**
 - Focus manually.

- 3 Position the gray card.**
 - Place the gray card at the same distance as the subject.
 - The gray card should be at a distance where the entire spot metering circle can cover the gray card.

- 4 Aim the camera so that the entire spot metering circle covers the gray card, then press the **<FEL>** button (which remains in effect for 16 sec.).**
 - ▶ The Speedlite will fire a preflash and the required flash output is retained in memory.
 - ▶ In the viewfinder, the exposure level indicator will indicate the currently-set flash exposure level relative to the standard exposure index.

Standard exposure index

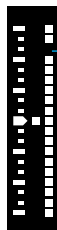

Flash exposure level indicator against the standard exposure level

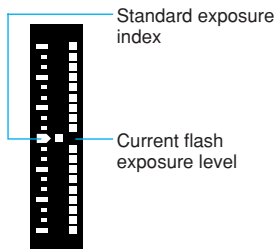

- 5 Set the correct flash exposure level.**
- Adjust the Speedlite's manual flash output and the camera aperture so that the flash exposure level indicator is aligned with the standard exposure index.

- 6 Compose and take the picture.**

About TTL and A-TTL Autoflash Speedlites

- With TTL and A-TTL autoflash Speedlites (EZ-, E-, EG-, ML-, TL-series) set in the TTL or A-TTL autoflash mode, the flash will be fired only at full output. If you set the camera's shooting mode to manual or aperture-priority AE, you can adjust the aperture and fire the flash at full output. Meanwhile, the Speedlite will remain in the TTL or A-TTL autoflash mode.
- When the 550EX is set to C.Fn-03-1, the flash will be fired at full output even in the TTL autoflash mode.

Using Non-Canon Flash Units

Sync Speed

The EOS-1Ds can synchronize with compact, non-Canon flash units at 1/250 sec. or slower shutter speeds. With large studio flash, the sync speed is 1/125 sec. or slower. Be sure to test the flash to see if it synchronizes properly with the camera.

PC Terminal

- The camera's PC terminal is provided for flash units having a sync cord. The PC terminal is threaded to prevent inadvertent disconnection.
- There are studio flash units whose sync cord polarity is opposite from the camera's PC terminal. Such flash units do not work with the EOS-1Ds camera unless the polarity of the sync cable is changed. Consult the manufacturer of the flash unit or purchase a commercially-available polarity conversion cord. The camera's PC terminal polarity is shown in the figure on the right.

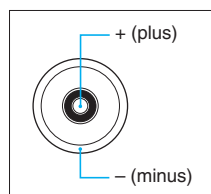

- If the camera is used with a flash unit or flash accessory dedicated to another camera brand, the camera may not operate properly and camera malfunction may result.
Also, do not connect to the camera's PC terminal any flash unit requiring 250 V or more.
- Do not use a high voltage flash on the hot shoe. It might not fire.



A flash unit attached to the camera's hot shoe and a flash unit connected to the PC terminal can be used at the same time.



Playback Images

You can view or erase the images you capture with the camera. You can even make a sound recording for an image.

When playback images not taken with the camera:

The camera might not be able to properly display images captured with a different camera or edited with a personal computer for image processing or changing file name.

Playback Images

You can playback any image on the LCD monitor. A single image or an image index can be displayed.

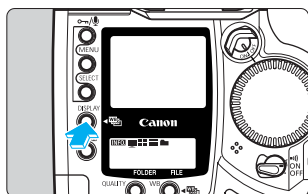

1 Playback an image.

- Press the <DISPLAY> button.
- ▶ The last image you took will be displayed on the LCD monitor.
- To turn off the LCD monitor, press the <DISPLAY> button again.

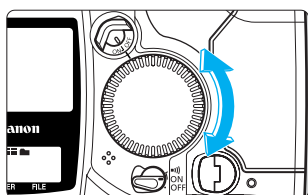

2 Browse through the images.

- To playback images starting with the last (newest) image, hold down the <SELECT> button and turn the <ZOOM IN> dial counterclockwise.
- To playback images starting with the first (oldest) image, hold down the <SELECT> button and turn the <ZOOM IN> dial clockwise.

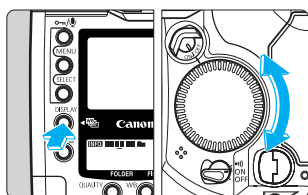

3 Change the display format.

- While pressing the <DISPLAY> button, turn the <ZOOM IN> dial.
- ▶ On the rear LCD panel, the selection mark will move under the display format icons and the LCD monitor's display format will change accordingly.
- When the desired display format appears, let go of the <DISPLAY> button.
- To turn off the LCD monitor, press the <DISPLAY> button again.

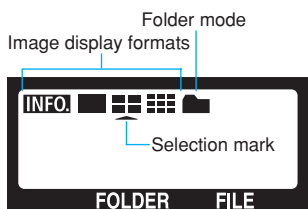

INFO

Image with shooting information (→p.118)



Single image



Four-image index



Nine-image index





- If you playback images and then go away without operating or turning off the camera, the LCD monitor will turn off automatically after half of the auto power-off time elapses. If the auto power-off function has been disabled, the image display will turn off automatically after 15 minutes.
- You can playback all the images in the current folder. To playback images in another folder, you must first select that folder (see step 1 on page 55).
- In any display format, you can protect the image (→p.119) or create a sound recording(→p.121).

P.Fn-30 Enlarging the image

When P.Fn-30's "Enlargement mode" is ON, you can view an enlarged portion of the image. For details, see "EOS DIGITAL Software User's Manual."

To enable this feature, set P.Fn-30 to ON for both shooting and playback. If P.Fn-30 is not ON during shooting, the image cannot be enlarged on the LCD monitor.

1 Playback the image and select the image to be enlarged. (→p.116)

- The image to be enlarged can be in any display format.

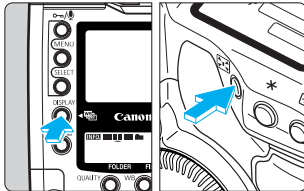

2 Enlarging the image.

- Hold down the <DISPLAY>, then press <DISP>. Be sure to hold down the <DISPLAY> button first.
- ▶ The image will be enlarged.

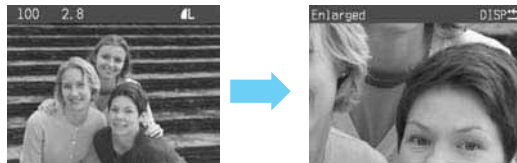

Reference image Box

3 Scroll around the image.

- Press the <SELECT> button.
- ▶ In the bottom right corner, the little box in the reference image shows where you are currently viewing.
- While pressing the <SELECT>button, turn the <DISP> dial to scroll around the image to see another magnified portion. Then let go of the <SELECT> button.
- ▶ The portion within the little box will be enlarged on the LCD monitor.



While one image is enlarged, you cannot switch to another image. Press the <DISPLAY> button to cancel the image enlargement, then proceed from step 1.

Image with Shooting Information

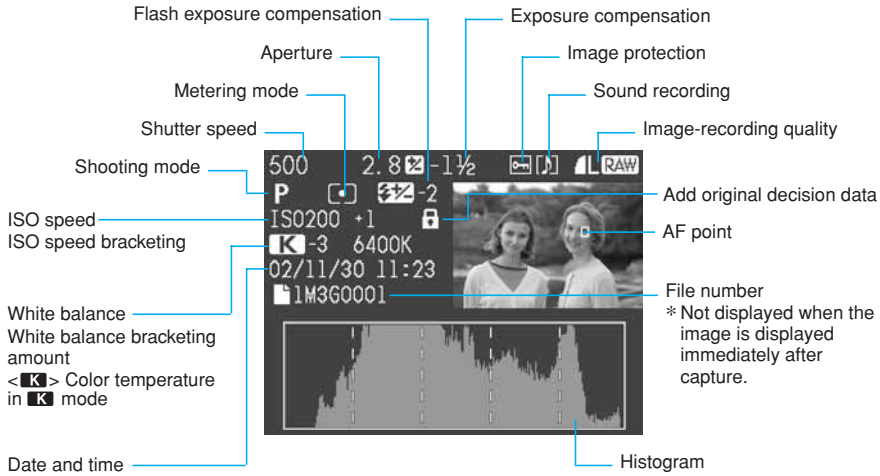

About the Histogram

A histogram is a graph indicating the image's brightness. The horizontal axis indicates the brightness level, while the vertical axis indicates how many pixels exist for each brightness level. From left to right on the horizontal axis, the brightness goes from dark to bright. The more pixels there are toward the left, the darker the image. The more pixels there are toward the right, the brighter the image. If there are too many pixels on either side, you can set exposure compensation (→p.92) to take the picture again so that the exposure is more accurate.

Sample histogram

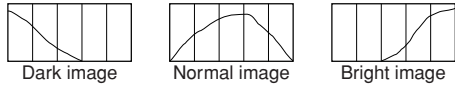

MENU Highlight Alert

When the <INFO> menu's "Highlight alert" is "On" and the display format is set to single image (■) or image with shooting information (INFO), any areas in the image which are overexposed will blink on the LCD monitor even when the image is displayed immediately after capture. Refer to the histogram and apply a decreased exposure compensation amount and take the picture again to obtain a better result.

MENU AF Point

When the <INFO> menu's "Display AF points" is "On" and the display format is (INFO), the AF point used to achieve focus will be shown. (→p.129)
 If the image was taken in the One-Shot AF mode, the AF point which achieved focus will be shown. If automatic AF point selection was used, you may see multiple AF points which achieved focus. If AI Servo AF was used, the selected AF point will be shown.
 The AF point(s) which achieved focus will also be shown if the <OK> menu's "Review" is set to "On (Info)."

Image Protection

Protecting a Single Image

This prevents the image from being erased accidentally.



1 Select the image to be protected.

- Press the <DISPLAY> button to turn on the image display. (→p.116)
- The image can be protected regardless of the display format.
- While pressing the <SELECT> button, turn the <DISP.> dial to select the image to be protected. Then let go of the <SELECT> button.

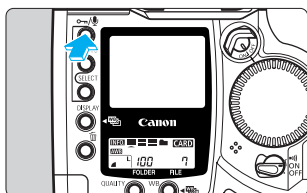

2 Protect the image.

- Press the <Protect> button.
- ▶ The <Protect> icon will then appear to indicate that the image is protected.
- To cancel the image protection, press the <Protect> button again. The <Protect> icon will turn off.
- To protect another image, select the image and press the <Protect> button. Repeat this step for all other images you want to protect.
- When the image is displayed immediately after capture, you can follow step 2 to protect that image.
- To turn off the image display, press the <DISPLAY> button.



The <Protect> button has dual functions for image protection and sound recording. To protect an image, press the button and let go when the <Protect> icon appears. If you press the <Protect> button too long (about 2 seconds), the microphone will start recording instead and the image protection will not be applied.



- You can also protect all the images in a folder or in the CF card all at once. (→p.120)
- A protected image cannot be erased with the camera. To erase a protected image, cancel the protection first.



You can also erase all images at once while retaining the protected ones. (→p.123, 125)

MENU Protecting All Images in a Folder or CF Card

You can protect all the images in a folder or CF card all at once. In the case of a folder, first select it. (→p.55)

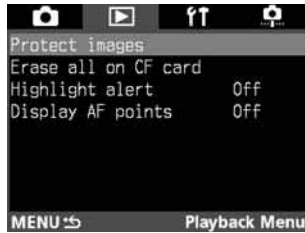

1 On the menu, select “Protect images.”

- Press the <MENU> button.
- While pressing the <MENU> button, turn the <DIAL> dial to select <▶>.
- While pressing the <SELECT> button, turn the <DIAL> dial to select “Protect images.” Then let go of the <SELECT> button.



2 Protect the image.

- While pressing the <SELECT> button, turn the <DIAL> dial to select “Select all in folder” or “Select all on CF card.” Then let go of the <SELECT> button.
- ▶ A confirmation dialog will appear.
- While pressing the <SELECT> button, turn the <DIAL> dial to select “OK.” Then let go of the <SELECT> button.



Protected images cannot be erased with the camera. To erase a protected image, first cancel the image protection.

Clearing Protection for All Images



- In step 2 above, select “Clear all in folder” or “Clear all on CF card.” The protection for all the images in the folder or CF card will be cleared.

🎤 Sound Recording for an Image

With the camera's built-in microphone, you can record your voice for any image. The sound data is attached to the image file and can be played with the dedicated software.



1 Select the image to have a sound recording.

- Press the <DISPLAY> button to playback the image. (→p.116)
- You can record your voice regardless of the LCD monitor's image display format.
- While pressing the <SELECT> button, turn the <DISP.> dial to select the image to have a sound recording. Then let go of the button.

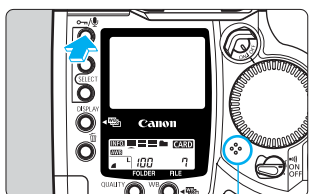

microphone

2 Record your voice.

- Press the <MIC/ON/OFF> button for about 2 sec.
- ▶ When "Recording" appears on the LCD monitor, keep pressing the <MIC/ON/OFF> button and speak into the built-in microphone.
- ▶ The elapsed recording time will be displayed on the lower right corner.



- After you finish the sound recording, let go of the <MIC/ON/OFF> button.
- ▶ The <M> icon will be displayed if the image has a sound recording.



- The maximum time for a single sound recording is 30 sec.
- To record a narration longer than 30 sec., follow step 2 again to do another sound recording for the same image.
- While the image is displayed right after you captured it, you can just follow step 2 to add a sound recording.
- To turn off the LCD monitor, press the <DISPLAY> button.



- A sound recording is not possible on a protected image.
- The EOS-1Ds camera itself cannot play back the sound recording. The EOS-1Ds camera itself cannot play back the sound recording. You must transfer the image to a personal computer and use the dedicated software to play the sound recording.
- The <ON/OFF> button has dual functions for image protection and sound recording. If you press the <ON/OFF> button and release it immediately, image protection will function instead of the sound recording. To make a sound recording, keep pressing the <ON/OFF> button until the “Recording” message appears and let go when you finish the sound recording.
- You cannot erase only the sound recording with the camera alone.

Erasing an Image

You can use the button to erase a single image or all images in a folder. You can also use menu commands to erase all images in a CF card.

- Once an image is erased, it cannot be recovered. Make sure you are erasing the right image.
- You can protect important images from erasing. (→p.119)

🗑 Erasing a Single Image

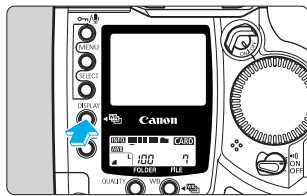

1 Playback the image.

- Press the <DISPLAY> button to playback the image.
 - ▶ The last (newest) image will be displayed.

2 Select the image to be erased.

- While pressing the <SELECT> button, turn the <DISP> dial to select the image to be erased.

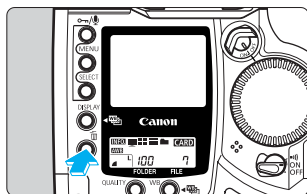

3 Display the erase menu.

- Press the button.
 - ▶ The erase menu will appear at the bottom of the LCD monitor. To exit the erase menu, press the button again.
- You can also follow steps 3 and 4 to erase an image immediately after it is taken.



4 Erase the image.

- While pressing the <⏮> button, turn the <⌚> dial to select "OK." Then let go of the <⏮> button.
- ▶ The access lamp will blink while the image is erased.
- To erase another image, repeat steps 2 to 4.
- To turn off the LCD monitor, press the <DISPLAY> button.

Erasing All Images in a Folder

1 Select the folder whose images you want to erase. (→p.55)

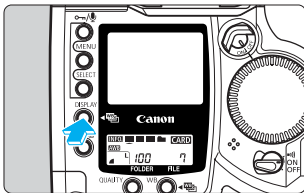

2 Playback the image.

- Press the <DISPLAY> button to playback the image.
- If the folder mode is displayed, hold down the <DISPLAY> button and turn the <⌚> dial to switch to the playback mode. Any display format can be used.

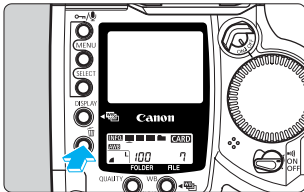

3 Display the erase menu.

- Press the <⏮> button.
- ▶ The erase menu will appear at the bottom of the LCD monitor.



7

Playback Images



4 On the erase menu, select "ALL."

- While pressing the <⏏> button, turn the <⌚> dial to select "ALL." Then let go of the <⏏> button.
- ▶ A confirmation dialog will appear.



5 Erase the images.

- While pressing the <⏏> button, turn the <⌚> dial to select "OK." Then let go of the <⏏> button.
- ▶ All unprotected images in the folder will be erased.
- To turn off the LCD monitor, press the <DISPLAY> button.

MENU Erasing All Images on the CF Card

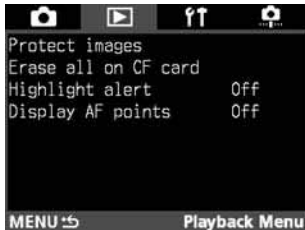

1 On the menu, select “Erase all on CF card.”

- Press the <MENU> button.
- While pressing the <MENU> button, turn the <DISP> dial to select <▶>.
- While pressing the <SELECT> button, turn the <DISP> dial to select “Erase all on CF card.” Then let go of the <SELECT> button.

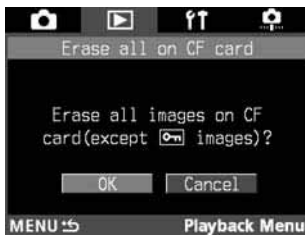

2 Erase the images.

- While pressing the <SELECT> button, turn the <DISP> dial to select “OK.” Then let go of the <SELECT> button.
 - ▶ All unprotected images on the CF card will be erased.
- After the images are erased, the menu will reappear.
- To exit the menu and turn off the LCD monitor, press the <MENU> button.



Once an image is erased, it cannot be recovered. Make sure you are erasing the right images.



Protected images cannot be erased with the camera. To erase protected images, first cancel the image protection. (→p.119)



This procedure is convenient for erasing all unprotected images at one time while retaining the protected images on the CF card.

MENU Formatting a CF Card

If necessary, you can format a CF card for use with the camera. If you insert the CF card into the camera and the CF card error message “Err LF” appears, you may have to format the CF card.

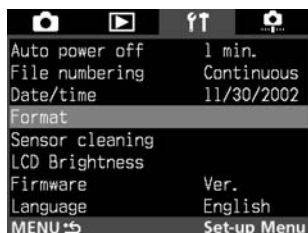

1 On the menu, select “Format.”

- Press the <MENU> button.
- While pressing the <MENU> button, turn the <DISP> dial to select <fT>.
- While pressing the <SELECT> button, turn the <DISP> dial to select “Format.” Then let go of the <SELECT> button.

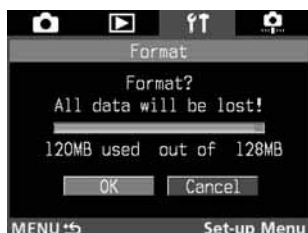

2 Select “OK.”

- While pressing the <SELECT> button, turn the <DISP> dial to select “OK.” Then let go of the <SELECT> button.
- ▶ The CF card will be formatted.
- After the CF card is formatted, the menu will reappear.
- To exit the menu and turn off the LCD monitor, press the <MENU> button.



When you format a CF card, all data on the card will be lost. Protected images will also be erased. Before formatting a CF card, be sure it is okay to erase the contents.



- A non-Canon CF card or a CF card formatted with another camera or personal computer might not work with the EOS-1Ds camera. In such a case, format the CF card with the camera first. Then it might work with the camera.
- If you insert the CF card and the CF card error message “Err LF” appears, use a utility program such as Scan Disk to diagnose and fix the CF card.
- If the CF card error message “Err LF” appears even after you format the CF card, or you use Scan Disk or a similar utility program, use another CF card instead.

8

Menu Settings

On-screen menus enable you to customize the camera's various settings and functions. The mark you see in these Instruction Manual gives just a brief description of the relevant Custom Function. This section explains all of the camera's menu settings, Custom Functions, and Personal Functions. The procedure to set the menu settings is explained in "Menu Operations." (→p.32, 33)

MENU Menu Settings



Custom WB

Select the image to be used for the custom white balance setting. (→p.43)



Color temp.

Set the desired color temperature from 2800 K to 10000 K in 100 K increments. (→p.44)

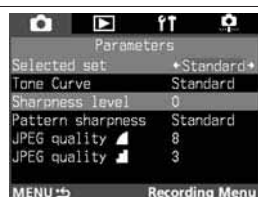

Processing parameter setting

Besides the Standard setting, up to three sets of parameter settings can be set and registered. (→p.50)



Color matrix

Select the film's characteristics equivalent such as the hue, chroma, and color gamut (color reproduction range). (→p.48)



RAW+JPEG rec.

You can record the image in both the RAW and JPEG formats simultaneously.

Select from "RAW+L", "RAW+L", "RAW+S", or "RAW only". (→p.40)



Review

You can display the picture on the LCD monitor immediately after you take it. Set it to "On," "On (Info)," or "Off." (→p.52)

The number of seconds (review time) the image is displayed on the LCD monitor can also be set. See the next menu item.



	<p>Review time</p> <p>When “Review” is set to “On” or “On (Info),” you can set the number of seconds the image is displayed on the LCD monitor. (→p.53)</p>
	<p>Noise reduction</p> <p>When turned on, noise reduction can reduce noise in the image that is prone to occur during bulb exposures.</p> <p> The noise reduction process will take the same amount of time as the exposure time.</p>



	<p>Protect images</p> <p>You can protect all the images in the selected folder or CF card to prevent accidental erase. Or you can cancel the image protection. Choose “Select all in folder,” “Clear all in folder,” “Select all on CF card,” or “Clear all on CF card.” (→p.120)</p>
	<p>Erase all on CF card</p> <p>This erase all the unprotected images on the CF card. (→p.125)</p>
	<p>Highlight alert</p> <p>When the display format has been set to INFO (single image with information) or single image, the overexposed highlight areas of the image will blink on the LCD monitor when “Highlight alert” is “On.” (→p.118)</p>
	<p>Display AF points</p> <p>When the display format has been set to INFO (single image with information), you can set “Display AF points” to “On” or “Off.” (→p.118)</p> <p>The active AF point will be displayed for the One-Shot AF and the selected AF point for the AI Servo AF.</p>

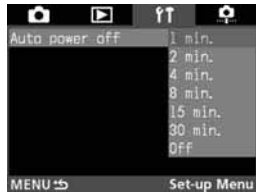

Auto power off

To avoid exhausting the battery, “Auto power off” turns off the camera automatically after the camera is left unused for a set time period. You can set this time to 1, 2, 4, 8, 15, or 30 min. “Off” will disable this feature.



File numbering

Each picture you take is assigned a file number. Set the file numbering system to “A-Reset” or “Continuous.” (→p.56) Selecting “M-Reset” will create a new folder and the file number will start from 0001.



Date/time

Sets the date and time. You can also change the date format (year, month, day). (→p.148)

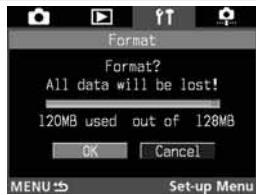

Format

This formats the CF card in the camera. (→p.126)







Sensor cleaning

Select this when you want to clean the CMOS sensor. (→p.150)

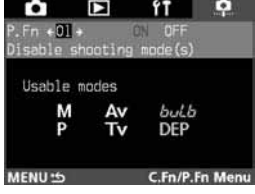
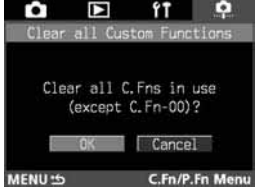

LCD brightness

This sets the brightness of the LCD monitor. While pressing the <SELECT> button, turn the <DIAL> dial to set one of five settings. Use the gray scale on the left side to check the LCD monitor’s tonal range.

	<p>Firmware (→p.155)</p> <p>If you select this without intending to update the firmware, the “CF card containing firmware is required to update.” message will appear. Press the <MENU> button to return to the menu. To obtain the latest firmware update and installation instructions, see Canon’s Web site.</p>
	<p>Language</p> <p>Select your preferred language for the menu. It can be displayed in English, German, French, Spanish, or Japanese.</p>
	<p>Custom Functions</p> <p>This is for setting the camera’s Custom Functions according to your preferences. (→p.132)</p>
	<p>Personal Functions</p> <p>This is for saving up to three groups of Custom Function settings. You can also use the dedicated software to set each Personal Function on or off.(→p.145)</p>
	<p>Clear all Custom Functions</p> <p>This clears all the Custom Function settings to the default settings. Only C.Fn-00 cannot be cleared. (→p.139)</p>
	<p>Clear all Personal Functions</p> <p>This clears all the Personal Function settings. You can then use “Personal Functions (P.Fn)” to set the Personal Functions again. (→p.146)</p>

MENU Setting a Custom Function

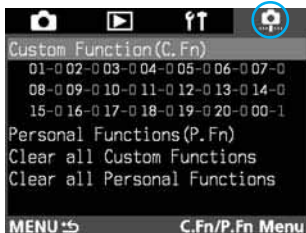

1 On the menu, select “Custom Function (C.Fn).”

- Press the <MENU> button.
- While pressing the <MENU> button, turn the <DISP> dial to select <C.Fn>.
- While pressing the <SELECT> button, turn the <DISP> dial to select “Custom Function (C.Fn).” Then let go of the <SELECT> button.

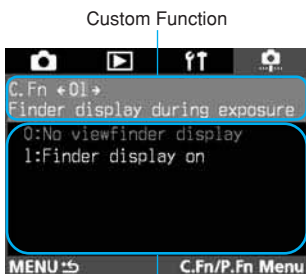

Custom Function

Setting

2 Set the Custom Function.

- While pressing the <SELECT> button, turn the <DISP> dial to select the desired Custom Function. Then let go of the <SELECT> button.
- While pressing the <SELECT> button, turn the <DISP> dial to set the desired setting. Then let go of the <SELECT> button.
- Repeat the above steps to set any other Custom Functions.

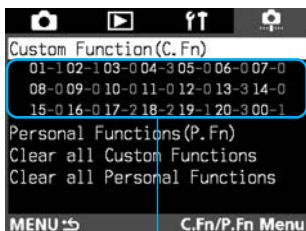

Custom Function settings

3 Exit.

- Press the <MENU> button.
 - ▶ The Custom/Personal Function menu will reappear.
 - ▶ The respective Custom Function setting (number) will be displayed in the Custom Function list.
- To exit the menu and turn off the LCD monitor, press the <MENU> button.

MENU Custom Function Settings

C.Fn-01

Finder display during exposure

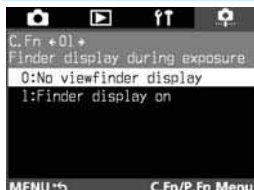

1: Displays the exposure information and number of remaining shots during continuous shooting.

C.Fn-02

Shutter release without CF card

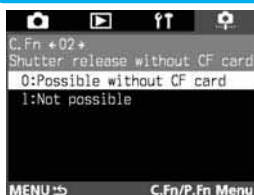

1: With C.Fn-02-1, the shutter button will not work if there is no CF card in the camera. This prevents picture taking without a CF card.

If there is no CF card and you press the shutter button, “LF” will blink on the top LCD panel and in the viewfinder. It indicates that C.Fn-02-1 is in effect.

C.Fn-03

ISO speed expansion

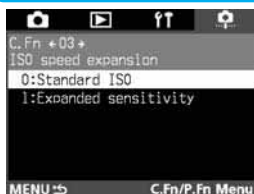

1: You can expand the ISO speed to ISO 50. When this is set, “L” will be displayed.

C.Fn-04

Shutter button / AE lock button

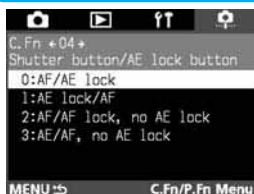

1: You can focus at one location and obtain AE lock at another location in the scene. Press the <∗> button to autofocus and press the shutter button halfway to attain AE lock.

2: In the AI Servo AF mode, you can press the <∗> button to stop the AI Servo AF operation momentarily. It prevents the AF from being thrown off by any passing obstruction coming between the camera and subject. The exposure is set when the picture is taken.

3: This is useful for subjects which keep moving and stopping repeatedly. In the AI Servo AF mode, you can press the <∗> button to start or stop the AI Servo AF operation. The exposure is set when the picture is taken. Thus, the optimum focusing and exposure are always ready for the peak moment.

 C.Fn-04 and C.Fn-19-0/1/2 (→p.138) both have AF start/stop and AE lock functions. If you have set both these Custom Functions and you execute both Custom Function operations, the latter operation will not work. The only exception will be when AF stop is executed after AF start.

C.Fn-05 Manual Tv/Av set. for M exp.

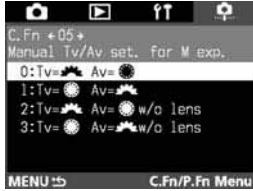

1: This is convenient when you have to often change the aperture during studio sessions with studio flash units. Also, when you use AEB in the manual exposure mode, the shutter speed can stay fixed while only the aperture is shifted for AEB.

To set the shutter speed, hold down the <L> button (or the <Fn> button if C.Fn-11-1/2 is set) and turn the <DIAL> dial.

2: You set the shutter speed and aperture in the same way as with C.Fn-05-0. And you can still set the aperture even while the lens is detached from the camera. Convenient especially if you want to use a super telephoto lens with more than one EOS-1Ds body.

3: You set the shutter speed and aperture in the same way as with C.Fn-05-1. And you can still set the aperture even while the lens is detached from the camera.

C.Fn-06 Exposure level increments

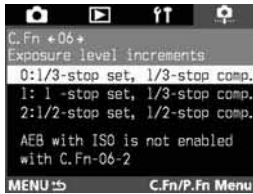

1: Sets full-stop increments for the shutter speed and aperture.
2: Sets half-stop increments for the shutter speed, aperture, and exposure compensation.



When C.Fn-06-2 is set, AEB varying the ISO speed will be disabled by.

C.Fn-07 USM lens electronic MF

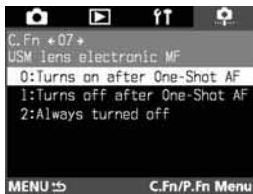

1: This prevents the focus from being thrown off by inadvertent turning of the focusing ring after One-Shot AF. With both C.Fn-07-1 and C.Fn-07-2, manual focusing is possible with the lens focus mode switch set to <MF> (or <M>).

2: Electronic manual focusing is disabled in the AF mode.

Applicable lenses

EF 50mm f/1.0L USM, EF 85mm f/1.2L USM, EF 200mm f/1.8L USM, EF 300mm f/2.8L USM, EF 400mm f/2.8L USM, EF 400mm f/2.8L II USM, EF 500mm f/4.5L USM, EF 600mm f/4L USM, EF 1200mm f/5.6L USM, EF 28-80mm f/2.8-4L USM.



When both C.Fn-04 and C.Fn-07 are set, electronic manual focusing will be enabled or disabled as follows:

Custom Function No.	C.Fn-04		
	Setting	0, 2	1, 3
C.Fn-07	0	D / E	E / E
	1	D / D	E / D
	2	D / D	D / D

* When in focus/Not in focus E: Enabled D: Disabled

C.Fn-08

Top LCD panel / Back LCD pane

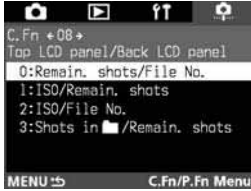

- 1: Displays the ISO speed at all times. It also displays the number of remaining shots on the top LCD panel with four digits.
- 2: Displays the ISO speed instead of the number of remaining shots. You can tell when the number of remaining shots is low by seeing a low maximum burst count displayed in the viewfinder during continuous shooting.
- 3: Displays the number of images saved in the selected folder. Or select this setting if the top LCD panel cannot display all of the digits indicating the number of remaining shots. Images recorded in the RAW+JPEG mode are counted as 1 per shot even though there are two identical images.

The ISO speed display in the viewfinder also changes in the same way.

C.Fn-09

Auto bracketing sequence / cancel

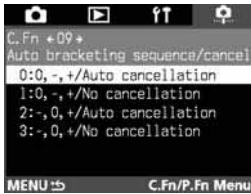

AEB
 0: Standard exposure
 -: Decreased exposure
 +: Increased exposure
 White balance bracketing
 0: Standard white balance
 -: Bluish
 +: Reddish

- You can alter the AEB sequence when you bracket automatically with the shutter speed, aperture, or ISO speed. You can also alter the white balance bracketing sequence. When “Auto cancellation” is set, bracketing will be canceled after you change the lens, or turn off the Main Switch.
- 1: The first bracketed shot is standard exposure (or exposed with the standard white balance). This bracketing sequence can be repeated.
 - 2: Starts the bracketing sequence with the minus (bluish) setting.
 - 3: Repeats the bracketing sequence starting with the minus (bluish) setting.

C.Fn-10

AF point illumination



- 1: The AF point does not light at all. Effective when it is bothersome to see it light up.
- 2: Prevents the dimmed lighting of C.Fn-10-0.
- 3: Effective when the AF point lighting is difficult to see with C.Fn-10-0.

C.Fn-11

AF point selection method



- 1: This reverses the functions of the button and button.
- 2:
 - While exposure metering is active, turn the dial to select a horizontal AF point (if C.Fn-13-3 has been set, select a peripheral AF point). This is also possible during continuous shooting in the AI Servo AF mode or while you are pressing the shutter button halfway. The AF point selection stops at the extreme left, extreme right, top-most, and bottom-most AF points.
 - During autofocusing, you can press the button to switch instantly to the automatic AF point selection mode.
 - You can also select the AF point (including automatic AF point selection) by the same operations of C.Fn-11-1.
 - If both C.Fn-11-2 and C.Fn-18-1/2 (→p.138) have been set, select a vertical AF point by pressing the button and turning the dial.
- 3: This reverses the functions of the button and button.

C.Fn-12

Mirror lockup

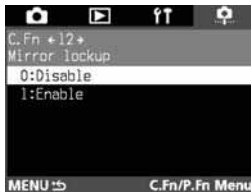

- 1: Effective for close-up and telephoto shots to prevent camera shake caused by the mirror's reflex action. See page 104 for Instruction Manual.

C.Fn-13

Number of AF points/Spot metering

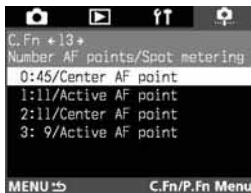

- 1: The selectable AF points are limited to 11. Spot metering is linked to the active AF point. (→p.66)
- 2: The selectable AF points are limited to 11. Spot metering is linked to the center AF point. (→p.66)
- 3: The selectable AF points are limited to 9. Spot metering is linked to the active AF point. (→p.66)



- The metering mode must be set to spot metering before it can be linked to the AF point.
- If C.Fn-13-1/2 is set or cleared, the registered AF point (→p.68) will be replaced by the center AF point.



- Any metering mode besides spot metering can be used.
- With C.Fn-13-1/2/3, all 45 AF points will be subject to automatic selection.
- With C.Fn-13-1/3, FE lock is possible with any AF point you select

C.Fn-14 Auto reduction of daylight sync

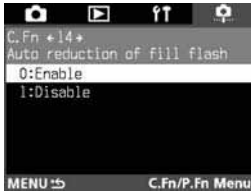

- 0: Obtains a natural-looking fill-flash automatically.
- 1: This prevents underexposure of a subject in front of a strong backlight such as a sunset.

C.Fn-15 Shutter curtain synchronization

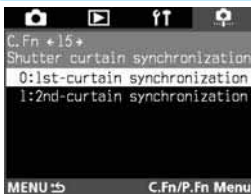

- 1: By using a slow sync speed, you can create a light trail following a moving subject. The flash fires right before the shutter closes. This Custom Function can be used to obtain 2nd-curtain sync effects even with EX-series Speedlites which do not have this capability. If an EX-series Speedlite having this capability is set for 2nd-curtain sync, it will override this Custom Function.

C.Fn-16 Safety shift in Av or Tv



- Safety shift can be set for the shutter-priority AE and aperture-priority AE modes.
- 1: If the subject's brightness changes suddenly and the current shutter-priority AE or aperture-priority AE setting becomes unsuitable, the shutter speed or aperture is shifted to obtain a suitable exposure automatically.

C.Fn-17 AF point activation area

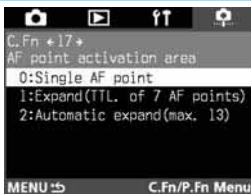

- 1: The AF point activation area expands by one point all around the manually-selected AF point. A total of 7 AF points become active. This setting is effective for when only one manually-selected AF point is unable to focus track a subject moving erratically.
- 2: The camera automatically sets the AF point activation area to 7 or 13 points to suit the lens focal length, AF mode, and the subject's speed during predictive AF. This is effective when the subject's movement is unpredictable.

- 
 - The AF point activation area centers on the selected AF point. Therefore, if a peripheral AF point is selected, the AF point activation area will be smaller as shown below.

7-point activation area



13-point activation area



- Setting C.Fn-13 together will also expand the AF point activation area.

C.Fn-18 Switch to registered AF point



- 1: Press the <[AF-ON]> button to switch to the registered AF point.
- 2: You can switch to the registered AF point only while you press the <[AF-ON]> button. When you release the button, the AF point selected previously becomes active again. You can thereby easily switch between the selected AF point and registered AF point.

If C.Fn-04-1/3 is also set, you can press the <[AF-ON]> button to switch to the registered AF point and start the AF at the same time.

C.Fn-19 Lens AF stop button function



- 1: AF operates only while the AF stop button is pressed. While the button is pressed, AF operation with the camera is disabled.
- 2: When the button is pressed while metering is still active, AE lock takes effect. Convenient when you want to focus and meter separately.
- 3: In the manual AF point selection mode, holding down the button switches to automatic AF point selection (among 45 AF points). Holding down the button switches from manual AF point selection to automatic AF point selection instantly. Convenient when you are no longer able to focus track a moving subject with a manually-selected AF point in the AI Servo AF mode.
In the automatic AF point selection mode, holding down the button selects the center AF point instantly.
- 4: In the One-Shot AF mode, pressing the button switches to AI Servo AF mode only while the button is pressed. In the AI Servo AF mode, pressing the button switches to One-Shot AF mode only while the button is pressed. Convenient when you need to keep switching between One-Shot AF and AI Servo AF for a subject which keeps moving and stopping.
- 5: With the lens' IS switch already ON, the Image Stabilizer operates only while you press the button.

The AF stop button is provided only on super telephoto lenses.

C.Fn-20 AI Servo tracking sensitivity

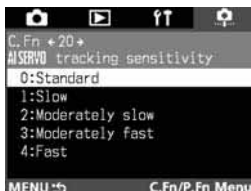

- 1 or 2: Prevents the autofocus from being thrown off by any passing obstruction coming between the camera and subject.
- 3 or 4: Effective when you want to consecutively photograph multiple subjects located at random distances.

This Custom Function does not affect the AI Servo AF tracking speed.

C.Fn-00 Focusing screen

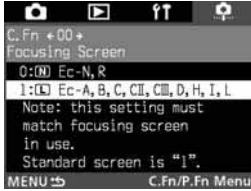

0: For New Laser-matte screens.

1: For Laser-matte screens.

Since the EOS-1Ds's standard focusing screen is the Ec-CIII, C.Fn-00-1 is already set upon factory shipment.



For C.Fn-00 when you change the focusing screen, see page 164.

MENU Clearing All Custom Functions

Except for C.Fn-00, you can clear all the Custom Function settings (reverts to 0).

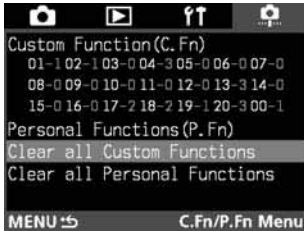

1 On the menu, select “Clear all Custom Functions.”

- Press the <MENU> button.
- While pressing the <MENU> button, turn the <DISP> dial to select <C.Fn>.
- While pressing the <SELECT> button, turn the <DISP> dial to select “Clear all Custom Functions” Then let go of the <SELECT> button.

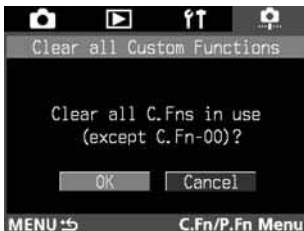

2 Clear all the Custom Function settings.

- While pressing the <SELECT> button, turn the <DISP> dial to select “OK.” Then let go of the <SELECT> button.
 - ▶ All the Custom Function settings will be cleared.
 - ▶ After the Custom Function settings are cleared, the menu will reappear.
- To exit the menu and turn off the LCD monitor, press the <MENU> button.

MENU Registering Custom Function Groups

MENU Registering Custom Function Groups

You can register up to three groups of Custom Function settings. A group of Custom Function settings can be used for a specific shooting situation such as sports, snapshotting, and landscapes.

Note that C.Fn-00 “Focusing screen” cannot be registered in any Custom Function

1 Set the desired Custom Function settings. (→p.132)

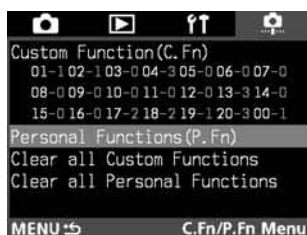

2 On the menu, select “Personal Functions (P.Fn).”

- Press the <MENU> button.
- While pressing the <MENU> button, turn the <DISP> dial to select <P.Fn>.
- While pressing the <SELECT> button, turn the <DISP> dial to select “Personal Functions (P.Fn).” Then let go of the <SELECT> button.

3 Select “P.Fn 00.”

- While pressing the <SELECT> button, turn the <DISP> dial to select “P.Fn 00.” Then let go of the <SELECT> button.

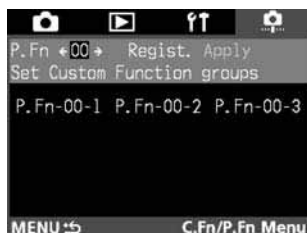

4 Select “Regist.”

- While pressing the <SELECT> button, turn the <DISP> dial to select “Regist.” Then let go of the <SELECT> button.

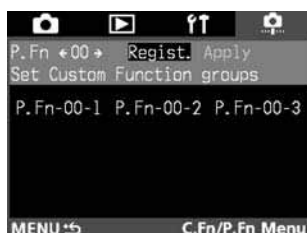



5 Select the group number.

- While pressing the <SELECT> button, turn the <DIAL> dial to select a group number from “P.Fn-00-1” to “P.Fn-00-3.” Then let go of the <SELECT> button.
- ▶ When you select an unregistered group number, the “Not registered” message will appear. If you select a registered group number, the Custom Function settings in that group will be displayed.



6 Register the Custom Function settings under the selected group number.

- While pressing the <SELECT> button, turn the <DIAL> dial to select “OK.” Then let go of the <SELECT> button.

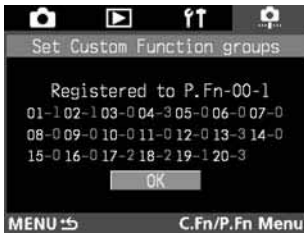

7 Check the registered group's Custom Function settings.

- Check the registered Custom Function settings and press the <SELECT> button.
- ▶ The menu in step 3 will reappear.
- To register another Custom Function group, repeat steps 1 to 7. If you want to change any Custom Function settings in a group, also repeat steps 1 to 7.
- Press the <MENU> button to return to the menu. To exit the menu and turn off the LCD monitor, press the <MENU> button again.
- To incorporate the group's Custom Function settings into the camera, follow “Using a Custom Function Group” on the next page.

MENU Using a Custom Function Group

After following the procedure on the preceding page to register a Custom Function group, follow the procedure below to apply the Custom Function group's settings to the camera.

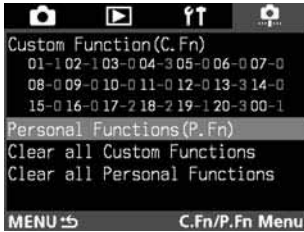

1 On the menu, select “Personal Functions (P.Fn).”

- Press the <MENU> button.
- While pressing the <MENU> button, turn the <DISP> dial to select <P.Fn>.
- While pressing the <SELECT> button, turn the <DISP> dial to select “Personal Functions (P.Fn).” Then let go of the <SELECT> button.



2 Select “P.Fn 00.”

- While pressing the <SELECT> button, turn the <DISP> dial to select “P.Fn 00.”

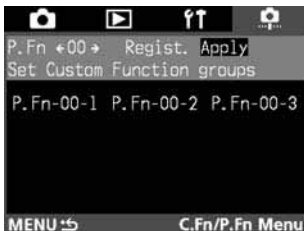

3 Select “Apply.”

- While pressing the <SELECT> button, turn the <DISP> dial to select “Apply.” Then let go of the <SELECT> button.
- ▶ If the P.Fn 00 group has not been registered, “Apply” cannot be selected. First follow the procedure in “Set Custom Function Groups.” (→p.140)

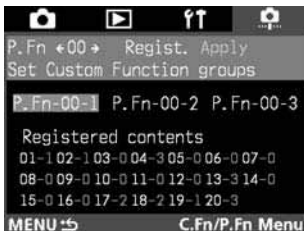

4 Select the group number to be applied.

- While pressing the <SELECT> button, turn the <DISP> dial to select “P.Fn-00-1,” “P.Fn-00-2,” or “P.Fn-00-3.” Then let go of the <SELECT> button.
- ▶ When you select a registered group number, the respective Custom Function settings (“Registered contents”) will be displayed. If you select an unregistered group number, the “Not registered” message will appear.

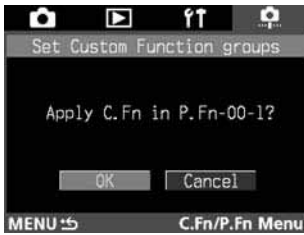

5 Select "OK."

- While pressing the <SELECT> button, turn the <DIAL> dial to select "OK." Then let go of the <SELECT> button.

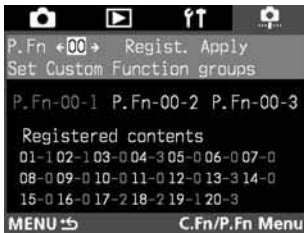

6 Check the registered group's Custom Function settings.

- ▶ The group number of the Custom Functions that were applied is displayed in green, and the settings are also displayed.
- Check the applied Custom Function settings.
- Press the <MENU> button to return to the menu. To exit the menu and turn off the LCD monitor, press the <MENU> button again.

Personal Functions

Beyond Custom Functions, Personal Functions enable you to further customize your camera settings. They are set with the dedicated software while the EOS-1Ds is connected to a personal computer. For details, see “EOS DIGITAL Software User’s Manual.”

P.Fn-00 for Custom Function group registration can be set with the camera. (→p.140)

Personal Functions

P.Fn No.	Description
00	Custom Function group registration.
01	Disables the shooting modes.
02	Disables the metering modes.
03	Specifies the metering mode for manual exposure.
04	Sets the maximum and minimum shutter speeds to be used.
05	Sets the maximum and minimum apertures to be used.
06	Registers and switches the shooting mode and metering mode.
07	Repeats bracketing during continuous shooting.
08	Sets the number of shots to be bracketed.
09	Changes the bracketing sequence for C.Fn-09-2/3 to increased exposure, standard exposure, and decreased exposure.
10	Retains the shift amount for program shift.
14	Disables focus detection (search driving) by the lens drive.
15	Disables the AF-assist beam from being emitted.
16	Enables automatic shooting when focus is achieved at the fixed point of focus while the shutter button is pressed fully.
17	Disables automatic AF point selection.
18	Enables automatic AF point selection when C.Fn-11-2 has been set.
19	Sets the continuous shooting speed.
20	Limits the number of frames during continuous shooting.
21	Enables quiet operation when the shutter button is OFF after picture-taking.
23	Changes the timer’s time length.
24	Illuminates the LCD panel during bulb exposures.
25	Sets the default settings when the CLEAR (QUALITY+WB) button is ON.
27	Enables the electronic dial’s function to be used in the reverse direction.
28	Prevents exposure compensation with the Quick Control Dial.
30	Enlargement mode.
31	Adds original image evaluation data.

* About P.Fn-11, 12, 13, 22, 26, and 29

In order to have the EOS-1Ds’s P.Fn numbers (00 to 31) match the EOS-1D’s as much as possible, the Personal Functions in the EOS-1D which are not provided in the EOS-1Ds have been left blank in the EOS-1Ds.

MENU Clearing and Resetting Personal Functions

You can clear or reset Personal Functions set and registered with the dedicated software. The Personal Function settings can be modified only with the driver software. For details, see “EOS DIGITAL Software User’s Manual.”

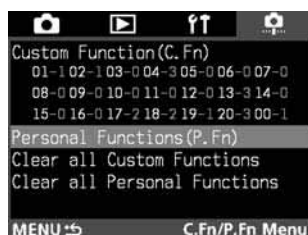

1 On the menu, select “Personal Functions (P.Fn).”

- Press the <MENU> button.
- While pressing the <MENU> button, turn the <DISP> dial to select <P.Fn>.
- While pressing the <SELECT> button, turn the <DISP> dial to select “Personal Functions (P.Fn).” Then let go of the <SELECT> button.



2 Select the number of the Personal Function whose setting you want to clear or reset.

- While pressing the <SELECT> button, turn the <DISP> dial to select the Personal Function number. Then let go of the <SELECT> button.



3 Clear or reset the setting.

- While pressing the <SELECT> button, turn the <DISP> dial to select “OFF” to clear the settings or select “ON” to reset the settings. Then let go of the <SELECT> button.
 - ▶ When it is “ON” or “OFF,” it will be displayed in green.
- To clear or reset another Personal Function, repeat steps 2 and 3.
- Press the <MENU> button to return to the menu. To exit the menu and turn off the LCD monitor, press the <MENU> button again.



Even after you clear the Personal Function settings all at once (→p.146), you can follow the above procedure to reset the Personal Functions.

MENU Clearing All Personal Functions

You can clear all the Personal Function settings set or registered with the dedicated software.

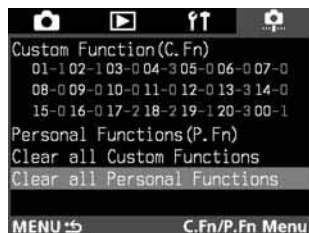

1 On the menu, select “Clear all Personal Functions.”

- Press the <MENU> button.
- While pressing the <MENU> button, turn the <DISP> dial to select <P.Fn>.
- While pressing the <SELECT> button, turn the <DISP> dial to select “Clear all Personal Functions.” Then let go of the <SELECT> button.



2 Clear all the Personal Functions.

- While pressing the <SELECT> button, turn the <DISP> dial to select “OK.” Then let go of the <SELECT> button.
 - ▶ When the Personal Functions are cleared, the menu will reappear.
- To exit the menu and turn off the LCD monitor, press the <MENU> button.



After all the Personal Functions are cleared, you can set them again by using “Personal Functions (P.Fn).” (→p.145)

9

Maintenance

Learn how to set the camera's date and time, back-up battery and clean the CMOS sensor.

MENU Setting the Date and Time

To set or correct the camera's date and time, follow the procedure below. The date and time is recorded with each picture you take.

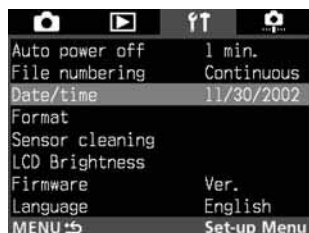

1 On the menu, select "Date/time."

- Press the <MENU> button.
- While pressing the <MENU> button, turn the <DISP> dial to select <fT>.
- While pressing the <SELECT> button, turn the <DISP> dial to select "Date/time." Then let go of the <SELECT> button.

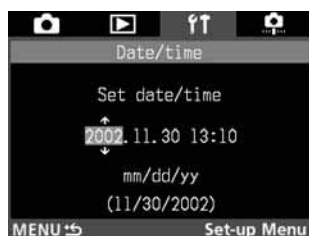

2 Set the date and time.

- Press the <SELECT> button to select the year, month, day, hour, or minute.
 - ▶ The selection shifts each time you press the <SELECT> button.
- While pressing the <SELECT> button, turn the <DISP> dial to select the correct number. Then let go of the <SELECT> button.
- ▶ After setting one item, select the next item to be set.

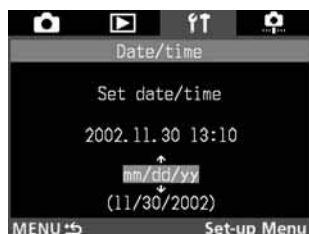

3 Choose the date display format.

- While pressing the <SELECT> button, turn the <DISP> dial to select one of the following display formats (the selection loops as follows):

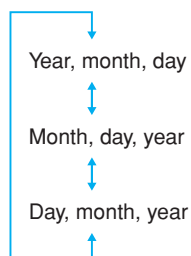

4 Press the <MENU> button.

- ▶ The date and time will be set and the menu will reappear.
- To exit the menu and turn off the LCD monitor, press the <MENU> button again.



The pictures you take are recorded together with the current date and time. If the correct date and time is not set first, the pictures you take will be recorded with an incorrect date and time.

Replacing the Back-up Battery

The back-up battery maintains the camera's date and time. The battery's service life is about 10 years. If the date/time is reset upon battery pack replacement, replace the back-up battery with a new CR2025 lithium battery as described below.

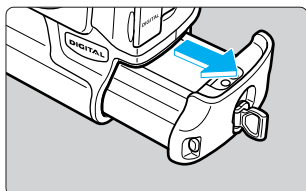

1 Set the ON/OFF switch to OFF and remove the battery pack.

- The back-up battery is on the ceiling of the battery pack compartment.

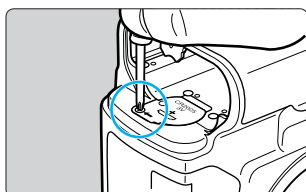

2 Remove the back-up battery cover.

- Loosen the screw as shown in the illustration.

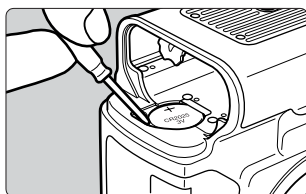

3 Remove the back-up battery.

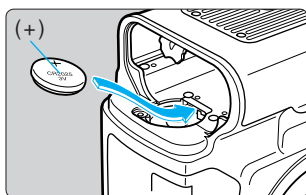

4 Install a new back-up battery.

- The plus side of the battery must face up.

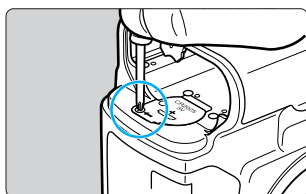

5 Reattach the battery cover.

- After you install the battery and set the ON/OFF switch to ON, the LCD monitor will display the menu for setting the date and time. Follow the steps 2 to 4 on page 148 to set the correct date and time.





For the back-up battery, be sure to use only a CR2025 lithium battery.

MENU Cleaning the CMOS Sensor

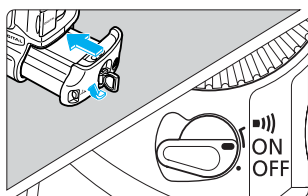

The CMOS sensor corresponds to the film in a film-based camera. If any dust or other foreign matter adheres to the CMOS sensor, it may show up as a dark speck in the pictures you take. To avoid this, follow the procedure below to clean the CMOS sensor. Note that the CMOS sensor is a very delicate component. If possible, you should have it cleaned by a Canon Service Center.

While you clean the CMOS, the camera's power must remain on the whole time. To make sure the power will not turn off while you clean the CMOS sensor, connect the camera to a power outlet with the DC Coupler Kit or use the battery pack that has enough power. You will also need a rubber blower, and the lens must be detached from the camera. (→p.26)



- 1 Insert the DC coupler or battery pack into the battery compartment (→p.23, 25) and set the  switch to <ON> (→p.29).**



- 2 On the menu, select "Sensor cleaning."**
 - Press the <MENU> button.
 - While pressing the <MENU> button, turn the  dial to select <fT>.
 - While pressing the <SELECT> button, turn the  dial to select "Sensor cleaning." Then let go of the <SELECT> button.



- 3 Select "OK."**
 - While pressing the <SELECT> button, turn the  dial to select "OK." Then let go of the <SELECT> button.
 - ▶ The LCD monitor will turn off.

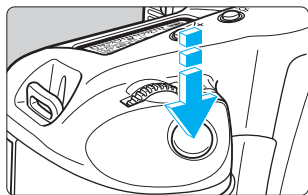

- 4 Press the shutter button fully.**
 - ▶ The reflex mirror will lock up and the shutter will open.

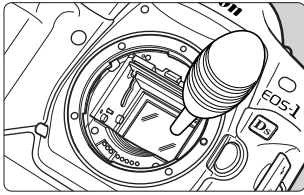

5 Clean the CMOS sensor.

- Use a rubber blower to carefully blow away any dust, etc., adhering to the CMOS sensor.

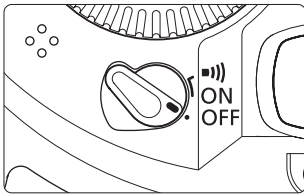

6 After cleaning the CMOS sensor.

- Set the <S> switch to <OFF>.
 - ▶ The camera will turn off and the shutter will close. The reflex mirror will also go down.
- Set the <S> switch to <ON>. You can start taking pictures again.



- Be sure not to turn off the camera while cleaning the CMOS sensor. If the power is turned off, the shutter will close and you might damage the shutter curtain with the blower.
- Do not use a blower brush. The brush can scratch the CMOS sensor.
- Do not insert the blower tip inside the camera beyond the lens mount. If the power goes out, the shutter curtain will close and the blower tip may damage it.
- Do not use a high-pressure blower or compressed, canned air. The air's extra pressure may damage the CMOS sensor or the gas in the can may freeze the CMOS sensor surface.



10

Reference

This section will help you understand your camera better. It covers basic photography concepts, camera specifications, system accessories, and other reference information.

Basic Terminology

AE

Abbreviation for auto exposure. It is an automatic metering and exposure system that sets the optimum exposure (shutter speed and/or aperture) based on the reading by the built-in exposure meter.

AF

Abbreviation for auto focus. It enables the camera to focus the subject automatically.

CF (CompactFlash) card

CF card is the small, card-shaped storage media used to record images taken by the EOS-1Ds.

ISO speed

This indicates the film's sensitivity to light. It is expressed as a number following "ISO" such as "ISO 200." The higher the number, the higher the sensitivity to light. Digital cameras also use the same ISO speed standard used by film-based cameras.

JPEG

Abbreviation for Joint Photographic Experts Group. It is an image file format with various compression levels. The higher the compression rate, the lower the image quality, when the file is expanded (restored).

RAW

This is an image file format that saves the image as is when captured by the camera. It is geared for image processing with a personal computer.

The image quality is not affected when the raw image is compressed, saved, or decompressed. By using the dedicated software for image processing, the image can be optimally enhanced for the specified purpose.

sRGB

Color matching standard jointly developed by Microsoft and Hewlett-Packard. Cameras, monitors, applications, and printers which comply with this standard are able to reproduce colors in the same way. (The "s" stands for standard.)

Depth of field

This is the range where acceptable focus can be achieved in front of and behind the point of the subject. The smaller the aperture (the higher the f/number), the deeper the depth of field. And the larger the aperture (the lower the f/number), the shallower the depth of field.

The depth of field is affected as described below:

- (1) A smaller aperture (a higher f/number) increases the depth of field.
For example, stopping down to f/8 obtains a deeper depth of field than f/4.5.
- (2) A lens with a shorter focal length increases the depth of field.
A wide-angle lens obtains a deeper depth of field than a telephoto lens.
- (3) A longer distance between the camera and subject increases the depth of field.
- (4) The depth of field behind the point of optimum focus (2) is longer than the depth of field in front of the point of optimum focus (1).

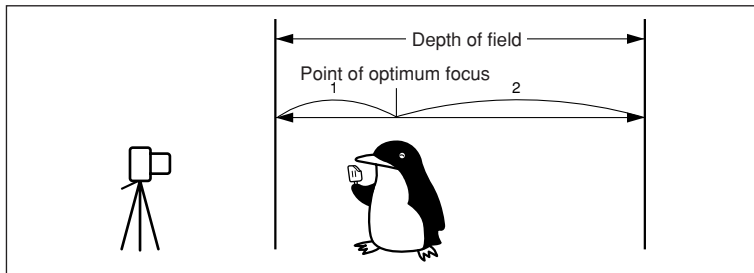

Aperture set to f/22.









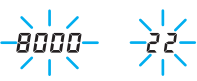

Aperture set to f/2.

Exposure

Exposure occurs when the film (or the image sensor in a digital camera) is exposed to light. Correct exposure is obtained when the film or the image sensor is exposed to a proper amount of light in accordance with its sensitivity to light. The correct exposure is adjusted with the camera's shutter speed and aperture.

Exposure Warning List

Mode	Blinking Warning	Indication	Solution
P		The subject is too dark.	1) Increase the ISO speed. 2) Use flash.
		The subject is too bright.	1) Decrease the ISO speed. 2) Attach a neutral density filter to the lens.
Tv	125 	The picture will be underexposed.	1) Turn the to set a slower shutter speed. 2) Increase the ISO speed.
	125 	The picture will be overexposed.	1) Turn the to set a faster shutter speed. 2) Decrease the ISO speed.
Av		The picture will be underexposed.	1) Turn the to set a larger aperture (smaller f/number). 2) Increase the ISO speed.
		The picture will be overexposed.	1) Turn the to set a smaller aperture (larger f/number). 2) Decrease the ISO speed.
DEP	60 	The desired depth of field cannot be obtained.	1) Move away from the subject and try again. 2) If a zoom lens is used, use the shortest focal length.
		The subject is too dark.	1) Increase the ISO speed. 2) Use flash.
		The subject is too bright.	1) Decrease the ISO speed. 2) Attach a neutral density filter to the lens.



The sample warnings apply when a lens having a maximum aperture of f/1.4 and minimum aperture of f/22 is attached to the camera. The maximum and minimum aperture warning displays will differ depending on the lens attached to the camera.

Program Line

The program line below applies when the camera is used in the Program AE <P> mode with an EF 50mm f/1.4 USM lens.

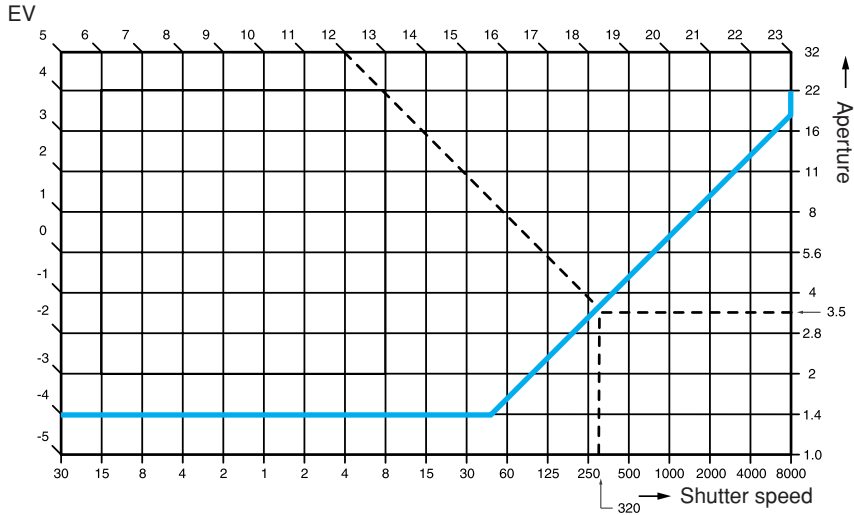

Program Line Description

The bottom horizontal axis represents the shutter speed and the right vertical axis represents the aperture. On the left edge and top edge of the graph, the Exposure Value (EV) is indicated for respective shutter speed and aperture combination set by the Program AE mode and denoted by the colored program line.

Example: When the subject brightness is EV 12, the point where the diagonal line from EV 12 (on the top edge of the graph) intersects the program line indicates the corresponding shutter speed (1/320 sec.) and aperture (f/3.5) which the program sets automatically.

Shutter Speed and Aperture Readouts

Shutter speed readout

The shutter speed is normally displayed in 1/3-stop increments. Numbers from “4” to “8000” denote the denominator of the shutter speed fraction. For example, “125” is 1/125 sec. Also, 0”3 is 0.3 sec., and 15” is 15 sec.

Aperture readout

The aperture is normally displayed in 1/3-stop increments. The higher the number, the smaller the aperture opening. The range of aperture numbers (f/numbers) displayed depends on the lens used.

1/3-stop Increments		1/2-stop Increments		Full-stop Increments			
Shutter Speed	Aperture	Shutter Speed	Aperture	Shutter Speed	Aperture		
8000	13	1.0	2.5	8000	1”	1.0	1.0
6400	10	1.1	2.9	6000	1”5	1.2	1.4
5000	8	1.2	3.2	4000	2”	1.4	2.0
4000	6	1.4	3.6	3000	3”	1.8	2.8
3200	5	1.6	4.0	2000	4”	2.0	4.0
2500	4	1.8	4.5	1500	6”	2.5	5.6
2000	0”3	2.0	5.1	1000	8”	2.8	8.0
1600	0”4	2.2	5.7	750	10”	3.5	11
1250	0”5	2.5	6.4	500	15”	4.0	16
1000	0”6	2.8	7.2	350	20”	4.5	2.2
800	0”8	3.2	8.1	250	30”	5.6	8
640	1”	3.5	9.1	180		6.7	4
500	1”3	4.0		125		8.0	6.4
400	1”6	4.5		90		9.5	9.1
320	2”	5.0		60		1.1	
250	2”5	5.6		45		1.3	4”
200	3”2	6.3		30		1.6	8”
160	4”	7.1		20		1.9	15”
125	5”	8.0		15		2.2	30”
100	6”	9.0		10		2.7	
80	8”	10		8		3.2	
60	10”	1.1		6		3.8	
50	13”	1.3		4		4.5	
40	15”	1.4		0”3		5.4	
30	20”	1.6		0”5		6.4	
25	25”	1.8		0”7		7.6	
20	30”	2.0				9.1	
15		2.2					

C.Fn C.Fn-06 enables the shutter speed and aperture to be set in full-stop or 1/2-stop increments. (→p.134)

Error Codes

If a camera error occurs, <Err xx> will be displayed on the top LCD panel. Follow the instruction below according to the error code.

If the same error occurs often, something is probably wrong with the camera. Jot down the “xx” error code and take your camera to the nearest Canon Service Center (see list of service centers on the back cover).

If an error occurs after you take a picture, the camera might have missed the shot. Press the <DISPLAY> button to see if the image appears on the LCD monitor.

Error code	Countermeasures
Err 01	Clean the lens contacts. (→p.11)
Err 02	There is a problem on the CF card. Please perform one of the following actions: Removing and reinstalling the CF card. Format the CF card. Use another CF card instead.
Err 03	Too many folders in the CF card. Replace with a formatted CF card.
Err 04	The CF card is full. Erase unnecessary images or replace with a CF card with sufficient space.
Err 99	Remove and reinstall the battery.

On-screen Messages

The messages displayed on the LCD monitor are as follows:

Message	Description
Busy	The camera is processing the data. Wait a moment.
This is not an image shot by EOS-1Ds	You selected an image that cannot be used for “Custom WB”. Select an image that can be used. (→p.43)
“Folder number full” No more producing folder	Since the folder number has reached the maximum of 999, a new folder cannot be created. Use a personal computer to delete unnecessary folders or use a CF card containing a folder number that has not reached the maximum.
“CF card full” No more producing folder	Since the CF card is full, a new folder cannot be created. Use a CF card which is not full or use a personal computer to erase unnecessary images or folders from the CF card to make more room. Note that any erased images cannot be recovered.

Message	Description
“CF card full” No more recording	Since the CF card is full, a sound recording cannot be made. Erase unnecessary images from the CF card to make more room. Note that any erased images cannot be recovered. (→p.121)
Cannot record	The sound file (WAV) is damaged, or there is a sound file in an incompatible format. Use a personal computer to erase unnecessary sound files.
Cannot format Change the CF card	The CF card could not be formatted. Use a compatible CF card.
CF card not formatted	The CF card has not been formatted. The CF card must be formatted before it can be used. (→p.126) There is something wrong with the CF card. Format the CF card or replace it.
No CF card	There is no CF card. Insert a CF card into the camera.
Protected!	You tried to erase a protected image. To erase a protected image, first cancel the protection. Then erase the image. (→p.119)
Not applicable, since not registered	You tried to apply a P.Fn-00 number which has not been registered. Only a P.Fn-00 number that has been registered can be applied. (→p.142)
No Image	The CF card has no displayable image. This message also appears if there is no displayable image while you are setting the “LCD brightness” on the menu. Take a picture or insert a CF card that contains a displayable image.
Cannot play back image	You tried to playback an image whose file format is incompatible. Or you tried to playback an image whose file has been corrupted.
This image cannot be enlarged	You tried to enlarge an image which was not taken with the EOS-1Ds. Or, P.Fn-30 was not ON when the image was taken.
Set P.Fn-30 to ON	P.Fn-30 was OFF. To enable image magnification, turn on P.Fn-30 before shooting.
Set enlargement mode of P.Fn-30 on the camera	P.Fn-30 has not been set in the camera. Use the dedicated software to set P.Fn-30.

Troubleshooting Guide

If there is a problem, first refer to this Troubleshooting Guide.

Power Source

<p>The battery cannot be recharged.</p>	<p>You are using the wrong battery. ▶ Use the dedicated Ni-MH Pack. (→p.22)</p> <p>The battery is not properly attached to the charger. ▶ Attach the battery properly to the charger. (→p.22)</p>
<p>The camera does not operate even when the <⏻> switch is set to <ON>.</p>	<p>The battery is exhausted. ▶ Recharge the battery. (→p.22)</p> <p>The battery is not installed properly. ▶ Install the battery properly. (→p.23)</p> <p>The CF card slot cover is open. ▶ Push in the CF card until the CF card release button pops up. Then close the CF card slot cover. (→p.27)</p>
<p>The access lamp still blinks even when the <⏻> switch is set to <OFF>.</p>	<p>If you set the <⏻> switch to <OFF> right after taking a picture, the access lamp will still blink for a few seconds while the image is recorded onto the CF card. ▶ When the camera finishes recording the image to the CF card, the access lamp will stop blinking and the power will turn off.</p>
<p>The battery becomes exhausted quickly.</p>	<p>The battery is not fully charged. ▶ Recharge the battery fully. (→p.22)</p> <p>The battery's service life has expired. ▶ Replace the battery with a new one. (→p.166)</p>
<p>The camera turns off by itself.</p>	<p>Auto power off is in effect. ▶ Set the <⏻> switch to <ON> again or set auto power off to "Off." (→p.130)</p>
<p>Only the <⏻> icon is displayed on the top LCD panel.</p>	<p>The battery has almost exhausted. ▶ Recharge the battery. (→p.22)</p>

Shooting

<p>No images can be shot or recorded.</p>	<p>The CF card is not properly installed. ▶ Install the CF card properly. (→p.27)</p> <p>The CF card is full. ▶ Use a new CF card or erase unnecessary images. (→p.27, 122)</p> <p>The battery is exhausted. ▶ Recharge the battery. (→p.22)</p> <p>You did not focus well. (The focus confirmation light in the viewfinder blinked.) ▶ Press the shutter button halfway and focus the subject. If you still cannot focus properly, focus manually. (→p.74)</p>
<p>The LCD monitor does not display a clear image.</p>	<p>The LCD monitor screen is dirty. ▶ Use a soft cloth to clean the screen.</p> <p>The LCD's service life has expired. ▶ Contact your dealer or Canon Service Center.</p>
<p>The image is out of focus.</p>	<p>The lens focus mode switch is set to <MF> or <M>. ▶ Set the lens focus mode switch to <AF>. (→p.26)</p> <p>Camera shake occurred when you pressed the shutter button. ▶ To prevent camera shake, hold the camera still and press the shutter button gently. (→p.29, 35)</p>
<p>The CF card cannot be used.</p>	<p>The data in the CF card is damaged. ▶ Format the CF card. (→p.126) ▶ Use the correct CF card. (→p.2, 3)</p>

Image Review

<p>The image cannot be erased.</p>	<p>The image is protected. ▶ Cancel the protection first. (→p.119)</p>
<p>The date and time is wrong.</p>	<p>The correct date and time has not been set. ▶ Set the correct date and time. (→p.148)</p>

Changing the Focusing Screen

You can change the camera's focusing screen to better suit the subject or shooting situation. You must also set C.Fn-00 so that the standard setting for obtaining a correct exposure matches the focusing screen.

Focusing Screen Type	Designation	C.Fn-00 Setting
N New Laser-matte Screen	Ec-N, Ec-R	0
L Laser-matte Screen	Ec-series (A, B, C, CII, CIII, D, H, I, L)	1

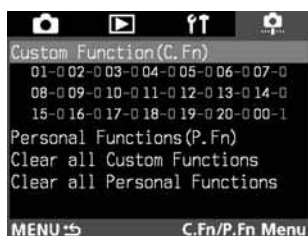

1 On the menu, select "Custom Function (C.Fn)."

- Press the <MENU> button.
- While pressing the <MENU> button, turn the <DISP> dial to select <C.Fn>.
- While pressing the <SELECT> button, turn the <DISP> dial to select "Custom Function (C.Fn)" Then let go of the <SELECT> button.

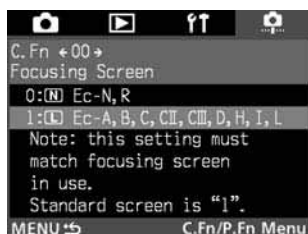

2 Select C.Fn-00.

- While pressing the <SELECT> button, turn the <DISP> dial to select "00." Then let go of the <SELECT> button.
- While pressing the <SELECT> button, turn the <DISP> dial to select the desired setting. Then let go of the <MENU> button.



3 Check the message.

- If it is OK, hold down the <SELECT> button and turn the <DISP> dial to select "OK." Then let go of the <SELECT> button.



C.Fn-00 cannot be in any Custom Function group to be registered.



- If you do not replace the focusing screen that came with the camera, you need not change C.Fn-00-1 factory setting.
- To change the focusing screen, refer to the instructions that came with the focusing screen.
- The Ec-A, Ec-B, Ec-I, and Ec-L focusing screens have a prism at the center. A correct exposure reading cannot be obtained with evaluative metering or spot metering based on the center area where there is a prism. Use centerweighted average metering or off-center spot metering with these focusing screens.

Ec-series Interchangeable Focusing Screens

Ec-A: Standard microprism

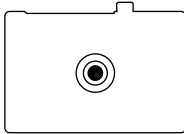

Lenses with a maximum aperture smaller (higher f/number) than f/5.6 will cause the focusing screen's microprism to darken.

Ec-H: Laser-matte with scale

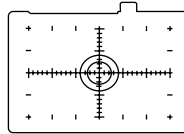

The scales at the center and periphery help you compose shots for close-ups and photomicrography.

Ec-B: New split screen

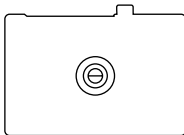

Lenses with a maximum aperture smaller (higher f/number) than f/5.6 will not cause the focusing screen's microprism to darken.

Ec-I: Laser-matte with cross hair

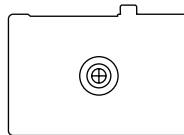

Use the cross hair at the center to focus. Suited for photomicrography and astrophotography.

Ec-CII: All Laser-matte

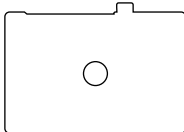

EOS-1N's standard focusing screen.

Ec-L: Cross split screen

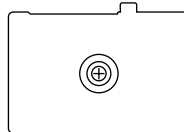

Focus with the vertical and horizontal splits. Lenses with a maximum aperture smaller (higher f/number) than f/5.6 will cause the focusing screen's split portion to darken.

Ec-CIII: Laser-matte

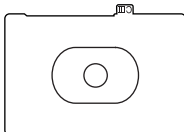

EOS-1Ds, EOS-1D and EOS-1V's standard focusing screen. The CIII logo is imprinted on the lug to distinguish it from the Ec-N.

Ec-N: New Laser-matte

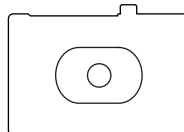

EOS-3's standard focusing screen.

Ec-D: Laser-matte with grid

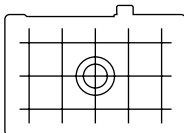

Ideal for architectural photography and photo duplication work.

Ec-R: New Laser-matte

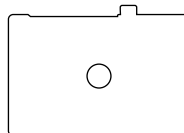

EOS-1N RS's standard focusing screen.

Major Accessories (optional)



Ni-MH Pack NP-E3

Dedicated, high-performance power pack with a rated voltage of 12 V. It can be recharged up to 500 times. When fully charged, it enables the camera to take up to about 600 shots at normal temperature.



Ni-MH Charger NC-E2

Quick charger dedicated to the Ni-MH Pack NP-E3. It takes about 120 minutes to recharge one pack, and excess recharging is prevented. Two packs can be attached to it at one time. The discharge function takes about 8.5 hours to cancel the pack's memory effect. It runs on 100 - 240 VAC.



Shoe-mount Speedlites

Flash photography with an EX-series Speedlite is as easy as normal auto exposure shooting without flash. All EX-series Speedlites enable E-TTL autofocus, high-speed sync (FP flash), and FE lock. With the 550EX, an easy-to-use, wireless E-TTL autofocus system is possible with multiple Speedlites.



Macro Ring Lites

The EX-series Macro Ring Lites are ideal for macro flash photography.

You can fire only one or both flash tubes and control the flash ratio to easily obtain sophisticated lighting effects with E-TTL autofocus. Also, high-speed sync (FP flash), FE lock, and a multi-Speedlite, wireless system (with 550EX as a slave) are possible to achieve various macro flash effects.



Remote Switch RS-80N3

Remote switch with an 80-cm cord to prevent camera shake for super telephoto shots, macrophotography, and bulb exposures. You can use the remote switch to press the shutter button halfway or completely. It also has a shutter release lock. Its quick-lock plug connects to the EOS-1Ds's remote control terminal.



Timer Remote Controller TC-80N3

Attached with an 80-cm cord, this remote switch has four built-in functions: 1. Self-timer, 2. Interval timer, 3. Bulb-exposure timer, and 4. Shutter-release count setting. The time can be set anywhere from 1 sec. to 99 hours, 59 min., 59 sec. Its connection plug for the EOS-1Ds has a quick-lock feature.



Wireless Controller LC-4

Wireless controller effective up to 100 meters. It comes with a transmitter and receiver. The receiver's camera connection plug connects to the EOS-1D's remote control terminal with quick-lock feature.



E-Series Dioptic Adjustment Lenses

One of ten E-series dioptic adjustment lenses (−4 to +3 diopters) can be attached to the camera's eyepiece to further expand the dioptic adjustment range.



CF card

Data storage device where the captured images are recorded. CF cards made by Canon are recommended.

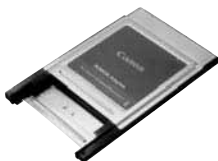

PC card adapter

Enables a CF card to be inserted into a PC card slot or PC card reader.

System Map

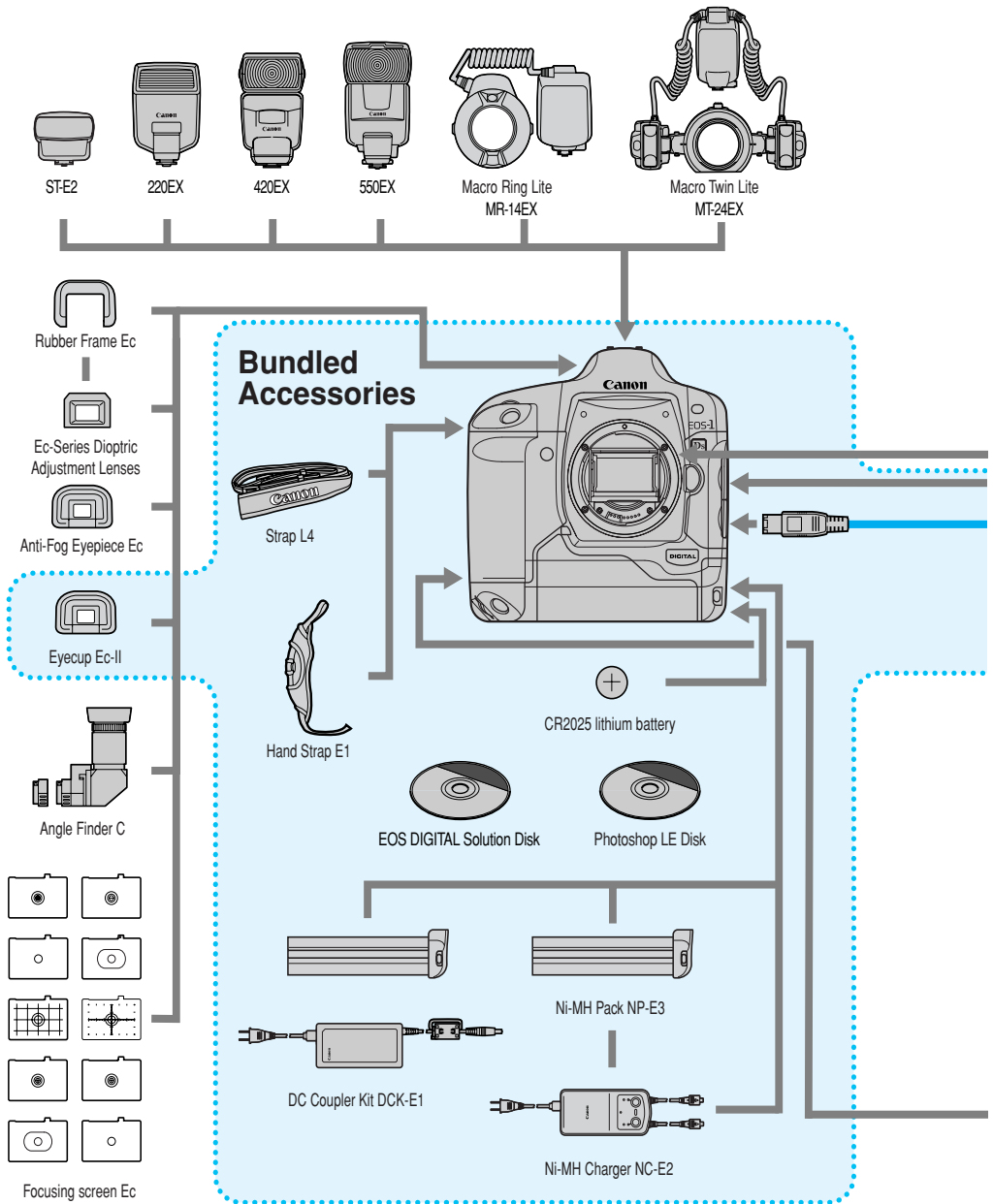

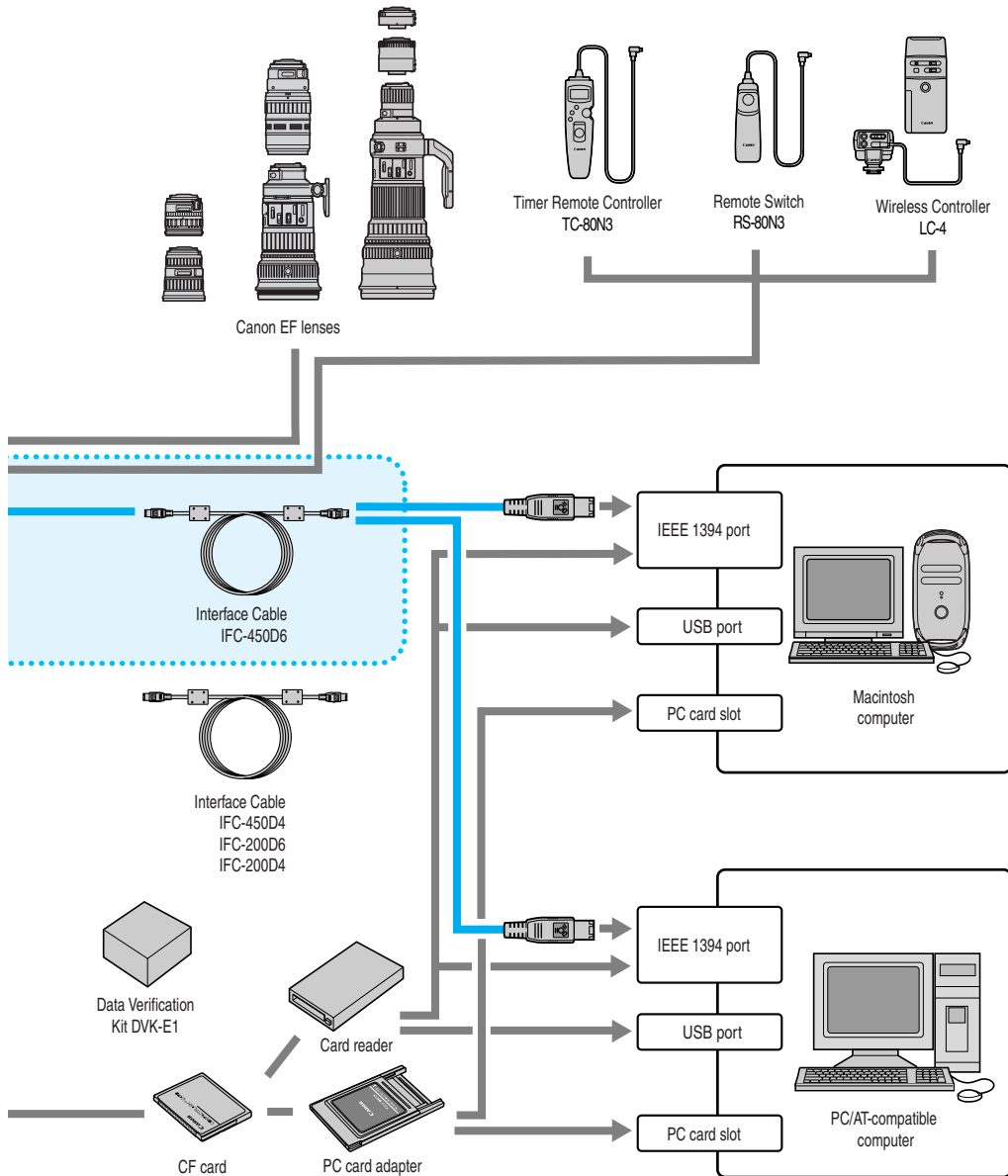

Specifications

• Type

Type	Digital AF/AE SLR
Recording medium	Type I or II CF card
Image size	35.8 x 23.8 mm (1.4 x 1 in)
Compatible lenses	Canon EF lenses (effective focal length is as marked on the lens)
Lens mount	Canon EF mount

• Imaging Element

Type	High-sensitivity, high-resolution, large single-plate CMOS sensor
Pixels	Effective pixels: Approx. 11.1 megapixels Total pixels: Approx. 11.4 megapixels
Aspect ratio	3:2
Color filter system	RGB primary color filter
Low-pass filter	Located in front of the CMOS sensor, non-removable

• Recording System

Recording format	Design rule for Camera File system (except Color Matrix 4) and RAW
Image format	JPEG, RAW (12bit)
RAW+JPEG simultaneous recording	Provided
File size	(1) Large/Fine: approx. 4.1 MB (4064x2704 pixels) (2) Large/Normal: approx. 1.7 MB (4064x2704 pixels) (3) Small/Fine: approx. 1.4 MB (2032x1352 pixels) (4) RAW: approx. 11.4 MB (4064x2704 pixels) * Exact file sizes depend on the subject and ISO speed.
Folders	Folder creation and selection enabled
File numbering	(1) Consecutive numbering (2) Auto reset (3) Manual reset
Processing parameters	Standard parameters plus up to three custom processing parameters can be set
Interface	IEEE 1394 (with dedicated cable)

• White Balance

Settings	Auto, daylight, shade, cloudy, tungsten light, fluorescent light, flash, custom, color temperature setting, personal white balance (Total 10 settings)
Auto white balance	Hybrid auto white balance with the CMOS sensor and a dedicated, external sensor
Personal white balance	Up to three personal white balance settings can be registered
Color temperature compensation	White balance bracketing: +/-3 stops in full-stop increments

• Color Matrix

Type	Two types of color space, sRGB and Adobe RGB. Preferable type is selectable out of four types of color tone in sRGB (Total 5 types).
------	--

● Viewfinder

Type	Glass pentaprism
Coverage	Approx. 100 percent vertically and horizontally with respect to the effective pixels
Magnification	0.7x (−1 diopter with 50mm lens at infinity)
Eyepoint	20 mm
Built-in dioptic correction	−3.0 - +1.0 diopter
Focusing screen	Interchangeable (9 types), Standard focusing screen: Ec-CIII
Mirror	Quick-return half mirror (Transmission:reflection ratio of 37:63, no mirror cut-off with EF 1200mm f/5.6 or shorter lens)
Viewfinder information	AF information (AF points, focus confirmation light), exposure information (shutter speed, aperture, manual exposure, metering range, ISO speed, exposure level, exposure warning), flash information (flash ready, FP flash, FE lock, flash exposure level), JPEG format, number of remaining shots, CF card information
Depth-of-field preview	Enabled with depth-of-field preview button
Eyepiece shutter	Built-in

● Autofocus

Type	TTL-AREA-SIR with a CMOS sensor
AF points	45 AF points (Area AF)
AF working range	EV 0-18 (at ISO 100)
Focusing modes	One-Shot AF AI Servo AF Manual focusing (MF)
AF point selection	Automatic selection, manual selection, home position (switch to registered AF point)
Selected AF point display	Superimposed in viewfinder and indicated on top LCD panel
AF-assist beam	AF-assist beam is emitted by the dedicated Speedlite

● Exposure Control

Metering modes	TTL full aperture metering with 21-zone SPC (1) Evaluative metering (linkable to any AF point) (2) Partial metering (approx. 8.5% of viewfinder at center) (3) Spot metering <ul style="list-style-type: none"> Center spot metering (approx. 2.4% of viewfinder at center) AF point-linked spot metering (approx. 2.4% of viewfinder) Multi-spot metering (Max. 8 spot metering entries) (4) Centerweighted average metering
Metering range	EV 0-20 (at 20°C with 50mm f/1.4 lens, ISO 100)
Exposure control systems	Program AE (shiftable), shutter-priority AE, aperture-priority AE, depth-of-field AE, E-TTL autoflash, manual, flash metered manual
ISO speed range	Equivalent to ISO 100-1250 (in 1/3-stop increments), ISO speed can be expanded to ISO 50. (C.Fn-03)
Exposure compensation	Auto exposure bracketing (AEB): +/−3 stops in 1/3-stop increments.

Specifications

	Bracketing methods
	1. Shutter speed or aperture 2. ISO speed
	Manual: +/-3 stops in 1/3-stop increments (can be combined with AEB)
AE lock	Auto: Operates in One-Shot AF mode with evaluative metering when focus is achieved.
	Manual: By AE lock button in all metering modes.

● Shutter

Type	Electronically-controlled, focal-plane shutter
Shutter speeds	1/8000 to 30 sec. (1/3-stop increments), bulb, X-sync at 1/250 sec.
Shutter release	Soft-touch electromagnetic release
Self-timer	10-sec. or 2-sec. delay.
Remote control	Remote control with N3 type contact

● Flash

EOS-dedicated Speedlite PC terminal	E-TTL autoflash with EX series Speedlite Provided
-------------------------------------	---

● Drive System

Drive modes	Single/Continuous
Continuous shooting speed	Approx. 3 fps
Max. burst during continuous shooting	10 shots
	* The maximum shots per burst depends on the subject, shooting mode, and ISO speed.

● LCD Monitor

Type	TFT color LCD monitor
Monitor size	2.0 inches
Pixels	Approx. 120,000
Coverage	100% with respect to the effective pixels
Brightness control	Adjustable to one of five levels

● Image Playback

Image display format	1. Single image with information, 2. Single image, 3. Four-image index, 4. Nine-image index, 5. Magnify (P.Fn-30)
Highlight alert	In display formats 1 and 2 above, any overexposed highlight areas will blink in the image display.

● Image Protection and Erase

Protection	Erase protection of one image, all images in a folder, or all images in the CF card can be applied or canceled at one time.
Erase	One image, all images in a folder, or all images in the CF card can be erased (except protected images) at one time.

• Sound Recording

Recording method	The voice narration recorded with the built-in microphone is attached to the image.
File format	WAV
Recording time	Max. 30 sec. per recording

• Menus

Menu categories	1. Recording menu, 2. Playback menu, 3. Set-up menu, 4. Custom/Personal Functions menu
LCD monitor language	Japanese, English, French, German, Spanish
Firmware update	Update possible by the user

• Customizing Function

Custom Functions	21 Custom Functions with 67 settings
Personal Functions	26

• Power Source

Battery	One Ni-MH Pack NP-E3 * AC power can be supplied via the AC adapter and DC coupler.
Number of shots	At 20°C: Approx. 600 At 0°C: Approx. 450 * The above figures apply when a fully-charged Ni-MH Pack NP-E3 is used.
Battery check	Automatic
Power saving	Provided. Power turns off after 1, 2, 4, 8, 15, or 30 min.
Back-up battery	One CR2025 lithium battery

• Dimensions and Weight

Dimensions (W x H x D)	156 x 157.6 x 79.9 mm / 6.1 x 6.2 x 3.1 in.
Weight	1265 g / 44.6 oz. (body only. battery: 335 g/11.8 oz.)

• Working Conditions

Working temperature range	0 - 45°C / 32 - 113°F
Working humidity	85% or lower

- All the specifications above are based on Canon's testing and measuring standards.
- The camera's specifications and physical appearance are subject to change without notice.

Index

A	
Accessories	166
AEB	94
- canceling	97
AE lock	98
AF point	64
- activation area	70
- automatic selection	65
- manual selection	65
- registration	68
- switching	69
AF point-linked spot metering	77
AF points	118
AF mode	60
AI Servo AF	62
aperture-priority AE	86
Automatic Playback	53
Av aperture-priority AE	86

B	
basic terminology	154
battery	22
- loading	23
- recharging	22
- removing	24
battery level check	23
bulb exposures	102

C	
CF card	27
- inserting	27
- removing	28
cleaning the CMOS sensor	150
color matrix	48
color temperature	44
Custom Functions	132
- canceling all	139
- Custom Function group registration ...	140
- description	133
- setting procedure	132
custom white balance	43

D	
date and time battery replacement	149
date and time setting	148
DEP depth-of-field AE	88
depth-of-field preview	87
dioptric adjustment	35

drive modes	99
-------------------	----

E	
E-TTL autoflash	107
electronic dials	30
erasing images	122
- erasing a single image	122
- erasing all images in CF card	125
- erasing all images in folder	123
error codes	160
exposure compensation	92
exposure, manual setting	90
exposure warnings	157
eyepiece shutter	101

F	
FEB	108
FE lock	109
flash exposure compensation	110
flash metered manual	112
flash photography	105
- with non-Canon flash unit	114
focusing screen	164
folder	54
- creating	54
- selecting	55
formatting of CF card	126

H	
highlight alert	118
high-speed sync (FP flash)	108
histogram	118
holding the camera	35

I	
image file number	56
- auto reset	56
- continuous numbering	57
- manual reset	58
image playback	52
- playback	115
- review	52
- review time	53
- enlargement	117
image protection	119
- canceling of all images	120

- of a single image 119
- of all images in CF card 120
- of all images in folder 120
- image recording quality 38
- image with shooting information 118
- ISO speed 49

L

- lens 26
 - detaching 26
 - mounting 26
- LCD monitor 34
- LCD panel illumination 103

M

- M manual exposure 90
- Main switch 29
- manual focusing 73
- menu 32
 - description 32
 - operation 32
 - settings 128
- metering modes 76
- messages on-screen 160
- mirror lockup 104
- modeling flash 111
- multi-spot metering 78

N

- Nomenclature 14

O

- One-Shot AF 61

P

- Personal Functions 144
 - clearing all 146
 - clearing and resetting 145
- personal white balance 45
- playback 116
- processing parameters 50
- Program AE 82
- program line 158

R

- RAW and JPEG image simultaneous recording 40

S

- self-timer 100
- shutter button 29
- shutter speed and aperture display 159
- shutter-priority AE 84
- sound recording 121
- specifications 170
- strap 36
- system map 168

T

- troubleshooting guide 162
- Tv shutter speed-priority AE 84

W

- white balance 41
- white balance bracketing 46
- wireless, multi-Speedlite flash 111



CANON INC. 30-2, Shimomaruko 3-chome, Ohta-ku, Tokyo 146-8501, Japan

U.S.A. ————— **CANON U.S.A. INC.**

For all inquiries concerning this camera, call toll free in the U.S.
1-800-OK-CANON or write to: Customer Relations, Canon U.S.A., Inc.
One Canon Plaza, Lake Success, N.Y. 11042-1198

CANADA ————— **CANON CANADA INC. HEADQUARTERS**

6390 Dixie Road, Mississauga, Ontario L5T 1P7, Canada

CANON CANADA INC. MONTREAL BRANCH

5990, Côte-de-Liesse, Montréal Québec H4T 1V7, Canada

CANON CANADA INC. CALGARY OFFICE

2828, 16th Street, N.E. Calgary, Alberta T2E 7K7, Canada

For all inquiries concerning this camera, call toll free in Canada

1-800-OK-CANON

EUROPE, ————— **CANON EUROPA N.V.**

AFRICA & Bovenkerkerweg 59-61, P.O. Box 2262, 1180 EG Amstelveen, The Netherlands

MIDDLE EAST **CANON COMMUNICATION & IMAGE FRANCE S.A.**

102, Avenue du Général de Gaulle 92257 La Garenne-Colombes Cedex, France

CANON UK LTD.

Woodhatch Reigate Surrey RH2 8BF, United Kingdom

CANON DEUTSCHLAND GmbH

Europark Fichtenhain A10, 47807 Krefeld, Germany

CANON ITALIA S.p.A.

Palazzo L, Strada 6, 20089 Rozzano, Milanofiori, Milano, Italy

CANON Schweiz AG

Geschäftsbereich Wiederverkauf, Industriestrasse 12, CH-8305 Dietlikon, Switzerland

CANON G. m. b. H.

Oberlaaerstrasse 233, 4th floor, 1100 Wien, Austria

CANON España, S. A.

C/Joaquín Costa, 41, 28002 Madrid, Spain

SEQUE Soc. Nac. de Equip., Lda.,

Praça da Alegria, 58, 2º, 1269-149 Lisboa, Portugal

CENTRAL & ————— **CANON LATIN AMERICA, INC. DEPTO DE VENTAS**

SOUTH AMERICA 703 Waterford Way Suite 400 Miami, FL 33126 U.S.A.

CANON LATIN AMERICA, INC. CENTRO DE SERVICIO Y REPARACION

Apartado 2019, Zona Libre de Colón, República de Panamá

ASIA ————— **CANON HONGKONG CO., LTD.**

9/F, The Hong Kong Club Building, 3A Chater Road, Central, Hong Kong

CANON SINGAPORE PTE. LTD.

79 Anson Road #09-01/06 Singapore 079906

OCEANIA ————— **CANON AUSTRALIA PTY. LTD.**

1 Thomas Holt Drive, North Ryde, N.S.W. 2113, Australia

CANON NEW ZEALAND LTD.

Akoranga Business Park, Akoranga Drive, Northcote Auckland, New Zealand

JAPAN ————— **CANON SALES CO., INC.**

16-6, Kohnan 2-chome, Minato-ku, Tokyo 108-8011, Japan

This Instruction Manual booklet is current as of September 2002. For information on using the camera with system accessories introduced after this date, contact your nearest Canon Service Center.

Free Manuals Download Website

<http://myh66.com>

<http://usermanuals.us>

<http://www.somanuals.com>

<http://www.4manuals.cc>

<http://www.manual-lib.com>

<http://www.404manual.com>

<http://www.luxmanual.com>

<http://aubethermostatmanual.com>

Golf course search by state

<http://golfingnear.com>

Email search by domain

<http://emailbydomain.com>

Auto manuals search

<http://auto.somanuals.com>

TV manuals search

<http://tv.somanuals.com>