

# EOS M50

## Help Guide

Wireless Features/Accessories

Wireless Features

Accessories

Learning About the Camera

Setup and Basics

Shooting

Playback

Settings

Troubleshooting

Errors and Warnings

Appendix

Index

ENGLISH







## Preliminary Notes and Legal Information

- Take and review some test shots initially to make sure the images were recorded correctly. Please note that Canon Inc., its subsidiaries and affiliates, and its distributors are not liable for any consequential damages arising from any malfunction of a camera or accessory, including memory cards, that result in the failure of an image to be recorded or to be recorded in a way that is machine readable.
- The user's unauthorized photographing or recording (video and/or sound) of people or copyrighted materials may invade the privacy of such people and/or may violate others' legal rights, including copyright and other intellectual property rights. Note that restrictions may apply even when such photographing or recording is intended solely for personal use.
- The camera warranty is valid only in the area of purchase. In case of camera problems while abroad, return to the area of purchase before contacting a Customer Support Help Desk.
- Although the screen is produced under extremely high-precision manufacturing conditions and more than 99.99% of the pixels meet design specifications, in rare cases some pixels may be defective or may appear as red or black dots. This does not indicate camera damage or affect recorded images.
- When the camera is used over an extended period, it may become warm. This does not indicate damage.

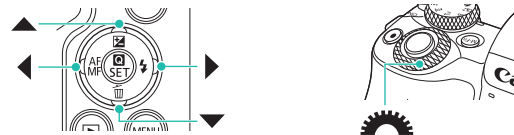
## Conventions in This Guide

- In this guide, icons are used to represent the corresponding camera buttons and dials on which they appear or which they resemble.
- The following camera buttons and controls are represented by icons.



- On-screen icons and text are indicated in brackets.
- : Important information you should know
- : Notes and tips for expert camera use
-  xx: Pages with related information (in this example, "xx" represents a page number)
- Instructions in this guide apply to the camera under default settings.
- For convenience, all lenses and mount adapters are simply referred to as "lenses" and "mount adapters," whether they are included or sold separately.
- The illustrations in this guide show the camera with the EF-M 15-45mm f/3.5-6.3 IS STM lens attached as an example.
- For convenience, all supported memory cards are simply referred to as the "memory card."

Wireless Features

Accessories

Learning About the Camera

Setup and Basics

Shooting

Playback

Settings

Troubleshooting

Errors and Warnings

Appendix

Index



## Table of Contents

Preliminary Notes and Legal Information .....	2
Conventions in This Guide .....	2

## Part 1: Wireless Features/Accessories

<b>Wireless Features .....</b>	<b>7</b>
Available Wireless Features.....	7
Preparing to Use Wireless Features .....	8
Preparing the Camera .....	8
Preparing Smartphones.....	9
Connecting to Bluetooth Enabled Smartphones via Wi-Fi .....	9
Connecting the Camera and Smartphone via Wi-Fi.....	9
Sending Images to Smartphones from the Camera Menu .....	11
Sending Images to Smartphones During Playback .....	11
Sending Images to Smartphones Automatically as You Shoot .....	11
[Bluetooth function] Screen .....	12
Geotagging Images as You Shoot.....	13
Checking Location Information.....	13
Pairing with Wireless Remote Control BR-E1 .....	14
Controlling the Camera from a Smartphone.....	14
Connecting to NFC-Compatible Smartphones via Wi-Fi.....	15
Connecting via Wi-Fi and Using the App .....	16
Sending Images to Smartphones During Playback (1).....	16
Sending Images to Smartphones During Playback (2).....	17
Sending Images to Smartphones from the Camera Menu .....	17
Sending Images to Smartphones Automatically as You Shoot .....	17

Connecting to Smartphones via Wi-Fi with the Wi-Fi Button .....	18
Sending Images to Smartphones from the Camera Menu .....	19
Sending Images to Smartphones During Playback .....	19
Sending Images to Smartphones Automatically as You Shoot .....	20
Connecting to Computers via Wi-Fi and Using EOS Utility ....	21
Connecting via Wi-Fi .....	21
Controlling the Camera from EOS Utility .....	23
Sending Images to Computers Automatically.....	23
Connecting via Wi-Fi .....	23
Sending Images on the Camera to Computers Automatically ...	24
Printing Wirelessly from Printers Connected via Wi-Fi.....	25
Connecting via Wi-Fi .....	25
Uploading Images to Web Services .....	27
Registering Web Services .....	27
Uploading Images to Web Services .....	29
Reconnecting via Wi-Fi .....	30
Connecting to Bluetooth Connected Smartphones via Wi-Fi .....	31
Changing the Nickname .....	32
Changing or Deleting Connection Settings .....	32
Restoring Default Wireless Settings.....	33
Clearing the Settings .....	33
Clearing Information of Devices Paired via Bluetooth.....	33
<b>Accessories .....</b>	<b>34</b>
System Map .....	35
Optional Accessories.....	36
Lenses .....	36
Power Supplies.....	36
Flash.....	37



Microphone.....	37
Other Accessories .....	37
Printers .....	38
Using Optional Accessories.....	38
Playback on a TV .....	38
RAW Playback on an HDR TV .....	39
Powering the Camera with Household Power .....	39
Using the Hot Shoe .....	40
Using an External Flash (Sold Separately).....	40
Using the Software .....	42
Software .....	42
Checking Your Computer Environment .....	42
Installing the Software .....	42
Saving Images to a Computer .....	43
Printing Images .....	44
Easy Print .....	44
Configuring Print Settings.....	45
Adding Images to the Print List (DPOF) .....	45
Adding Images to a Photobook .....	46

## Part 2: Learning About the Camera

<b>Setup and Basics .....</b>	<b>47</b>
Handling Precautions .....	47
Initial Preparations.....	48
Charging the Battery Pack.....	48
Inserting/Removing the Battery Pack and Memory Card .....	48
Setting the Date, Time, and Time Zone .....	48
Using a Lens.....	49
Attaching EF and EF-S Lenses .....	49
Holding the Camera.....	49
On/Off.....	49
Shutter Button .....	50

Viewfinder.....	50
Screen Angle and Orientation .....	50
Frames on the Shooting Screen.....	50
Quick Control Screen .....	50
Menu Screen.....	50
On-Screen Keyboard.....	51
Indicator Display.....	51
<b>Shooting.....</b>	<b>52</b>
Auto Mode .....	52
Shooting in Hybrid Auto Mode .....	52
Still Images .....	53
Movies .....	53
Scene Icons.....	53
Shooting with Your Favorite Settings (Creative Assist).....	54
Specific Scenes.....	54
Self Portrait .....	54
Smooth Skin .....	54
Sports .....	55
Close-up .....	55
Food .....	55
Panning .....	55
Handheld Night Scene.....	55
HDR Backlight Control.....	55
Silent Mode.....	55
Applying Special Effects.....	56
Soft Focus .....	56
Fish-Eye Effect .....	56
Toy Camera Effect.....	56
Miniature Effect.....	56
HDR Art Standard, HDR Art Vivid, HDR Art Bold, and HDR Art Embossed.....	56



Manual Mode.....	56
Setting Up Shooting from a Single Screen.....	56
Image Brightness (Exposure).....	56
Image Colors.....	58
Focusing.....	60
Flash.....	61
Other Settings.....	62
Specific Shutter Speeds and Aperture Values.....	65
Customizing the Camera.....	66
Recording Movies.....	67
Recording Movies in Movie Mode.....	67
Recording Time-Lapse Movies (Time-Lapse Movie).....	67
Miniature Model Effect in Movies (Miniature Effect Movie).....	67
Adjusting the Recording Volume.....	67
Convenient Features.....	68
Using the Self-Timer.....	68
Shooting by Touching the Screen (Touch Shutter).....	68
Continuous Shooting.....	68
Changing Image Quality.....	68
Capturing in RAW Format.....	69
Changing the Aspect Ratio.....	69
Changing Movie Image Quality.....	69
<b>Playback.....</b>	<b>70</b>
Playback.....	70
Viewing Stills and Movies.....	70
Playback Using Touch Operations.....	71
Viewing Slideshows.....	71
Viewing Digest Movies.....	71
Image Browsing and Searching.....	71
Navigating through Images in an Index.....	71
Finding Images Matching Specified Conditions.....	71
Finding Images with the Main Dial.....	72

Protecting Images.....	72
Protecting Individual Images.....	72
Protecting Multiple Images.....	72
Rating Images.....	72
Erasing Images.....	72
Erasing Multiple Images.....	72
Editing Still Images.....	73
Rotating Images.....	73
Resizing Images.....	73
Cropping.....	73
Applying Filter Effects.....	73
Correcting Red-Eye.....	73
Applying Your Favorite Effects (Creative Assist).....	73
Processing RAW Images with the Camera.....	73
Processing Multiple Images.....	74
Editing Movies.....	74
Removing the Beginning/End of Movies.....	74
Extracting Frames of 4K Movies as Stills.....	74
Reducing File Sizes.....	74
Editing Digest Movies.....	74
<b>Settings.....</b>	<b>75</b>
Adjusting Basic Camera Functions.....	75
Changing the Image Display Period after Shots.....	75
Creating or Selecting Folders.....	75
File Numbering.....	75
Formatting Memory Cards.....	76
Using Eco Mode.....	76
Power-Saving Adjustment.....	76
Customizing Shooting Information Display.....	76
Customizing Playback Information Display.....	76
Adjusting the Touch-Screen Panel.....	76
Cleaning the Image Sensor.....	77



Setting Copyright Information to Record in Images.....	77
Restoring Default Camera Settings.....	77
<b>Troubleshooting.....</b>	<b>78</b>
<b>Errors and Warnings.....</b>	<b>80</b>
<b>Part 3: Appendix</b>	
On-Screen Information.....	82
When Shooting.....	82
During Playback.....	83
Specifications.....	85
Index.....	92



## Part 1: Wireless Features/Accessories

### Wireless Features

Send images wirelessly to a variety of compatible devices, or share them via Web services.

#### Available Wireless Features

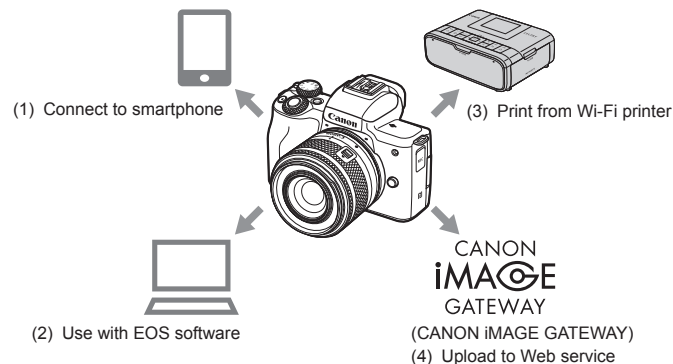

- (1) Connect to smartphone 14  
Control the camera remotely and browse images on the camera over a Wi-Fi connection by using the dedicated Camera Connect app on smartphones or tablets.  
You can also geotag images and use other features when connected by Bluetooth®\*.  
For convenience in this guide, smartphones, tablets, and other compatible devices are collectively referred to as “smartphones.”  
\* Bluetooth low energy technology (hereafter referred to as “Bluetooth”)
- (2) Use with EOS software 21, 23  
Control the camera remotely from a Wi-Fi connected computer by using EOS Utility, software used with EOS cameras. With Image Transfer Utility 2, images on the camera can also be sent to a computer automatically.
- (3) Print from Wi-Fi printer 25  
Print images over a Wi-Fi connection from printers compatible with PictBridge (wireless LAN) technology.



(4)  Upload to Web service (📖27)



Share images with friends or family on social media or the CANON IMAGE GATEWAY online photo service for Canon customers after you complete member registration (free of charge).

## Preparing to Use Wireless Features

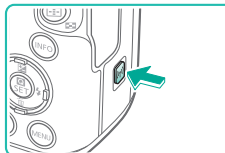
### Preparing the Camera



#### 1 With the camera on, press the button.

- If the wireless settings screen is not displayed initially when you press the  button, press the  button again.

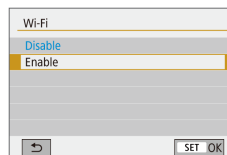

#### 2 Set Wi-Fi to [Enable].

- Choose [Enable] and press the  button.
- A message about nicknames is displayed.

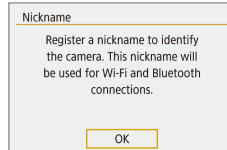

#### 3 Check the [Nickname] setting.

- Press the  button and check the nickname (camera name).







## ■ Steps on the Smartphone (1)



### 5 On the smartphone, turn on Bluetooth.



### 6 Start Camera Connect.



### 7 Choose the camera to pair with.

- Touch the nickname of the camera to pair with.
- In Android, go to step 9.



### 8 Touch [Pair] (iOS only).

## ■ Steps on the Camera (2)

### 9 On the camera, complete the pairing process.

- Choose [OK] when a pairing confirmation message is displayed.
- On the pairing notification screen, press the  button.
- Pairing is now complete, and the camera is connected to the smartphone via Bluetooth.
- Go to the next step and establish a Wi-Fi connection.

## ■ Steps on the Smartphone (2)

- In Android



### 1 Choose a Camera Connect function.

- Choose a function other than [Bluetooth remote controller].
- In a moment, a Wi-Fi connection is established, and a screen for the selected function is displayed on the smartphone.
- [Wi-Fi on] is displayed on the camera.

- In iOS



### 1 Choose a Camera Connect function.

- Choose a function other than [Bluetooth remote controller].



### 2 Use the smartphone to connect via Wi-Fi.

- Touch the button displayed on the smartphone to copy the password, as instructed.
- In the Wi-Fi settings displayed, choose the SSID of the camera to connect to.
- Touch the password field and paste the password to establish a connection.
- Display the Camera Connect screen.
- In a moment, a Wi-Fi connection is established, and a screen for the selected function is displayed on the smartphone.
- [Wi-Fi on] is displayed on the camera.



### 3 Use Camera Connect.

- Use Camera Connect to shoot remotely, browse images on the camera, or save them to the smartphone.



## Sending Images to Smartphones from the Camera Menu

Before following these steps, make sure the camera and smartphone are connected via Wi-Fi (📶).

### 1 Access the menu.

- Press the **MENU** button and choose [📷] → [📱] → [Wireless communication settings] → [Send images to smartphone].
- Images are displayed.

### 2 Access the top screen in Camera Connect.

### 3 Choose an image.

- Choose an image and press the (📷) button.
- After you choose other sending options on the screen displayed, the image is sent to the smartphone.

## Sending Images to Smartphones During Playback

Before following these steps, make sure the camera and smartphone are connected via Wi-Fi (📶).

### 1 Play back images.

### 2 Press the (📷) button.

### 3 Choose [📱].



### 4 Choose an image.

- Choose an image and press the (📷) button.
- After you choose other sending options on the screen displayed, the image is sent to the smartphone.

## Sending Images to Smartphones Automatically as You Shoot

Your shots can be sent automatically. Before following these steps, make sure the camera and smartphone are connected via Wi-Fi (📶).

### 1 Choose [Send to smartphone after shot].

- Press the **MENU** button and choose [📷] → [📱] → [Wireless communication settings] → [Wi-Fi settings] → [Send to smartphone after shot].

### 2 Set up automatic sending.

- Set [Auto send] to [Enable].
- Choose a size in [Size to send].

### 3 Access the top screen in Camera Connect.

### 4 Shoot.

- As long as the devices are connected via Wi-Fi, your shots will be sent to the smartphone.



## Specifying Viewable Images

- Specify which images can be viewed on smartphones as follows. Temporarily disconnect the devices. Press the (ⓘ) button and choose [Disconnect,exit] → [OK].  
With the camera on, press the (ⓘ) button and choose [📱] → [Edit device information] → smartphone name → [Viewable imgs]. Specify viewable images on the screen displayed.
- If remote live view shooting is not possible in Camera Connect despite the Wi-Fi connection, choose [All images] as described above.



- Battery life may be shorter when you use the camera after pairing, because power is consumed even when power saving is active.

## [Bluetooth function] Screen

### Bluetooth function

- Choose a device to pair with the camera.
- Choose [Disable] if you will not use Bluetooth.

### Pairing

- Pair the camera with the device selected in [Bluetooth function].

### Check/clear connection info

- Enables you to check the name and connection status of paired devices.
- Before pairing with another smartphone, clear the connection information for the device currently paired via Bluetooth (📱33).

### Bluetooth address

- Enables you to check the camera's Bluetooth address.

## Stay connected if the camera is turned off

- Selecting [Enable] lets you view images on the camera and control it in other ways via Wi-Fi when it is off.



- This feature is not available unless the camera and smartphone are paired via Bluetooth.





## Geotagging Images as You Shoot

Your shots can be geotagged using GPS information (such as latitude, longitude, and elevation) from a Bluetooth enabled smartphone.

### 1 Pair the camera and smartphone via Bluetooth.

- Follow the steps in “Steps on the Camera (1)”, “Steps on the Smartphone (1)”, and “Steps on the Camera (2)” in “Connecting to Bluetooth Enabled Smartphones via Wi-Fi” (19).
- You can skip these steps if the devices are already paired.

### 2 End the Wi-Fi connection.

- If the camera is connected via Wi-Fi, end the connection.

### 3 Start Camera Connect.

- Keep the smartphone running Camera Connect within arm's reach.

### 4 Turn on GPS.

- Press the **MENU** button and choose [GPS] → [GPS settings].
- Set [GPS via mobile] to [Enable].



### 5 Shoot.

- Before shooting, confirm that [GPS] and [GPS] icons are shown on the camera. If the icons are not shown, press the **INFO** button repeatedly.
- Your shots are now geotagged.
- From now on, shots you take with Camera Connect running will be geotagged.

### Checking Location Information

- To customize which screen shows latitude, longitude, elevation, and UTC, access the [Playback information display] screen: **MENU** button → [INFO] → [INFO4]. Press the **INFO** button during image playback to view this information.
- The date and time of UTC is essentially the same as Greenwich Mean Time.
- Using the Map Utility program, you can display the location information on a map.



- The GPS information added to your movie is acquired initially, when you start recording.
- Images may not be geotagged if you connect via NFC or Bluetooth when the camera is off.
- Others may be able to locate or identify you by using location data in your geotagged still images or movies. Be careful when sharing these images with others, as when posting images online where many others can view them.



## Pairing with Wireless Remote Control BR-E1

To prepare for using an optional BR-E1, pair the devices as follows. Also refer to the BR-E1 instruction manual.

### 1 Pair the devices.

- Press the **MENU** button and choose [1] → [1] → [Wireless communication settings] → [Bluetooth function] (twice) → [Remote] → [Pairing] → [ ] button.

### 2 Hold down both the W and T buttons on the BR-E1 for at least three seconds.

- The devices are now paired.

### 3 Set up the camera for remote shooting.

- Stills: Set the drive mode to [Self-timer: 10sec/remote].
- Movies: **MENU** button → [ ] → [1] → [Remote control] → [Enable] → [ ] button.



- Auto power off is triggered in about two minutes, even if you have set it for one minute.
- For details on clearing pairing settings, see 33.

## Controlling the Camera from a Smartphone

You can control the camera by using a Bluetooth enabled smartphone as a remote control.



### 1 Pair the camera and smartphone via Bluetooth.

- Follow the steps in “Steps on the Camera (1)”, “Steps on the Smartphone (1)”, and “Steps on the Camera (2)” in “Connecting to Bluetooth Enabled Smartphones via Wi-Fi” (9).
- You can skip these steps if the devices are already paired.

### 2 End the Wi-Fi connection.

- End any Wi-Fi connection between the camera and smartphone.

### 3 Control the camera from the smartphone.

- In Camera Connect, touch [Bluetooth remote controller].
- Shoot or play back images on the control screen displayed. Watch the simulated camera screen as you control the camera.



- If the camera temporarily overheats during extended 4K recording, is displayed and recording stops. At this time, movie recording will be unavailable, even if you press the movie button.

Following the instructions displayed, either choose a movie recording size other than or turn off the camera to let it cool down before you resume recording.

- Using Bluetooth functions consumes battery power even after auto power off turns the camera off. To turn Bluetooth off when it is not needed, press the **MENU** button and choose → → [Wireless communication settings] → [Bluetooth function] (twice) → [Disable].

## Connecting to NFC-Compatible Smartphones via Wi-Fi

Using NFC on Android smartphones with this feature is an easy way to connect to the camera.



- Turn Bluetooth off by pressing the **MENU** button and choosing → → [Wireless communication settings] → [Bluetooth function] (twice) → [Disable].
- When using NFC, keep the following points in mind.
  - Avoid strong impact between the camera and smartphone. This may damage the devices.
  - Depending on the smartphone, the devices may not recognize each other immediately. In this case, try holding the devices together in slightly different positions. If a connection is not established, keep the devices together until the camera screen changes.
  - Do not place other objects between the camera and smartphone. Also, note that camera or smartphone covers or similar accessories may block communication.



- Connections require that a memory card be in the camera.
- To disable NFC connections, choose tab → [Wireless communication settings] → [Wi-Fi settings] → [NFC connection] → [Disable].



## Connecting via Wi-Fi and Using the App

### 1 Prepare to use wireless features.

- See “Preparing to Use Wireless Features” (8) (or when finished, go to the next step).

### 2 Turn on NFC on the camera and smartphone.

- To turn on NFC on the camera, press the **MENU** button and choose [F1] → [F1] → [Wireless communication settings] → [Wi-Fi settings] → [NFC connection] → [Enable].

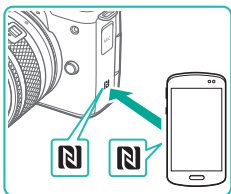

### 3 Establish the connection.

- Touch the N-Mark (N) on the smartphone with Camera Connect installed against the camera's N-Mark.
- By touching the devices together during image playback, you can choose images on the camera to send to the smartphone.
- Camera Connect starts up on the smartphone, and a connection is established.

### 4 Adjust the privacy setting.

- When the screen at left is displayed, choose [All images] and press the **OK** button.
- [Wi-Fi on] is displayed on the camera.

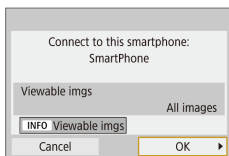

### 5 Use Camera Connect.

- Use Camera Connect to shoot remotely, browse images on the camera, or save them to the smartphone.

## Sending Images to Smartphones During Playback (1)

When you are viewing images on the camera, touch it against the smartphone to send images to the smartphone.

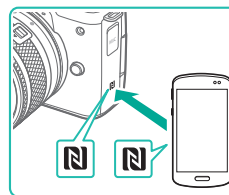

### 1 Play back images.

### 2 Establish the connection.

- Touch the N-Mark (N) on the smartphone with Camera Connect installed against the camera's N-Mark.

### 3 Choose an image.

- Choose an image and press the **OK** button.
- After you choose other sending options on the screen displayed, the image is sent to the smartphone.





## Sending Images to Smartphones During Playback (2)

When you are not viewing images, use NFC to connect the camera and smartphone via Wi-Fi.

### 1 Play back images.

### 2 Press the button.

### 3 Choose .



### 4 Choose an image.

- Choose an image and press the  button.
- After you choose other sending options on the screen displayed, the image is sent to the smartphone.

## Sending Images to Smartphones from the Camera Menu

When you are not viewing images, use NFC to connect the camera and smartphone via Wi-Fi.

### 1 Choose [Send images to smartphone].

- Press the **MENU** button and choose  →  → [Wireless communication settings] → [Send images to smartphone].
- Images are displayed.



### 2 Choose an image.

- Choose an image and press the  button.
- After you choose other sending options on the screen displayed, the image is sent to the smartphone.

## Sending Images to Smartphones Automatically as You Shoot

Your shots can be automatically sent to a smartphone connected via Wi-Fi. (Does not apply to movies.) When you are not viewing images, use NFC to connect the camera and smartphone via Wi-Fi.

### 1 Choose [Send to smartphone after shot].

- Press the **MENU** button and choose  →  → [Wireless communication settings] → [Wi-Fi settings] → [Send to smartphone after shot].

### 2 Set up automatic sending.

- Set [Auto send] to [Enable].
- Choose a size in [Size to send].

### 3 Access the top screen in Camera Connect.

### 4 Shoot.

- As long as the devices are connected via Wi-Fi, your shots will be sent to the smartphone.



## Specifying Viewable Images

- Specify which images can be viewed on smartphones as follows. Temporarily disconnect the devices. Press the (P) button and choose [Disconnect,exit] → [OK]. With the camera on, press the (P) button and choose [ ] → [Edit device information] → smartphone name → [Viewable imgs]. Specify viewable images on the screen displayed.
- If remote live view shooting is not possible in Camera Connect despite the Wi-Fi connection, choose [All images] as described above.

## Connecting to Smartphones via Wi-Fi with the Wi-Fi Button

### Steps on the Camera (1)

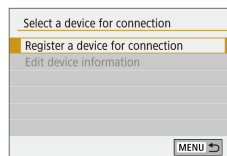
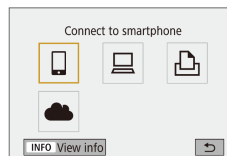

#### SSID (Network name)

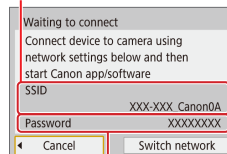

Password

### 1 Prepare to use wireless features.

- See “Preparing to Use Wireless Features” (8) (or when finished, go to the next step).

### 2 With the camera on, press the (P) button.

- Choose [ ].

### 3 Choose [Register a device for connection].

- Choose [Register a device for connection] → [Do not display].

### 4 Check the SSID and password.

- The SSID ends with \_Canon0A.



## Steps on the Smartphone



### 5 Connect the smartphone to the network.

- In the smartphone's Wi-Fi setting menu, choose the SSID (network name) displayed on the camera to establish a connection.
- In the password field on the smartphone, enter the password displayed on the camera.



### 6 Start Camera Connect.

- After [Start Canon app/software on the smartphone] is displayed on the camera, Camera Connect starts up on the smartphone.



### 7 Select the camera to connect to.

- In the [Cameras] list in Camera Connect, touch the camera to connect to via Wi-Fi.

## Steps on the Camera (2)



### 8 Establish a Wi-Fi connection.

- Choose [OK] and press the button.
- [Wi-Fi on] is displayed on the camera.

### 9 Use Camera Connect.

- Use Camera Connect to shoot remotely, browse images on the camera, or save them to the smartphone.

## Sending Images to Smartphones from the Camera Menu

Before following these steps, make sure the camera and smartphone are connected via Wi-Fi ( 18).

### 1 Access the menu.

- Press the **MENU** button and choose → → [Wireless communication settings] → [Send images to smartphone].
- Images are displayed.

### 2 Choose an image.

- Choose an image and press the button.
- After you choose other sending options on the screen displayed, the image is sent to the smartphone.

## Sending Images to Smartphones During Playback

Before following these steps, make sure the camera and smartphone are connected via Wi-Fi ( 18).

### 1 Play back images.

### 2 Press the button.

### 3 Choose .

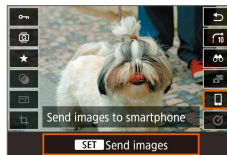



#### 4 Choose an image.

- Choose an image and press the  button.
- After you choose other sending options on the screen displayed, the image is sent to the smartphone.

### Sending Images to Smartphones Automatically as You Shoot

Your shots can be automatically sent to a smartphone connected via Wi-Fi. (Does not apply to movies.) When you are not viewing images, connect the camera and smartphone via Wi-Fi ( 18).

#### 1 Choose [Send to smartphone after shot].

- Press the **MENU** button and choose  →  → [Wireless communication settings] → [Wi-Fi settings] → [Send to smartphone after shot].

#### 2 Set up automatic sending.



- Set [Auto send] to [Enable].
- Choose a size in [Size to send].

#### 3 Access the top screen in Camera Connect.

#### 4 Shoot.

- As long as the devices are connected via Wi-Fi, your shots will be sent to the smartphone.

#### Specifying Viewable Images

- Specify which images can be viewed on smartphones as follows. Temporarily disconnect the devices. Press the  button and choose [Disconnect,exit] → [OK]. With the camera on, press the  button and choose  → [Edit device information] → smartphone name → [Viewable imgs]. Specify viewable images on the screen displayed.
- If remote live view shooting is not possible in Camera Connect despite the Wi-Fi connection, choose [All images] as described above.



#### Establishing a Connection via an Access Point

Connect the devices near the access point, because you will need to press the WPS button.

#### 1 Prepare to use wireless features.

- See "Preparing to Use Wireless Features" ( 8) (or when finished, go to the next step).

#### 2 Choose [WPS (PBC mode)].

- Press the **MENU** button and choose  →  → [Wireless communication settings] → [Wi-Fi function] →  → [Register a device for connection] → [Do not display] → [Switch network] → [Connect with WPS] → [WPS (PBC mode)] → [OK] → [OK].

#### 3 Press the WPS button on the access point.

#### 4 Choose [Auto setting] on the camera's [IP address set.] screen.

- Connection is now attempted between the camera and access point.



- 5** After a connection is established, go to step 6 in “Connecting to Smartphones via Wi-Fi with the Wi-Fi Button” (📖 18).

## Connecting to Computers via Wi-Fi and Using EOS Utility

Control the camera remotely from a Wi-Fi connected computer by using EOS Utility, software used with EOS cameras. Install EOS Utility on the computer before configuring the settings to connect via Wi-Fi.

### Connecting via Wi-Fi

#### Steps on the Camera (1)

**1 Prepare to use wireless features.**

- See “Preparing to Use Wireless Features” (📖 8) (or when finished, go to the next step).

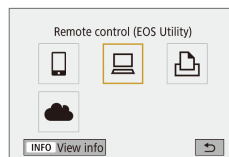

**2 With the camera on, press the (P) button.**

- Choose [📄].

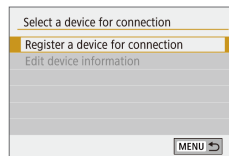

**3 Choose [Register a device for connection].**



SSID (Network name)

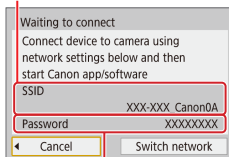

Password

#### 4 Check the SSID and password.

#### Steps on the Computer (1)



#### 5 Connect the computer to the network.

- In the computer's Wi-Fi settings, choose the SSID (network name) displayed on the camera to establish a connection.
- In the password field on the computer, enter the password displayed on the camera.

#### Steps on the Camera (2)

#### 6 Pair the devices.

- After password authentication on the computer, [Start pairing devices] is displayed on the camera.
- Choose [OK], press the  button, and start EOS Utility.

#### Steps on the Computer (2)



#### 7 Start EOS Utility.

#### 8 In EOS Utility, click [Pairing over Wi-Fi/LAN].

- The EOS Pairing Software window is displayed.

#### 9 Click [Connect].

- Choose the camera to connect to and click [Connect].

#### Steps on the Camera (3)

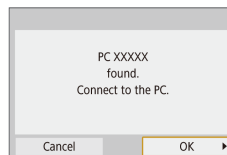

#### 10 Establish a Wi-Fi connection.

- Choose [OK] and press the  button.
- [Wi-Fi on] is displayed on the camera.
- The camera and computer are now connected via Wi-Fi.



## Establishing a Connection via an Access Point

Connect the devices near the access point, because you will need to press the WPS button.

### 1 Choose [WPS (PBC mode)].

- Press the **MENU** button and choose **[Wi-Fi]** → **[Wi-Fi 1]** → [Wireless communication settings] → [Wi-Fi function] → **[Wi-Fi]** → [Register a device for connection] → [Switch network] → [Connect with WPS] → [WPS (PBC mode)] → [OK] → [OK].

### 2 Press the WPS button on the access point.

### 3 Choose [Auto setting] on the camera's [IP address set.] screen.

- Connection is now attempted between the camera and access point.

### 4 After a connection is established, go to “Steps on the Camera (2)” (p. 22).

## Controlling the Camera from EOS Utility

For details on using EOS Utility, refer to the EOS Utility instruction manual. Remote shooting is only one of the many camera operations available.

## Sending Images to Computers Automatically

Images on the camera can be sent to a computer automatically.

- Connect the computer running the dedicated Image Transfer Utility 2 program to the access point that the camera will connect to via Wi-Fi.
- Connect the devices near the access point, because you will need to press the WPS button.

## Connecting via Wi-Fi

### Steps on the Computer (1)

#### 1 Start Image Transfer Utility 2.

#### 2 In Image Transfer Utility 2, access the pairing settings screen.

- The screen to set up pairing is shown when you follow the instructions displayed the first time Image Transfer Utility 2 starts up.

### Steps on the Camera (1)

#### 3 Prepare to use wireless features.

- See “Preparing to Use Wireless Features” (p. 8) (or when finished, go to the next step).

#### 4 Choose [Auto send images to computer].

- Press the **MENU** button and choose **[Wi-Fi]** → **[Wi-Fi 1]** → [Wireless communication settings] → [Wi-Fi settings] → [Auto send images to computer].



## 5 Connect to the computer via Wi-Fi.

- Choose [Auto send] → [Enable].
- Choose [OK] and press the  button.
- Choose [Connect with WPS] → [WPS (PBC mode)] → [OK] → [OK].

### ■ Steps on the Access Point

## 6 Press the WPS button.

- Press the WPS button on the access point to allow the camera to connect.

### ■ Steps on the Camera (2)

## 7 Choose a computer.

- Names of computers you can connect to are displayed.
- Choose a computer to connect to.

### ■ Steps on the Computer (2)

## 8 Choose the camera to pair with.



- Camera nicknames are shown on the pairing screen in Image Transfer Utility 2.
- Choose the camera to connect to and click [Pairing] to connect the computer and camera.

## Sending Images on the Camera to Computers Automatically

### 1 Prepare to use wireless features.

- See “Preparing to Use Wireless Features” (📖8) (or when finished, go to the next step).

### 2 On the camera, choose [Image sending options].

- Press the **MENU** button and choose  →  → [Wireless communication settings] → [Wi-Fi settings] → [Auto send images to computer] → [Image sending options].
- Select or specify the items displayed.

### 3 Send the images to the computer automatically.

- Make sure you are logged in to the computer connected to the access point.
- Turn on the camera, within range of the access point.
- Images are automatically sent to the computer, following the sending options you set in step 2.



- When using auto image transfer, ensure that the battery pack has sufficient charge. Auto power off is disabled during auto image transfer.
- Any images captured after auto image transfer are not sent to the computer then. They are sent automatically when the camera is restarted.







- Auto image transfer to a computer is triggered by camera startup within range of the access point. If auto image transfer does not begin automatically, try restarting the camera.

## Disabling Auto Image Transfer

To stop sending images automatically, press the **MENU** button and choose [F] → [F1] → [Wireless communication settings] → [Wi-Fi settings] → [Auto send images to computer] → [Auto send] → [Disable].

## Printing Wirelessly from Printers Connected via Wi-Fi

### Connecting via Wi-Fi

#### 1 Prepare to use wireless features.

- See “Preparing to Use Wireless Features” (18) (or when finished, go to the next step).

#### 2 With the camera on, press the (P) button.

#### 3 Choose [P].



#### 4 Choose [Register a device for connection].

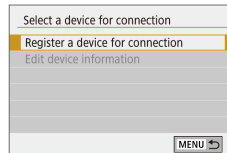

#### 5 Check the SSID and password.

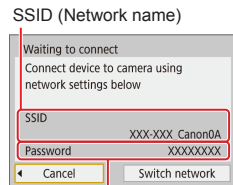

Password



## 6 Use the printer to connect to the camera via Wi-Fi.

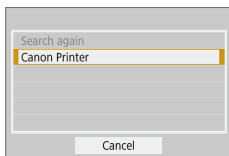

- In the printer's Wi-Fi setting menu, choose the SSID (network name) displayed on the camera to establish a connection.
- In the password field on the printer, enter the password displayed on the camera.



## 7 Choose the printer to connect to via Wi-Fi.

- Choose the printer to use and press the  button.
- Images on the memory card are displayed after the devices are connected via Wi-Fi.

## 8 Choose an image to print.



- Choose an image and press the  button.
- Select or specify the items displayed, and then print ( 44).



## Establishing a Connection via an Access Point

Connect the devices near the access point, because you will need to press the WPS button.

### 1 Choose [WPS (PBC mode)].

- Press the **MENU** button and choose  →  → [Wireless communication settings] → [Wi-Fi function] →  → [Register a device for connection] → [Switch network] → [Connect with WPS] → [WPS (PBC mode)] → [OK] → [OK].

### 2 Press the WPS button on the access point.

### 3 Choose [Auto setting] on the camera's [IP address set.] screen.

- Connection is now attempted between the camera and access point.

### 4 After a connection is established, go to step 7 in "Connecting via Wi-Fi" ( 25).



## Uploading Images to Web Services

### Registering Web Services

Use a smartphone or computer to add your Web services to the camera.

- A smartphone or computer with a browser and Internet connection is required to complete camera settings for CANON iMAGE GATEWAY and other Web services.
- Check the CANON iMAGE GATEWAY website for details on browser (Microsoft Internet Explorer, etc.) requirements, including settings and version information.
- For information on countries and regions where CANON iMAGE GATEWAY is available, visit the Canon website (<http://www.canon.com/cig/>).
- For CANON iMAGE GATEWAY instructions and setting details, refer to the help information for CANON iMAGE GATEWAY.
- To use Web services other than CANON iMAGE GATEWAY, you must have an account with them. For further details, check the websites for each Web service you want to register.
- Separate ISP connection and access point fees may apply.

### Registering CANON iMAGE GATEWAY

Connect the devices near the access point, because you will need to press the WPS button.

Link the camera and CANON iMAGE GATEWAY by adding CANON iMAGE GATEWAY as a destination Web service on the camera. Note that you will need to enter an email address used on your computer or smartphone to receive a notification message for completing linkage settings.

#### 1 Prepare to use wireless features.

- See “Preparing to Use Wireless Features” (8) (or when finished, go to the next step).

#### 2 With the camera on, press the (P) button.

#### 3 Choose [☁].

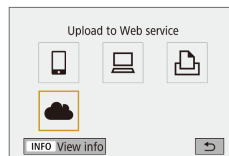

#### 4 Accept the agreement to enter an email address.

- Read the agreement displayed and choose [I Agree].

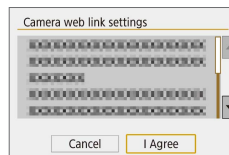

## 5 Establish a connection with an access point.

- Choose [Connect with WPS] → [WPS (PBC mode)] → [OK] → [OK].
- Press the WPS button on the access point.
- Choose [Auto setting] on the camera's [IP address set.] screen to connect the camera to the access point.

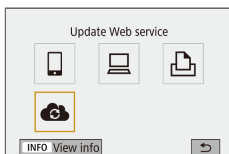
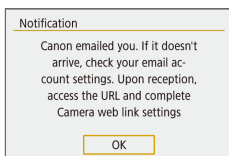
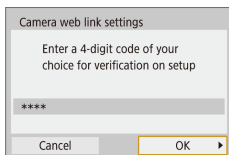
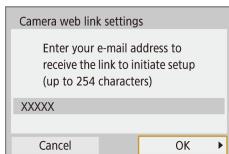



## 6 Enter your email address.

- Once the camera is connected to CANON iMAGE GATEWAY, a screen is displayed for entering an email address.
- Enter your email address and continue.

## 7 Enter a four-digit number.

- Enter a four-digit number of your choice and continue.
- You will need this four-digit number later when setting up linkage with CANON iMAGE GATEWAY in step 9.

## 8 Check for the notification message.



- Once information has been sent to CANON iMAGE GATEWAY, you will receive a notification message at the email address entered in step 6.
- Press the  button on the next screen, which indicates that notification has been sent.
-  now changes to .



## 9 Access the page in the notification message and complete camera link settings.

- From a computer or smartphone, access the page linked in the notification message.
- Follow the instructions to complete the settings on the camera link settings page.

## 10 Complete CANON iMAGE GATEWAY settings on the camera.

- Choose  and press the  button.
- CANON iMAGE GATEWAY has now been added as a destination Web service.

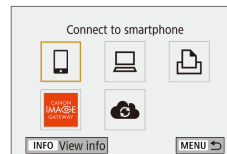

- Make sure initially that your computer or smartphone mail application is not configured to block email from relevant domains, which may prevent you from receiving the notification message.



## Registering Other Web Services

You can also add Web services besides CANON iMAGE GATEWAY to the camera.



### 1 Log in to CANON iMAGE GATEWAY and access the camera link settings page.

- From a computer or smartphone, access <http://www.canon.com/cig/> to visit CANON iMAGE GATEWAY.



### 2 Configure the Web service you want to use.

- Follow the instructions displayed on the smartphone or computer to set up the Web service.

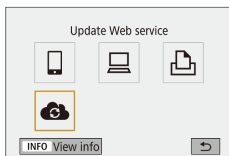

### 3 Choose [📶].

- Press the (Fn) button to choose [📶].



- If any configured settings change, follow these steps again to update the camera settings.

## Uploading Images to Web Services

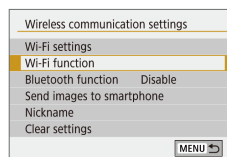

### 1 Choose [Wi-Fi function].

- Press the (Fn) button.

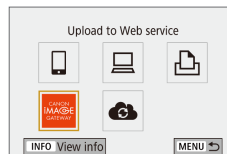

### 2 Choose the destination.

- Choose a Web service icon and press the (Fn) button.
- If multiple recipients or sharing options are used with a Web service, choose an item on the screen displayed for selecting recipients, and then press the (Fn) button.



### 3 Send an image.

- Choose sending options and upload the image.
- When uploading to YouTube, read the terms of service, choose [I Agree], and press the (Fn) button.
- After the image is sent, [OK] is displayed. Press the (Fn) button to return to the playback screen.



- To view images uploaded to CANON iMAGE GATEWAY on a smartphone, try the dedicated Canon Online Photo Album app. Download and install the Canon Online Photo Album app for iPhones or iPads from the App Store or for Android devices from Google Play.





## Reconnecting via Wi-Fi

Reconnecting to devices or Web services via Wi-Fi is possible once the connection settings are registered.

### 1 With the camera on, press the (P) button.

### 2 Choose an item.

- From the past connections shown, choose an item to connect to via Wi-Fi and press the (P) button. If the item is not shown, press the ◀/▶ buttons to switch to other screens.
- No past connections are displayed if [Connection history] is set to [Hide].

#### Web Services

- Step 3 is not necessary.

### 3 Prepare the other device.

#### Smartphones

- On the smartphone, turn on Wi-Fi and start Camera Connect.
- If the smartphone's settings were changed to connect to other devices, restore the settings to connect to the camera or the camera's access point via Wi-Fi.
- In direct Wi-Fi connections between the camera and smartphones, the SSID ends with \_Canon0A.

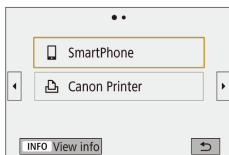

#### EOS Utility

- Start EOS Utility on the computer.
- If the computer's settings were changed to connect to other devices, restore the settings to connect to the camera or the camera's access point via Wi-Fi.
- In direct Wi-Fi connections between the camera and computers, the SSID ends with \_Canon0A.

#### Printers

- If the printer's settings were changed to connect to other devices, restore the settings to connect to the camera or the camera's access point via Wi-Fi.
- In direct Wi-Fi connections between the camera and printers, the SSID ends with \_Canon0A.

## Connecting to Bluetooth Connected Smartphones via Wi-Fi

Reconnect via Wi-Fi to a smartphone already paired via Bluetooth as follows.

### In Android



#### 1 Start Camera Connect.

- Touch the Camera Connect icon on the smartphone to start the app.



#### 2 Choose a Camera Connect function.

- Choose a Camera Connect function to use.
- A connection is established automatically. After the devices are connected, a screen for the selected function is displayed.

### In iOS



#### 1 Start Camera Connect.



#### 2 Choose a Camera Connect function.



### 3 Use the smartphone to connect via Wi-Fi.

- Touch the button displayed on the smartphone to copy the password, as instructed.
- In the Wi-Fi settings displayed, choose the SSID of the camera to connect to.
- Touch the password field and paste the password to establish a connection.
- Display the Camera Connect screen.
- In a moment, a Wi-Fi connection is established, and a screen for the selected function is displayed on the smartphone.
- [Wi-Fi on] is displayed on the camera.



## Changing the Nickname

Change the nickname as needed.

### 1 Access the nickname screen.

- Press the **MENU** button and choose [F] → [F1] → [Wireless communication settings] → [Nickname] → [OK] button.

### 2 Change the nickname.

- Use the keyboard displayed to change the nickname.

## Changing or Deleting Connection Settings

Connection settings saved on the camera can be changed or deleted. Before changing or deleting connection settings, end the Wi-Fi connection.

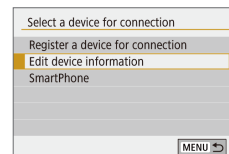
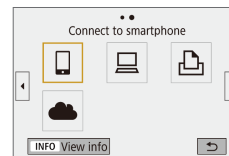
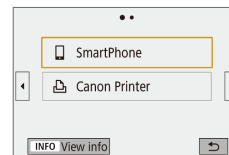

### 1 With the camera on, press the (F) button.

### 2 Choose an item.

- On the screen shown at left, you can switch to other screens by pressing the ◀/▶ buttons.

- On the screen at left, choose an item with connection settings to delete or change.

### 3 Choose [Edit device information].

- On the screen displayed, choose a device with connection settings to change or delete, and then change or delete the settings.





## Restoring Default Wireless Settings

All wireless settings can be cleared. This can prevent the information from being leaked if you lend the camera or transfer ownership.

### Clearing the Settings

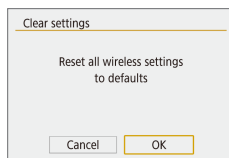

- Press the **MENU** button and choose **[F1]** → **[F1]** → [Wireless communication settings] → [Clear settings] → [OK].

## Clearing Information of Devices Paired via Bluetooth

Before pairing with a different smartphone, clear the information about any connected smartphones.

### Steps on the Camera

- Press the **MENU** button and choose **[F1]** → **[F1]** → [Wireless communication settings] → [Bluetooth function] → [Check/clear connection info] → **INFO** button → [OK] → **[F1]** button.

### Steps on the Smartphone

- In the Bluetooth setting menu on the smartphone, clear the camera information registered on the smartphone.



## Accessories

Enjoy the camera in more ways with optional Canon accessories and other compatible accessories sold separately.

### Use of genuine Canon accessories is recommended.

This product is designed to achieve excellent performance when used with genuine Canon accessories.

Canon shall not be liable for any damage to this product and/or accidents such as fire, etc., caused by the malfunction of non-genuine Canon accessories (e.g., a leakage and/or explosion of a battery pack). Please note that any repairs your Canon product may require as a result of such malfunction are not covered under warranty and will incur a fee.



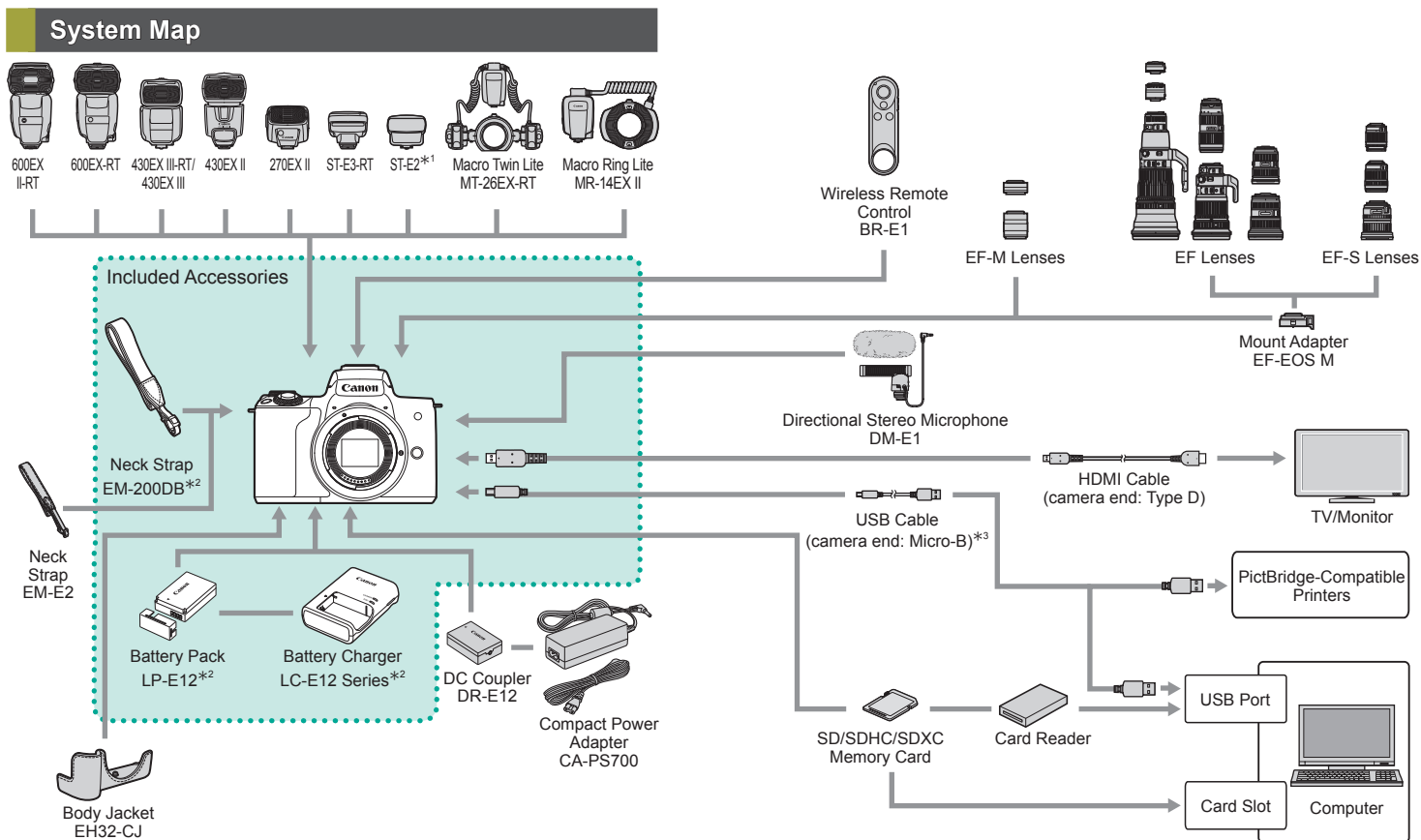

\*1 With some lenses, Off-Camera Shoe Cord OC-E3 may be required.

\*2 Also available for purchase separately.

\*3 A genuine Canon accessory is also available (Interface Cable IFC-600PCU).



## Optional Accessories

The following camera accessories are sold separately. Note that availability varies by area, and some accessories may no longer be available.

### Lenses

#### EF-M, EF, and EF-S Lenses

- Switch lenses to suit the subject or your preferred shooting style. Note that EF and EF-S lenses require Mount Adapter EF-EOS M.

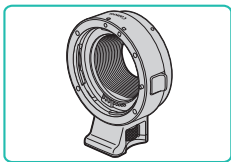

#### Mount Adapter EF-EOS M

- Use this mount adapter when attaching EF or EF-S lenses.

### Power Supplies

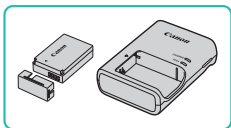

#### Battery Pack LP-E12

- Rechargeable lithium-ion battery

#### Battery Charger LC-E12 Series

- Charger for Battery Pack LP-E12



- The battery pack includes a convenient cover which you can attach to know the charge status at a glance. Attach the cover so that ▲ is visible on a charged battery pack, and attach it so that ▲ is not visible on an uncharged battery pack.

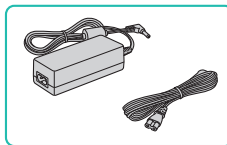

#### Compact Power Adapter CA-PS700

- For powering the camera using household power. Recommended when using the camera over extended periods, or when connecting the camera to a printer or computer. Cannot be used to charge the battery pack in the camera.

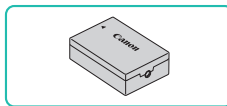

#### DC Coupler DR-E12

- Used with a compact power adapter.



- The battery charger and compact power adapter can be used in areas with 100 – 240 V AC power (50/60 Hz).
- For power outlets in a different format, use a commercially available adapter for the plug. Never use an electrical transformer designed for traveling, which may damage the battery pack.



## Flash

**Speedlite 600EX II-RT/600EX-RT/  
430EX III-RT/430EX III/430EX II/270EX II**

- Shoe-mounted flash unit that enables many styles of flash photography. Speedlite 580EX II, 580EX, 550EX, 430EX, 420EX, 380EX, 320EX, 270EX, 220EX, and 90EX are also supported.

**Speedlite Transmitter ST-E3-RT/ST-E2**

- Enables wireless control of Speedlite flash units (except Speedlite 220EX/270EX).
- Off-Camera Shoe Cord OC-E3 may be required when using ST-E2 with certain lenses.

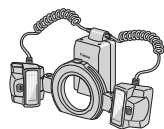

**Macro Twin Lite MT-26EX-RT  
Macro Ring Lite MR-14EX II**

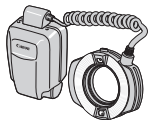
- External macro flash unit that enables many styles of macro flash photography. MR-14EX is also supported.

**Off-Camera Shoe Cord OC-E3**

- Connection cord for using a Speedlite without mounting it on the camera.

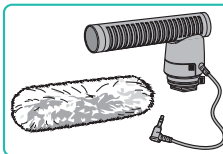
## Microphone

**Directional Stereo Microphone DM-E1**

- When movies are recorded, any sounds of lens and camera operations that are picked up by the microphone will be quieter.

## Other Accessories

**Wireless Remote Control BR-E1**

- Bluetooth enabled wireless remote control.

**Body Jacket EH32-CJ**

- Attach to the camera to protect it from dust and scratches and give it a new look.

**Neck Strap EM-E2**

- A soft and comfortable neck strap.

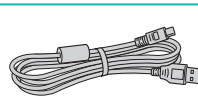
**Interface Cable IFC-600PCU**

- For connecting the camera to a computer or printer.



## Printers

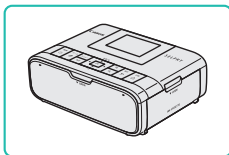

## Canon PictBridge-Compatible Printers

- Even without using a computer, you can print images by connecting the camera directly to a printer.

## Using Optional Accessories

## Playback on a TV

You can view your shots on a TV by connecting the camera to a TV with a commercially available HDMI cable (not exceeding 2.5 m / 8.2 ft., with a Type D terminal on the camera end).

For details on connection or how to switch inputs, refer to the TV manual.

- 1 Make sure the camera and TV are off.**

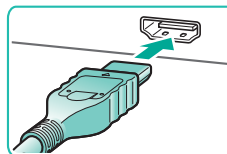

- 2 Connect the camera to the TV.**

- On the TV, insert the cable plug fully into the HDMI input as shown.

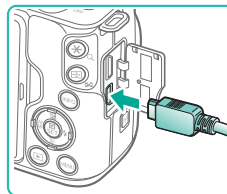

- On the camera, open the terminal cover and insert the cable plug fully into the camera terminal.

- 3 Turn the TV on and switch to external input.**

- Switch the TV input to the external input you connected the cable to in step 2.



#### 4 Turn the camera on.

- Move the power switch to [ON].
- Press the  button.
- Images from the camera are now displayed on the TV. (Nothing is displayed on the camera screen.)
- When finished, turn off the camera and TV before disconnecting the cable.



- Touch-screen operations are not supported while the camera is connected to a television.
- During HDMI output, display of the next image may take some time if you switch between 4K and HD movies, or movies of different frame rates.



- When the camera and TV are connected, you can also shoot while previewing shots on the larger screen of the TV.

#### RAW Playback on an HDR TV

You can view RAW images in HDR by connecting the camera to an HDR TV. For image color display matching HDR TV characteristics, choose []3 tab → [HDMI HDR output] → [On].



- Make sure the HDR TV is set up for HDR input. For details on how to switch inputs on the TV, refer to the TV manual.
- Depending on the TV used, images may not look as expected.
- Some image effects and information may not be displayed on an HDR TV.

#### Powering the Camera with Household Power

Powering the camera with both Compact Power Adapter CA-PS700 and DC Coupler DR-E12 (both sold separately) eliminates the need to monitor the remaining battery level.

##### 1 Make sure the camera is off.

##### 2 Insert the coupler.

- With the cover open and the coupler terminals (1) in the position shown, hold the battery lock toward (2) and insert the coupler.
- Close the cover.

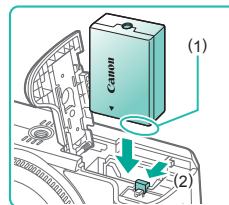

##### 3 Connect the adapter to the coupler.

- Open the cover and insert the adapter plug fully into the coupler.

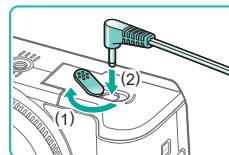

##### 4 Connect the power cord.

- Insert one end of the power cord into the adapter, and then plug the other end into a power outlet.
- Turn the camera on and use it as desired.
- When finished, turn the camera off and unplug the power cord from the outlet.

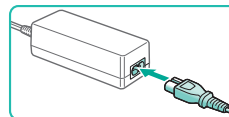

- Do not disconnect the adapter or unplug the power cord while the camera is still on. This may erase your shots or damage the camera.
- Do not attach the adapter or adapter cord to other objects. Doing so could result in malfunction or damage to the product.



## Using the Hot Shoe

Use the hot shoe to attach an optional external flash or microphone.

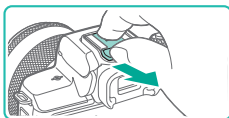

### 1 Remove the hot shoe cap.

- Pull off the cap as shown.
- To avoid losing the cap, place it in the case for your external flash or microphone.

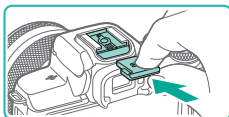

### 2 Attach the hot shoe cap.

- After removing the external flash or microphone, reattach the cap to protect the hot shoe.
- Insert the cap as shown.

## Using an External Flash (Sold Separately)

More sophisticated flash photography is possible with an optional Speedlite EX series flash.



- Non-EX series Canon flash units may not fire correctly or may not fire at all, in some cases.
- Use of non-Canon flash units (especially high-voltage flash units) or flash accessories may prevent normal camera operation and may damage the camera.



- Also refer to the Speedlite EX series manual for additional information. This camera is a Type-A camera that supports all features of EX-series Speedlites.

### 1 Attach the flash.

### 2 Set the shooting mode to **P**, **Tv**, **Av**, or **M** mode.

- In other modes, flash settings cannot be changed, because the flash is adjusted and fired automatically, as needed.

### 3 Configure the external flash.



- Keep cords (from the macro ring lite or macro twin lite, as well as the off-camera shoe cord) away from flash heads.
- When using a tripod, adjust the position of the legs to prevent the flash heads from coming into contact with the legs.



- Settings for the built-in flash cannot be configured while a Speedlite EX series flash is attached, because that setting screen is no longer accessible.
- The AF-assist beam on the external flash will not fire.





## Setting External Flash Functions

When an external flash is attached, configure the following settings in [Flash control] on the [CAMERA] tab.

- Flash firing
- E-TTL II metering
- Slow synchro
- Safety FE
- External flash function settings (41)
- External flash Custom Function settings (41)
- Clear settings (41)

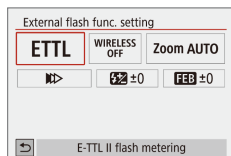

- Choose [CAMERA] → [Flash control] → [External flash func. setting] and press the [OK] button.
- The screen at left is displayed.
- Choose an item, press the [OK] button, choose an option, and press the [OK] button again.



- [Built-in flash settings] is not available when an external flash is attached.
- Information displayed and available setting items vary depending on the type of flash unit, current flash mode, flash Custom Function settings, and other factors. For details on the functions available with your flash unit, refer to the instruction manual of the flash unit.
- With an EX-series Speedlite not compatible with flash function settings, only [Flash exposure compensation] can be adjusted. ([Shutter synchronization] can also be set for some EX-series Speedlites.)

## Setting External Flash Custom Functions

For details on Custom Functions for flash units, refer to the instruction manual of the flash (sold separately).

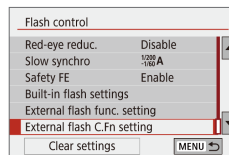

- Choose [CAMERA] → [Flash control] → [External flash C.Fn setting] and press the [OK] button.
- Choose an item, press the [OK] button, choose an option, and press the [OK] button again.



- For full flash firing when shooting with EX series Speedlites, set [Flash metering mode] to [1:TTL] (automatic flash metering).

## Restoring External Flash Defaults

Restore default [External flash func. setting] and [External flash C.Fn setting] settings.

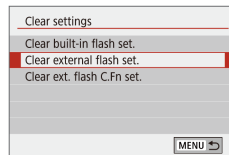

- Choose [CAMERA] → [Flash control] → [Clear settings], and then press the [OK] button.
- Choose an item, press the [OK] button, choose [OK], and press the [OK] button again.



## Using the Software

The software available for download from the Canon website is introduced below, with instructions for installation and saving images to a computer.

### Software

After installing the software, you can do the following things on your computer.

- EOS Utility
  - Import images and change camera settings
- Digital Photo Professional
  - Browse, process, and edit photos, including RAW images
- Picture Style Editor
  - Edit Picture Styles and create and save Picture Style files
- Image Transfer Utility 2
  - Automatically send images to a computer
- Map Utility
  - Use a map to view GPS information that has been added to images



- To view and edit movies on a computer, use preinstalled or commonly available software compatible with movies recorded by the camera.



- Download and install the latest software from the Canon website.

## Checking Your Computer Environment

For detailed software system requirements and compatibility information (including support in new operating systems), visit the Canon website.

## Installing the Software

### 1 Download the software.

- With a computer connected to the Internet, access <http://www.canon.com/icpd/>.
- Access the site for your country or region.
- Download the software.

### 2 Follow the instructions displayed.

- Double-click the downloaded file to install it.



## Saving Images to a Computer

Use a USB cable (sold separately; camera end: Micro-B) to connect the camera and save images to the computer.

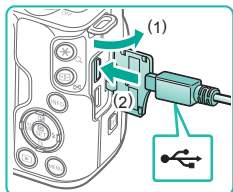

### 1 Connect the camera to the computer.

- With the camera turned off, open the cover (1). With the smaller plug of the cable in the orientation shown, insert the plug fully into the camera terminal (2).
- Insert the larger plug of the cable in the computer's USB port. For details about USB connections on the computer, refer to the computer user manual.

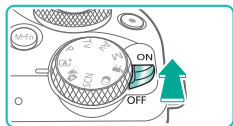
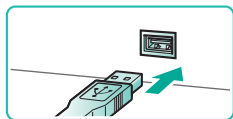

### 2 Turn on the camera and display EOS Utility.

- Move the power switch to [ON].
- Windows: Double-click the EOS Utility icon on the desktop.
- Mac OS: Click the EOS Utility icon in the Dock.
- From now on, EOS Utility will start up automatically when you connect the camera to the computer and turn on the camera.

### 3 Save the images to the computer.

- Click [Download images to computer] → [Start automatic download].
- Once images are saved to the Pictures folder on the computer (in separate folders named by date), Digital Photo Professional starts up automatically and displays the imported images.
- After images are saved, close EOS Utility, turn the camera off, and disconnect the cable.
- Use Digital Photo Professional to view images you save to a computer. To view movies, use preinstalled or commonly available software compatible with movies recorded by the camera.



- The first time you connect the camera to the computer, drivers will be installed, so it may take a few minutes until camera images are accessible.
- Although you can save images to a computer simply by connecting your camera to the computer without using the software, the following limitations apply.
  - It may take a few minutes after you connect the camera to the computer until camera images are accessible.
  - Images shot in vertical orientation may be saved in horizontal orientation.
  - RAW images (or JPEG images recorded with RAW images) may not be saved.
  - Image protection settings may be cleared from images saved to a computer.
  - Some problems may occur when saving images or image information, depending on the operating system version, the software in use, or image file sizes.



## Printing Images

Your shots can easily be printed by connecting the camera to a printer. On the camera, you can specify images to set up batch printing, prepare orders for photo development services, and prepare orders or print images for photobooks.

A Canon SELPHY CP series compact photo printer is used here for the sake of illustration. Screens displayed and available functions vary by printer. Also refer to the printer manual for additional information.

### Easy Print

Easily print your shots by connecting the camera to a PictBridge-compatible printer (sold separately) with a USB cable (sold separately; camera end: Micro-B).

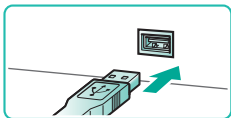
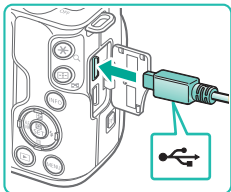

#### 1 Make sure the camera and printer are off.

#### 2 Connect the camera to the printer.

- Open the terminal cover and insert the smaller plug fully into the camera terminal in the orientation shown.
- Connect the larger cable plug to the printer. For other connection details, refer to the printer manual.

#### 3 Turn the printer on.

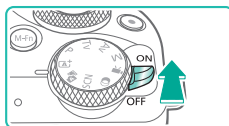

#### 4 Turn the camera on.

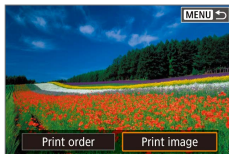

#### 5 Choose an image.

#### 6 Access the printing screen.

- Press the button, choose [Print image], and then press the button again.

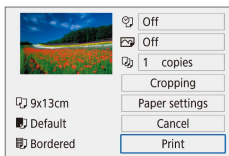

#### 7 Print the image.

- Choose [Print] and press the button.
- Printing now begins.
- To print other images, after printing is finished, repeat this procedure from step 5.
- When you are finished printing, turn the camera and printer off and disconnect the cable.



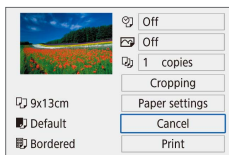

## Configuring Print Settings



### 1 Access the printing screen.

- Follow steps 1 – 6 in “Easy Print” (44) to access the screen at left.

### 2 Configure the settings.

- Choose an item, and then press the  button.
- Choose an option on the next screen, and then press the  button to return to the printing screen.

## Adding Images to the Print List (DPOF)

Batch printing and ordering prints from a photo development service can be set up on the camera.

Choose up to 998 images on a memory card and configure relevant settings (46), such as the number of copies, as follows. The printing information you prepare this way will conform to DPOF (Digital Print Order Format) standards.





- RAW images and movies cannot be selected.

## Configuring Print Settings

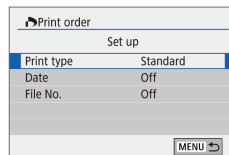
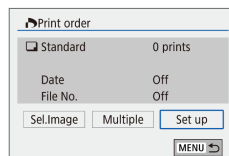
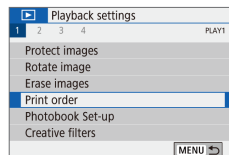

Specify the printing format, whether to add the date or file number, and other settings as follows. These settings apply to all images in the print list.



### 1 Choose [Print order].

- Choose [Print order] on the  tab, and then press the  button.

### 2 Choose [Set up].

- Choose [Set up] and press the  button.
- Choose an item, and then press the  button.
- Choose an option on the next screen, and then press the **MENU** button to return to the printing screen.



- Not all of your DPOF settings may be applied in printing by the printer or photo development service, in some cases.
- Do not use this camera to configure print settings for images with DPOF settings set up on another camera. Changing the print settings using this camera may overwrite all previous settings.
- Setting [Date] to [On] may cause some printers to print the date twice.



## Specifying Images to Print

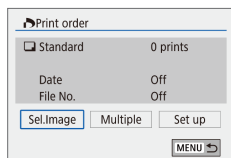

### 1 Choose images to print.

- Follow step 1 in “Configuring Print Settings” (45) to access the screen at left.
- Choose [Sel.Image] or [Multiple], and then press the button.
- Follow the instructions displayed to add images for printing.

## Adding Images to a Photobook

Photobooks can be set up on the camera by choosing up to 998 images on a memory card and transferring them into the software on your computer, where they are stored in their own folder. This is convenient when ordering printed photobooks online or printing photobooks with your own printer.

## Adding Images Individually

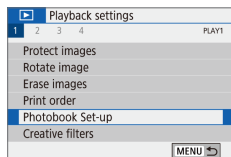

### 1 Choose [Photobook Set-up].

- Press the **MENU** button, choose 1 → [Photobook Set-up], and press the button.

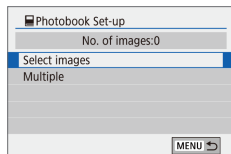

### 2 Choose [Select images].

- Choose [Select images] and press the button.



### 3 Choose an image.

- Choose an image and press the button.
- is displayed.
- To remove the image from the photobook, press the button again. is no longer displayed.
- Repeat this process to specify other images.
- When finished, press the **MENU** button to return to the menu screen.

## Adding Multiple Images at Once

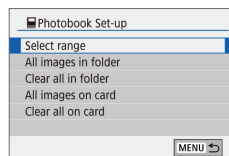

- In step 2 in “Adding Images Individually” (46), choose [Multiple] to access the screen at left.
- Choose an item, and then press the button.
- Follow the instructions displayed to add images.



- Do not use this camera to configure print settings for images with DPOF settings set up on another camera. Changing the print settings using this camera may overwrite all previous settings.



- RAW images and movies cannot be selected.



## Part 2:

# Learning About the Camera

## Setup and Basics

Learn about setting up the camera and performing basic camera operations.

### Handling Precautions

- The camera is a high-precision electronic device. Avoid dropping it or subjecting it to strong impact.
- Never bring the camera near magnets, motors, or other devices that generate strong electromagnetic fields. Strong electromagnetic fields may cause malfunction or erase image data.
- If water droplets or dirt adheres to the camera or screen, wipe with a dry soft cloth, such as an eyeglass cloth. Do not rub hard or apply force.
- Never use cleaners containing organic solvents to clean the camera or screen.
- Use a blower brush to remove dust from the lens. If cleaning is difficult, contact a Customer Support Help Desk.
- Store unused battery packs in a plastic bag or other container. To maintain battery performance if you will not use the battery pack for some time, about once a year charge it and then use the camera until it runs out of power before storing the battery pack.
- Do not touch the camera or lens contacts. This may cause the camera to malfunction.
- To avoid damaging the image sensor, do not touch it when it is exposed after a lens is removed.
- Do not block the shutter operation with your finger, etc. Doing so may cause a malfunction.
- After detaching the lens from the camera, put down the lens with the rear end up and attach the lens caps to avoid scratching the lens surface and electrical contacts.
- Besides dust entering the camera from outside, in rare cases lubricant from the camera's internal parts may adhere to the front of the sensor. If spots are still visible on images after automatic sensor cleaning, contact a Customer Support Help Desk to request sensor cleaning.
- Periodically cleaning the camera's body and lens mount with a soft lens cleaning cloth is recommended.



## Initial Preparations

### Charging the Battery Pack

- Before use, charge the battery pack with the included charger. Be sure to charge the battery pack initially, because the camera is not sold with the battery pack charged.
- To protect the battery pack and keep it in optimal condition, do not charge it continuously for more than 24 hours.
- Battery charger problems may trigger a protective circuit that stops charging and makes the charge lamp blink in orange. If this happens, disconnect the charger's power plug from the power outlet and remove the battery pack. Attach the battery pack to the charger again and wait a while before connecting the charger to a power outlet again.
- The charger can be used in areas with 100 – 240 V AC power (50/60 Hz). For power outlets in a different format, use a commercially available adapter for the plug. Never use an electrical transformer designed for traveling, which may damage the battery pack.
- Charged battery packs gradually lose their charge, even when they are not used. Charge the battery pack on (or immediately before) the day of use.
- As a visual reminder of the charge status, attach the battery cover with ▲ visible on a charged battery pack and concealed on an uncharged one.

### Inserting/Removing the Battery Pack and Memory Card

- If you insert the battery pack facing the wrong way, it cannot be locked into the correct position. Always confirm that the battery pack is facing the right way and locks when inserted.
- Any setting you are currently adjusting may be cleared if you remove the battery pack while the camera is on.
- Before using a new memory card or a card formatted in another device, you should format the card with this camera.
- Recording is not possible on memory cards with a write-protect switch when the switch is in the locked position. Slide the switch to unlock it.
- Make sure the memory card is facing the right way when you insert it. Inserting memory cards facing the wrong way may damage the camera.

### Setting the Date, Time, and Time Zone

- Set the current date, time, and zone correctly if the [Date/Time/Zone] screen is displayed when you turn the camera on. Information you specify this way is recorded in image properties when you shoot, and it is used when you manage images by shooting date or print images showing the date.
- To set daylight saving time (1 hour ahead), set [☀️] to [🌑] on the [Date/Time/Zone] screen.
- If the date/time/zone settings have been cleared, set them again correctly.





## Using a Lens

- Zooming should be done before focusing. The focus may change slightly if you turn the zoom ring after a subject is in focus.
- To protect the lens, keep the lens cap on when the camera is not in use.
- Some lenses may cause vignetting if the built-in flash is used.
- Tips for avoiding dust and smudges
  - When changing lenses, do it quickly in a place with minimal dust.
  - When storing the camera with the lens removed, always attach the camera cap.
  - Wipe off any dust or dirt on the camera cap before you attach it.
- Since the image sensor size is smaller than the 35mm film format, it will look like the lens focal length is increased by approx. 1.6x. For example, the focal length of a 15-45mm lens is approximately equivalent to a focal length of 24-72mm on a 35mm camera.

## Attaching EF and EF-S Lenses

- To use EF and EF-S lenses, attach the optional Mount Adapter EF-EOS M.
- When carrying or using a camera with a lens that is heavier than the camera, support the lens.
- Adapters may extend the minimum focusing distance or affect the maximum magnification or shooting range of the lens.
- If the front part (focusing ring) of the lens rotates during autofocus, do not touch the rotating part.
- The focus preset and power zoom features of some super telephoto lenses are not supported.
- When using a tripod while the adapter is attached to the camera, use the tripod mount included with the adapter. Do not use the camera's tripod socket.
- With EF lenses that incorporate a tripod mount (such as super telephoto lenses), attach the tripod to the tripod mount on the lens.

- Correct camera shake by using a lens with built-in image stabilization. Lenses with built-in image stabilization are named with "IS." IS stands for Image Stabilizer.

## Holding the Camera

- If you have raised the flash, do not rest your fingers on it.

## On/Off

- When an EF-M lens is attached to the camera and the power is off, the aperture narrows to reduce the amount of light entering the camera and protect the internal components of the camera. Accordingly, the camera makes a small noise when turned on or off as the aperture is adjusted.
- The sensor is cleaned when the camera is turned on or off, which may also make a small noise. Even when the camera is off, [ ] is displayed as the sensor is cleaned. However, the [ ] icon may not be displayed if you switch the camera on and off quickly in succession.
- To switch to a shooting mode during playback, press the shutter button halfway, press the [ ] button or movie button, or turn the mode dial.



## Shutter Button

- To ensure that the subject is in focus, begin by holding the shutter button halfway down, and once the subject is in focus, press the button all the way down to shoot.
- Subjects may be out of focus if you shoot without initially pressing the shutter button halfway.

## Viewfinder

- Although the viewfinder is produced under extremely high-precision manufacturing conditions and more than 99.99% of the pixels meet design specifications, in rare cases some pixels may be defective or may appear as red or black dots. This does not indicate camera damage or affect recorded images.
- The viewfinder display and camera screen cannot be activated at the same time.
- Some aspect ratio settings will cause black bars to be displayed on the top and bottom or left and right edges of the screen. These areas are not recorded.
- The screen will not be activated when you move your eye away from the viewfinder if you have selected [F4] tab → [Display settings] → [Display control] → [Manual] and then [Manual display] → [Viewfinder].
- You can conserve battery power by setting [Disp. performance] on the [F4] tab to [Power saving], but viewfinder and screen display may be choppy.
- You can configure viewfinder and screen brightness separately in [Disp. brightness] on the [F2] tab.
- To reduce the shooting screen, choose [F4] tab → [VF display format] → [Display 2].

## Screen Angle and Orientation

- When including yourself in shots, you can view a mirror image of yourself by rotating the screen around toward the front of the camera. To cancel reverse display, choose [F4] tab → [Reverse display] → [Off].
- To protect the screen, always keep it closed and facing the camera body when the camera is not in use.
- Do not force the screen open any wider, which may damage the camera.

## Frames on the Shooting Screen

- Try shooting in **P** mode if no frames are displayed, if frames are not displayed around desired subjects, or if frames are displayed in the background or similar areas.

## Quick Control Screen

- You can also choose options by turning the  dial.

## Menu Screen

- Available menu items vary depending on the selected shooting mode.



## On-Screen Keyboard

- Note that the length and type of information you can enter varies depending on the function you are using.
- Touch [X] to delete the previous character. Touching and holding [X] will delete five characters at a time.
- For some functions, [↵] is not displayed and cannot be used.
- Characters can also be entered by pressing the ▲/▼/◀/▶ buttons to select characters or icons, and then pressing the [Globe] button.

## Indicator Display

- When the indicator is lit or blinking, never turn the camera off, open the memory card/battery cover, or shake or hit the camera. Doing so may corrupt images or damage the camera or memory card.



## Shooting

Learn about a variety of shooting modes for stills and movies.

### Auto Mode

#### Shooting in Hybrid Auto Mode

- For more impressive digest movies, aim the camera at subjects about four seconds before shooting still images.
- The camera records both a still image and movie clip. The clip, which ends with the still image and a shutter sound, forms a single chapter in the digest movie.
- Battery life is shorter in this mode than in **A+** mode, because digest movies are recorded for each shot.
- A digest movie may not be recorded if you shoot a still image immediately after turning the camera on, choosing **A+** mode, or operating the camera in other ways.
- Any sounds and vibrations from your camera or lens operations will be recorded in digest movies.
- Digest movie image quality is **[HD 29.97P]** for NTSC or **[HD 25.00P]** for PAL. This varies depending on the video output format.
- Sounds are not played when you press the shutter button halfway or trigger the self-timer.
- Digest movies are saved as separate movie files in the following cases even if they were recorded on the same day in **A+** mode.
  - The digest movie file size reaches approximately 4 GB, or the total recording time reaches approximately 29 minutes and 59 seconds.
  - The digest movie is protected.
  - Daylight saving time, video system, time zone, or copyright information settings are changed.
- Recorded shutter sounds cannot be modified or erased.
- If you prefer to record digest movies without still images, adjust the setting in advance. Choose **[2]** tab → [Digest type] → [No stills].



## Still Images



- If the camera cannot focus on subjects when you press the shutter button halfway, an orange frame is displayed, and no picture is taken if you press the shutter button all the way down.
- Focusing may take longer or be incorrect when no people or other subjects are detected, when subjects are dark or lack contrast, or in very bright conditions.
- Blinking shutter speeds and aperture values warn that images are more likely to be blurred by camera shake. In this case, mount the camera on a tripod or take other measures to keep it still.
- If your shots are dark despite the flash firing, move closer to the subject.
- To assist in focusing, the lamp may be activated when you press the shutter button halfway in low-light conditions.
- Vignetting or dark image areas may occur with some lenses if the flash fires.
- Although you can shoot again before the shooting screen is displayed, your previous shot may determine the focus, brightness, and colors used.

## Movies

- The black bars on the top and bottom of the screen are not recorded.
- Once recording begins, the display area narrows, and subjects are enlarged.
- When you recompose shots, the focus, brightness, and colors will be automatically adjusted.
- Recording will stop automatically when the memory card becomes full.
- Although the camera may become warm when recording movies repeatedly over an extended period, this does not indicate a problem.
- Keep your fingers away from the microphone while recording movies. Blocking the microphone may prevent audio from being recorded or may cause the recording to sound muffled.

- Avoid touching camera controls other than the movie button and touch-screen panel when recording movies, because sounds made by the camera will be recorded. To adjust settings or perform other operations during recording, use the touch-screen panel if possible.
- Mechanical sounds from the lens and camera are also recorded.
- Once movie recording begins, the image display area changes and subjects are enlarged to allow for correction of significant camera shake. To record subjects at the same size shown before recording, adjust the image stabilization setting.
- Audio is recorded in stereo.
- During movie recording, lens operating noises from auto focusing may also be recorded. If you prefer not to record sound, choose [📷5] tab → [Sound recording] → [Disable].
- To keep the focus fixed during movie recording, choose [📷5] tab → [Movie Servo AF] → [Disable].
- Individual movies that exceed 4 GB may be divided into multiple files. Automatic playback of divided movie files one after another is not supported. Play each movie separately.







## Scene Icons

- In  and  modes, shooting scenes determined by the camera are indicated by the icon displayed, and corresponding settings are automatically selected for optimal focusing, subject brightness, and color.
- Try shooting in **P** mode if the scene icon does not match actual shooting conditions, or if it is not possible to shoot with your expected effect, color, or brightness.



## Shooting with Your Favorite Settings (Creative Assist)

- Capture shots just as you imagine them, without having to know photography terms. Choose from easy-to-understand options to blur the background, adjust brightness, or customize shots in other ways as you watch the screen.

 Background blur	Adjust background blur. Choose higher values to make backgrounds sharper, or lower values to make them blurrier.
 Brightness	Adjust image brightness. Choose higher values to brighten images.
 Contrast	Adjust contrast. Choose higher values to increase the contrast.
 Saturation	Adjust the vividness of colors. Choose higher values to make colors more vivid, or lower values to make them subdued.
 Color tone 1	Adjust color tone. Choose higher values to increase amber, or lower values to increase blue.
 Color tone 2	Adjust color tone. Choose higher values to increase green, or lower values to increase magenta.
 Monochrome	Choose from five monochrome options: [B/W], [Sepia], [Blue], [Purple], or [Green]. Set to [Off] to shoot in color. Note that [Saturation], [Color tone 1], and [Color tone 2] are not available with options other than [Off].



- [Background blur] is not available when the flash is used.
- To prevent your settings from being reset when you switch modes or turn the camera off, set [Retain Creative Assist data] on the [📷] tab to [Enable].

## Saving Creative Assist Settings

- You can also specify your preferred effects, such as [Background blur], [Brightness], [Contrast], [Saturation], [Color tone 1], [Color tone 2], [Background blur], and [Monochrome].
- Up to three customized settings can be saved as presets.
- After three presets have been saved, any new ones you save will overwrite the existing presets. Note that overwritten presets cannot be recovered.

## Specific Scenes

### Self Portrait

- Areas other than people's skin may be modified, depending on the shooting conditions.
- Try taking some test shots first to make sure you obtain the desired results.
- You can also customize effects by turning the  dial after you choose [📷] mode, press the  button, and choose an effect such as [Smooth skin effect] or [Background].
- [Smooth skin effect] settings specified in [📷] mode are not applied in [📷] mode.
- [Background] is set to [AUTO] and cannot be changed in [📷] flash mode when you have raised the flash.
- Any external flash that is attached will not fire.

### Smooth Skin

- Areas other than people's skin may be modified, depending on the shooting conditions.
- Try taking some test shots first to make sure you obtain the desired results.
- Setting details in [📷] mode are not applied in [📷] mode.





## Sports

- Shots may look grainy because the ISO speed is increased to suit the shooting conditions.

## Close-up

- Check the minimum focusing distance of the attached lens to determine how close to subjects you can shoot. The lens minimum focusing distance is measured from the  (focal plane) mark on the top of the camera to the subject.
- To make small things appear much larger, use a macro lens (sold separately).

## Food

- You can also set your preferred effect by turning the  dial, after you choose [F] mode, press the  button, and choose [Color tone].
- These color tones may not look suitable when applied to people.
- In flash shots, color tones are automatically set to the default setting.

## Panning

- For details on lenses compatible with  mode, visit the Canon website.
- Try taking some test shots first to make sure you obtain the desired results.
- For best results, hold the camera securely in both hands, with your elbows close to your body, and rotate your whole body to follow the subject.
- This feature is more effective for subjects moving horizontally, such as cars or trains.

## Handheld Night Scene

- Image noise is reduced by combining consecutive shots into a single image.
- Shots may look grainy because the ISO speed is increased to suit the shooting conditions.
- Hold the camera steady as it shoots continuously.
- Excessive motion blur or certain shooting conditions may prevent you from obtaining the desired results.
- There will be a delay before you can shoot again, as the camera processes and combines the images.
- Try to keep the camera still when using the flash, because the shutter speed may be slower.

## HDR Backlight Control

- Hold the camera steady as it shoots continuously.
- Excessive motion blur or certain shooting conditions may prevent you from obtaining the desired results.
- If excessive camera shake interferes with shooting, mount the camera on a tripod or take other measures to keep it still. In this case, also disable image stabilization.
- Any subject movement will cause images to look blurry.
- There will be a delay before you can shoot again, as the camera processes and combines the images.

## Silent Mode

- Not available with flash photography or continuous shooting.
- A frame is displayed around the screen as shots are taken.
- Camera shake or subject motion may cause image distortion.



## Applying Special Effects

### Soft Focus

- Try taking some test shots first to make sure you obtain the desired results.

### Fish-Eye Effect

- Try taking some test shots first to make sure you obtain the desired results.

### Toy Camera Effect

- The following effects can be applied to images in [📷] mode.

Standard	Shots resemble toy camera images.
Warm tone	Images have a warmer tone than with [Standard].
Cool tone	Images have a cooler tone than with [Standard].

- Try taking some test shots first to make sure you obtain the desired results.

### Miniature Effect

- A white frame is displayed when you select [📷] mode, indicating the image area that will not be blurred.
- Try taking some test shots first to make sure you obtain the desired results.

### HDR Art Standard, HDR Art Vivid, HDR Art Bold, and HDR Art Embossed

- This mode can reduce the washed-out highlights and loss of detail in shadows that tend to occur in high-contrast shots.
- When you press the shutter button all the way down, the camera will take three shots and combine them. Hold the camera steady as you shoot.

- Excessive motion blur or certain shooting conditions may prevent you from obtaining the desired results.
- If excessive camera shake interferes with shooting, mount the camera on a tripod or take other measures to keep it still. In this case, also disable image stabilization.
- There will be a delay before you can shoot again, as the camera processes and combines the images.

## Manual Mode

### Setting Up Shooting from a Single Screen

- The items that are displayed and configurable vary by shooting mode.
- Some settings are configured on another screen that opens when you select the setting and press the [📷] button. Items labeled with [INFO] on the second screen can be configured by pressing the [INFO] button. Press the [📷] button to return to the INFO. Quick Control screen.

### Image Brightness (Exposure)

#### Adjusting Image Brightness (Exposure Compensation)

- You can also configure this setting by choosing [📷2] tab → [Expo. comp./AEB].



#### Auto Exposure Bracketing (AEB Shooting)

- To clear the AEB setting, set the AEB amount to 0, following the configuration procedure.
- AEB is not available with flash, Multi Shot Noise Reduction, creative filter, or bulb shooting.
- If exposure compensation is already in use, the value specified for that function is treated as the standard exposure level for AEB.











### Locking Image Brightness / Exposure (AE Lock)

- AE: Auto Exposure
- After the exposure is locked, you can adjust the combination of shutter speed and aperture value by turning the  dial (Program Shift).
- In **P**, **Tv**, **Av**, or **M** mode, an exposure value is displayed based on the time set in [Metering timer] on the  tab.







### Changing the Metering Method

- With , the exposure is locked at the level determined when you press the shutter button halfway. With , , or , the exposure is not locked then but determined the moment you shoot.
- You can also set the metering method by choosing  tab → [Metering mode].

### Changing the ISO Speed

- Although choosing a lower ISO speed may reduce image graininess, there may be a greater risk of subject and camera shake in some shooting conditions.
- Choosing a higher ISO speed will increase shutter speed, which may reduce subject and camera shake and increase the flash range. However, shots may look grainy.
- You can also adjust the ISO speed by pressing the **M-Fn** button.
- You can also adjust the ISO speed by choosing  tab →  ISO speed settings] → [ISO speed].

### Auto Correction of Brightness and Contrast (Auto Lighting Optimizer)

- Correct brightness and contrast automatically to avoid images that are too dark or have too little or too much contrast.
- This feature may increase noise under some shooting conditions.
- When the effect of Auto Lighting Optimizer is too strong and images become too bright, set it to  or .
- Images may still be bright or the effect of exposure compensation may be weak under a setting other than  if you use a darker setting for exposure compensation or flash exposure compensation. For shots at your specified brightness, set this feature to .
- You can also configure auto correction of brightness and contrast by choosing  tab → [Auto Lighting Optimizer].
- Fewer continuous shots may be available when this setting is set to .

### Shooting Bright Subjects (Highlight Tone Priority)

- Setting highlight tone priority to [D+] or [D+2] will prevent you from setting ISO speeds lower than 160. Auto Lighting Optimizer is also set to  and cannot be changed, in this case.
- Under some shooting conditions, images may not look as expected even if you choose [D+2].



## Image Colors

### Adjusting White Balance

- You can choose [Auto: Ambience priority] or [Auto: White priority] after choosing [WB] and pressing the [WB] button.
- You can also configure this setting by choosing [WB] tab → [White balance].

### Custom White Balance

- Capturing a white subject that is too bright or dark may prevent you from setting the white balance correctly.
- Choose [Cancel] to choose a different image. Choose [OK] to use that image for loading white data, but note that it may not produce a suitable white balance.
- Instead of a white object, a gray chart or 18% gray reflector (commercially available) can produce a more accurate white balance.
- The current white balance and related settings are disregarded when you capture a white subject.

### Manually Correcting White Balance

- Any correction level you set is retained even if you change the white balance option.
- On the advanced settings screen for correction, B is for blue, A for amber, M for magenta, and G for green.
- One level of blue/amber correction is equivalent to about 5 mireds on a color temperature conversion filter. (Mired: Color temperature unit representing color temperature conversion filter density)
- You can also configure the correction level by choosing [WB] tab → [WB Shift/Bkt.].
- You can shoot with white balance adjusted automatically (WB bracketing) by turning the  dial on the correction screen. Three images are captured per shot, each with different color tones.

### Manually Setting White Balance Color Temperature







- Color temperature can be set at 100 K increments in a range of 2,500 – 10,000 K.

### Color Space





- The Adobe RGB color space is mainly used in professional applications such as commercial printing. It is not recommended unless you are familiar with image processing, Adobe RGB, and DCF 2.0 (Exif 2.21 or later). Further image processing on a computer will be needed to avoid images in this color space looking very subdued in sRGB computer environments or when printed with printers not compatible with DCF 2.0 (Exif 2.21 or later).
- File names of stills shot in the Adobe RGB color space begin with \_.
- ICC profiles are not embedded. For details on ICC profiles, refer to the Digital Photo Professional instruction manual.





### Customizing Colors (Picture Style)

- The following Picture Style items are available.

 Auto	The color tone is adjusted automatically to suit the scene. The colors look vivid, especially for blue skies, greenery, and sunsets in nature, outdoor, and sunset scenes.
 Standard	The image looks vivid, sharp, and crisp. Suitable for most scenes.
 Portrait	For smooth skin tones, with slightly less sharpness. Suited for close-up portraits. To modify skin tones, adjust [Color tone].
 Landscape	For vivid blues and greens, and very sharp and crisp images. Effective for impressive landscapes.
 Fine Detail	For detailed rendering of fine subject contours and subtle textures. Makes images slightly more vivid.
 Neutral	For retouching later on a computer. Makes images subdued, with lower contrast and natural color tones.











 Faithful	For retouching later on a computer. Faithfully reproduces the actual colors of subjects as measured under ambient light with a color temperature of 5200 K. Vivid colors are suppressed for a subdued look.
 Monochrome	Creates black and white images.
  	Add a new style based on presets such as [Portrait] or [Landscape] or a Picture Style file, and then adjust it as needed.

- Default [Auto] settings are used for , , and  until you add a Picture Style.
- You can also configure Picture Styles by choosing  tab → [Picture Style].

### Customizing Picture Styles

- The following Picture Style items are adjustable.

Sharpness	 Strength	Adjust the level of edge enhancement. Choose lower values to soften (blur) subjects, or higher values to sharpen them.
	 Fineness	Indicates the edge thinness that enhancement applies to. Choose lower values for more enhanced details.
	 Threshold	Contrast threshold between edges and surrounding image areas, which determines edge enhancement. Choose lower values to enhance edges that do not stand out much from surrounding areas. Note that with lower values, noise may also be emphasized.
 Contrast		Adjust the contrast. Choose lower values to decrease the contrast, or higher values to increase it.

 Saturation* <sup>1</sup>	Adjust the intensity of colors. Choose lower values to make colors faded, or higher values to make them deeper.
 Color tone* <sup>1</sup>	Adjust skin color tone. Choose lower values to produce redder hues, or higher values to produce yellower hues.
 Filter effect* <sup>2</sup>	Emphasize white clouds, the green of trees, or other colors in monochrome images. N: Normal black-and-white image with no filter effects. Ye: The blue sky will look more natural, and the white clouds will look crisper. Or: The blue sky will look slightly darker. The sunset will look more brilliant. R: The blue sky will look quite dark. Fall leaves will look crisper and brighter. G: Skin tones and lips will appear muted. Green tree leaves will look crisper and brighter.
 Toning effect* <sup>2</sup>	Choose from the following monochrome hues: [N:None], [S:Sepia], [B:Blue], [P:Purple], or [G:Green].

\*<sup>1</sup> Not available with .

\*<sup>2</sup> Only available with .

- In [Sharpness], [Fineness] and [Threshold] settings are not applied to movies.
- To undo any changes after adjusting Picture Styles, press the **INFO** button.
- [Filter effect] results are more noticeable with higher [Contrast] values.



## Saving Customized Picture Styles

- Picture Styles that you have added to the camera using EOS Utility can also be modified.
- Download software instruction manuals from the Canon website as needed. For downloading instructions, see “Installing the Software” (42).

## Focusing

### Easily Identifying the Focus Area (MF Peaking)

- Colors displayed for MF peaking are not recorded in your shots.

### Choosing the AF Method

- Focusing may take longer or be incorrect when subjects are dark or lack contrast, in very bright conditions, or with some EF or EF-S lenses. For lens details, check the Canon website.
- You can also change the method of auto focus (AF) used by choosing [AF] tab → [AF method].
- If the camera cannot focus on subjects when you press the shutter button halfway, an orange frame is displayed, and no picture is taken if you press the shutter button all the way down.

### ☺+Tracking

- After you aim the camera at the subject, a white frame is displayed around the face of the main subject as determined by the camera.
- When the camera detects movement, frames will follow moving subjects, within a certain range.
- If no faces are detected when you aim the camera at people, pressing the shutter button halfway displays green frames around other areas in focus.
- With the following subjects, faces may not be detected.
  - Subjects that are distant or extremely close
  - Subjects that are dark or light
  - Faces in profile, at an angle, or partly hidden

- The camera may misinterpret non-human subjects as faces.
- Pressing the [☺] button displays [Face select: On], and a face frame (☺) is shown around the face detected as the main subject. Press the [☺] button again to switch the face frame (☺) to another detected face. Once you cycle through all detected faces, [Face select: Off] is displayed and Face Select is canceled.

### ■ Zone AF

- The camera focuses within your designated area. Effective when the subject is hard to capture with [☺+Tracking] or [1 pt AF], because you can specify where to focus. The camera will focus within the white frame displayed. You can move the white frame by dragging it or touching the screen.
- Blue frames are displayed around positions in focus when you select [AF] tab → [AF operation] → [Servo AF].

### ■ 1-point AF

- The camera focuses using a single AF point. Effective for reliable focusing.
- You can also move the frame by touching the screen to specify where to focus. To compose shots with subjects on the edge or in a corner without moving the frame, first aim the camera to bring the subject into an AF point, and then hold the shutter button halfway down. Keep the shutter button halfway down as you recompose the shot, and then press the shutter button all the way down (Focus Lock).

### Magnifying Display to Check the Focus

- Magnified display is also possible by touching [Q] on the screen when the AF method is set to [AF (☺)] or [AF □].



## Shooting with Subject Eyes in Focus

- Subject eyes may not be detected correctly, depending on the subject and shooting conditions.
- No frame is displayed around eyes unless the camera detects the subject's face or eyes.
- Eye Detection AF is not available when the AF method is set to [AF( )] or [AF□], or when AF operation is set to [SERVO].
- Enabling [Eye Detection AF] disables [AE+ Auto servo].
- You can also choose an eye by touching it on the screen, and you can switch the focus to other eyes by pressing the [AF] button.

## Shooting with Servo AF

- The focus and exposure are maintained where the blue AF point is displayed while you are pressing the shutter button halfway.
- The camera may not be able to shoot while focusing, even if you press the shutter button all the way down. Keep holding down the shutter button as you follow the subject.
- Exposure is not locked in Servo AF mode when you press the shutter button halfway but is determined the moment you shoot, regardless of the metering mode setting.
- Continuous shooting with auto focus is possible by specifying Servo AF. Note that continuous shooting is slower at this time. Also note that focus may be lost if you zoom in or out during continuous shooting.
- Depending on the lens used, the distance to the subject, and the subject's speed, the camera may not be able to achieve correct focus.
- If the camera cannot focus on subjects when you press the shutter button halfway, an orange frame is displayed, and no picture is taken if you press the shutter button all the way down.
- You can also configure Servo AF by choosing [CAM6] tab → [AF operation].

## Changing the Focus Setting

- Changing the Continuous AF setting has the following effect.

Enable	Helps avoid missing sudden photo opportunities, because the camera constantly focuses on subjects until you press the shutter button halfway.
Disable	Conserves battery power, because the camera does not focus constantly. However, this may delay focusing.

- With Continuous AF disabled, you can touch subjects to select them and set the focus there.

## Choosing Subjects by Touch

- Tracking may not be possible when subjects are too small or move too rapidly, or when there is inadequate contrast between subjects and the background.

## Flash

- [Built-in flash settings] can be reset to defaults. Choose [CAM1] tab → [Flash control] → [Clear settings] → [Clear built-in flash set.].

## Changing the Flash Mode

- If the flash fires, vignetting may occur. Firing the flash may also cause vignetting or dark image areas with certain lenses.
- When there is a risk of overexposure, the camera automatically adjusts the shutter speed or ISO speed for flash shots to reduce washed-out highlights and shoot at optimal exposure. Thus, shutter speeds and ISO speeds displayed when you press the shutter button halfway may not match the settings in flash shots.
- You can also configure this setting by choosing [CAM1] tab → [Flash control] → [Flash firing].
- Auto flash [A]
- Fires automatically in low-light conditions.
- Flash on [F]
- Fires for each shot.
- Flash off [OFF]
- For shooting without the flash.



## Safety FE

- When there is a risk of overexposure, the camera automatically adjusts the ISO speed for flash shots to reduce washed-out highlights and shoot at optimal exposure. However, you can deactivate automatic adjustment of the ISO speed by choosing 1 tab → [Flash control] → [Safety FE] → [Disable].

## Adjusting the Flash Exposure Compensation

- You can also configure the flash exposure compensation by choosing 1 tab → [Flash control] → [Built-in flash settings] → [exp. comp.].
- You can also access the [Built-in flash settings] screen as follows.
  - When the flash is up, press the button and immediately press the **MENU** button.
  - Press the button, and then touch **[MENU]**.

## Shooting with FE Lock

- FE: Flash Exposure
- The metering range is shown by a circle in the center of the screen when FE is locked.
- blinks when standard exposure is not possible, even if you press the button to fire the flash. Enable FE lock by pressing the button when subjects are within flash range.

## Changing the Flash Timing

- [1st curtain] is used whenever the shutter speed is 1/100 or faster, even if you select [2nd curtain].

## Changing the Flash Metering Mode

- When using [Average], adjust flash exposure compensation to suit the shooting conditions.
- Mount the camera on a tripod or take other measures to keep it still and prevent camera shake. In this case, also disable image stabilization ( 62).
- Even after the flash fires, ensure that the main subject does not move until the shutter sound is finished playing.

## Other Settings

### Changing the IS Mode Settings

- The following [IS mode] items are available.





On	Corrects camera movement or camera shake using built-in image stabilization performed by the lens.
Off	Deactivates image stabilization.

- Image stabilization is only applied at the moment of shooting in mode, regardless of the lens IS setting.
- If image stabilization cannot prevent camera shake, mount the camera on a tripod or take other measures to hold it still. Additionally, you should set [IS mode] to [Off] when using a tripod or other means to secure the camera.
- [IS mode] is not displayed for lenses other than EF-M lenses. Use the image stabilization switch on the lens instead.





## Correcting Camera Shake when Recording Movies

- Even more effective correction is possible by using a lens that supports Combination IS, which combines lens image stabilization with in-camera Digital IS. For details on lenses compatible with Combination IS, check the Canon website.
- The following  Digital IS] items are available.

Enable	  (When using a lens supporting Combination IS)	Corrects camera shake when recording movies. The image display area narrows and subjects are slightly enlarged.
Enhanced	  (When using a lens supporting Combination IS)	Corrects strong camera shake when recording movies. Subjects are further enlarged.
Disable	 Off	—

- Try taking some test shots first to check the effect with the lens you are using.
- [Enhanced] is only available in  mode.

## Auto Level

- When you set  Digital IS] to [Enable] or [Enhanced],  Auto level] is set to [Disable] and cannot be changed.
- Once recording begins, the display area narrows, and subjects are enlarged.

## Correcting Lens Aberrations

Peripheral illumination correction	Corrects vignetting from lens characteristics. Choose [Enable] to display corrected images. Less correction is applied than the maximum amount in Digital Photo Professional. If the effect of correction is hard to determine, apply peripheral illumination correction in Digital Photo Professional.
Distortion correction	Corrects distortion from lens characteristics. Choose [Enable] to display corrected images. Note that corrected images are cropped, due to the nature of this correction. To compensate for the slightly lower sharpness after correction, adjust Picture Style [Sharpness] as needed.
Digital Lens Optimizer	Corrects lens aberration, diffraction, and loss of sharpness from the low-pass filter by applying optical design values. Enabling this option applies both chromatic aberration correction and diffraction correction, which are no longer shown in the menu.
Chromatic aberration correction	Corrects chromatic aberration (color fringing around subjects) from lens characteristics. Choose [Enable] to display corrected images. If the effect of correction is hard to determine, check with magnified display.
Diffraction correction	Corrects loss of sharpness from the lens aperture. Choose [Enable] to display corrected images. If the effect of correction is hard to determine, check with magnified display.

- Noise may occur around the edges of images shot under some conditions if you set [Peripheral illum corr] to [Enable].
- The higher the ISO speed, the lower the amount of peripheral illumination correction will be.
- Note the following when enabling [Digital Lens Optimizer] or [Diffraction correction].
  - When correcting lens aberration, this feature may also make noise more noticeable, under some shooting conditions.
  - The higher the ISO speed, the lower the amount of correction will be.
  - Correction is not applied to movies.



- [Diffraction correction] corrects loss of sharpness not only from diffraction but also from the low-pass filter and other factors. Thus, correction is also effective for exposures with the aperture wide open.

### Lens Correction Data

- When [Correction data not available] is displayed on the setting screen, correction data has not been added to the camera. Note the following about adding correction data.
  - Lens correction data for lenses compatible with this feature is registered (stored) on the camera. Correction is automatic when you enable [Peripheral illum corr], [Distortion correction], [Digital Lens Optimizer], or [Chromatic aberr corr].
  - Using EOS Utility, you can check which lenses have correction data registered on the camera. You can also register correction data for lenses that have not been registered yet. For lenses with internal correction data, there is no need to register the information on the camera. For details, refer to the EOS Utility instruction manual.
  - Existing JPEG images cannot be corrected.
  - Effects of correction are not shown on images when you shoot with magnified display in the case of [Peripheral illum corr], [Distortion correction], [Digital Lens Optimizer], or [Diffraction correction].
  - The amount of correction (except diffraction correction) is less for lenses that do not provide distance information.
  - Effects of lens aberration correction vary by lens and shooting conditions. With some lenses and under some shooting conditions, effects may be less noticeable.
  - Results of shooting without registering lens correction data on the camera are the same as shooting with [Peripheral illum corr], [Distortion correction], [Digital Lens Optimizer], and [Chromatic aberr corr] set to [Disable].

### Using Multi Shot Noise Reduction

- Unexpected results may occur if images are quite misaligned (from camera shake, for example). Mount the camera on a tripod or take other measures to keep it still, if possible.
- If you shoot a moving subject, the subject's movement may leave afterimages or the surrounding area of the subject may become dark.
- Depending on shooting conditions, noise may appear on the image periphery.
- Flash shooting is not possible.
- Recording the image to the card will take longer than with normal shooting. You cannot take another shot until processing is finished.

### Adding Dust Delete Data to Images

- After Dust Delete Data is obtained, it is added to all captured JPEG and RAW images. It is a good idea to acquire Dust Delete Data again or update it before important shooting occasions.
- For details on using Digital Photo Professional (software used with EOS cameras) to erase dust spots automatically, refer to the Digital Photo Professional instruction manual.
- The size of Dust Delete Data added to images is negligible and has essentially no effect on image file sizes.
- Shoot a solid-white object, such as a new sheet of white paper. Any patterns or designs may be misinterpreted as dust data and affect the accuracy of the dust deletion.

### Reducing Noise at Slow Shutter Speeds

- There may be a delay before you can shoot again, as the camera reduces noise in images.
- Images shot at ISO speeds of 1600 or higher may be grainier with [Long exp. noise reduction] set to [ON] than [OFF] or [AUTO].





## Specific Shutter Speeds and Aperture Values



### Specific Shutter Speeds (Tv Mode)

- **Tv**: Time value
- There may be a delay before you can shoot again when [Long exp. noise reduction] is set to [ON] or [AUTO] and the shutter speed is 1 second or slower, because images are processed to remove noise.
- We recommend deactivating image stabilization when shooting at slow shutter speeds on a tripod.
- Maximum shutter speed with the flash is 1/200 second. If you specify a faster speed, the camera will automatically reset the speed to 1/200 second before shooting.
- Blinking display of the aperture value when you press the shutter button halfway indicates that the standard exposure has not been obtained. Adjust the shutter speed until the aperture value is displayed in white, or use safety shift.

### Specific Aperture Values (Av Mode)

- **Av**: Aperture value (size of the opening made by the diaphragm in the lens)
- Blinking display of the shutter speed when you press the shutter button halfway indicates that the standard exposure has not been obtained. Adjust the aperture value until the shutter speed is displayed in white, or use safety shift.
- Maximum shutter speed with the flash is 1/200 second. To avoid exceeding 1/200 second in flash shots, the camera may adjust the aperture value.
- The aperture changes only at the moment you shoot, and it remains open at other times. For this reason, the depth of field shown on the screen looks narrow, or shallow. To check the area in focus, assign [Fn] (depth-of-field preview) to a button and press it.

## Specific Shutter Speeds and Aperture Values (M Mode)

- **M**: Manual
- Available aperture values vary by lens.
- When the ISO speed is fixed, you can compare your specified value (indicated by the position where the exposure level mark moves) to the standard exposure level by pressing the shutter button halfway. The exposure level mark is shown as [◀] or [▶] when the difference from standard exposure exceeds 3 stops.
- After you set the shutter speed and aperture value, the exposure level may change if you adjust the zoom or recompose the shot.
- When the ISO speed is fixed, screen brightness may change depending on your specified shutter speed and aperture value. However, screen brightness remains the same when the flash is up and the mode is set to [⚡].
- Exposure may not be as expected when the ISO speed is set to [AUTO], because the ISO speed is adjusted to ensure standard exposure relative to your specified shutter speed and aperture value.
- Image brightness may be affected by Auto Lighting Optimizer. To keep the Auto Lighting Optimizer disabled in **M** mode, add a [✓] mark to [Disable during man expo] on the Auto Lighting Optimizer setting screen.
- Calculation of standard exposure is based on the specified metering method.
- The following operations are available when ISO speed is set to [AUTO].
  - Turn the  dial when  is shown on the exposure compensation bar to adjust exposure.
  - Press the  button to lock the ISO speed. Screen brightness changes accordingly.



## Shooting Long Exposures (Bulb)

- Shots are exposed for as long as you hold the shutter button all the way down. The elapsed exposure time is displayed during exposure.
- Mount the camera on a tripod or take other measures to keep it still and prevent camera shake. In this case, also disable image stabilization.
- Images from long bulb exposures may have more noise and look grainy. Noise can be reduced by choosing [5] tab → [Long exp. noise reduction] → [AUTO] or [ON].
- When [Touch Shutter] is set to [Enable], shooting is started by touching the screen once and stopped by touching it again. Be careful not to move the camera when touching the screen.

## Adjusting the Flash Output

- You can also access the [Built-in flash settings] screen when the flash is up by pressing the ► button and immediately pressing the **MENU** button.

## Recording Movies at Specific Shutter Speeds and Aperture Values (Movie Manual Exposure)

- Some shutter speeds may cause flickering on the screen when recording under fluorescent or LED lighting, which may be recorded.
- Large aperture values may delay or prevent accurate focusing.
- When the ISO speed is fixed, you can compare your specified value (indicated by the position where the exposure level mark moves) to the standard exposure level by pressing the shutter button halfway. The exposure level mark is shown as ◀ or ▶ when the difference from standard exposure exceeds 3 stops.
- You can check the ISO speed in [AUTO] mode by pressing the shutter button halfway. If standard exposure cannot be obtained with your specified shutter speed and aperture value, the exposure level mark moves, indicating the difference from standard exposure. The exposure level mark is shown as ◀ or ▶ when the difference from standard exposure exceeds 3 stops.

## Customizing the Camera

### Configuring Touch & Drag AF

- This feature is not available when [3] tab → [Touch control] is set to [Disable].
- Touch-and-drag settings can be adjusted in [5] tab → [Touch & drag AF settings] → [Positioning method], and the area available for touching or dragging on compatible screens can be changed in [Active touch area].

Absolute	The AF point moves to the touched or dragged position on the screen.
Relative	The AF point moves in the direction you drag, by an amount corresponding to the amount you drag, no matter where you touch the screen.

### Configuring Custom Functions

- The following [Custom Functions(C.Fn)] items on the [5] tab can be configured.

Type of Function	Function	Description
C.Fn 1: Exposure	ISO expansion	Set to [1:On] for the option of setting the ISO speed to [H]. [H] corresponds to ISO 51200 for stills or ISO 25600 for movies (except [4k 2500P] or [4k 23.98P]).
	Safety shift	Set to [1:Enable] for automatic adjustment of the shutter speed and aperture value to bring the exposure level closer to standard exposure if standard exposure would not be available otherwise under your specified shutter speed or aperture value in <b>Tv</b> or <b>Av</b> mode.





## Convenient Features

### Using the Self-Timer

- Once you start the self-timer, the lamp will blink and the camera will play a self-timer sound.
- When using an optional Wireless Remote Control BR-E1, choose [F1] tab → [Wireless communication settings] → [Bluetooth function] → [Remote]. [C] changes to [S] once the devices are paired, and you can then use the remote to shoot. For pairing instructions, also refer to the BR-E1 instruction manual.
- When shooting remotely in [M] mode, set [Remote control] on the [C1] tab to [Enable].
- You can also configure this setting by choosing [C1] tab → [Drive mode].

### Customizing the Self-Timer

- Even when set, the self-timer has no effect if you press the movie button to start recording.
- More time is required between shots when the flash fires or when you have specified to take many shots. Shooting will stop automatically when the memory card becomes full.
- When a delay longer than two seconds is specified, two seconds before the shot, the lamp blinking and self-timer sound will speed up. (The lamp will remain lit in case the flash fires.)

### Shooting by Touching the Screen (Touch Shutter)

- You can configure touch-shutter settings by choosing [C5] tab → [Touch Shutter].
- An orange AF point indicates that the camera could not focus on subjects. No shot will be taken.

## Continuous Shooting

- During continuous shooting, focus is locked at the position determined when you pressed the shutter button halfway.
- Shooting may stop momentarily or continuous shooting may slow down depending on shooting conditions and camera settings.
- As more shots are taken, shooting may slow down.
- There may be a delay before you can shoot again, depending on shooting conditions, the type of memory card, and how many shots you took continuously.
- Shooting may slow down if the flash fires.
- Screen display in continuous shooting differs from the images actually captured and may look out of focus. Some lenses may also darken the continuous shooting screen display, but images are captured with standard brightness.
- Fewer continuous shots may be available under some shooting conditions or camera settings.

## Changing Image Quality

- [L] and [H] indicate different levels of image quality depending on the extent of compression. At the same size (pixel count), [L] offers higher image quality. Although [H] images have slightly lower image quality, more fit on a memory card. Note that [S2]-size images are of [L] quality.
- Image quality cannot be configured in [M] mode.
- You can also configure this setting by choosing [C1] tab → [Image quality].



## Capturing in RAW Format

- The camera can capture images in JPEG and RAW format.
- **[RAW]** produces RAW images with maximum image quality. **[CRAW]** produces RAW images with more compact file sizes.
- RAW image data cannot be used as-is for viewing on a computer or printing. You must first process it on this camera or use the Digital Photo Professional application to convert images to ordinary JPEG or TIFF files.
- To save RAW images (or RAW and JPEG images captured together) to a computer, always use the dedicated software, EOS Utility.
- For details on the relationship between the pixel count and the number of shots that will fit on a card, see “Recording” (p.88).
- The file extension for JPEG images is .JPG, and the extension for RAW images is .CR3. File names of JPEG and RAW images captured together have the same image number.
- For details on Digital Photo Professional and EOS Utility applications, see “Software” (p.42). Download software instruction manuals from the Canon website as needed. For downloading instructions, see “Installing the Software” (p.42).
- You can also configure this setting by choosing **[1]** tab → [Image quality]. To capture images in both JPEG and RAW format simultaneously, choose **[RAW]** or **[CRAW]** in [RAW].
- Only JPEG images are captured when [RAW] is set to [-] on the [Image quality] screen, and only RAW images are captured when [JPEG] is set to [-].

## Changing the Aspect Ratio

- The aspect ratio cannot be configured in **[M]** mode.
- You can also configure this setting by choosing **[1]** tab → [Still img aspect ratio].

## Changing Movie Image Quality

- **[4k 25.00P]** and **[4k 23.98P]** are only available in **[M]** mode.
- With **[4k 25.00P]** or **[4k 23.98P]**, focusing may take longer.
- Subjects appear larger with **[4k 25.00P]** or **[4k 23.98P]** than at other image quality levels. Additionally, some features may not be available.
- You can also configure this setting by choosing **[1]** tab → [Movie rec quality].





## Playback

Learn about viewing your stills and movies on the camera.

### Playback

#### Viewing Stills and Movies

- It may not be possible to play back or edit images that were renamed or already edited on a computer, or images from other cameras.
- To pause or resume movies, press the  button.
- To switch to a shooting mode during playback, press the shutter button halfway, press the  button or movie button, or turn the mode dial.
- Lines indicating the aspect ratio are displayed when you view RAW images. These lines are shown on the top and bottom of images shot at an aspect ratio of [16:9] and on the left and right of images shot at an aspect ratio of [4:3] or [1:1].
- If you prefer to have the most recent shot displayed when you start playback after turning the camera on, choose [4] tab → [View from last seen] → [Disable].

#### Overexposure Warning (for Image Highlights)

- Washed-out highlights blink on information display screens when you press the **INFO** button during playback to access detailed information display.

#### Brightness Histogram

- A graph on the top of the screen, called a brightness histogram, shows the distribution of brightness in images when you press the **INFO** button during playback to access detailed information display. The horizontal axis represents the degree of brightness, and the vertical axis, how much of the image is at each level of brightness. Viewing this histogram enables you to check exposure.



## RGB Histogram

- To view an RGB histogram showing the red, green, and blue distribution in an image, press the **INFO** button during playback to access detailed information display. The horizontal axis represents R, G, or B brightness, and the vertical axis, how much of the image is at that level of brightness. Viewing this histogram enables you to check image color characteristics.

## Playback Using Touch Operations

- The movie playback panel can also be displayed by touching the screen during movie playback.
- During index display, drag up or down to scroll through images.
- Drag to move the display position during magnified display.

## Viewing Slideshows

- After you start playback and [Loading image] is displayed, the slideshow starts in a few seconds.
- Press the **MENU** button to stop the slideshow.
- The camera's power-saving functions are deactivated during slideshows.
- To pause or resume slideshows, press the **⏸** button.
- During a slideshow, you can also pause playback by touching the screen.
- You can switch to other images during playback by pressing the **◀/▶** buttons. For fast-forward or fast-rewind, hold the **◀/▶** buttons down.
- On the slideshow start screen, you can choose [Set up] to configure slideshow repetition, display time per image, and the transition between images.

## Viewing Digest Movies

- The movie recorded automatically on the day of still image shooting is played back from the beginning.
- After a moment, **[SET]** will no longer be displayed when you are using the camera with information display deactivated.

## Viewing by Date

- Digest movies can be viewed by date.

## Image Browsing and Searching

### Navigating through Images in an Index

- Press the **⏮** button to display images in an index. Each press of the **⏮** button increases the number of images shown.
- Each press of the **✖** button reduces the number of images shown.
- An orange frame is displayed around the selected image.
- Press the **⏪** button to view the selected image in single-image display.

### Finding Images Matching Specified Conditions

- Find desired images quickly on a memory card full of images by filtering image display according to your specified conditions. You can also protect or erase these images all at once.



★ Rating	Display images you have rated.
📅 Date	Display the images shot on a specific date.
📁 Folder	Display images in a specific folder.
🔑 Protect	Display protected or unprotected images on the memory card.
📁 Type of file	Display [📷 Stills], [📷 (RAW)], [📷 (RAW, RAW+JPEG)], [📷 (RAW+JPEG)], [📷 (RAW+JPEG, JPEG)], [📷 (JPEG)], [🎬 Movies], or [📷 Digest].

- To clear your search, press the **⏮** button on the setting screen.
- You can also protect, rotate, rate, or apply other actions only to all matching images, which are displayed in yellow frames, by pressing the **⏪** button.



- If you edit images and save them as new images, a message is displayed, and the images that were found are no longer shown.
- The same operations are available by choosing [▶3] tab → [Set image search conditions].



### Finding Images with the Main Dial

- Turning the  dial in single-image display jumps through images forward or backward according to your specified method.
- After you choose [◀] or [▶], turn the  dial to view only images matching the condition or jump by the specified number of images forward or back.
- With [▶], jumping is not possible unless there are applicable images.

### Protecting Images

- Protected images on a memory card will be erased if you format the card.
- Protected images cannot be erased using the camera's erasure function. To erase them this way, first cancel protection.
- You can also protect images by choosing [▶1] tab → [Protect images].



### Protecting Individual Images

- [🔒] is displayed when you choose [▶1] tab → [Protect images] → [Select images] and press the  button. To cancel protection (and remove [🔒] display), when [🔒] is displayed, press the  button again.

### Protecting Multiple Images

- You can also specify images by choosing [Protect images] and then [Select range], [All images in folder], or [All images on card].

### Rating Images

- Organize images by rating them on a scale of 1 – 5 ([OFF], [★], [★★], [★★★], [★★★★], or [★★★★★]). By viewing only images with a specified rating, you can restrict the following operations to all images with that rating.
  - Viewing, viewing slideshows, protecting, erasing, or adding images to a print list or photobook
- To remove ratings, press the  button, choose [OFF] in the [★] setting item, and then press the  button.
- You can also configure this setting by choosing [▶3] tab → [Rating].

### Erasing Images

- You can choose and erase unneeded images one by one. Be careful when erasing images, because they cannot be recovered.
- Protected images cannot be erased.
- During display of images captured in both RAW and JPEG format, pressing the  button displays [Erase RAW], [Erase JPEG], and [Erase RAW+JPEG]. Choose an option to erase the image.
- You can also erase images by choosing [▶1] tab → [Erase images].

### Erasing Multiple Images

- To clear selection (and remove [✓]), when [✓] is displayed, press the  button again.
- Choosing an image captured in both RAW and JPEG format will erase both versions.





## Editing Still Images



- Image editing is only available when the memory card has sufficient free space.

## Rotating Images

- You can also rotate images by choosing [  1 ] tab → [Rotate image].

## Deactivating Auto Rotation

- The following rotation options are available for images in vertical orientation.



On 	Automatically rotate images during playback on both the camera and computers.
On 	Automatically rotate images during playback on computers.
Off	Do not automatically rotate images.

## Resizing Images



- Editing is not possible for images shot at a pixel count of [S2].
- RAW images cannot be edited.
- Images cannot be resized to a higher pixel count.
- You can also configure this setting by choosing [  2 ] tab → [Resize].

## Cropping

- RAW images cannot be edited.
- Cropped images cannot be cropped again.
- Cropped images cannot be resized or have creative filters applied.
- Cropped images will have a lower pixel count than uncropped images.
- While previewing the cropped image, you can resize, move, and adjust the aspect ratio of the cropping frame.

- You can also specify the cropping frame size, position, orientation, and aspect ratio by choosing [  2 ] tab → [Cropping], choosing an image, and pressing the  button.
- You can also move the cropping frame by dragging it.

## Applying Filter Effects

- For [  ], you can also choose the type of filter effect.
- For [  ], you can also move the frame by touching or dragging across the screen.



## Correcting Red-Eye

- Once red-eye is corrected, frames are displayed around corrected image areas.
- Some images may not be corrected accurately.

## Applying Your Favorite Effects (Creative Assist)

- [AUTO1], [AUTO2], or [AUTO3] is displayed as a recommended preset after the camera automatically analyzes the image.
- You can also specify your preferred effects, such as [Brightness], [Contrast], [Saturation], [Color tone 1], [Color tone 2], and [Monochrome].

## Processing RAW Images with the Camera

- Images produced by in-camera processing will not match those processed with Digital Photo Professional exactly.
- On the processing conditions screen, you can also choose an effect for the selected processing condition by turning the  dial.
- For magnified display on the processing conditions screen, press the  button.
- The camera can also be set up for RAW image processing from the Quick Control screen by choosing [  2 ] tab → [Quick Control RAW processing] → [RAW image processing].



## Processing Multiple Images

- Choose [ ] tab → [RAW image processing] → [Select images], press the button, and then press the buttons to choose an image. Press the button to mark the item as selected ([✓]). Repeat this process to specify other images. When finished, process the images.
- To cancel selection, press the button again. [✓] is no longer displayed.

## Processing a Range of Images

- Choose [ ] tab → [RAW image processing] → [Select range], press the button, and then specify a range of images. When finished, process the images.

## Editing Movies

### Removing the Beginning/End of Movies

- To cancel editing, press the **MENU** button, choose [OK], and then press the button.
- To erase and overwrite the original movie with the edited one, choose [Overwrite] on the screen for saving edited movies.
- If the memory card lacks sufficient space, only [Overwrite] will be available.
- Movies may not be saved if the battery pack runs out while saving is in progress.
- When editing movies, if possible, use a fully charged battery pack, or insert a DC coupler and connect a compact power adapter (both sold separately).

### Extracting Frames of 4K Movies as Stills

- Choose [ ] on the movie editing screen to save a frame as a still image.

## Reducing File Sizes

- The image quality after compression is as follows.

Before Compression	After Compression
59.94P,  29.97P	29.97P
25.00P,  50.00P,  25.00P	25.00P
23.98P,  23.98P	23.98P
59.94P	29.97P
50.00P	25.00P

- Edited movies cannot be saved in compressed format when you choose [Overwrite].

## Editing Digest Movies

- After [Erase this clip?] is displayed, the chapter is erased and the digest movie is overwritten when you choose [OK] and press the button.



# Settings

Learn about setting up basic camera functions.  
Make the camera easier to use by customizing or adjusting these basic functions.

## Adjusting Basic Camera Functions

- These settings are configured on the [📷] and [🔧] tabs. Customize commonly used functions as desired, for greater convenience.

## Changing the Image Display Period after Shots

- The following items are available.

2 sec., 4 sec., 8 sec.	Images are displayed for the specified time. Even while the shot is displayed, you can take another shot by pressing the shutter button halfway again.
Hold	Images are displayed until you press the shutter button halfway.
Off	No image display after shots.

## Creating or Selecting Folders

- Folders are named as in 100CANON, with a three-digit folder number followed by five letters or numbers.
- Folders with numbers in the range 100 – 999 can be created.

## File Numbering

- Your shots are automatically numbered in sequential order (0001 – 9999) and saved in folders that store up to 9,999 images each. You can change how the camera assigns file numbers. The following items are available.

Continuous	Images are numbered consecutively (until the 9999th shot is taken/saved) even if you switch memory cards.
Auto reset	Image numbering is reset to 0001 if you switch memory cards, or when a new folder is created.
Manual reset	Manually applies auto reset.



- Regardless of the option selected in this setting, shots may be numbered consecutively after the last number of existing images on newly inserted memory cards. To start saving shots from 0001, use an empty (or formatted) memory card.

## Formatting Memory Cards

- Formatting or erasing data on a memory card only changes file management information on the card and does not erase the data completely. When disposing of or transferring ownership of memory cards, take steps to protect personal information if necessary, as by physically destroying cards.
- The total card capacity indicated on the formatting screen may be less than the advertised capacity.

## Low-Level Formatting

- Low-level formatting takes longer than initial formatting, because data is erased from all storage regions of the memory card.
- You can cancel low-level formatting in progress by choosing [Cancel]. In this case, all data will be erased, but the memory card can be used normally.

## Using Eco Mode

- The screen darkens about two seconds after you stop using the camera. About ten seconds later, the screen turns off. The camera turns off after approximately three minutes of inactivity.
- To activate the screen and prepare for shooting when the screen is off, press the shutter button halfway.

## Power-Saving Adjustment

- To conserve battery power, you should normally choose [4/2] tab → [Power saving] → [Auto power off] → [1 min.], and set [Display off] to [1 min.] or less.
- [Display off] and [Auto power off] are not available when Eco mode is set to [On].

## Customizing Shooting Information Display

- The information displayed when you press the **INFO** button can be thoroughly customized by choosing [4/4] tab → [Shooting info. disp.] → [Screen info. settings].
- For a smaller grid pattern, choose [4/4] tab → [Shooting info. disp.] → [Grid display].
- To switch from a brightness histogram to an RGB histogram or adjust the display size, choose [4/4] tab → [Shooting info. disp.] → [Histogram disp].
- The viewfinder display format can be changed by choosing [4/4] tab → [VF display format].

## Customizing Playback Information Display

- An example of customized display is shown at left on the display customization screen.
- To display Creative Assist setting details, add a [✓] mark to [2] in [4/4] tab → [Playback information display]. The information is now displayed when you press the **INFO** button.

## Adjusting the Touch-Screen Panel

- Increase the sensitivity of the touch-screen panel if gestures are not easily detected.
- Take the following precautions when using the touch-screen panel.
  - The screen is not pressure sensitive. Do not use sharp objects such as fingernails or ballpoint pens for touch operations.
  - Do not perform touch-screen operations when your fingers are wet.
  - If you perform touch-screen operations when the screen or your fingers are wet, the camera may not respond, or it may malfunction. In this case, turn the camera off and dry the screen with a cloth.
  - Do not apply screen protectors or adhesive film purchased separately. This may reduce the responsiveness of touch operations.
- The camera may be less responsive if you perform touch operations quickly when the setting is set to [Sensitive].



## Cleaning the Image Sensor



### Activating Sensor Cleaning

- The sensor cleaning also works while no lens is attached. If no lens is attached, do not insert your finger or a blower tip past the lens mount, which may damage the shutter curtains.
- For best results, clean with the camera placed upright on a desk or other surface.
- Repeated cleaning will not produce notably better results. Note that [Clean now ] may not be available immediately after cleaning.
- Contact a Customer Support Help Desk regarding dust or other material that cannot be removed by sensor cleaning.

### Cleaning the Sensor Manually

- The image sensor is extremely delicate. Clean the sensor with care.
- Use a blower without a brush attached. A brush may scratch the sensor.
- Do not insert the blower tip inside the camera beyond the lens mount. It can damage the shutter curtains.
- Never use canned air or gas to clean the sensor. The force of the air may damage the sensor, and any gas that adheres and freezes on the sensor may also damage it.
- If a smudge that cannot be removed with a blower remains, having the sensor cleaned by a Customer Support Help Desk is recommended.

## Setting Copyright Information to Record in Images

- Information you enter on the copyright information screen is recorded in the images you capture.
- To check the information entered, choose [5] tab → [Copyright information] → [Display copyright info.], and then press the  button.
- You can also use EOS Utility to enter, change, or delete copyright information on the camera. Some characters entered with the software may not be displayed on the camera but will be correctly recorded in images.
- You can check copyright information recorded in images by using the software, once you save the images to a computer.
- Download the EOS Utility instruction manual from the Canon website as needed. For downloading instructions, see “Installing the Software” (42).

### Deleting All Copyright Information

- You can delete both the author's name and copyright details at the same time, but copyright information already recorded in images is not deleted.

## Restoring Default Camera Settings

### Restoring Camera Defaults

- Basic settings such as [Language ] and [Date/Time/Zone] are not restored to defaults.



# Troubleshooting

Troubleshoot camera issues as described in this section. If the issue persists, contact a Customer Support Help Desk.

## Power

The battery pack cannot be charged.

- Do not use any battery packs other than a genuine Canon Battery Pack LP-E12.

The battery charger lamp blinks.

- The charge lamp blinks in orange and a protection circuit stops charging if (1) problems occur with the battery charger or battery pack or (2) communication is not possible with the battery pack (when non-Canon battery packs are used). In the case of (1), unplug the charger, reinsert the battery pack, and wait 2 – 3 minutes before plugging the charger in again. If the problem persists, contact a Customer Support Help Desk.

## Shooting

Strange display on the screen under low light.

- Screen brightness is automatically increased when you are shooting under low light, so that it is easier to check how shots are composed. However, on-screen image brightness may not match the brightness of your shots. Note that any on-screen image distortion or jerky subject motion will not affect recorded images.



Strange display on the screen when shooting.

- Note that the following display problems are not recorded in still images but are recorded in movies.
  - The screen may flicker and horizontal banding may appear under fluorescent or LED lighting.
- Focusing is not possible if you are closer to the subject than the minimum focusing distance of the lens. To determine the minimum focusing distance, check the lens. The lens minimum focusing distance is measured from the  (focal plane) mark on the top of the camera to the subject.

Continuous shooting suddenly stops.

- Continuous shooting stops automatically to protect the camera after about 1,000 shots are taken at one time. Release the shutter button a moment before you resume shooting.

Movie recording or playback suddenly stops.

- For  or , use a memory card with a UHS speed class of 3.



Shots are affected by linear noise or moiré.

- Some subjects make shots more susceptible to linear noise or moiré. This is more likely to happen under the following conditions.
  - Subjects have fine horizontal stripes or checkered patterns.
  - The sun, lights, or other sources of bright light are visible on the shooting screen, or are nearby.
- In this case, taking the following steps may reduce noise or moiré.
  - Resize the subject by changing the focusing distance or zooming in or out.
  - Recompose the shot to keep sources of bright light off the shooting screen.
  - Attach a lens hood to prevent bright light from shining into the lens.
- Images may also be affected by linear noise or moiré if you shift or tilt a TS-E lens.

## Shooting Movies

Subjects look distorted.

- Subjects that pass in front of the camera quickly may look distorted.

## Display

[###] is displayed.

- [###] is displayed when the number of images on a memory card exceeds the number that can be displayed.

## Wi-Fi

Cannot access the Wi-Fi menu by pressing the (W) button.

- The Wi-Fi menu is not available when the camera is connected to a computer or printer with a cable. Disconnect the cable.

Images take a long time to send. / The wireless connection is disrupted.

- Do not use the camera near sources of Wi-Fi signal interference such as microwave ovens or other equipment operating on the 2.4 GHz band.
- Bring the camera closer to the other device you are trying to connect to (such as the access point), and make sure there are no objects between the devices.

Cannot connect to the access point.

- Confirm that the access point channel is set to a channel supported by the camera (1-90). Note that instead of auto channel assignment, it is advisable to specify a supported channel manually.

Cannot pair with a smartphone via Bluetooth.

- Pairing with a smartphone via Bluetooth is not possible if you are using Wireless Remote Control BR-E1 with [Bluetooth function] set to [Remote].



## Errors and Warnings

If an error message is displayed, respond as follows.

### Error Codes

- In case of problems with the camera, error codes (in the format Errxx) and recommended responses are displayed.

Number	Message and Response
01	Communications between the camera and lens is faulty. Clean the lens contacts.
	→ Clean the electrical contacts on the camera and lens, use a Canon lens, or reinsert the battery pack.
02	Card cannot be accessed. Reinsert/change card or format card with camera.
	→ Reinsert the memory card, use a different card, or format the card.
04	Cannot save images because card is full. Replace card.
	→ Use a different memory card, erase unneeded images, or format the card.
10, 20, 30, 40, 50, 60, 70, 80, 99	An error prevented shooting. Turn the camera off and on again or re-install the battery.
	→ Use the power switch, reinsert the battery pack, or use a Canon lens.

\*If the problem persists, write down the error code (Errxx) and contact a Customer Support Help Desk.





## Wi-Fi

### Device with same IP address exists on selected network

- Reset the IP address so that it does not conflict with another.

### Disconnected/Could not send the image

- You may be in an environment where Wi-Fi signals are obstructed.
- Avoid using the camera's Wi-Fi function around microwave ovens and other devices that operate on the 2.4 GHz band.
- Bring the camera closer to the other device you are trying to connect to (such as the access point), and make sure there are no objects between the devices.
- Check for errors on the connected device.

### Not enough free space on server

- Delete unneeded images on the server and check the free space before you attempt transmission again.

### Check the network settings

- Make sure your computer can connect to the Internet under the current network settings.



## Part 3: Appendix

Helpful information when using the camera.

### On-Screen Information

#### When Shooting

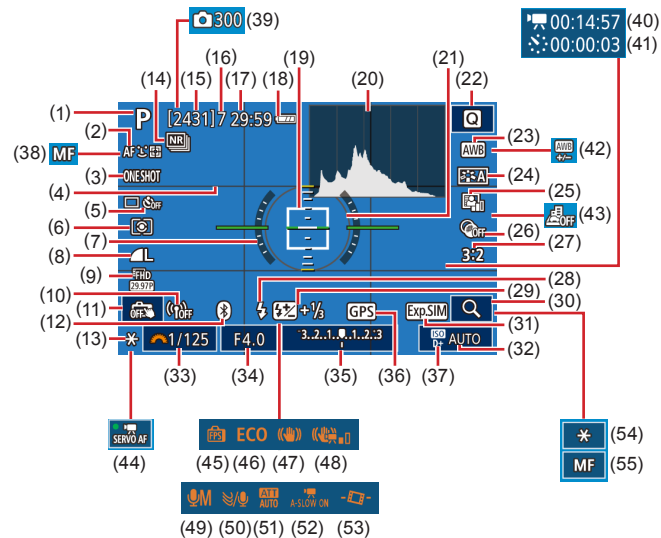

- |  |   |
|--|---|
| (1) Shooting mode, Scene icon                      | (9) Movie quality (pixel count, frame rate) |
| (2) AF method                                      | (10) Wi-Fi signal strength                  |
| (3) AF operation                                   | (11) Touch Shutter                          |
| (4) Grid lines                                     | (12) Bluetooth connection status            |
| (5) Drive mode/Self-timer                          | (13) AE lock                                |
| (6) Metering mode                                  | (14) High ISO speed noise reduction         |
| (7) Electronic level                               | (15) Recordable shots                       |
| (8) Still image quality (compression, pixel count) | (16) Maximum continuous shots               |



- |   |                               |
|---|-------------------------------|
| (17) Remaining time   | (37) Highlight tone priority  |
| (18) Battery level  | (38) Manual focus             |
| (19) AF point   | (39)  Number of shots         |
| (20) Histogram  | (40)  Time required           |
| (21) Metering frame   | (41)  Interval                |
| (22) Quick Control screen                                       | (42) White balance correction |
| (23) White balance  | (43) Miniature effect movie   |
| (24) Picture Style  | (44) Movie Servo AF           |
| (25) Auto Lighting Optimizer                                    | (45) Display performance      |
| (26) Creative filters   | (46) Eco mode                 |
| (27) Still image aspect ratio                                   | (47) Image stabilization      |
| (28) Flash mode   | (48) Digital IS for movies    |
| (29) Flash exposure compensation /<br>Flash output level        | (49) Audio recording mode     |
| (30) Magnify  | (50) Wind filter              |
| (31) Exposure simulation  | (51) Attenuator               |
| (32) ISO speed  | (52)  Auto slow shutter       |
| (33) Shutter speed  | (53) Auto level               |
| (34) Aperture value   | (54) Movie AE lock            |
| (35) Exposure compensation                                      | (55) AF/MF indicator          |
| (36) Bluetooth smartphone connection,<br>GPS acquisition status |                               |

## Battery Level

An on-screen icon or message indicates the battery charge level.

Display	Details
	Sufficient charge
	Slightly depleted, but sufficient
(Blinking red)	Nearly depleted—charge the battery pack soon
	Depleted—charge the battery pack immediately

## During Playback

### Info Display 1

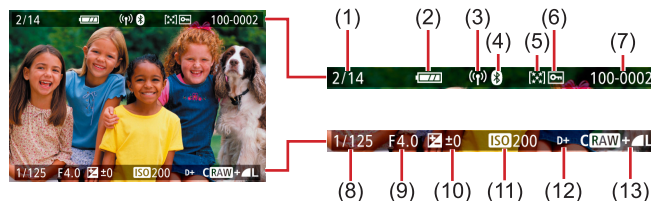

- |                                  |                                  |
|----------------------------------|----------------------------------|
| (1) Current image / Total images | (8) Shutter speed                |
| (2) Battery level                | (9) Aperture value               |
| (3) Wi-Fi signal strength        | (10) Exposure compensation level |
| (4) Bluetooth connection status  | (11) ISO speed                   |
| (5) Protection                   | (12) Highlight tone priority     |
| (6) Folder number - File number  | (13) Image quality*              |

\*Images captured with a creative filter, resizing, cropping, or red-eye correction applied are labeled with . Cropped images are labeled with .



## Info Display 2

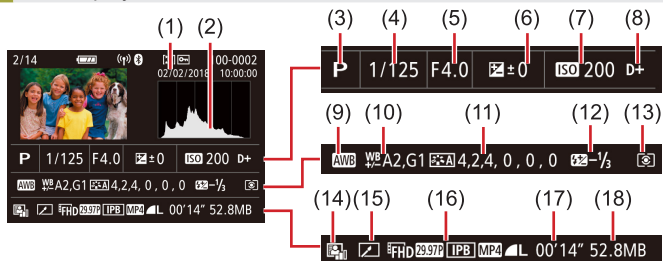

- |                                 |                                    |
|---------------------------------|------------------------------------|
| (1) Shooting date/time          | (10) White balance correction      |
| (2) Histogram                   | (11) Picture Style setting details |
| (3) Shooting mode               | (12) Flash exposure compensation   |
| (4) Shutter speed               | (13) Metering mode                 |
| (5) Aperture value              | (14) Auto Lighting Optimizer       |
| (6) Exposure compensation level | (15) Edited*1                      |
| (7) ISO speed                   | (16) Image quality*2               |
| (8) Highlight tone priority     | (17) Movie recording time          |
| (9) White balance               | (18) Image size                    |

\*1 Displayed for images with a creative filter, resizing, cropping, or red-eye correction applied.

\*2 Cropped images are labeled with [C].

## Info Display 3

Shows the lens name, focal length, and an RGB histogram. Note that long lens names may not be fully displayed. Information on the top of the screen is the same as for Info Display 2.

## Info Display 4

Shows white balance information. Information on the top of the screen is the same as for Info Display 2.

## Info Display 5

Shows Picture Style information. Information on the top of the screen is the same as for Info Display 2.

## Info Display 6

Shows noise-reduction settings for long exposures and high ISO speeds. Information on the top of the screen is the same as for Info Display 2.

## Info Display 7

Shows lens correction data and information about correction of peripheral illumination, chromatic aberration, and diffraction. Information on the top of the screen is the same as for Info Display 2.

## Info Display 8

Shows image recipient information and the sending status. Information on the top of the screen is the same as for Info Display 2.

## Info Display 9

Shows GPS information. Information on the top of the screen is the same as for Info Display 2.



## Specifications

### Type

Category ..... Digital single-lens non-reflex AF/AE camera

### Image Sensor

#### Image size

Shooting screen size  
(Recording image size)..... Approx. 22.3 x 14.9 mm

#### Number of pixels

Camera Effective Pixels  
(Pixels may decrease due  
to image processing)..... Approx. 24.1 megapixels  
Total Pixels..... Approx. 25.8 megapixels

Aspect ratio..... 3:2

Dust removal feature (Auto/Manual)..... Provided

### Focus Control

AF method ..... Face+Tracking AF, Zone AF,  
1-point AF

Face+Tracking AF  
AF points (max.)  
(Switches automatically depending  
on the lens type)..... 143/99 points

Zone AF  
AF frames (max.) ..... 25 frames

Focusing Brightness Range  
(room temperature 23 °C/73 °F, ISO 100,  
when using EF-M22mm F2 STM)  
EV value ..... -2 - 18

### Focus operation

#### Still Image

TTL autofocus..... One-Shot AF, Servo AF  
Continuous AF ..... Provided  
MF (Manual focus)..... MF peaking, Electronic manual  
focus on lens (focus is manually  
adjusted after One-Shot AF  
operation)

#### Movie

MF (Manual focus)..... MF peaking, Electronic manual  
focus on lens (focus is manually  
adjusted after One-Shot AF  
operation)

Movie servo AF (Fixed to AF  
for High Frame Rate Movies)..... Provided  
Magnified display in Live View..... Approx. 5x / Approx. 10x

Touch & drag AF ..... Provided

Eye detection AF (Fixed to One-Shot AF) ... Provided

AF-assist Beam ..... Built-in LED lamp

### Exposure Control

#### Metering mode

Still Image ..... Real-time metering using the  
image sensor (Evaluative  
metering, Partial metering, Spot  
metering, Center-weighted  
average)  
Movie ..... Real-time metering using the  
image sensor (Center-weighted  
average)

#### Brightness metering range (room temperature 23 °C/73 °F, ISO 100)

Still Image EV value ..... 0 - 20  
Movie EV value ..... 0 - 20

#### Exposure control

Still Image ..... Program AE, Shutter priority AE,  
Aperture priority AE, Manual  
exposure

Wireless Features

Accessories

Learning About the Camera

Setup and Basics

Shooting

Playback

Settings

Troubleshooting

Errors and Warnings

Appendix

Index



Exposure control

Still Image

- Exposure compensation .....±3 stop in 1/3-stop increments
- Program Shift..... Provided
- AE lock ..... Manual/Auto
- AE Bracketing .....±2 stop in 1/3-stop increments  
(Can be used together with manual compensation)

Movie

- Exposure compensation .....±3 stop in 1/3-stop increments
- AE lock ..... Manual

ISO speed (recommended exposure index)

Still Image

ISO Auto Range

- Min. speed (AUTO mode).....ISO 100
- Max. speed (AUTO mode).....ISO 6400
- Max. speed limit setting

in ISO Auto ..... P mode, Tv mode, Av mode, M mode, When movie manual exposure is selected

Available speed settings (P mode)

- Min. speed .....ISO 100
- Max. speed .....ISO 25600
- Expanded .....ISO 51200
- Number of stop(s) that can be set ..... 1/3-stop

Movie

4K (3840 x 2160)

- Auto settings
  - Min. speed .....ISO 100
  - Max. speed .....ISO 6400
- Manual settings
  - Min. speed .....ISO 100
  - Max. speed .....ISO 6400
  - Expanded .....ISO 6400

Full HD (1920 x 1080)

- Auto settings
  - Min. speed .....ISO 100
  - Max. speed .....ISO 12800
- Manual settings
  - Min. speed .....ISO 100
  - Max. speed .....ISO 12800
  - Expanded .....ISO 25600

HD (1280 x 720)

- Auto settings
  - Min. speed .....ISO 100
  - Max. speed .....ISO 12800
- Manual settings
  - Min. speed .....ISO 100
  - Max. speed .....ISO 12800
  - Expanded .....ISO 25600



## White Balance

WB settings.....	Auto (Ambience priority, White priority), Day Light, Shade, Cloudy, Tungsten light, White fluorescent light, Flash, Custom, Color temperature
White balance correction .....	Provided

## Shutter

Method.....	Electronically controlled focal-plane shutter (Focal-plane, Touch Shutter)
Silent shutter.....	Provided
Shutter Speed	
BULB (Shooting mode : M Only).....	Provided
Total shutter speed range	
Max. Tv.....	30 sec.
Min. Tv.....	1/4000 sec.
Fastest synchronized shutter speed with flash.....	1/200 sec.

## Flash

Built-in Flash	
Type.....	Manual pop-up flash
Specification	
Guide number (ISO 100/m).....	Gno. Approx. 5
Flash control .....	E-TTL II metering, Red-eye reduction

## Viewfinder/Monitor

Electronic color viewfinder	
Screen Size .....	0.39 type
Number of dots .....	Approx. 2.36 million dots
Monitor	
Type.....	TFT color liquid crystal
Screen Size .....	3.0 type
Number of dots .....	Approx. 1.04 million dots
Depth-of-field preview .....	Provided

## Shooting

Image Processing	
Noise reduction	
Long exposure shots .....	At exposure of one second and above and at bulb exposure
High ISO speed shots.....	At any ISO Speed
Image correction	
Auto Lighting Optimizer .....	Provided
Highlight tone priority.....	Provided
Lens correction	
(EF-M lens has in-lens correction data)....	Peripheral illumination correction, Distortion correction, Digital lens optimizer, Chromatic aberration correction, Diffraction correction
Picture Style.....	Auto, Standard, Portrait, Landscape, Fine Detail, Neutral, Faithful, Monochrome, User Def.1, User Def.2, User Def.3



## Continuous shooting

Drive Mode ..... Single shooting, High-speed continuous shooting, Low-speed continuous shooting

## Shooting speed









## One-Shot AF

High-speed continuous shooting speed ..... Max.: approx. 10.0 shots/sec.  
Low-speed continuous shooting speed ..... Max.: approx. 4.0 shots/sec.

## Servo AF

High-speed continuous shooting speed ..... Max.: approx. 7.4 shots/sec.  
Low-speed continuous shooting speed ..... Max.: approx. 4.0 shots/sec.

## Maximum number of shots at burst

	Approx. 33 shots
	
	Approx. 30 shots
	
	Approx. 29 shots
	
	Approx. 30 shots
	
	Approx. 10 shots

## Recording

File Format..... DCF-compliant DPOF compatible (Version 1.1)

## Data type

## Still Images

Recording Format..... Exif 2.31 (DCF 2.0)  
Image (RAW images taken in continuous shooting are A/D converted into 12-bit format.)..... JPEG/RAW (CR3 a Canon 14-bit RAW format)

## Movies

Recording Format..... MP4  
Video..... MPEG-4 AVC/H.264  
Variable (average) bit rate

Audio ..... MPEG-4 AAC-LC (stereo)

Built-in microphone..... Stereo  
Rec. level adjustment ..... Provided  
Wind Filter  
(when using built-in microphone).... Provided  
Attenuator ..... Provided





Number of shots per a memory card  
Still Image (Measured at ISO100)  
Using a 32 GB (UHS-I) memory card

Image quality	Number of shots per a memory card (Approx.)
	3651 shots
	6782 shots
	6645 shots
	11741 shots
	9948 shots
	16455 shots
	16874 shots
	1084 shots
	835 shots

Movies  
Using a 32 GB (UHS-I) memory card

Image quality	Recording file size (Approx.)	Recordable time per a memory card (Approx.)
	15000 KB/sec.	35 min. 33 sec.
	7500 KB/sec.	1 hr. 11 min. 7 sec.
	3750 KB/sec.	2 hr. 22 min. 13 sec.
	6500 KB/sec.	1 hr. 22 min. 3 sec.
	3250 KB/sec.	2 hr. 44 min. 6 sec.

- Continuous recording is possible until the memory card becomes full or a single recording reaches approx. 29 minutes and 59 seconds. (Or when a single or recording reaches approx. 7 minutes and 29 seconds.)

Recording Media.....	SD/SDHC/SDXC memory cards
Create Folder.....	Immediately, Folder selection
File Numbering.....	Continuous, Auto Reset, Manual reset

## Playback

Zoom magnification display	
Zoom magnification.....	Min.: approx. 1.5 x Max.: approx. 10.0 x
Movie playback.....	Built-in speaker
Highlight alert/ Overexposed highlights blink.....	Provided
Rating.....	Provided
Protect.....	Provided
In-camera RAW image processing.....	Provided
Frame grab (4K movies only).....	Provided
Image browsing methods.....	Single image, Jump 10 images, Set number of shots, Date, Folder, Movies, Stills, Protected images, Image search (Rating, Date, Protected images, Type of file)
Slideshow.....	All images, Slideshow of images after selection from the search list
Post-processing of images (Possible only with images taken with same model).....	Creative filters (Grainy B/W, Soft focus, Fish-eye effect, Art bold effect, Water painting effect, Toy camera effect, Miniature effect), Resize, Cropping (Tilt correction), Red-Eye Correction



## Customizing

Customizable buttons and controls..... Shutter button, Cross button (up, down, left, right), AE lock button, M-Fn button, Movie button

Copyright Info ..... Provided

## Power

Battery Pack ..... LP-E12

Number of Still Image Shots

(CIPA compliant : room temperature 23 °C/73 °F)

Monitor On ..... Approx. 235 shots (Approx. 290 shots when power saving is enabled)

Electronic color viewfinder On ..... Approx. 235 shots (Approx. 290 shots when power saving is enabled)

Number of Still Image Shots (Eco Mode On)

Monitor On ..... Approx. 370 shots (Approx. 425 shots when power saving is enabled)

Movie Recording Time

(CIPA compliant : room temperature 23 °C/73 °F)

Monitor On ..... Approx. 85 min.

Electronic color viewfinder On ..... Approx. 85 min.

Movie Recording Time (Continuous Shooting)\*

Monitor On ..... Approx. 130 min.

Electronic color viewfinder On ..... Approx. 130 min.

\* Total shooting time when shooting is performed under the following conditions:

-Using default AUTO Mode

-Without using zooming and other operations

-When max. recording time per movie is reached and recording stops/resumes automatically

Playback Time (Time when playing back

a slideshow of still images)..... Approx. 4 hr.

## Interface

### Wired

Digital terminal

(Hi-Speed USB compliant) ..... Micro USB

HDMI OUT terminal ..... Type D

HDMI output while recording (shooting screen without sound)

HDMI output to HDR compatible TVs (Movie playback not supported.

JPEG images are not displayed in HDR)

### Wireless

NFC ..... NFC Forum Type 3/4 Tag compliant (Dynamic)

### Bluetooth

Compliance standards ..... Bluetooth Ver. 4.1 (Bluetooth low energy technology)

Transmission scheme ..... GFSK modulation scheme

### Wi-Fi

Compliance standards ..... IEEE 802.11b (DS-SS modulation),  
IEEE 802.11g (OFDM modulation),  
IEEE 802.11n (OFDM modulation)

Transmission frequency

Frequency ..... 2401 - 2473 MHz

Channels ..... 1 - 11 ch

### Security

Infrastructure mode ..... WPA2-PSK (AES/TKIP),

WPA-PSK (AES/TKIP), WEP

\* Wi-Fi Protected Setup compliant

Camera access point mode ..... WPA2-PSK (AES)



**Operating Environment**

Temperature.....	Min.: 0 °C (32 °F), Max.: 40 °C (104 °F)
Humidity.....	Available humidity: 85 % or less

**Dimensions (CIPA compliant)**

W .....	Approx. 116.3 mm (Approx. 4.6 in.)
H .....	Approx. 88.1 mm (Approx. 3.5 in.)
D .....	Approx. 58.7 mm (Approx. 2.3 in.)

**Weight (CIPA compliant)**

Black	
Including Battery Pack, Memory Card .....	
Camera Body Only .....	Approx. 387 g (Approx. 13.7 oz.)
Camera Body Only .....	Approx. 351 g (Approx. 12.4 oz.)
White	
Including Battery Pack, Memory Card .....	
Camera Body Only .....	Approx. 390 g (Approx. 13.8 oz.)
Camera Body Only .....	Approx. 354 g (Approx. 12.5 oz.)

**Battery Pack LP-E12**

Type .....	Rechargeable lithium-ion battery
Rated voltage.....	7.2 V DC
Battery capacity .....	875 mAh
Working temperature range .....	Charging: 5 °C - 40 °C (41 °F - 104 °F) Shooting: 0 °C - 40 °C (32 °F - 104 °F)

**Battery Charger LC-E12/LC-E12E**

Compatible battery.....	Battery Pack LP-E12
Recharging time.....	Approx. 2 hours (at room temperature)
Rated input .....	100 - 240 V AC (50/60 Hz)
Rated output .....	8.4 V DC / 540 mA
Working temperature range .....	5 °C - 40 °C (41 °F - 104 °F)

- All the data above is based on Canon's testing standards and CIPA (Camera & Imaging Products Association) testing standards and guidelines.
- Dimensions, maximum diameter, length and weight listed above are based on CIPA Guidelines (except weight for camera body only).
- Product specifications and the exterior are subject to change without notice.
- If a problem occurs with a non-Canon lens attached to the camera, consult the respective lens manufacturer.



**Numbers**

1-point AF 60

**A**

Accessories 36  
 AEB shooting 56  
 AE lock 57  
 AF points 60  
 AF-point zoom 60  
 Aspect ratio 69  
 Auto Lighting Optimizer 57  
 Auto mode (shooting mode) 52  
 Auto rotate 73  
 Av (shooting mode) 65

**B**

Battery charger 36  
 Battery pack  
   Charging 48  
   Eco mode 76  
   Level 83  
 Bluetooth 7  
 Bulb exposure 66

**C**

Camera  
   Resetting 77  
 Camera Connect 7  
 CANON iMAGE GATEWAY 27  
 Changing or deleting connection  
   settings 32  
 Charging 48  
 Chromatic aberration correction 63  
 Cleaning (image sensor) 77

Close-up (shooting mode) 55  
 Color space 58  
 Color temperature 58  
 Color (white balance) 58  
 Compact power adapter 36, 39  
 Connecting to computers via Wi-Fi  
   21, 23  
 Creative Assist (shooting mode) 54  
 Creative filters (shooting mode) 56  
 Cropping 73  
 Custom white balance 58

**D**

Date/time/zone  
   Settings 48  
 DC coupler 36, 39  
 Defaults → Resetting  
 Diffraction correction 63  
 Digital Lens Optimizer 63  
 Display period 75  
 Distortion correction 63  
 DPOF 45  
 Dust delete data 64

**E**

Eco mode 76  
 Editing  
   Cropping 73  
   Red-eye correction 73  
   Resizing images 73  
 Erasing 72  
 Error messages 80  
 Exposure  
   AE lock 57

FE lock 62

**F**

Face+Tracking 60  
 Favorites 72  
 FE lock 62  
 File numbering 75  
 Fish-eye effect (shooting mode) 56  
 Flash  
   Flash exposure compensation 62  
   Flash off 61  
   Slow synchro 41  
 Flash exposure compensation 62  
 Flash off 61  
 Focusing  
   AF points 60  
   MF peaking 60  
   Servo AF 61  
 Focus lock 60  
 Food (shooting mode) 55

**G**

Grid lines 76

**H**

Handheld night scene (shooting  
 mode) 55  
 HDMI cable 38  
 HDR art bold (shooting mode) 56  
 HDR art embossed (shooting mode)  
   56  
 HDR art standard (shooting mode) 56  
 HDR art vivid (shooting mode) 56  
 HDR Backlight Control (shooting  
 mode) 55  
 Highlight tone priority 57  
 Household power 39  
 Hybrid Auto (shooting mode) 52

**I**

Icons 82, 83  
 Image dust prevention 77  
 Image quality 68  
 Images  
   Display period 75  
   Playback → Viewing  
 Image stabilization 62  
 Index display 71  
 Indicator 51  
 Installation 42  
 ISO expansion 66  
 ISO speed 57

**J**

Jump display 72

**L**

Level 83  
 Long exposure 66  
 Long exposure noise reduction 64

**M**

M (shooting mode) 65  
 Macro photography 55  
 Memory cards 48  
 Menu  
   Basic operations 50  
 Metering method 57  
 MF peaking 60  
 Miniature effect movie (shooting  
 mode) 67  
 Miniature effect (shooting mode) 56  
 Movies  
   Editing 74  
   Image quality (pixel count/frame  
   rate) 69  
 Multi-function button 66



Multi shot noise reduction 64

## N

Noise reduction

Long exposure 64

## P

Panning (shooting mode) 55

Peripheral illumination correction 63

Photobook set-up 46

PictBridge 38, 44

Picture Style 58

Playback → Viewing

Power 36 → Battery charger

→ Battery pack → Compact power  
adapter

Power saving 76

Printing 44

Protect images 72

Protecting 72

## Q

Quick Control screen

Basic operations 50

## R

Rating 72

RAW 69

RAW image processing 73

Red-eye correction 13

Resetting 33, 77

Resizing images 73

Rotating 73

## S

Saving images to a computer 43

Screen

Icons 82, 83

Searching 71

Self portrait (shooting mode) 54

Self-timer 68

Customizing the self-timer 68

Sending images 27

Sending images to a smartphone 7

Sending images to Web services 27

Sensor cleaning 77

Servo AF 61

Shooting

Shooting information 82

Silent mode (shooting mode) 55

Slideshows 71

Slow synchro 41

Smooth skin (shooting mode) 54

Soft focus (shooting mode) 56

Software

Installation 42

Saving images to a computer 43

Sports (shooting mode) 55

## T

Terminal 38, 39, 44

Time-lapse movie (shooting mode) 67

Tone priority 57

Touch Shutter 68

Toy camera effect (shooting mode) 56

Troubleshooting 78

TV display 38

Tv (shooting mode) 65

## V

Viewing 70

Image search 71

Index display 71

Jump display 72

Slideshows 71

TV display 38

## W

White balance (color) 58

## Z

Zone AF 60



## Security Precautions

Because Wi-Fi uses radio waves to transmit signals, security precautions more stringent than when using a LAN cable are required.

Keep the following points in mind when using Wi-Fi.

- Only use networks you are authorized to use.  
This product searches for Wi-Fi networks in the vicinity and displays the results on the screen. Networks you are not authorized to use (unknown networks) may also be displayed. However, attempting to connect to or using such networks could be regarded as unauthorized access. Be sure to use only networks you are authorized to use, and do not attempt to connect to other unknown networks.

If security settings have not been properly set, the following problems may occur.

- Transmission monitoring  
Third parties with malicious intent may monitor Wi-Fi transmissions and attempt to acquire the data you are sending.
- Unauthorized network access  
Third parties with malicious intent may gain unauthorized access to the network you are using to steal, modify, or destroy information. Additionally, you could fall victim to other types of unauthorized access such as impersonation (where someone assumes an identity to gain access to unauthorized information) or springboard attacks (where someone gains unauthorized access to your network as a springboard to cover their tracks when infiltrating other systems).

To prevent these types of problems from occurring, be sure to thoroughly secure your Wi-Fi network.

Only use this camera's Wi-Fi function with a proper understanding of Wi-Fi security, and balance risk and convenience when adjusting security settings.

## Third-Party Software

- AES-128 Library

Copyright (c) 1998-2008, Brian Gladman, Worcester, UK. All rights reserved.

### LICENSE TERMS

The redistribution and use of this software (with or without changes) is allowed without the payment of fees or royalties provided that:

1. source code distributions include the above copyright notice, this list of conditions and the following disclaimer;
2. binary distributions include the above copyright notice, this list of conditions and the following disclaimer in their documentation;
3. the name of the copyright holder is not used to endorse products built using this software without specific written permission.

### DISCLAIMER

This software is provided 'as is' with no explicit or implied warranties in respect of its properties, including, but not limited to, correctness and/or fitness for purpose.



- CMSIS Core header files  
Copyright (C) 2009-2015 ARM Limited.  
All rights reserved.

Redistribution and use in source and binary forms, with or without modification, are permitted provided that the following conditions are met:

- Redistributions of source code must retain the above copyright notice, this list of conditions and the following disclaimer.
- Redistributions in binary form must reproduce the above copyright notice, this list of conditions and the following disclaimer in the documentation and/or other materials provided with the distribution.
- Neither the name of ARM nor the names of its contributors may be used to endorse or promote products derived from this software without specific prior written permission.

THIS SOFTWARE IS PROVIDED BY THE COPYRIGHT HOLDERS AND CONTRIBUTORS "AS IS" AND ANY EXPRESS OR IMPLIED WARRANTIES, INCLUDING, BUT NOT LIMITED TO, THE IMPLIED WARRANTIES OF MERCHANTABILITY AND FITNESS FOR A PARTICULAR PURPOSE ARE DISCLAIMED. IN NO EVENT SHALL COPYRIGHT HOLDERS AND CONTRIBUTORS BE LIABLE FOR ANY DIRECT, INDIRECT, INCIDENTAL, SPECIAL, EXEMPLARY, OR CONSEQUENTIAL DAMAGES (INCLUDING, BUT NOT LIMITED TO, PROCUREMENT OF SUBSTITUTE GOODS OR SERVICES; LOSS OF USE, DATA, OR PROFITS; OR BUSINESS INTERRUPTION) HOWEVER CAUSED AND ON ANY THEORY OF LIABILITY, WHETHER IN CONTRACT, STRICT LIABILITY, OR TORT (INCLUDING NEGLIGENCE OR OTHERWISE) ARISING IN ANY WAY OUT OF THE USE OF THIS SOFTWARE, EVEN IF ADVISED OF THE POSSIBILITY OF SUCH DAMAGE.

- KSDK Peripheral Drivers, Flash / NVM, KSDK H/W Abstraction Layer (HAL)  
(c) Copyright 2010-2015 Freescale Semiconductor, Inc.  
ALL RIGHTS RESERVED.

Redistribution and use in source and binary forms, with or without modification, are permitted provided that the following conditions are met:

- \* Redistributions of source code must retain the above copyright notice, this list of conditions and the following disclaimer.
- \* Redistributions in binary form must reproduce the above copyright notice, this list of conditions and the following disclaimer in the documentation and/or other materials provided with the distribution.
- \* Neither the name of the <organization> nor the names of its contributors may be used to endorse or promote products derived from this software without specific prior written permission.

THIS SOFTWARE IS PROVIDED BY THE COPYRIGHT HOLDERS AND CONTRIBUTORS "AS IS" AND ANY EXPRESS OR IMPLIED WARRANTIES, INCLUDING, BUT NOT LIMITED TO, THE IMPLIED WARRANTIES OF MERCHANTABILITY AND FITNESS FOR A PARTICULAR PURPOSE ARE DISCLAIMED. IN NO EVENT SHALL <COPYRIGHT HOLDER> BE LIABLE FOR ANY DIRECT, INDIRECT, INCIDENTAL, SPECIAL, EXEMPLARY, OR CONSEQUENTIAL DAMAGES (INCLUDING, BUT NOT LIMITED TO, PROCUREMENT OF SUBSTITUTE GOODS OR SERVICES; LOSS OF USE, DATA, OR PROFITS; OR BUSINESS INTERRUPTION) HOWEVER CAUSED AND ON ANY THEORY OF LIABILITY, WHETHER IN CONTRACT, STRICT LIABILITY, OR TORT (INCLUDING NEGLIGENCE OR OTHERWISE) ARISING IN ANY WAY OUT OF THE USE OF THIS SOFTWARE, EVEN IF ADVISED OF THE POSSIBILITY OF SUCH DAMAGE.



## Personal Information and Security Precautions

If personal information and/or Wi-Fi security settings, such as passwords, etc., are saved on the camera, please be aware that such information and settings may still remain in the camera.

When transferring the camera to another person, disposing of it, or sending it for repair, be sure to take the following measures to prevent the leakage of such information and settings.

- Erase registered Wi-Fi security information by choosing [Clear settings] in the Wi-Fi settings.

Wireless Features/Accessories

Wireless Features

Accessories

Learning About the Camera

Setup and Basics

Shooting

Playback

Settings

Troubleshooting

Errors and Warnings

Appendix

Index





## Free Manuals Download Website

<http://myh66.com>

<http://usermanuals.us>

<http://www.somanuals.com>

<http://www.4manuals.cc>

<http://www.manual-lib.com>

<http://www.404manual.com>

<http://www.luxmanual.com>

<http://aubethermostatmanual.com>

Golf course search by state

<http://golfingnear.com>

Email search by domain

<http://emailbydomain.com>

Auto manuals search

<http://auto.somanuals.com>

TV manuals search

<http://tv.somanuals.com>