

Canon

FAXPHONE L80

Basic Guide

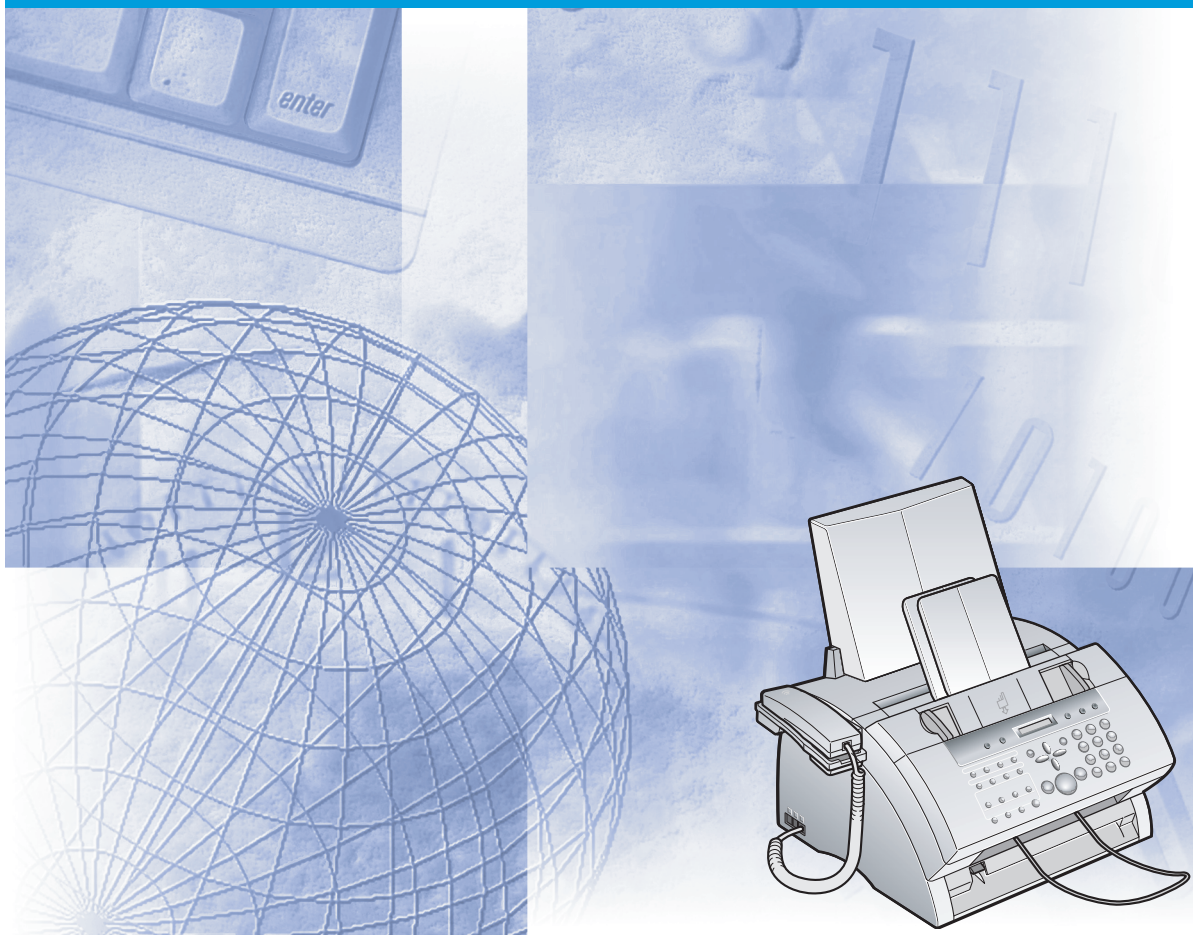

Please read this guide before operating this equipment.
After you finish reading this guide, store it in a safe place for future reference.

ENG

Where to Find Help

Canon offers a full range of customer technical support* options:

- For e-mail support, the latest driver downloads and answers to frequently asked questions (www.usa.canon.com/consumer)
- Free technical support Monday-Saturday (excluding holidays) for products still under warranty (1-800-828-4040)
- Technical support for products no longer under warranty (1-757-413-2848)



Within Canada, call for technical support 24 hours a day, 7 days a week (1-800-263-1121).

* Support program specifics are subject to change without notice.

Product Type and Model

FAXPHONE L80: Facsimile Transceiver, Model H12250

Copyright

This Basic Guide is copyrighted by Canon U.S.A., Inc. with all rights reserved. Under the copyright laws, this guide may not be reproduced in any form, in whole or part, without prior written consent of Canon U.S.A.

© 2003 Canon U.S.A., Inc.

Disclaimer

Canon U.S.A., Inc. has reviewed this guide thoroughly in order to make it an easy to use guide for your Canon FAXPHONE L80 system. All statements, technical information, and recommendations in this guide and in any guides or related documents are believed reliable, but the accuracy and completeness thereof are not guaranteed or warranted, and they are not intended to be, nor should they be understood to be, representations or warranties concerning the products described.

Your FAXPHONE L80 has been sold to you subject to the limited warranties set forth in the warranty cards. Further, Canon U.S.A. reserves the right to make changes in the specifications of the products described in this guide at any time without notice and without obligation to notify any person of such changes.

Trademarks

Canon and FAXPHONE are registered trademarks, and UHQ is a trademark of Canon Inc.

All other product and brand names are registered trademarks, trademarks or service marks of their respective owners.



As an ENERGY STAR® Partner, Canon U.S.A. has determined that the FAXPHONE L80 meets the ENERGY STAR® guidelines for energy efficiency.



Super G3 is a phrase used to describe the new generation of fax units that use ITU-T V.34 standard 33.6 Kbps* modems. Super G3 High Speed Fax units allow transmission time of approximately three seconds* per page which results in reduced telephone line charges.

* Approximately three seconds per page document transmission time based on ITU-T No. 1 Chart, standard mode, at 33.6 Kbps modem speed. The Public Switched Telephone Network (PSTN) currently supports 28.8 Kbps modem speeds or lower, depending on telephone line conditions.

How to use the documentation provided

START HERE



Printed sheet

Set-Up Instructions

Be sure to read this sheet first!

This guide includes instructions for setting up your machine and getting it ready for use. Follow all steps in this guide before using your machine.



Printed manual

Basic Guide (This guide)

After following instructions in the Set-Up Instructions, we recommend you read this guide to familiarize yourself with the basic operation of all functions of your machine.



User's Guide

This guide, included as a PDF file in the FAXPHONE L80 printer driver software CD-ROM, includes comprehensive instructions on functions that can be performed directly from your machine. Refer to this guide for in-depth instructions not included in the Basic Guide, or if you want to learn more about advanced features.



Printer Driver Software User's Guide

This guide, included as a PDF file in the FAXPHONE L80 printer driver software CD-ROM, includes comprehensive instructions on using the FAXPHONE L80 printer driver software. Refer to this guide for full instructions on printing, scanning, and faxing from your computer.



Note

- To view the manuals in PDF format, Adobe Reader/Acrobat Reader/Acrobat is required. If Adobe Reader/Acrobat Reader/Acrobat is not installed on your system, please download it from the Adobe Systems Incorporated website (<http://www.adobe.com>).
- In addition to the above documentation, you can also refer to the online help in the FAXPHONE L80 printer driver software for online information about a window or dialog box, and for step by step instructions on performing FAXPHONE L80 printer driver tasks. To access the online help, select or click **Help** in the software.

Type conventions

Please read the list below of symbols, terms, and abbreviations used in this guide.



Indicates a warning concerning operations that may lead to death or injury to persons if not performed correctly. In order to use the machine safely, always pay attention to these warnings.



Indicates a caution concerning operations that may lead to injury to persons or damage to property if not performed correctly. In order to use the machine safely, always pay attention to these cautions.



Indicates operational warnings and restrictions. Be certain to read these items to operate the machine correctly, and to avoid damage to the machine.



Indicates notes for operation or additional explanations. Reading these is highly recommended.

(→ p. n-nn)	Indicates a page number where additional information can be found.
→ <i>Set-Up Instructions</i>	Refer to the Set-Up Instructions for more details.
→ <i>User's Guide</i>	Refer to the User's Guide (included in the CD-ROM) for more details.
→ <i>Software User's Guide</i>	Refer to the FAXPHONE L80 Printer Driver Software User's Guide (included in the CD-ROM) for more details.
default	A setting that remains in effect unless you change it.
menu	A list of settings from which you select an item to set up or change. A menu has a title which appears in the LCD.
click, double-click	Term used to select or choose a command or option on your computer, generally with a mouse.
fax or document	The original sheet(s) of paper you send or receive and copy with the machine.
TX/RX NO.	Denotes Transaction number.
TX	Denotes Sending.
RX	Denotes Receiving.

Safety information

Read this safety information thoroughly before using your machine, and keep it handy in case you need to refer to it later.



This product emits low level magnetic flux. If you use a cardiac pacemaker and feel abnormalities, please move away from this product and consult your doctor.



- Do not disassemble or modify. There are high-temperature and high-voltage components inside the machine which may result in a fire or electrical shock.
- Follow all warnings and instructions marked on the machine.

■ Location



Do not place the machine near alcohol, paint thinner, or other inflammable substances. If inflammable substances come into contact with electrical parts inside the machine, it may result in a fire or electrical shock.

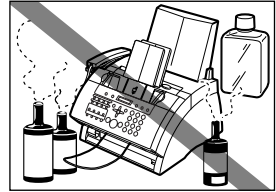

- Do not place the machine on top of a carpet or rug which has long pile. The threads may get inside the machine and cause a fire.
- Do not block or cover the ventilation port or any openings on the machine with objects, as this may result in a fire.
- Place the machine on a flat, stable, vibration-free surface that is strong enough to support its weight.

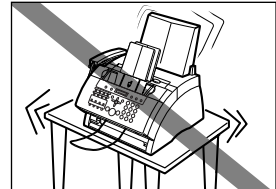

- Do not place objects around the power plug so that you are able at any time to readily disconnect the power plug from the wall outlet. Otherwise you will be unable to disconnect the power plug in case of an emergency.
- Make sure the area is free from dust.
- Make sure the location is not affected by extreme temperature changes, and always stays between 50°F and 90.5°F (10°C and 32.5°C).
- Make sure the relative humidity of the area is between 20% and 80%.
- Keep the machine away from direct sunlight.
- Do not use or store the machine outdoors.
- Do not install the machine near devices that contain magnets or generate magnetic fields, such as speakers.

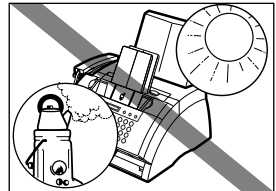

- To ensure proper ventilation, make sure the machine is approximately 4 inches (10 cm) away from walls and other equipment.

Power supply



- Do not damage or modify the power cord and power plug. Also do not place heavy objects on the power cord, pull on it, or extensively bend it. These actions may cause electrical damage and result in a fire or electrical shock.

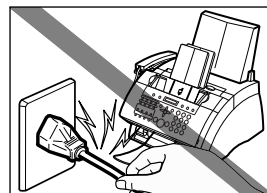

- Do not insert or unplug the power plug with wet hands, as this may result in electrical shock.

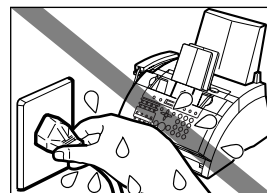

- Do not overload the wall outlet with too many electrical appliances, as this may result in a fire or electrical shock.
- Plug the machine into a standard 120 V AC, 60 Hz, three-prong grounded outlet. Operate the machine only from the type of power source indicated on the machine's label or a fire, electrical shock or malfunction may occur. If you are not sure of the type of power available, consult your local power company.
- Do not allow the power cord to be near objects that emit heat. The outer cover of the power cord may melt resulting in fire or electrical shock.
- Make sure the power cord is fully extended and has no knots in it when electricity is running through it. Knots etc. in the cord may result in fire or electrical shock.
- Fully insert the power plug securely into the electrical outlet. If the prongs of the power plug come into contact with metallic objects etc., it may result in fire or electrical shock.



- During electrical storms, disconnect the power cord from the power outlet. (Please note that any documents stored in the machine's memory will be deleted when you turn off the power.)

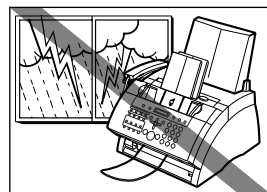

- Do not use an extension cord as this may result in fire or electrical shock.
- Disconnect the power cord if the machine will not be used for a long period such as during holidays.



- If dust accumulates around the plug of the power cord when it is connected to a power outlet, unplug the machine and wipe the plug with a clean, dry cloth.
- Do not plug the machine into the same circuit as appliances such as an air conditioner, television, or copier. These devices generate electrical noise which may interfere with your machine's operation.

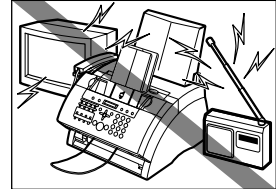

- Whenever you unplug the machine, wait at least five seconds before you plug it in again.
- Use only the power cord that came with the machine.
- Unplug the machine in the following conditions:
 - If the power cord or plug is damaged or frayed.
 - If liquid has spilled into the machine.
 - If the machine has been exposed to rain or water.
 - If the machine does not operate normally when you have followed the instructions in the guides included with your machine. Adjust only those controls that are covered by the instructions in the guides since improper adjustment of other controls may result in damage and will often require extensive work by a qualified technician to restore the product to normal operation.
 - If the machine has been dropped or damaged.
 - If the machine exhibits a distinct change in performance, indicating a need for servicing.

Handling



- Do not drop paper clips, staples, or other metal objects inside the machine. Also, do not spill water, liquid, or inflammable substances inside the machine. If these items come into contact with high-voltage parts inside the machine, it may result in a fire or electrical shock. If these items are dropped or spilled in the machine, unplug the power cord immediately with dry hands. Then, contact the Canon Customer Care Center.

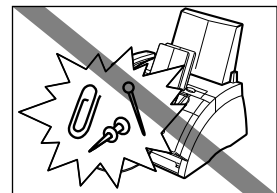

- Do not use any highly flammable spray near the machine. If gas from a spray comes into contact with the electrical components inside the machine, it will result in a fire.

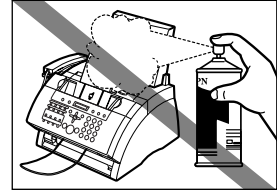

- There are high-voltage components inside the machine. If you are looking inside the machine to remove paper jams etc., do not allow metallic objects such as jewelry to come into contact with the inside of the machine. Contact may result in burns or electrical shock.



Do not place the following objects on top of the machine. If such objects come into contact with internal electrical components, the machine may short-circuit resulting in fire or electrical shock.

- Metallic objects such as jewelry and watches
- Containers of water or other liquids such as glasses, vases or pot plants
- If water etc. does spill inside the machine, immediately disconnect the power cord and contact the retailer.
- Do not touch the internal electrical parts as this may result in electrical shock.
- Do not place heavy objects on top of the machine as these may topple over and result in injury.
- Do not subject the machine to strong physical shock or vibration.
- Unplug the machine before moving it.
- Do not lift the machine by any of its attachments. Lift it by the recessed areas on the sides of the machine.
- A distinct change in performance may indicate a need for servicing.

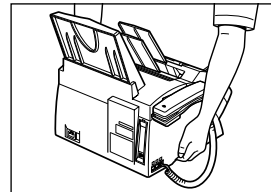

Maintenance



Do not service the machine yourself except as specifically described in this guide. If further servicing is required, contact the Canon Customer Care Center.

- Keep the machine clean. Dust accumulation may prevent the machine from operating properly.

Legal limitation on usage of your product and the use of images

Using your product to scan, print or otherwise reproduce certain documents, and the use of such images as scanned, printed or otherwise reproduced by your product, may be prohibited by law and may result in criminal and/or civil liability. A non-exhaustive list of these documents is set forth below. This list is intended to be a guide only. If you are uncertain about the legality of using your product to scan, print or otherwise reproduce any particular document, and/or of the use of the images scanned, printed or otherwise reproduced, you should consult in advance with your legal advisor for guidance.

- Paper money
- Money orders
- Certificates of deposit
- Postage stamps (canceled or uncanceled)
- Identifying badges or insignias
- Selective service or draft papers
- Checks or drafts issued by governmental agencies
- Motor vehicle licenses and certificates of title
- Traveler's checks
- Food stamps
- Passports
- Immigration papers
- Internal revenue stamps (canceled or uncanceled)
- Bonds or other certificates of indebtedness
- Stock certificates
- Copyrighted works/works of art without permission of copyright owner

Users in the U.S.A.

Pre-installation requirements for Canon facsimile equipment

A. Location

Supply a suitable table, cabinet, or desk. See the Appendix for the machine's dimensions and weight.

B. Order information

1. Only a single line, touch-tone or rotary telephone set is to be used.
2. Order an RJ11-C modular jack (USOC code), which should be installed by the telephone company. If the RJ11-C jack is not present, installation cannot occur.
3. Order a normal business line from your telephone company's business representative. The line should be a regular voice grade line or the equivalent. Use one line per machine.

DDD (DIRECT DISTANCE DIAL) LINE

-or-

IDDD (INTERNATIONAL DIRECT DISTANCE DIAL) LINE IF YOU COMMUNICATE OVERSEAS



Canon recommends an individual line following industry standards, e.g., the 2500 (Touch Tone) or 500 (Rotary/Pulse Dial) telephones. A dedicated extension off a PBX machine without “Call Waiting” can be used with your FAXPHONE L80. Key telephone systems are not recommended because they send non-standard signals to individual telephones for ringing and special codes, which may cause a fax error.

C. Power requirements

This equipment should be connected to a standard 120-volt AC, three-wire grounded outlet only. Do not connect this machine to an outlet or power line shared with other appliances that cause “electrical noise.” Air conditioners, electric typewriters, copiers, and machines of this sort generate electrical noise which often interferes with communications equipment and the sending and receiving of documents.

Connection of the equipment

This equipment complies with Part 68 of the FCC rules and the requirements adopted by the ACTA. On the rear panel of this equipment is a label that contains, among other information, a product identifier in the format US:AAAEQ##TXXXX. If requested, this number must be provided to the telephone company.

An FCC compliant telephone cord and modular jack are provided with this equipment. This equipment is designed to be connected to the telephone network or premises wiring using a compatible modular jack which is Part 68 compliant. See Installation instructions for details.

The Ringer Equivalence Number (REN) is used to determine the number of devices that may be connected to a telephone line. Excessive RENs on a telephone line may result in the devices not ringing in response to an incoming call. In most but not all areas, the sum of RENs should not exceed five (5.0). To be certain of the number of devices that may be connected to a line, as determined by the total RENs, contact the local telephone company. The REN for this product is part of the product identifier that has the format US:AAAEQ##TXXXX. The digits represented by ## are the REN without a decimal point (e.g., 03 is a REN of 0.3).

This equipment may not be used on coin service provided by the telephone company. Connection to party lines is subjected to state tariffs.

In case of equipment malfunction

Should any malfunction occur which cannot be corrected by the procedures described in this guide, disconnect the equipment from the telephone line and unplug the power cord. The telephone line should not be reconnected or the power cord plugged in until the problem is completely resolved. Users should contact Canon Authorized Service Facilities for servicing of equipment. Information regarding Authorized Service Facility

locations can be obtained by calling the Canon Customer Care Center. (1-800-828-4040)

Rights of the telephone company

Should the equipment cause harm to the telephone network, the telephone company may temporarily disconnect service. The telephone company also retains the right to make changes in facilities and services which may affect the operation of this equipment. When such changes are necessary, the telephone company is required to give adequate prior notice to the user.

FCC Notice

This device complies with Part 15 of the FCC Rules.

Operation is subject to the following two conditions:

- (1) This device may not cause harmful interference, and
- (2) this device must accept an interference received, including interference that may cause undesired operation.



Note

This equipment has been tested and found to comply with the limits for a class B digital device, pursuant to Part 15 of the FCC Rules. These limits are designed to provide reasonable protection against harmful interference in a residential installation. This equipment generates, uses and can radiate radio frequency energy and, if not installed and used in accordance with the instructions, may cause harmful interference to radio communications. However, there is no guarantee that interference will not occur in a particular installation. If this equipment does cause harmful interference to radio or television reception, which can be determined by turning the equipment off and on, the user is encouraged to try to correct the interference by one or more of the following measures:

- Reorient or relocate the receiving antenna.
- Increase the separation between the equipment and receiver.
- Connect the equipment into an outlet on a circuit different from that to which the receiver is connected.
- Consult the dealer or an experienced radio/TV technician for help.

Use of shielded cable is required to comply with class B limits in Subpart B of Part 15 of the FCC Rules.

Do not make any changes or modifications to the equipment unless otherwise specified in this guide. If such changes or modifications should be made, you could be required to stop operation of the equipment.

Canon U.S.A. Inc.
One Canon Plaza, Lake Success, NY 11042, U.S.A.
TEL No. 1-516-328-5000

The Telephone Consumer Protection Act of 1991 makes it unlawful for any person to use a computer or other electronic device to send any message via a telephone fax machine unless such message clearly contains in a margin at the top or bottom of each transmitted page or on the first page of the transmission, the date and time it is sent and an identification of the business or other entity, or other individual sending the message and the telephone number of the sending machine or such business, other entity, or individual.

To automatically enter this information into your machine, follow the instructions in Chapter 2 or on p. 2-5 of this guide.

Users in Canada

Pre-installation requirements for Canon facsimile equipment

A. Location

Supply a suitable table, cabinet, or desk. See the Appendix for the machine's dimensions and weight.

B. Order information

1. Provide only a single-line to touch-tone or rotary telephone set terminated with a standard 4-pin modular phone plug. (Touch-tone is recommended if available in your area.)
2. Order an CA11A modular jack (USOC code), which should be installed by the telephone company. If the CA11A jack is not present, installation cannot occur.
3. Order a normal business line from your telephone company's business representative. The line should be a regular voice grade line or equivalent. Use one line per machine.

DDD (DIRECT DISTANCE DIAL) LINE

-or-

IDDD (INTERNATIONAL DIRECT DISTANCE DIAL) LINE IF YOU
COMMUNICATE OVERSEAS



Canon recommends an individual line following industry standards [e.g., the 2500 (touch tone) or 500 (rotary/pulse dial) telephones]. A dedicated extension off a PBX machine without "Camp On" signals is also permissible with your FAXPHONE L80. Key telephone systems are not recommended because they send non-standard signals to individual telephones for ringing and special codes, which may cause a fax error.

C. Power requirements

The power outlet should be a three-prong grounded receptacle (Single or Duplex). It should be independent from copiers, heaters, air conditioners or any electric equipment that is thermostatically controlled. The rated value is 120 volts and 15 amperes. The CA11A modular jack should be relatively close to the power outlet to facilitate installation.

Notice

This equipment meets the applicable Industry Canada Terminal Equipment Technical Specifications. This is confirmed by the registration number. The abbreviation, IC, before the registration number signifies that registration was performed based on a Declaration of Conformity indicating that Industry Canada technical specifications were met. It does not imply that Industry Canada approved the equipment.

Cet appareil est conforme aux Spécifications techniques des équipements terminaux de l'Industrie du Canada. Ceci est confirmé par le numéro d'enregistrement. L'abréviation IC précédant le numéro d'enregistrement signifie que l'enregistrement a été effectué sur la base de la Déclaration de conformité indiquant que le produit est conforme aux spécifications techniques du Canada. Ceci n'implique pas que le produit ait été approuvé par l'industrie du Canada.

Before installing this equipment, users should ensure that it is permissible to be connected to the facilities of the local telecommunications company. The equipment must also be installed using an acceptable method of connection. The customer should be aware that compliance with the above conditions may not prevent degradation of service in some situations.

Repairs to certified equipment should be coordinated by a representative designated by the supplier. Any repairs or alterations made by the user to this equipment, or equipment malfunctions, may give the telecommunications company cause to request the user to disconnect the equipment.

Users should ensure for their own protection that the electrical ground connections of the power utility, telephone lines and internal metallic water pipe system, if present, are connected together. This precaution may be particularly important in rural areas.



Users should not attempt to make such connections themselves, but should contact the appropriate electric inspection authority, or electrician, as appropriate.



This Class B digital apparatus meets all requirements of the Canadian Interference-Causing Equipment Regulations.

Cet appareil numérique de la classe B respecte toutes les exigences du Règlement sur le matériel brouilleur du Canada.

The Ringer Equivalence Number (REN) for this terminal equipment is 1.0. The REN assigned to each terminal equipment provides an indication of the maximum number of terminals allowed to be connected to a telephone interface. The termination on an interface may consist of any combination of devices subject only to the requirement that the sum of the Ringer Equivalence Numbers of all the devices does not exceed five.

Le Nombre d'équivalence Ringer (REN) de cet appareil terminal est 1.0. Le REN attribué à chaque équipement terminal fournit une indication sur le nombre maximum de terminaux pouvant être connectés sur une interface téléphonique. La terminaison sur une interface peut consister en n'importe quelle combinaison d'appareils, à la condition seulement que la somme des Nombres d'équivalence Ringer de tous les appareils ne soit pas supérieure à 5.

CANON CANADA INC.
1-800-263-1121

Contents

Chapter 1: Introduction

What Your Machine Can Do	1-2
Main Components of the FAXPHONE	1-3
Operation Panel	1-4
Special Function Buttons	1-4
LCD (Standby Mode)	1-4

Chapter 2: Registering Information

Guidelines for Entering Numbers, Letters, and Symbols	2-2
Correcting a Mistake	2-4
Registering Required Sender Information	2-5
What is Sender Information?	2-5
Registering Your Sender Information	2-6
Setting the Telephone Line Type	2-8

Chapter 3: Documents and Print Media

Documents	3-2
Document Requirements	3-2
Scanned Area of a Document	3-2
Loading Documents	3-3
Print Media	3-4
Print Media Requirements	3-4
Printable Areas	3-5
Selecting Print Media	3-6
Loading Paper	3-6
Selecting Face-Up or Face-Down Delivery	3-7
Changing the Paper Size Setting	3-9

Chapter 4: Sending Faxes

Preparing to Send a Fax	4-2
Documents You Can Fax	4-2
Setting the Scanning Resolution	4-2
Setting the Scanning Contrast	4-3
Sending Faxes	4-4
Sending Methods	4-4
Memory Sending	4-4
Speed Dialing	4-6
Speed Dialing Methods	4-6
Registering One-Touch Speed Dialing	4-7
Registering Coded Speed Dialing	4-11
Using Speed Dialing	4-14

Chapter 5: Receiving Faxes

Receiving Methods	5-2
Receiving Faxes Manually: MANUAL MODE	5-3
Setting MANUAL MODE	5-3
Receiving a Fax Manually	5-3
Canceling Receiving	5-4

Chapter 6: Copying

Documents You Can Copy	6-2
Making Copies	6-2

Chapter 7: Installing Printer Driver

Installing the Software	7-2
System Requirements	7-2
Printing a Document	7-3
Defining Print Settings: an Overview	7-4
Viewing a Summary of Print Settings	7-6

Chapter 8: Maintenance

Periodic Cleaning	8-2
Cleaning the Machine's Exterior	8-2
Cleaning the Machine's Interior	8-2
Cleaning the Scanner Components	8-5
Replacing the FX-3 Cartridge	8-7

Chapter 9: Troubleshooting

Clearing Jams	9-2
Jams in the ADF	9-2
Paper Jams	9-3
Jams in the Paper Delivery Slots	9-3
Jams Inside the Machine	9-3
LCD Messages	9-8
Paper Feeding Problems	9-13
Printing Problems	9-14
Faxing Problems	9-15
Sending Problems	9-15
Receiving Problems	9-16
Copying Problems	9-18
Telephone Problems	9-19
Installation Problems	9-19
Printing Problems with Your Computer	9-20
General Problems	9-23
If You Cannot Solve a Problem	9-24
If a Power Failure Occurs	9-25

Chapter 10: Summary of Settings

Understanding the Menu System10-2
 Printing a List to Check the Current Settings10-2
 Accessing the Menus10-3
USER SETTINGS Menu.....10-4
REPORT SETTINGS Menu10-5
TX (Transmission) SETTINGS Menu10-6
RX (Reception) SETTINGS Menu10-7
PRINTER SETTINGS Menu10-8
POLLING BOX Menu.....10-9
SYSTEM SETTINGS Menu10-10

Appendix: SpecificationsA-1

IndexI-1

Chapter 1

Introduction

What Your Machine Can Do

Thank you for purchasing the Canon FAXPHONE L80. Your machine incorporates the following functions in one simple-to-operate device:

- Printer** ••••••••••••••••
 - 600 × 600 dpi laser printing for high resolution text and graphics
 - Print speed of approximately 6 letter-size pages* per minute
 - Easy installation of the cartridge
 - Convenient multi-purpose tray for loading a variety of paper and other print media
 - Toner saving feature for less toner consumption and a longer cartridge life
- Fax** ••••••••••••••••
 - Automatic switching between fax super voice calls
 - Fast transmission speed with Super G3 technology encoding—up to approximately 3 seconds* per page
 - 350-page* memory for storing faxes
 - Canon's Ultra High Quality (UHQ™) Image Processing System for enhanced definition in faxed photos
 - Error Correction Mode (ECM) to reduce transmission errors when sending to or receiving from fax machines with ECM capability
 - Automatic dialing and broadcasting—one-touch, coded speed, group, and directory dialing
 - Answering machine connection for automatically receiving both messages and faxes
 - Automatic reduction of received faxes when paper in the machine does not match transmitted page size
 - Special faxing features, such as delayed sending, polling, and reception restriction
 - DRPD (Distinctive Ring Pattern Detection) capability (subscription to a DRP service necessary)
- Copier** ••••••••••••••••
 - Multiple copies—up to 99
 - 400 × 300 dpi high-resolution copying (single copies)
 - Copy reduction—90%, 80%, or 70%
- Telephone** ••••••••••••••••
 - Connection for handset, as well as one other external device (extension telephone, answering machine, or data modem)
 - One-touch and coded speed dialing for quick and efficient dialing
 - Directory dialing

*Based on ITU-T No. 1 Chart, standard mode.

Main Components of the FAXPHONE

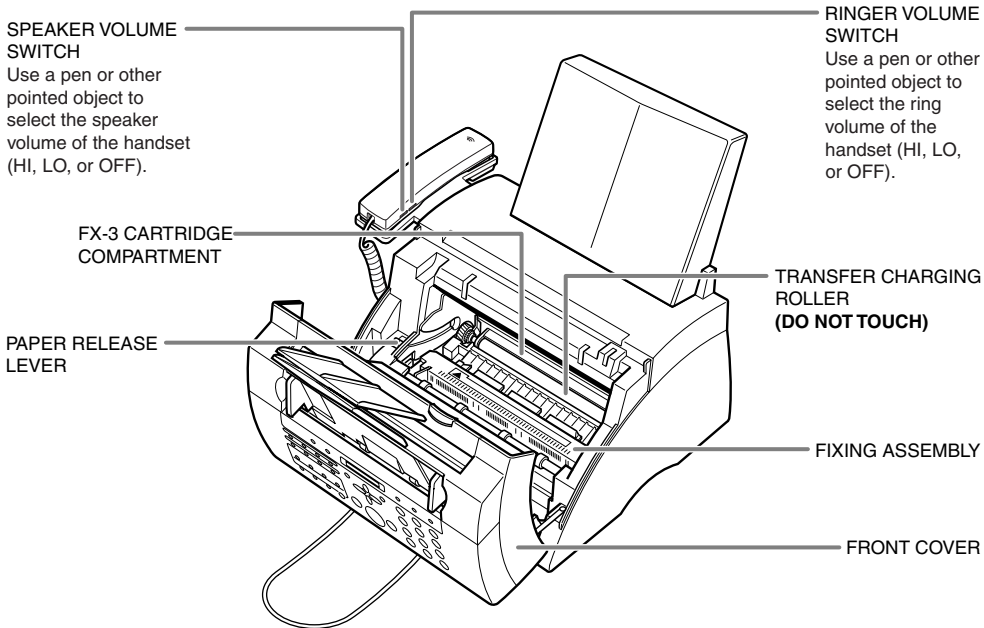
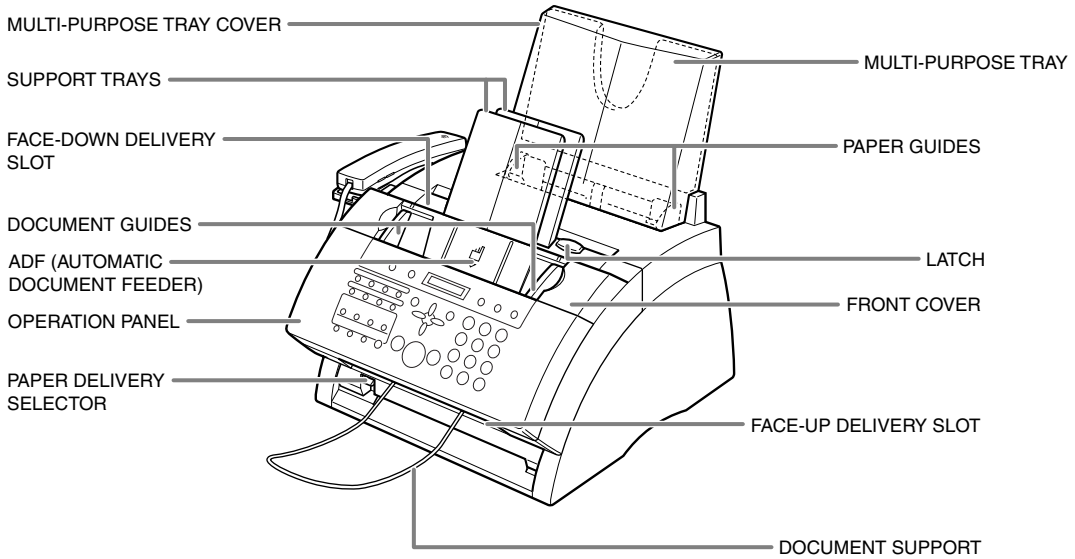

Operation Panel

- Directory Button
- Image Quality Button
- LCD
- Coded Dial Button
- Redial Button
- Pause Button
- Clear Button
- ◀▶▲▼ Buttons
- Set Button

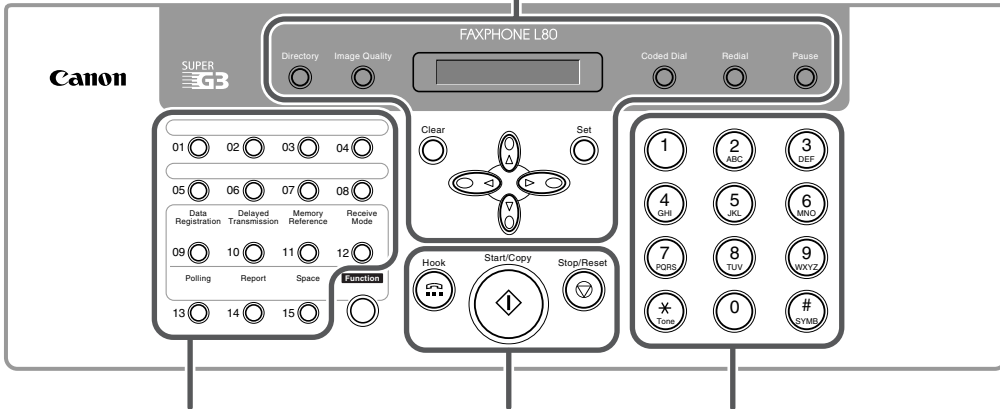

- One-Touch Speed Dialing Buttons
- Hook Button
- Start/Copy Button
- Stop/Reset Button
- Numeric Buttons

Special Function Buttons

- Data Registration Button
- Delayed Transmission Button
- Memory Reference Button
- Receive Mode Button

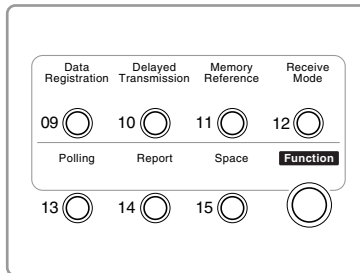

- Polling Button
- Report Button
- Space Button
- Function Button

LCD (Standby Mode)

- Date **12/26**
- **FaxTel.**
- Receive Mode

Chapter 2

Registering Information

Guidelines for Entering Numbers, Letters, and Symbols

When you come to a step that requires you to enter a name or number, refer to the table below to determine which numeric button to press for the character you need:

Button	Letters (:A)	Numbers (:1)
①		1
^{ABC} ②	ABCabc	2
^{DEF} ③	DEFdef	3
^{GHI} ④	GHIghi	4
^{JKL} ⑤	JKLjkl	5
^{MNO} ⑥	MNOmno	6
^{PQRS} ⑦	PQRSpqrs	7
^{TUV} ⑧	TUVtuv	8
^{WXYZ} ⑨	WXYZwxyz	9
^{OPER} ⑩		0
^{SYMB} ⑪	-.*#!";,:^`_ = /!'?\$@% &+()[]{} < >	
^{Tone} ✳	Letter input (:A) ↔ Number input (:1)	



Note If you pause for more than 60 seconds between entering data, the machine will automatically return to standby mode.

■ Changing Between Number Mode and Letter Mode

Press ✳ to select number mode (:1) or letter mode (:A).

:1
 (Number mode)

:A
 (Letter mode)

■ Entering Letters

1 Press **✳** to switch to letter mode (:A).

_ :A

2 Press the numeric button that contains the letter you want.

C :A

- Press repeatedly until the letter you want appears. Each button cycles through the letters that it contains.
- If you are unsure which button to press for the letter you want, see p. 2-2.

3 Continue entering other letters using the numeric buttons.

CA :A

- If the next letter you want to enter is under a different numeric button, simply press that button until the letter you want appears.
- or-
- If the next letter you want to enter is under the same numeric button you pressed in step 2, press **▶** to move the cursor to the right. Then press that same numeric button repeatedly until the letter you want appears.
- To enter a space, press **Function** then **Space**.

■ Entering Numbers

1 Press **✳** to switch to number mode (:1).

_ :1

2 Press the numeric button that contains the number you want.

1_ :1

- To enter a space, press **Function** then **Space**.

3 Continue entering other numbers using the numeric buttons.

10_ :1

■ Entering Symbols

1 Press **#** repeatedly until the symbol you want appears.

:1

2 If you want to enter another symbol, press **▶** to move the cursor to the right, then press **#** repeatedly until the symbol you want appears.

#_ :1

Correcting a Mistake

You can delete an entire entry by pressing **Clear**. Or follow this procedure to correct individual characters:

- 1** Use ◀ or ▶ to move the cursor under the incorrect character.

CANEN :A

- 2** Press the numeric button that contains the correct letter, to enter it over the incorrect character.

CANON :A

- If you are unsure which button to press for the letter you want, see p. 2-2.
- 3** When you have finished making corrections, press **Set** to register your new entry.

Registering Required Sender Information

In the United States, FCC rules governing the use of facsimile equipment state that the following sender information **must** be printed on every facsimile transmission:

- Your fax number
- Your personal name or company name
- The time and date of transmission

Your machine has been designed to print this information at the top of every fax you send. You must therefore register your machine's telephone/fax number, your personal name or company name, and the current date and time before using your machine. This section gives details on registering your sender information.

What is Sender Information?

When you receive a fax, the name of the person or company who sent you the fax, their fax/telephone number, and the date and time of transmission will be printed in small type at the top of each page. This information is called the *Sender information* or the *Transmit Terminal Identification (TTI)*. You must register your details in your machine so that whenever you send a fax, the other party knows who sent it, and when it was sent. Below is an example of how your sender information would print on a fax sent from your machine:

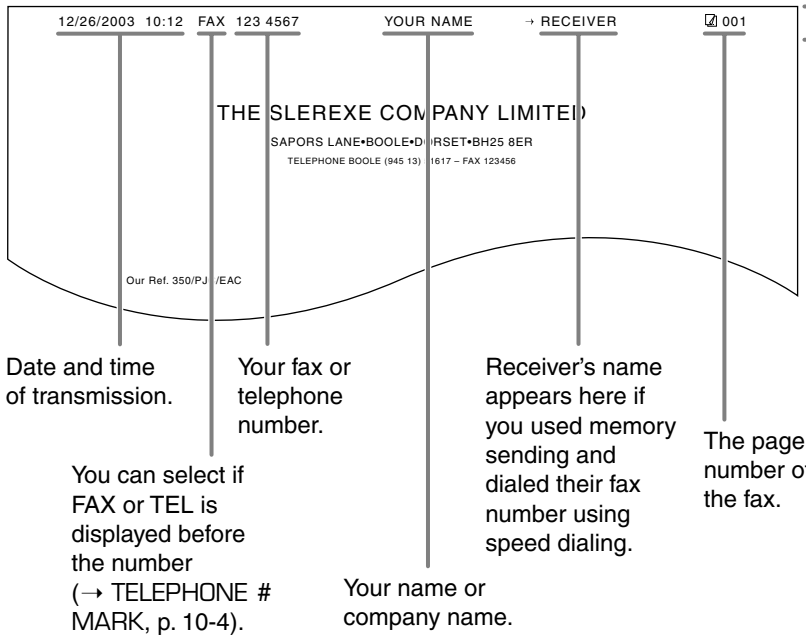

To enter the sender information in your machine, follow the procedures on the following pages.

Registering Your Sender Information

Follow this procedure to set the current date and time, register your fax/telephone number, and register your name or company name:

1 Press **Function**.

2 Press **Data Registration**.

DATA REGISTRATION

3 Press **Set** three times.

- The date and time currently set for your machine are displayed.

USER SETTINGS

DATE & TIME

12/19/2003 13:30

4 Use the numeric buttons to enter the correct month, day, year, and time in this order.

- Enter only the last two digits of the year.
- Use the 24-hour format for the time (e.g. 1:00 p.m. as 13:00), and precede single digits with a zero.
- If you make a mistake, press **Clear** and re-enter the date and time. You can also use ◀ or ▶ to move the cursor under the incorrect number and enter the correct number.

12/26/2003 15:00

5 Press **Set** twice.

UNIT TELEPHONE #

TEL=

6 Use the numeric buttons to enter your fax/telephone number (max. 20 digits, including spaces).

- To enter a space, press **Function** then **Space**. Spaces are optional but make the number easier to read.
- If you make a mistake, press **Clear** and re-enter the number. You can also use ◀ to erase the right-most digit and enter the correct number.

TEL= 123 xxxx

7 Press **Set** twice.

UNIT NAME

_ :A

8 Use the numeric buttons to enter your name or company name (max. 24 characters, including spaces).

- If you are unsure how to enter characters, see p. 2-2.
- If you make a mistake, press **Clear** and re-enter the name. You can also use ◀ or ▶ to move the cursor under the incorrect letter and enter the correct letter.

CANON :A

9 Press **Set**.

TX TERMINAL ID

10 Press **Stop/Reset** to return to standby mode.

12/26 FaxTel



Note To check the sender information registered in your machine, you can print the USER'S DATA LIST (→ *User's Guide*).

Setting the Telephone Line Type

Before using your machine, make sure it is set for the telephone line type of your telephone system. If you are unsure of your telephone line type, check with your local telephone company.

Your machine is factory-set to operate for tone dialing (TOUCH TONE setting). If you need to change this setting for pulse dialing (ROTARY PULSE setting), follow this procedure:

1 Press **Function**.

2 Press **Data Registration**.

DATA REGISTRATION

3 Press **Set** twice.

USER SETTINGS

DATE & TIME

4 Use ▼ or ▲ to select TEL LINE TYPE.

TEL LINE TYPE

5 Press **Set**.

TOUCH TONE

6 Use ▼ or ▲ to select ROTARY PULSE.

ROTARY PULSE

7 Press **Set**.

REPORT SETTINGS

8 Press **Stop/Reset** to return to standby mode.

12/26 FaxTel

Chapter 3

Documents and Print Media

Documents

Document Requirements

The documents you load in the ADF for sending and copying must meet the following requirements:

	One-page document	Multipage document of the same thickness and weight
Size (W × L)	Min. 5.8 × 4.1 in. (Min. 148 × 105 mm) Max. 8.5 × Approx. 39.4 in. (Max. 216 mm × Approx. 1 m)	Min. 5.8 × 4.1 in. (Min. 148 × 105 mm) Max. 8.5 × 14 in. (Max. 216 × 356 mm)
Quantity	1 sheet	Max. 30 letter- or A4-size sheets* Max. 10 legal-size sheets*
Thickness	0.002 to 0.009 in. (0.06 to 0.23 mm)	0.002 to 0.005 in. (0.06 to 0.13 mm)
Weight	9.3 to 64 lb. (35 to 240 g/m ²)	10.7 to 24 lb. (40 to 90 g/m ²)

■ Problem Documents

- To prevent document jams in the ADF, do not use any of the following:
 - Wrinkled or creased paper
 - Curled or rolled paper
 - Torn paper
 - Carbon paper or carbon-backed paper
 - Coated paper
 - Onion skin or thin paper
- Remove all fasteners (staples, paper clips, etc.) before loading the document in the ADF.
- Make sure any glue, ink, or correction fluid on the document is completely dry before loading it in the ADF.
- If you have a document that will not feed properly in the ADF, make a photocopy of the document and load the copy instead.
- If you will be sending a document that you have printed from your machine, be sure to use face-down delivery when printing that document (→ p. 3-7).

Scanned Area of a Document

The shaded area shows the scanned area of a document. Make sure your document's text and graphics fall within this area.

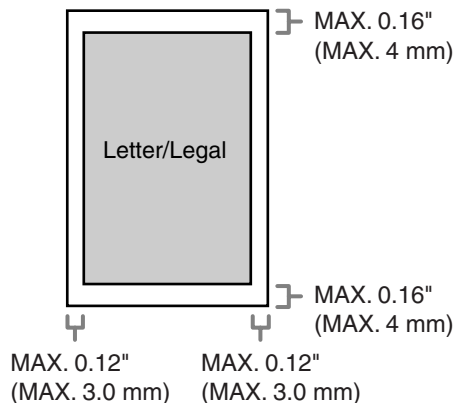

* 20 lb. (75 g/m²) paper

Loading Documents

Insert the top of your document, face down, into the ADF until you hear a beep ①. Then adjust the document guides to the width of the document ②.

- Tap multipage documents on a flat surface to even the edges before inserting them in the ADF.

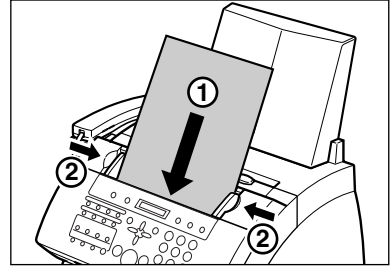

The document is now ready for scanning.



- For a multipage document, the pages are fed one by one from the bottom of the stack.
- Wait until all pages of your document have been scanned before starting a new job.

Print Media

Print Media Requirements

You can load the following print media in the multi-purpose tray:

Print Media	Size (W × L)		Quantity & Weight
Plain Paper	Min.	3.6 × 5 in. (92 × 127 mm)	Quantity: Max. stack height: 0.4 in./10 mm (Approx. 100 sheets of 20 lb. (75 g/m ²) paper) Weight: 17 to 24 lb. (64–90 g/m ²) 1 sheet: 17 to 28 lb. (64–105 g/m ²)
	Max.	8.5 × 14 in. (216 × 356 mm)	
	LTR (Letter)	8.5 × 11 in. (216 × 279 mm)	
	LGL (Legal)	8.5 × 14 in. (216 × 356 mm)	
	A4	8.3 × 11.7 in. (210 × 297 mm)	
	CUSTOM1 /LONG*	8.5 × 12.5 in. to 8.5 × 13.4 in. (216 × 317 mm to 216 × 340 mm)*	
CUSTOM2 /SHORT*	8.5 × 10 in. to 8.5 × 11.2 in. (216 × 254 mm to 216 × 285 mm)*		
Envelopes	U.S. Commercial No. 10	9.5 × 4.1 in. (241 × 104 mm)	7 envelopes
	European DL	8.7 × 4.3 in. (220 × 110 mm)	
Transparencies	LTR (Letter)	8.5 × 11 in. (216 × 279 mm)	1 sheet
	A4	8.3 × 11.7 in. (210 × 297 mm)	

Once you have decided which paper you want to load, be sure to do the following:

- Check that the print media is compatible with your machine (→ p. 3-6).
- If you are loading paper, check that the paper size setting of the multi-purpose tray is set for the paper size you are loading (→ p. 3-9). (The default setting is letter size.)
- Check that paper delivery is set correctly for the print media and task you are performing (→ p. 3-7).
- Check that you have loaded the print media correctly in the multi-purpose tray (→ *User's Guide*).

Printable Areas

■ Paper

The shaded area shows the printable area of letter-size paper.

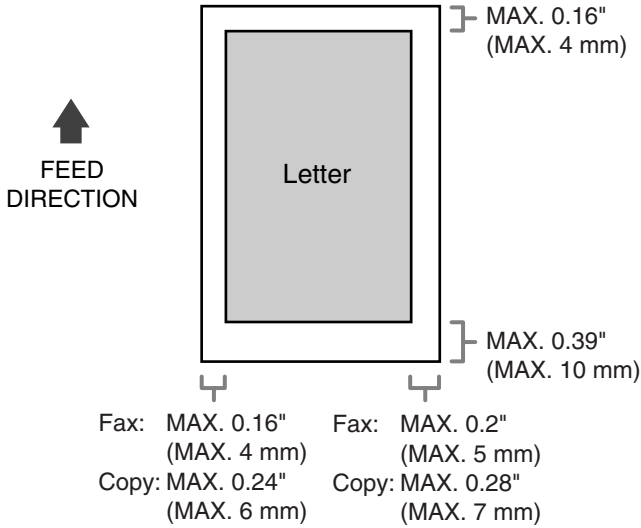

■ Envelope

The shaded area shows the printable area of U.S. Commercial No. 10-size envelopes.

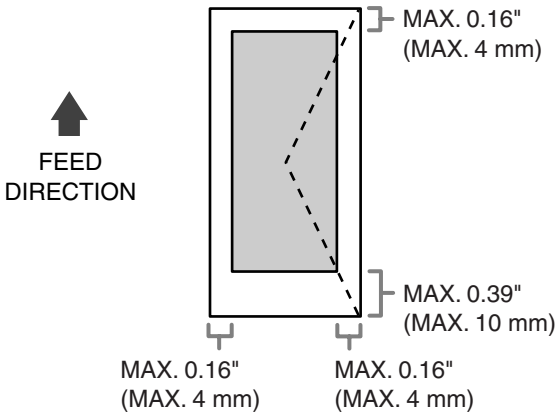

U.S. Commercial
No. 10

Selecting Print Media

■ Paper

- To prevent paper jams in the multi-purpose tray, do not use any of the following:
 - Wrinkled or creased paper
 - Coated paper
 - Damp paper
 - Curled or rolled paper
 - Torn paper
 - Onion skin or very thin paper
- The following types of paper do not print well:
 - Highly textured paper
 - Shiny paper
 - Very smooth paper
- Make sure the paper is free from dust, lint, and oil stains.
- Be sure to test paper before purchasing large quantities.
- Store all paper wrapped and on a flat surface until ready to use. Keep opened packs in their original packaging, in a cool, dry location.
- Store paper at 64.4°F–75.2°F (18°C–24°C), 40%–60% relative humidity.

■ Envelopes

- Use standard envelopes with diagonal seams and flaps.
- To prevent jams in the multi-purpose tray, do not use the following:
 - Envelopes with windows, holes, perforations, cutouts, and double flaps
 - Envelopes made with special coated paper or deeply embossed paper
 - Envelopes with peel-off sealing strips
 - Envelopes with letters enclosed
- You may be able to load other size envelopes than those listed on the previous page. However, Canon cannot guarantee consistent performance on these.



When printing on envelopes, be sure to use face-up delivery (→ p. 3-7).

■ Transparencies

Use only special laser printer transparencies.



- When printing on transparencies, be sure to use face-up delivery (→ p. 3-7).
- To prevent the transparency from curling, remove it as soon as it exits the machine and place it on a flat surface to cool.

Loading Paper

For instructions on loading paper or other print media in the multi-purpose tray, see p. 2-16 of the *User's Guide*.

Selecting Face-Up or Face-Down Delivery

■ Before Setting the Paper Delivery Selector

Before selecting paper delivery, be sure to take note of the following:

- Always set the paper delivery selector before printing.
- The face-down delivery slot can hold up to approximately 50 sheets of paper. To prevent paper jams, remove paper from this slot before 50 sheets print out.
- Never pull the paper as it comes out of the machine.
- Select face-down delivery when:
 - printing on paper.
 - you want the printed pages to stack in the correct page order.
- Select face-up delivery when:
 - printing on envelopes.
 - printing on transparencies.

■ Setting the Paper Delivery Selector

Select face-up or face-down delivery with the paper delivery selector.

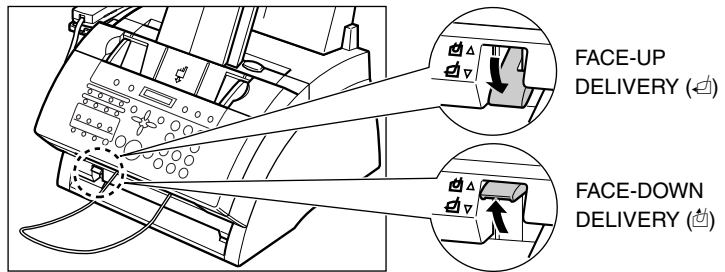
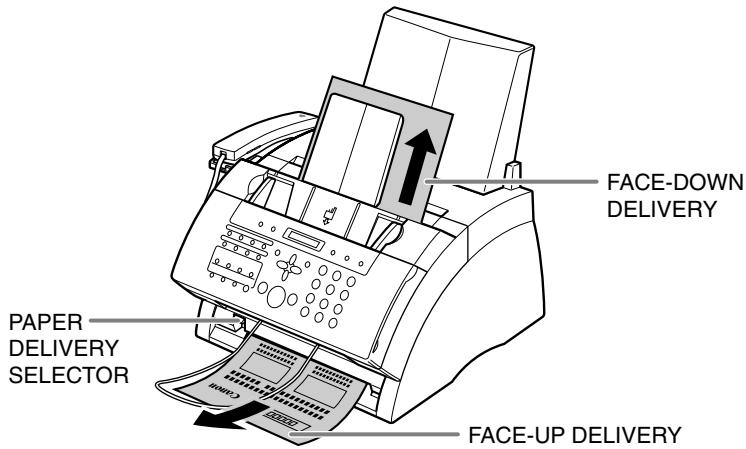

When using face-up delivery, you must remove each sheet as it is delivered. Failure to do this may cause jams in the face-up delivery slot and result in damage to your machine.

Changing the Paper Size Setting

The multi-purpose tray is factory-set for loading letter-size paper. If you want to load a different paper size, follow this procedure to change the paper size setting:

1 Press **Function**.

2 Press **Data Registration**.

DATA REGISTRATION

3 Press **Set**.

USER SETTINGS

4 Use ▼ or ▲ to select **PRINTER SETTINGS**.

PRINTER SETTINGS

5 Press **Set**.

RX REDUCTION

6 Use ▼ or ▲ to select **PAPER SIZE**.

PAPER SIZE

7 Press **Set**.

LTR

8 Use ▼ or ▲ to select the paper size you want for the multi-purpose tray.

- You can select from the following:
 - LTR
 - LGL
 - CUSTOM
 - A4

■ **If you selected LTR, LGL, or A4 in step 8: go to step 11.**

■ **If you selected CUSTOM in step 8:**

9 Press **Set**.

CUSTOM1/LONG

10 Use ▼ or ▲ to select the custom paper size setting.

- You can select from the following:
 - CUSTOM1/LONG
 - CUSTOM2/SHORT

11 Press **Set**.

ECONOMY PRT

12 Press **Stop/Reset** to return to standby mode.

12/26 FaxTel

Chapter 4

Sending Faxes

Preparing to Send a Fax

Documents You Can Fax

For information on the types of documents you can fax and their requirements, see Chapter 3.

Setting the Scanning Resolution

You can set the scanning resolution of documents you send. The higher the resolution the higher the output quality at the other end, but the slower the transmission speed. Adjust the scanning resolution according to the type of document you are sending.

If you are sending a document that requires some pages to be scanned at a different resolution from the others, you can change the resolution setting while the document is being scanned. However, please note that the new setting will only be effective from the next page scanned.

Follow this procedure to set the scanning resolution:

1 Press **Image Quality** repeatedly until the resolution setting you want is displayed.

FAX PHOTO

- You can select from the following:
 - FAX STANDARD
Suitable for most text-only documents.
 - FAX FINE
Suitable for fine-print documents.
 - FAX PHOTO
Suitable for documents that contain images such as photos. With this setting, areas of the document that contain photos are automatically scanned with 64 levels of gray, rather than just in black & white.
 - SUPER FINE
Suitable for documents that contain fine print and images. This setting is four times the resolution of the FAX STANDARD setting.

2 Continue with the operation you are performing.

- If you do not proceed with any other operation, the LCD returns to standby mode after about 10 seconds.

Setting the Scanning Contrast

You can adjust the degree of contrast at which your document is scanned for sending and copying. Adjust according to how light or how dark your document is.

Follow this procedure to set the scanning contrast for sending and copying:

1 Press **Function**.

2 Press **Data Registration**.

DATA REGISTRATION

3 Press **Set** twice.

USER SETTINGS

DATE & TIME

4 Use ▼ or ▲ to select **SCAN CONTRAST**.

SCAN CONTRAST

5 Press **Set**.

STANDARD

6 Use ▼ or ▲ to select the scanning contrast you want.

- You can select from the following:
 - **STANDARD**
Adequate for most documents.
 - **DARKER**
Suitable for light documents.
 - **LIGHTER**
Suitable for dark documents.

7 Press **Set**.

OFFHOOK ALARM

8 Press **Stop/Reset** to return to standby mode.

12/26 FaxTel

Sending Faxes

Sending Methods

There are two methods of sending faxes from your machine:

- Memory sending (→ below)
- Manual sending via the handset (→ *User's Guide*)

Memory Sending

Memory sending is a quick and easy way to send a document. As the machine scans the first page of a multipage document into its memory, it begins calling the other party and transmitting the information even as the remaining pages are being scanned.

Since your machine is multitasking, you can even scan a document into memory while performing other tasks.

Your machine has enough memory to store up to approximately 350 pages* (fewer if the document contains many graphics or particularly dense text).

Follow this procedure to send a document using memory sending:

- 1** Load the document, face down in the ADF (→ p. 3-3).
 - To adjust the resolution and contrast, see pp. 4-2, 4-3.
 - You may be unable to send if the memory used (shown in the LCD) is close to 100%. Use manual sending via the handset instead (→ *User's Guide*).

MEMORY USED 0%
(Currently used memory)

DOCUMENT READY
(Standby to scan)

- 2** Dial the other party's fax number.
 - For details on the dialing methods, see the *User's Guide*.
 - If you enter the wrong number, press **Stop/Reset**, then enter the correct number.
 - If you are connected to a PBX and need to first dial an outside line access number ("9", for example), add a pause after that number by pressing **Pause** (→ *User's Guide*).

TEL= 9p76xxxxx

*Based on ITU-T No. 1 Chart, standard mode.

- 3** Press **Start/Copy** to begin scanning for sending, or if you used speed dialing, wait a few seconds for your machine to begin scanning automatically.
- If you do not want your machine to begin scanning automatically after a few seconds, disable the TIME OUT setting (→ p. 10-6).
 - To cancel sending once dialing has started, press **Stop/Reset** then ✕.
 - If the number you are calling is busy, your machine redials the number automatically after a few minutes (→ *User's Guide*).



- You can have up to 20 different jobs waiting in memory to be sent.
- The document is automatically deleted from memory after sending. This occurs even if an error prevents complete transmission of the document.

Speed Dialing

Speed Dialing Methods

Instead of having to dial a fax or telephone number using regular dialing (e.g. with the numeric buttons), you can simplify the dialing procedure by registering the fax/telephone number for speed dialing. This will reduce the number of buttons you need to press to dial the fax/telephone number, making it convenient for frequently dialed numbers.

Speed dialing also allows you to register several fax numbers under one speed dialing button or code so that you can send a document to all those fax numbers in one operation.

You can also look up a fax/telephone number quickly using the directory function.

See below for details on the different speed dialing methods.

Your machine offers the following speed dialing methods:

■ **One-Touch Speed Dialing** (→ p. 4-7)

Register a fax/telephone number under a one-touch speed dialing button so that you only have to press one button to dial that fax/telephone number.

There are 15 one-touch speed dialing buttons available for you to register fax/telephone numbers.

■ **Coded Speed Dialing** (→ p. 4-11)

Register a fax/telephone number under a coded speed dialing code so that you only have to press **Coded Dial** and enter the registered two-digit code (with the numeric buttons) to dial that fax/telephone number.

There are 100 codes available for you to register fax/telephone numbers.

■ **Group Dialing** (→ *User's Guide*)

“Group” up to 114 fax numbers together, so you can send to those fax numbers in one quick operation. A group is registered under a one-touch speed dialing button or a coded speed dialing code.

■ **Directory Dialing** (→ *User's Guide*)

Use the **Directory** button to look up the fax/telephone numbers you registered for one-touch speed dialing, coded speed dialing, and group dialing.

Registering One-Touch Speed Dialing

By registering a fax/telephone number under a one-touch speed dialing button, you can simplify dialing of that number to the press of a single button.

Follow this procedure to register one-touch speed dialing:

1 Press **Function**.

2 Press **Data Registration**.

DATA REGISTRATION

3 Use ▼ or ▲ to select TEL REGISTRATION.

TEL REGISTRATION

4 Press **Set** twice.

1-TOUCH SPD DIAL

O1=

5 Use ▼ or ▲ to select the one-touch speed dialing button (O1 to 15) under which you want to register the fax/telephone number.

O4=

- If a one-touch speed dialing button has already been registered, the number registered under that button appears.
- If a group is already registered under a one-touch speed dialing button, GROUP DIAL appears.

6 Press **Set** twice.

TELEPHONE NUMBER

TEL=_

7 Use the numeric buttons to enter the fax/telephone number you want to register (max. 120 digits, including spaces and pauses).

TEL=20 5xx xxxx_

- To enter a space, press **Function** then **Space**. Spaces are optional and are ignored during dialing.
- To enter a pause, press **Pause**.
- To correct a mistake in the number, press ◀ to delete the rightmost digit. Alternatively, press **Clear** to delete the entire number.

- To cancel one-touch speed dialing for the button you selected, press **Clear** then **Set**. Press **Stop/Reset** to return to standby mode. The fax/telephone number and name registered under that button will be deleted.
- If you have already registered a number that you want to keep, ignore this step.

8 Press **Set** twice.

NAME

_ :A

9 Use the numeric buttons to enter a name for the one-touch speed dialing button (max. 16 characters, including spaces).

Canon EUROPA :A

- If you are unsure how to enter characters, see p. 2-2.
- If you have already registered a name that you want to keep, ignore this step.

10 Press **Set**.

OPTIONAL SETTING

11 This completes the basic one-touch speed dialing settings.
To continue registering other one-touch speed dialing buttons, press **Set** twice and repeat the procedure from step 5.

05=

-or-

To end registering one-touch speed dialing buttons, press **Stop/Reset** to return to standby mode.

12/26 FaxTel

-or-

To register the transmission type for the current button you are registering, continue with the steps below.

12 Press **Set**.

OFF

13 Use ▼ or ▲ to select ON.

ON

14 Press **Set** twice.

TX TYPE
REGULAR TX

15 Use ▼ or ▲ to select the transmission type setting you want.

- You can select from the following:
 - REGULAR TX
Normal transmission.
 - PSWD/SUBADDRESS
Transmission with a subaddress and/or password. For details, see below.

■ **If you selected REGULAR TX in step 15:**

16 Press **Set**.

05=

17 Press **Stop/Reset** to return to standby mode.

12/26	FaxTel
-------	--------

■ **If you selected PSWD/SUBADDRESS in step 15:**

The other party's fax machine may require an ITU-T-standard subaddress and/or password to receive faxes. The subaddress/password you register here must match exactly the one(s) registered on the other party's fax machine. Contact the other party to check their settings.

When sending with a subaddress/password, the other party's fax machine receives the fax only if your subaddress/password matches theirs. Their fax machine then handles the received fax according to the feature they are using.

You also need to register a subaddress/password when polling a fax machine that requires these settings (→ *User's Guide*).

Continue with the steps below to register a subaddress/password:

16 Press **Set** twice.

SUBADDRESS

17 If a subaddress is required, use the numeric buttons to enter it (max. 20 digits).

- If a subaddress is not required, ignore this step.
- If you have already registered a subaddress that you want to keep, ignore this step.

1234

18 Press **Set** twice.

PASSWORD

19 If a password is required, use the numeric buttons to enter it (max. 20 digits).

4321

- If a password is not required, ignore this step.
- If you have already registered a password that you want to keep, ignore this step.

20 Press **Set**.

05=

21 To continue registering other one-touch speed dialing buttons, repeat the procedure from step 5.

-or-

Press **Stop/Reset** to return to standby mode.

12/26 FaxTel



Note

- Use the destination labels provided with your machine to label the one-touch speed dialing buttons. Stick the labels above each corresponding button.
- To check your entries, you can print a list of all the numbers and names registered for one-touch speed dialing (→ *User's Guide*).

Registering Coded Speed Dialing

By registering a fax/telephone number under a coded speed dialing code, you can simplify dialing of that number to pressing **Coded Dial** and entering the registered two-digit code.

Follow this procedure to register coded speed dialing:

1 Press **Function**.

2 Press **Data Registration**.

DATA REGISTRATION

3 Use ▼ or ▲ to select TEL REGISTRATION.

TEL REGISTRATION

4 Press **Set**.

1-TOUCH SPD DIAL

5 Use ▼ or ▲ to select CODED SPEED DIAL.

CODED SPEED DIAL

6 Press **Set**.

*00=

7 Use ▼ or ▲ to select the coded speed dialing code (00 to 99) under which you want to register the fax/telephone number.

*01=

- Alternatively, press **Coded Dial** and use the numeric buttons to enter the code.
- If a coded speed dialing code has already been registered, the number registered under that code appears.
- If a group is already registered under a coded speed dialing code, GROUP DIAL appears.

8 Press **Set** twice.

TELEPHONE NUMBER

TEL=_

9 Use the numeric buttons to enter the fax/telephone number you want to register (max. 120 digits, including spaces and pauses)(→ p. 4-7).

TEL=3 37xx xxxx_

10 Press **Set** twice.

NAME

_ :A

11 Use the numeric buttons to enter a name for the coded speed dialing code (max. 16 characters, including spaces)(→ p. 4-8).

Canon Inc. :A

12 Press **Set**.

OPTIONAL SETTING

13 This completes the basic coded speed dialing settings.

To continue registering other coded speed dialing codes, press **Set** twice and repeat the procedure from step 7.

-or-

To end registering coded speed dialing codes, press **Stop/Reset** to return to standby mode.

-or-

To register the transmission type for the current code you are registering, continue with the steps below.

*02=

12/26 FaxTel

14 Press **Set**.

OFF

15 Use ▼ or ▲ to select ON.

ON

16 Press **Set** twice.

TX TYPE

REGULAR TX

17 Use ▼ or ▲ to select the transmission type setting you want.

- You can select from the following:
 - REGULAR TX
Normal transmission.
 - PSWD/SUBADDRESS
Transmission with a subaddress and/or password. For details, see p. 4-9.

■ **If you selected REGULAR TX in step 17:**

18 Press **Set**.

*02=

19 Press **Stop/Reset** to return to standby mode.

12/26 FaxTel

■ **If you selected PSWD/SUBADDRESS in step 17:**

Set a subaddress/password (→ p. 4-9).

Using Speed Dialing

Follow this procedure to send a document using one-touch speed dialing, coded speed dialing, or group dialing:

- 1** Load the document, face down in the ADF (→ p. 3-3).
 - To adjust the resolution and contrast, see pp. 4-2, 4-3.
 - You may be unable to send if the memory used (shown in the LCD) is close to 100%. To free up space in the machine's memory: print, send, or delete any documents you no longer need to be stored in memory (→ *User's Guide*).

- 2** Enter the one-touch speed dialing button or coded speed dialing code assigned to the fax number or group you want to send to.
 - **One-touch speed dialing button:**
Press the one-touch speed dialing button you want.
 - **Coded speed dialing code:**
Press **Coded Dial**, then use the numeric buttons to enter the two-digit code you want.
 - If you make a mistake, press **Stop/Reset** and repeat this step.
 - NO TEL # appears if no fax/telephone number or group is assigned to the speed dialing button or code you pressed.

- 3** Press **Start/Copy** to begin scanning for sending, or wait a few seconds for your machine to begin scanning automatically.
 - If you do not want your machine to begin scanning automatically after a few seconds, disable the TIME OUT setting (→ p. 10-6).

MEMORY USED 0%

(Currently used memory)

DOCUMENT READY

(Standby to scan)

Chapter 5

Receiving Faxes

Receiving Methods

Your machine provides you with several modes for receiving faxes. To determine which mode best suits your requirements, refer to the table below:

Receive Mode	Main Use	Operation	Requirements	Details
Fax/Tel Mode	Fax/Tel	The machine automatically switches between fax and voice calls. It receives faxes automatically and rings for voice calls.	Handset or the extension telephone connected to your machine.	<i>User's Guide</i>
MANUAL MODE	Tel	The machine rings for every call, whether a fax call or a voice call. For a fax call, you have to manually activate reception of a fax.	Handset or the extension telephone connected to your machine.	p. 5-3
FAX ONLY MODE	Fax	The machine answers all calls as fax calls. It receives faxes automatically and disconnects voice calls.	Separate telephone line for fax use only.	<i>User's Guide</i>
ANS.MACHINE MODE	Fax/Tel	The machine receives documents automatically and the answering machine records voice messages.	Answering machine connected to your machine.	<i>User's Guide</i>
DRPD	Fax/Tel	The machine rings differently depending on whether a call is a fax or voice call.	Subscription to a DRPD service. Handset or the extension telephone connected to your machine.	<i>User's Guide</i>

Once you have decided which receive mode is suitable for your needs, set the mode by pressing **Function, Receive Mode**, then ▲ or ▼. You can change the mode at any time.

Receiving Faxes Manually: MANUAL MODE

Setting MANUAL MODE

Follow this procedure to set the receive mode to MANUAL MODE:

1 Press **Function**, then **Receive Mode**.

2 Press ▼ or ▲ to select MANUAL MODE.



MANUAL MODE

3 Press **Set**.

- The LCD changes to this display:



12/26 Manual

Receiving a Fax Manually

Follow this procedure to receive a fax manually:

1 Make sure Manual is displayed in the LCD.



12/26 Manual

2 Make sure you have connected the handset or extension telephone to your machine (→ *Set-Up Instructions*).

3 When you hear the handset or extension telephone ring, pick up the handset.

■ If you hear a long beep tone or silence:

4 Someone is trying to send you a fax. Press **Start/Copy** on your machine and hang up to begin receiving the document.

- If you are using the extension telephone and it is located away from your machine, dial 25 (the default remote receiving ID) on your telephone and hang up.

■ If you hear a voice:

- 4 Start your conversation. If the caller wants to send a fax after talking to you, ask them to press the start button on their fax machine.
- 5 When you hear a long beep, press **Start/Copy** on your machine and hang up to begin receiving the document.
 - If you are using the extension telephone and it is located away from your machine, dial 25 (the default remote receiving ID) on your telephone and hang up.



- If using the handset, be sure to hang up *after* you press **Start/Copy** on the machine, otherwise the call will be disconnected.
- Your machine will alert you by beeping if the handset is not hung up properly. Make sure the handset is seated properly in its cradle. If you do not want the machine to beep, disable the OFFHOOK ALARM setting (→ p. 10-4).
- If you cannot activate reception from the extension telephone, check that the REMOTE RX setting is enabled (→ p. 10-7).
- You can change the remote receiving ID (→ REMOTE RX ID, p. 10-7), or disable remote receiving (→ REMOTE RX, p. 10-7).
- If you have an answering machine connected to your machine that can carry out remote-control operations (controlling your answering machine from a remote telephone), the security code for this function may be the same as the remote receiving ID of your machine. If this is the case, make sure you change the machine's remote receiving ID to make it distinct from the answering machine's security code (→ REMOTE RX ID, p. 10-7).

Canceling Receiving

Press **Stop/Reset**, then press ✖.

Chapter 6

Copying

Documents You Can Copy

For information on the types of documents you can copy, their requirements, and details on loading documents, see Chapter 3.

Making Copies

Follow this procedure to make copies:

- 1** Adjust the paper delivery selector if necessary (→ p. 3-7).
- 2** Load the document, face down in the ADF (→ p. 3-3).
 - To adjust the contrast, see p. 4-3.
- 3** Press **Start/Copy**.
- 4** Press **Image Quality** repeatedly until the resolution setting you want is displayed.
 - You can select from the following:
 - TEXT
Suitable for most text documents.
 - PHOTO
Suitable for documents that contain photographs.
- 5** To make a reduced copy of your document, use ▼ or ▲ to select the reduction percentage you want.
 - You can select from the following:
 - 70%
 - 80%
 - 90%
 - 100%

MEMORY USED 0%

(Currently used memory)

DOCUMENT READY

(Standby to scan)

COPY 100% 01

PHOTO

COPY 80% 01

- 6** If you want to make multiple copies, use the numeric buttons to enter the number of copies.

COPY 80% 05

- You can make up to 99 copies.



Note

The machine copies at 400 × 300 dpi for single copies, and at 200 × 300 dpi for multiple copies. For best quality output, make one copy at a time.

- 7** Press **Start/Copy** to begin copying.

- To cancel copying, press **Stop/Reset**. You may then need to open the operation panel to remove the document from the ADF (→ p. 9-2).

COPYING



Note

You will be unable to make multiple copies if MEMORY FULL appears in the LCD. Print, send, or delete any documents you no longer need to be stored in the machine's memory (→ *User's Guide*), then start again. Also, if you are copying multiple pages with many graphics, separate the pages into smaller stacks or make the desired number of copies one at a time as needed.

Chapter 7

Installing Printer Driver

Installing the Software

If you have not already installed the software as explained in the *Set-Up Instructions* please do so now. For instructions, see the *Set-Up Instructions* or the *Software User's Guide*.

System Requirements

To successfully install and operate your printer and printer driver, your system must meet the following minimum requirements:

■ Windows Operating System

Microsoft Windows 98, Windows Me, Windows 2000, or Windows XP.

■ USB Port

■ Computer Processor

- Windows 98: A 90-megahertz (MHz) Pentium processor or higher
- Windows Me: A 150-MHz Pentium processor or higher
- Windows 2000: A 133-MHz Pentium processor or higher
- Windows XP: A 233-MHz Pentium processor or higher

■ Memory

- Windows 98/Me: 32 megabytes (MB) of RAM. 64 MB of RAM or more is recommended.
- Windows 2000/XP: 64 MB of RAM. 128 MB of RAM or more is recommended.

■ Hard Disk Space

15 MB of available hard disk space

■ Disk Drive

CD-ROM drive, or access to one over a network connection

■ Monitor

256-color SVGA monitor or greater

■ Printer Cable

A USB cable 16.4 feet (5 meters) in length or shorter.

Printing a Document

Once you have installed the software, you are ready to print a document, from any Windows application that supports printing, such as Word for Windows.

Predefined printer settings are initially installed, enabling you to print immediately. These settings determine what your documents look like when printed. For example, they define such settings as the paper size and page orientation.

Instructions for printing a document can vary somewhat for different Windows applications. Therefore, for detailed instructions, see the user documentation for the specific application from which you are printing.

The following instructions summarize the general procedures for printing a document.

■ To print a document

- 1** With your document open, click the command to print your document. (In most Windows applications, the Print command is on the File menu or toolbar.)
- 2** In the Print dialog box, make sure the printer is selected under Printer (Windows 98/Me) or Select Printer (Windows 2000/XP).
- 3** Click the command to print your document (usually **OK** or **Print**).

Defining Print Settings: an Overview

Print settings determine how your document looks when it is printed.

Although predefined print settings are initially installed with the software, you may want to change these settings for certain documents.

Print settings can be changed to suit the type of document you are printing.

For example, if you regularly print draft copies of reports, you can define print settings to suit your printing requirements.

You can change a number of print settings, such as the paper size, page layout, resolution, and halftoning method. If you use certain print settings often, you can save the settings as a print profile and reuse the profile as needed.

The following instructions summarize the general procedures for changing printer settings, based on your version of Windows. For detailed information on specific print settings, see the sections that immediately follow these instructions.

■ To define print settings (Windows 98/Me):

- 1** On the Windows desktop, click **Start**, point to **Settings**, and then click **Printers**.
- 2** In the Printers window, right-click the printer icon. On the displayed menu, click **Properties**.

■ To define print settings (Windows 2000/XP):

- 1** On the Windows desktop, click **Start**, point to **Settings**, and then click **Printers** (in Windows XP, click **Start**, and then click **Printers and Faxes**).
- 2** In the Printers window (in Windows XP, the Printers and Faxes window), right-click the printer icon. On the displayed menu, click **Printing Preferences**.

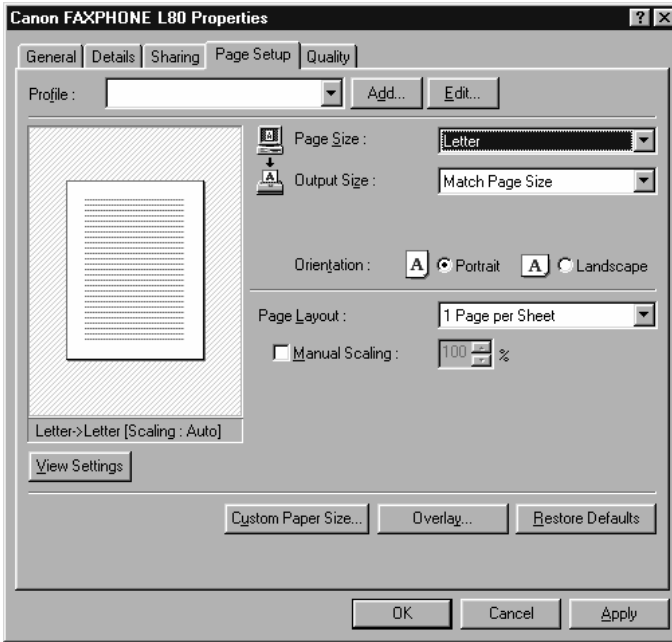

- 3** In the Properties dialog box, on the Page Setup or Quality tab, specify the desired printer settings.
- 4** To accept the changes and close the dialog box, click **OK**.
 - To accept the changes and leave the dialog box open, click **Apply**.
 - To cancel the changes and return to the default settings, click **Restore Defaults**.
 - To close the dialog box without accepting any changes, click **Cancel**.

Viewing a Summary of Print Settings

As you work with the individual print settings on the different tabs, you can view a summary of the current settings at any time.

■ To view a summary of print settings

On Page Setup or Quality tab, click **View Settings**.

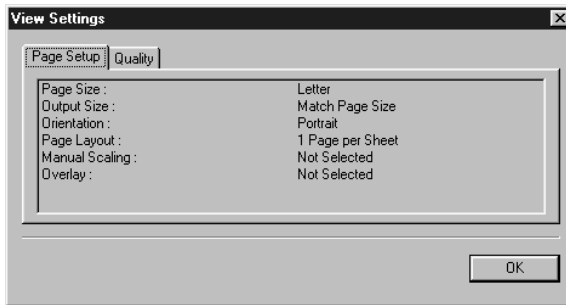

Chapter 8

Maintenance.

Periodic Cleaning

This section describes the necessary cleaning procedures for your machine. Please note the following before cleaning your machine:

- Be sure to disconnect the power cord before cleaning the machine. Since documents in memory are erased when the power is disconnected, print or send any documents stored in memory before disconnecting the power cord (→ *User's Guide*).
- Do not use tissue paper, paper towels, or similar materials for cleaning; they can stick to the components or generate static charges.



Never use volatile liquids such as thinners, benzene, acetone, or any other chemical cleaner to clean the interior of the machine; these can damage the machine's components.

Cleaning the Machine's Exterior

Follow this procedure to clean the machine's outer casing:

- 1** Disconnect the power cord from the machine.
- 2** Wipe the machine's exterior with a clean, soft, lint-free cloth moistened with water or diluted dishwashing detergent solution.
- 3** When you are finished, reconnect the power cord.

Cleaning the Machine's Interior

To prevent toner powder and paper dust from accumulating inside the machine and affecting print quality, clean the machine's print area periodically.

Follow this procedure to clean inside the machine:

- 1** Disconnect the power cord from the machine.
- 2** Lift the latch and open the front cover.



Do not try to open the front cover without lifting the latch since this may damage your machine.

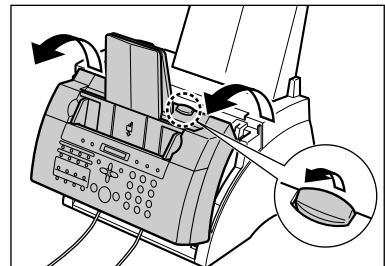

- 3** Hold the cartridge by its handle and remove it from the machine.
- To avoid exposing the cartridge to light, place it in its protective bag or wrap it in a thick cloth.

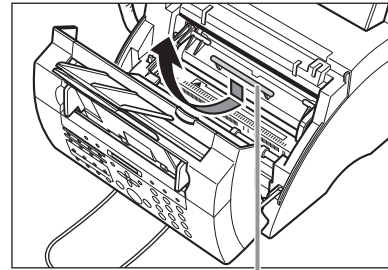

HANDLE

- 4** Use a clean, soft, dry, lint-free cloth to remove any toner or paper debris from the machine's interior (shaded area in the illustration).



- **The fixing assembly becomes extremely hot when the machine is in use. Be very careful not to touch it so as to avoid injury.**
- **Be careful not to touch the black transfer charging roller since this adversely affects print quality.**

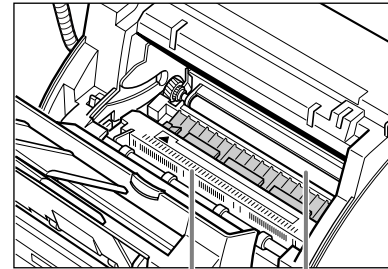

**DO NOT TOUCH THE
FIXING ASSEMBLY**

**DO NOT TOUCH THE BLACK
TRANSFER CHARGING ROLLER**

- 5** When you are finished, reinsert the cartridge. Hold the cartridge by its handle and insert it into the machine as far as it will go, making sure that its tabs are aligned with the rails inside the machine.
- Always hold the cartridge by its handle.

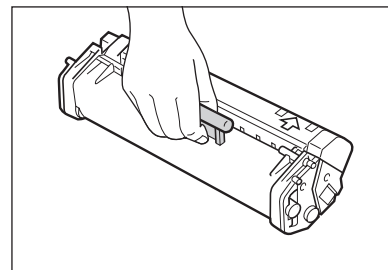
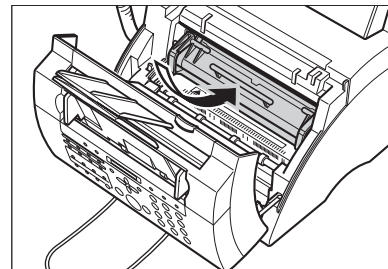

- 6** Use both hands to close the front cover.

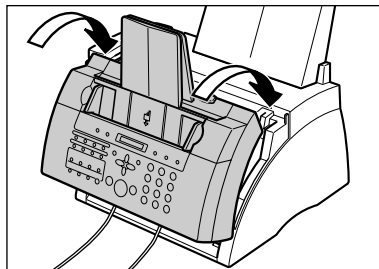

- 7** Reconnect the power cord.

Cleaning the Scanner Components

Follow this procedure to periodically check and clean the scanner components:

- 1** Disconnect the power cord from the machine.
- 2** Use both hands to gently open the operation panel.
 - It only opens partially.
- 3** While holding the operation panel open, clean these components:

■ Separation guide and separation roller:

Wipe with a clean, soft, dry, lint-free cloth.

■ White sheet and scanning glass:

Wipe with a clean, soft, lint-free cloth moistened with water, then wipe with a clean, soft, dry, lint-free cloth.



Note

- If the scanner components are dirty, the documents you send or copy will also be dirty.
- Be sure to use a soft cloth to avoid scratching the components.
- Do not use tissue paper, paper towels, or similar materials for cleaning; they can stick to the components or generate static charges.

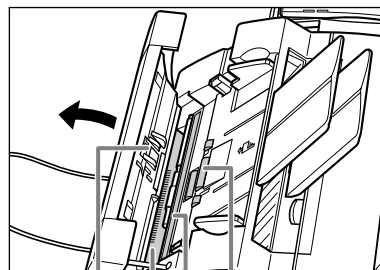

SEPARATION ROLLER
SCANNING GLASS
WHITE SHEET
SEPARATION GUIDE

- 4** Clean the underside of the operation panel (shaded area in the illustration).
 - Dirt and dust particles that collect on the underside of the operation panel affect the quality of the documents you copy or send.

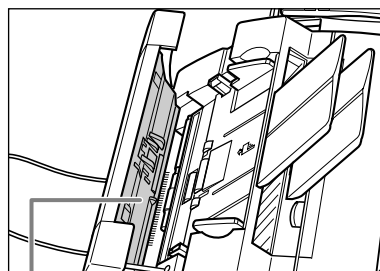

UNDERSIDE OF OPERATION PANEL

- 5** Use a clean, soft, dry, lint-free cloth to wipe any paper dust from the areas surrounding the separation roller (shaded area in the illustration).

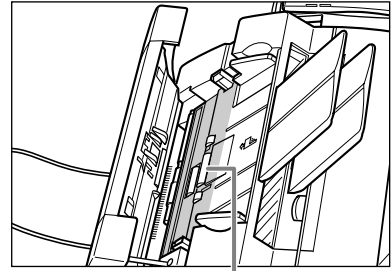

SEPARATION
ROLLER

- 6** When you are finished, close the operation panel by pressing it down from the center.
 - Be sure to close the operation panel until it locks into place, or the machine will not function properly.
- 7** Reconnect the power cord.

Replacing the FX-3 Cartridge

The only component of your machine you will need to replace is the FX-3 cartridge. The FX-3 S Cartridge is a starter cartridge that comes with your machine, and yields approximately 1,500 pages based on 5% coverage of an A4 size page. The replacement FX-3 cartridge yields approximately 2,700 pages based on 5% coverage of an A4 size page. To purchase this cartridge, contact the Canon Customer Care Center, or your business machine retailer/dealer.

When CHANGE CARTRIDGE appears in the LCD, you may need to replace the cartridge. However, it may also indicate that the toner inside the cartridge is simply unevenly distributed. Before replacing the cartridge, follow this procedure to distribute the toner evenly:

- 1** Remove the cartridge from the machine (→ steps 1 to 4, below).
- 2** Gently rock the cartridge from side to side a few times to distribute the toner evenly inside it.
 - Poor print quality may result if the toner is unequally distributed.

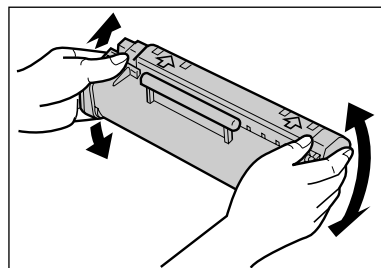

- 3** Reinsert the cartridge into the machine (→ steps 8 and 9, p. 8-9).

If after following the procedure above, CHANGE CARTRIDGE remains in the LCD or print quality does not improve, follow this procedure to replace the cartridge:

- 1** Remove any documents and printouts from the machine.
- 2** Make sure the machine is plugged in.
- 3** Lift the latch and open the front cover.



Do not try to open the front cover without lifting the latch since this may damage your machine.

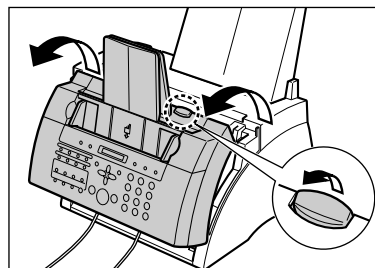

- 4** Hold the cartridge by its handle and remove it from the machine.
- Discard the old cartridge immediately according to the local laws and regulations for disposal of consumables. To recycle your used cartridge, simply follow the instructions included with your new FX-3 cartridge.

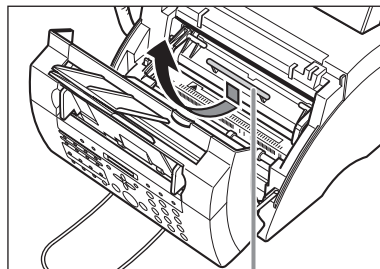

HANDLE

- 5** Remove the new FX-3 cartridge from its protective bag.
- Save the protective bag in case you need to repackage the cartridge at a later date.

- 6** Gently rock the cartridge from side to side a few times to distribute the toner evenly inside it.
- Poor print quality may result if the toner is unequally distributed.

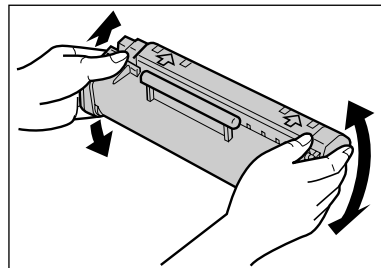

- 7** Place and support the cartridge on a flat, clean surface, then gently pull on the plastic tab to remove the plastic seal.
- Use a firm, even pull to avoid breaking the seal.

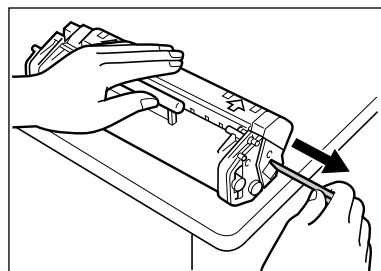

SIDE VIEW

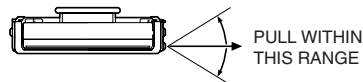

TOP VIEW

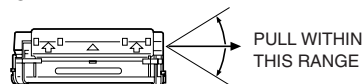

- 8** Hold the cartridge by its handle and insert it into the machine as far as it will go, making sure that its tabs are aligned with the rails inside the machine.

- Always hold the cartridge by its handle.

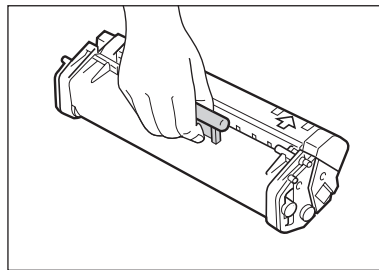
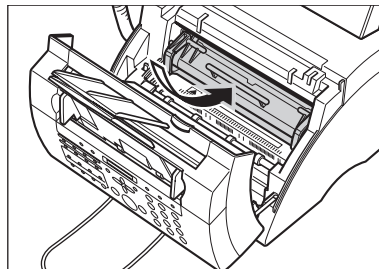

- 9** Use both hands to close the front cover.

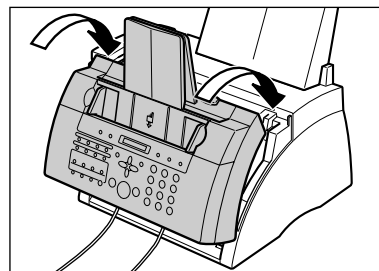

Chapter 9

Troubleshooting

Clearing Jams

Jams in the ADF

When a document jams or misfeeds in the ADF, the LCD displays CHECK DOCUMENT.

Follow this procedure to clear the document jam:



You do not need to unplug your machine when clearing document jams.

1 Press **Stop/Reset**.

2 Use both hands to gently open the operation panel.

- It only opens partially.
- Do not try to pull the document out without opening the operation panel since you may tear or smudge the document.

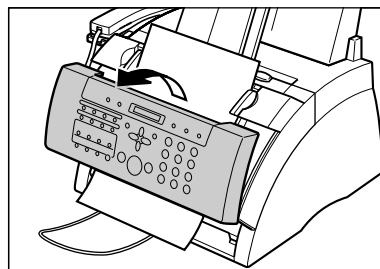

3 While holding the operation panel open, remove the document.

- Pull it gently in either direction.
- If a multipage document is loaded, remove the entire document from the ADF.



If the paper does not pull out easily, do not force it. Contact the Canon Customer Care Center.

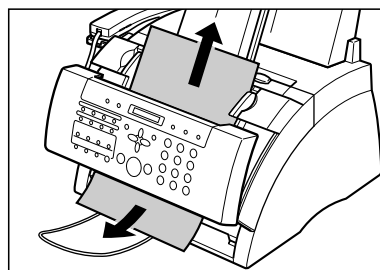

4 When you are finished, close the operation panel by pressing it down from the center.

- Be sure to close the operation panel until it locks into place, or the machine will not function properly.

Paper Jams

When paper jams in the machine, the LCD displays CLEAR PAPER JAM. Try clearing the jam by following the procedure in *Jams in the Paper Delivery Slots* below. If this does not clear the jam, follow the procedure in *Jams Inside the Machine*.

Jams in the Paper Delivery Slots

Follow this procedure to clear a paper jam in the paper delivery slots:



You do not need to unplug your machine when clearing paper jams.

- 1 Gently pull any jammed paper out of the machine as shown.

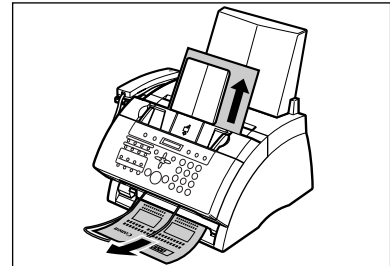

- 2 Remove the paper stack from the multi-purpose tray and reload it (→ *Set-Up Instructions*).



If the paper jam occurred while a fax was being received into the machine's memory, that fax will print automatically when the jam is cleared.

Jams Inside the Machine

Follow this procedure to clear a paper jam inside the machine:



You do not need to unplug your machine when clearing paper jams.

- 1 Lift the latch and open the front cover.



Do not try to open the front cover without lifting the latch since this may damage your machine.

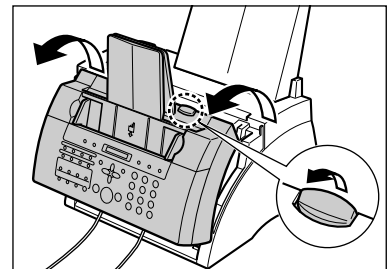

- 2** Hold the cartridge by its handle and remove it from the machine.
- To avoid exposing the cartridge to light, place it in its protective bag or wrap it in a thick cloth.

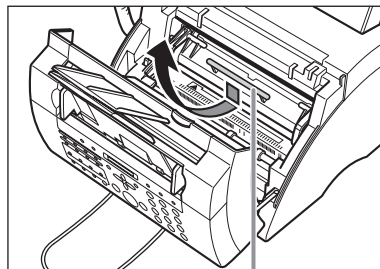

HANDLE

- 3** Move the paper release lever back.

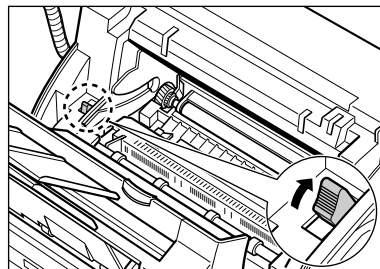

- The fixing assembly becomes extremely hot when the machine is in use. Be very careful not to touch it so as to avoid injury.
- Be careful not to touch the transfer charging roller since this adversely affects print quality.

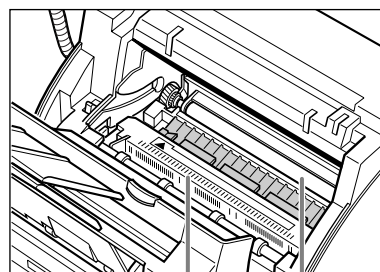

**DO NOT TOUCH THE
FIXING ASSEMBLY**

**DO NOT TOUCH THE BLACK
TRANSFER CHARGING ROLLER**

- 4** Locate the paper jam and clear it as explained on the following pages.

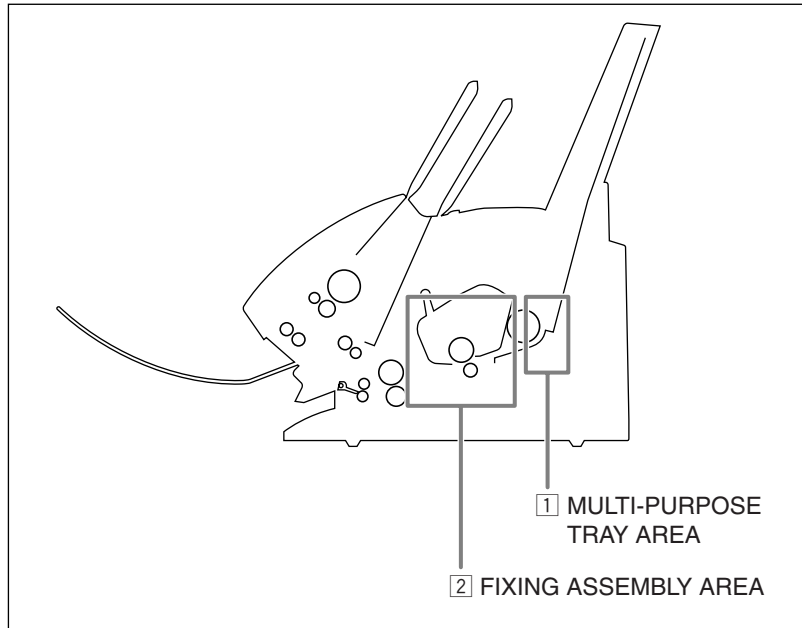

1 Multi-purpose tray area:

Hold the machine steady and carefully pull the jammed paper straight out from the machine.

- Do this carefully to prevent tearing the jammed paper. If you do tear it, be sure to remove any torn pieces from the machine since these will cause paper to jam again.
- The toner on the paper will not have been fixed to the paper yet, so remove the jammed paper carefully to avoid soiling the inside of the machine. Loose toner powder inside the machine may adversely affect print quality.
- Loose toner powder can soil any surface; protect yourself and your work area. Remove immediately any toner powder from yourself or your clothing with cold water.

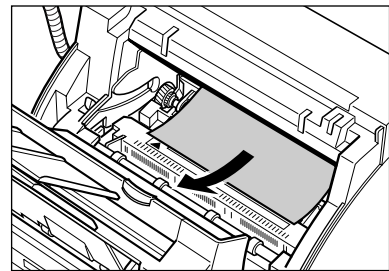

2 Fixing assembly area:

Top edge of the jammed paper in the fixing assembly:

Push the jammed paper back ①, then pull it carefully toward you to remove it ②.



The fixing assembly becomes extremely hot when the machine is in use. Be very careful not to touch it so as to avoid injury.

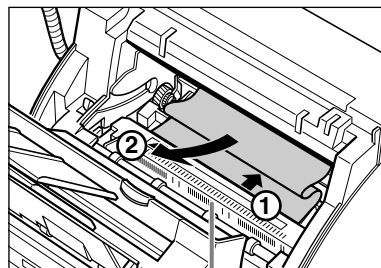

DO NOT TOUCH THE FIXING ASSEMBLY

Top edge of the jammed paper has passed through the fixing assembly:

Pass the jammed paper under the roller.

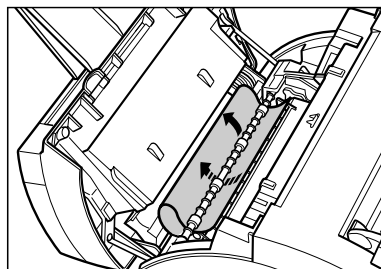

Use both hands to carefully pull out the jammed paper.

- Do this carefully to prevent tearing the jammed paper. If you do tear it, be sure to remove any torn pieces from the machine since these will cause paper to jam again.

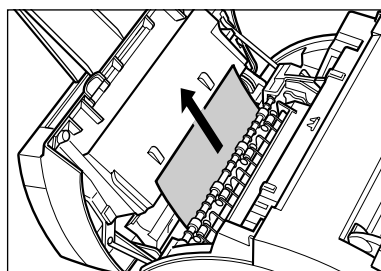

- 5** When you are finished, reinsert the cartridge. Hold the cartridge by its handle and insert it into the machine as far as it will go, making sure that its tabs are aligned with the rails inside the machine.

- Always hold the cartridge by its handle.

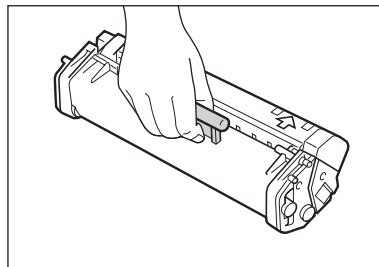
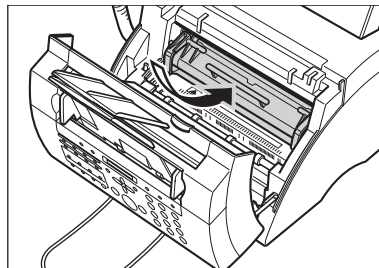

- 6** Move the paper release lever forward.

- 7** Use both hands to close the front cover.

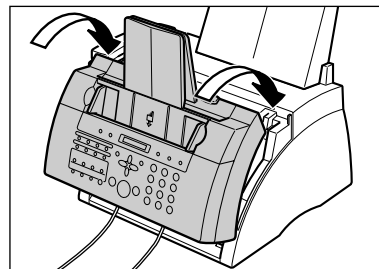

- 8** Reload paper in the multi-purpose tray (→ *Set-Up Instructions*).



- Note** If you are experiencing repeated paper jams, it may be due to the paper you are using:
- Tap the paper on a flat surface before stacking it in the multi-purpose tray.
 - Check that the paper you are using meets the requirements for your machine (→ p. 3-4).
 - Make sure you have completely removed any scraps of paper from inside the machine. Not doing so will cause paper to jam again.

LCD Messages

The following messages are displayed in the LCD when the machine is performing a task, or when it encounters an error. The error code appears in the ACTIVITY REPORT

Message	Error Code	Cause	Action
AUTO REDIAL	—	The machine is waiting to redial the other party's fax number because the line was busy or the other party did not answer when you tried to send the document.	Wait for the machine to automatically redial the fax number (→ <i>User's Guide</i>).
BUSY/NO SIGNAL	#018	The fax/telephone number you dialed is busy.	Try sending the document at a later time.
		The fax number dialed was incorrect.	Check the fax number and dial again.
		The other party's fax machine is not working.	Contact the other party and have them check their fax machine.
		The other party is not using a G3 fax machine.	Contact the other party to check that they are using a G3 fax machine.
		The telephone line type setting on your machine is incorrect.	Set your machine for your telephone line type (→ p. 2-8).
		The receiving fax machine did not answer within 55 seconds (after all automatic redialing attempts).	Contact the other party and have them check their fax machine. You can try to send the document using manual sending via the handset (→ <i>User's Guide</i>). For an overseas call, add pauses to the registered number (→ <i>User's Guide</i>).
CHANGE CARTRIDGE	—	The toner inside the cartridge may be unevenly distributed.	Redistribute the toner inside the cartridge (→ p. 8-7). If the message remains, replace the cartridge (→ p. 8-7).

Message	Error Code	Cause	Action
CHANGE CARTRIDGE (Continued)		The cartridge is empty.	Replace the FX-3 cartridge (→ p. 8-7).
CHECK COVER	—	The front cover is open.	Close the front cover.
CHECK DOCUMENT	#001	A document is jammed in the ADF.	Clear the document jam (→ p. 9-2). Then start again.
CHECK PAPER SIZE	—	The size of the paper in the multi-purpose tray and that specified in the PAPER SIZE setting are different.	Load the correct paper size (→ <i>Set-Up Instructions</i>) or change the PAPER SIZE setting (→ p. 3-9) to match the size of the paper loaded in the multi-purpose tray.
CHECK POLLING ID	#021	The subaddress and/or password do not match the settings on the other party's fax machine.	Make sure the subaddress and/or password match the settings on the other party's fax machine (→ <i>User's Guide</i>).
	#008	No subaddress and/or password has been entered on the other party's machine, or the subaddress and/or password do not match the settings on your machine.	Contact the other party to enter the correct subaddress and/or password.
CHECK PRINTER	—	The cartridge may be defective.	Reinstall the cartridge (→ <i>Set-Up Instructions</i>). If the message remains in the LCD, replace the cartridge (→ p. 8-7).
		The machine is connected to an uninterruptible power supply (UPS).	Make sure the machine is plugged into an AC outlet. In either case, if the error does not clear, try unplugging the machine. Wait five seconds, then plug it back in. If the message remains in the LCD, contact the Canon Customer Care Center.

Message	Error Code	Cause	Action
CHK SUBADDR/PSWD	#083/102	You attempted to send a document or poll another fax machine with the incorrect subaddress and/or password.	Contact the other party to check their settings. Change your settings if necessary (→ pp. 4-7, 4-11).
CLEAR PAPER JAM	—	There is a paper jam.	Clear the paper jam (→ p. 9-3), then reload paper in the multi-purpose tray (→ <i>Set-Up Instructions</i>).
DOC. TOO LONG	#003	The document is longer than 39.4 inches (1 meter).	Use a copier to make a reduced copy of the document and then send the copy.
ECM RX	—	The machine is receiving a fax using Error Correction Mode (ECM).	Receiving with ECM may take longer than normal receptions. Turn off ECM if you need to receive quickly, or if you know your local lines are in good condition (→ ECM RX, p. 10-7).
ECM TX	—	The machine is sending a fax using Error Correction Mode (ECM).	Sending with ECM may take longer than normal transmissions. Turn off ECM if you need to transmit quickly, or if you know your local lines are in good condition (→ ECM TX, p. 10-6).
LOAD PAPER	—	The multi-purpose tray is empty.	Load paper in the multi-purpose tray (→ <i>Set-Up Instructions</i>), then press Stop/Reset .

Message	Error Code	Cause	Action
MEMORY FULL	#037	The machine's memory is full because it has received too many documents, or a very long or detailed document.	Print any documents you no longer need to be stored in memory (→ <i>User's Guide</i>). Then start again.
		The machine's memory is full because you tried to send too many pages at once, or a very long or detailed document.	Divide the document and send each part separately. To free up space in the machine's memory, print, send, or delete any documents you no longer need to be stored in memory (→ <i>User's Guide</i>).
MEMORY USED <i>nn</i> %	—	Shows the percentage of memory currently in use.	If you need more space, wait for the machine to send any faxes. Also, print, send, or delete any documents you no longer need to be stored in memory (→ <i>User's Guide</i>).
NO RX PAPER	#012	The other party's fax machine is out of paper or its memory is full.	Contact the other party and have them load paper in their fax machine or free up space in their fax machine's memory.
NO TEL #	#022	The one-touch speed dialing button or coded speed dialing code you entered has not been registered.	Register the one-touch speed dialing button or coded speed dialing code (→ Chapter 4).
NOT AVAILABLE	—	You entered an invalid number.	Enter a valid number.
PSWD POLL REJECT	#084	You attempted to poll a fax machine with a password, but the other party has not set a password or their fax machine does not support polling with a password.	Contact the other party to check their settings. If their fax machine does not support polling with a password, delete the password you have registered (→ pp. 4-7, 4-11).

Message	Error Code	Cause	Action
PSWD TX REJECTED	#081	You attempted to send a document with a password, but the other party's fax machine does not support reception with a password.	Contact the other party to check their settings. If their fax machine does not support reception with a password, delete the password you have registered (→ pp. 4-7, 4-11).
REC'D IN MEMORY	—	The machine received the fax in memory because paper or toner ran out, or a paper jam occurred during reception. The loaded paper size may not match the size of the fax being received.	Load paper in the multi-purpose tray (→ <i>Set-Up Instructions</i>), replace the FX-3 cartridge (→ p. 8-7), or clear the paper jam (→ p. 9-3). Load the correct paper in the multi-purpose tray (→ p. 3-4).
SELECT POL REJECT	#082	You attempted to poll a fax machine with a subaddress, but the other party has not set a subaddress or their fax machine does not support polling with a subaddress.	Contact the other party to check their settings. If their fax machine does not support polling with a subaddress, delete the subaddress you have registered (→ pp. 4-7, 4-11).
SUBADD TX REJECT	#080	You attempted to send a document with a subaddress, but the other party's fax machine does not support reception with a subaddress.	Contact the other party to check their settings. If their fax machine does not support reception with a subaddress, delete the subaddress you have registered (→ pp. 4-7, 4-11).
TX/RX CANCELLED	—	You pressed Stop/Reset to cancel a transaction.	—
TX/RX NO. <i>nnnn</i>	—	The number shown (<i>nnnn</i>) is a unique identification number assigned to the document you are sending or receiving.	This number appears in reports so you can identify transactions. Write the number down if you will need it later.
TX/RX NO. <i>nnnn</i> SCANNING P. <i>nnn</i> MEMORY FULL (Three messages toggle.)	—	The machine is sending a document and its memory is full.	The machine continues to send the document as memory becomes available.

Paper Feeding Problems

■ Paper does not feed properly.

The multi-purpose tray may contain too many sheets.

- Make sure you load the correct quantity (→ p. 3-4).

The print media may not be loaded correctly.

- Make sure the print media is loaded correctly in the multi-purpose tray (→ *User's Guide*).

■ Multiple sheets feed together into the machine.

The print media may not be loaded correctly.

- Make sure the print media is loaded correctly in the multi-purpose tray (→ *User's Guide*).

The multi-purpose tray may contain too many sheets.

- Make sure you load the correct quantity (→ p. 3-4).

Different types of print media may be loaded in the multi-purpose tray.

- Load only one type of print media.
- Make sure you load print media that meets the requirements for the machine (→ p. 3-4).
- Let the print media run out before refilling the multi-purpose tray. Avoid mixing new stock with print media already loaded.

■ Repeated paper jams occur.

The print media you are using may be causing the jams.

- Make sure you load print media that meets the requirements for the machine (→ p. 3-4).

■ Envelopes do not load.

Envelopes may not be loaded correctly.

- Make sure the envelopes are loaded properly (→ *User's Guide*). Do not load more than 7 envelopes in the multi-purpose tray.

The envelopes you are using may not meet the requirements for the machine.

- Make sure you load envelopes that meets the requirements for the machine (→ p. 3-4).

The envelopes may not be feeding properly.

- Make sure you are using face-up delivery (→ p. 3-7).

Printing Problems

■ The machine beeps while printing.

The machine may have a paper jam.

- Clear the paper jam (→ p. 9-3).

■ Nothing prints.

The power cord may not be plugged in securely.

- Check that the power cord is plugged securely into the machine and into the wall outlet (→ *Set-Up Instructions*). If the machine is plugged into a power strip, make sure the power strip is plugged in and turned on.

You may not have removed the plastic seal from the cartridge.

- Make sure you install the cartridge properly (→ *Set-Up Instructions*).

The cartridge may need to be replaced.

- Replace the cartridge (→ p. 8-7).

■ Printout does not match the print media size.

The print media may not be loaded correctly.

- Make sure the print media is loaded correctly in the multi-purpose tray (→ *User's Guide*).

■ Printout is skewed.

The print media may not be loaded correctly.

- Make sure the print media is loaded correctly in the multi-purpose tray (→ *User's Guide*).
- Make sure the paper delivery slots are clear.

■ Print media jams occur.

You may not be using the correct paper delivery slot.

- Select the correct paper delivery slot (→ p. 3-7).

■ Printout is not clear.

You may not be using the correct print media type.

- Make sure you load print media that meets the requirements for the machine (→ p. 3-4).

You may be printing on the wrong side of the paper.

- Some papers have a “right” side for printing. If the print quality is not as clear as you would like it to be, try turning the paper over and printing on the other side.

■ Printout has vertical white streaks.

Toner may be low or unevenly distributed.

- Redistribute the toner inside the cartridge (→ p. 8-7). If the problem persists, replace the cartridge (→ p. 8-7).

Faxing Problems

Sending Problems

■ Cannot send a fax.

The machine may not be set for the correct telephone line type.

- Make sure the machine is set for the correct telephone line type (→ p. 2-8).

The document may not be loaded correctly.

- Make sure the document is loaded correctly in the ADF (→ p. 3-3).
- Make sure the operation panel is closed.

The one-touch speed dialing button or coded speed dialing code you entered may not be registered correctly.

- Check that the speed dialing settings are registered correctly (→ Chapter 4).

You dialed or have been provided with an incorrect number.

- Dial the number again, or check that you have the correct number.

The other party's fax machine may be out of paper.

- Contact the other party and ask them to make sure paper is loaded in their fax machine.

There may be other documents being sent from memory.

- Allow time for those documents to finish sending.

An error may have occurred during sending.

- Print an ACTIVITY REPORT (→ *User's Guide*) and check for an error code (→ p. 9-8).

The telephone line may not be working properly.

- Make sure there is a dial tone when you press **Hook** or when you lift the handset of any external device connected to the machine. If there is no dial tone, contact your local telephone company.

The receiving fax machine may not be a G3 fax machine.

- Make sure the receiving fax machine is compatible with your machine (which is a G3 fax machine).

The subaddress and/or password are incorrect.

- If you registered a subaddress/password under a speed dialing button or code, make sure they match the other party's settings.

■ Faxes sent from the machine are spotted or dirty.

The receiving fax machine may not be working properly.

- Check the machine by making a copy (→ p. 6-2). If the copy is clear, the problem may be in the receiving fax machine. If the copy is spotted or dirty, clean the scanner components (→ p. 8-5).

The document may not be loaded correctly.

- Make sure the document is loaded correctly in the ADF (→ p. 3-3).

■ **Cannot send using Error Correction Mode (ECM).**

The other party's fax machine may not support ECM.

- If this is the case, the document is sent without ECM.

ECM may be disabled.

- Make sure ECM on your machine is enabled (→ ECM TX, p. 10-6).
- Contact the other party to check if ECM on their fax machine is enabled.

■ **Errors occur frequently while sending.**

The telephone lines may be in poor condition, or you may have a bad connection.

- Lower the transmission speed (→ TX START SPEED, p. 10-10).



If none of these solutions solve the problem, unplug the machine and wait for at least five seconds. Then plug it back in and try sending again. If you still cannot send, contact the Canon Customer Care Center.

Receiving Problems

■ **Cannot receive a fax automatically.**

The machine may not be set to receive automatically.

- For the machine to receive faxes automatically, the receive mode must be set to FAX ONLY MODE, Fax/Tel Mode, ANS.MACHINE MODE, or DRPD (→ *User's Guide*). If you have set ANS.MACHINE MODE, confirm that an answering machine is connected to the machine and that it is turned on with an outgoing message properly recorded (→ *User's Guide*).

The machine may have a document stored in memory, leaving little or no memory available.

- Print, send, or delete any documents you no longer need to be stored in memory (→ *User's Guide*).

An error may have occurred during reception.

- Check the LCD for an error message (→ p. 9-8).
- Print an ACTIVITY REPORT (→ *User's Guide*) and check for an error code (→ p. 9-8).

The multi-purpose tray may be empty.

- Make sure paper is loaded in the multi-purpose tray (→ *User's Guide*).

The telephone line cord may not be connected properly.

- Make sure it is connected properly (→ *Set-Up Instructions*).

■ No automatic switching between telephone and fax calls.

The machine may not be set to switch automatically between telephone and fax calls.

- For the machine to switch automatically, the receive mode must be set to Fax/Tel Mode, ANS.MACHINE MODE, or DRPD (→ *User's Guide*). If you have set ANS.MACHINE MODE, confirm that an answering machine is connected to the machine and that it is turned on with an outgoing message properly recorded (→ *User's Guide*).

The machine may have a document stored in memory, leaving little or no memory available.

- Print, send, or delete any documents you no longer need to be stored in memory (→ *User's Guide*).

An error may have occurred during reception.

- Check the LCD for an error message (→ p. 9-8).
- Print an ACTIVITY REPORT (→ *User's Guide*) and check for an error code (→ p. 9-8).

The multi-purpose tray may be empty.

- Make sure paper is loaded in the multi-purpose tray (→ *User's Guide*).

The other party's fax machine may not send the CNG signal that tells your machine that the incoming call is a fax call.

- Some fax machines cannot send this signal. In such cases, you will have to receive the fax manually (→ p. 5-3).

■ Cannot receive a document manually.

You may have disconnected the call by pressing Start/Copy or dialing the remote receiving ID after hanging up.

- Always press **Start/Copy** or dial the remote receiving ID *before* hanging up. Otherwise you will disconnect the call (→ p. 5-3).

■ Print quality is poor.

You may not be using the correct paper type.

- Make sure you load paper that meets the requirements for the machine (→ p. 3-4).

The other party's fax machine may not be functioning properly.

- The sending fax machine usually determines the machine's quality. Contact the other party and have them check that the scanning components of their fax machine are clean.

Error Correction Mode (ECM) may be disabled.

- Make sure ECM is on (→ ECM RX, p. 10-7).

■ Faxes do not print.

The cartridge may not be installed properly.

- Make sure the cartridge is installed properly (→ *Set-Up Instructions*).

The cartridge may need to be replaced.

- Replace the cartridge (→ p. 8-7).

■ Received faxes print blotched or unevenly.

The telephone lines may be in poor condition, or you may have a bad connection.

- Error Correction Mode (ECM) sending/receiving should eliminate such problems. However, if the telephone lines are in poor condition, you may have to try again.

The other party's fax machine may not be functioning properly.

- The sending fax machine usually determines the fax's quality. Contact the other party and have them check that the scanning components of their fax machine are clean.

Toner may be low or unevenly distributed.

- Redistribute the toner inside the cartridge (→ p. 8-7). If the problem persists, replace the cartridge (→ p. 8-7).

■ Cannot receive using Error Correction Mode (ECM).

The other party's fax machine may not support ECM.

- If this is the case, the document is received without ECM.

ECM may be disabled.

- Make sure ECM on your machine is enabled (→ ECM RX, p. 10-7).
- Contact the other party to check if ECM on their fax machine is enabled.

■ Errors occur frequently while receiving.

The telephone lines may be in poor condition, or you may have a bad connection.

- Lower the reception speed (→ RX START SPEED, p. 10-10).

The other party's fax machine may not be functioning properly.

- Contact the other party and have them check that their fax machine is functioning properly.

Copying Problems

■ Cannot make copies.

The document may not be loaded correctly.

- Make sure the document is loaded correctly in the ADF (→ p. 3-3).
- Make sure the operation panel is closed.

The document may not meet the requirements for the machine.

- Make sure you load documents that meet the requirements for the machine (→ p. 3-2).



For additional troubleshooting, see *Printing Problems*, p. 9-14.

Note

Telephone Problems

■ Cannot dial.

The telephone line cord may not be connected properly.

- Make sure it is connected properly (→ *Set-Up Instructions*).

The power cord may not be plugged in securely.

- Check that the power cord is plugged securely into the machine and into the wall outlet (→ *Set-Up Instructions*). If the machine is plugged into a power strip, make sure the power strip is plugged in and turned on.

The machine may not be set for the correct telephone line type.

- Make sure the machine is set for the correct telephone line type (→ p. 2-8).

■ Handset or extension telephone disconnects while you are talking.

The power cord may not be plugged in securely.

- Check that the power cord is plugged securely into the machine and into the wall outlet (→ *Set-Up Instructions*). If the machine is plugged into a power strip, make sure the power strip is plugged in and turned on.

The handset or extension telephone cord may be defective.

- Check the cord by substituting with another cord.

Installation Problems

■ For Windows 2000/XP: Are you not able to complete the installation of the printer driver?

During the installation, you may be unable to continue beyond the dialog box prompting you to connect the USB cable to your port. (If you cannot continue, the system is unable to display the found new hardware wizard, described in Step 6 in the “Installing the Software” section in Chapter 2 of the *Software User’s Guide*).

In this situation, you need to exit the setup, remove the device from the Windows Device Manager, and restart the installation process.

To resolve this situation:

1. Click No in the dialog box prompting you to connect your cable, and exit the setup.
2. Remove the device from the Windows Device Manager. The device may appear listed as Canon FAXPHONE L80 or Unknown Device. To remove the device: Click Start, point to Settings and then click Control Panel (in Windows XP, click Start, and then click Control Panel). In the Control Panel window, double-click System, click Hardware tab, and then click Device Manager (in Windows XP, click Performance and Maintenance, click System, and then on the Hardware tab, click Device Manager). Under Universal Serial Bus Controllers or Other Devices, click the device and press the Delete key.

If you are unable to remove the device, disconnect the power cord from the printer to turn it off, and then reconnect the power cord.

3. Disconnect the USB cable from the port.
4. Start the installation process again. For instructions, see Chapter 2, “Installing the Printer Driver” of the *Software User’s Guide*.

■ **For Windows 98/Me: Are you not able to complete the installation of the printer driver?**

During the installation, you may be unable to continue beyond the dialog box prompting you to connect the USB cable to your port.

In this situation, you need to exit the setup, remove the device from the Windows Device Manager, and restart the installation process.

To resolve this situation:

1. Click No in the dialog box prompting you to connect your cable, and exit the setup.
2. Remove the device from the Windows Device Manager. The device may appear listed as Canon FAXPHONE L80 or Unknown Device.

To remove the device: Click Start, point to Settings and then click Control Panel. In the Control Panel window, double-click System. On Device Manager tab, under Universal Serial Bus Controllers or Other Devices, click the device and press the Delete key.

If you are unable to remove the device, disconnect the power cord from the printer to turn it off, and then reconnect the power cord.

3. Disconnect the USB cable from the port.
4. Start the installation process again. For instructions, see Chapter 2, “Installing the Printer Driver” of the *Software User’s Guide*.

Printing Problems with Your Computer.

■ **Is the LCD blank?**

You might have a power problem. Check that the power cord is plugged securely into the printer, and that your power source is OK.

■ **Is the printer warm to the touch?**

The printer might have overheated and shut down. Turn the printer off and let it cool down for several minutes. Try using it again. Be aware that when you turn the printer off, any unprinted documents are cleared from printer memory. Unprinted documents can include received faxes waiting to be printed or scheduled faxes waiting to be sent.

■ **Does paper not come out of the printer?**

Make sure the Print Setup option of your printing application shows your printer as the printer selected.

■ **Does the job not print when using DOS?**

The printer driver can be used to print documents only in Windows; it cannot print a document in DOS.

■ Is the document printing with undesirable results?

You may experience undesirable results when printing a document if you have the Windows Printing System (or other bi-directional device, such as a later model laser printer) installed on your computer and you are attempting to use the same port on which you also have the printer connected. Be sure that the printer is the only device configured to a particular port.

■ Is the document not printing?

If your document is not printing, consider the following.

■ The printer driver may not have installed fully.

To verify if the installation was incomplete, display Programs (in Windows XP, display All Programs) in the Start menu on the Windows desktop. If the Canon FAXPHONE L80 item does not appear, you need to complete the printer driver installation.

To do so, insert the installation disk into your disk drive.

Follow the on-screen instructions to complete the installation.

(If installation does not start automatically, click Start, and then click Run. In the Run dialog box, type D:\SETUP.EXE (where D: is your disk drive containing the installation disk), and then click OK.)

■ You need to check your Windows application settings.

To determine if your Windows application settings may be the problem, print a test page with your printer driver. To do so, open the printer properties dialog box. On the General tab, click Print Test Page.

If the test page prints successfully, the printer and printer driver are set up appropriately. Therefore, check the settings for your Windows application.

■ You may need to remove and reinstall the printer driver.

To determine if you need to remove and reinstall the printer driver, print a test page (as described in the previous item). If the test page does not print successfully, remove the printer driver, and then reinstall (as described in Chapter 2 of the *Software User's Guide*).

■ Are you unable to print to a shared printer?

If you are using a client system that is set up to use a shared printer, yet you are unable to print to the shared printer, check the following:

- That the server system, to which the printer is connected, is turned on
- That the server system has set the printer to be shared
- That the server system is set to allow your system access to the shared printer.

■ Does paper not load into the printer?

The multi-purpose tray might contain too many sheets or paper might not be inserted all the way into the multi-purpose tray.

■ **Does paper not feed through one sheet at a time?**

Be sure to fan the stack of paper before placing it in the multi-purpose tray.

■ **Is an envelope not loading correctly?**

Make sure you do not stack more than 7 envelopes in the multi-purpose tray.

■ **Is some of the document content not printing?**

If some of the document content is not printing, check that the USB cable is securely plugged in at both ends. Make sure your cable does not exceed 16.4 feet (5 meters). Check your application's print setup to make sure your printer is selected.

■ **Does some of the document content not fit on the page?**

Make sure paper is aligned correctly in the multi-purpose tray. Check that margins and paper size are set correctly in your printing application. Also, check that the scaling is set appropriately in the printer driver settings. The scaling may be set to enlarge the document page to a size that is too large for the paper.

■ **Is printing not clear?**

Check the print resolution. A higher resolution prints more clearly.

■ **Do fonts not print smoothly?**

Bitmapped fonts designed for dot matrix printers will not look smooth when printed by your high-resolution printer. Choose another font. Make sure you install an outline font manager such as Adobe Type Manager or Bitstream Facelift, or that you choose a TrueType font.

■ **Is the printing not dark enough?**

Check the print settings, such as the print resolution, brightness, contrast, and toner saver. Try replacing the toner cartridge.

■ **Did a toner low warning appear while printing?**

If you want to continue printing your document, even though you are low on toner, change the TONER SUPPLY LOW setting on the printer from RX TO MEMORY to KEEP PRINTING. (Even if the toner cartridge is out of toner, the document will not be stored in memory.)

■ **Do vertical white streaks appear?**

Vertical white streaks may appear when the error message CHANGE CARTRIDGE is displayed. This situation indicates that the toner level is low or that the toner is unevenly distributed in the cartridge.

To resolve the situation, open the front cover of the printer and remove the toner cartridge. Gently rock the cartridge from side to side five or six times to evenly distribute the toner inside. Replace the cartridge in the printer, and close the front cover.

If redistributing the toner does not resolve the situation, replace your cartridge. (→ p. 8-7)

General Problems

■ Machine has no power.

The power cord may not be plugged in securely.

- Check that the power cord is plugged securely into the machine and into the wall outlet (→ *Set-Up Instructions*). If the machine is plugged into a power strip, make sure the power strip is plugged in and turned on.

The power cord may not be supplying power.

- Check the power cord by substituting with another, or by using a voltmeter to test it for continuity.

■ Nothing appears in the LCD.

The power cord may not be plugged in securely.

- Check that the power cord is plugged securely into the machine and into the wall outlet (→ *Set-Up Instructions*). If the machine is plugged into a power strip, make sure the power strip is plugged in and turned on. If the LCD remains blank, unplug the machine and wait five seconds, then plug it back in. If the LCD still remains blank, contact the Canon Customer Care Center.

If You Cannot Solve a Problem

If you have a problem with your machine that you cannot solve with the information provided in this chapter, contact the Canon Customer Care Center (→ p. ii).



Attempting to repair the machine yourself may void the limited warranty.



If the machine makes strange noises, emits smoke or strange smells, unplug it immediately and contact the Canon Customer Care Center. Do not attempt to disassemble or repair the machine yourself.

If you contact the Canon Customer Care Center, make sure you have the following information ready:

- **Product name: FAXPHONE L80**
- **Serial number (on the label located at the back of the machine)**
- **Details of the problem**
- **Steps taken to try to resolve the problem and the results**

If a Power Failure Occurs

If power is suddenly lost due to a power failure or accidental unplugging, a built-in battery retains the machine's settings. However, any documents stored in memory will be lost.

During a power failure, functions are limited as follows:

- You cannot make telephone calls using the handset. Also, depending on your telephone, you may not be able to make calls using the extension telephone connected to your machine.
- You cannot send, receive, or copy documents.
- You can receive telephone calls through the handset. Also, depending on your telephone, you may be able to receive calls through the extension telephone connected to your machine.

When power is restored, your machine automatically prints a MEMORY CLEAR REPORT that lists the documents that were deleted from memory as a result of the power failure.

12/26/2003 16:48 FAX 123 4567		CANON		001	
***** *** MEMORY CLEAR REPORT *** *****					
MEMORY FILES DELETED					
TX/RX NO	MODE	CONNECTION TEL/ID	PGS.	SET TIME	ST. TIME
0046	TRANSMIT	[* 01] Canon TOKYO	3	12/26 16:03	
0047	B'CAST	[01] Canon CANADA	1	12/26 16:08	
		[* 02] Canon FRANCE			
0048	DEL SQ BDCST	[03] Canon ITALIA	1	12/26 16:15	20:00
		[04] Canon U.S.A.			20:00
0049	DELAYED TX	[08] Canon OPTICS	2	12/26 16:36	22:00



Note If the cartridge is empty or there is no paper in the multi-purpose tray when power is restored, the LCD displays CHANGE CARTRIDGE or LOAD PAPER. In these cases, the MEMORY CLEAR REPORT will not be printed even after the cartridge is replaced or paper is loaded.

Chapter 10

Summary of Settings

Understanding the Menu System

The machine menu system allows you to customize the way your machine operates. It consists of seven menus, each containing settings that control different functions of your machine.

Before adjusting any settings, you may want to print the USER'S DATA LIST to check the current settings (→ below).

Printing a List to Check the Current Settings

You can print the USER'S DATA LIST to check the current settings of your machine as well as the registered sender information (→ p. 2-5).

Follow this procedure to print the USER'S DATA LIST:

1 Press **Function**.

2 Press **Report**.

ACTIVITY REPORT

3 Use ▼ or ▲ to select **USER DATA LIST**.

USER DATA LIST

4 Press **Set**.

- The machine prints the USER'S DATA LIST.

PRINTING REPORT

The sender information is shown at the beginning of the list. The current settings of the machine are listed after this.

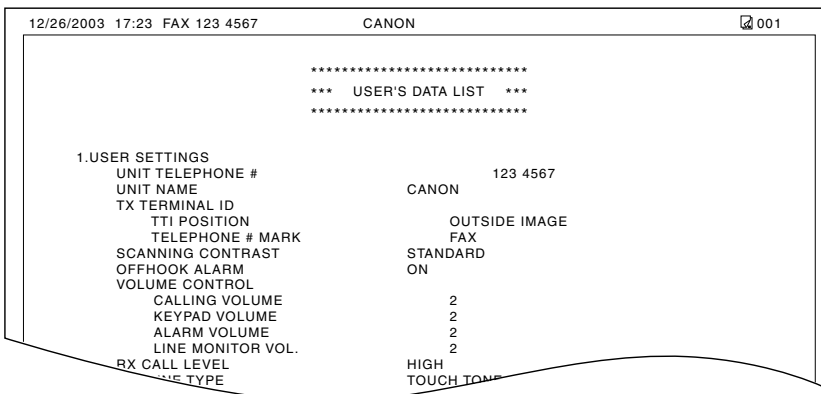

Accessing the Menus

Follow this procedure to access the different menus:

1 Press **Function**.

2 Press **Data Registration**.

DATA REGISTRATION

3 Press **Set**.

USER SETTINGS

4 Use ▼ or ▲ to select the menu you want.

- You can select from the following:
 - USER SETTINGS (→ p. 10-4)
 - REPORT SETTINGS (→ p. 10-5)
 - TX SETTINGS (→ p. 10-6)
 - RX SETTINGS (→ p. 10-7)
 - PRINTER SETTINGS (→ p. 10-8)
 - POLLING BOX (→ p. 10-9)
 - SYSTEM SETTINGS (→ p. 10-10)

5 Press **Set** to access the settings under the menu you selected.

ECM RX

6 Refer to the appropriate table (→ following pages) and use these guidelines to select and register settings:

- Use ▼ or ▲ to scroll through the settings.
- To register a setting or access sub-settings, press **Set**.
- To return to a previous level, press **Function** then **Data Registration**.
 - For your settings to be registered, be sure to press **Set** after making a selection or entering information.
 - If at any stage you wish to return to standby mode, press **Stop/Reset**.
 - If you pause for more than 60 seconds while accessing a menu, the machine will automatically return to standby mode.

7 When you are finished, press **Stop/Reset** to return to standby mode.

12/26

FaxTel

USER SETTINGS Menu

For details on accessing the settings below, see p. 10-3.

Default settings are shown in **bold** type.

Setting	Description	Sub-Settings
DATE & TIME	Sets the current date and time (→ p. 2-6).	–
UNIT TELEPHONE #	Enters the fax/telephone number you want to appear at the top of each fax page you send (→ p. 2-6).	–
UNIT NAME	Enters the name or company name you want to appear at the top of each fax page you send (→ p. 2-7).	–
TX TERMINAL ID	Sets the options for the sender information.	–
TTI POSITION	Selects whether the sender information is positioned inside or outside the image area (→ p. 2-5).	OUTSIDE IMAGE INSIDE IMAGE
TELEPHONE # MARK	Selects the prefix for the machine number (→ p. 2-5).	FAX TEL
SCAN CONTRAST	Selects the scanning contrast (→ p. 4-3).	STANDARD DARKER LIGHTER
OFFHOOK ALARM	Enables/disables the off hook alarm that alerts you that the handset is not seated properly in its cradle.	ON OFF
VOLUME CONTROL	Sets the volume of the machine sounds.	–
CALLING VOLUME	Selects the ring volume when the machine detects a voice call.	1/ 2 /3
KEYPAD VOLUME	Selects the keypad touch beep volume.	0 (off)/1/ 2 /3
ALARM VOLUME	Selects the error alarm volume.	0 (off)/1/ 2 /3
LINE MONITOR VOL	Selects the line monitor volume (sound during dialing).	0 (off)/1/ 2 /3
RX CALL LEVEL	Selects the ring type for incoming calls.	HIGH STANDARD
TEL LINE TYPE	Selects the telephone line type setting for your machine (→ p. 2-8).	TOUCH TONE ROTARY PULSE

REPORT SETTINGS Menu

For details on accessing the settings below, see p. 10-3.

Default settings are shown in **bold** type.

Setting	Description	Sub-Settings
TX REPORT	Enables/disables automatic printing of a TX (transmission) REPORT (→ <i>User's Guide</i>). PRINT ERROR ONLY: Prints a report only when a transmission error occurs. OUTPUT YES: Prints a report every time you send a document. OUTPUT NO: No report is printed.	PRINT ERROR ONLY OUTPUT YES OUTPUT NO
PRINT WITH IMAGE	If you select PRINT ERROR ONLY or OUTPUT YES above, this setting enables/disables printing of the first page of the fax under the report.	ON OFF
RX REPORT	Enables/disables automatic printing of an RX (reception) REPORT (→ <i>User's Guide</i>). OUTPUT NO: No report is printed. PRINT ERROR ONLY: Prints a report only when a reception error occurs. OUTPUT YES: Prints a report every time you receive a document.	OUTPUT NO PRINT ERROR ONLY OUTPUT YES
ACTIVITY REPORT	Enables/disables automatic printing of an ACTIVITY REPORT after every 20 transactions (→ <i>User's Guide</i>).	AUTO PRINT ON AUTO PRINT OFF

TX (Transmission) SETTINGS Menu

For details on accessing the settings below, see p. 10-3.

Default settings are shown in **bold** type.

Setting	Description	Sub-Settings
ECM TX	Enables/disables Error Correction Mode (ECM) during transmission.	ON OFF
MID PAUSE SET	Selects the length of a pause entered within a fax/telephone number with the Pause button.	2 SEC (1 to 15)
AUTO REDIAL	Enables/disables automatic redialing if the other party's line is busy on the first attempt (→ <i>User's Guide</i>).	ON OFF
REDIAL TIMES	Selects the number of redial attempts.	2 TIMES (1 to 10)
REDIAL INTERVAL	Selects the time interval between redial attempts.	2 MIN. (2 to 99)
TIME OUT	Enables/disables automatic scanning of documents after the fax number is entered. ON: Scanning begins automatically five seconds after entering the fax number (10 seconds if sending to multiple fax numbers). OFF: Scanning does not start automatically. (You need to press Start/Copy to begin scanning.)	ON OFF

RX (Reception) SETTINGS Menu

For details on accessing the settings below, see p. 10-3.

Default settings are shown in **bold** type.

Setting	Description	Sub-Settings
ECM RX	Enables/disables Error Correction Mode (ECM) during reception.	ON OFF
RX MODE	Selects the receive mode (→ p. 5-2). If you select FAX/TEL AUTO SW or DRPD, you can select additional sub-settings (→ <i>User's Guide</i>).	FAX/TEL AUTO SW FAX ONLY MODE DRPD
INCOMING RING	When the RX MODE setting is set to FAX ONLY MODE or FAX/TEL AUTO SW, this setting enables/disables ringing when the machine receives a call.*	OFF ON
RING COUNT	Selects the number of rings before the machine begins receiving.	2 TIMES (1 to 99)
MAN/AUTO SWITCH	When the receive mode is set to MANUAL MODE, this setting determines if the machine switches to fax receive mode after it rings for a specified time.	OFF ON
F/T RING TIME	If you select ON above, this setting selects the length of time the machine rings before switching to fax receive mode.	15 SEC (1 to 99)
REMOTE RX	Enables/disables remote receiving.	ON OFF
REMOTE RX ID	If you select ON above, this setting selects the remote receiving ID.	25 (00 to 99)
MEMORY RX	Enables/disables reception of a document in the machine's memory when a problem occurs.	ON OFF
RX PAGE FOOTER	Enables/disables printing of the reception date and time, transaction number (TX/RX NO.), and page number at the bottom of each received fax page.	OFF ON

* Even if you have set INCOMING RING to ON, ringing will only occur if you have connected the handset or an extension telephone to your machine.

PRINTER SETTINGS Menu

For details on accessing the settings below, see p. 10-3.

Default settings are shown in **bold** type.

Setting	Description	Sub-Settings
RX REDUCTION	Enables/disables reduction of faxes to fit on the paper loaded in the multi-purpose tray. If you select ON, you can select the direction of the reduction.	ON OFF VERTICAL ONLY HORIZ & VERTICAL
PAPER SIZE	Selects the size of the paper loaded in the multi-purpose tray (→ p. 3-9). If you select CUSTOM, you can select additional sub-settings (→ p. 3-9).	LTR LGL CUSTOM A4
ECONOMY PRT	Enables/disables economy printing (→ <i>User's Guide</i>).	OFF ON
TONER SUPPLY LOW	Selects whether the machine continues printing when toner level is low (CHANGE CARTRIDGE displayed in the LCD). RX TO MEMORY: Stops printing and received faxes are stored in memory. KEEP PRINTING: Ignores the warning and keeps printing the entire document. This setting is convenient when you do not have a new FX-3 cartridge at hand. Note however, that when you select this setting, the machine will not receive the document in memory when the cartridge is completely empty. Once you install a new FX-3 cartridge, be sure to set RX TO MEMORY.	RX TO MEMORY KEEP PRINTING

POLLING BOX Menu

For details on accessing the settings below, see p. 10-3.

Default settings are shown in **bold** type.

Setting	Description	Sub-Settings
SETUP FILE	Sets up the polling box to hold a document to be polled (→ <i>User's Guide</i>).	–
FILE NAME	Enters the name for the polling box.	–
PASSWORD	Enters a password to restrict access to the polling box settings.	0000 to 9999
TX PASSWORD	Enters an ITU-T-standard password.	–
ERASE AFTER TX	Selects whether the document is deleted from memory once it is polled, or continues to be stored in memory. ON: Document is deleted from memory after it is polled. OFF: Document remains in memory after it is polled.	ON OFF
CHANGE DATA	Changes the polling box settings (→ <i>User's Guide</i>).	–
PASSWORD	Enters the password (if registered) to access the polling box settings.	–
DELETE FILE	Deletes the polling box settings (→ <i>User's Guide</i>).	–
PASSWORD	Enters the password (if registered) to access the polling box settings.	–

SYSTEM SETTINGS Menu

For details on accessing the settings below, see p. 10-3.

Default settings are shown in **bold** type.

Setting	Description	Sub-Settings
RX RESTRICTION	Restricts reception of faxes to the numbers registered for speed dialing on your machine (→ <i>User's Guide</i>). If you select ON, you can select additional sub-settings.	OFF ON
DATE SETUP	Selects the date format displayed in the LCD and printed on the faxes you send.	MM/DD/YYYY DD/MM YYYY YYYY MM/DD
DISPLAY LANGUAGE	Selects the language of the LCD messages, settings, and reports.	ENGLISH FRENCH SPANISH PORTUGUESE
TX START SPEED	Selects the speed at which the machine starts transmitting.	33600bps 14400bps 9600bps 7200bps 4800bps 2400bps
RX START SPEED	Selects the speed at which the machine starts receiving.	33600bps 14400bps 9600bps 7200bps 4800bps 2400bps
DAYLIGHT SAV TIME	Sets the daylight saving time (→ <i>User's Guide</i>). If you select ON, you can select additional sub-settings.	OFF ON

Appendix Specifications

General Specifications

Power Source

120–127 V/60 Hz

Power Consumption

- Max.: Approx. 660 W
- Standby: Approx. 3.5 W

Weight

Approx. 22 lb./10 kg (With components attached)

Dimensions

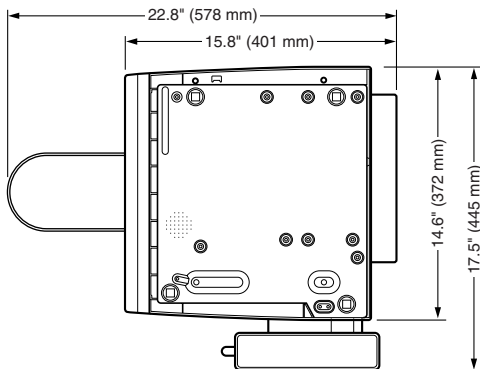
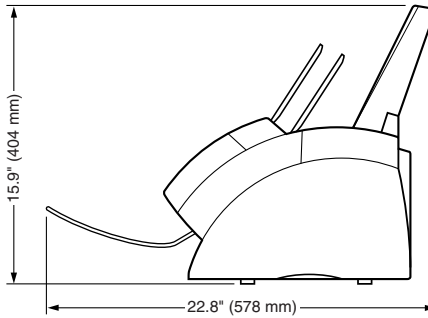
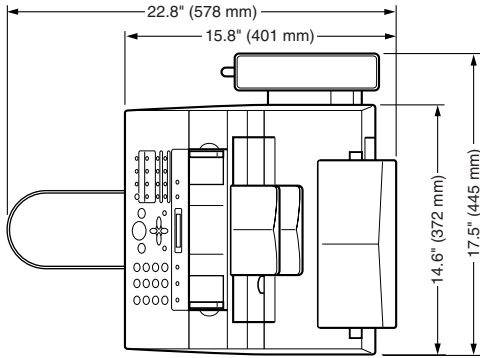

Environmental Conditions	<ul style="list-style-type: none"> • Temperature: 50°F–90.5°F (10°C–32.5°C) • Humidity: 20%–80%
Liquid Crystal Display (LCD)	16 × 1
Display Languages	English/French/Spanish/Portuguese
Applicable Standards	<ul style="list-style-type: none"> • Electrical safety: UL1950, C-UL • Radiation: FCC Part 15 Class B, IC • Other: FCC Part 68, IC CS-03, Energy Star compliant
ADF Capacity	→ p. 3-2
Multi-Purpose Tray Capacity	→ p. 3-4
Printable Areas	→ p. 3-5
Scanned Area	→ p. 3-2

System Requirements

→ p. 7-2

Print Specifications

Printing Method	Laser beam printing
Paper Handling	Automatic feed
Print Media Size and Weight	→ p. 3-4
Recommended Print Media	→ p. 3-6
Print Speed	Approx. 6 pages/minute
Print Width	Max. 8.2 in. (208 mm)
Resolution	600 × 600 dpi

Copy Specifications

Copy Speed	• Approx. 6 pages/minute
No. of Copies	Max. 99 copies
Scanning Resolution	<ul style="list-style-type: none"> – Direct Copy: 400 × 300 dpi – Memory Copy: 200 × 300 dpi
Printing Resolution	600 × 600 dpi
Reduction	70%, 80%, 90%

Facsimile Specifications

Applicable Line	Public Switched Telephone Network (PSTN)
Compatibility	G3
Data Compressing System	MH, MR, MMR
Modem Type	Fax modem
Modem Speed	33.6/31.2/28.8/26.4/24/21.6/19.2/16.8/14.4/12/9.6/7.2/4.8/ 2.4 Kbps

Transmission Speed	Approx. 3 seconds/page at 33.6 Kbps, ECM-MMR, transmitting from memory
Scanning Image Processing	<ul style="list-style-type: none"> • UHQ™ (Ultra High Quality) image enhancement • Halftones: 64 levels of gray • Density adjustment: 3 levels
Memory	Transmission/reception: 350 pages (Based on ITU-T No.1 Chart, standard mode.)
Fax Scanning Speed	Approx. 7.7 seconds/page (Based on ITU-T No.1 Chart, standard mode.)
Fax Resolution	<ul style="list-style-type: none"> • <FAX STANDARD>: 203 pels/in. × 98 lines/in. (8 pels/mm × 3.85 lines/mm) • <FAX FINE>: 203 pels/in. × 196 lines/in. (8 pels/mm × 7.7 lines/mm) • <FAX PHOTO>: 203 pels/in. × 196 lines/in. with halftones (8 pels/mm × 7.7 lines/mm with halftones) • <SUPER FINE>: 203 pels/in. × 392 lines/in. (8 pels/mm × 15.4 lines/mm)
Dialing	<ul style="list-style-type: none"> • Automatic dialing <ul style="list-style-type: none"> One-touch speed dialing (15 destinations) Coded speed dialing (100 destinations) Group dialing (Max. 114 destinations) Directory dialing (with Directory button) • Regular dialing (with numeric buttons) • Automatic redialing • Manual redialing • Pause button • Redial button
Networking	<ul style="list-style-type: none"> • Sequential broadcast (Max. 116 destinations) • Automatic reception • Automatic fax/tel switchover • Delayed transmission (Max. 116 destinations) • Polling transmission • Polling reception • Remote reception by telephone (Default ID: 25) • Non-ring reception • ECM deactivation • DRPD (Distinctive Ring Pattern Detection) • ACTIVITY REPORT (after every 20 transactions) • Non-delivery report • TTI (Transmit Terminal Identification)

Telephone Specifications

Connection	<ul style="list-style-type: none"> – Extension telephone/answering machine (CNG detecting signal)/data modem – Handset
-------------------	--

Specifications subject to change without notice

Index

- ▼ button 1-4
- ◀ button 1-4, 2-4
- ▶ button 1-4, 2-3, 2-4
- ▲ button 1-4
- (→ p. n-nn), definition v
- (→ *User's Guide*), definition v

A

- A4 setting 3-2, 3-4
- ACTIVITY REPORT
 - setting 10-5
- ADF 1-3
 - capacity 3-2
 - jams in 9-2
- ALARM VOLUME setting 10-4
- ANS.MACHINE MODE
 - description 5-2
- Answering machine 5-2
- Area
 - printable 3-5
 - scanned of document 3-2
- AUTO REDIAL
 - message 9-8
 - setting 10-6
- Automatic Document Feeder. *See* ADF
- Automatic redialing
 - setting 10-6

B

- BUSY/NO SIGNAL message 9-8
- Button. *See individual button names*

C

- CALLING VOLUME setting 10-4
- Canceling
 - receiving 5-4
 - sending 4-5
- Cartridge
 - compartment 1-3
 - replacing 8-7 to 8-9
- CHANGE CARTRIDGE message 8-7, 9-8, 9-9
- CHANGE DATA setting 10-9
- CHECK COVER message 9-9
- CHECK DOCUMENT message 9-2, 9-9
- CHECK PAPER SIZE message 9-9
- CHECK POLLING ID message 9-9
- CHECK PRINTER message 9-9
- CHK SUBADDR/PSWD message 9-10
- Cleaning
 - scanner components 8-5, 8-6
 - machine's exterior 8-2
 - machine's interior 8-2 to 8-4
- Clear button 1-4, 2-4
- CLEAR PAPER JAM message 9-3, 9-10
- Coded Dial button 1-4, 4-6, 4-11
- Coded speed dialing 4-6
 - registering 4-11 to 4-13
 - sending with 4-14
- Components, machine 1-3. *See also individual component names*
- Contrast
 - copying, setting 4-3
 - sending, setting 4-3
- Conventions, type v
- Copying 6-2, 6-3
 - document requirements 3-2
 - features 1-2
 - problems 9-18
- Correcting mistake 2-4
- Cover
 - front 1-3
 - multi-purpose tray 1-3
- CUSTOM setting 3-4, 3-9, 10-8
- CUSTOM1/LONG setting 3-4, 3-9
- CUSTOM2/SHORT setting 3-4, 3-9
- Customer support back cover

D

Data

Registration button 1-4, 10-3

Date, entering 2-6

DATE & TIME setting 2-6, 10-4

DATE SETUP setting 10-10

Daylight Saving Time 10-10

Default, definition v

DELETE FILE setting 10-9

Delivery, paper. *See* Paper delivery

Destination labels 4-10

Dialing

coded speed dialing. *See* Coded speed dialing

group dialing. *See* Group dialing

one-touch speed dialing. *See* One-touch speed

dialing

speed. *See* Speed dialing

Dimensions A-2

Directory button 1-4

DISPLAY LANGUAGE setting 10-10

DOC. TOO LONG message 9-10

Document

definition v

guide 1-3

loading 3-3

problem 3-2

quantity 3-2

requirements 3-2

scanned area 3-2

size 3-2

support 1-3

thickness 3-2

weight 3-2

Documentation iv

Basic Guide iv

FAXPHONE L80 User's Guide iv

Printer Driver Software User's Guide iv

Set-Up Instructions iv

DRPD

description 5-2

setting 10-7

E

ECM RX

message 9-10

setting 10-7

ECM TX

message 9-10

setting 10-6

ECONOMY PRT setting 10-8

Envelopes

printable area 3-5

requirements 3-4

selecting 3-6

ERASE AFTER TX setting 10-9

F

F/T RING TIME setting 10-7

Face-down delivery 3-7, 3-8

slot 1-3

Face-up delivery 3-7, 3-8

slot 1-3

Fax

definition v

features 1-2

FAX ONLY MODE

description 5-2

setting 10-7

FAX setting 10-4

FAX/TEL AUTO SW setting 10-7

Fax/Tel Mode

description 5-2

setting 10-7

FaxOnly setting. *See* FAX ONLY MODE

FAXPHONE. *See* Machine

FaxTel setting. *See* Fax/Tel Mode

Features, FAXPHONE 1-2

FILE NAME setting 10-9

Fixing assembly 1-3

Front cover 1-3

Function button 1-4

FX-3. *See* Cartridge

G

Group dialing 4-6

Guide

document 1-3

paper 1-3

H

Handling, safety information viii, ix

Handset 1-2

Hook button 1-4

HORIZ & VERTICAL setting 10-8

I

Image Quality button 1-4, 4-2, 6-2

INCOMING RING setting 10-7

INSIDE IMAGE setting 10-4

J

Jams

clearing 9-2 to 9-7

in ADF 9-2

in paper delivery slots 9-3

inside machine 9-3 to 9-7

paper 9-3 to 9-7

K

KEEP PRINTING setting 10-8
KEYPAD VOLUME setting 10-4

L

Label
 destination 4-10
Latch 1-3
LCD 1-4
 messages 9-8 to 9-12. *See also individual message names*
Letter
 entering 2-2, 2-3
 mode 2-2, 2-3
Lever, paper release 1-3, 9-4
LGL setting 3-4, 3-9, 10-8
LINE MONITOR VOL setting 10-4
LOAD PAPER message 9-10
Loading
 document 3-3
 paper 3-6
Location
 safety information vi
LTR setting 3-4, 3-9, 10-8

M

Maintenance, safety information ix
Machine
 cleaning 8-2 to 8-6
 clearing jams 9-2 to 9-7
 components 1-3, 1-4. *See also individual component names*
 features 1-2
 name, registering 2-6, 2-7
 number, registering 2-6, 2-7
MAN/AUTO SWITCH setting 10-7
MANUAL MODE
 description 5-2
 setting 5-3
Manual setting. *See* MANUAL MODE
Memory
 Reference button 1-4
 sending. *See* Memory sending
MEMORY CLEAR REPORT 9-25
 sample 9-25
MEMORY FULL message 9-11
MEMORY RX setting 10-7
Memory sending 4-4, 4-5
 canceling 4-5
MEMORY USED nn% message 9-11
Menu. *See also individual menu names*
 accessing 10-3
 definition v
 system, understanding 10-2, 10-3
Messages. *See* LCD messages
MID PAUSE SET setting 10-6
Mistake, correcting 2-4
Multi-purpose tray 1-3

capacity 3-4
cover 1-3

N

NO RX PAPER message 9-11
NO TEL # message 9-11
NOT AVAILABLE message 9-11
Number
 entering 2-2, 2-3
 mode 2-2, 2-3
Numeric buttons 1-4, 2-2

O

OFFHOOK ALARM setting 10-4
One-touch speed dialing 4-6
 buttons 1-4, 4-7
 registering 4-7 to 4-10
 sending with 4-14
Operation panel 1-3, 1-4
OUTPUT NO setting 10-5
OUTPUT YES setting 10-5
OUTSIDE IMAGE setting 10-4

P

Panel
 operation 1-3, 1-4
Paper
 delivery. *See* Paper delivery
 feeding problems 9-13
 guide 1-3
 jams 9-3 to 9-7
 path 3-8
 printable area 3-5
 quantity 3-4
 release lever 1-3, 9-4
 requirements 3-4
 selecting 3-6
 size setting 3-4, 3-9
 weight 3-4
Paper delivery
 face-down 3-7, 3-8
 face-up 3-7, 3-8
 selecting 3-7, 3-8
 selector 1-3, 3-7, 3-8
 slot, jams in 9-3
PAPER SIZE setting 3-9, 10-8
Password
 registering for coded speed dialing 4-11 to 4-13
 registering for one-touch speed dialing 4-7 to 4-10
PASSWORD setting 10-9
Pause button 1-4
Power
 failure 9-25
 supply, safety information vii
PRINT ERROR ONLY setting 10-5

- Print media
 - requirements 3-4
 - selecting 3-6
- PRINT WITH IMAGE setting 10-5
- Printer
 - features 1-2
- PRINTER SETTINGS menu 10-3, 10-8
- Printing
 - area 3-5
 - document 7-3
 - problems 9-14
- Print Settings
 - defining 7-4, 7-5
 - viewing a summary 7-6
- Problems
 - cannot solve 9-24
 - copying 9-18
 - document 3-2
 - general 9-23
 - installing 9-19 to 9-20
 - paper feeding 9-13
 - printing 9-14
 - printing from computer 9-20 to 9-22
 - receiving 9-16 to 9-18
 - sending 9-15, 9-16
 - telephone 9-19
- PSWD POLL REJECT message 9-11
- PSWD TX REJECTED message 9-12
- Pulse dialing
 - setting for 2-8

Q

- Quantity
 - document 3-2
 - envelopes 3-4
 - paper 3-4
 - transparencies 3-4

R

- REC'D IN MEMORY message 9-12
- Receive Mode button 1-4
- Receiving. *See also individual receive modes*
 - canceling 5-4
 - methods 5-2
 - problems 9-16 to 9-18
- Redial button 1-4
- REDIAL INTERVAL setting 10-6
- REDIAL TIMES setting 10-6
- REMOTE RX ID setting 10-7
- REMOTE RX setting 10-7
- Replacing FX-3 cartridge 8-7 to 8-9
- Report button 1-4, 10-2
- REPORT SETTINGS menu 10-3, 10-5
- Resolution
 - copying, setting 6-2
 - sending, setting 4-2

- RING COUNT setting 10-7
- Roller, transfer charging 1-3
- ROTARY PULSE setting 2-8, 10-4
- RX (Reception) SETTINGS menu 10-3, 10-7
- RX CALL LEVEL setting 10-4
- RX MODE setting 10-7
- RX PAGE FOOTER setting 10-7
- RX REDUCTION setting 10-8
- RX REPORT. *See also* RX (Reception) REPORT setting 10-5
- RX RESTRICTION setting 10-10
- RX SETTINGS menu. *See* RX (Reception) SETTINGS menu
- RX START SPEED setting 10-10
- RX TO MEMORY setting 10-8

S

- Safety information vi to ix
- SCAN CONTRAST setting 4-3, 10-4
- Scanner components, cleaning 8-5, 8-6
- Scanning
 - contrast, copying 4-3
 - contrast, sending 4-3
 - document area 3-2
 - resolution, copying 6-2
 - resolution, sending 4-2
- SELECT POL REJECT message 9-12
- Selector, paper delivery 1-3, 3-8
- Sender information
 - definition 2-5
 - registering 2-6, 2-7
 - sample 2-5
- Sending
 - canceling 4-5
 - document requirements 3-2
 - memory 4-4, 4-5
 - methods 4-4
 - problems 9-15, 9-16
 - with coded speed dialing 4-14
 - with group dialing 4-14
 - with one-touch speed dialing 4-14
 - with speed dialing 4-14
- Serial number, machine 9-24
- Set button 1-4, 10-3
- Settings. *See also individual setting names*
 - printing list of 10-2
- SETUP FILE setting 10-9
- Size
 - document 3-2
 - envelopes 3-4
 - paper 3-4, 3-9, 3-10
 - transparencies 3-4
- Space button 1-4, 2-3
- Special function buttons 1-4. *See also individual button names*

Speed dialing. *See also individual speed dialing methods*

definition 4-6

methods 4-6

sending document with 4-14

using 4-14

Standby mode 1-4

Start/Copy button 1-4, 5-3, 5-4

Starter cartridge 8-7

Stop/Reset button 1-4, 10-3

SUBADD TX REJECT message 9-12

Subaddress

registering for coded speed dialing 4-11 to 4-13

registering for one-touch speed dialing 4-7 to 4-10

Support

customer back cover

document 1-3

tray 1-3

Symbols, entering 2-2, 2-3

SYSTEM SETTINGS menu 10-3, 10-10

T

TEL LINE TYPE setting 2-8, 10-4

TEL setting 10-4

Telephone

features 1-2

problems 9-19

TELEPHONE # MARK setting 10-4

Telephone line type

setting 2-8

Thickness, document 3-2

Time

entering 2-6

TIME OUT setting 10-6

Tone dialing

setting for 2-8

TONER SUPPLY LOW setting 10-8

TOUCH TONE setting 2-8, 10-4

Transfer charging roller 1-3

Transparencies

requirements 3-4

selecting 3-6

Tray

multi-purpose 1-3

multi-purpose, cover 1-3

support 1-3

TTI POSITION setting 10-4

TX (Transmission) SETTINGS menu 10-3, 10-6

TX PASSWORD setting 10-9

TX REPORT

setting 10-5

TX SETTINGS menu. *See TX (Transmission)*

SETTINGS menu

TX START SPEED setting 10-10

TX TERMINAL ID setting 10-4

TX/RX CANCELLED message 9-12

TX/RX NO. nnnn message 9-12

TX/RX NO. nnnn, SCANNING P.nnn, MEMORY FULL message 9-12

Type conventions v

U

UNIT NAME setting 2-7, 10-4

UNIT TELEPHONE # setting 2-6, 10-4

USER SETTINGS menu 10-3, 10-4

USER'S DATA LIST

printing 10-2

sample 10-2

User's Guide v

type conventions v

V

VERTICAL ONLY setting 10-8

Volume

ALARM VOLUME setting 10-4

CALLING VOLUME setting 10-4

KEYPAD VOLUME setting 10-4

LINE MONITOR VOL setting 10-4

VOLUME CONTROL setting 10-4

VOLUME CONTROL setting 10-4

W

Weight

document 3-2

machine A-2

paper 3-4



The contents of this guide are
printed on 70% recycled paper.

Canon

CANON INC.

30-2, Shimomaruko 3-chome, Ohta-ku, Tokyo 146-8501, Japan

CANON U.S.A., INC.

One Canon Plaza, Lake Success, NY 11042, U.S.A.

CANON CANADA INC.

6390 Dixie Road Mississauga, Ontario L5T 1P7, Canada

CANON EUROPA N.V.

Bovenkerkerweg 59-61 P.O. Box 2262, 1180 EG Amstelveen, The Netherlands

CANON FRANCE S.A.

17,quai du President Paul Doumer 92414 Courbevoie Cedex, France

CANON (U.K.) LTD.

Woodhatch, Reigate, Surrey, RH2 8BF, United Kingdom

CANON DEUTSCHLAND GmbH

Europark Fichtenhain A10, 47807 Krefeld, Germany

CANON ITALIA S.p.A.

Via Milano, 8-20097 San Donato Milanese (MI) Italy

CANON LATIN AMERICA, INC.

703 Waterford Way, Suite 400, Miami, Florida 33126, U.S.A.

CANON AUSTRALIA PTY. LTD

1 Thomas Holt Drive, North Ryde, Sydney, N.S.W. 2113, Australia

CANON SINGAPORE PTE. LTD.

79 Anson Road #09-01/06, Singapore 079906

CANON HONGKONG CO., LTD

9/F, The Hong Kong Club Building, 3A Chater Road, Central, Hong Kong

Free Manuals Download Website

<http://myh66.com>

<http://usermanuals.us>

<http://www.somanuals.com>

<http://www.4manuals.cc>

<http://www.manual-lib.com>

<http://www.404manual.com>

<http://www.luxmanual.com>

<http://aubethermostatmanual.com>

Golf course search by state

<http://golfingnear.com>

Email search by domain

<http://emailbydomain.com>

Auto manuals search

<http://auto.somanuals.com>

TV manuals search

<http://tv.somanuals.com>