

Canon

PUB. DIE-323

Digital Video Camcorder  
**Instruction Manual**

**FS20**

**FS21**

**FS22**

**FS200**



**NTSC**



  
PictBridge

# Important Usage Instructions

## WARNING!



**TO REDUCE THE RISK OF FIRE OR ELECTRIC SHOCK, DO NOT EXPOSE THIS PRODUCT TO RAIN OR MOISTURE.**

## WARNING!



**TO REDUCE THE RISK OF ELECTRIC SHOCK AND TO REDUCE ANNOYING INTERFERENCE, USE THE RECOMMENDED ACCESSORIES ONLY.**

## COPYRIGHT WARNING:

**Unauthorized recording of copyrighted materials may infringe on the rights of copyright owners and be contrary to copyright laws.**

Digital Video Camcorder, FS22 A/FS21 A/FS20 A/FS200 A systems

This device complies with Part 15 of the FCC Rules. Operation is subject to the following two conditions: (1) This device may not cause harmful interference, and (2) this device must accept any interference received, including interference that may cause undesired operation.

Note: This equipment has been tested and found to comply with the limits for class B digital device, pursuant to Part 15 of the FCC Rules. These limits are designed to provide reasonable protection against harmful interference in a residential installation. This equipment generates, uses and can radiate radio frequency energy and, if not installed and use in accordance with the instructions, may cause harmful interference to radio communications. However, there is no guarantee that interference will not occur in a particular installation. If this equipment does cause harmful interference to radio or television reception, which can be determined by turning the equipment off and on, the user is encouraged to try to correct the interference by one or more of the following measures:

- Reorient or relocate the receiving antenna.
- Increase the separation between the equipment and receiver.
- Connect the equipment into an outlet on a circuit different from that to which the receiver is connected.
- Consult the dealer or an experienced radio/TV technician for help.

The cable with the ferrite core provided with the digital video camcorder must be used with this equipment in order to comply with Class B limits in Subpart B of Part 15 of the FCC rules.

Do not make any changes or modifications to the equipment unless otherwise specified in the manual.

If such changes or modifications should be made, you could be required to stop operation of the equipment.

Canon U.S.A., Inc.

One Canon Plaza, Lake Success, NY 11042, U.S.A.

Tel No. (516)328-5600

## CAUTION:

**TO PREVENT ELECTRIC SHOCK, MATCH WIDE BLADE OF PLUG TO WIDE SLOT, FULLY INSERT.**

The Mains plug is used as the disconnect device. The Mains plug shall remain readily operable to disconnect the plug in case of an accident.

## Important Warning



The lightning flash with arrowhead symbol, within an equilateral triangle, is intended to alert the user to the presence of uninsulated "dangerous voltage" within the product's enclosure, that may be of sufficient magnitude to constitute a risk of electric shock to persons.

## CAUTION:

**TO REDUCE THE RISK OF ELECTRIC SHOCK, DO NOT REMOVE COVER (OR BACK). NO USER-SERVICEABLE PARTS INSIDE. REFER SERVICING TO QUALIFIED SERVICE PERSONNEL.**



The exclamation point, within an equilateral triangle, is intended to alert the user to the presence of important operating and maintenance (servicing) instructions in the literature accompanying the product.

# IMPORTANT SAFETY INSTRUCTIONS

In these safety instructions the word “product” refers to the Canon Digital Video Camcorder FS22 A/FS21 A/FS20 A/FS200 A and all its accessories.

- 1** Read these instructions.
- 2** Keep these instructions.
- 3** Heed all warnings.
- 4** Follow all instructions.
- 5** Do not use this apparatus near water.
- 6** Clean only with dry cloth.
- 7** Do not install near any heat sources such as radiators, heat registers, stoves, or other apparatus (including amplifiers) that produce heat.
- 8** Do not defeat the safety purpose of the polarized or grounding-type plug. A polarized plug has two blades with one wider than the other. A grounding type plug has two blades and a third grounding prong. The wide blade or the third prong are provided for your safety. If the provided plug does not fit into your outlet, consult an electrician for replacement of the obsolete outlet.
- 9** Protect the power cord from being walked on or pinched particularly at plugs, convenience receptacles, and the point where they exit from the apparatus.
- 10** Only use attachments/accessories specified by the manufacturer.
- 11** Unplug this apparatus during lightning storms or when unused for long periods of time.
- 12** Refer all servicing to qualified service personnel. Servicing is required when the apparatus has been damaged in any way, such as power-supply cord or plug is damaged, liquid has been spilled or objects have fallen into the apparatus, the apparatus has been exposed to rain or moisture, does not operate normally, or has been dropped.
- 13** Read Instructions — All the safety and operating instructions should be read before the product is operated.
- 14** Retain Instructions — The safety and operating instructions should be retained for future reference.
- 15** Heed Warnings — All warnings on the product and in the operating instructions should be adhered to.
- 16** Follow Instructions — All operating and maintenance instructions should be followed.
- 17** Cleaning — Unplug this product from the wall outlet before cleaning. Do not use liquid or aerosol cleaners. The product should be cleaned only as recommended in this manual.
- 18** Accessories — Do not use accessories not recommended in this manual as they may be hazardous.
- 19** Avoid magnetic or electric fields — Do not use the camera close to TV transmitters, portable communication devices or other sources of electric or magnetic radiation. They may cause picture interference, or permanently damage the camera.
- 20** Water and Moisture — Hazard of electric shock — Do not use this product near water or in rainy/moist situations.
- 21** Placing or Moving — Do not place on an unstable cart, stand, tripod, bracket or table. The product may fall, causing serious injury to a child or adult, and serious damage to the product.  
A product and cart combination should be moved with care. Quick stops, excessive force, and uneven surfaces may cause the product and cart combination to overturn.  

- 22** Power Sources — The CA-570 Compact Power Adapter should be operated only from the type of power source indicated on the marking label. If you are not sure of the type of power supply to your home, consult your product dealer or local power company. Regarding other power sources such as battery power, refer to instructions in this manual.
- 23** Polarization — The CA-570 Compact Power Adapter is equipped with a polarized 2-prong plug (a plug having one blade wider than the other).  
The 2-prong polarized plug will fit into the power outlet only one way. This is a safety feature. If you are unable to insert the plug fully into the outlet, try reversing the plug. If the plug still fails to fit, contact your electrician to replace your obsolete outlet. Do not defeat the safety purpose of the polarized plug.
- 24** Power Cord Protection — Power cords should be routed so that they are not likely to be walked on or pinched by items placed upon or against them. Pay particular attention to plugs and the point from which the cords exit the product.

- 25 Outdoor Antenna Grounding** — If an outside antenna is connected to the product, be sure the antenna is grounded so as to provide some protection against voltage surges and built-up static charges. Section 810 of the National Electrical Code, ANSI / NFPA No. 70—1984, provides information with respect to proper grounding of the mast and supporting structure, grounding of the lead-in wire to an antenna discharge unit, size of grounding conductors, location of antenna discharge unit, connection to grounding electrodes, and requirements for the grounding electrode. See figure 1.

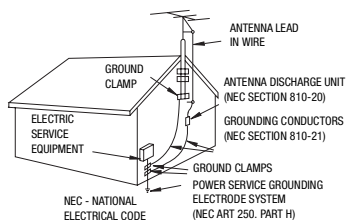
**Fig. 1** EXAMPLE OF ANTENNA GROUNDING AS PER NATIONAL ELECTRICAL CODE



- 26 Lightning** — For added protection of this product during a lightning storm, or when it is left unattended and unused for long periods of time, disconnect it from the wall outlet and disconnect the antenna. This will prevent damage to the product due to lightning and power-line surges.
- 27 Overloading** — Do not overload wall outlets and extension cords as this can result in a risk of fire or electric shock.
- 28 Objects and Liquid Entry** — Never push objects of any kind into this product through openings as they may touch dangerous voltage points or short out parts that could result in a fire or electric shock. Be careful not to spill liquid of any kind onto the product.
- 29 Servicing** — Do not attempt to service this product yourself as opening or removing covers may expose you to dangerous voltage or other hazards. Refer all servicing to qualified service personnel.
- 30 Damage Requiring Service** — Disconnect this product from the wall outlet and all power sources including battery, and refer servicing to qualified service personnel under the following conditions:
- When the power-supply cord or plug is damaged.
  - If any liquid has been spilled onto, or objects have fallen into, the product.
  - If the product has been exposed to rain or water.
  - If the product does not operate normally even if you follow the operating instructions. Adjust only those controls that are covered by the operation instructions. Improper adjustment of other controls may result in damage and will often require extensive work by a qualified technician to restore the product to its normal operation.
  - If the product has been dropped or the cabinet has been damaged.
  - When the product exhibits a distinct change in performance. This indicates a need for service.
- 31 Replacement Parts** — When replacement parts are required, be sure the service technician has used replacement parts that are specified by Canon or that have the same characteristics as the original part. Unauthorized substitutions may result in fire, electric shock or other hazards.
- 32 Safety Check** — Upon completion of any service or repairs to this product, ask the service technician to perform safety checks to determine that the product is in safe operating order.
- 33 Heat** — The product should be situated away from heat sources such as radiators, heat registers, stoves, or other products (including amplifiers) that produce heat.

When replacement of the power supply is required, please return it to the responsible nearest Canon Service Center and please replace it with the same type number CA-570.

The Adapter can be used with a power supply between 100 and 240 V AC. For areas where 120 V AC power is not used, you will need a special plug adapter. Contact your nearest Canon Service Center for further information.

This Class B digital apparatus complies with Canadian ICES-003.

# Getting to Know the Camcorder

## What is so special about recording on flash memory?

Your videos and photos are recorded in the built-in memory (**FS22** / **FS21** / **FS20** only) or on a memory card (SD or SDHC card). Recording on flash memory means that there are no moving parts in the recorder unit of the camcorder. To you, it means a camcorder that is smaller, lighter and faster.



## Other features of this camcorder

Whether you are using a camcorder for the first time or are very experienced, this camcorder offers many easy-to-use functions. The following are just but a few examples of the many functions that can enrich your shooting experience.

- Dual Shot (□ 25): With Dual Shot (  mode), recording is as simple as pressing a single button and using the zoom lever. The camcorder will take care of the rest!
- Special Scene recording programs (□ 44): When recording in a variety of situations, such as at the beach, the camcorder automatically selects the optimal settings for that situation.
- Pre-recording function (□ 49): The camcorder records for 3 seconds before you start shooting, ensuring that those once-in-a-lifetime moments do not slip by.
- Video snapshot (□ 47): Create a montage of scenes and even set it to music when you play it back.

# Table of contents

## Introduction

---

- 5 Getting to Know the Camcorder
- 10 About this Manual
- 12 Overview**
- 12 Supplied Accessories and CD-ROMs
- 13 Components Guide
- 16 Screen Displays

## Preparations

---

- 19 Getting Started**
- 19 Charging the Battery Pack
- 21 Preparing the Wireless Controller (**FS22**) only) and Accessories
- 23 Adjusting the Position and Brightness of the LCD Screen
- 25 Basic Operation of the Camcorder**
- 25 Operating Modes
- 26 Joystick and Joystick Guide
- 27 Using the Menus
- 28 First Time Settings**
- 28 Setting the Date and Time
- 29 Changing the Language
- 29 Changing the Time Zone
- 31 Using a Memory Card**
- 31 Memory Cards Compatible for Use with the Camcorder
- 31 Inserting and Removing a Memory Card
- 32 **FS22** / **FS21** / **FS20** Selecting the Memory for the Recordings
- 32 Initializing the Built-In Memory (**FS22** / **FS21** / **FS20** only) or Memory Card

## Video

---

### **34 Basic Recording**

- 34 Shooting Video
- 35 Selecting the Video Quality  
(Recording Mode)
- 35 Zooming: Optical, Advanced and Digital Zoom
- 37 Quick Start Function

### **38 Basic Playback**

- 38 Playing Back the Video
- 40 Selecting What Recordings to Play Back
- 40 Selecting Scenes by Recording Date
- 41 Selecting the Playback Starting Point from the Movie Timeline
- 42 Pre-selecting Recordings from the Index Screen
- 43 Deleting Scenes

### **44 Advanced Functions**

- 44 Special Scene Recording Programs
- 45 Controlling Shutter Speed and Other Functions while Shooting
- 47 Mini Video Light
- 47 Video Snapshot
- 49 Pre-recording Function
- 49 Self Timer
- 50 Automatic Backlight Correction and Manual Exposure  
Adjustment
- 51 Manual Focus Adjustment
- 51 White Balance
- 52 Image Effects
- 53 Digital Effects
- 54 On-Screen Displays and Data Code
- 54 Using Headphones
- 55 Using an External Microphone

### **56 Playlist and Scene Operations**

- 56 Dividing Scenes
- 56 Editing the Playlist: Adding, Deleting and Moving Playlist  
Scenes

- 58 **FS22 / FS21 / FS20** Copying Scenes

## Photos

---

### 60 **Basic Recording**

- 60 Taking Photos
- 60 Selecting Photo Size and Quality
- 62 Erasing a Photo Right After Recording It

### 62 **Basic Playback**

- 62 Viewing Photos
- 64 Magnifying Photos during Playback
- 65 Deleting Photos

### 66 **Additional Functions**

- 66 **FS22 / FS21 / FS20** Drive Mode: Continuous Shooting and Exposure Bracketing
- 67 Histogram Display
- 67 Protecting Photos
- 68 **FS22 / FS21 / FS20** Copying Photos
- 69 Other Functions You Can Use When Taking Photos

### 69 **Printing Photos**

- 69 Printing Photos
- 70 Selecting the Print Settings
- 72 Print Orders

## External Connections

---

### 75 **Terminals on the Camcorder**

- 75 Connection Diagrams

### 76 **Playback on a TV Screen**

### 77 **Saving and Backing Up Your Recordings**

- 77 Backing Up Your Recordings on a Computer
- 77 Authoring DVD Discs and Photo DVDs
- 80 Copying your Recordings to an External Video Recorder



80	Transferring Photos to a Computer (Direct Transfer)
83	Transfer Orders

## Additional Information

---

### **84 Appendix: Menu Options Lists**

84	FUNC. Menu
86	Setup Menus
86	Camera Setup (Zoom Type, Image Stabilizer, etc.)
88	Memory Operations (Initialization, etc.)
88	Display Setup (LCD Brightness, Language, etc.)
90	System Setup (Speaker Volume, Beep, etc.)
92	Date/Time Setup

### **93 Trouble?**

93	Troubleshooting
97	List of Messages

### **105 Do's and Don'ts**

105	Handling Precautions
108	Maintenance/Others
109	Using the Camcorder Abroad
109	Music Files

### **111 General Information**

111	System Diagram
112	Optional Accessories
114	Product Codes
115	Specifications
118	Index

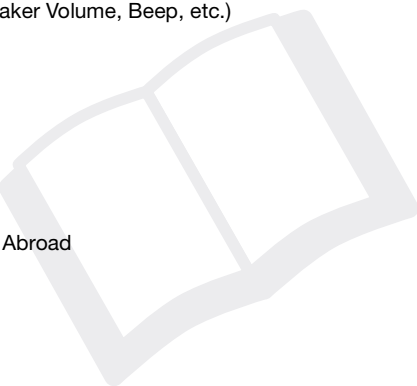





## About this Manual

Thank you for purchasing the Canon FS22/FS21/FS20/FS200\*. Please read this manual carefully before you use the camcorder and retain it for future reference. Should your camcorder fail to operate correctly, refer to *Troubleshooting* (□ 93).

\* Availability differs from area to area.







### Conventions Used in this Manual

-  **IMPORTANT:** Precautions related to the camcorder's operation.
-  **NOTES:** Additional topics that complement the basic operating procedures.
-  **POINTS TO CHECK:** Restrictions or requirements regarding the function described.
- : Reference page number in this manual.

To complete some operations you will need to refer also to other instruction manuals. This will be indicated with the following icons and the name of the relevant chapter or section.

 Refer to the “Digital Video Software” instruction manual, included as a PDF file in the supplied **DIGITAL VIDEO Solution Disk** CD-ROM.

 Refer to the instruction manual of the optional DW-100 DVD Burner.

-  : Text that applies only to the model shown in the icon.
- The following terms are used in this manual:  
When not specified as “memory card” or “built-in memory”, the term “memory” by itself refers to both (  /  /  only).  
“Scene” refers to one movie unit from the point you press the  button to start recording until you press again to pause the recording.
- The photos included in this manual are simulated pictures taken with a still camera. Unless indicated otherwise, illustrations and menu icons refer to the  .

Names of buttons and switches other than the joystick are indicated within a “button” frame.

For example **[FUNC]**.

Brackets [ ] are used to refer to menu options as they are displayed on screen. In tables in this manual the default value is shown in boldface.

For example **[ON]**, **[OFF]**.

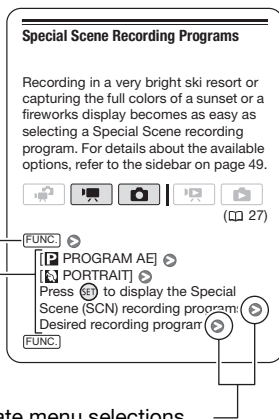

In this manual, the > arrow is used to abbreviate menu selections.

For a detailed explanation refer to *Using the Menus* ( 27).

#### **Online product registration for U.S.A. Customers only.**

Register your product online at [www.registercanon.com](http://www.registercanon.com)

##### ✓ **Protect your product**

We will keep the model number and date of purchase of your new Canon product on file to help you refer to this information in the event of an insurance claim such as loss or theft.

##### ✓ **Receive information on new products and promotions**



Upon your request, we will send you information on Canon new products and promotions.

The serial number of this product can be found on the battery compartment cover of the camcorder. Write down the number and other information here and retain this book as a permanent record of your purchase to aid identification in case of theft.

Date of Purchase:	Model Name: FS22 A/FS21 A/FS20 A/FS200 A
Purchased From:	Serial No.:
Dealer Address:	
Dealer Phone No.:	

## Supplied Accessories and CD-ROMs

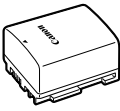
The following accessories are supplied with the camcorder.

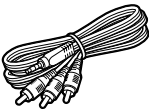
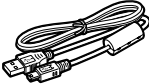
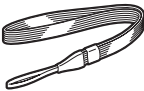
<p>CA-570 Compact Power Adapter</p> 	<p>BP-808 Battery Pack</p> 	<p><b>FS22</b> WL-D88 Wireless Controller</p> 	<p><b>FS22</b> Lithium Button Battery CR2025 for Wireless Controller</p> 
<p>STV-250N Stereo Video Cable</p>  <p>Yellow • Red • White plugs</p>	<p>IFC-400PCU USB Cable</p> 	<p>WS-30 Wrist Strap</p> 	

The following CD-ROMs and software are supplied with the camcorder.

- **PIXELA Application Disc Ver.1 Disc 1** CD-ROM\* and 'PIXELA ImageMixer 3 SE Ver.4 Installation Guide'
  - ImageMixer 3 SE Ver.4 Transfer Utility - For saving and transferring movies.
  - Music Transfer Utility Ver.1 - For transferring music for Video Snapshot and slideshow playback to the camcorder.
- **PIXELA Application Disc Ver.1 Disc 2** CD-ROM\*
  - ImageMixer 3 SE Ver.4 Video Tools - For managing, editing, and playing back movies.
- **DIGITAL VIDEO Solution Disk** CD-ROM\* and Installation Guide - Contains software for saving, managing, and printing photos.
- **Instruction Manual/Music Data Disc** CD-ROM - Contains the full-length camcorder instruction manual (electronic version on PDF file) as well as music files for playing back Video Snapshot scenes. This CD-ROM cannot be played back on a CD player. The music files on this CD-ROM are for exclusive use with the supplied PIXELA applications, Music Transfer Utility and ImageMixer 3 SE Video Tools. For more details, refer to the 'Music Transfer Utility Software Guide' and 'ImageMixer 3 SE Software Guide' on the **PIXELA Application Disc Ver.1 Disc 1** CD-ROM.

\* The CD-ROM includes the instruction manual of the software (electronic version on PDF file).

## Components Guide

### Left side view

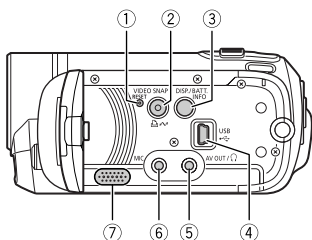

- ① RESET button ( 96)
- ② VIDEO SNAP (Video Snapshot) button ( 47)/ (print/share) button ( 70, 80)
- ③ DISP. (on-screen display) button ( 54, 67)/  
BATT. INFO button ( 18)
- ④ USB terminal ( 75)
- ⑤ AV OUT/ terminal ( 75)
- ⑥ MIC terminal (red) ( 55)
- ⑦ Speaker ( 38)
- ⑧ Strap mount ( 22)
- ⑨ ACCESS (memory access) indicator ( 34, 60)

### Right side view

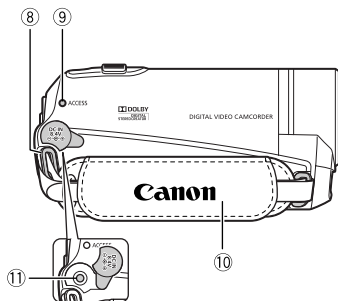

- ⑩ Grip belt
- ⑪ DC IN terminal ( 19)
- ⑫ Mini video light ( 47)
- ⑬ Stereo microphone

### Front view

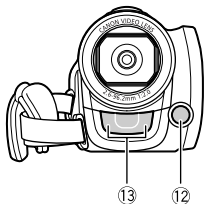

**Back view**

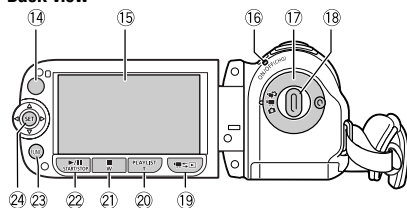

**Top view**

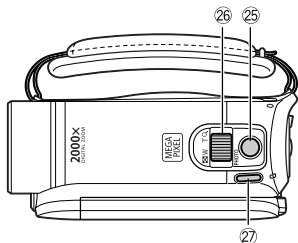

**Bottom view**

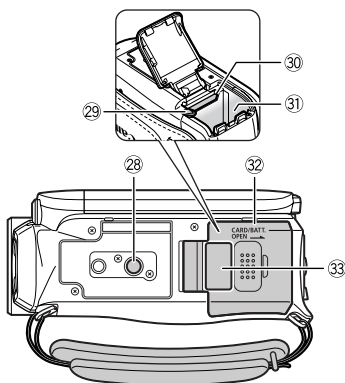

- 14 **FS22** Remote sensor (□ 22)
- 15 LCD screen (□ 23)
- 16 ON/OFF(CHG) (power/charge) indicator (□ 20)
- 17 Camera mode dial (□ 25)
- 18 Start/Stop button (□ 34)
- 19 (camera/play) button (□ 26)
- 20 PLAYLIST button (□ 56)/ Zoom in **T** (telephoto) button (□ 35)
- 21 (stop) button (□ 38)/ Zoom out **W** (wide-angle) button (□ 35)
- 22 (play/pause) button (□ 38)/ START/STOP button (□ 34)
- 23 FUNC. button (□ 27, 84)
- 24 Joystick (□ 26)
- 25 PHOTO button (□ 60)
- 26 Zoom lever (□ 35)
- 27 POWER button
- 28 Tripod socket (□ 105)
- 29 Battery release latch (□ 20)
- 30 Memory card slot (□ 31)
- 31 Battery compartment (□ 19)
- 32 Battery compartment cover/ Memory card slot cover
- 33 Serial number

The serial number label is located on the top surface of the battery compartment cover.

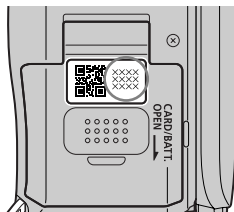

## ES22 Wireless Controller WL-D88

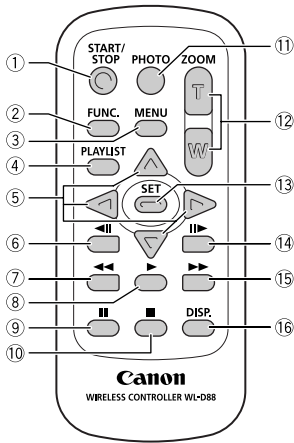

- ① START/STOP button (☐ 34)
- ② FUNC. button (☐ 27, 84)
- ③ MENU button (☐ 27, 86)
- ④ PLAYLIST button (☐ 56)
- ⑤ Navigation buttons ( ▲/▼/◀/▶ )
- ⑥ ◀|| (frame reverse) button (☐ 39)
- ⑦ ◀◀ (fast reverse) button (☐ 39)
- ⑧ ▶ (play) button (☐ 38)
- ⑨ || (pause) button (☐ 38)
- ⑩ ■ (stop) button (☐ 38)
- ⑪ PHOTO button (☐ 60)
- ⑫ Zoom buttons (☐ 35)
- ⑬ SET button
- ⑭ ||▶ (frame advance) button (☐ 39)
- ⑮ ▶▶ (fast forward) button (☐ 39)
- ⑯ DISP. (on-screen display) button (☐ 54, 67)

## Screen Displays

### Recording Movies

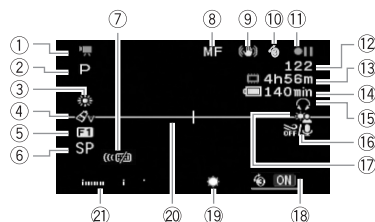

### Playing Movies (During Playback)



- ① Operating mode (□ 25)
- ② Recording program (□ 44, 45)
- ③ White balance (□ 51)
- ④ Image effects (□ 52)
- ⑤ Digital effects (□ 53)
- ⑥ Recording mode (□ 35)
- ⑦ **FS22** Remote sensor off (□ 90)
- ⑧ Manual focus (□ 51)
- ⑨ Image stabilizer (□ 86)
- ⑩ Pre-recording function (□ 49)
- ⑪ Memory operation (□ 18)
- ⑫ Number of scenes recorded (record pause)/Time code (hours : minutes : seconds, while recording)
- ⑬ Remaining recording time  
□ On the memory card  
**FS22** / **FS21** / **FS20** (□) In the built-in memory
- ⑭ Remaining battery time (□ 18)
- ⑮ Headphone output (□ 54)
- ⑯ Wind screen off (□ 86)
- ⑰ Backlight correction (□ 50)
- ⑱ Joystick guide (□ 26)
- ⑲ Mini video light (□ 47)
- ⑳ Level marker (□ 88)
- ㉑ Audio level indicator (□ 88)
- ㉒ Time code/Playback time (hours : minutes : seconds)
- ㉓ Scene number
- ㉔ Data code (□ 88)



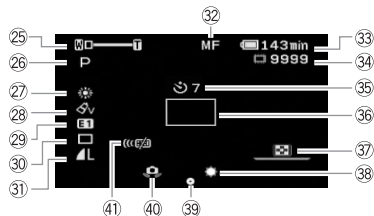

## Recording Photos

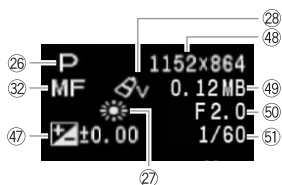
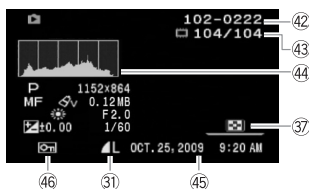

## Viewing Photos



- 25 Zoom (□ 35), Exposure  (□ 50)
- 26 Recording program (□ 44, 45)
- 27 White balance (□ 51)
- 28 Image effect (□ 52)
- 29 Digital effect (□ 53)
- 30 Drive mode (□ 66)
- 31 Photo quality/size (□ 60)
- 32 Manual focus (□ 51)
- 33 Remaining battery time (□ 18)
- 34 Number of photos available (□ 18)
  -  On the memory card
  - FS22** / **FS21** / **FS20**  In the built-in memory
- 35 Self timer (□ 49)
- 36 AF frame (□ 87)
- 37 Joystick guide (□ 26)
- 38 Mini video light (□ 47)
- 39 Focus and exposure lock (□ 60)
- 40 Camcorder shake warning (□ 87)
- 41 **FS22** Remote sensor off (□ 90)
- 42 Photo number (□ 18, 91)
- 43 Current photo / Total number of photos
- 44 Histogram (□ 67)
- 45 Date and time of recording
- 46 Photo protection mark (□ 67)
- 47 Manual exposure (□ 50)
- 48 Photo size (□ 60)
- 49 File size
- 50 Aperture value
- 51 Shutter speed (□ 45)

**11 Memory operation**

- Record, ● || Record pause,
- ▶ Playback, || Playback pause,
- ▶▶ Fast playback,
- ◀◀ Fast reverse playback,
- ▶ Slow playback,
- ◀ Slow reverse playback



**FS22** only:

- ▶ Frame advance,
- ◀ Frame reverse

**13 Remaining recording time**

When there is no more free space on the memory, [END] (built-in memory, **FS22** / **FS21** / **FS20** only) or [END] (memory card) will be displayed and the recording will stop.

**14, 33 Remaining battery time**

- The icon shows a rough estimate of the remaining charge as a percentage of the full charge of the battery pack. The remaining recording/playback time of the battery pack is displayed, in minutes, next to the icon.
- When  is displayed in red, replace the battery pack with a fully charged one.
- When you attach an empty battery pack, the power may turn off without displaying .
- The first time you use a battery pack, fully charge it and then use the camcorder until the battery pack is completely exhausted. Doing so will ensure that the remaining recording time will be displayed accurately.

- Depending on the conditions under which the camcorder and the battery pack are used, the actual battery charge may not be indicated accurately.
- When the camcorder is off, press **[BATT.INFO]** to display the charge status of a battery pack. The Intelligent System will display the charge status (as a percentage) and the remaining recording time (in minutes) for 5 seconds. If the battery pack is exhausted, the battery information may not be displayed.

**34 Number of photos available**

 in red: No card

 in green: 6 or more photos

 in yellow: 1 to 5 photos

 in red: No more photos can be recorded

- When viewing the photos, the display will always be in green.
- Depending on the recording conditions, the number of available photos displayed may not decrease even after a recording has been made, or may decrease by 2 photos at once.

**42 Photo number**

The photo number indicates the name and location of the file on the memory card. For example, the file name of photo 101-0107 is "IMG\_0107.JPG", stored under the folder "DCIM\101CANON".



# Preparations

This chapter describes basic operations, such as navigating the menus, and first time settings to help you learn more about your camcorder.

## Getting Started

### Charging the Battery Pack

The camcorder can be powered with a battery pack or directly using the compact power adapter. Charge the battery pack before use.

For approximate charging times and recording/playback times with a full battery pack, refer to the tables on pages 112-113.

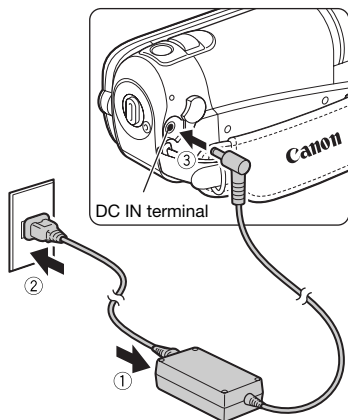

- 1 Connect the power cord to the compact power adapter.

- 2 Plug the power cord into a power outlet.
- 3 Connect the compact power adapter to the camcorder's DC IN terminal.

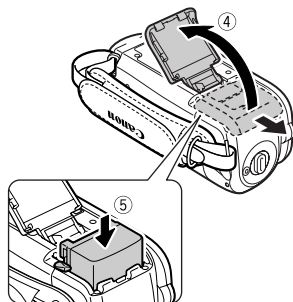

- 4 Slide the battery compartment cover away from the lens and open it.
- 5 Insert the battery pack all the way into the compartment and press gently until it clicks.
- 6 Close the cover and slide it toward the lens until you hear a click.

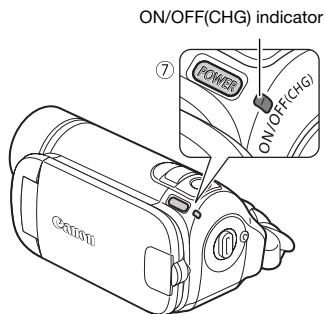

### 7 Charging will start when the camcorder is turned off.

- The ON/OFF(CHG) indicator starts flashing in red. The indicator will go out when the charging is completed.
- If the indicator flashes quickly, refer to *Troubleshooting* (□ 93).

### ONCE THE BATTERY PACK IS FULLY CHARGED

- 1 Disconnect the compact power adapter from the camcorder.
- 2 Unplug the power cord from the power outlet and the compact power adapter.

### TO REMOVE THE BATTERY PACK

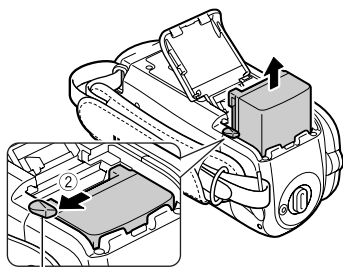

Battery release latch

- 1 Slide the battery compartment cover away from the lens and open it.
- 2 Press the battery release latch and pull out the battery pack.
- 3 Close the cover and slide it toward the lens until you hear a click.

### ! IMPORTANT

- Turn off the camcorder before connecting or disconnecting the compact power adapter. After turning off the camcorder, important data is updated in the memory. Be sure to wait until the ON/OFF(CHG) indicator turns off.
- We recommend charging the battery pack in temperatures between 10 °C and 30 °C (50 °F and 86 °F). Outside the temperature range of 0 °C to 40 °C (32 °F to 104 °F), the charging will not start.
- Do not connect to the camcorder's DC IN terminal or to the compact power adapter any electrical equipment that is not expressly recommended for use with this camcorder.



- To prevent equipment breakdowns and excessive heating, do not connect the supplied compact power adapter to voltage converters for overseas travels or special power sources such as those on aircraft and ships, DC-AC inverters, etc.

## **i** NOTES

- Turn off the camcorder before charging the battery pack. The battery pack will not charge while the camcorder is on.
- If remaining battery time is an issue, you can power the camcorder using the compact power adapter so the battery pack will not be consumed.
- Charged battery packs continue to discharge naturally. Therefore, charge them on the day of use, or the day before, to ensure a full charge.
- We recommend that you prepare battery packs to last 2 to 3 times longer than you think you might need.
- **USA and Canada only:** The Lithium ion/polymer battery that powers the product is recyclable. Please call 1-800-8-BATTERY for information on how to recycle this battery.



## Preparing the Wireless Controller (ES22) only) and Accessories

First, insert the supplied lithium button battery CR2025 into the wireless controller.

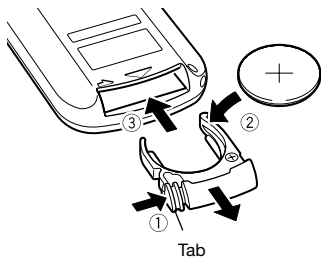

- 1** Press the tab in the direction of the arrow and pull out the battery holder.
- 2** Place the lithium button battery with the + side facing up.
- 3** Insert the battery holder.

## TO USE THE WIRELESS CONTROLLER

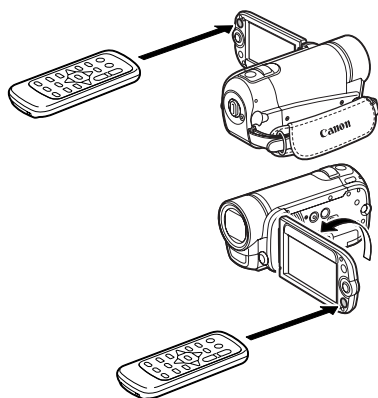

**Point the wireless controller at the camcorder's remote sensor when you press the buttons.**

You can rotate the LCD panel 180 degrees to use the wireless controller from the front of the camcorder.

### **i** NOTES

- The wireless controller may not work properly when the remote sensor is situated under strong light sources or direct sunlight.
- If the wireless controller does not work, check that [WL.REMOTE] is not set to [OFF OFF] (90). Otherwise, replace the battery.

## Accessories

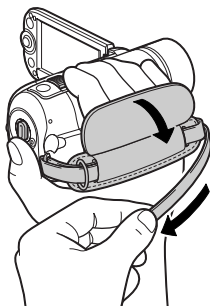

### Fasten the grip belt.

- Adjust the grip belt so that you can reach the zoom lever with your index finger, and the [Start/Stop] button with your thumb.
- You can remove the grip belt and replace it with the supplied wrist strap.

## TO REMOVE THE GRIP BELT

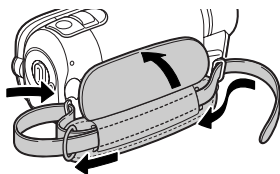

- 1 Lift the padded handgrip's flap and detach the strap from the Velcro pad.**
- 2 Pull the strap to remove it first from the front bracket on the camcorder, then to unthread it from the handgrip and finally to remove it from the rear bracket on the camcorder.**



### TO ATTACH A WRIST STRAP

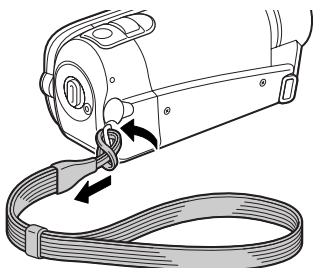

Pass the attaching end of the wrist strap through the back bracket on the camcorder, thread the wrist strap through the loop and fasten.

You can also attach the wrist strap to the strap mount on the grip belt to use both for extra convenience and protection.

### TO ATTACH A SHOULDER STRAP

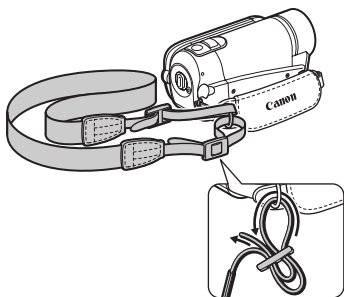

Pass the ends of the shoulder strap through the strap mount on the grip belt and adjust the length of the strap.

You can also remove the grip belt and attach the shoulder strap directly to the rear bracket on the camcorder.

### TO REATTACH THE GRIP BELT

- 1 Pass the end of the strap through the rear bracket on the camcorder.
- 2 Thread the strap through the padded handgrip and then pass it through the front bracket on the camcorder.
- 3 Fasten the grip belt as necessary, attach the strap to the Velcro pad on the handgrip and close the flap.

---

## Adjusting the Position and Brightness of the LCD Screen

### Rotating the LCD Panel

**Open the LCD panel 90 degrees.**

- You can rotate the panel 90 degrees downward.
- You can rotate the panel 180 degrees toward the lens. Rotating the LCD panel 180 degrees can be useful in the following cases:
  - When you wish to include yourself in the picture when recording with the self timer.

- **FS22** To allow the camcorder to be operated with the wireless controller from the front.

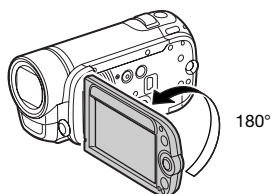
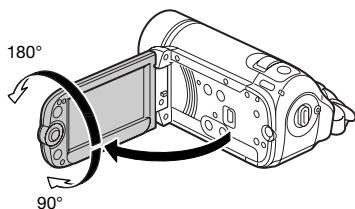

Subject can monitor the LCD screen

**i** NOTES

**About the LCD screen:** The screen is produced using extremely high-precision manufacturing techniques, with more than 99.99% of the pixels operating to specification. Less than 0.01% of the pixels may occasionally misfire or appear as black, red, blue or green dots. This has no effect on the recorded image and does not constitute a malfunction.

**LCD Backlight**

You can set the brightness of the screen to dim, normal or bright. To set the screen to dim, turn on [LCD DIMMER] (☐ 88). To toggle between normal and bright or to turn off [LCD DIMMER], perform the following procedure.

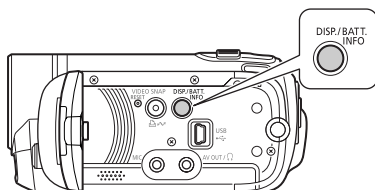

**While the camcorder is on, hold** **[DISP.]** **pressed down for more than 2 seconds.**

Repeat the operation to switch between normal and bright.

**i** NOTES



- This setting does not affect the brightness of the recording.
- Using the bright setting will shorten the effective usage time of the battery pack.
- When the compact power adapter is connected while the brightness of the screen is normal, the brightness will automatically change to bright.





## Basic Operation of the Camcorder

### Operating Modes







The camcorder's operating mode is determined by the  button and the position of the camera mode dial. In this manual,  indicates that a function is available in the operating mode shown and  indicates that the function is not available. See the following table for a summary of the operating modes.

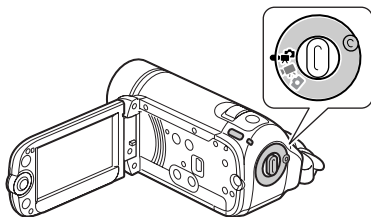

#### Recording: Dual Shot and Flexible Recording

















The camcorder offers two basic modes for recording video or photos: **Dual Shot** ( mode) for beginners or if you just prefer not to bother with detailed camcorder settings, and **flexible recording mode**, which lets

you change the camcorder's settings to your preference.



Turn the camera mode dial to  to set the camcorder to  mode. You do not need to worry about any settings and can shoot video using just **Start/Stop** ( 34) or take photos using just **PHOTO** ( 60). You can also use the zoom lever, Quick Start ( 37) and Video Snapshot ( 47).

To set the camcorder to flexible recording mode, turn the camera mode dial to  for movies or  for photos.

Operating mode	Icon display	Operation	
	 AUTO	Recording movies or photos to the memory (Dual Shot)	25
	 (green)	Recording movies to the memory	34
	 (blue)	Recording photos to the memory	60
	 (green)	Playing movies from the memory (press  while the camera mode dial is set to  or  )	38
	 (blue)	Viewing photos from the memory (press  while the camera mode dial is set to  )	62

\* **FS22** / **FS21** / **FS20** only.

You can access the menus and change settings to your preference. Even in flexible recording mode, the camcorder can help you with the settings. For example, you can use the Special Scene recording programs (□ 44) to set at once all the optimal settings to match special recording conditions.

## Playback

Press to switch between the recording mode indicated by the camera mode dial and playback mode (**FS22** / **FS21** / **FS20**) the selected media will remain the same). When the camera mode dial is set to or , pressing switches the camcorder to movie playback mode. When the camera mode dial is set to , pressing switches the camcorder to photo playback mode. Even if the camcorder is turned off, pressing will start the camcorder in the corresponding playback mode.

## NOTES

In mode you cannot access the menus or joystick guide but you can change the following settings in advance, before setting the camcorder to mode.

- Recording mode of movies
- Size/quality of photos
- Widescreen
- Auto slow shutter
- All settings in the [ SYSTEM SETUP] menu
- LCD screen dimmer
- Demo mode
- Image stabilizer

## Joystick and Joystick Guide

Use the joystick to operate the camcorder's menus.

Push the joystick up, down, left or right (, , , ) to select an item or change settings.

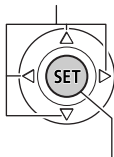

Press the joystick itself () to save the settings or confirm an action. On menu screens, this is indicated by the icon ().

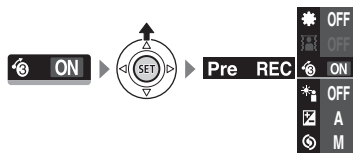

The functions that appear in the joystick guide depend on the operating mode. By default, the joystick guide is minimized. Push the joystick () to display it.

During or mode, select (, ) a function and press () to change the setting. With some functions, you will need to make further adjustments (indicated by small arrows).

During playback mode, select (, ) a “row” of functions and press () to operate the function in the middle or push the joystick (, ) to operate the function on the left or right side of the row, respectively.



In either mode, if you wait a few seconds, the joystick guide will minimize again but the selected function can still be operated. You can also push the joystick (▼) to hide the joystick guide.

---

## Using the Menu

Many of the camcorder's functions can be adjusted from the menus that open after pressing the FUNC. button (FUNC.). To access the menus, set the camcorder to flexible recording mode. In [ ] mode, except for a few exceptions, most menu settings will return to their default values. For details about the available menu options and settings, refer to the appendix *Menu Options Lists* (□ 84).

### Selecting a FUNC. Menu Option in Recording Mode

---

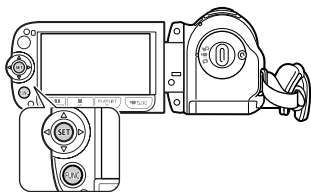

- 1 Press [FUNC.].
- 2 Select (▲▼) the icon of the function you want to change from the left side column.  
Menu items not available will appear grayed out.
- 3 Select (◀▶) the desired setting from the available options at the bottom bar.

- The selected option will be highlighted in orange.
- With some settings you will need to make further selections and/or press (SET). Follow the additional operation guides that will appear on the screen (such as the [SET] icon, small arrows, etc.).

- 4 Press [FUNC.] to save the settings and close the menu.



You can press [FUNC.] to close the menu at any time.

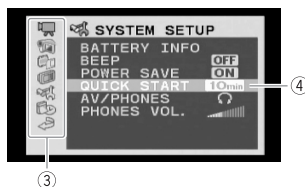
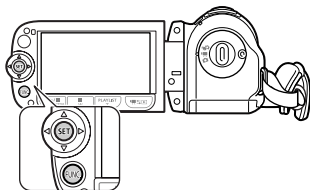

### Selecting an Option from the Setup Menus

---



- 1 Press [FUNC.].

- 2 Select (▲▼, ◀▶) the  icon and press  to open the setup menu.**

You can also press  on the wireless controller ( only) or hold  pressed down for more than 1 second or to open directly the setup menu screen.

- 3 Select (▲▼) the desired menu from the left side column and press .**

The title of the selected menu appears on top of the screen and under it the list of settings.

- 4 Select (▲▼) the setting you want to change and press .**

- The orange selection bar indicates the menu setting currently selected. Items not available appear in black.
- Push the joystick (◀) to return to the menu selection screen (step 3).

- 5 Select (▲▼) the desired option and press .**

- 6 Press .**

You can press  to close the menu at any time.

## First Time Settings

### Setting the Date and Time

You will need to set the date and time of the camcorder before you can start using it. The [DATE/TIME] screen will appear automatically when the camcorder's clock is not set.



When the [DATE/TIME] screen appears, the year will be displayed in orange and indicated with up/down arrows.

- 1 Change (▲▼) the year and move (▶) to the month.**
- 2 Change the rest of the fields (month, day, hour and minutes) in the same way.**
- 3 Select (▶) [OK] and press  to start the clock and close the setup screen.**

### IMPORTANT

- When you do not use the camcorder for about 3 months, the built-in rechargeable lithium battery may discharge completely and the date and time setting may be lost. In such case, recharge the built-in lithium battery ( 107) and set the time zone, date and time again.



- The date appears in a year-month-day format only in the first setup screen. In subsequent screen displays the date and time will appear as month-day-year (for example, [JAN. 1, 2009 12:00 AM]). You can change the date format (📅 92).
- You can also change the date and time later on (not during the initial setup). To open the [DATE/TIME] screen:

[FUNC.] ➤ [☰ MENU] ➤  
[📅 DATE/TIME SETUP] ➤  
[DATE/TIME]

## Changing the Language



### Options

◆ Default value

[ČEŠTINA]	[MELAYU]	[العربية]
[DEUTSCH]	[NEDERLANDS]	[فارسی]
[ΕΛΛΗΝΙΚΑ]	[POLSKI]	[ภาษาไทย]
<b>[ENGLISH]◆</b>	[PORTUGUÊS]	[简体中文]
[ESPAÑOL]	[ROMÂNĂ]	[繁體中文]
[FRANÇAIS]	[TÜRKÇE]	[한국어]
[ITALIANO]	[РУССКИЙ]	[日本語]
[MAGYAR]	[УКРАЇНСЬКА]	

[FUNC.] ➤  
[☰ MENU] ➤  
[📅 DISPLAY SETUP] ➤  
[LANGUAGE 🗣️] ➤  
Desired language ➤  
[FUNC.]

## NOTES

- If you changed the language by mistake, select the menu item with the 🗣️ mark and change the setting.
- The displays **SET** and **FUNC** that appear in some menu screens refer to the name of buttons on the camcorder and will not change, regardless of the language selected.

## Changing the Time Zone

Change the time zone to match your location. The default setting is New York.



### TO SET THE HOME TIME ZONE

[FUNC.] ➤  
[☰ MENU] ➤  
[📅 DATE/TIME SETUP] ➤  
[T.ZONE/DST] ➤ 🏠 ➤  
Your local time zone\* ➤

[FUNC.]

### WHEN YOU TRAVEL

[FUNC.] ➤  
[☰ MENU] ➤  
[📅 DATE/TIME SETUP] ➤  
[T.ZONE/DST] ➤ ✈️ ➤  
Local time at your destination\* ➤



**FUNC.**

\* To adjust for daylight saving time, select the area name marked with a ☀.



## Using a Memory Card

### Memory Cards Compatible for Use with the Camcorder

You can use commercially available  SDHC (SD high capacity) memory cards and  SD memory cards with this camcorder to record movies and photos. However, depending on the memory card, you may not be able to record movies on it. Refer to the following table.

As of December 2008, the movie recording function has been tested using SD/SDHC memory cards made by Panasonic, SanDisk and Toshiba.

#### NOTES

**About the SD Speed Class:** The SD Speed Class is a standard that indicates the minimum guaranteed data transfer speed of SD/SDHC memory cards. When you buy a new memory card, look for the Speed Class logo on the package.

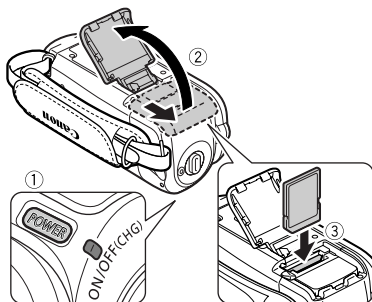

### Inserting and Removing a Memory Card

Make sure to initialize all memory cards before using them with this camcorder ( 32).



- 1 Turn off the camcorder.**  
Make sure that the ON/OFF(CHG) (power/charge) indicator is off.
- 2 Slide the memory card slot cover away from the lens and open it.**
- 3 Insert the memory card straight, with the label facing away from the lens, all the way into the memory card slot until it clicks.**
- 4 Close the cover and slide it toward the lens until you hear a click.**

#### Memory cards usable for recording movies

Memory card	Capacity	SD Speed Class	Recording movies
 SD memory cards	64 MB or less	—	—
	128 MB to 2 GB	—	●*
	512 MB to 2 GB	CLASS② or higher	●
 SDHC memory cards	4 GB to 32 GB	CLASS② or higher	●

\* Depending on the memory card, it may not be possible to record movies.

Do not force the cover closed if the memory card is not correctly inserted.

### ! IMPORTANT

Memory cards have front and back sides that are not interchangeable. Inserting a memory card facing the wrong direction can cause a malfunction of the camcorder.

### i NOTES

**To remove the memory card:** Push the memory card once to release it. When the memory card springs out, pull it all the way out.

## FS22 / FS21 / FS20 Selecting the Memory for the Recordings

You can select to record your movies and photos in the built-in memory or on the memory card. The built-in memory is the default media for recording both.



FUNC. >

- [MENU] >
- [MEMORY OPER.] >
- [MEDIA:MOVIES] or
- [MEDIA:PHOTOS] >
- The memory you want to use\* >
- Press [SET] >

FUNC.

\* For each media, you can check the total, used, and approximate available space. The approximate available space will

depend on the recording mode (for movies) or size/quality (for photos) currently in use.

## Initializing the Built-In Memory (FS22 / FS21 / FS20 only) or Memory Card

Initialize memory cards when you use them with this camcorder for the first time. You can also initialize a memory card or the built-in memory (FS22 / FS21 / FS20 only) to permanently delete all the data it contains.

**FS22 / FS21 / FS20** At the time of purchase, the built-in memory comes pre-initialized and contains music files for Video Snapshot and slideshow playback.



### Options

[INITIALIZE]
Clears the file allocation table but does not physically erase the stored data.
[COMPL.INIT.]
Erases all data completely.

### FS22 / FS21 / FS20

FUNC. >

- [MENU] >
- [MEMORY OPER.] >
- [INITIALIZE] > The memory you want to initialize >
- Initialization method >
- [YES]\* > [OK] >

FUNC.





## FS200

FUNC. 

 MENU 

 MEMORY OPER.] 

[INITIALIZE] 

Initialization method 

[YES]\*  [OK] 

FUNC.

- \* Press  to cancel the complete initialization while it is in progress. All recordings will be erased but the recording media can be used without any problem.

## IMPORTANT

---

- Initializing the memory will permanently erase all data. Lost original recordings cannot be recovered. Make sure you back up important recordings in advance using an external device ( 77).
- Music files for Video Snapshot will also be erased. Use the supplied software **Music Transfer Utility** to transfer the music files on the supplied **Instruction Manual/Music Data Disc** CD-ROM. For details, refer to the software's instruction manual (PDF file).
- While the initialization is in progress, do not disconnect the power source or turn off the camcorder.



# Video

This chapter covers functions related to shooting movies, including recording, playback, and memory operations.

## Basic Recording

### Shooting Video

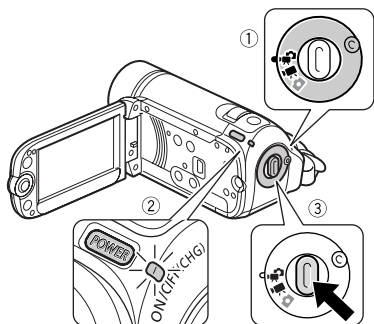

**1 Set the camera mode dial to or .**

**2 Turn on the camcorder.**

**FS22 / FS21 / FS20** You can select the memory to be used for recording movies (□ 32).

**3 Press **Start/Stop** to begin recording.**

- Recording starts; press **Start/Stop** again to pause the recording.

- You can also press **START/STOP** on the LCD panel.

### WHEN YOU HAVE FINISHED RECORDING

- 1 Make sure that the ACCESS indicator is off.**
- 2 Turn off the camcorder.**
- 3 Close the LCD panel.**

### ! IMPORTANT

Observe the following precautions while the ACCESS indicator is on or flashing. Failing to do so may result in permanent data loss or damage to the memory.

- Do not open the memory card slot cover.
- Do not disconnect the power source or turn off the camcorder.
- Do not change the operating mode.

### i NOTES

- **About the Power Save mode:** To save power when the camcorder is powered by a battery pack, the camcorder will automatically shut off if left without any operations for 5 minutes (□ 90). Press **POWER** to turn on the camcorder.
- When recording in bright places it may be difficult to use the LCD screen. Conversely, when recording in dark places, the LCD panel may be a nuisance to others nearby. In such cases, change the brightness of the LCD screen accordingly (□ 23, 89).



## Selecting the Video Quality (Recording Mode)

The camcorder offers 3 recording modes. Changing the recording mode will change the recording time available on the memory. Select XP mode for better movie quality; select LP mode for longer recording times. The following table gives approximate recording times.



( 25)

FUNC.

[ **SP** STANDARD PLAY 6Mbps ]

Desired recording mode

FUNC.

## NOTES

- The camcorder uses a variable bit rate (VBR) to encode video so the actual recording times will vary depending on the content of the scenes.
- The camcorder retains the last setting used even if you set the camcorder to mode.

## Zooming: Optical, Advanced and Digital Zoom

The camcorder offers three types of zoom: optical, advanced and digital zoom. In mode, all three types are available. In mode, only the advanced zoom is available; in mode, only the optical zoom is available.

### Approximate recording times for movies

◆ Default value

Recording mode →	XP	SP◆	LP
Memory ↓			
1 GB memory card	10 min.	20 min.	35 min.
2 GB memory card	25 min.	40 min.	1 hr. 15 min.
4 GB memory card	55 min.	1 hr. 20 min.	2 hr. 35 min.
<b>FS20</b> Built-in memory/ 8 GB memory card	1 hr. 50 min.	2 hr. 45 min.	5 hr. 10 min.
<b>FS21</b> Built-in memory/ 16 GB memory card	3 hr. 40 min.	5 hr. 30 min.	10 hr. 20 min.
<b>FS22</b> Built-in memory/ 32 GB memory card	7 hr. 20 min.	11 hr. 5 min.	20 hr. 50 min.

- When a recording exceeds 4 GB, it will be divided and saved as scenes smaller than 4 GB.
- **FS22** / **FS21** / **FS20** The camcorder comes pre-installed with about 170 MB of music files.

## Selecting the Zoom Type



### Options

◆ Default value

<b>[ 87x OPTICAL ] (37x)</b>
The zoom range is limited to the optical magnification ratio of the lens.
<b>[ 48x ADVANCED ]* (Advanced Zoom)</b>
In addition to the optical zoom range, the camcorder processes the image digitally to obtain a larger zoom range without any deterioration in image quality. When recording movies with a 16:9 aspect ratio, the field of view (picture angle) will change. Refer to the table in the NOTES section. <b>FS200</b> The default setting is [ 41x ADVANCED ].
<b>[ 2000x DIGITAL ] (2000x)</b>
When this option is selected, the camcorder will switch to digital zoom (light blue area on the zoom indicator) when you zoom in beyond the optical zoom range (white area on the zoom indicator). With the digital zoom, the image is processed digitally so image quality will deteriorate the more you zoom in.

- FUNC.**
- [ MENU ]
- [ CAMERA SETUP ]
- [ ZOOM TYPE ] Desired option
- FUNC.**

### NOTES

- The zoom range of the advanced zoom will change depending on the aspect ratio of the scene ( 86).

**[WIDESCREEN] set to [ ON ON ] (16:9)**

**FS22 / FS21 / FS20** 48x\*,  
**FS200** 41x\*\*

\* The picture angle will be wider at both full telephoto and full wide-angle.

\*\* The picture angle will be wider at full wide-angle.

**[WIDESCREEN] set to [ OFF OFF ] (4:3)**

**FS22 / FS21 / FS20** 55x ,  
**FS200** Not available

## Using the Zoom

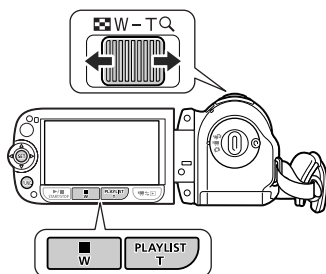

**Move the zoom lever toward W to zoom out (wide-angle). Move it toward T to zoom in (telephoto).**

Press gently for a slow zoom; press harder for faster zooms. You can also set [ZOOM SPEED] ( 86) to one of three constant speeds (3 is the fastest, 1 the slowest).



## **i** NOTES

- Keep at least 1 m (3.3 ft.) away from the subject. At full wide angle, you can focus on a subject as close as 1 cm (0.39 in.).
- When [ZOOM SPEED] is set to [VAR VARIABLE]:
  - The zoom speed will be faster in record pause mode than when actually recording.
  - When you use the **T** and **W** buttons on the wireless controller (**FS22** only) or LCD panel, the zoom speed will be constant at [SPEED 3].

---

## Quick Start Function

When you close the LCD panel with the camcorder on, the camcorder enters the standby mode. In standby mode the camcorder consumes only about half the power used when recording, saving energy when you are using a battery pack. Additionally, when you open the LCD panel or change the position of the mode dial, the camcorder is ready to start recording in approximately 1 second\*, allowing you to record the subject right away.

\* The actual time required varies depending on the shooting conditions.



(□ 25)

## **1** With the camcorder on and in a recording mode, close the LCD panel.

A beep will sound and the ON/OFF(CHG) (power/charge) indicator

will change to orange to indicate the camcorder entered the standby mode.

## **2** When you wish to resume recording, open the LCD panel.

The ON/OFF(CHG) indicator will return to green and the camcorder will be ready to record.

## **!** IMPORTANT

Do not disconnect the power source during standby mode (while the ON/OFF(CHG) indicator is lit in orange).

## **i** NOTES

- If you close the LCD panel under some circumstances (for example while recording, while a menu is being displayed, while the battery charge is low, or while the memory card slot cover is open), the camcorder may not enter the standby mode. Check that the ON/OFF(CHG) indicator changes to orange.
- The camcorder will shut off if left in standby mode for 10 minutes, regardless of the [POWER SAVE] setting (□ 90). Press **POWER** to turn on the camcorder.
- You can select the length of time until shut-off or turn off the Quick Start function with the [QUICK START] setting (□ 91).

## Basic Playback

### Playing Back the Video

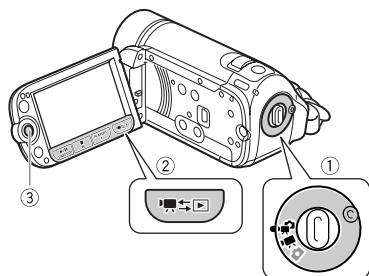

**1** Set the camera mode dial to or .

**2** Press .

- Even if the camcorder is off, pressing will turn on the camcorder in playback mode.
- The original movies index screen appears after a few seconds.

**3** Move (, ) the selection frame to the scene you want to play back.

Push the joystick () to extend the selection frame and browse () through whole index pages. Push the joystick () to return to the index screen.

**4** Press or to begin the playback.

- Playback will start from the scene selected and continue until the end of the last scene recorded.
- Press again to pause the playback.
- Press to stop the playback and return to the index screen.

### ADJUSTING THE VOLUME



**1** Push the joystick () to display the joystick guide.

**2** Push the joystick () to select the top row.

**3** Adjust () the volume.

To turn off the volume, keep the joystick pressed () toward until the volume bars disappear.

### ! IMPORTANT

- Observe the following precautions while the ACCESS indicator is on or flashing. Failing to do so may result in permanent data loss.
  - Do not open the memory card slot cover.
  - Do not disconnect the power source or turn off the camcorder.
  - Do not change the operating mode.
- You may not be able to play back with another device the movies you recorded on the memory card with this camcorder. In such case, play back the





movies on the memory card using this camcorder.

- You may not be able to play back with this camcorder movies recorded using another device.

## NOTES









Depending on the recording conditions, you may notice brief stops in video or sound playback between scenes.



## Special playback modes

To enter the special playback modes, use the wireless controller (**FS22** only;  15) and joystick guide ( 26). There is no sound during the special playback modes.

### Fast playback









From normal playback, play back scenes at a faster speed than normal. Every time the operation is performed, the playback speed is increased 5x→15x→60x.



Display the joystick guide  select ( ) the middle row  Push the joystick ( ) toward  or .

**FS22** Alternatively, press  or  on the wireless controller.



### Slow playback

From playback pause mode, play back scenes at a slower speed than normal. Slow playback is 1/8 the normal speed; slow reverse playback is 1/12 the normal speed.

Display the joystick guide  Select ( ) the middle row  Push the joystick ( ) toward  or .







**FS22** Alternatively, press  or  on the wireless controller.

### Frame Advance/Reverse (**FS22** only)

In playback pause mode, press  or  on the wireless controller to reverse a few frames (approx. 0.5 seconds) or to advance one frame. Hold the button pressed for continuous playback.







### Skipping scenes

To skip to the next scene:

Display the joystick guide  Select ( ) the bottom row  Push the joystick () toward .

**FS22** Alternatively, press  on the wireless controller.



To return to the beginning of the current scene or skip to the previous scene:

Display the joystick guide  Select ( ) the bottom row  Push the joystick () toward .

**FS22** Alternatively, press \* on the wireless controller.

\* Repeat to skip to the beginning of the previous scene.

### Ending special playback modes

During any special playback mode, press  on the camcorder or  on the wireless controller (**FS22** only) to return the camcorder to its initial playback mode.

## NOTES

- During some special playback modes, you may notice some anomalies (blocky video artifacts, banding, etc.) in the playback picture.
- The speed indicated on the screen is approximate.

## Selecting What Recordings to Play Back

From the index screen, you can select whether to play back movies or photos. You can also use the tabs on the top of the screen to select the media from which to play back recordings (**FS22** / **FS21** / **FS20** only).







- 1 In the index screen, move (**▲▼**) the orange selection frame to the tabs on the top of the screen.

**FS22** / **FS21** / **FS20**



**FS200**



-  Movies
-  Photos
-  Recordings in the built-in memory
-  Recordings on the memory card

- 2 Select (**◀▶**) the media (**FS22** / **FS21** / **FS20** only) and the recording type (scenes or photos).

- 3 Return (**▲▼**) to the index screen to select the scene or photo.

## Selecting Scenes by Recording Date



You can search for all the recordings you made on a particular date (for example, to find all the movies you shot during a special event).



### POINTS TO CHECK

Selecting scenes by recording date is available only from the original movies index screen.

## Selecting from the List of Recordings

- 1 Open the original movies index screen.
  - From this index screen, you can also press **[VIDEO SNAP]** to open the index screen for Video Snapshot ( 47) scenes.
  - **FS22** / **FS21** / **FS20** You can select the scenes in the built-in memory or on the memory card ( 40).
- 2 Open the list of recordings.
  - [FUNC.]**  **[SCENE SEARCH]**  **[SELECT DATE]**
  - The list of recordings displays all dates in which recordings were made. An orange selection frame appears on the day.
  - The thumbnail shows a photo from the first scene recorded on that





day. Below it will appear the number of scenes recorded and the total recording time for the same day.

### 3 Change (▲▼) the day and move (◀▶) to the month or year.

### 4 Change the other fields in the same way to select the desired date and press (SET).

The index screen will appear with the selection frame on the first scene recorded on the selected date.

number of scenes recorded and the total recording time for the same day.

- You can select (▲▼) the year or month field and change (◀▶) the year or month to move faster between calendar months.

### 4 Press (SET) to return to the index screen.

The orange selection frame will appear on the first scene recorded on the selected date.

## Selecting from the Calendar Screen

### 1 Open the original movies index screen.

- From this index screen, you can also press (VIDEO SNAP) to open the index screen for Video Snapshot (□ 47) scenes.
- (FS22) / (FS21) / (FS20) You can select the scenes in the built-in memory or on the memory card (□ 40).

### 2 Open the calendar screen.

(FUNC.) > ([SCENE SEARCH]) > [CALENDAR]

- The calendar screen appears.
- Dates that contain scenes (that is, movies were recorded on that date) appear in white. Dates without recordings appear in black.

### 3 Move (▲▼, ▶) the cursor to the desired date.

- When you move the cursor to a date displayed in white, a thumbnail showing a photo from the first scene recorded on that date will be displayed next to the calendar. Below it will appear the

## (i) NOTES

- You can change on what day to start the week for the calendar display (□ 89).
- You can press (FUNC.) to return to the index screen at any time.

## Selecting the Playback Starting Point from the Movie Timeline

You can display a timeline of the scene and select where to begin the playback. This is very convenient when you want to play back a long scene from a specific point.

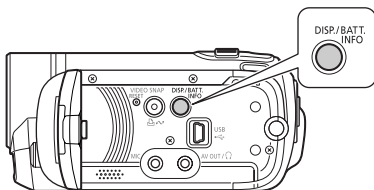

## 1 In the index screen select the scene you want to view and press

**[DISP.]**.

- The timeline screen appears. The large thumbnail will show the first frame of the scene. Below it, the timeline ruler shows frames taken from the scene at fixed intervals.
- Press **[DISP.]** again to return to the index screen.

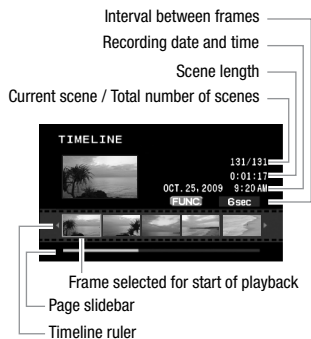

## 2 Select (**◀▶**) the playback starting point from the timeline ruler.

## 3 Press **(SET)** to begin the playback.

### TO SELECT ANOTHER SCENE

Move (**▲▼**) the orange selection frame to the large thumbnail and change (**◀▶**) the scene.

### TO MOVE BETWEEN TIMELINE RULER PAGES

Move (**▲▼**) the orange selection frame to the sidebar below the ruler and display (**◀▶**) the previous/next 5 frames in the scene.

### TO CHANGE THE INTERVAL BETWEEN FRAMES

**[FUNC.]** **▶** Desired interval **▶** **[FUNC.]**

## Pre-selecting Recordings from the Index Screen

You can select in advance a number of movies or photos from the index screen in order to perform certain actions on them collectively, all at once.

**[M] mode**: Delete (□ 43), copy (**FS22** / **FS21** / **FS20** only; □ 58) or add the selected scenes to the playlist (□ 56).

**[V] mode**: Delete (□ 65), copy (**FS22** / **FS21** / **FS20** only; □ 68) or protect (□ 67) the selected photos or mark all of them with print orders (□ 72) or transfer orders (□ 83).



## 1 Select the movies or the photo index screen.

- From this index screen, you can also press **[VIDEO SNAP]** to open the index screen for Video Snapshot (□ 47) scenes.
- **FS22** / **FS21** / **FS20** You can select the scenes in the built-in memory or on the memory card (□ 40).

## 2 Open the selection screen.

**[FUNC.]** **▶** **[SELECT]** **▶**  
**[INDIVIDUAL SCENES]** or  
**[INDIVIDUAL PHOTOS]**

- The selection screen appears.



### 3 Move ( $\blacktriangle$ , $\blacktriangleleft$ ) between the scenes or photos in the index screen and press $\text{SET}$ to select an individual scene/photo.

- A checkmark  $\checkmark$  will appear on the selected scenes/photos.
- Repeat this step to add all the scenes/photos you want to include in your selection (up to 100).

Total number of scenes selected

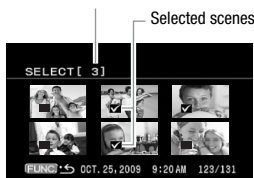

### 4 Press $\text{FUNC.}$ twice to close the menu.

#### TO CANCEL ALL THE SELECTIONS

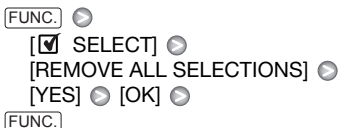

#### **i** NOTES

- The selection of scenes/photos will be canceled if you turn off the camcorder or change the operating mode.
- Scenes in the playlist cannot be included in the selection.

## Deleting Scenes

You can delete original scenes that you are not interested in keeping. Deleting scenes also allows you to free up space on the memory. To delete scenes in the playlist, refer to *Deleting Scenes from the Playlist* (□ 57).



### Options

[ALL SCENES]
Deletes all the scenes.
[ALL SCENES (THIS DATE)]
Deletes all the scenes recorded on the same day as the selected scene.
[ONE SCENE]
Deletes only the selected scene.
[SELECTED SCENES]
Deletes all the scenes selected in advance (marked with a $\checkmark$ checkmark). Refer to <i>Pre-selecting Recordings from the Index Screen</i> (□ 42).

### 1 Select ( $\blacktriangle$ , $\blacktriangleleft$ ) the scene you want to delete, or a scene recorded on the date you want to delete.

This step is not necessary to delete all scenes or previously selected scenes.

### 2 Delete the scene(s).



\* If you selected any option other than [ONE SCENE], you can press  $\text{SET}$  to interrupt the

operation while it is in progress. Some scenes will be deleted nevertheless.

### ! IMPORTANT

- Be careful when deleting original recordings. Once deleted, an original scene cannot be recovered.
- Back up important scenes before deleting them (□ 77).
- Observe the following precautions while the ACCESS indicator is on or flashing (while scenes are being deleted).
  - Do not open the memory card slot cover.
  - Do not disconnect the power source or turn off the camcorder.
  - Do not change the operating mode.

### i NOTES

- Deleting a scene from the original movies index screen also deletes that scene from the playlist.
- To delete all movies and make all recordable space available again you may prefer to initialize the memory (□ 32).
- You may not be able to delete scenes recorded or edited using another device.

## Advanced Functions

### Special Scene Recording Programs

Recording in a very bright ski resort or capturing the full colors of a sunset or a fireworks display becomes as easy as selecting a Special Scene recording program. For details about the available options, refer to the sidebar on page 45.



- FUNC.** >
- [P PROGRAM AE] >
  - [PORTRAIT] >
  - Press **SET** to display the Special Scene (SCN) recording programs >
  - Desired recording program >

**FUNC.**

### i NOTES

- [NIGHT]
  - Moving subjects may leave a trailing afterimage.
  - Picture quality may not be as good as in other modes.
  - White points may appear on the screen.
  - Autofocus may not work as well as in other modes. In such case, adjust the focus manually.
- [FIREWORKS]
  - To avoid camcorder shake, we recommend using a tripod. Make sure to use a tripod especially in  mode, as the shutter speed slows down.

### [] **PORTRAIT**

The camcorder uses a large aperture, achieving a focus on the subject while blurring other distracting details.



### [] **BEACH**

Use this mode to record on a sunny beach. It prevents the subject from being underexposed.



### [] **SPORTS**

Use this mode to record sports scenes such as tennis or golf.



### [] **SUNSET**

Use this mode to record sunsets in vibrant colors.

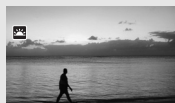

### [] **NIGHT**

Use this mode to record in dimly lit places.



### [] **SPOTLIGHT**

Use this mode to record spotlight scenes.



### [] **SNOW**

Use this mode to record in bright ski resorts. It prevents the subject from being underexposed.



### [] **FIREWORKS**

Use this mode to record fireworks.



- [] **PORTRAIT** / [] **SPORTS** / [] **BEACH** / [] **SNOW**
  - The picture may not appear smooth during playback.
- [] **PORTRAIT**
  - The blur effect of the background increases the more you zoom in (**T**).
- [] **SNOW** / [] **BEACH**
  - The subject may become overexposed on cloudy days or in shaded places. Check the image on the screen.

---

## Controlling Shutter Speed and Other Functions while Shooting

Use the automatic exposure (AE) program to use functions like the white

balance or image effects, or give priority to the shutter speed.

Use faster shutter speeds to record subjects moving quickly; use slower shutter speeds to add motion blur, emphasizing the feel of movement.



## Options

♦ Default value

<b>[P] PROGRAM AE</b> ♦
The camcorder automatically adjusts the aperture and shutter speed to obtain the optimal exposure for the subject.
<b>[TV] SHUTTER-PRIO.AE</b>
Set the shutter speed value. The camcorder automatically sets the appropriate aperture value.

[FUNC.] ➤

[P] PROGRAM AE ➤ Desired recording program\* ➤

[FUNC.]

\* When you select [TV] SHUTTER-PRIO.AE], do not press [FUNC.] and continue instead with the following procedure.

## TO SET THE SHUTTER SPEED

1 Adjust (◀▶) the shutter speed to the desired value and then press

(SET).

2 Press [FUNC.].

### Shutter speed guidelines

Note that on screen only the denominator is displayed – [TV] 250] indicates a shutter speed of 1/250 second, etc.

1/2*, 1/4*, 1/8, 1/15, 1/30
To record in dimly lit places.
1/60
To record under most ordinary conditions.
1/100
To record indoor sports scenes.
1/250, 1/500, 1/1000**
To record from within a moving car or train or to shoot fast-moving subjects such as roller coasters.
1/2000**
To record outdoor sports scenes on sunny days.

\* [CAM] mode only.

\*\* [CAM] mode only.

### NOTES

#### [TV] SHUTTER-PRIO.AE]

- When setting the shutter speed, the number display will flash if the value is not appropriate for the recording conditions. In such case, select a different value.
- If you use a slow shutter speed in dark places, you can obtain a brighter image, but image quality may be lower, and autofocus may not work well.
- The image may flicker when recording with fast shutter speeds.
- **Recording movies under fluorescent lights:** If the screen starts to flicker, select [TV] SHUTTER-PRIO.AE] and set the shutter speed to 1/100.



---

## Mini Video Light

You can turn on the mini video light to shoot video or take photos in dark places.



**1** Push the joystick ( **▲**) to display the joystick guide.

**2** Select ( **▲▼**) [**VID.LIGHT** ] and press (**SET**).

- appears on the screen.
- Press (**SET**) again to turn the mini video light off.

---

## Video Snapshot

Record a series of short scenes and combine them with music to add a new level of enjoyment to your movies. By changing the music, you can give your scenes an entirely new feel. You can also add to the playlist ( 56) just the scenes you want to watch and change their order.

**FS200** Use the supplied software **Music Transfer Utility** to transfer in advance the music files on the supplied **Instruction Manual/Music Data Disc**

CD-ROM. For details, refer to the software's instruction manual (PDF file).

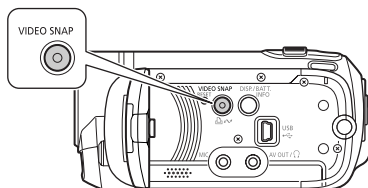

---

## Recording Scenes



**1** Press [**VIDEO SNAP**].

- The button's light illuminates.
- A blue border appears on the screen.

**2** Press [**Start/Stop**].

- The camcorder records for about 4 seconds and then automatically switches to record pause mode.
- The blue border changes to black and roughly indicates how much time has passed. When the camcorder has finished recording, the screen will momentarily turn black as if a camera shutter had released.
- Video Snapshot scenes are indicated in the index screen with a mark.

---

## Combining Scenes with Music



## 1 In the original movies index screen, press **[VIDEO SNAP]**.

- The button's light illuminates.
- An index screen appears that contains only the Video Snapshot scenes.

## 2 Set the background music.

**[FUNC.]** **[♪ SELECT MUSIC]**

Select **(▲▼)** a track\* **[FUNC.]**

\* Press **[SET]** to start/stop the track. Select **[OFF]** to set the original audio of the scenes.

- **[FS22] / [FS21] / [FS20]** Make sure the music files are in the same media (built-in memory or memory card) that contains the scenes. For details, refer to the instruction manual (PDF file) of the supplied software **Music Transfer Utility**.

## Playing Back the Scenes



( 25)

### Select a scene from which to start playback and press **[▶/II]**.

There is no sound during fast playback.

## TO DELETE A MUSIC TRACK

### 1 In the track selection screen, select **(▲▼)** a track to delete.

### 2 Select **[▶] [III]** and press **[SET]**.

### 3 Select **[▶] [YES]** and press **[SET]**.

Press **[FUNC.]** twice to return to the index screen.

## IMPORTANT

Music files transferred to the camcorder with the supplied software **Music**

**Transfer Utility** may not be used without permission from the copyright holder, except for cases permitted under applicable laws, such as for personal use. Make sure to follow applicable laws when using music files.

## NOTES

- If the memory is initialized, the music files in the memory will also be erased. Use the supplied software **Music Transfer Utility** to transfer the music files on the supplied **Instruction Manual/Music Data Disc** CD-ROM to the camcorder.
- **[FS22] / [FS21] / [FS20]** The **Instruction Manual/Music Data Disc** CD-ROM contains the tracks pre-installed in the built-in memory as well as tracks that were not. You can change the tracks in the memory and try out new combinations.
- For details, refer to the instruction manual (PDF file) of the supplied software **Music Transfer Utility**.
- Video Snapshot is deactivated if the camcorder is switched to playback mode.
- Before transferring music files, we recommend making sure that there is enough available space in the memory (about 5 times more than the size of the music files). If there is not enough available space, the video and audio may not play back correctly.
- If the USB cable is disconnected while transferring music files to the camcorder, playback of those files may not be possible. In such case, erase those music files in the





camcorder (📖 48) and transfer the files again.

## Pre-recording Function

The camcorder will start recording 3 seconds before you press **[Start/Stop]**, ensuring you do not miss important shooting opportunities. This is especially useful when it is difficult to predict when to start recording.



**1 Push the joystick (▲) to display the joystick guide.**

**2 Select (▲▼) [Pre REC 📷] and press (SET).**

- 📷 appears.
- Press (SET) again to turn pre-recording off.

**3 Press [Start/Stop] to begin recording.**

The recording will include the 3 seconds before [Start/Stop] was pressed.

### **i** NOTES

- While pre-recording is on, all operational sounds will be turned off.
- The camcorder will not record the full 3 seconds if any of the following operations are not performed before 3 seconds have elapsed.

- Turning on pre-recording
- Exiting standby mode
- Stopping a recording
- Pre-recording will be turned off when any of the following operations are performed.
  - Opening the FUNC. menu or setup menus
  - Leaving the camcorder without any operation for 5 minutes
  - Changing the operating mode
  - Turning on Video Snapshot
  - Setting the camcorder to standby mode

## Self Timer



FUNC. ➤

[MENU] ➤

[CAMERA SETUP] ➤

[SELF TIMER] ➤ [ON 🕒] ➤

FUNC.

🕒 appears.

**mode:**

**In record pause mode, press [Start/Stop].**

The camcorder starts recording after a 10-second countdown\*. The countdown appears on the screen.

**mode:**

**Press [PHOTO], first halfway to activate the autofocus and then fully.**

The camcorder will record the photo after a 10-second countdown\*. The countdown appears on the screen.

- \* **FS22** 2 seconds when using the wireless controller.

## NOTES

- When the LCD panel is rotated toward the lens, we recommend pushing the joystick ( $\blacktriangledown$ ) to hide the joystick guide and make the  $\odot$  icon appear larger.
- The self timer will be canceled when any of the following operations are performed.
  - Pressing **Start/Stop** (when recording movies) or **PHOTO** (when taking photos) once the countdown has begun
  - Turning off the camcorder
  - Changing the operating mode
  - Setting the camcorder to standby mode

## Automatic Backlight Correction and Manual Exposure Adjustment

At times, backlit subjects may appear too dark (underexposed) or subjects under very strong lights may appear too bright or glaring (overexposed). To correct this, you can manually adjust the exposure or use the automatic backlight correction.



( 25)

## POINTS TO CHECK

Select a recording program other than [**FIREWORKS**].

## Automatic Backlight Correction



When shooting subjects with a strong light source behind them, you can have the camcorder automatically correct for the backlight.

**1 Push the joystick ( $\blacktriangle$ ) to display the joystick guide.**

**2 Select ( $\blacktriangle\blacktriangledown$ ) [**BLC** \* $\frac{1}{2}$ ] and press **SET**.**

- $\frac{1}{2}$  appears on the screen.
- Press **SET** again to end the backlight correction mode.

## Manual Exposure Adjustment



**1 Push the joystick ( $\blacktriangle$ ) to display the joystick guide.**

**2 Select ( $\blacktriangle\blacktriangledown$ ) [**EXPOSURE**  $\frac{1}{2}$ ] and press **SET**.**

- The exposure will be locked.
- The exposure adjustment indicator  $\text{---}| \text{---}$  and the neutral value [ $\pm 0$ ] appear on the screen.
- The adjustment range and the length of the exposure adjustment indicator will vary depending on the initial brightness of the picture.

**3 Adjust the ( $\blacktriangle\blacktriangleright$ ) the brightness of the image as required.**

- If you operate the zoom lever during exposure lock, the brightness of the image may change.



- During exposure lock, press **SET** to return the camcorder to automatic exposure.

---

---

## Manual Focus Adjustment

Autofocus may not work well on the following subjects. In such case, focus manually.

- Reflective surfaces
- Subjects with low contrast or without vertical lines
- Fast moving subjects
- Through wet windows
- Night scenes



( 25)

### POINTS TO CHECK

Adjust the zoom before you start the procedure.



- 1 Push the joystick (▲) to display the joystick guide.**
- 2 Select (▲▼) [FOCUS ] and press **SET**.**  
[MF] appears on the screen.
- 3 Adjust (◀▶) the focus as necessary.**
  - The focus will be locked.
  - During focus lock, press **SET** to return the camcorder to autofocus.

---

## Infinity Focus

Use this function when you wish to focus on faraway subjects such as mountains or fireworks.

Instead of step 3 in the previous procedure:

**Push the joystick (▶) toward ▲ and hold it down.**

- ∞ appears.
- If you operate the zoom or push the joystick (◀) and hold it down, ∞ changes to [MF] and the camcorder returns to manual focus.

---

---

## White Balance

The white balance function helps you to accurately reproduce colors under different lighting conditions so that white objects will always look truly white in your recordings.



( 25)



### POINTS TO CHECK



Select a recording program other than the Special Scene recording programs.

## Options

◆ Default value

[ <b>AWB AUTO</b> ]◆
The camcorder automatically sets the white balance for natural-looking colors.
[ <b>DAYLIGHT</b> ]
For recording outdoors on a bright day.



[  TUNGSTEN ]
For recording under tungsten and tungsten type (3-wavelength) fluorescent lighting.
[  SET ]
Use the custom white balance setting to make white subjects appear white under colored lighting.

[FUNC.] [  AUTO ] Desired option\* 



[FUNC.]

\* When you select [  SET ], do not press [FUNC.] and continue instead with the following procedure.

## TO SET THE CUSTOM WHITE BALANCE

- 1 Point the camcorder at a white object, zoom in until it fills the whole screen and press .**  
When the adjustment is completed,  stops flashing and stays on. The camcorder retains the custom setting even if you turn off the camcorder.
- 2 Press [FUNC.] to save the setting and close the menu.**

## NOTES

- When you select the custom white balance:**
  - Set the custom white balance in a sufficiently illuminated place.
  - Select a zoom type other than [  DIGITAL ] (□ 35).
  - Reset the white balance when the lighting conditions change.
  - Depending on the light source,  may keep flashing. The result will still be better than with [  AUTO ].

- Custom white balance may provide better results in the following cases:
  - Changing lighting conditions
  - Close-ups
  - Subjects in a single color (sky, sea or forest)
  - Under mercury lamps and certain types of fluorescent lights

## Image Effects

You can use the image effects to change the color saturation and contrast to record images with special color effects.







(□ 25)

## POINTS TO CHECK

Select a recording program other than the Special Scene recording programs.

### Options

♦ Default value

[  IMAGE EFFECT OFF ] ♦
Records with no image enhancing effects.
[  VIVID ]
Emphasizes the contrast and color saturation.
[  NEUTRAL ]
Tones down the contrast and color saturation.
[  SOFT SKIN DETAIL ]
Softens the details in the skin tone area for a more complimentary appearance. To obtain the best effect, use this setting when recording a person in close-up. Note that areas similar to the skin color may lack in detail.



FUNC.    
 [ OFF IMAGE EFFECT OFF ]    
 Desired option    
 FUNC.

## Digital Effects



### Options

 Default value

[  OFF D.EFFECT OFF ] 
Select this setting when you do not intend to use the digital effects.
[  FADE-T ] (fade trigger), [  WIPE ]
Select one of the faders to begin or end a scene with a fade from or to a black screen.
[  BLK&WHT ]*
Records images in black and white.
[  SEPIA ]*
Records images in sepia tones for an “old” look.
[  ART ], [  MOSAIC ]
Select one of these digital effects to add “flavor” to your recordings.

\* Only these digital effects are available in  mode.

### Setting

FUNC.    
 [ D.EFFECT OFF ]    
 Desired fader/effect\*    
 FUNC. \*\*

\* You can preview the digital effect on the screen.

\*\* The icon of the selected digital effect appears.

### Applying

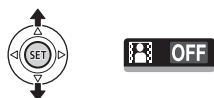

**1** Push the joystick (▲) to display the joystick guide.

**2** Select (▲▼) [D.EFFECT ] and press .

- The icon of the selected effect turns green.
- Press  again to deactivate the digital effect (its icon will turn white again).

#### TO FADE IN

Activate the selected fader in record pause mode (●||), then press  to start recording with a fade in.

#### TO FADE OUT

Activate the selected fader while recording (●), then press  to fade out and pause the recording.

#### TO ACTIVATE AN EFFECT

 mode: Activate the selected effect while recording or in record pause mode.

 mode: Activate the selected effect and then press  to record the photo.

## **i** NOTES

- When you apply a fader, not only the picture but also the sound will fade in or out. When you apply an effect, the sound will be recorded normally.
- The camcorder retains the last setting used even if you turn off the digital effects or change the recording program.

## On-Screen Displays and Data Code

With every scene or photo recorded, the camcorder keeps a data code that includes the date, time and information about the camera setup at the time of recording. While viewing a photo, all the data is displayed in the form of information icons. During movie playback you can select what to display with the [DATA CODE] setting (p. 89). You can also turn most on-screen displays on or off.

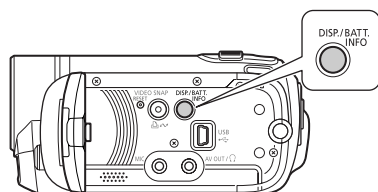

**Repeatedly press [DISP.] to turn the on-screen displays on/off in the following sequence:**

 ,  mode:





- All displays on
- Most displays off\*

 mode:



- All displays on
- Data code only
- All displays off

 mode:

- All displays on
- Regular displays only (removes the histogram and information icons)
- All displays off





\* The following icons will appear even when all other on-screen displays are turned off: The icons  and  (in  mode), the  icon and AF frames when the autofocus is locked (in  mode), screen markers (both recording modes).

## Using Headphones

Use headphones for playback or to check the audio level while recording. The headphones are connected to the AV OUT/ terminal, which is used for both the headphones and the audio/video output. Before connecting the headphones, follow the procedure below to change the function of the terminal from AV output to  (headphones) output.



\* If recording in  mode, change the terminal's setting and headphone volume in advance.

[FUNC.]    
 [MENU]    
 [SYSTEM SETUP]    
 [AV/PHONES]  [PHONES]    
 [FUNC.]



appears.

### TO ADJUST THE VOLUME OF THE HEADPHONES

In mode, adjust the volume of the headphones with the [PHONES VOL.] setting (□ 90). In mode, adjust the headphone's volume the same way you adjust the speaker's volume (□ 38). During slideshow playback, push the joystick (◀▶) to adjust the volume.

### ! IMPORTANT

- When using headphones, make sure to lower the volume to an appropriate level.
- Do not connect the headphones to the AV OUT/ terminal if the icon does not appear on the screen. Only noise will be output in such case.

### i NOTES

- Use commercially available headphones with a  $\varnothing$  3.5 mm minijack.
- Even if the AV OUT/ terminal is set to [ PHONES] during playback mode, the setting will change to [ AV] when the operating mode is changed to or mode.

## Using an External Microphone

You can attach a commercially available microphone for recording movies.

When recording in very quiet surroundings, the built-in microphone

may pick up the sound of the camcorder's internal machinery. In such case, we recommend using an external microphone.

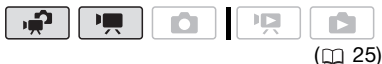

### Connecting a Microphone

Connect the external microphone to the MIC terminal. Use commercially available condenser microphones with their own power supply. You can connect almost any stereo microphone with a  $\varnothing$  3.5 mm plug but audio recording levels may vary.

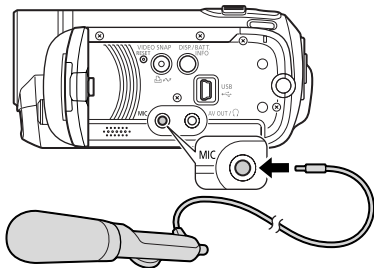

### ! IMPORTANT

Make sure to check the audio recording level before recording with the external microphone (□ 88).

### i NOTES

When an external microphone is connected to the camcorder, [WIND SCREEN] will automatically be set to [ OFF OFF OFF].

## Playlist and Scene Operations

### Dividing Scenes

You can divide scenes (original scenes only) in order to leave out the best parts and later cut out the rest.



#### 1 Open the original movies index screen.

**[FS22] / [FS21] / [FS20]** You can select the movies in the built-in memory or on the memory card ( 40).

#### 2 Select (**▲▼**, **◀▶**) the scene you want to divide.

#### 3 Open the scene division screen.

**[FUNC.]** **[▶]** **[⌘]** **[DIVIDE]**

The scene selected will start playing back.

#### 4 Select (**◀▶**) the **[⌘]** icon and press **[SET]** where you want to divide the scene.

- You can use the following icons to bring the scene to a precise point.
  - ◀◀/▶▶**: Fast playback reverse/forward.
  - ⏮/⏭**: Skip to the beginning/end of the current scene.
  - ◀||/||▶**: Frame reverse/advance.
- Press **[FUNC.]** or **[■]** to stop the playback and exit the scene division screen.

#### 5 Select (**▶**) **[YES]** and press **[SET]**.

- A progress bar will be displayed on the screen.
- You can press **[SET]** to cancel the operation while it is in progress.

#### 6 When the confirmation screen appears, press **[SET]**.

The video from the division point to the end of the scene will appear as a new scene in the index screen.

### **[i]** NOTES

- In this mode, the scene playback will pause only at points where the scene can be divided.
- The following scenes cannot be divided:
  - Scenes included in the scene selection (marked with a ✓ checkmark). Remove the selection mark in advance.
  - Scenes too short (5 seconds or shorter).
  - Video Snapshot scenes
  - Scenes that were not recorded with this camcorder.
- Scenes cannot be divided within 2 seconds from the beginning or the end of the scene.
- During the playback of a scene that was divided, you may notice some anomalies in the picture/sound at the point where the scene was cut.

### Editing the Playlist: Adding, Deleting and Moving Playlist Scenes

Create a playlist to play back only the scenes you prefer and in the order of your choice and even set them to music ( 47). You can also create a playlist that contains only Video Snapshot





scenes (□ 47). Moving or deleting scenes in the playlist will not affect the original recordings.



## Adding Scenes to the Playlist

### Options

[ALL SCENES (THIS DATE)]
Adds to the playlist all the scenes that were recorded on the same day as the selected scene.
[ONE SCENE]
Adds to the playlist only the scene marked with the orange selection frame.
[SELECTED SCENES]
Adds to the playlist all the scenes selected in advance (marked with a ✓ checkmark). Refer to <i>Pre-selecting Recordings from the Index Screen</i> (□ 42).

### 1 Open the original movies index screen.

- From the this index screen, you can also press [VIDEO SNAP] to open the index screen for Video Snapshot (□ 47) scenes.
- **[FS22] / [FS21] / [FS20]** You can select the movies in the built-in memory or on the memory card (□ 40).

### 2 Select (▲▼, ◀▶) the scene you want to add to the playlist, or a scene recorded on the date you want to add to the playlist.

This step is not necessary for scenes selected in advance.

### 3 Add the scene(s) to the playlist.

[FUNC.] ● [ ] ADD TO PLAYLIST

● Desired option ● [YES]

- When the operation is completed [ADDED TO PLAYLIST] will be displayed.

- **[FS22] / [FS21] / [FS20]** Scenes are added to the playlist on the same media they are recorded on.

- To check the playlist, press

[PLAYLIST].

### NOTES

- **[FS22] / [FS21] / [FS20]** You can copy scenes from the built-in memory to the memory card (□ 58) to include in the memory card's playlist also scenes that were originally recorded in the built-in memory.
- You may not be able to add scenes to the playlist if they were recorded or edited using another device or if there is not enough space available in the memory.
- **[FS22]** You can press [PLAYLIST] on the wireless controller to switch between the original movies index screen and the playlist of the respective memory.

## Deleting Scenes from the Playlist

Deleting scenes from the playlist will not affect your original recordings.

### Options

[ALL SCENES]
Deletes all the scenes from the playlist.
[ONE SCENE]
Deletes from the playlist only the scene marked with the orange selection frame.

### 1 Open the playlist index screen.

In the original movies index screen, press [PLAYLIST].

## 2 Select (▲▼, ◀▶) the scene you want to delete.

This step is not necessary to delete all scenes.

## 3 Delete the scene(s).

[FUNC.] ➤ [DELETE] ➤  
Desired option ➤ [YES] ➤ [OK] ➤  
[FUNC.]

### Moving Scenes in the Playlist

Move the scenes in the playlist to play them back in the order of your choice.

## 1 Open the playlist index screen.

In the original movies index screen, press [PLAYLIST].

## 2 Select (▲▼, ◀▶) the scene you want to move.

## 3 Open the screen to move scenes.

[FUNC.] ➤ [MOVE]

## 4 Move (▲▼, ◀▶) the orange marker to the desired position of the scene and press [SET].

The original position of the scene and the current position of the marker are displayed at the bottom of the screen.

## 5 Select [▶] [YES] and press [SET] to move the scene.

### NOTES

You may not be able to move scenes in the playlist if there is not enough space available in the memory.

### FS22 / FS21 / FS20 Copying Scenes

You can copy original movies or the entire playlist only from the built-in memory to the corresponding location on the memory card.



### Copying Original Movies

#### Options

[ALL SCENES]	Copies all the scenes to the memory card.
[ALL SCENES (THIS DATE)]	Copies to the memory card all the scenes that were recorded on the same day as the selected scene.
[ONE SCENE]	Copies only the scene marked with the orange selection frame to the memory card.
[SELECTED SCENES]	Copies to the memory card all the scenes selected in advance (marked with a ✓ checkmark). Refer to <i>Pre-selecting Recordings from the Index Screen</i> (42).

## 1 Open the original movies index screen of the built-in memory.

## 2 Select (▲▼, ◀▶) the scene you want to copy to the memory card, or a scene recorded on the date you want to copy.

This step is not necessary to copy all scenes or previously selected scenes.

### 3 Copy the scene(s).

[FUNC.] > [COPY] >  
Desired option > [YES]\* >  
[OK] > [FUNC.]

\* Press **SET** to interrupt the operation while it is in progress.

## Copying the Entire Playlist

---

### 1 Open the index screen of the built-in memory's playlist.

In the original movies index screen of the built-in memory, press [PLAYLIST].

### 2 Copy the scene(s).

[FUNC.] > [COPY] >  
[YES]\* > [OK] > [FUNC.]

\* Press **SET** to interrupt the operation while it is in progress.

## **!** IMPORTANT

---

Observe the following precautions while the ACCESS indicator is on or flashing. Failing to do so may result in permanent data loss.

- Do not open the memory card slot cover.
- Do not disconnect the power source or turn off the camcorder.
- Do not change the operating mode.

## **i** NOTES

---

- If the memory card does not have enough free space, you will not be able to copy movies.
- If the memory card slot cover is open, or the LOCK switch on the memory card is set to prevent writing, you will not be able to copy movies to the memory card.



# Photos

Refer to this chapter for details on shooting photos – from capturing and playing back photos to printing them.

## Basic Recording

### Taking Photos

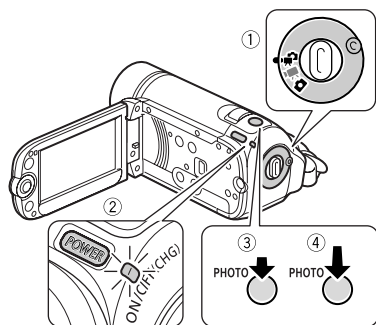

**1** Set the camera mode dial to or .

**2** Turn on the camcorder.

**FS22 / FS21 / FS20** You can select the memory to be used for recording photos (□ 32).

**3** Press **PHOTO** halfway.

- Once the focus is automatically adjusted, ● will turn green and one or more AF frames will appear.

- FS22** When you press **PHOTO** on the wireless controller, the photo is recorded after the autofocus is activated and locked.

**4** Press **PHOTO** fully.

The **ACCESS** indicator will flash as the photo is being recorded.

### ! IMPORTANT

Observe the following precautions while the **ACCESS** indicator is on or flashing. Failing to do so may result in permanent data loss.

- Do not open the memory card slot cover.
- Do not disconnect the power source or turn off the camcorder.
- Do not change the operating mode.

### i NOTES

If the subject is not suitable for autofocus, ● turns yellow. Adjust the focus manually (□ 51).

## Selecting Photo Size and Quality

Photos are recorded as JPG files. As a general rule, select a larger photo size for higher quality. **FS22 / FS21 / FS20** Select the **[LW 1152x648]** size for photos with an aspect ratio of 16:9.



( 25)

## Options

Photo size options and the approximate number of photos that can be recorded on memory cards of various sizes are given in the table below.

**FUNC.**

[ 1152x864] (**FS22** / **FS21** / **FS20** only) or

[ 1024x768] (**FS200** only)

Desired photo size\*

Desired photo quality\*

**FUNC.**

\* Press to move back and forth between size and quality selection. The number displayed on the right corner indicates the approximate number of photos that can be recorded with the current quality/size setting.

## NOTES

- The camcorder retains the last setting used even if you set the camcorder to mode.
- When printing photos, use the following guidelines as a reference for selecting the print size.

Photo size	Recommended use
<b>LW</b> 1152x648	To print photos on wide-sized photo paper or to view photos on a TV with a 16:9 aspect ratio.
<b>L</b> 1152x864 or <b>L</b> 1024x768	To print photos up to L size (9 x 13 cm, 3.5 x 5 in.) or postcard size (10 x 14.8 cm, 4 x 6 in.).
<b>S</b> 640x480	To send photos as e-mail attachments or to post on the Web.

## Approximate number of photos on a memory card

Default value

Memory card	128 MB			512 MB			1 GB		
Photo quality <sup>1</sup>									
Photo size									
<b>LW</b> 1152x648 ( <b>FS22</b> / <b>FS21</b> / <b>FS20</b> only)	245	360	695	970	1,435	2,740	1,945	2,875	5,490
<b>L</b> 1152x864 <sup>♦</sup> ( <b>FS22</b> / <b>FS21</b> / <b>FS20</b> only)	185	280	545	735	1,115	2,155	1,470	2,235	4,315
<b>L</b> 1024x768 <sup>♦</sup> ( <b>FS200</b> only)	235	345	695	940	1,370	2,740	1,885	2,745	5,490
<b>S</b> 640x480	585	850	1,530	2,320	3,350	6,035	4,645	6,710	12,085 <sup>2</sup>

<sup>1</sup> : [SUPER FINE], : [FINE], : [NORMAL]

<sup>2</sup> Approximate number of photos that can actually be recorded on the memory card. (The maximum number of remaining photos displayed on the screen is 9999.)

## Erasing a Photo Right After Recording It

You can erase the photo recorded last while reviewing it within the time set for the [REVIEW] option or immediately after recording it, if [REVIEW] is set to [OFF OFF].



While reviewing the photo immediately after recording:

- 1 Push the joystick (▲) to display the joystick guide.
- 2 Press **SET**.
- 3 Select (◀▶) [YES] and press **SET**.

## Basic Playback

### Viewing Photos

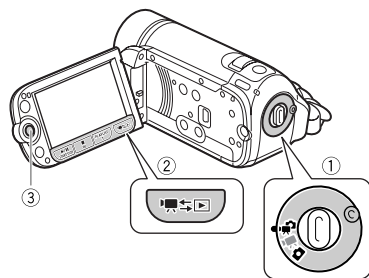

When the camera mode dial is set to or :

- 1 Press .
  - Even if the camcorder is off, pressing will turn on the camcorder in playback mode.
  - The original movies index screen appears after a few seconds.
- 2 Move (▲▼) the orange selection frame to the tabs on the top of the screen.
- 3 Select (◀▶) the tab that contains the photos you want to play back.
  - **FS22 / FS21 / FS20** You can switch between the photos recorded in the built-in memory and those recorded on the memory card. Refer to *Selecting What Recordings to Play Back* ( 40).



**4 Return (▲▼) to the index screen.**

**5 Select (▲▼, ◀▶) a photo.**

- Move the orange selection frame to the photo you want to view.
- Push the joystick (▲▼) to extend the selection frame and browse (◀▶) through whole index pages. Push the joystick (▲▼) to return to the index screen.

**6 Press (SET).**



The index screen closes and the selected photo is displayed.

**7 Push the joystick (◀▶) to move between images.**

Push the joystick (◀▶) and hold it down to run quickly through the photos.

When the camera mode dial is set to :

**1 Press   .**

- Even if the camcorder is off, pressing    will turn on the camcorder in playback mode.
- The last photo recorded will appear.

**2 Push the joystick (◀▶) to move between photos.**

Push the joystick (◀▶) and hold it down to run quickly through the photos.

## Photo Jump Function



When you have recorded a large number of photos, you can jump 10 or 100 photos at a time.

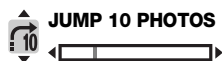

**1 Push the joystick (▲) to display the joystick guide.**

**2 Select (▲▼)  and press (SET).**



**3 Select (▲▼) [ 10 JUMP 10 PHOTOS] or [ 100 JUMP 100 PHOTOS].**

**4 Jump (◀▶) the number of photos selected and press (SET).**

## Index Screen

**1 Move the zoom lever toward W.**

- The photo index screen appears.
- **FS22 / FS21 / FS20** You can switch between the photos recorded in the built-in memory and those recorded on the memory card. Refer to *Selecting What Recordings to Play Back* (□ 40).

**2 Select (▲▼, ◀▶) a photo.**

- Move the orange selection frame to the photo you want to view.
- Push the joystick (▲▼) to extend the selection frame and browse (◀▶) through whole index pages. Push the joystick (▲▼) to return to the index screen.

**3 Press (SET).**

The index screen closes and the selected photo is displayed.

## Slideshow

You can play a slideshow of all the photos and even set it to music.

**1 Select the first photo of the slideshow.**

## 2 Press to play back the photos one after another.

Press  to stop the slideshow.

### TO SET THE SLIDESHOW TO MUSIC

#### 1 In the photo index screen, press

.



#### 2 Select a track to play with the slideshow.

 .

Select () a track\* .

.

\* Press  to start/stop the track.

- You can delete music files to free up space in the memory ( 48).
- Refer to *Adjusting the volume* ( 38) for details on adjusting the speaker's volume.

### IMPORTANT

- Observe the following precautions while the ACCESS indicator is on or flashing. Failing to do so may result in permanent data loss.
  - Do not open the memory card slot cover.
  - Do not disconnect the power source or turn off the camcorder.
  - Do not change the operating mode.
- The following may not be displayed correctly.
  - Photos not recorded with this camcorder.
  - Photos edited on or uploaded from a computer.
  - Photos whose file names have been changed.

### NOTES

- FS22 / FS21 / FS20** When playing back a slideshow, make sure the music files are in the same media (built-in memory or memory card) that contains the photos. For details, refer to the instruction manual (PDF file) of the supplied software **Music Transfer Utility**.
- When playing back a slideshow from a memory card, we recommend using a memory card that is rated Speed Class 2 or higher. When using memory cards with no Speed Class rating, it may take longer than usual for photos to advance or there may be brief stops in the sound.

### Magnifying Photos during Playback

During playback, photos can be magnified up to 5 times.



#### 1 Move the zoom lever toward **T**.

- The photo is magnified by 2 times and a frame appears indicating the position of the magnified area.
- To further enlarge the photo, move the zoom lever toward **T**. To reduce the magnification to less than 2 times, move it toward **W**.





- will appear for photos that cannot be enlarged.

## 2 Move (, ) the frame to the part of the photo you want to see enlarged.

To cancel the magnification, move the zoom lever toward **W** until the frame disappears.

## Deleting Photos

You can delete those photos that you are not interested in keeping.



### Deleting a Single Photo

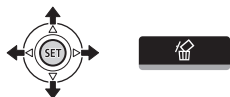

- 1 Select () the photo you want to erase.
- 2 Push the joystick () to display the joystick guide.
- 3 Select () and press **(SET)**.
- 4 Select () **[YES]** and press **(SET)**.

### Deleting Photos from the Index Screen

#### Options

<b>[ALL PHOTOS]</b>
Deletes all the photos.

<b>[ONE PHOTO]</b>
Deletes only the photo marked with the orange selection frame.
<b>[SELECTED PHOTOS]</b>
Deletes all the photos selected in advance (marked with a  checkmark). Refer to <i>Pre-selecting Recordings from the Index Screen</i> ( 42).

### 1 Open the photo index screen.

- Move the zoom lever toward **W**.
- **FS22 / FS21 / FS20** You can switch between the photos recorded in the built-in memory and those recorded on the memory card. Refer to *Selecting What Recordings to Play Back* ( 40).

### 2 Select (, ) the photo you want to delete.

This step is not necessary to delete all photos or previously selected photos.

### 3 Delete the photo(s).

**[FUNC.]** **[DELETE]**   
 Desired option **[YES]\***   
**[OK]** **[FUNC.]**

\* If you selected an option other than **[ONE PHOTO]**, you can press **(SET)** to interrupt the operation while it is in progress. Some photos will be deleted nevertheless.

### IMPORTANT

Be careful when deleting photos. Deleted photos cannot be recovered.

### NOTES

Protected photos cannot be deleted.

## Additional Functions

### FS22 / FS21 / FS20 Drive Mode: Continuous Shooting and Exposure Bracketting

Take a series of photos of a moving subject or record the same photo in 3 levels of exposure in order to choose later the photo you like the best.



#### POINTS TO CHECK

Select a recording program other than [FIREWORKS].

## Options

◆ Default value

[ <input type="checkbox"/> SINGLE ]◆
Records a single photo.
[  CONT.SHOOT. ] (Continuous Shooting), [  HISPEED CONT.SHOOT. ] (High-Speed Continuous Shooting)
Captures a series of photos as long as you hold [ PHOTO ] pressed down. For the number of shots per second, refer to the sidebar on page 66.
[  AEB ] (Auto Exposure Bracketting)
The camcorder records a photo in three different exposures (dark, normal, light in 1/2 EV steps), allowing you to choose the shot you like the best.

[FUNC.]

[  SINGLE ]

Desired option

[FUNC.]

### CONTINUOUS SHOOTING/ HIGH-SPEED CONTINUOUS SHOOTING

- 1 Press [PHOTO] halfway to activate the autofocus.
- 2 Press [PHOTO] fully and hold it pressed down.  
A series of photos will be recorded as long as you hold the button pressed.

#### Maximum number of continuous shots

Number of photos per second	
Normal speed	3 photos
High speed	5 photos

Maximum number of continuous shots	
<b>LW</b> 1152 x 648,	10 photos
<b>L</b> 1152 x 864	
<b>S</b> 640 x 480	20 photos

These figures are approximate and vary with the recording conditions and subjects. The actual number of frames per second will be lower when the shutter speed is 1/30 or slower.



## AUTO EXPOSURE BRACKETING

Press **[PHOTO]**, first halfway to activate the autofocus and then fully to record the photos.

Three photos in different exposures will be recorded.

## Histogram Display

When viewing photos you can display the histogram and the icons of all the functions used at the time of recording. Use the histogram as a reference to verify the correct exposure of the photo.



The area to the right of the histogram represents highlights and the left side represents shadows. A photo whose histogram skews to the right is relatively bright; while one whose histogram peaks to the left, is relatively dark.

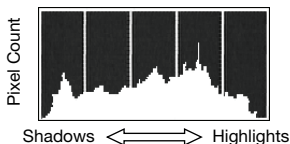

### **i** NOTES

The histogram will appear also after recording a photo, while reviewing it within the time set for the **[REVIEW]** option. You can choose to turn off the histogram by pressing **[DISP.]** ([ ] 54).

## Protecting Photos

You can protect photos from accidental erasure.



## Protecting Single Photos

### 1 Open the photo selection screen.

**[FUNC.]** **[ON PROTECT]**  
**[ON PROTECT]** appears on the screen.

### 2 Select (**◀▶**) the photo you want to protect.

### 3 Press **[SET]** to protect the photo.

**[ON]** appears on the bottom bar and the photo cannot be deleted. Press **[SET]** again to remove the protection.

### 4 Repeat steps 2-3 to protect additional photos or press **[FUNC.]** twice to close the menu.

## Protecting Photos from the Index Screen

### Options

<b>[INDIVIDUAL PHOTOS]</b>
Opens the same screen described in <i>Protecting Single Photos</i> ([ ] 67). Continue from step 3 of that procedure to protect the photo.
<b>[SELECTED PHOTOS]</b>
Protects all the photos selected in advance (marked with a ✓ checkmark). Refer to <i>Pre-selecting Recordings from the Index Screen</i> ([ ] 42).
<b>[REMOVE ALL SELECTIONS]</b>
Removes the protection from all photos.

[FUNC.]   
 [  PROTECT ]   
 Desired option  [YES]  [OK]  
 [FUNC.]

## IMPORTANT

Initializing the recording media (  32 ) will permanently erase all recordings, including protected photos.

## **FS22 / FS21 / FS20** Copying Photos

You can copy photos only from the built-in memory to the memory card.



### Copying Single Photos

- 1 Open in single photo view the photo you want to copy (  63 ).
- 2 Copy the photo to the memory card.



[FUNC.]  [  COPY ]  Press   
 [YES]  Press [FUNC.] twice

### Copying Photos from the Index Screen

#### Options

[ALL PHOTOS]
Copies all the photos.
[ONE PHOTO]
Copies only the photo marked with the orange selection frame.

#### [SELECTED PHOTOS]







Copies all the photos selected in advance (marked with a  checkmark). Refer to *Pre-selecting Recordings from the Index Screen* (  42 ).

### 1 Open the index screen of the photos recorded in the built-in memory.

Move the zoom lever toward **W** and then select the  (built-in memory) tab.

### 2 If you want to copy only one photo, select ( , ) the photo you want to copy.

### 3 Copy the photo(s).

[FUNC.]  [  COPY ]   
 Desired option  [YES]\*  [OK]\*\*   
 [FUNC.]

\* If you selected [SELECTED PHOTOS] or [ALL PHOTOS], you can press  to interrupt the operation while it is in progress.

\*\* This step is not required when copying a single photo.

## IMPORTANT

Observe the following precautions while the ACCESS indicator is on or flashing. Failing to do so may result in permanent data loss.

- Do not open the memory card slot cover.
- Do not disconnect the power source or turn off the camcorder.
- Do not change the operating mode.

## NOTES

- If there is not enough space on the memory card, the camcorder will copy as many photos as possible before stopping the operation.



- If the memory card slot cover is open, or the LOCK switch on the memory card is set to prevent writing, you will not be able to copy photos to the memory card.

### You can also use the following functions...

The following functions and features of the camcorder can be used either for shooting video or for taking photos. The way to set and use them was already explained in detail, so we refer you to the relevant page in the “Video” section.

- Zoom (□ 35)
- Quick Start (□ 37)
- Recording programs (□ 44, 45)
- Mini video light (□ 47)
- Self timer (□ 49)
- Automatic backlight correction and manual exposure adjustment (□ 50)
- Manual focus adjustment (□ 51)
- White balance (□ 51)
- Image effects (□ 52)
- Digital effects (□ 53)

## Printing Photos

### Printing Photos

The camcorder can be connected to any PictBridge-compatible printer. You can mark in advance the photos you want to print and set the desired number of copies as a print order (□ 72).





**Canon printers:** SELPHY printers of the CP, DS and ES series and PIXMA printers marked with the PictBridge logo.





### Connecting the Camcorder to the Printer



- 1 Turn on the printer.**
- 2 Connect the camcorder to the printer using the supplied USB cable.**
  - Connection [2]. Refer to *Connection Diagrams* (□ 75).
  - If the device type selection screen appears, select [PC/PRINTER] and press **SET**.
  - **FS22 / FS21 / FS20** Select in advance the memory from which you want to print the photos (□ 40).

- If the photo index screen is displayed, move the zoom lever toward **T** to display a photo.
-  appears and changes to .
- The  (print/share) button lights up and the current print settings will be displayed for approx. 6 seconds.

### IMPORTANT

- If  continues to flash (for more than 1 minute) or if  does not appear, the camcorder is not correctly connected to the printer. In such case, disconnect the USB cable and turn off the camcorder and the printer. After a short while, turn them on again, set the camcorder to  mode and restore the connection.
- During the following operations, even if you connect a printer to the camcorder it will not be recognized.
  - Erasing all photos
  - Erasing all transfer orders
  - Erasing all print orders

### NOTES

-  will appear for photos that cannot be printed.
- We recommend powering the camcorder using the compact power adapter.
- Refer also to the printer's instruction manual.
- If you have no intention to use the optional DW-100 DVD Burner, you can set [USB SETTING] to [PC/PRINTER] ( 90) so the device type selection screen does not appear every time you connect the camcorder to a printer.
- Connection to a PictBridge-compatible printer will not work when the memory card contains 1,800 photos or more.

- For best performance, we recommend keeping the number of photos on the memory card under 100.
- Disconnect the USB cable before changing the operating mode.

### Printing with the (Print/Share) Button

You can print a photo without changing the settings simply by pressing .

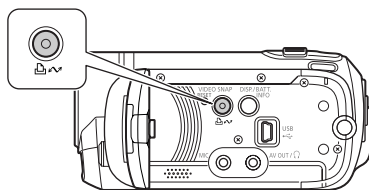

**1 Select (◀▶) the photo you wish to print.**

**2 Press .**

- Printing starts. The  button flashes and stays on when the printing is completed.
- To continue printing, select (◀▶) another photo.

### Selecting the Print Settings

You can select the number of copies and other settings for printing. The setting options vary depending on your printer model.





## Options

[PAPER]
[ PAPER SIZE]: Available paper sizes vary depending on the printer model.
[ PAPER TYPE]: Select [PHOTO], [FAST PHOTO], [PLAIN] or [DEFAULT].
[ PAGE LAYOUT]: Select [DEFAULT], [BORDERED] or one of the following page layouts. [BORDERLESS]: The photo is enlarged and may be slightly cropped at the edges to fit the paper. [2-UP], [4-UP], [8-UP], [9-UP], [16-UP]: Refer to the sidebar on page 72.
[☑] (Date print)
Select [ON], [OFF] or [DEFAULT].
[🖨] (Print effect)
Available only with printers compatible with the Image Optimize function. Select [ON], [OFF] or [DEFAULT]. <b>Canon PIXMA/SELPHY DS printers:</b> You can also select [VIVID], [NR] and [VIVID+NR].
[📄] (Number of copies)
Select 1-99 copies.

## **i** NOTES

Print setting options and [DEFAULT] settings vary depending on the printer model. For details, refer to the printer's instruction manual.

## Printing after Changing the Print Settings



- 1 Push the joystick (▲) to display the joystick guide.

- 2 Select (▲▼) and press (SET).

The print settings menu appears.

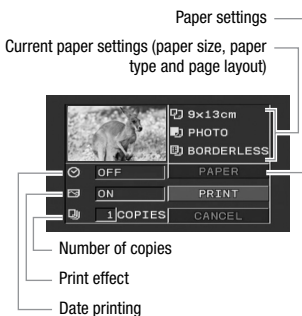

- 3 In the print settings menu, select (▲▼, ◀▶) the setting you want to change and press (SET).

- 4 Select (▲▼) the desired setting option and press (SET).

- 5 Select (▲▼, ◀▶) [PRINT] and press (SET).

- Printing starts. The print settings menu disappears when the printing is completed.
- To continue printing, select (◀▶) another photo.

## TO CANCEL THE PRINTING



- 1 Press (SET) while printing.
- 2 Select (◀▶) [OK] and press (SET).

## WHEN YOU HAVE FINISHED PRINTING

Disconnect the cable from the camcorder and printer and turn off the camcorder.

## PRINT ERRORS

If an error occurs while printing, an error message, for example [NO PAPER], will appear on the camcorder. Solve the problem referring to the error message list (□ 103) and to the printer's instruction manual.

- **Canon's PictBridge-compatible printers:** If printing does not resume automatically after you solved the problem, select [CONTINUE] and press  to resume printing. If that option is not available, select [STOP] and press  and then restart printing from the beginning.
- **Other printers or if the error still persists with a Canon printer:** If printing does not resume automatically, disconnect the USB cable and turn off the camcorder. After a short while, turn on the camcorder and restore the USB connection.

## ! IMPORTANT

- You may not be able to print correctly with a PictBridge-compatible printer photos whose file names have been

changed or that were recorded, created, edited or changed with any device other than this camcorder.

- If [BUSY] does not disappear, disconnect the USB cable and restore the connection after a short while.

## Print Orders

You can mark in advance the photos you want to print and set the desired number of copies as a print order. Later, you can easily print out the print orders by connecting the camcorder to a PictBridge-compatible printer (□ 69). You can set print orders for up to 998 photos.



(□ 25)

## Printing multiple photos on the same sheet [2-UP], [4-UP], etc.

When using Canon printers you can print the same photo multiple times on the same sheet of paper. Use the following table as a guideline for the recommended number of copies depending on the [ PAPER SIZE] setting.

[  PAPER SIZE] →	[CREDITCARD]	[9 x 13 cm]	[10 x 14.8 cm]	[A4]
Canon printer ↓				
PIXMA SELPHY DS	–	–	2, 4, 9 or 16 <sup>1</sup>	4
SELPHY CP/ES	2, 4 or 8 <sup>2</sup>	2 or 4	2 or 4	–

<sup>1</sup> You can also use the special sticker sheets.

<sup>2</sup> With the [8-UP] setting, you can also use the special sticker sheets (SELPHY CP printers only).

SELPHY CP: When you use the wide-sized photo paper with the [DEFAULT] setting, you can also use [2-UP] or [4-UP].





## Selecting Photos for Printing (Print Order)

Set the print orders before connecting the supplied USB cable to the camcorder.

### Marking Single Photos with Print Orders

#### 1 Open the photo selection screen.

[FUNC.] > [PRINT ORDER]  
[PRINT] 0 appears on the screen.

#### 2 Select (◀▶) the photo you want to mark with a print order.

#### 3 Press (SET) to set the print order.

The number of copies appears in orange.

#### 4 Set (▲▼) the number of copies desired and press (SET).

To cancel the print order, set the number of copies to 0.

#### 5 Repeat steps 2-4 to mark additional photos with print orders or press [FUNC.] twice to close the menu.

## Setting Print Orders from the Index Screen

### Options

#### [INDIVIDUAL PHOTOS]

Opens the same screen described in *Marking Single Photos with Print Orders* (□ 73). Continue from step 3 of that procedure to set the print order.

#### [SELECTED PHOTOS(1 COPY)]

Sets a print order of 1 copy of each of the photos selected in advance (marked with a ✓ checkmark). Refer to *Pre-selecting Recordings from the Index Screen* (□ 42).

#### [REMOVE ALL]

Removes all the print orders.

[FUNC.] >  
[PRINT ORDER] >  
Desired option > [YES] > [OK]  
[FUNC.]

## Printing the Photos Marked with Print Orders

### 1 Connect the camcorder to the printer using the supplied USB cable.

Connection [2]. Refer to *Connection Diagrams* (□ 75).

### 2 Open the print settings menu.

[FUNC.] > [MENU] >  
[PRINT]

- The print settings menu appears.
- If there are no photos marked with print orders, [SET] PRINT ORDER] appears.

### 3 Select (▲▼, ▶◀) [PRINT] and press (SET).

Printing starts. The print settings menu disappears when the printing is completed.

### NOTES

---

- Depending on the connected printer, you can change some print settings before step 3 (□□ 70).
- To cancel the printing, refer to page 71.
- **Restarting Printing:** Open the print settings menu as explained in step 2. In the print settings menu, select [RESUME]\* and press . The remaining photos will be printed. Printing cannot be restarted when the print order settings have been changed or if you deleted a photo with print order settings.

\* In case the print order was interrupted after the first photo, this menu option will appear as [PRINT] instead.



4



# External Connections

This chapter explains how to connect your camcorder to an external device such as a TV, VCR, or computer.

## Terminals on the Camcorder

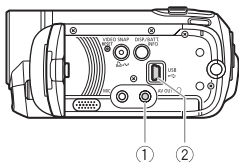

### ① AV OUT / Ω Terminal

Access: Open the LCD panel.

Sound from the built-in speaker will be muted while the STV-250N Stereo Video Cable is connected to the camcorder.



### ② USB Terminal

Access: Open the LCD panel.

## Connection Diagrams

### Connection 1

#### Type: Analog • Output only

Connect to a TV or VCR with audio/video input terminals. If the TV cannot automatically detect and change the aspect ratio ( 90), change [TV TYPE] according to the TV set (widescreen or 4:3).



STV-250N Stereo Video Cable (supplied)

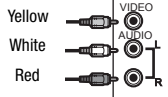

### Connection 2

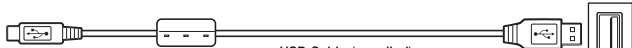

#### Type: Digital data connection

Connect to a computer to transfer and back up your recordings, to the optional DW-100 DVD Burner to create DVD discs from them, or to a printer to print out photos.



USB Cable (supplied)

## Playback on a TV Screen

Connect the camcorder to a TV to enjoy your recordings with family and friends. Before making the connection, set [AV/PHONES] to [ AV] in advance ( 90).



( 25)

### 1 Turn off the camcorder and the TV.

### 2 Connect the camcorder to the TV.

Refer to *Connection Diagrams*

( 75).

### 3 Turn on the connected TV.

On the TV, select as the video input the same terminal to which you connected the camcorder. Refer to the instruction manual of the connected TV.

### 4 Set the camcorder to mode ( 38) or mode ( 62).

Start the playback of movies or photos.

## NOTES

- We recommend powering the camcorder using the compact power adapter.
- Sound from the built-in speaker will be muted while the STV-250N Stereo Video Cable is connected to the camcorder.
- Adjust the volume using the TV.
- When you play back your 16:9 movies on standard TV sets with a 4:3 aspect ratio, the TV set will switch automatically to widescreen mode if it is compatible with the Video ID-1 system. Otherwise,

change the aspect ratio of the TV manually.



## Saving and Backing Up Your Recordings

### Backing Up Your Recordings on a Computer

Movies recorded with this camcorder are saved on the memory card or in the built-in memory (**FS22** / **FS21** / **FS20** only). Because space on the memory is limited, make sure to back up your movies onto a computer on a regular basis.

#### PIXELA ImageMixer 3 SE

With the supplied software **ImageMixer 3 SE Transfer Utility** you can save scenes in the camcorder to your computer's hard disk. On the computer, you can neatly organize all your video recordings into albums and add comments for quick and easy searches. With the supplied software **ImageMixer 3 SE Video Tools**, you can also edit scenes, convert and resize them to upload them to your Web site or to take with you on your portable video player and more. For details about the functions available, refer to the software's instruction manual (PDF file). For details about installing the software refer to **PIXELA ImageMixer 3 SE Installation Guide**.

### Saving your Recordings without a Computer

If you prefer to save your recordings without having to use a computer, you can use the optional DW-100 DVD Burner to create DVD discs of your movies and Photo DVDs of your photos (□ 77). You can also connect the camcorder to an external recording device (DVD or HDD recorder, VCR, etc.) to save copies of your movies (□ 80).

#### ! IMPORTANT

- **When the camcorder is connected to a computer:** Do not access, change or delete folders and files in the camcorder directly from the computer as this may result in permanent data loss.
- While the camcorder is connected to a computer, do not open the memory card slot cover and do not remove the memory card.

### Authoring DVD Discs and Photo DVDs

You can connect the camcorder to the optional DW-100 DVD Burner to create DVD discs from your movies or Photo DVD discs from your photos. For details about the connection and operation, refer to the instruction manual of the DW-100.

Refer to this section along with the relevant sections in the instruction manual of the DW-100.



(□ 25)



## Options for creating DVD discs

(  mode)

[ALL SCENES]
Add all the scenes to the disc(s).
[REM.SCENES]
Add only those scenes that have not been previously added to a disc.
[PLAYLIST]
Add only the scenes included in the playlist (  56).

## Options for creating Photo DVDs

(  mode)

[ALL PHOTOS]
Add all the photos to the slideshow on the disc.
[  TRANS.ORD]
Add only photos marked with transfer orders (  83).

## Preparations on the Camcorder

### 1 Set the camcorder to mode to create DVD discs of your movies or mode to create Photo DVDs of your photos.

- Power the camcorder using the compact power adapter.
- [FS22] / [FS21] / [FS20]** Select in advance the memory from which you want to add the scenes or photos (  40).

### 2 Select the scenes or photos you want to add to the disc.



- [FUNC.]  [  MENU ] 
- [  SYSTEM SETUP ] 
- [ADD TO DISC]  Desired option 
- [FUNC.]

## Connecting to the DVD Burner and Creating a Disc

### 1 Turn on the DVD burner.

**[DW-100]**  Refer to *Creating DVDs*.

### 2 Connect the camcorder to the DVD burner using the supplied USB cable.

- Connection . Refer to *Connection Diagrams* (  75) and **[DW-100]** *Connections*.
- If the device type selection screen appears, select [DVD BURNER] and press **[SET]**.
- When the connection is completed, [NO DISC] will be displayed.

### 3 Insert a brand new disc into the DVD burner.

- Use the OPEN/CLOSE button on the DVD burner to open and close the disc tray.
- After the disc is recognized, an information screen will display the type of DVD you are creating, the estimated time and number of discs it will require (based on the disc you inserted).
- If you inserted a DVD-RW disc that already contains data, [THE DISC CONTAINS DATA] will be displayed. To overwrite the data (erasing the previous content of the disc), press **[SET]**, select [YES] and press **[SET]** again.

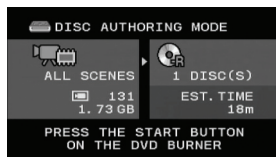



#### 4 Press the start button on the DVD burner.

- A progress bar will be displayed on the screen.
- After pressing the start button (while the current disc is being written) the operation cannot be canceled.
- When the disc (or the last disc, if the data requires multiple discs) is finalized, [TASK COMPLETED] will be displayed. Take out the disc and close the disc tray.

#### WHEN THE DATA REQUIRES MULTIPLE DISCS

After a disc is finalized it will be ejected automatically and [INSERT A NEW/ BLANK DISC AND CLOSE THE DISC TRAY] will appear. Insert the next disc and close the disc tray.

#### TO CREATE AN ADDITIONAL COPY OF THE SAME DISC

After the operation is finished, [INSERT A NEW/BLANK DISC] will be displayed again. Insert a brand new disc and close the disc tray.

#### TO PLAY BACK A DVD DISC

Discs created with this camcorder and the DVD burner can be played back on DVD players and computers that meet the following requirements:

- Compatible with the discs you created (DVD-R/DVD-R DL/DVD-RW discs)
- Compatible with DVD-Video specifications

- DVD playback software that is installed and running (in the case of computers)

Refer to the instruction manual of the external device and make sure it is compatible.

#### ! IMPORTANT

- While the camcorder is connected to the DVD burner, do not open the memory card slot cover and do not remove the memory card.
- Observe the following precautions while the ACCESS indicator on the camcorder is on or flashing. Failing to do so may result in permanent data loss.
  - Do not open the memory card slot cover.
  - Do not disconnect the USB cable.
  - Do not disconnect the power source or turn off the camcorder or the DVD burner.
- When creating discs with the optional DW-100 DVD Burner, you cannot add, using the [PLAYLIST] option, scenes recorded while the pre-recording function was on or divided scenes. To add such scenes, use the [ALL SCENES] or [REM.SCENES] option.
- For important information on handling your discs, refer to **DW-100** > *Cautions on handling*.

#### i NOTES

- The FUNC. menu and setup menus cannot be accessed while the camcorder is connected to the DVD burner.
- Disconnect the USB cable before changing the operating mode.
- The amount of time required for step 2 depends on how many scenes are being included on a disc. We recommend keeping the number of scenes to 2000

or less. (In such case, the connection time will be about 3 minutes 30 seconds).

---

## Copying your Recordings to an External Video Recorder

You can copy your recordings by connecting the camcorder to a VCR or a digital video device.



(□ 25)

---

## Connecting

Connect the camcorder to the VCR using Connection 1. Refer to *Connection Diagrams* (□ 75). Before making the connection, set [AV/ PHONES] to [AV AV] in advance (□ 90).

---

## Recording

- 1 External device: Load a blank cassette or disc and set the device to record pause mode.**
- 2 Camcorder: Locate the scene you wish to copy and pause playback shortly before the scene.**
- 3 Camcorder: Resume the movie playback.**
- 4 External device: Begin recording when the scene you wish to copy appears. Stop recording when copying is complete.**
- 5 Camcorder: Stop playback.**

---

## NOTES

- We recommend powering the camcorder using the compact power adapter.
- By default, on-screen displays will be embedded in the output video signal. You can change the displays by repeatedly pressing [DISP.] (□ 54).

---

## Transferring Photos to a Computer (Direct Transfer)

With the software supplied on the **DIGITAL VIDEO Solution Disk** CD-ROM you can transfer photos to a computer simply by pressing . Refer also to the relevant sections in the 'Digital Video Software' instruction manual (PDF file).



(□ 25)

---

## Preparations

Install the software before you connect the camcorder to the computer for the first time. (Windows users only: you also need to select CameraWindow's auto-launch setting.) After that, just connect the camcorder to the computer (steps 2 and 3) and proceed directly to transfer the photos (□ 82).

### 1 Install the supplied Digital Video Software.

Refer to the installation guide (separate leaflet included with the CD-ROM).

### 2 Set the camcorder to mode.





**FS22 / FS21 / FS20** Select in advance the memory from which you want to transfer photos (□ 40).

### 3 Connect the camcorder to the computer using the USB cable.

- Connection [2]. Refer to *Connection Diagrams* (□ 75).
- If the device type selection screen appears, select [PC/PRINTER] and press [SET].
- The direct transfer menu appears on the camcorder screen and the button lights up.

#### FIRST-TIME CONNECTION TO A COMPUTER RUNNING WINDOWS

The first time you connect the camcorder to the computer, you need also to select the CameraWindow auto-launch setting. **DVSD** Refer to *Starting CameraWindow*.

#### CONNECTION TO A COMPUTER RUNNING MAC OS

When you connect the camcorder to the computer, CameraWindow appears automatically.

**DVSD** Refer to *Downloading Still Images*.

#### ! IMPORTANT

- While the camcorder is connected to the computer, do not open the memory card slot cover and do not remove the memory card.
- Observe the following precautions while the ACCESS indicator is on or flashing. Failing to do so may result in permanent data loss.

- Do not open the memory card slot cover.
- Do not disconnect the USB cable.
- Do not turn off the camcorder or the computer.
- Do not change the operating mode.
- Operation may not work correctly depending on the software and the specifications/settings of your computer.
- If you wish to use the image files on your computer, make copies of them first. Use the copied files, retaining the originals.
- During the following operations, even if you connect the camcorder to the computer it will not be recognized.
  - Erasing all photos
  - Erasing all transfer orders
  - Erasing all print orders

#### i NOTES

- We recommend powering the camcorder using the compact power adapter.
- Refer also to the computer's instruction manual.
- **Users of Windows Vista, Windows XP and Mac OS X:** Your camcorder is equipped with the standard Picture Transfer Protocol (PTP) allowing you to transfer photos (JPEG only) simply by connecting the camcorder to a computer using the USB cable without having to install the supplied software.
- If you have no intention to use the optional DW-100 DVD Burner, you can set [USB SETTING] to [ PC/PRINTER] (□ 90) so the selection screen does not appear every time you connect the camcorder to a computer.
- Depending on the number of photos on the memory card (Windows: 1,800 photos or more; Macintosh: 1,000 photos or more), you may not be able to

transfer photos to a computer. Try using a card reader.

- Disconnect the USB cable before changing the operating mode.

## Transferring Photos



( 25)

### Automatic Transfer Options

All the relevant photos will be transferred to the computer in one batch and their thumbnails will be displayed on the computer.

[  ALL PHOTOS ]
Transfers all photos.
[  NEW PHOTOS ]
Transfers only those photos that have not yet been transferred to the computer.
[  TRANSFER ORDERS ]
Transfers photos marked with transfer orders ( 83).

### Manual Transfer Options

You can select the photo(s) to transfer.

[  SELECT & TRANSFER ]
Select the photo(s) to transfer.
[  WALLPAPER ]
Select a photo and set it as your computer's desktop background.

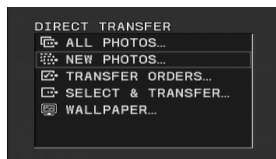
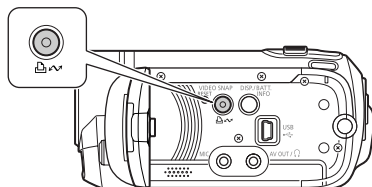

### AUTOMATIC TRANSFER OPTIONS

Select ( ) a transfer option and press .

- The camcorder returns to the transfer menu once the transfer is completed.
- To cancel the transfer, select ( ) [CANCEL] and press , or press .

### MANUAL TRANSFER OPTIONS

- 1 Select ( ) a transfer option and press .
- 2 Select ( ) the photo you wish to transfer and press .
  - [ SELECT & TRANSFER ]: Repeat this step to select other photos to transfer.
  - The button will flash while the photos are being transferred.
- 3 Press to return to the transfer menu.



## **i** NOTES

When the camcorder is connected to the computer and the photo selection screen is displayed, press **[FUNC.]** to return to the transfer menu.

---

## Transfer Orders

You can mark in advance the photos you want to transfer to the computer as transfer orders. You can set transfer orders for up to 998 photos.



## Selecting Photos to Transfer (Transfer Order)

Set the transfer orders before connecting the camcorder to the computer.

**[FS22]** / **[FS21]** / **[FS20]** Select in advance the memory from which you want to transfer photos ( 40).

## Marking Single Photos with Transfer Orders

- 1 Open the photo selection screen.**  
**[FUNC.]** **[TRANSFER ORDER]**  
 appears on the screen.
- 2 Select (◀▶) the photo you want to mark with a transfer order.**
- 3 Press (SET) to set the transfer order.**  
A checkmark ✓ appears in the box next to the transfer order icon .  
Press (SET) again to cancel the transfer order.

- 4 Repeat steps 2-3 to mark additional photos with transfer orders or press **[FUNC.]** twice to close the menu.**

## Setting Transfer Orders from the Index Screen

### Options

#### [INDIVIDUAL PHOTOS]

Opens the same screen described in *Marking Single Photos with Transfer Orders* ( 83). Continue from step 3 of that procedure to set the transfer order.

#### [SELECTED PHOTOS]

Marks all the photos selected in advance (marked with a ✓ checkmark) with a transfer order. Refer to *Pre-selecting Recordings from the Index Screen* ( 42).

#### [REMOVE ALL]

Removes all the transfer orders.

**[FUNC.]**

**[TRANSFER ORDER]**

Desired option **[YES]** **[OK]**

**[FUNC.]**

## TO TRANSFER PHOTOS MARKED WITH TRANSFER ORDERS

Connect the camcorder to the computer and select **[TRANSFER ORDERS]** in the transfer menu ( 82).



# Additional Information

This chapter contains troubleshooting advice, screen messages, handling and maintenance tips, and other information.

## Appendix: Menu Options Lists

Menu items not available appear grayed out in the FUNC. menu or in black in the setup menus. For details about how to select an item, refer to *Using the Menus* (□ 27). For details about each function, see the reference page. Menu options without a reference page are explained below the tables.

### FUNC. Menu (Recording Modes)

Menu item	Setting options			
Recording programs	[PROGRAM AE], [SHUTTER-PRIO.AE]	●	●	45
	[PORTRAIT], [SPORTS], [NIGHT], [SNOW], [BEACH], [SUNSET], [SPOTLIGHT], [FIREWORKS]	●	●	44
White balance	[AUTO], [DAYLIGHT], [TUNGSTEN], [SET]	●	●	51
Image effects	[OFF IMAGE EFFECT OFF], [VIVID], [NEUTRAL], [SOFT SKIN DETAIL]	●	●	52
Digital effects	[D.EFFECT OFF], [FADE-T], [WIPE], [BLK&WHT], [SEPIA], [ART], [MOSAIC]	●	–	53
	[D.EFFECT OFF], [BLK&WHT], [SEPIA]	–	●	
<b>FS22</b> / <b>FS21</b> / <b>FS20</b> Drive mode	[SINGLE], [CONT.SHOOT.], [HISPEED CONT.SHOOT.], [AEB]	–	●	66
Recording mode	[XP HIGH QUALITY 9Mbps], [SP STANDARD PLAY 6Mbps], [LP LONG PLAY 3Mbps]	●	–	35
Photos size/quality	<b>FS22</b> / <b>FS21</b> / <b>FS20</b> [LW 1152x648], [L 1152x864], [S 640x480]	–	●	60
	<b>FS200</b> [L 1024x768], [S 640x480] ----- [SUPER FINE], [FINE], [NORMAL]			

## FUNC. Menu (Playback Modes)

Menu item	Setting options			
[SELECT MUSIC]	[OFF], list of music files in the camcorder	● <sup>1</sup>	●	47
[SELECT]	[INDIVIDUAL SCENES], [REMOVE ALL SELECTIONS], [CANCEL]	● <sup>2</sup>	–	42
	From the index screen: [INDIVIDUAL PHOTOS], [REMOVE ALL SELECTIONS], [CANCEL]	–	●	42
<b>[FS22] / [FS21] / [FS20]</b> [COPY]	[ALL SCENES], [ALL SCENES (THIS DATE)], [ONE SCENE], [SELECTED SCENES], [CANCEL]	● <sup>2</sup>	–	58
	[NO], [YES]	● <sup>3</sup>	–	59
	From single photo view: [NO], [YES]	–	●	68
	From the index screen: [ALL PHOTOS], [ONE PHOTO], [SELECTED PHOTOS], [CANCEL]	–	●	68
[ADD TO PLAYLIST] <sup>2</sup>	[ALL SCENES (THIS DATE)], [ONE SCENE], [SELECTED SCENES], [CANCEL]	●	–	56
[DIVIDE] <sup>4</sup>	–	●	–	56
[MOVE] <sup>3</sup>	–	●	–	58
[PROTECT]	From single photo view: - From the index screen: [INDIVIDUAL PHOTOS], [SELECTED PHOTOS], [REMOVE ALL SELECTIONS], [CANCEL]	–	●	67
[PRINT ORDER]	From single photo view: 0-99 copies From the index screen: [INDIVIDUAL PHOTOS], [SELECTED PHOTOS(1 COPY)], [REMOVE ALL], [CANCEL]	–	●	72
[TRANSFER ORDER]	From single photo view: - From the index screen: [INDIVIDUAL PHOTOS], [SELECTED PHOTOS], [REMOVE ALL], [CANCEL]	–	●	83

Menu item	Setting options			
[DELETE]	[ALL SCENES], [ALL SCENES (THIS DATE)], [ONE SCENE], [SELECTED SCENES], [CANCEL]	● <sup>2</sup>	–	43
	[ALL SCENES], [ONE SCENE], [CANCEL]	● <sup>3</sup>	–	57
	From single photo view: [NO], [YES] From the index screen: [ALL PHOTOS], [ONE PHOTO], [SELECTED PHOTOS], [CANCEL]	–	●	65
[SCENE SEARCH] <sup>2</sup>	[CALENDAR], [SELECT DATE], [CANCEL]	●	–	40

<sup>1</sup> Option not available from the original movies index screen.

<sup>2</sup> Option available from the original movies index screen and Video Snapshot index screen.

<sup>3</sup> Option available from the playlist index screen and Video Snapshot playlist index screen.

<sup>4</sup> Option available from the original movies index screen.

## CAMERA SETUP

Menu item	Setting options			
[SELF TIMER]	[ ON ON  ], [ OFF OFF ]	●	●	49
[ZOOM TYPE]	[ 37x OPTICAL ], [ 48x ADVANCED ] <sup>1</sup> , [ 2000x DIGITAL ]	●	–	36
[ZOOM SPEED]	[ VAR VARIABLE ], [ >>> SPEED 3 ], [ >>> SPEED 2 ], [ > SPEED 1 ]	●	●	35
[IMG STAB]	[ ON ON  ], [ OFF OFF ]	●	–	–
[WIDESCREEN]	[ ON ON ], [ OFF OFF ]	●	–	–
[FOCUS PRI.]	[ AiAF ON: AiAF ], [  ON: CENTER ], [ OFF OFF ]	–	●	–
[A.SL SHUTTER] <sup>2</sup>	[ ON ON ], [ OFF OFF ]	●	●	–
[WIND SCREEN]	[ A AUTO ], [ OFF OFF  ]	●	–	–
[REVIEW] <sup>3</sup>	[ OFF OFF ], [ 2sec 2 sec ], [ 4sec 4 sec ], [ 6sec 6 sec ], [ 8sec 8 sec ], [ 10sec 10 sec ]	–	●	–

<sup>1</sup> [ 55x ADVANCED ] when [ WIDESCREEN ] is set to [ OFF OFF ]. **FS200** The default setting is [ 41x ADVANCED ].

<sup>2</sup> Option available only when the recording program is set to [ P PROGRAM AE ].

<sup>3</sup> **FS22** / **FS21** / **FS20** Option available only when the drive mode is set to [ SINGLE ].

**[IMG STAB]:** The image stabilizer compensates for camcorder shake even at full telephoto.

- The image stabilizer is designed to compensate for a normal degree of camcorder shake. **FS200** The image stabilizer may not be able to successfully eliminate all blur if the camcorder or the subject is moving too much.
- **FS200** The image stabilizer may not work well on subjects with low contrast, with a recurring, repetitive pattern or without vertical lines.



- We recommend setting the image stabilizer to [OFF OFF] when using a tripod.

**[WIDESCREEN]:** The camcorder uses the full width of the image sensor providing high-resolution 16:9 recordings.

- Since the screen on the camcorder has an aspect ratio of 16:9, recordings with a 4:3 aspect ratio will appear in the center of the screen with black sidebars.
- **Playing back a widescreen recording:** TV sets compatible with the Video ID-1 system will automatically switch to wide (16:9) mode. Otherwise, change the aspect ratio of the TV manually. To play back on a TV with normal aspect ratio (4:3) change the [TV TYPE] setting accordingly (□ 90).
- The camcorder retains the last setting used even if you set the camcorder to mode.

**[FOCUS PRI.]:** When the focus priority is activated, the camcorder records a photo only after the focus has been adjusted automatically. You can also select which AF frames to use.

[ ON:AiAF]: One or more AF frames out of the nine frames available are automatically selected and the focus is fixed on them.

[ ON:CENTER]: A single focusing frame appears in the center of the screen and the focus is automatically fixed on it.

[OFF OFF]: No AF frame will appear and the photo will be recorded immediately after you press .

- When the recording program is set to [ FIREWORKS], focus priority is automatically set to [OFF OFF].

**[A.SL SHUTTER]:** The camcorder automatically uses slow shutter speeds to obtain brighter recordings in places with insufficient lighting.

- The camcorder uses shutter speeds down to 1/30 (1/15 in mode).
- The setting can be changed when the camcorder is set to or mode. The camcorder retains the last setting used even if you set the camcorder to mode.
- If a trailing afterimage appears, set the slow shutter to [OFF OFF].
- If (camcorder shake warning) appears, we recommend stabilizing the camcorder, for example, by mounting it on a tripod.





**[WIND SCREEN]:** The camcorder automatically reduces the background sound of wind when recording outdoors.

- Some low-frequency sounds will be suppressed along with the sound of wind. When recording in surroundings unaffected by wind or if you want to record low-frequency sounds, we recommend setting the wind screen to [OFF OFF ].

**[REVIEW]:** Selects the time to display a photo after it has been recorded to the memory.

- If you press while reviewing a photo it will continue to be displayed indefinitely. Press halfway to return to the normal display.

 MEMORY OPER.







Menu item	Setting options					
<b>FS22 / FS21 / FS20</b> [MEMORY INFO]	—	●	●	●	●	—
[CARD INFO]	—	●	●	●	●	—
<b>FS22 / FS21 / FS20</b> [MEDIA:MOVIES]	[BUILT-IN MEM], [CARD]	●	●	—	—	32
<b>FS22 / FS21 / FS20</b> [MEDIA:PHOTOS]	[BUILT-IN MEM], [CARD]	●	●	—	—	32
[INITIALIZE]	[BUILT-IN MEM], [CARD], [CANCEL] [INITIALIZE], [COMPL.INIT.], [CANCEL]	●	●	●*	●	32

\* Option available from the original movies index screen and Video Snapshot index screen.

**[MEMORY INFO]/[CARD INFO]:** Displays a screen where you can verify how much of the built-in memory (**FS22 / FS21 / FS20** only) or the memory card is currently in use (total recording time and total number of photos) and approximately how much memory remains available for recording.

- Estimated figures about available movie recording time and available number of photos are approximate and based on the recording mode and photo quality/size settings currently in use.
- In the [CARD INFO] screen you can also verify the Speed Class of the memory card.
- The maximum number of remaining photos displayed on the screen is 99999.

 DISPLAY SETUP

Menu item	Setting options					
[BRIGHTNESS]		●	●	●	●	—
[LCD DIMMER]	[ ON ON], [ OFF OFF]	●	●	●	●	—
[AUDIO LEVEL]	[ ON ON], [ OFF OFF]	●	—	—	—	—
[TV SCREEN]	[ ON ON], [ OFF OFF]	●	●	—	—	—
[DATA CODE]	[ DATE], [ TIME], [ DATE & TIME], [ CAMERA DATA]	—	—	●	—	—
[MARKERS]	[ OFF OFF], [ LEVEL(WHT)], [ LEVEL(GRY)], [ GRID(WHT)], [ GRID(GRY)]	●	●	—	—	—





Menu item	Setting options					
[LANGUAGE	[ČEŠTINA],[DEUTSCH],[ΕΛΛΗΝΙΚΑ] [ENGLISH],[ESPAÑOL],[FRANÇAIS], [ITALIANO],[MAGYAR],[MELAYU], [NEDERLANDS],[POLSKI],[PORTUGUÊS], [ROMÂNĂ],[TÜRKÇE],[РУССКИЙ], [УКРАЇНСЬКА],[العربية],[فارسی], [ภาษาไทย],[简体中文],[繁體中文], [한국어],[日本語]	●	●	●	●	29
[START WEEK]	[SATURDAY],[SUNDAY],[MONDAY]	–	–	●	–	–
[DEMO MODE]	[ON ON],[OFF OFF]	●	●	–	–	–

**[BRIGHTNESS]:** Adjusts the brightness of the LCD screen.

- Changing the brightness of the LCD screen does not affect the brightness of your recordings or that of the playback image on a TV.

**[LCD DIMMER]:** When set to [ON ON], this function dims the LCD screen. Doing so is ideal when using the camcorder in environments where the LCD's illumination could be an annoyance.

- To turn off the LCD screen dimmer, change this setting to [OFF OFF] or press **[DISP.]** for 2 seconds or more.
- Dimming the LCD screen does not affect the brightness of your recordings or that of the playback image on a TV.
- When the LCD screen dimmer is turned off, the screen's brightness returns to the previous setting.

**[AUDIO LEVEL]:** Displays the audio level indicator on the LCD screen so you can check the audio recording level while recording.

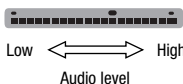

## [TV SCREEN]

- When set to [ON ON], the camcorder's on-screen displays will appear also on the screen of a TV or monitor connected using the STV-250N Stereo Video Cable.

**[DATA CODE]:** Displays the date and/or time when the scene was recorded.

**[CAMERA DATA]:** Displays the aperture (f-stop) and shutter speed used when recording.

**[MARKERS]:** You can display a grid or a horizontal line at the center of the screen. Use the markers as a reference to make sure your subject is framed correctly (vertically and/or horizontally).

















- Using the markers will not affect the recordings.





**[START WEEK]:** Select the day on which the week starts for the calendar display ( 40).

**[DEMO MODE]:** The demonstration mode displays the camcorder's main features. It starts automatically when the camcorder is powered with the compact power adapter if you leave it turned on for more than 5 minutes.

- To cancel the demo mode once it has started, press any button or turn off the camcorder.

## SYSTEM SETUP

Menu item	Setting options					
[BATTERY INFO]	–	●	●	●	●	–
<b>FS22</b> [WL.REMOTE]	[ <b>ON ON</b> ], [ <b>OFF OFF</b> (OFF) ]	●	●	●	●	–
[BEEP]	[  <b>HIGH VOLUME</b> ], [  <b>LOW VOLUME</b> ], [ <b>OFF OFF</b> ]	●	●	●	●	–
[POWER SAVE]	[ <b>ON ON</b> ], [ <b>OFF OFF</b> ]	●	●	●	●	–
[QUICK START]	[ <b>OFF OFF</b> ], [ <b>10min 10 min</b> ], [ <b>20min 20 min</b> ], [ <b>30min 30 min</b> ]	●	●	–	–	–
[AV/PHONES]	[ <b>AV AV</b> ], [  <b>PHONES</b> ]	●	●	●	●	55
[PHONES VOL.]		●	●	●	●	55
[SPEAKER VOL.]		–	–	●	●	–
[TV TYPE]	[ <b>4:3 NORMAL TV</b> ], [ <b>16:9 WIDE TV</b> ]	–	–	●	●	–
[USB SETTING]	[  <b>DVD BURNER</b> ], [  <b>PC/PRINTER</b> ], [  <b>CONNECT&amp;SET</b> ]	–	–	●	●	–
[ADD TO DISC]	[ <b>ALL SCENES</b> ], [ <b>REM.SCENES</b> ], [ <b>PLAYLIST</b> ]	–	–	●	–	77
	[ <b>ALL PHOTOS</b> ], [  <b>TRANS.ORD</b> ]	–	–	–	●	77
[PHOTO NOS.]	[  <b>RESET</b> ], [  <b>CONTINUOUS</b> ]	–	●	–	●	–
[FIRMWARE]	–	–	–	–	●	–

**[BATTERY INFO]:** Displays a screen where you can verify the battery charge (as a percentage) and the remaining recording time (,  mode) or playback time (,  mode).

**[WL.REMOTE]:** Allows the camcorder to be operated with the wireless controller.

**[BEEP]:** A beep will accompany some operations like turning on the camcorder, the self-timer countdown, etc.

**[POWER SAVE]:** In order to save power when the camcorder is powered by a battery pack, it will automatically shut off if left without any operation for 5 minutes.

- Approximately 30 seconds before the camcorder shuts off, [AUTO POWER OFF] will appear.



- In standby mode, the camcorder will shut off after the time selected for the [QUICK START] setting.
- The Power Save mode cannot be set while the compact power adapter is connected to the camcorder.

**[QUICK START]:** Select whether to activate the Quick Start function (□ 37) when you close the LCD panel in a recording mode and the length of time after which the camcorder will end the standby mode and shut off automatically.

**[SPEAKER VOL.]:** Adjust (◀▶) the volume of the playback. You can also adjust the volume using the joystick guide (□ 38).

**[TV TYPE]:** In order to display the picture in full and in the correct aspect ratio, select the setting according to the type of television to which you will connect the camcorder.

[4:3 NORMAL TV]: TV sets with 4:3 aspect ratio.

[16:9 WIDE TV]: TV sets with 16:9 aspect ratio.

- When the TV type is set to [4:3 NORMAL TV], the picture displayed on the LCD screen will be smaller than the full display area.

**[USB SETTING]:** Select the connection protocol to use when connecting the camcorder to an external device using the USB cable.

[DVD BURNER]: To connect exclusively to the optional DW-100 DVD Burner.

[PC/PRINTER]: To connect to a computer, a printer or similar USB peripherals.

[CONNECT&SET]: To make the selection from a screen that appears at the time of the connection to the external device.

**[PHOTO NOS.]:** Select the photo numbering method to be used on a new memory card. Photos are automatically assigned consecutive photo numbers from 0101 to 9900, and stored in folders containing up to 100 photos. Folders are numbered from 101 to 998.





[RESET]: Photo numbers will restart from 101-0101 every time you insert a new memory card.

[CONTINUOUS]: Photo numbers will continue from the number following that of the last photo recorded with the camcorder.

- If the memory card you insert already contains a photo with a larger number, a new photo will be assigned a number one higher than that of the last photo on the memory card.
- We recommend using the [CONTINUOUS] setting.

**[FIRMWARE]:** You can verify the current version of the camcorder's firmware. This menu option is usually unavailable.

 DATE/TIME SETUP

Menu item	Setting options					
[T.ZONE/DST]	List of world time zones.	●	●	●	●	29
[DATE/TIME]	–	●	●	●	●	28
[DATE FORMAT]	[Y.M.D (2009.1.1 AM 12:00)], <b>[M.D,Y (JAN. 1, 2009 12:00 AM)],</b> [D.M.Y (1.JAN.2009 12:00 AM)]	●	●	●	●	–

**[DATE FORMAT]:** Select the date format to be used for most on-screen displays, and (if selected) for the date printed on photos.



## Troubleshooting

If you have a problem with your camcorder, refer to this section. Sometimes what you think is a malfunction of the camcorder may have the simplest of solutions - please read the “CHECK THIS FIRST” box before going on to the more detailed problems and solutions. Consult your dealer or a Canon Service Center if the problem persists.

### CHECK THIS FIRST

#### Power supply

Is the battery charged? Is the compact power adapter correctly connected to the camcorder? (□ 19)

#### Recording

Did you turn the camcorder on and set it to recording mode? (□ 25)

If you are recording to a memory card, is one correctly inserted into the camcorder? (□ 31)

#### Playback

Did you turn the camcorder on and set it to playback mode? (□ 25)

If you are playing back recordings from a memory card, is one correctly inserted into the camcorder? (□ 31) Does it contain any recordings?

### Power source

**The camcorder will not turn on or it turns off by itself.**

- The battery pack is exhausted. Replace or charge the battery pack (□ 19).
- Remove the battery pack and reattach it correctly.

**Cannot charge the battery pack**

- The battery pack's temperature has either fallen below 0 °C (32 °F) or risen above 40 °C (100 °F). If the battery pack is too cold, warm it up. If the battery pack is too hot, let it cool down until its temperature is below 40 °C (100 °F).
- Charge the battery pack in temperatures between 0 °C and 40 °C (32 °F and 104 °F).
- The battery pack is damaged. Use a different battery pack.
- The camcorder cannot communicate with the battery pack attached. Such battery packs cannot be charged using this camcorder.

**A noise can be heard from the compact power adapter.**

- A faint sound can be heard while the compact power adapter is connected to a power outlet. This is not a malfunction.

**After using the camcorder for a long time, it becomes hot.**

- The camcorder may become hot after using it continuously for long periods of time; this is not a malfunction. If it becomes hot very quickly or it becomes too hot to touch, it may indicate a problem with the camcorder. Consult a Canon Service Center.

**The battery pack is exhausted extremely quickly even at normal temperatures.**

- The battery may have reached the end of its battery life. Buy a new battery pack.

## Recording

---

**Pressing Start/Stop will not start recording.**

- You cannot record while the camcorder is writing previous recording onto the memory (while the ACCESS indicator is on or flashing).
- The memory is full or it already contains 3,999 scenes (the maximum number of scenes). Delete some recordings (□□ 43) or initialize the memory (□□ 32) to free some space.

**The point where Start/Stop was pressed does not match the beginning/end of the recording.**

- There is a slight interval between pressing Start/Stop and the actual start of recording. This is not a malfunction.
- When the pre-recording function is used, the beginning of the scene will differ from when Start/Stop was pressed.

**The camcorder will not focus.**

- Autofocus does not work on the subject. Focus manually (□□ 51).
- Lens is dirty. Clean the lens with a soft lens-cleaning cloth (□□ 108). Never use tissue paper to clean the lens.

**A vertical light bar appears on the screen.**

- Bright light in a dark scene may cause a vertical light bar (smear) to appear. This is not a malfunction.

**Changing the operating mode between recording (●)/record pause (●|||)/playback (▶) takes longer than usual.**

- When the memory contains a large number of scenes, some operations may take longer than usual. Back up your recordings (□□ 77) and initialize the memory (□□ 32).

**Movies or photos cannot be recorded properly.**

- This may occur as movies and photos are recorded/deleted over time. Back up your recordings (□□ 77) and initialize the memory (□□ 32).

## Playback

---

**Cannot add scenes to the playlist.**

- The playlist cannot contain more than 99 scenes or 100 hours of scenes.
- You may not be able to add scenes to the playlist if they were recorded or edited using another device.

**Cannot delete a scene.**

- You may not be able to delete scenes recorded or edited using another device.

**Deleting scenes takes longer than usual.**

- When the memory contains a large number of scenes, some operations may take longer than usual. Back up your recordings (□□ 77) and initialize the memory (□□ 32).



#### Cannot erase a photo

- The photo is protected. Remove the protection (□ 67).

#### Cannot play back a music track.

- If the music tracks were erased when the memory was initialized, use the supplied software **Music Transfer Utility** to transfer the music files on the supplied **Instruction Manual/Music Data Disc** CD-ROM. For details, refer to the software's instruction manual (PDF file).

#### When playing back recordings combined with music, the video and audio do not play back correctly (playback skips or stops).

- This occurs when music files are transferred and there is not enough available space in the memory (about 5 times more than the size of the music files). Make sure there is enough space and then transfer the music files again.

#### When playing a slideshow, it takes longer than usual for the photos to advance or there are brief stops in the audio.

- This may occur when using a memory card with no Speed Class rating or playing back photos recorded with another device. Play back photos taken with this camcorder from a memory card rated Speed Class 2 or higher.

## Indicators and Onscreen Displays

---

#### lights up in red.

- Battery pack is exhausted. Replace or charge the battery pack (□ 19).

#### appears on the screen.

- The camcorder cannot communicate with the battery pack attached so the remaining battery time cannot be displayed.

#### lights up in red.

- A memory card error occurred. Turn off the camcorder. Remove and reinsert the memory card. Initialize the memory card (□ 32) if the display does not change back to normal.
- The memory card is full. Replace the memory card or delete some recordings (□ 43, 65) to free some space on the memory card.

#### The ON/OFF(CHG) (power/charge) indicator flashes rapidly while the camcorder is charging.

-  (one flash at 0.5-second intervals)  
Charging has stopped because the compact power adapter or the battery pack is faulty. Consult a Canon Service Center.

#### The ON/OFF(CHG) (power/charge) indicator flashes very slowly while the camcorder is charging.

-  (one flash at 2-second intervals)  
The battery pack's temperature has either fallen below 0 °C (32 °F) or risen above 40 °C (100 °F). If the battery pack is too cold, warm it up. If the battery pack is too hot, let it cool down until its temperature is below 40 °C (100 °F).
- Charge the battery pack in temperatures between 0 °C and 40 °C (32 °F and 104 °F).
- The battery pack is damaged. Use a different battery pack.

## Picture and Sound

---

### The LCD screen appears dim.

- The LCD screen dimmer is on. To turn it off, press **[DISP.]** for 2 seconds or more.

### Screen displays turn on and off repeatedly.

- The battery pack is exhausted. Replace or charge the battery pack (□ 19).
- Remove the battery pack and reattach it correctly.

### Abnormal characters appear on the screen and the camcorder does not operate properly.

- Disconnect the power source and reconnect it after a short time. If the problem still persists, disconnect the power source and press the RESET button with a pointed item. Pressing the RESET button resets all settings.

### Video noise appears on screen.

- When using the camcorder close to devices that emit strong electromagnetic fields (plasma TVs, cellular phones, etc.), keep a distance between the camcorder and these devices.

### Sound is distorted or is recorded at lower levels.

- When recording near loud sounds (such as fireworks, shows or concerts), sound may become distorted or it may not be recorded at the actual levels. This is not a malfunction.

### The picture is displayed correctly but there is no sound from the built-in speaker.

- Speaker volume is turned off. Adjust the volume (□ 38).
- If the STV-250N Stereo Video Cable is connected to the camcorder, disconnect it.
- [AV/PHONES] is set to [🔊 PHONES]. Change it to [📺 AV] (□ 90).

## Memory Card and Accessories

---

### Cannot insert the memory card.

- The memory card was not facing the correct direction. Turn the memory card over and insert it (□ 31).

### Cannot record on the memory card.

- The memory card is full. Erase some recordings to free some space or replace the memory card.
- Initialize the memory card (□ 32) when you use it with the camcorder for the first time.
- The LOCK switch on the SD or SDHC memory card is set to prevent accidental erasure. Change the position of the LOCK switch.
- In order to record movies, a compatible memory card must be inserted (□ 31).
- The folder and file numbers have reached their maximum value. Set [PHOTO NOS.] to [RESET] (□ 90) and insert a new memory card.
- The camcorder may not be able to record on a memory card that was recorded on with another device.

### **FS22** The wireless controller will not work.

- Set [WL.REMOTE] to [ON].
- Replace the battery of the wireless controller.





## Connections with External Devices

---

### Video noise appears on the TV screen.

- When using the camcorder in a room where a TV is located, keep a distance between the compact power adapter and the power or antenna cables of the TV.

### Playback looks fine on the camcorder but there is no image on the TV screen.

- The video input on the TV is not set to the video terminal to which you connected the camcorder. Select the correct video input.

### The computer doesn't recognize the camcorder even though the camcorder is connected correctly.

- [USB SETTING] is set to [DVD BURNER]. Set it to [PC/PRINTER] or to [CONNECT&SET] (□ 90).
- Disconnect the USB cable and turn off the camcorder. After a short while, turn it on again and restore the connection.

### The printer is not working even though the camcorder and printer are connected correctly.

- [USB SETTING] is set to [DVD BURNER]. Set it to [PC/PRINTER] or to [CONNECT&SET] (□ 90).
- Disconnect the USB cable. Turn the printer off and then on again and restore the connection.

### The camcorder doesn't recognize the DW-100 DVD Burner even though it is connected correctly.

- [USB SETTING] is set to [PC/PRINTER]. Set it to [DVD BURNER] or to [CONNECT&SET] (□ 90).

---

## List of Messages (in alphabetical order)

Following the list of messages for the camcorder you can find separate lists for printing-related messages (□ 103) and for messages that appear only when using the optional DW-100 DVD Burner (□ 102).

### ACCESSING THE CARD DO NOT REMOVE THE CARD

- You opened the memory card slot cover while the camcorder was accessing the memory card or the camcorder started accessing the memory card as you opened the memory card slot cover. Do not remove the memory card until this message disappears.

### BACK UP RECORDINGS REGULARLY

- This message may appear when you turn on the camcorder. In the event of a malfunction, recordings may be lost so back up your recordings regularly (□ 77).

### BUFFER OVERFLOW RECORDING WAS STOPPED

- The data transfer rate was too high for the memory card in use and the recording was stopped. Replace the memory card with one rated Speed Class 2 or higher.



### **FS22** / **FS21** / **FS20** BUILT-IN MEM INITIALIZE USING ONLY THE CAMCORDER

- There is a problem that prevents accessing the built-in memory. Initialize the built-in memory with this camcorder (□ 32).

### **FS22** / **FS21** / **FS20** BUILT-IN MEMORY ERROR

- The built-in memory could not be read. This may indicate a problem with the camcorder. Consult a Canon Service Center.

**FS22 / FS21 / FS20 BUILT-IN MEMORY FULL**

- The built-in memory is full ([] END] appears on the screen). Delete some recordings ([] 43, 65) to free some space.

**FS22 / FS21 / FS20 CANNOT ACCESS THE BUILT-IN MEMORY**

- There is a problem with the built-in memory.



**CANNOT COMMUNICATE WITH THE BATTERY PACK CONTINUE USING THIS BATTERY PACK?**

- You attached a battery pack that is not recommended by Canon for use with this camcorder.

**FS22 / FS21 / FS20 CANNOT COPY**

- The total size of the scenes you selected to copy exceeds the available space on the memory card. Delete some recordings on the memory card ([] 43, 65) or reduce the number of scenes to copy.

**CANNOT DIVIDE THE SCENE. INITIALIZE ONLY USING THE CAMCORDER.**

- The scene could not be divided because data could not be added to the camcorder's file management data. Back up the recordings ([] 77) and initialize the memory ([] 32).

**CANNOT EDIT**

- Cannot move or delete original scenes or scenes in the playlist.

**CANNOT EDIT CHECK THE CARD**

- The memory card in the camcorder was initialized using a computer. Initialize the memory card with this camcorder ([] 32).

**CANNOT ENTER THE STANDBY MODE NOW**

- The camcorder cannot enter the standby mode if the remaining battery charge is too low.

**CANNOT PLAY BACK**

- There is a problem with the memory.

**FS22 / FS21 / FS20 CANNOT PLAY BACK CANNOT ACCESS THE BUILT-IN MEMORY**

- There is a problem with the built-in memory.

**CANNOT PLAY BACK CHECK THE CARD**

- There is a problem with the memory card.

**FS22 / FS21 / FS20 CANNOT PLAY THE MOVIES IN THE BUILT-IN MEMORY INITIALIZE USING ONLY THE CAMCORDER**

- The camcorder's built-in memory was initialized using a computer. Initialize the built-in memory with this camcorder ([] 32).

**CANNOT PLAY THE MOVIES ON THIS CARD**

- Movies cannot be played back from a memory card with a capacity of 64 MB or less.

**CANNOT PLAY THE MOVIES ON THIS CARD INITIALIZE USING ONLY THE CAMCORDER**

- The memory card in the camcorder was initialized using a computer. Initialize the memory card with this camcorder ([] 32).

**CANNOT RECORD**

- There is a problem with the memory.

**FS22 / FS21 / FS20 CANNOT RECORD CANNOT ACCESS THE BUILT-IN MEMORY**

- There is a problem with the built-in memory.



#### **CANNOT RECORD CHECK THE CARD**

- There is a problem with the memory card.

#### **FS22 / FS21 / FS20 CANNOT RECORD MOVIES IN THE BUILT-IN MEMORY INITIALIZE USING ONLY THE CAMCORDER**

- The camcorder's built-in memory was initialized using a computer. Initialize the built-in memory with this camcorder (□ 32).

#### **CANNOT RECORD MOVIES ON THIS CARD**

- Movies cannot be recorded on a memory card with a capacity of 64 MB or less.

#### **CANNOT RECORD MOVIES ON THIS CARD INITIALIZE USING ONLY THE CAMCORDER**

- The memory card in the camcorder was initialized using a computer. Initialize the memory card with this camcorder (□ 32).

#### **CARD FULL**

- The memory card is full. Erase some recordings (□ 43, 65) to free some space or replace the memory card.

#### **FS22 / FS21 / FS20 CARD REACHED THE MAXIMUM NUMBER OF SCENES**

- The memory card already contains 3,999 scenes (the maximum number of scenes); no further scenes can be copied onto the memory card. Delete some recordings (□ 43) to free some space.

#### **CARD UNABLE TO RECOGNIZE THE DATA**

- The memory card contains scenes recorded in a different television system (PAL or SECAM).

#### **CHANGE THE BATTERY PACK**

- Battery pack is exhausted. Replace or charge the battery pack (□ 19).

#### **CHECK THE CARD**

- Cannot access the memory card. Check the memory card and make sure it is inserted correctly (□ 31).
- A memory card error occurred. The camcorder cannot record or display the image.
- If after the message disappears, □ appears in red, perform the following: Turn off the camcorder and remove and reinsert the memory card. If □ turns back to green you can resume recording/playback.
- Initialize the memory card (□ 32). (Doing so will erase all the recordings on the memory card.)

#### **CONNECT THE COMPACT POWER ADAPTER**

- When the camcorder is in  mode and is connected to the computer, this message will appear if the camcorder is being powered by the battery pack. Connect the compact power adapter to the camcorder.

#### **COULD NOT ADD TO PLAYLIST**

- The playlist cannot contain more than 100 hours of scenes.

#### **CARD INITIALIZE USING ONLY THE CAMCORDER**

- There is a problem that prevents accessing the memory card. Initialize the memory card with this camcorder (□ 32).

#### **LCD SCREEN HAS BEEN DIMMED**

- Hold  pressed down for 2 seconds or more.

#### **MAY NOT BE POSSIBLE TO RECORD MOVIES ON THIS CARD**

- You may not be able to record movies on a memory card without a Speed Class rating. Replace the memory card with one rated Speed Class 2 or higher.

**NAMING ERROR**

- The folder and file numbers have reached their maximum value. Set [PHOTO NOS.] to [RESET] (□ 90) and erase all the photos on the memory card or initialize it.

**NEED TO RECOVER FILES FROM THE CARD. CHANGE THE POSITION OF THE CARD'S LOCK SWITCH.**

- This message will appear the next time you turn on the camcorder if power supply was accidentally interrupted while the camcorder was writing to the memory card and later the position of the card's LOCK switch was changed to prevent erasure. Change the position of the LOCK switch.

**NO CARD**

- There is no memory card in the camcorder.

**NO PHOTOS**

- There are no photos to play back.

**NO SCENES**

- There are no scenes recorded in the memory selected.

**NOT AVAILABLE IN DUAL SHOT**

- You pressed a button that cannot be used in  mode. Turn the camera mode dial to a flexible recording mode (  or  ).

**NOT ENOUGH AVAILABLE SPACE CANNOT DIVIDE THE SCENE**

- The scene could not be divided because there was not enough available space in the memory. Delete some scenes (□ 43).

**PLAYLIST IS FULL. CANNOT DIVIDE THE SCENE.**

- Scene could not be divided. The playlist cannot contain more than 99 scenes. Delete some scenes (□ 43).

 **PRINT ORDER ERROR**

- You attempted to set more than 998 photos in the print order.

**PROCESS CANCELED**

- The process was canceled following user intervention.

**REACHED THE MAXIMUM NUMBER OF SCENES**

- The maximum number of scenes has been reached. Delete some scenes (□ 43).
- Scene could not be added to the playlist (□ 56). The playlist cannot contain more than 99 scenes. Delete some scenes (□ 57).

**FS22 / FS21 / FS20 READING THE BUILT-IN MEMORY**

- Reading data from the built-in memory.

**READING THE CARD**

- Reading data from the memory card.

**SCENE RECORDED USING ANOTHER DEVICE. CANNOT DIVIDE THE SCENE.**

- Scenes recorded with another device cannot be divided using this camcorder.

**SOME  PHOTOS COULD NOT BE DELETED**

- Protected photos cannot be deleted. Cancel the protection setting before deleting.

**SOME SCENES COULD NOT BE ADDED**

- Scene could not be added to the playlist. The playlist cannot contain more than 99 scenes. Delete some scenes from the playlist (□ 57).



#### **SOME SCENES COULD NOT BE DELETED**

- Movies that were protected/edited with other devices cannot be deleted.

#### **TASK IN PROGRESS DO NOT DISCONNECT THE POWER SOURCE**

- The camcorder is updating the memory. Do not disconnect the compact power adapter or remove the battery pack.

#### **THE CAMCORDER IS SET TO MOVIE MODE**

- You pressed **[PHOTO]** while the camera mode dial was set to **MOVIE**.

#### **THE CAMCORDER IS SET TO PHOTO MODE**

- You pressed **[Start/Stop]** while the camera mode dial was set to **PHOTO**.

#### **THE CARD IS SET FOR ERASURE PREVENTION**

- The LOCK switch on the SD or SDHC memory card is set to prevent accidental erasure. Change the position of the LOCK switch.

#### **THE MEMORY CARD COVER IS OPEN**

- After inserting a memory card, close the memory card slot cover (**[ ] 31**).

#### **THIS PHOTO COULD NOT BE DELETED**

- Protected photos cannot be deleted. Cancel the protection setting before deleting.

#### **TOO MANY PHOTOS DISCONNECT USB CABLE**

- Disconnect the USB cable and decrease the number of photos on the memory card to fewer than 1,800. If a dialog box appeared on the computer screen, close it. Disconnect the USB cable, and restore the connection after a short while.

#### **TRANSFER ORDER ERROR**

- You attempted to set more than 998 transfer orders. Reduce the number of photos marked with transfer orders.

#### **UNABLE TO RECOGNIZE THE DATA**

- A memory card with data recorded in a different television system (PAL or SECAM) was inserted into the camcorder.

#### **UNABLE TO RECOVER DATA**

- Could not recover a corrupted file.

#### **WHILE THE CAMCORDER IS CONNECTED TO A PC DO NOT DISCONNECT THE USB CABLE OR POWER SOURCE CANNOT TURN OFF POWER OR CHANGE MODES**

- When the camcorder is in **[PC]** mode and is connected to the computer with a USB cable, the camcorder cannot be operated. Disconnecting the USB cable or power source while this message appears may result in permanent loss of the recordings in the camcorder. Use the computer's Safely Remove Hardware function to end the connection and disconnect the USB cable before using the camcorder.

## Messages Related to the Optional DW-100 DVD Burner

---

If a message appears while the camcorder is connected to the optional DW-100 DVD Burner, refer to the following section and also to the instruction manual of the DVD Burner.

### **CANNOT READ THE DISC CHECK THE DISC**

- During disc recording mode, this message can appear when a commercially available DVD disc (a DVD disc containing movies, software, etc.) or an 8 cm mini DVD disc is inserted.

### **CLOSE THE MEMORY CARD SLOT COVER**

- The memory card slot cover is open. Close the cover after correctly inserting the memory card (□□ 31).

### **CONNECT THE COMPACT POWER ADAPTER**

- The camcorder is being powered by the battery pack. Connect the compact power adapter to the camcorder.

### **DISC ACCESS FAILURE CHECK THE DISC**

- There was an error when reading the disc or attempting to write onto it.
- This message can also appear if condensation has formed. Wait until the DVD burner dries completely before resuming use (□□ 108).
- The disc may not be loaded correctly. Try removing the disc and reinserting it.

### **ERROR READING THE DATA**

- Error while reading the recordings from the camcorder.
- Check that the USB cable was not accidentally disconnected.

### **LOADING THE DISC**

- Reading data from the disc.

### **NO DISC**

- Insert a disc into the DVD burner.
- This message can also appear if condensation has formed. Wait until the DVD burner dries completely before resuming use (□□ 108).

### **NO PHOTOS**

- There are no photos to add to the disc.

### **NO SCENES**

- There are no movies to add to the disc.

### **NO SCENES LEFT TO ADD**

- You selected to create a DVD with the [REM.SCENES] setting, but all the scenes have already been added to discs created in the past; there are no applicable scenes.

### **NO TRANSFER ORDERS**

- You selected to create a DVD with the [TRANS.ORD] setting, but no photos have been marked with transfer orders (□□ 83).

### **OPERATION CANCELED**

- The USB cable was disconnected and the operation was canceled. Check the USB connection.

### **UNABLE TO RECOVER DATA**

- Could not recover a corrupted file.



## Direct Print Related Messages

---



### **CANNOT PRINT!**

- You attempted to print a photo that was recorded with another camcorder, has a different compression, or was edited on a computer.

### **CHECK PRINT SETTINGS**

- Current print settings cannot be used for printing with the   button.

### **COMMUNICATION ERROR**

- The printer is experiencing a data transfer error. Cancel printing, disconnect the USB cable and turn off the printer. After a while, turn the printer back on and reconnect the USB cable. When you are printing using the   button, check the print settings.  
Or, you attempted to print from a memory card that contains a large number of photos. Reduce the number of photos.

### **COULD NOT PRINT X PHOTOS**

- You attempted to use the print order settings to print X photos that were recorded with another camcorder, with a different compression or were edited on a computer.

### **FILE ERROR**

- You attempted to print a photo that was recorded with another camcorder, has a different compression, or was edited on a computer.

### **HARDWARE ERROR**

- Cancel printing. Turn off the printer and turn it back on. Check the printer status. If the printer is equipped with a battery, it might be exhausted. In such case, turn off the printer, replace the battery and turn it back on.

### **INCOMPATIBLE PAPER SIZE**

- The paper settings of the camcorder conflict with the printer's settings.

### **INK ABSORBER FULL**

- Select [CONTINUE] to resume printing. Consult a Canon Service Center (refer to the list included with the printer) to replace the ink absorber.

### **INK ERROR**

- There is a problem with the ink. Replace the ink cartridge.

### **LOW INK LEVEL**

- The ink cartridge needs to be replaced soon. Select [CONTINUE] to restart printing.

### **NO INK**

- The ink cartridge is not inserted or is out of ink.

### **NO PAPER**

- Paper is not correctly inserted or there is no paper.

### **NO PRINTHEAD**

- No print head is installed in the printer or the print head is defective.

### **PAPER ERROR**

- There is a problem with the paper. The paper is not correctly loaded or the paper size is wrong. Alternatively, if the paper output tray is closed, open it to print.



**PAPER JAM**

- The paper jammed during printing. Select [STOP] to cancel printing. After removing the paper, set some paper again and retry printing.

**PAPER LEVER ERROR**

- Paper lever error occurred. Adjust the paper selection lever to the proper position.

**PRINT ERROR**

- Cancel printing, disconnect the USB cable and turn off the printer. After a while, turn the printer back on and reconnect the USB cable. Check the printer status.
- When you are printing using the   button, check the print settings.

**PRINTER COVER OPEN**

- Close the printer cover securely.

**PRINTER ERROR**

- A malfunction has occurred that may require repairs. (Canon PIXMA printers: the printer's green power lamp and orange error lamp flash alternately.)
- Disconnect the USB cable and turn off the printer. Unplug the printer's power cord from the power outlet and contact the appropriate customer support center or service center.

**PRINTER IN USE**

- The printer is in use. Check the printer status.

**SET  PRINT ORDER**

- No photo has been marked with a print order.

 **NOTES**

---

**About Canon PIXMA/SELPHY DS Printers:** If the printer's error indicator flashes or an error message appears on the printer's operation panel, refer to the printer's instruction manual.

- If you cannot solve the problem even after consulting this list and the printer's instruction manual, contact the closest Canon Service Center (refer to the list included with the printer).





## Handling Precautions

### Camcorder

Be sure to observe the following precautions to ensure maximum performance.

- **Back up your recordings periodically.** Make sure to transfer your recordings to an external device such as a computer or digital video recorder (□□ 77) and back them up on a regular basis. This will protect your important recordings in case of damage and create more free space on the memory. Canon shall not be liable for any data loss.
- When using the wrist strap or a shoulder strap, do not allow the camcorder to swing and hit an object.
- Do not carry the camcorder by the LCD panel. Be careful when closing the LCD panel.
- Do not leave the camcorder in places subject to high temperatures (like the inside of a car under direct sunlight), or high humidity.
- Do not use the camcorder near strong electromagnetic fields such as above TVs, near plasma TVs or mobile phones.
- Do not point the lens at strong light sources. Do not leave the camcorder pointed at a bright subject.
- Do not use or store the camcorder in dusty or sandy places. The camcorder is not waterproof – avoid also water, mud or salt. If any of the above should get into the camcorder

it may damage the camcorder and/or the lens.

- Be careful of heat generated by lighting equipment.
- Do not disassemble the camcorder. If the camcorder does not function properly, consult qualified service personnel.
- Handle the camcorder with care. Do not subject the camcorder to shocks or vibration as this may cause damage.
- When mounting the camcorder on a tripod, make sure that the tripod's fastening screw is shorter than 5.5 mm (0.2 in.). Using other tripods may damage the camcorder.

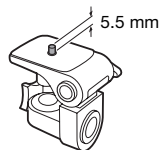

- **When recording movies, try to get a calm, stable picture.** Excessive camcorder movement while shooting and extensive use of fast zooms and panning can result in jittery scenes. In extreme cases, the playback of such scenes may result in visually induced motion sickness. If you experience such a reaction, immediately stop the playback and take a rest break as necessary.

### Long-term Storage

If you do not intend to use the camcorder for a long time, store it in a

place free of dust, in low humidity, and at temperatures not higher than 30 °C (86 °F).

---

---

## Battery Pack

### DANGER!

#### Treat the battery pack with care.

- Keep it away from fire (or it might explode).
- Do not expose the battery pack to temperature higher than 60 °C (140 °F). Do not leave it near a heater or inside a car in hot weather.
- Do not try to disassemble or modify it.
- Do not drop it or subject it to shocks.
- Do not get it wet.

### CAUTION:

**Danger of explosion if battery is incorrectly attached. Attach only with the same type.**

- Dirty terminals may cause a poor contact between the battery pack and the camcorder. Wipe the terminals with a soft cloth.

---

## Remaining Battery Time

If the remaining battery time displayed is not correct, charge the battery pack fully. However, the correct time may not be displayed if a fully charged battery pack is used continuously in high temperatures or it is left unused for long periods of time. Additionally, depending on the battery life, the correct time may

not be displayed. Use the time shown on the screen as an approximation.



---

## Long-term Storage

- Store battery packs in a dry place at temperatures no higher than 30 °C (86 °F).
- To extend the battery life of the battery pack, discharge it completely before storing it.
- Charge and discharge all your battery packs fully at least once a year.

---

## Regarding batteries that do not bear the Intelligent System mark

- For your safety, battery packs that do not bear the Intelligent System mark  Intelligent Li-ion Battery (□□ 112) will not be charged even if you attach them to this camcorder or to the optional CG-800 Battery Charger.
- If you use with the camcorder battery packs that are not genuine Canon battery packs,  will appear and the remaining battery time will not be displayed.

---

---

## Memory Card

- We recommend backing up the recordings on the memory card onto your computer. Data may be corrupted or lost due to memory card defects or exposure to static electricity. Canon makes no warranties for corrupted or lost data.
- Do not touch or expose the terminals to dust or dirt.
- Do not use memory cards in places subject to strong magnetic fields.



- Do not leave memory cards in places subject to high humidity and high temperature.
- Do not disassemble, bend, drop, or subject memory cards to shocks and do not expose them to water.
- Check the direction before inserting the memory card. Forcing a memory card into the slot if it is not correctly oriented may damage the memory card or the camcorder.
- Do not attach any labels or stickers on the memory card.
- SD/SDHC memory cards have a physical switch to prevent writing on the card so as to avoid the accidental erasure of the card's content. To write protect the memory card, set the switch to the LOCK position.

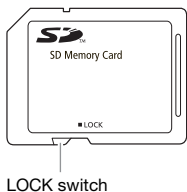

---

## Built-in Rechargeable Lithium Battery

The camcorder has a built-in rechargeable lithium battery to keep the date/time and other settings. The built-in lithium battery is recharged while you use the camcorder; however, it will become totally discharged if you do not use the camcorder for about 3 months.

### To recharge the built-in lithium battery:

Connect the compact power adapter to the camcorder and leave it connected

for about 24 hours with the camcorder off.

---

## ES22 Lithium Button Battery

### WARNING!

- The battery used in this device may present a fire or chemical burn hazard if mishandled.
- Do not disassemble, modify, immerse in water, heat above 100 °C (212 °F) or incinerate the battery.
- Replace with a CR2025 battery made by Panasonic, Hitachi Maxell, Sony, Sanyo, or with Duracell2025. Use of other batteries may present a risk of fire or explosion.
- Do not insert the battery into the mouth. If swallowed, seek medical assistance immediately. The battery case may break and the battery fluids may cause internal damage.
- Keep the battery out of the reach of children.
- Do not recharge, short-circuit or insert the battery in the wrong direction.
- Dispose of the used battery according to applicable recycling regulations.

- Do not pick up the battery using tweezers or other metal tools, as this will cause a short circuit.
- Wipe the battery with a clean dry cloth to ensure proper contact.
- **For California, USA only:** The lithium battery included contains Perchlorate Material – special handling may apply. See [www.dtsc.ca.gov/hazardouswaste/perchlorate](http://www.dtsc.ca.gov/hazardouswaste/perchlorate) for details.

---

---

## Disposal

When you delete movies or initialize the built-in memory (**FS22** / **FS21** / **FS20** only) or memory card, only the file allocation table is altered and stored data is not physically erased. Take the necessary precautions when you dispose of the camcorder or memory card, for example by physically damaging it to prevent the leakage of private data.

**FS22** / **FS21** / **FS20** If giving the camcorder to another person, initialize the built-in memory using the [COMPL.INIT.] setting (□ 32), fill it up with unimportant recordings, and then initialize it again using the same method. This makes recovering the original recordings very difficult.

## Maintenance/Others

---

---

### Cleaning

#### Camcorder Body

- Use a soft, dry cloth to clean the camcorder body. Never use chemically treated cloths or volatile solvents such as paint thinner.

#### Lens

If the lens surface is dirty, the autofocus may not work properly.

- Remove any dust or dirt particles using a non-aerosol type blower brush.
- Use a clean, soft lens-cleaning cloth to gently wipe the lens. Never use tissue paper.

#### LCD Screen

- Clean the LCD screen using a clean, soft lens-cleaning cloth.
- Condensation may form on the surface of the screen when the temperature changes suddenly. Wipe it with a soft dry cloth.

---

---

### Condensation

Moving the camcorder rapidly between hot and cold temperatures may cause condensation (water droplets) to form on its internal surfaces. Stop using the camcorder if condensation is detected. Continued use may damage the camcorder.



#### Condensation may form in the following cases:

- When the camcorder is moved quickly from cold to warm places
- When the camcorder is left in a humid room
- When a cold room is heated rapidly

#### TO AVOID CONDENSATION

- Do not expose the camcorder to sudden or extreme changes in temperature.
- Place the camcorder in an airtight plastic bag and let it adjust to temperature changes slowly before removing it from the bag.

#### WHEN CONDENSATION IS DETECTED

The camcorder automatically shuts off. The precise time required for water droplets to evaporate will vary depending on the location and weather conditions. As a general rule, wait for 2 hours before resuming use of the camcorder.

---

### Using the Camcorder Abroad

#### Power Sources

You can use the compact power adapter to operate the camcorder and to charge battery packs in any country with power supply between 100 and 240 V AC, 50/60 Hz. Consult a Canon Service Center for information on plug adapters for overseas use.

#### Playback on a TV Screen

You can only play back your recordings on TVs compatible with the NTSC system. NTSC is used in the following regions/countries:

**Americas:** All of North America and Central America; most Caribbean islands (except in French territories like Guadeloupe and Martinique); most of South America (except in Argentina, Brazil and Uruguay). **Asia:** Only in Japan, the Philippines, South Korea, Taiwan and Myanmar. **Oceania:** US territories (Guam, American Samoa, etc.) and some Pacific islands like Micronesia, Samoa and Tonga.

---

### Music Files

The specifications of the music files compatible with the camcorder are as follows.

Audio encoding: Linear PCM

Audio sampling: 48 kHz, 16 bits, 2 channels

Minimum length: 10 seconds

File extension: WAV

The music files are saved in the memory under the following folder structure.

On the memory card:

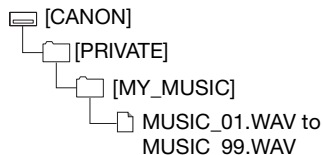

**FS22 / FS21 / FS20**

In the built-in memory:

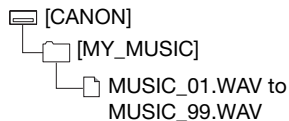

The supplied **Instruction Manual/ Music Data Disc** CD-ROM contains a folder called [MUSIC]. This folder contains two folders called [MUSIC 1] and [MUSIC 2]. [MUSIC 1] contains the tracks that are pre-installed in the built-in memory of the FS22/FS21/FS20. [MUSIC 2] contains tracks different from those in [MUSIC 1]. Use tracks from both folders to your liking or to restore the pre-installed tracks if the built-in memory was initialized (**FS22 / FS21 / FS20** only).



## System Diagram (Availability differs from area to area)

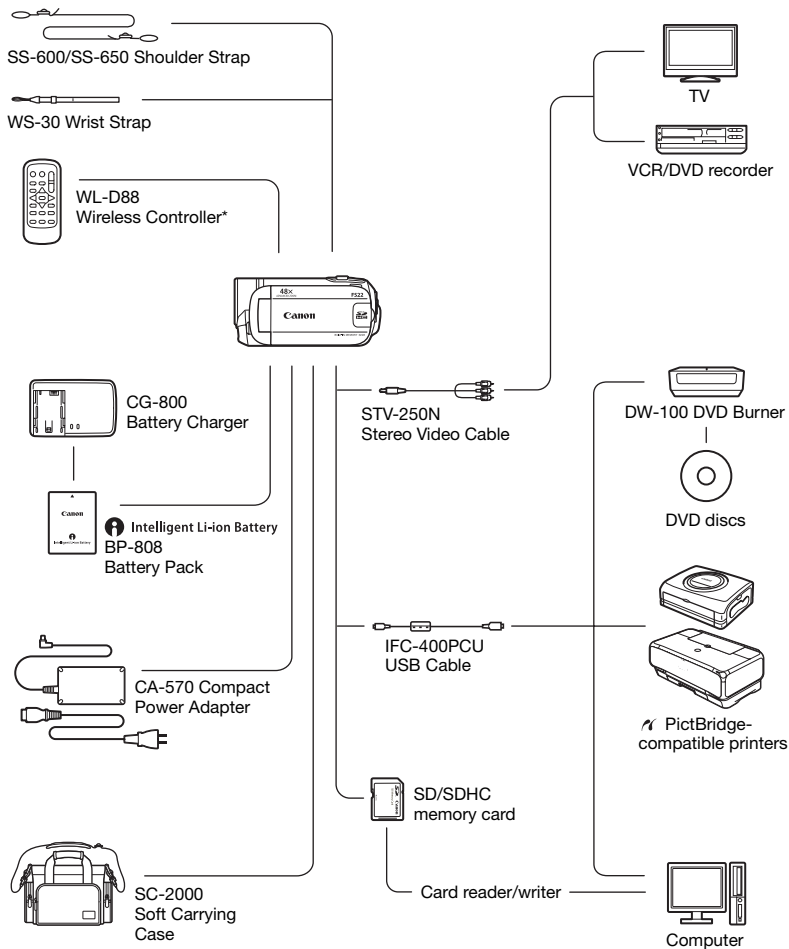

## Optional Accessories

Call or visit your local retailer/dealer for genuine Canon video accessories. You can also obtain genuine accessories for your Canon camcorder by calling: 1-800-828-4040, Canon U.S.A. Information Center.

### Use of genuine Canon accessories is recommended.

This product is designed to achieve excellent performance when used with genuine Canon accessories. Canon shall not be liable for any damage to this product and/or accidents such as fire, etc., caused by the malfunction of non-genuine Canon accessories (e.g., a leakage and/or explosion of a battery pack). Please note that this warranty does not apply to repairs arising out of the malfunction of non-genuine Canon accessories, although you may request such repairs on a chargeable basis.

### Battery Packs

When you need extra battery packs, make sure you select the BP-808.

#### Intelligent Li-ion Battery

When you use battery packs bearing the Intelligent System mark, the camcorder will communicate with the battery and display the remaining usage time (accurate to 1 minute). You can only use and charge these battery packs with camcorders and chargers compatible with Intelligent System.

### CG-800 Battery Charger

Use the battery charger to charge the battery packs. It plugs directly into a power outlet without a cable.

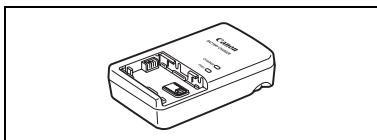
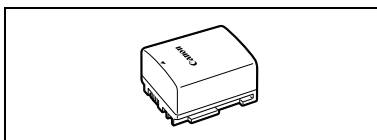

### Charging Times

The charging times given in the following table are approximate and vary according to charging conditions and initial charge of the battery pack.

Charging conditions	Charging time
Using the camcorder	140 min.*
Using the CG-800 Battery Charger	105 min.

\* When the camcorder charges an exhausted battery pack for the first 20 minutes, it can be used for 3 times longer than it was charged. In other words, you can record with the camcorder for 60 minutes after a 20-minute charge.





### Recording and Playback Times

The recording and playback times given in the following table are approximate and vary according to recording mode and charging, recording or playback conditions. The effective usage time of the battery pack may decrease when recording in cold surroundings, when using the brighter screen settings, etc.

#### Using the built-in memory (FS22 / FS21 / FS20 only)

Recording mode →	XP	SP	LP
Usage time ↓			
Maximum recording time	210 min.	215 min.	215 min.
Typical recording time*	105 min.	105 min.	110 min.
Playback time	290 min.	295 min.	295 min.

#### Using a memory card (FS22 / FS21 / FS20)

Recording mode →	XP	SP	LP
Usage time ↓			
Maximum recording time	205 min.	205 min.	205 min.
Typical recording time*	100 min.	100 min.	105 min.
Playback time	275 min.	275 min.	280 min.

#### Using a memory card (FS200)

Recording mode →	XP	SP	LP
Usage time ↓			
Maximum recording time	205 min.	210 min.	210 min.
Typical recording time*	100 min.	105 min.	105 min.
Playback time	290 min.	295 min.	295 min.

\* Approximate times for recording with repeated operations such as start/stop, zooming, and power on/off.

### Shoulder Strap

You can attach a shoulder strap for more security and portability.

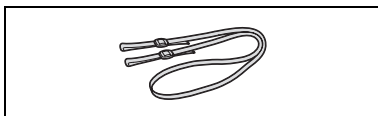

**SC-2000 Soft Carrying Case**

A handy camcorder bag with padded compartments and plenty of space for accessories.



This mark identifies genuine Canon video accessories. When you use Canon video equipment, we recommend Canon-brand accessories or products bearing the same mark.



---

---

**Product Codes**

**Provided Accessories**

CA-570 Compact Power Adapter	8468A002AA
BP-808 Battery Pack	2740B002AA
WL-D88 Wireless Controller	D83-0770-000
STV-250N Stereo Video Cable	3067A002AA (D82-0590-002)
IFC-400PCU USB Cable	9370A001AA
WS-30 Wrist Strap	D81-1530-000

**Optional Accessories**

CG-800 Battery Charger	2590B002AA
SS-650 Shoulder Strap	3123A001AA
SS-600 Shoulder Strap	3122A001AA
SC-2000 Soft Carrying Case	9389A001AA



## Specifications

### FS22/FS21/FS20/FS200

#### System

<b>Recording System</b>	Movies:	SD-Video Video compression: MPEG-2 Audio compression: Dolby Digital 2ch (AC-3)
	Photos:	DCF (Design rule for camera system), compatible with Exif <sup>1</sup> Ver. 2.2 and with DPOF Photo compression: JPEG (Super Fine, Fine, Normal)

**Television System** EIA standard (525 lines, 60 fields) NTSC color signal

<b>Recording Media</b>	<b>FS22</b>	Built-in flash memory, 32 GB; SD or SDHC (SD High Capacity) memory card (not included)
	<b>FS21</b>	Built-in flash memory, 16 GB; SD or SDHC (SD High Capacity) memory card (not included)
	<b>FS20</b>	Built-in flash memory, 8 GB; SD or SDHC (SD High Capacity) memory card (not included)
	<b>FS200</b>	SD or SDHC (SD High Capacity) memory card (not included)

<b>Maximum Recording Time (approximate figures)</b>	<b>FS22</b>	Built-in memory, 32 GB XP: 7 hr. 20 min., SP: 11 hr. 5 min., LP: 20 hr. 50 min.
	<b>FS21</b>	Built-in memory, 16 GB XP: 3 hr. 40 min., SP: 5 hr. 30 min., LP: 10 hr. 20 min.
	<b>FS20</b>	Built-in memory, 8 GB XP: 1 hr. 50 min., SP: 2 hr. 45 min., LP: 5 hr. 10 min. 4 GB memory card XP: 55 min., SP: 1 hr. 20 min., LP: 2 hr. 35 min.

<b>Image Sensor</b>	<b>FS22 / FS21 / FS20</b>	1/6-inch CCD, approx. 1,070,000 pixels
	Effective pixels <sup>2</sup> (all figures are approximate values)	
	16:9 Movies (advanced zoom)	410,000 (T) / 710,000 (W) pixels
	(optical zoom)	550,000 pixels
	4:3 Movies (advanced zoom)	310,000 (T) / 690,000 (W) pixels
	(optical zoom)	690,000 pixels
	16:9 Photos	600,000 pixels
	4:3 Photos	800,000 pixels
	<b>FS200</b>	1/6-inch CCD, approx. 680,000 pixels
	Effective pixels <sup>2</sup> (all figures are approximate values)	
16:9 Movies (advanced zoom)	360,000 (T) / 450,000 (W) pixels	
(optical zoom)	360,000 pixels	
4:3 Movies (optical zoom)	340,000 pixels	
Photos	450,000 pixels	

**LCD Screen** 2.7 in., wide, TFT color, approx. 123,000 dots

**Microphone** Stereo electret condenser microphone

## Lens

<b>FS22 / FS21 / FS20</b>	f=2.6-96.2 mm, F/2.0-5.2, 37x optical zoom
	35 mm equivalent (all figures are approximate values)
16:9 Movies (advanced zoom)	41.7-2,002 mm
(optical zoom)	47.1-1,743 mm
4:3 Movies (advanced zoom)	44.6-2,453 mm
(optical zoom)	44.6-1,650 mm
16:9 Photos	45.2-1,672 mm
4:3 Photos	41.5-1,536 mm
<b>FS200</b>	f=2.6-96.2 mm, F/2.0-5.2, 37x optical zoom
	35 mm equivalent (all figures are approximate values)
16:9 Movies (advanced zoom)	41.3-1,695 mm
(optical zoom)	45.8-1,695 mm
4:3 Movies (advanced zoom)	49.8-1,843 mm
Photos	43.6-1,613 mm

<b>Lens Configuration</b>	10 elements in 8 groups (1 double-sided, aspheric element)
<b>AF System</b>	TTL autofocus, manual focus available
<b>Minimum Focusing Distance</b>	1 m (3.3 ft.); 1 cm (0.39 in.) at full wide angle
<b>White Balance</b>	Auto white balance, preset white balance (DAYLIGHT, TUNGSTEN) or custom white balance
<b>Minimum Illumination</b>	[NIGHT] recording program, Shutter speed at 1/8: <b>FS22 / FS21 / FS20</b> 1.7 lx <b>FS200</b> 1.3 lx [PROGRAM AE], Auto slow shutter [ON], Shutter speed at 1/30: <b>FS22 / FS21 / FS20</b> 6.5 lx <b>FS200</b> 5 lx
<b>Recommended Illumination</b>	More than 100 lx
<b>Image Stabilization</b>	Electronic
<b>Size of Photos</b>	<b>FS22 / FS21 / FS20</b> 1152 x 864, 1152 x 648, 640 x 480 pixels <b>FS200</b> 1024 x 768, 640 x 480 pixels

<sup>1</sup> This camcorder supports Exif 2.2 (also called "Exif Print"). Exif Print is a standard for enhancing the communication between camcorders and printers. By connecting to an Exif Print-compliant printer, the camcorder's image data at the time of shooting is used and optimized, yielding extremely high quality prints.

<sup>2</sup> When two values are given, the first indicates the value at full telephoto (T) and the second indicates the value at full wide-angle (W).

## Terminals

<b>AV OUT</b>  Terminal	Ø 3.5 mm minijack; Output only (dual purpose terminal also for headphones stereo output) Video: 1 V <sub>p-p</sub> / 75 Ω unbalanced Audio: -10 dBV (47 kΩ load) / 3 kΩ or less
<b>USB Terminal</b>	mini-B, USB 2.0 (Hi-Speed USB)
<b>MIC Terminal</b>	Ø 3.5 mm stereo minijack -57 dBV (with 600 Ω microphone) / 5 kΩ or more
<b>Power/Others</b>	
<b>Power supply (rated)</b>	7.4 V DC (battery pack), 8.4 V DC (compact power adapter)
<b>Power consumption (SP mode, AF on)</b>	1.8 W (LCD screen, normal brightness, recording in the built-in memory*) * <b>FS22 / FS21 / FS20</b> only 1.8 W (LCD screen, normal brightness, recording on a memory card)
<b>Operating temperature</b>	0 - 40 °C (32 - 104 °F)
<b>Dimensions (W x H x D)</b>	55 x 59 x 121 mm (2.2 x 2.3 x 4.8 in.) excluding the grip belt
<b>Weight (camcorder body only)</b>	225 g (7.9 oz.) excluding the grip belt



---

---

## CA-570 Compact Power Adapter

<b>Power supply</b>	100 – 240 V AC, 50/60 Hz
<b>Rated output / consumption</b>	8.4 V DC, 1.5 A / 29 VA (100 V) – 39 VA (240 V)
<b>Operating temperature</b>	0 – 40 °C (32 – 104 °F)
<b>Dimensions</b>	52 x 29 x 90 mm (2.1 x 1.1 x 3.5 in.)
<b>Weight</b>	135 g (4.8 oz.)

---

---

## BP-808 Battery Pack

<b>Battery type</b>	Rechargeable lithium ion battery, compatible with Intelligent System
<b>Rated voltage</b>	7.4 V DC
<b>Operating temperature</b>	0 - 40 °C (32 - 104 °F)
<b>Battery capacity</b>	890 mAh
<b>Dimensions</b>	30.7 × 23.3 × 40.2 mm (1.2 × 0.9 × 1.6 in.)
<b>Weight</b>	46 g (1.6 oz.)

Weight and dimensions are approximate. Errors and omissions excepted. The information in this manual is verified as of January 2009. Subject to change without notice.

## Index

- A**
- Abroad, using the camcorder . . . . . 109
  - AEB - Auto exposure bracketing . . . . . 66
  - Aspect ratio of a connected TV
    - (TV type) . . . . . 90
  - Audio level indicator . . . . . 88
  - Auto slow shutter . . . . . 86
  - Autofocus (AF): AF frame
    - (9-point AiAF/Center point) . . . . . 87
  - AV OUT/□ terminal . . . . . 75
- B**
- Backing up recordings . . . . . 77
  - Backlight correction . . . . . 50
  - Battery pack
    - Battery information . . . . . 18
    - Charging . . . . . 19
    - Remaining charge indicator . . . . . 18
  - Beach (recording program) . . . . . 45
  - Beep . . . . . 90
  - Built-in backup battery . . . . . 107
- C**
- Calendar display . . . . . 41
  - Condensation . . . . . 108
  - Connections to external devices . . . . . 75
  - Continuous shooting . . . . . 66
  - Copying<sup>1</sup>
    - Movies . . . . . 58
    - Photos . . . . . 68
- D**
- Data code . . . . . 89
  - Date and time . . . . . 28
    - Date format . . . . . 92
    - Daylight saving time . . . . . 29
    - Time zone . . . . . 29
- E**
- Deleting/Erasing
    - Movies . . . . . 43, 57
    - Photos . . . . . 62, 65
  - Digital effects . . . . . 53
  - Direct print . . . . . 69
  - Direct transfer . . . . . 80
  - Dividing scenes . . . . . 56
  - Drive mode . . . . . 66
  - Dual Shot . . . . . 25
  - DVD authoring . . . . . 77
- E**
- Error messages . . . . . 97
  - Exposure . . . . . 50
- F**
- Fireworks (recording program) . . . . . 45
  - Focus
    - Focus priority . . . . . 86
    - Manual . . . . . 51
  - FUNC. menu . . . . . 27, 84
- H**
- Headphones . . . . . 54
  - Histogram . . . . . 67
- I**
- Image effects . . . . . 52
  - Image stabilizer . . . . . 86
  - Index screen . . . . . 38, 63
  - Initializing the memory . . . . . 32
- J**
- Joystick . . . . . 26
  - Joystick guide . . . . . 26
- L**
- Language . . . . . 29
  - LCD screen . . . . . 23

<sup>1</sup> FS22 / FS21 / FS20 only.



## M

Magnifying photos	.64
Maintenance	.108
Manual exposure adjustment	.50
Markers	.88
Memory card	.106
MIC terminal	.55
Microphone	.55
Mini video light	.47
Music Files	.109

## N

Night (recording program)	.45
---------------------------	-----

## O

Onscreen display selection	.54, 67
----------------------------	---------

## P

P (recording program)	.45
Photo numbers	.90
Photo quality	.60
Photo size	.60
Playback	
Movies	.38
Photos	.62
Playlist	.56
Portrait (recording program)	.45
Power save	.34
Pre-recording	.49
Print order	.72
Print/share button	.70, 82
Printing photos	.69
Protecting photos	.67

## Q

Quick Start function	.37
----------------------	-----

## R

Recording	
Movies	.34
Photos	.60

Recording mode	.35
Recording programs	.44, 45
Recording time	.35
Remote sensor <sup>1</sup>	.22
RESET	.96
Reviewing photos	.86

## S

Screen icons	.16
SD/SDHC memory card	.31
Searching scenes by date	.40
Selecting the media <sup>2</sup>	
for playback	.40
for recording	.32
Self timer	.49
Serial number	.14
Setup menus	.27, 86
Shutter speed	.45
Slideshow	.63
Snow (recording program)	.45
Special Scene (recording programs)	.44
Sports (recording program)	.45
Spotlight (recording program)	.45
Sunset (recording program)	.45

## T

Telephoto	.35
Timeline	.41
Transfer order	.83
Transferring to a computer	
Movies	.77
Photos	.80
Troubleshooting	.93
Tv (recording program)	.45

## U

USB terminal	.75
--------------	-----

<sup>1</sup> **FS22** only.

<sup>2</sup> **FS22** / **FS21** / **FS20** only.

<b>V</b>	
VIDEO SNAP .....	47
Video Snapshot .....	47
Volume .....	38, 90

<b>W</b>	
White balance .....	51
Wide angle .....	35
Wind screen .....	87
Wireless controller <sup>1</sup> .....	21, 22

<b>Z</b>	
Zoom	
Advanced zoom .....	35
Zoom speed .....	35, 86
Zoom type .....	36

<sup>1</sup> **FS22** only.

### Trademark Acknowledgements

- The SD logo is a trademark. The SDHC logo is a trademark.
- Microsoft, Windows and Windows Vista are trademarks or registered trademarks of Microsoft Corporation in the United States and/or other countries.
- Macintosh and Mac OS are trademarks of Apple Inc., registered in the U.S. and other countries.
- Manufactured under license from Dolby Laboratories.  
“Dolby” and the double-D symbol are trademarks of Dolby Laboratories.
- Other names and products not mentioned above may be trademarks or registered trademarks of their respective companies.
- ANY USE OF THIS PRODUCT OTHER THAN CONSUMER PERSONAL USE IN ANY MANNER THAT COMPLIES WITH THE MPEG-2 STANDARD FOR ENCODING VIDEO INFORMATION FOR PACKAGED MEDIA IS EXPRESSLY PROHIBITED WITHOUT A LICENSE UNDER APPLICABLE PATENTS IN THE MPEG-2 PATENT PORTFOLIO, WHICH LICENSE IS AVAILABLE FROM MPEG LA, L.L.C., 250 STEELE STREET, SUITE 300, DENVER, COLORADO 80206.





**U.S.A.**

## **CANON CONSUMER DIGITAL VIDEO EQUIPMENT LIMITED WARRANTY FOR THE UNITED STATES**

The limited warranty set forth below is given by Canon U.S.A., Inc. ("Canon USA") with respect to Canon Consumer Digital Video Equipment (the "Equipment") purchased in the United States. This limited warranty is only effective upon presentation of your Bill of Sale or other proof of purchase.

The Equipment is warranted under normal, non-commercial, personal use, against defective materials or workmanship as follows:

**Parts:** Defective parts will be exchanged for new parts or comparable rebuilt parts for a period of ONE YEAR from the date of original purchase, except for a defective Video Head, which will be exchanged for a period of three months from the date of purchase.

**Labor:** For a period of ONE YEAR from the date of original purchase, labor will be provided free of charge by our factory service centers or designated service facilities located in the United States.

When returning Equipment under this warranty, you must pre-pay the shipping charges, and you must enclose the Bill of Sale or other proof of purchase with a complete explanation of the problem. During the ONE-YEAR warranty period, repairs will be made and the Equipment will be return-shipped to you free of charge. For repairs after the warranty period is over, you will be given an estimate of the cost of repair and an opportunity to approve or disapprove of the repair expense before it is incurred. If you approve, repairs will be made and the Equipment will be return-shipped to you. (shipping charges apply). If you disapprove, we will return-ship the equipment at no charge to you.

**Non-Canon brand peripheral equipment and software which may be distributed with, or factory loaded on, the Equipment, are sold "AS IS" without warranty of any kind by Canon USA, including any implied warranty regarding merchantability or fitness for a particular purpose. The sole warranty with respect to such non-Canon brand items is given by the manufacturer or producer thereof. If the Equipment contains a hard disk drive, Canon USA recommends that data stored on that drive be duplicated or backed up to prevent its loss in the event of failure or other malfunction of such drive.**

Canon USA shall have no responsibility under this limited warranty for use of the Equipment in conjunction with incompatible peripheral equipment and incompatible software.

In order to obtain warranty service, contact the authorized Canon retail dealer from whom you purchased the Equipment or call the CANON INFORMATION CENTER AT 1-800-OK-CANON). You will be directed to the nearest service facility for your Equipment.

This Limited Warranty covers all defects encountered in normal use of the Equipment and does not apply in the following cases:

- A) Loss or damage to the Equipment due to abuse, mishandling, accident, improper maintenance, or failure to follow operating instructions;
- B) If the Equipment is defective as a result of leaking batteries, sand, dirt or water damage;
- C) If defects or damages are caused by the use of unauthorized parts or by service other than by Canon USA's factory service centers or authorized service facilities;
- D) If the Equipment is used for commercial or industrial use.

This Limited Warranty does not cover cabinet (exterior finish), video cassette tape, head cleanings, nor does it apply to Equipment purchased outside the United States. This warranty does not cover units sold to rental firms, military operations, hotels, schools, hospitals or for other commercial, industrial, or institutional applications. These uses are covered only by such specific warranty as Canon may issue with such sales.

This Limited Warranty does not apply to accessories or consumables for the Equipment, which are sold "AS IS", without warranty of any kind by Canon USA.

Please retain this warranty card and your Bill of Sale as a permanent record of your purchase. This card is most important in order to be sure you are contacted right away should there be a safety inspection, modification or product recall under applicable laws or regulations.

**NO IMPLIED WARRANTY, INCLUDING MERCHANTABILITY AND FITNESS FOR A PARTICULAR PURPOSE APPLIES TO THIS EQUIPMENT AFTER THE APPLICABLE PERIOD OF EXPRESS WARRANTY OR GUARANTY, EXCEPT AS MENTIONED ABOVE, GIVEN BY ANY PERSON, FIRM OR CORPORATION WITH RESPECT TO THIS EQUIPMENT SHALL BIND THE UNDERSIGNED (SOME STATES DO NOT ALLOW LIMITATIONS ON HOW LONG AN IMPLIED WARRANTY LASTS, SO THE ABOVE LIMITATION OR EXCLUSION MAY NOT APPLY TO YOU). CANON USA SHALL NOT BE LIABLE FOR LOSS OF REVENUES OR PROFITS, EXPENSE FOR SUBSTITUTE EQUIPMENT OR SERVICE, STORAGE CHARGES, LOSS OR CORRUPTION OF DATA, INCLUDING WITHOUT LIMITATION, LOSS OR CORRUPTION OF DATA STORED ON THE EQUIPMENT'S HARD DRIVE, OR ANY OTHER SPECIAL, INCIDENTAL OR CONSEQUENTIAL DAMAGES CAUSED BY THE USE, MISUSE OR INABILITY TO USE THE EQUIPMENT, REGARDLESS OF THE LEGAL THEORY ON WHICH THE CLAIM IS BASED, AND EVEN IF CANON USA HAS BEEN ADVISED OF THE POSSIBILITY OF SUCH DAMAGES. NOR SHALL RECOVERY OF ANY KIND AGAINST CANON USA BE GREATER THAN THE PURCHASE PRICE OF THE EQUIPMENT SOLD BY CANON USA AND CAUSING THE ALLEGED DAMAGE. WITHOUT LIMITING THE FOREGOING, YOU ASSUME ALL RISK AND LIABILITY FOR LOSS, DAMAGE OR INJURY TO YOU AND YOUR PROPERTY AND TO OTHERS AND THEIR PROPERTY ARISING OUT OF USE, MISUSE OR INABILITY TO USE THE EQUIPMENT NOT CAUSED DIRECTLY BY THE NEGLIGENCE OF CANON USA. (SOME STATES DO NOT ALLOW THE EXCLUSION OR LIMITATION OF INCIDENTAL OR CONSEQUENTIAL DAMAGES, SO THE ABOVE LIMITATION MAY NOT APPLY TO YOU). THIS WARRANTY SHALL NOT EXTEND TO ANYONE OTHER THAN THE ORIGINAL PURCHASER OF THIS EQUIPMENT OR THE PERSON FOR WHOM IT WAS PURCHASED AS A GIFT.**

This warranty gives you specific legal rights, and you may also have other rights which vary from state to state. CANON U.S.A., INC.

**CANADA**

## **CANON CONSUMER DIGITAL VIDEO EQUIPMENT LIMITED WARRANTY**

The limited warranty set forth below is given by Canon Canada Inc. ("Canon Canada") with respect to Canon Consumer Digital Video Equipment (the "Equipment") purchased in Canada. This limited warranty is only effective upon presentation of a bill of sale or other proof of purchase for this Equipment to a Canon Service Facility when repairs are required.

The Equipment is warranted under normal, non-commercial, personal use, against defective materials or workmanship as follows:

**Parts:** Defective parts will be exchanged for new parts or, at Canon Canada's option, comparable rebuilt parts for a period of one year from the date of original purchase, except Video Heads which will be exchanged for a period of 3 months from the date of purchase.

**Labour:** For a period of one year from the date of original purchase, labour will be provided free of charge by our Canon Service Facilities in Canada. This limited warranty covers all defects except where:

(a) The loss or damage to the product results from:

- i) accident, natural disaster, mishandling, abuse, neglect, unauthorized product modification or failure to follow instructions contained in the instruction manual;
- ii) the use of accessories, attachments, products, supplies, parts or devices with the Equipment that do not conform to Canon specifications or that cause abnormally frequent service problems;
- iii) repairs or services performed by any party other than a Canon Service Facility;
- iv) defective batteries or any exposure to water, sand or dirt;
- v) shipping (claim must be presented to the shipper);

(b) Any serial number on the video equipment is altered or removed.

(c) The Equipment is used for commercial, professional or industrial purposes.

This limited warranty does not cover the cabinet (exterior finish) of the Equipment, media, nor does it apply to Equipment purchased outside Canada. If the Equipment contains a hard disk drive, Canon Canada recommends that data stored on that drive be duplicated or backed up to prevent its loss in the event of a failure or other malfunction of such drive.

### **TO OBTAIN WARRANTY SERVICE**

Ship your Equipment in its original carton, box or equivalent, properly packed, fully insured with shipping charges prepaid, together with a copy of your bill of sale or other proof of purchase and a description of the problem to any of the Canon Service Facilities in Canada.

### **LIMITATIONS**

Except as otherwise required by applicable legislation, this warranty is in lieu of all other warranties, conditions, guarantees or representations, express or implied, statutory or otherwise, relative to the Equipment, including implied warranties or conditions of merchantability or fitness for a particular purpose.

Canon Canada assumes no liability for special, consequential or incidental damages, loss or corruption of data including, without limitation, data stored on the hard disk drive of the Equipment or loss that may arise, whether on account of negligence or otherwise, from the use, misuse or inability to use the Equipment (including loss of profit, revenue, media or enjoyment) or from failure to conform to any express or implied warranties, conditions, guarantees or representations. Any recovery under this limited warranty shall not exceed the purchase price of the equipment. Canon Canada does not assume or authorize any other person to assume for Canon Canada any other liability with respect to this equipment.

This warranty does not extend to any person other than the original purchaser of the Equipment or the person for whom it was purchased as a gift and states your exclusive remedy.

### **NOTICE TO CONSUMER**

If you plan to take important videos or if the product has not been used for some time, please check all functions with the instruction book before using it.

---

<b>USA</b>	<p><b>CANON U.S.A., INC. NEW JERSEY OFFICE</b> 100 Jamesburg Road, Jamesburg, NJ 08831 USA</p> <p><b>CANON U.S.A., INC. CHICAGO OFFICE</b> 100 Park Blvd., Itasca, IL 60143 USA</p> <p><b>CANON U.S.A., INC. LOS ANGELES OFFICE</b> 15955 Alton Parkway, Irvine, CA 92618 USA</p> <p><b>CANON U.S.A., INC. HONOLULU OFFICE</b> 210 Ward Avenue, Suite 200, Honolulu, HI 96814 USA</p> <ul style="list-style-type: none"><li>❖ If you have any questions, call the Canon U.S.A. Information Center toll-free at 1-800-828-4040 (USA only).</li></ul>
<b>CANADA</b>	<p><b>CANON CANADA INC.</b> 6390 Dixie Road, Mississauga, ON L5T 1P7</p> <p><b>CANON CANADA INC. CALGARY</b> 2828 16th Street NE, Calgary, AB T2E 7K7</p> <p><b>CANON CANADA INC. MONTREAL</b> 8801 Route Transcanadienne, Saint-Laurent, QC H4S 1Z6</p> <ul style="list-style-type: none"><li>❖ If you have any questions, call the Canon Canada Information Center toll free (in Canada only) at 1-800-OK-CANON (1-800-652-2666).</li><li>❖ Si vous avez des questions, veuillez téléphoner 1-800-OK-CANON (1-800-652-2666, sans frais au Canada seulement).</li></ul>
<b>MÉXICO</b>	<p><b>CANON MEXICANA, S DE RL DE CV</b> Bld. Manuel Ávila Camacho No. 138, Piso 17 Col. Lomas de Chapultepec, C.P. 11000 México, D.F., México</p> <p><b>CANON U.S.A., INC. NEW JERSEY OFFICE</b> 100 Jamesburg Road, Jamesburg, NJ 08831 USA</p>
<b>CENTRO Y SURAMÉRICA</b>	<p><b>CANON LATIN AMERICA, INC.</b> 703 Waterford Way, Suite 400, Miami, FL 33126 USA</p>
<b>ASIA</b>	<p><b>CANON HONGKONG COMPANY LTD.</b> 19/F, The Metropolis Tower, 10 Metropolis Drive, Hungghom, Kowloon, Hong Kong Tel: +852 3191 2333, Fax: +852 2428 3963</p>

---

For support concerning the supplied PIXELA software, please call PIXELA customer support (details in the PIXELA ImageMixer 3 SE Installation Guide).

## Free Manuals Download Website

<http://myh66.com>

<http://usermanuals.us>

<http://www.somanuals.com>

<http://www.4manuals.cc>

<http://www.manual-lib.com>

<http://www.404manual.com>

<http://www.luxmanual.com>

<http://aubethermostatmanual.com>

Golf course search by state

<http://golfingnear.com>

Email search by domain

<http://emailbydomain.com>

Auto manuals search

<http://auto.somanuals.com>

TV manuals search

<http://tv.somanuals.com>