

Canon

i550

Color Bubble Jet Printer

Quick Start Guide

Canon i550 Color Bubble Jet Printer Quick Start Guide.

Copyright

This manual is copyrighted by Canon U.S.A., Inc. with all rights reserved. Under the copyright laws, this manual may not be reproduced in any form, in whole or in part, without the prior written consent of Canon U.S.A., Inc.

© 2002 Canon U.S.A., Inc.

Disclaimer

Canon U.S.A., Inc. has reviewed this manual thoroughly in order that it will be an easy-to-use guide to your Canon i550 Color Bubble Jet Printer. All statements, technical information and recommendations in this manual and in any guides or related documents are believed reliable, but the accuracy and completeness thereof are not guaranteed or warranted, and they are not intended to be, nor should they be understood to be, representation or warranties concerning the products described.

Specifications are subject to change without notice.



As an ENERGY STAR partner, Canon U.S.A., Inc., has determined that this product meets the ENERGY STAR guidelines for energy efficiency.

All information regarding non-Canon products was compiled from publicly available information. No representation is made regarding the accuracy thereof.

Trademarks

Canon is a registered trademark of Canon Inc. PhotoRecord is a trademark of Canon Information System Research Australia. Macintosh, Mac and the Mac logo are registered trademarks of Apple Computer, Inc., registered in the U.S. and other countries. All other product and brand names are trademarks of their respective owners.

Canon U.S.A., Inc.
One Canon Plaza
Lake Success, NY 11042

Contents

Basic Printing

Turning the Printer's Power On	2
Loading Paper	3
Using Special Media	6
Printing with Windows	8
Printing with Macintosh	10

Advanced Printing

Applications Included in the CD-ROM Package	12
Printing photographs with Windows	13
Printing photographs with Macintosh	16
Accessing Printer Driver	20
Using Printer Driver Options.....	22

Printing Maintenance

Replacing an Ink Tank	23
When Printing Becomes Faint or Colors are Incorrect	28
Printing the Nozzle Check Pattern	29
Print Head Cleaning.....	31
Print Head Deep Cleaning.....	34
Aligning Print Head	36

Troubleshooting

Cannot Install the Printer Driver.....	40
Print Quality is Poor or Contains Errors	41
Troubleshooting Printer Hardware.....	43
Paper Does Not Feed Properly	44
Handling Error Messages	45
An Error Message Appears on the Screen	46

Appendix

User's Guide Table of Contents	47
Specifications	48
Safety Precautions	50
Regulatory Information	52
CANON LIMITED WARRANTY --- (USA Only).....	53

Index	55
--------------------	----

Basic Printing

 **Note** This Quick Start Guide describes some of the features of your i550 printer and how to use them. For more information, view the i550 User's Guide on the Setup Software & User's Guide CD-ROM, or use the online help in your printer interface:

Windows

While in the printer's Properties window press the F1 key, or click? in the upper right corner then click the feature you want to know more about, or click the Help button when displayed.

Macintosh

Turn Balloon Help on by selecting Help, then Show Balloon Help.

Turning the Printer's Power On

- 1** Turn on the printer by pressing the POWER button.

The POWER lamp flashes while the printer warms up and changes to steady (non-flashing) green when the printer is ready.

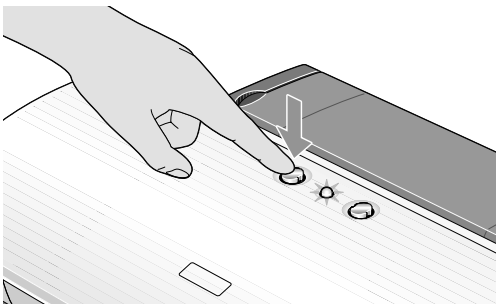

 **Note** If the POWER lamp changes to orange and begins flashing, refer to the section "**Handling Error Messages**" on page 45.

Loading Paper

■ Print Media to Avoid

Do not use the following types of paper. Using such paper will not only produce unsatisfactory results, but can also cause the printer to jam or malfunction.

- Folded, curled or wrinkled paper
- Damp paper
- Excessively thin paper (less than 64 gsm or 17 lb)
- Excessively thick paper* (more than 105 gsm or 28 lb)

*non-Canon branded paper

- Picture postcards
- Postcards affixed with photos or stickers
- Envelopes with double flaps
- Sealed envelopes
- Envelopes with an embossed or treated surface
- Any type of paper with holes (such as loose-leaf)

■ Loading the Print Media

In this example, description is provided of the steps used to load Plain Paper in your printer.

- For detailed information on the specialty media Canon provides for use with its various printers, refer to the section "**Using Special Media**" on page 6.
- Consult the *User's Guide* for detailed instructions on how to load envelopes and specialty media in the printer.

1 Flatten the four corners of the paper before loading it.

Important When paper is curled, hold the opposing curled corners and gently bend them in the opposite direction until the paper becomes completely flat.

2 Preparing to Load Paper

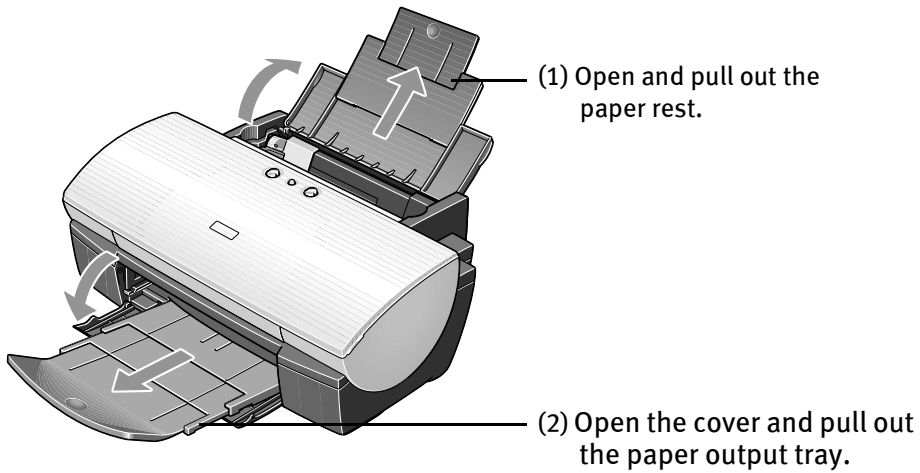

- (3) Open the front cover and adjust the paper thickness lever to the correct position for the media in use.
Move to the left position for plain paper.
Move to the right position for envelopes, Banner Paper and T-Shirt Transfers.

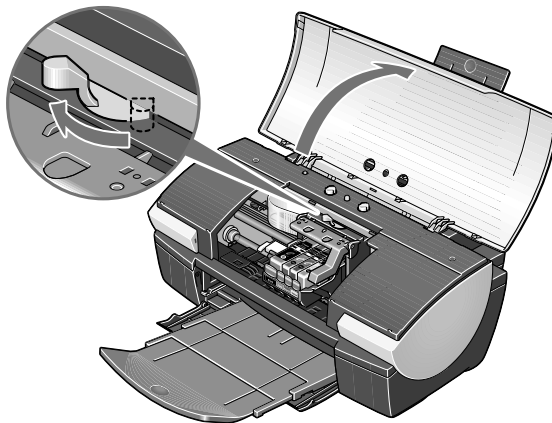

3 Loading the Paper

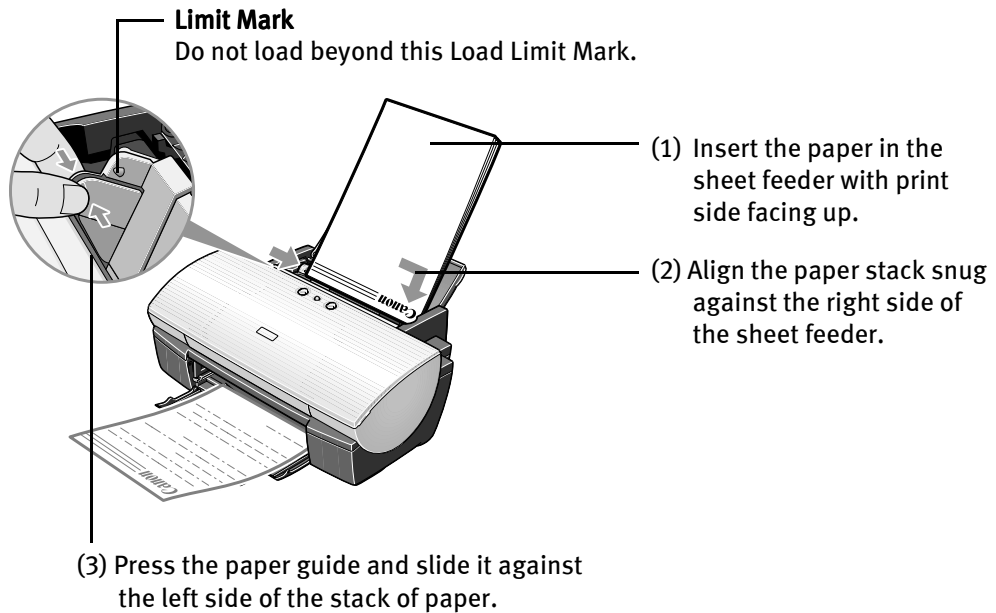

-  **Note**
- Do not stack more than 50 sheets in the paper output tray.
 - Do not touch the printed surfaces until the ink dries. For specific drying times, refer to the instructions packaged with your media.

Using Special Media

Canon recommends that you use genuine Canon media to insure optimal print quality.

■ Photo quality media

- Photo Paper Pro
- Photo Paper Plus Glossy
- Matte Photo Paper
- Glossy Photo Paper
- Glossy Photo Cards
- High Gloss Photo Film
- High Resolution Paper



■ Media suited to business documents

- High Resolution Paper
- Transparencies



■ Canon Special Media

Media Type	Paper Rest Load Limit	Paper Thickness Lever Position	Printer driver setting Media Type
Bubble Jet Paper	Up to 150 sheets	Left	Plain Paper
Brilliant White Paper	Up to 150 sheets	Left	
Banner Paper	1 sheet(can print up to 6 connected sheets)	Right	
Photo Paper Pro	Letter: Up to 10 sheets 4" x 6": Up to 20 sheets	Left	Photo Paper Pro*1*2
Photo Paper Plus Glossy	Letter: Up to 10 sheets 4" x 6":Up to 20 sheets	Left	Photo Paper Plus Glossy
Matte Photo Paper	Up to 10 sheets	Left	Matte Photo Paper
Glossy Photo Paper	Up to 10 sheets	Left	Glossy Photo Paper
High Resolution Paper	Up to 80 sheets	Left	High Resolution Paper
High Gloss Photo Film	1 sheet	Left	High Gloss Photo Film
Glossy Photo Cards	Up to 20 sheets	Left	Glossy Photo Paper *2
T-Shirt Transfers	1 sheet	Right	T-Shirt Transfer
Transparencies	Up to 30 sheets	Left	Transparency

-  **Note**
- For detailed description of print media types, refer to the *User's Guide*.
 - *1: When loading Letter size paper on the auto sheet feeder, do not load the paper at once. To avoid sticking, load the necessary number of paper (up to 10 sheets) one at a time.
 - *2: Print settings are much easier to select if you use the applications included on the *Setup Software & User's Guide CD-ROM* when printing with Photo Paper Pro (4" x 6") and Glossy Photo Cards.
For instructions on how to print from the software applications, refer to the *Photo Application Guide*.



Printing with Windows

Note Note that the names of features and functions listed in Print menus and dialog boxes may vary, depending on the software application you are using. The steps described in this section are for printing in Windows XP.

- 1 Create a document or open a file to print.
- 2 Open Printer Properties dialog box.
 - (1) Select **Print** from the application software's **File** menu.

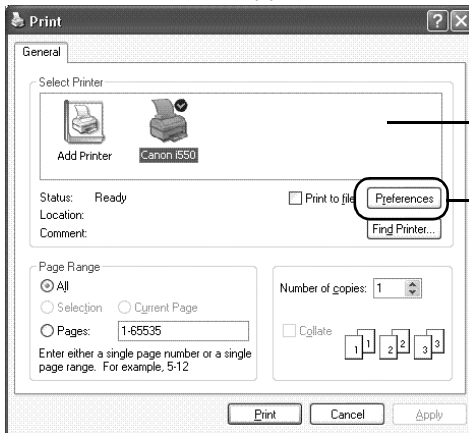

- (2) Ensure that **Canon i550** is selected.
- (3) Click **Preferences** (or **Properties**).

Note In Windows 2000, click the **Main** tab in the **Print** dialog box.

3 Specify the required settings.

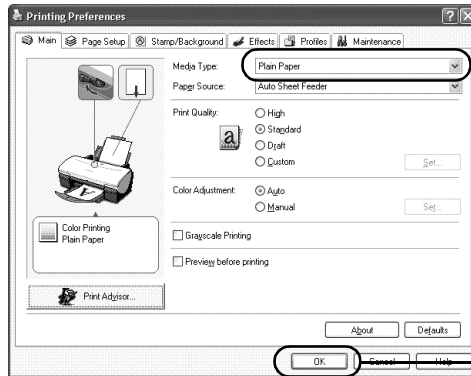

(1) Click **Media Type** to select the type of media loaded in the printer.

(2) Click **OK**.

-  **Note**
- From the Page Setup tab select the correct document size to be printed.
 - To adjust Print Quality settings, select **Custom** and click **Set**. You can control quality in the **Set Print Quality** dialog box.
 - For detail about other printer driver functions, refer to the *User's Guide* or Help.
 - Select **Preview before printing** by clicking the check box. This displays a preview screen that allows you to confirm the selected printing effects and how your document will look when printed. Some applications do not contain the function to display the preview.

4 Print the Document

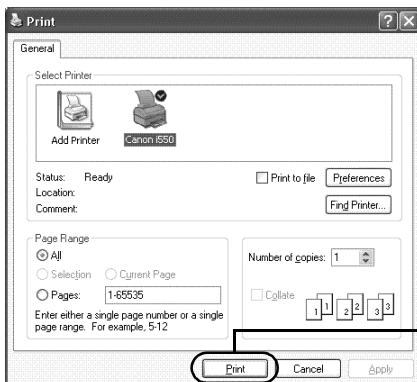

(1) Click **Print** or **OK**.

-  **Note** You can cancel a print job in progress by simply pressing the **RESUME/CANCEL**  button.

Macintosh

Printing with Macintosh

 **Note** The menu screens and dialog boxes that appear may vary, depending on the software application you are using. The steps described in this section are for printing Mac OS 9.

1 Create a document or open a file to print.

2 Select Paper Size

(1) Select the **Page Setup** from the application software's **File** menu.

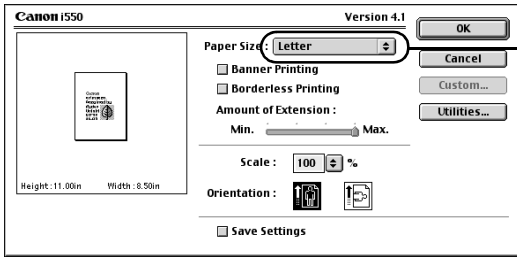

(2) Select the desired paper size from the **Paper Size** pull-down menu.

(3) Click **OK**.

3 Specify the required settings.

(1) Select **Print** from the application software's **File** menu.

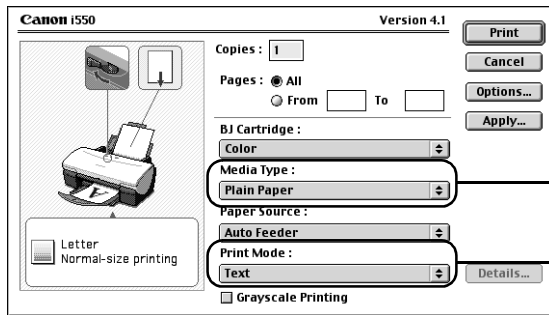

(2) Select the **Media Type** from the pull-down menu.

(3) Select a type of document from the **Print Mode** pull-down menu.

(4) Click **Print**.

**Note**

- When you select a type of document from the **Print Mode** pull-down menu, the document will be printed in colors and print quality suited to the characteristics of the **Media Type** you have selected.

Text: Select when printing documents consisting mainly of text.

Graphic: Select when printing documents consisting mainly of graphs and graphics (illustrations) with strong color definition.

Photo: Select when printing documents consisting mainly of photographs and graphics featuring fine color gradation.

Manual: If you select **Manual**, the **Details** button will become selectable. Click **Details** button to display the Detailed Setting dialog box where you can fine-tune the Print Quality and Halftoning settings.
Refer to the *User's Guide*.

- For detail about the printer driver functions, refer to the *User's Guide* or Help.
- You can cancel a print job in progress by simply pressing the **RESUME/CANCEL**  button.

Advanced Printing

Applications Included in the CD-ROM Package

The *Setup Software & User's Guide CD-ROM* includes photo applications designed to edit the photographs taken by digital camera and print them as photo-lab quality prints without standard white borders. Please use the application(s) suitable for your print purposes.



- Note**
- Applications are easy to install. Just go to *Easy Setup Instructions* and follow the instructions.
 - For detailed description of the various features of photo applications and instructions on their use, refer to the *Photo Application Guide* include on the *Setup Software & User's Guide CD-ROM*.

■ Easy-PhotoPrint (Windows)

You can make a Borderless Printing easily and quickly, just by selecting a photograph taken with a digital camera and the paper type on which to print. You can also use simple editing features such as trimming and image rotation. It is Exif Print (Exif 2.2) compatible.

■ ImageBrowser (Macintosh)

You can import photographs taken with a digital camera into the computer, edit and caption them. You can also make a Borderless Printing or Index Print without difficulty. It is Exif Print (Exif 2.2) compatible.

■ ZoomBrowser EX/PhotoRecord (Windows)

You can import photographs taken with a digital camera into the computer, edit and caption them, and print them in an album. PhotoRecord is Exif Print (Exif 2.2) compatible.

■ PhotoStitch (Windows/Macintosh)

You can merge a selected sequence of photographs to create a panoramic photo.



Printing photographs with Windows

This chapter describes only the steps used to print from photo applications included with your Setup Software and User's Guide CD-ROM using the Borderless Printing mode.

Note Media Types Suitable for Borderless Printing

Media types compatible with Borderless Printing include Photo Paper Plus Glossy (LTR, 4" x 6"), Photo Paper Pro (LTR), Matte Photo Paper (LTR), and Glossy Photo Paper (LTR).

Follow the simple steps below to create prints of digital camera photographs with Easy-PhotoPrint using the Borderless Printing function. Easy-PhotoPrint supports Exif Print (Exif 2.2).

- Exif Print (Exif2.2) is a new worldwide standard. Under Exif2.2, the digital camera can record data tags for specific camera settings and functions such as whether the flash was on or off, if the camera was in portrait or night scene mode, etc. BJ Printers support Exif Print and use Easy-PhotoPrint to read camera data precisely, producing optimal prints. This enables you to create prints that reproduce your vision more accurately than ever before.
- Easy-PhotoPrint can handle only JPEG files (filename extension: .jpg and .jpeg).

1 Start Easy-PhotoPrint.

- (1) Insert the memory card in the computer.

This chapter describes only the steps used for printing the photographs stored in the card as an example. We recommend you consult your memory card documentation for instructions on how to set the memory card in the computer.

- (2) Click **Start**, select **All Programs** (or **Programs**), **Canon Utilities**, **Easy-PhotoPrint**, and then **Easy-PhotoPrint**. The **1.Image Selection** sheet is displayed.

2 Select photographs.

- (1) Select the folder containing the photograph you want to print. (Select memory card folder, then the folder containing the digital photographs.) All photographs in the selected folder are displayed.

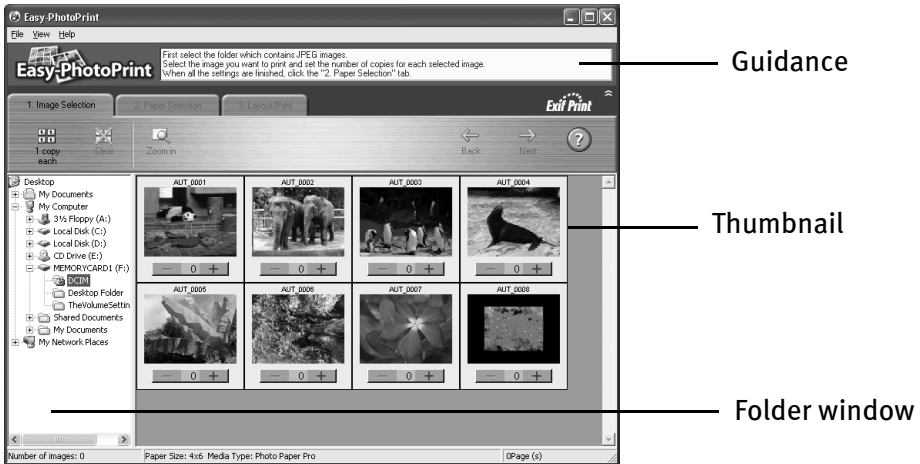

- (2) Click the **[+]** button on the thumbnail of the photograph you want to print and specify the number of copies.

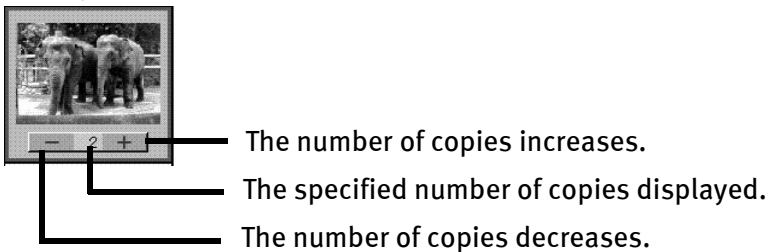

3 Select the paper.

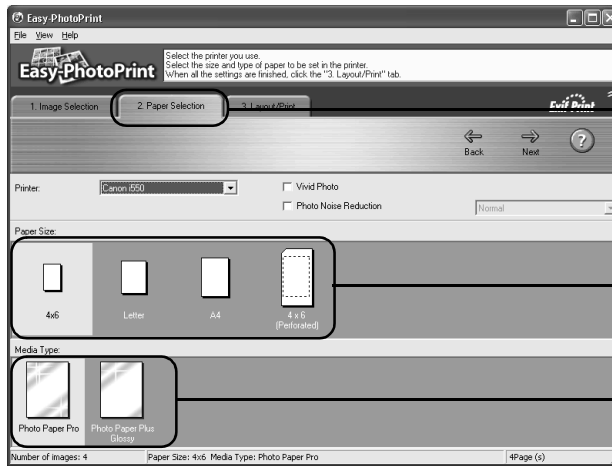

(1) Click the **2.Paper Selection** tab.

(2) Select the size of the paper you use from **Paper Size**.

(3) Select the type of the paper you use from **Media Type**.

4 Select the layout.



(1) Click the **3. Layout/Print** tab.

(2) Select **Borderless(full)**.

(3) Load the media type specified in the **2.Paper Selection** tab.

(4) Click **Print**.

Printing photographs with Macintosh

This chapter describes only the steps used to print from photo applications included with your Setup Software and User's Guide CD-ROM using the Borderless Printing mode.

 **Note** **Media Types Suitable for Borderless Printing**

Media Types compatible with Borderless Printing include Photo Paper Plus Glossy (LTR, 4" x 6"), Photo Paper Pro (LTR), Matte Photo Paper (LTR), and Glossy Photo Paper (LTR).

Follow the simple steps described below and learn how to create color prints of digital camera photographs with ImageBrowser using Borderless Printing.

Exif Print (Exif2.2) is a new worldwide standard. Under Exif2.2, the digital camera can record data tags for specific camera settings and functions such as whether the flash was on or off, if the camera was in portrait or night scene mode, etc.

BJ Printers support Exif Print and use ImageBrowser to read camera data precisely, producing optimal prints.

This enables you to create prints that reproduce your vision more accurately than ever before.

1 **Start ImageBrowser.**

- (1) Insert the memory card in the computer.

This chapter describes the steps used for printing the photographs stored in the card. We recommend you consult your memory card documentation for instructions on how to set the memory card in the computer.

- (2) Double-click the **Canon ImageBrowser** (alias) icon on the desktop.

If the Canon ImageBrowser icon is not displayed on the desktop, open the Canon ImageBrowser folder, in which the ImageBrowser program has been installed, and double-click the **ImageBrowser** icon in the folder.

2 Select photographs.

- (1) Select the folder containing the photograph you want to print. (Select memory card folder, then the folder containing the digital photographs.)

All photographs in the selected folder are displayed.

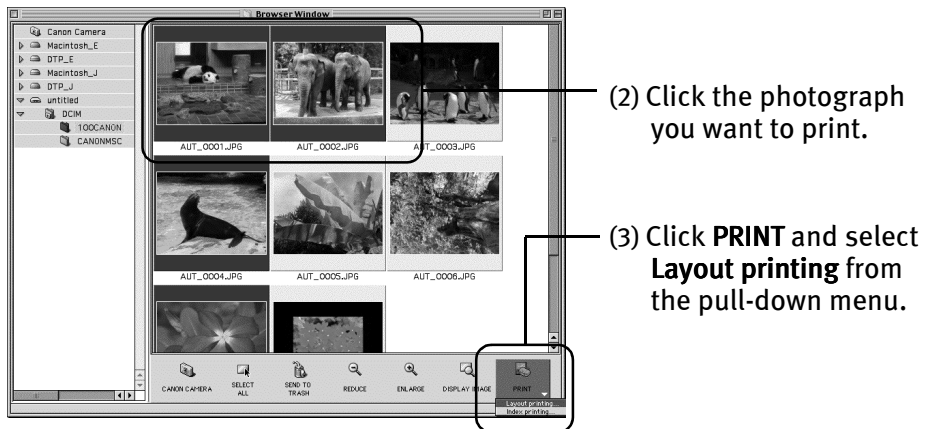

The **Layout Options** dialog box appears and layout selection wizard starts.

3 Enter layout options.

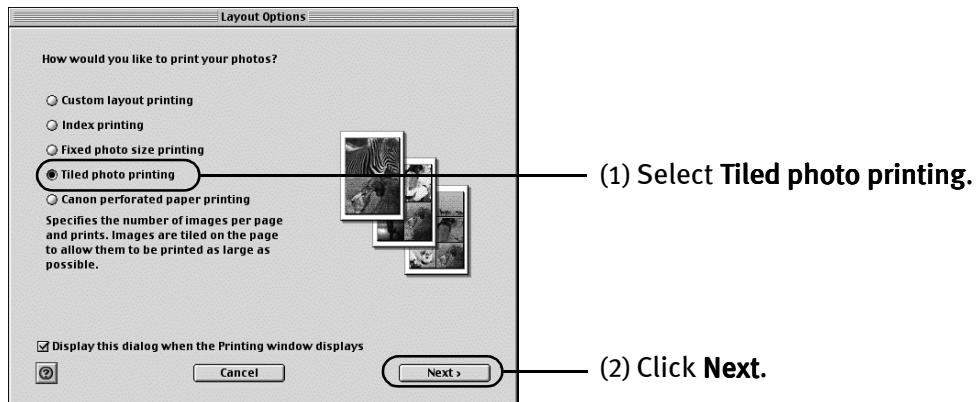

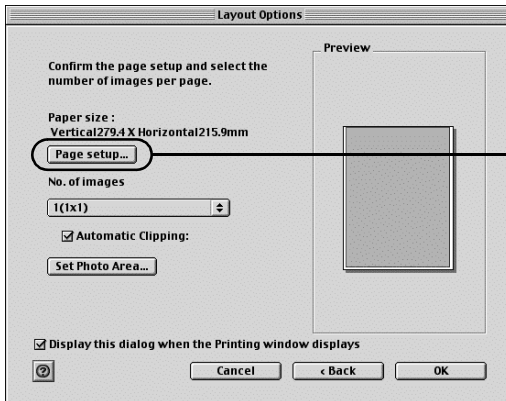

(3) Click **Page setup...**

4 Select Borderless Printing.

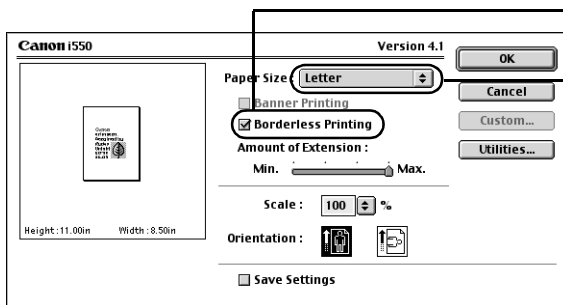

(1) Select **Borderless Printing**.

(2) Select a paper size from the **Paper Size** pull-down menu. The menu only displays those paper sizes compatible with Borderless Printing.

(3) Click **OK**.

A message box pops up, displaying the information about printing. Read the message and click **OK**.

This returns you to the **Layout Options** dialog box.

5 Specify the number of photographs to print on one page.

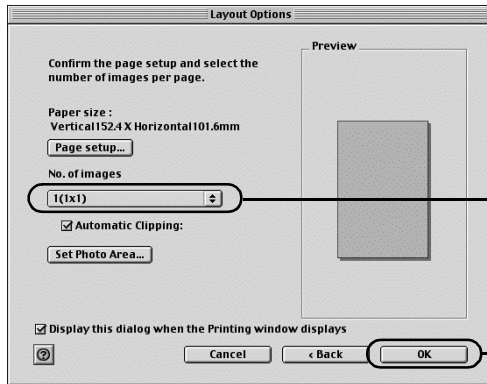

(1) Select **1(1×1)** from the **No. of images** pull-down menu.

(2) Click **OK**.

6 Print the photograph.



(1) Click **PRINT**.

The Print dialog box is displayed.

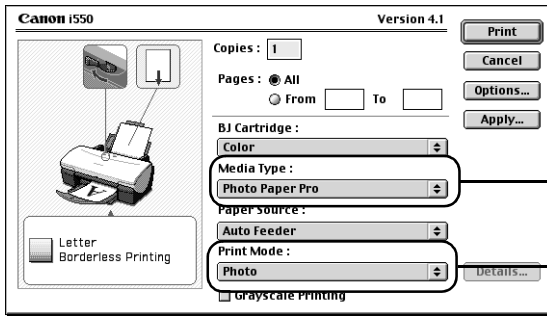

(2) Select a type of media for printing from the **Media Type** pull-down menu.

(3) Select **Photo** from the **Print Mode** pull-down menu.

(4) Load the selected paper in the printer.

(5) Click **Print**.

Accessing Printer Driver

The **Printer Properties** dialog box can be opened from either within an application, or directly from the Windows **Start** menu.

-  **Note**
- This manual refers to Windows XP operation. The operations may vary depending on your operating system.
 - Depending on your application program, the command and menu names may differ, and there may be more steps involved in opening the Printer Properties dialog box. For further details, see the user's manual for your application.

■ Opening the Printer Properties dialog box from your application program

1 In your application, select the command to print a document.

The **Print** dialog box can usually be opened by selecting **Print** from the **File** menu.

2 Ensure that Canon i550 is selected. Then click Preferences (or Properties).

The **Printer Properties** dialog box opens.

■ Opening the Printer Properties dialog box directly from the Start menu

This method is used for maintenance operations such as print head cleaning, or to specify printer settings common to all application programs.

When the **Printer Properties** dialog box is opened from the **Start** menu, additional tabs appear, including the **Details** tab. These do not appear when the Printer Properties dialog box is opened from within an application.

For further information about these additional tabs, refer to your Windows documentation.

1 Click Start and select Control Panel, Printers and Other Hardware, and then Printers and Faxes.

For non-XP Windows, Click **Start**, select **Settings**, and then **Printers**.

2 Select the Canon i550 icon.

3 Open the File menu and select Printing Preferences (or Properties).

In Windows NT 4.0, Select **Document Defaults...**

The **Printer Properties** dialog box opens.

Using Printer Driver Options

Getting to know the basic features of your printer driver will provide you with sufficient expertise to print a wide range of images and documents. The illustrations below provide a basic introduction to the many features offered by your printer driver.

 **Note** For detailed description of the printer driver functions, refer to the *User's Guide*.



Printing with Borderless Printing

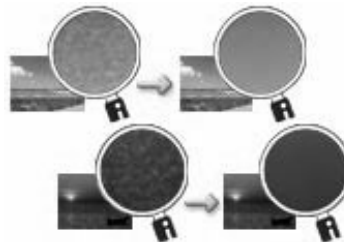

Reducing Noise from Images Recorded with Digital Camera

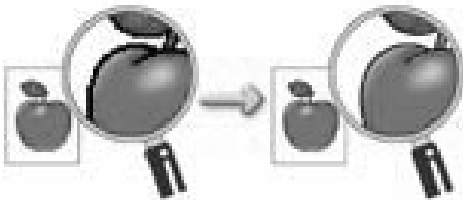

Smoothing the Rough Edges of Certain Images

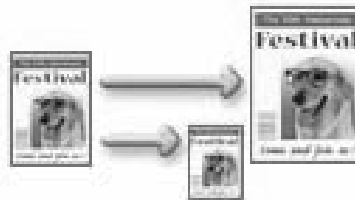

Automatically Resizing the Image to Fit the Page



Resizing the Image by Selecting the Scaling Ratio



Adding Illustrated Effect to Documents

Printing Maintenance

Replacing an Ink Tank

When replacing an ink tank, check the model number very carefully. The printer will not print properly if the wrong ink tank is used, or installed in the incorrect position.

With this printer, ink tanks must be installed from the right in the order indicated below.

- Yellow: BCI-3eY
- Magenta: BCI-3eM
- Cyan: BCI-3eC
- Black: BCI-3eBK

■ Knowing When to Replace Ink Tank

If an ink tank needs replacing, as soon as printing begins, the **POWER** lamp will change from green to orange and flash four times. It is important to quickly identify the empty tank using the BJ Status Monitor (Windows) or error messages (Macintosh) and replace it.

 **Note** Should missing characters or white streaks appear despite sufficient ink levels, refer to the section "**When Printing Becomes Faint or Colors are Incorrect**" on page 28

Windows

The following message appears when ink is empty. Printing will resume as soon as ink tank is replaced and the front cover is closed.

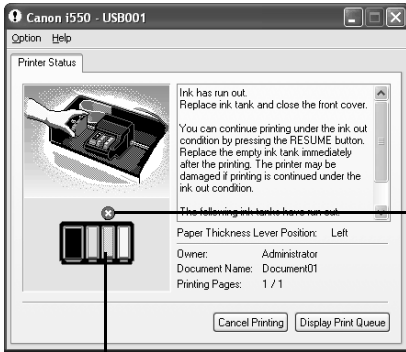

Empty ink tank

The ink tank with [X] symbol is out of ink. Replace with a new ink tank.

- Click **Cancel Printing** to cancel the current print job.
- Press the **RESUME/CANCEL** button to resume printing with an empty ink tank. When printing is finished, replace the ink tank immediately. If you continue printing with an empty ink tank, it will be a cause of trouble.
- Menu screens will vary to some degree, depending on your software environment.

Note When Low Ink is Detected

The BJ Status Monitor appears as soon as a print job starts. [!] Indicates ink low. Obtain a replacement tank as soon as possible.

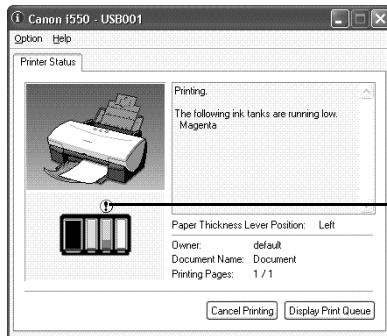

Tank with low ink level

Macintosh

The following message is displayed when ink tank is empty. Printing will resume as soon as ink tank is replaced and the front cover is closed.

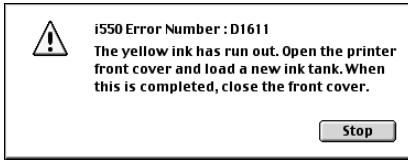

- Press the **RESUME/CANCEL** button to resume printing with the ink tank empty. When printing is finished, replace the ink tank immediately. If you continue printing with an empty ink tank, it will be a cause of trouble.

Note When Low Ink is Detected

The following message is displayed as soon as a print job starts.

[!] Indicates ink low. Obtain a replacement tank as soon as possible.

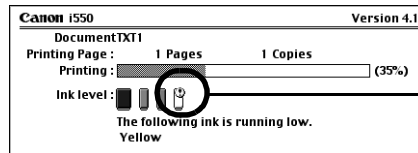

Tank with low ink level

■ Replacing Ink Tanks

When ink tanks run out of ink, replace them using the following steps.

1 Ensure that the printer is on, and then open the front cover.

The print head holder moves to the center.

2 Remove the empty ink tank.

(1) Push the tab and remove the ink tank.

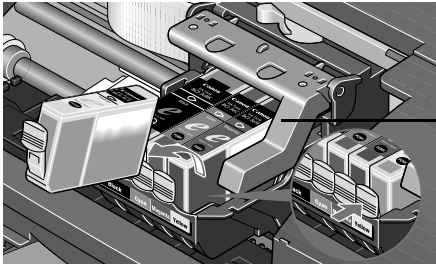

Do not touch the lock lever; remove only the ink tank.

- Important**
- Handle ink tanks carefully to avoid staining clothing or the surrounding area.
 - Discard empty ink tanks according to the local laws and regulations regarding disposal of consumables.

3 Prepare a replacement tank.

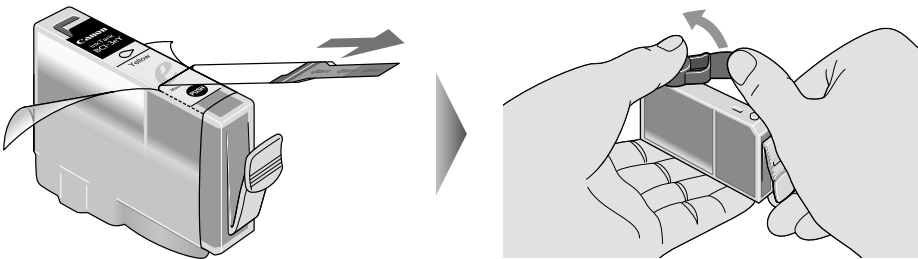

- (1) Unpack the new ink tank and pull off the orange tape.
- (2) Remove the orange protective cap from the bottom of the ink tank and discard it.

- Important**
- Do not squeeze the side of ink tanks as this may cause the ink to leak out and stain your clothes and hands.
 - Do not re-attach the protective cap once you have removed it.
 - Once the protective cap is removed, do not touch the open ink port.

4 Install the ink tank.

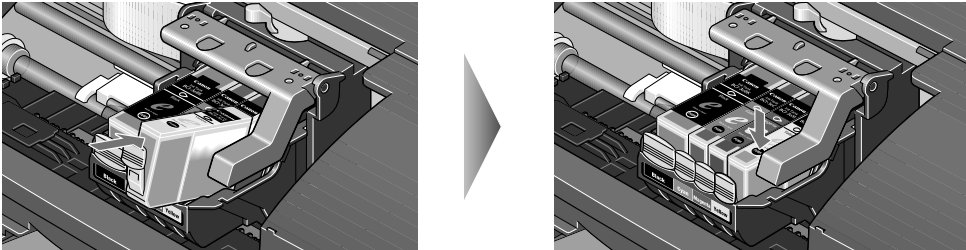

- (1) Insert the ink tank in the print head holder.
- (2) Press on the "PUSH" mark until the ink tank snaps firmly into place.

5 Close the front cover.

The print head holder moves to the right. The ink tank installation process is now complete.

-  **Note**
- To maintain optimal Print Quality, use an ink tank within six months of first use.
 - Once an ink tank has been used, do not remove it from the printer and leave it out in the open. An ink tank left out in the open and then reinstalled in the printer may not function.
 - Color ink consumption may occur even when black-and-white or grayscale printing is specified. Color ink is consumed in the head cleaning and deep cleaning, which are necessary to maintain the printer's capabilities.

When Printing Becomes Faint or Colors are Incorrect

When printing becomes faint or colors are incorrect, even if ink remains in the ink tanks, see if the print head nozzles are clogged and clean them first. Follow the procedures below and maintain the print head.

Important Before maintaining the print head, check the following;

- Open the front cover and make sure whether the ink tank contains ink. If it is out of ink, replace it.
- Ensure that all the orange tape of the ink tank has been peeled off.
- Press "PUSH" on the ink tank and ensure that the ink tank is installed securely.
- Increase the Print Quality setting in the printer driver settings.

Step 1

"Printing the Nozzle Check Pattern" on page 29

If the print quality is poor

If white stripes are noticeable

Step 2

"Print Head Cleaning" on page 31

Step 2

"Aligning Print Head" on page 36

If the problem remains

Step 3

"Print Head Deep Cleaning" on page 34



Note If print head maintenance does not resolve the problem, contact the Customer Care Center.

Printing the Nozzle Check Pattern

Print the nozzle check pattern to determine whether the ink ejects normally from the print head nozzles, and to verify print head alignment. Use this function when printed results are blurred or the color is incorrect.

 **Note** Nozzle check pattern printing can be executed also from the printer itself. With the printer on, load a sheet of Letter paper in the printer. Hold the **RESUME/CANCEL** button until the **POWER** lamp flashes twice.

Windows

- 1 With the printer on, load a sheet of Letter paper in the printer.
- 2 Open the Printer Properties dialog box.
See "**Opening the Printer Properties dialog box directly from the Start menu**" on page 21
- 3 Print the Nozzle Check Pattern.

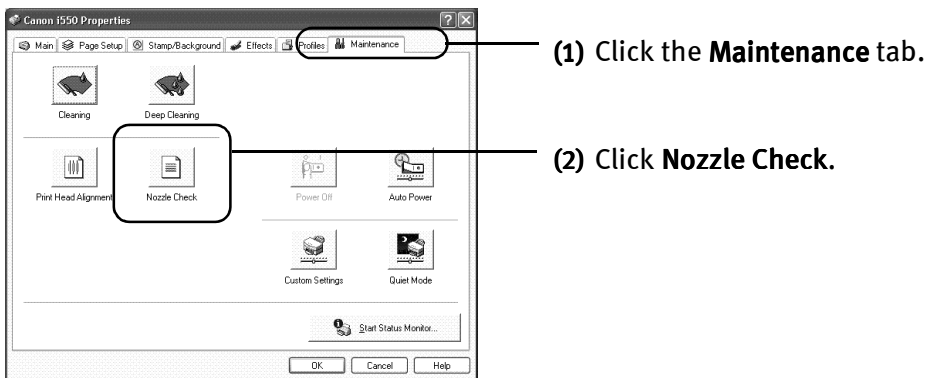

(3) When the confirmation message is displayed, click **OK**.

See "**Examining the Nozzle Check Pattern**" on page 31

Macintosh

- 1** With the printer on, load a sheet of Letter paper in the printer.
- 2** Open the **Printer Utility** dialog box.
 - (1) Select **Page Setup...** in the **File** menu
 - (2) Click **Utilities** to open the **Printer Utility** dialog box.
- 3** Print the Nozzle Check Pattern.

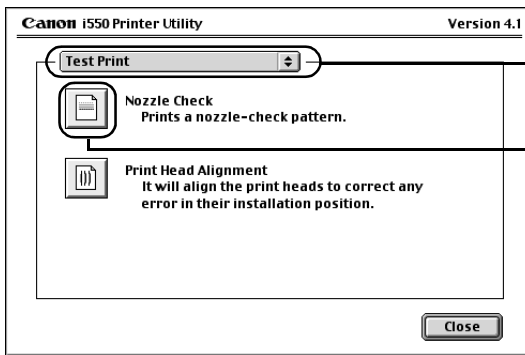

- (1) Select **Test Print** from the pull-down menu.
- (2) Click **Nozzle Check**.

(3) When the confirmation message is displayed, click **OK**.

See "**Examining the Nozzle Check Pattern**" on page 31

■ Examining the Nozzle Check Pattern

The nozzle check pattern should appear as follows when ink is discharged properly. Examine the nozzle check pattern output by the printer.

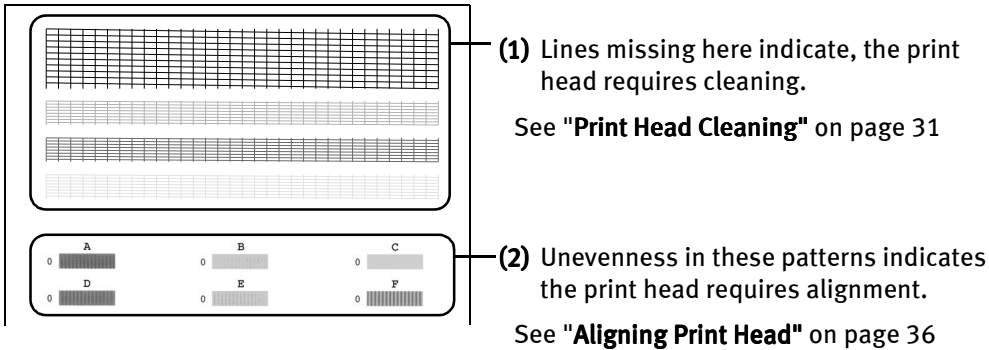

Print Head Cleaning

Clean the print head if you suspect that the nozzles might be clogged. Cleaning the print head consumes ink, so perform print head cleaning only when necessary.

Windows

- 1 Ensure that the printer is on.
- 2 Open the Printer Properties dialog box.

See "**Opening the Printer Properties dialog box directly from the Start menu**" on page 21

3 Start Print Head Cleaning.

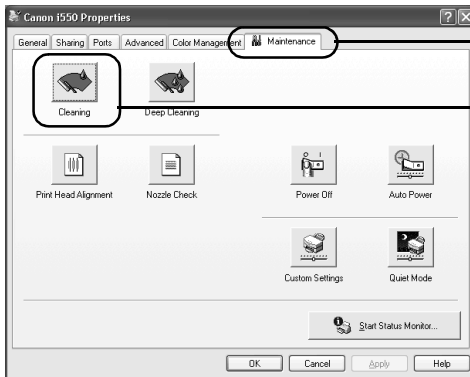

(1) Click the **Maintenance** tab.

(2) Click **Cleaning**.

(3) Select the ink nozzles to be cleaned, and then click **Execute**.

All colors: All nozzles

Black: Black ink nozzles

Color: Color ink nozzles

(4) When the message is displayed, click **OK**.

Macintosh

1 Ensure the printer is on.

2 Open the **Printer Utility** dialog box.

(1) Select **Page Setup...** in the **File** menu.

(2) Click **Utilities** to open the **Printer Utility** dialog box.

3 Start Print Head Cleaning.

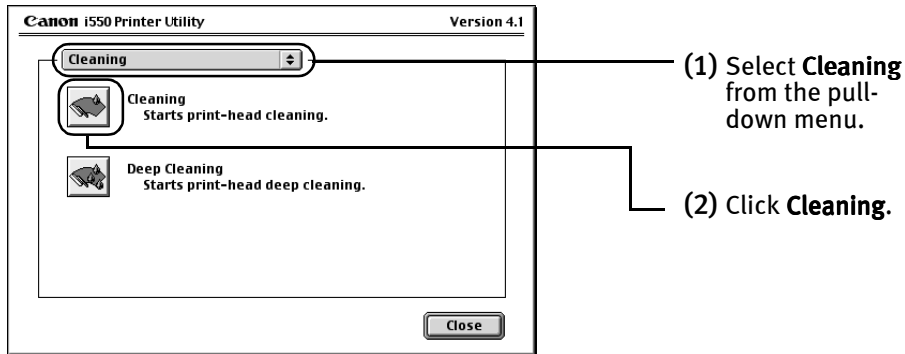

(1) Select **Cleaning** from the pull-down menu.

(2) Click **Cleaning**.

(3) Select the ink nozzles to be cleaned, and then click **OK**.

All colors: All nozzles

Black: Black ink nozzles

Color: Color ink nozzles

(4) When the message is displayed, click **OK**.

Important Do not perform any other operations until the print head cleaning finishes. This takes about 50 seconds.

-  **Note**
- Print head cleaning can be performed also from the printer itself. Ensure the printer is on. Hold down the **RESUME/CANCEL** button until the **POWER** lamp flashes once.
 - After print head cleaning finishes, print the nozzle check pattern to verify that the print head nozzles are clean.

See "**Printing the Nozzle Check Pattern**" on page 29

Print Head Deep Cleaning

If print quality does not improve by standard print head cleaning, try print head deep cleaning, which is a more powerful process. Print head deep cleaning consumes ink, so perform this procedure only when necessary.

Windows

1 Ensure the printer is on.

2 Open the Printer Properties dialog box.

See "**Opening the Printer Properties dialog box directly from the Start menu**" on page 21

3 Start Print Head Deep Cleaning.

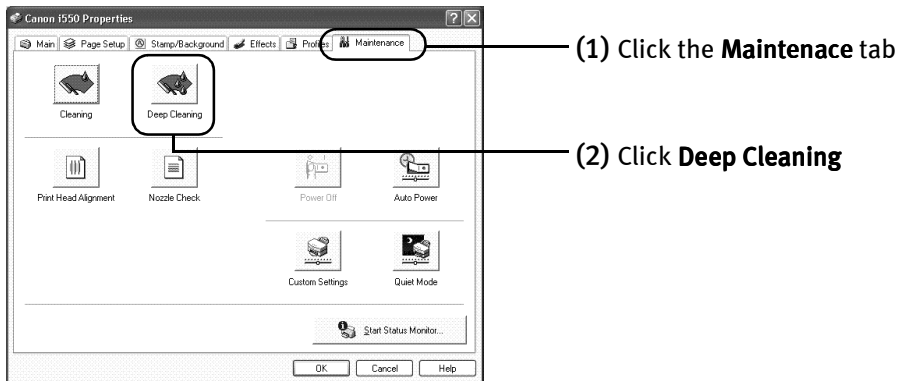

(3) Select the ink nozzles to be cleaned, and then click **OK**.

- All colors:** All nozzles
- Black:** Black ink nozzles
- Color:** Color ink nozzles

(4) When the message is displayed, click **OK**.

Macintosh

- 1 Ensure the printer is on.
- 2 Open the Printer Utility dialog box.
 - (1) Select **Page Setup...** in the **File** menu.
 - (2) Click **Utilities** to open the **Printer Utility** dialog box.
- 3 Start Print Head Deep Cleaning.

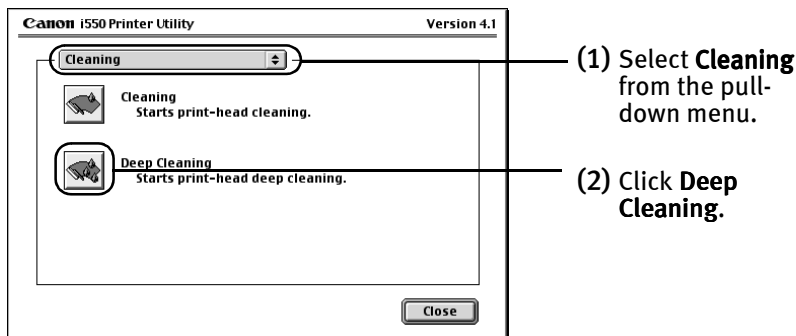

- (3) Select the ink nozzles to be cleaned, and then click **OK**.

All colors: All nozzles

Black: Black ink nozzles

Color: Color ink nozzles

- (4) When the message is displayed, click **OK**.

Important The process takes one or two minutes to complete, so simply wait until the **POWER** lamp stops flashing.

 **Note** After print head deep cleaning finishes, print the nozzle check pattern to verify that the print head nozzles are clean.

See "**Printing the Nozzle Check Pattern**" on page 29

If the print head is still not clean after the second deep cleaning, the print head may be worn out. In this event, contact the Customer Care Center.

Aligning Print Head

Aligning the print head position allows you to print without shifts in the color registration.

Windows

1 With the printer on, load a sheet of Letter paper in the printer.

2 Open the Printer Properties dialog box.

See "**Opening the Printer Properties dialog box directly from the Start menu**" on page 21

3 Print the pattern.

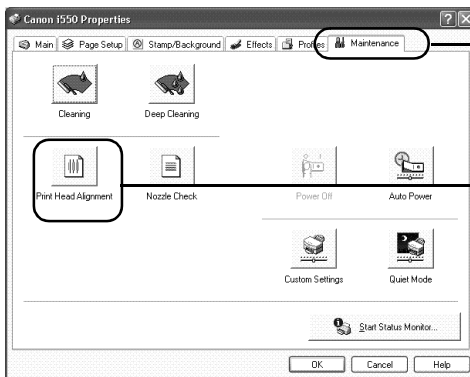

(1) Click the **Maintenance** tab.

(2) Click **Print Head Alignment**.



(3) When the confirmation message is displayed, click **OK**.

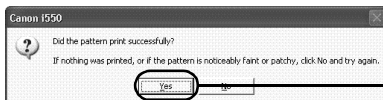

(4) After the pattern is printed, click **Yes**.

4 Align the Print Head.

- (1) Look at the print-out. From the patterns, select the most even, least irregular patterns and enter the number that corresponds.

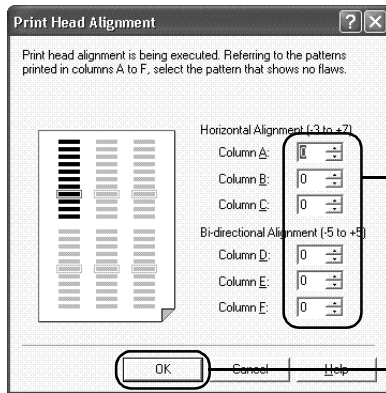

(2) Enter the numbers.

(3) Click **OK**.

Note If this is difficult to pick up the best pattern on Column F, pick the setting that procedures the least noticeable vertical white stripes.

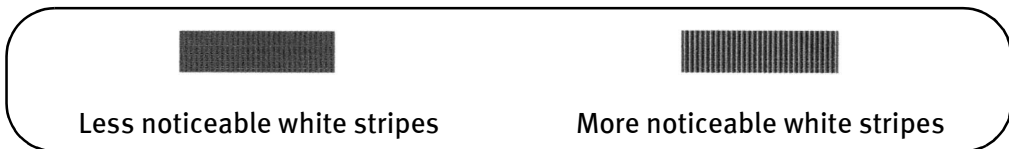

- (4) When the confirmation message is displayed, click **OK**.

Macintosh

- 1 Ensure the printer is on.
- 2 Open the Print Utility dialog box.
 - (1) Select **Page Setup...** in the **File** menu.
 - (2) Click **Utilities** to open the **Printer Utility** dialog box.

3 Print the pattern.

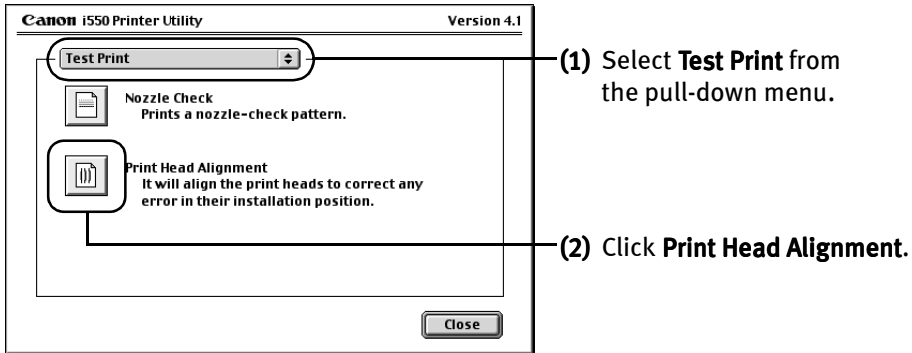

4 Align the Print Head.

(1) Look at the print-out. From the patterns, select the most even, least irregular patterns and enter the number that corresponds.

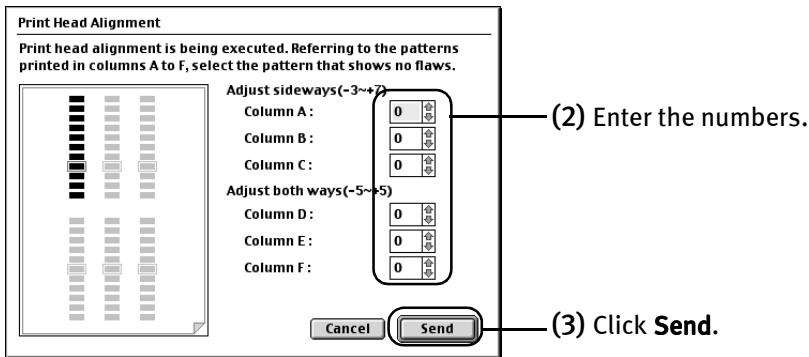

 **Note** If this is difficult to pick up the best pattern on Column F, pick the setting that procedures the least noticeable vertical white stripes.

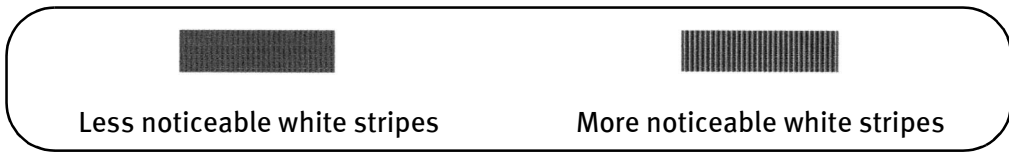

(4) Click **Close**.

(5) Click **OK**.

Troubleshooting

This section provides troubleshooting tips for the most common printing problems. Troubleshooting usually falls into one of the following categories. Refer to the User's Guide for additional information on topics not covered in this section.

- "Cannot Install the Printer Driver" on page 40
- "Print Quality is Poor or Contains Errors" on page 41
- "Troubleshooting Printer Hardware" on page 43
- "Paper Does Not Feed Properly" on page 44
- "Handling Error Messages" on page 45
- "An Error Message Appears on the Screen" on page 46



Note

Windows

When error occurs

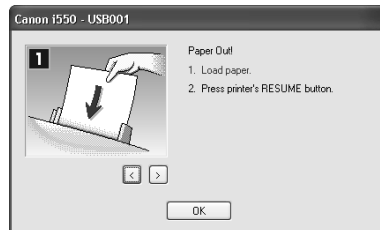

The BJ Status Monitor opens and displays a message when an error occurs. Take the appropriate action described in the message.

The message may vary depending on your operating system.





When using Windows Me, Windows 98 or Windows 95, click the **Guide** tab and follow the on-screen instructions.

Cannot Install the Printer Driver

Problem	Possible Cause	Try This
Cannot Install the Printer Driver	Installation procedure not followed correctly	<p>Follow the installation instructions from the <i>Easy Setup Instructions</i> packaged with your printer.</p> <p>Windows  Note If the installer was forced to terminated due to an error, Windows may be unstable. Remove the CD-ROM from the CD-ROM drive and restart the computer. Try reinstalling the printer driver.</p> <p>If the problem persists, refer to your Windows documentation for more information.</p>
	Other applications running in the background	Other open applications on your computer can interfere with the installation routine. Close all open software applications before reinstalling the printer driver. Refer to the <i>Easy Setup Instructions</i> for installing the printer driver.
	Installation does not start automatically when the CD-ROM is inserted into the drive	<p>Windows If printer driver installation did not start automatically when you inserted the CD-ROM into the CD-ROM drive:</p> <ol style="list-style-type: none"> 1. Click Start and select My Computer. 2. Double-click the CD-ROM icon. <p>For non-XP Windows, open the My Computer window, and then double-click the CD-ROM icon.</p> <p>Macintosh Double-click the CD-ROM icon on your desktop to start installation.</p>
	Installation CD-ROM not working properly	<p>Confirm that there are no problems with the Setup Software & User's Guide CD-ROM.</p> <p>Windows Use Windows Explorer to confirm that the CD-ROM can be read.</p> <p>Macintosh Confirm that the CD-ROM icon is displayed on the desktop.</p> <p>If there is any problem with the CD-ROM, contact the Customer Care Center.</p>
	Unable to proceed beyond the Printer Port screen	<p>Windows</p>  <p>Reinstall the printer driver</p> <ol style="list-style-type: none"> 1. Click Cancel. 2. When the Terminate Installation screen is displayed, click OK. 3. Click Exit, then remove the CD-ROM. 4. Turn the printer off. 5. Restart the computer. 6. Carefully follow the procedures described in the <i>Easy Setup Instructions</i> and reinstall the driver.

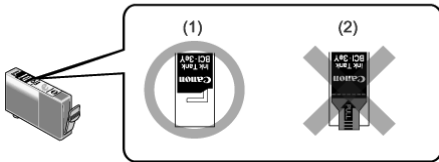

Print Quality is Poor or Contains Errors

Problem	Possible Cause	Try This
<p>Ink does not come out/ Printing is Blurred/ Colors are Wrong / White Streaks</p>	<p>Ink tank is not seated properly/Ink tank is empty</p>	<p>Check that the ink tanks are firmly seated in the print head and reseal them if necessary.</p> <ul style="list-style-type: none"> Check to see if all the orange tape has been peeled off as shown in (1). If there remains a part of the orange tape as shown in (2), remove it thoroughly.  <p>If ink tank is empty: See "Replacing an Ink Tank" on page 23</p>
<p>Media not loaded print-side up</p>	<p>Media not loaded print-side up</p>	<p>Check that your paper is loaded with the correct print side facing up.</p> <p> Note Follow the instructions packaged with your specialty media for loading and handling.</p>
<p>Incorrect paper type</p>	<p>Incorrect paper type</p>	<p>Windows On the Main tab, confirm that the Media Type selected matches the paper loaded.</p> <p>Macintosh In the Print dialog box, confirm that the Media Type selected matches the paper loaded.</p>
<p>Print head nozzles clogged or misaligned</p>	<p>Print head nozzles clogged or misaligned</p>	<p>Print the nozzle check pattern to check for uneven ink output. When a specific color is missing from the nozzle check pattern, clean the print head.</p> <ul style="list-style-type: none"> If ink supply is uneven: See "Print Head Cleaning" on page 31 If straight lines are misalign: See "Aligning Print Head" on page 36 <p> Note The ink tank may be clogged with dust or air if the protective cap is replaced after the removal.</p>
<p>Print Quality not set properly</p>	<p>Print Quality not set properly</p>	<p>Be sure to set the Print Quality setting to High.</p> <p>Windows On the Main tab, click High for the Print Quality setting.</p> <p>Macintosh</p> <ol style="list-style-type: none"> Select Manual in the Print Mode pull-down menu in the Print dialog box and then click Details. Click the Quality icon and then drag the Print Quality slide bar to the Fine end.

Troubleshooting

Problem	Possible Cause	Try This
Printed Paper Curls or Ink Blots	Printed paper too thin	Use High Resolution Paper or Photo Paper Pro to print images that require a lot of ink (i.e. pictures with intense colors or photographs).
	Color Intensity setting is too high	Reduce the Intensity setting in the printer driver and try printing again. Windows 1. Open the Printer Properties dialog box. 2. On the Main tab, select Manual for Color Adjustment , and then click Set . 3. Drag the Intensity slide bar to adjust the intensity. Macintosh 1. Open the Print dialog box. The Print dialog box can be opened by selecting Print in the File menu. 2. In the Print Mode pull-down menu, select Manual and then click Details . 3. Click the Color icon, then drag the Intensity slide bar to set the intensity.
	Paper feed roller is dirty	Clean the paper feed roller. See " Paper Does Not Feed Properly " on page 44
Printed Surface is Scratched	Inappropriate paper type used	Check to see if the paper you are printing on is too thick or curled. See " Print Media to Avoid " on page 3 Note that smudging may occur at the top and bottom edges of the paper when using Borderless Printing. Make sure that the paper you are using is compatible with Borderless Printing. See " Media Types Suitable for Borderless Printing " on page 13
	Incorrect position of the paper thickness lever	When printing on thick paper, set the paper thickness lever to the "✉" mark. This widens a gap between the print head and the paper. If the paper is scratched even when printing on plain paper, also try this.

Troubleshooting Printer Hardware

Problem	Possible Cause	Try This
Printer Does Not Start or Printer Stops During Print Jobs	Print head has overheated due to long periods of continuous printing	<p>Stop printing and turn the printer off for at least 15 minutes to allow the print head to cool down.</p> <p>The print head tends to overheat when printing continuously for long periods of time. The print head is designed to automatically pause at line breaks before resuming printing in order to cool down.</p> <p>Caution The area around the print head can become extremely hot during extended print operation. Always avoid touching the print head and its peripheral components.</p>
	Printing high-resolution photographs and graphics	<p>Wait until the print job finishes.</p> <p>The POWER lamp flashes green while the print data is being processed. Printing photographs and high-density graphics can take time.</p>
	Printer cable is too long	<p>Avoid using printer (parallel) cables longer than 6.5 feet and USB cables longer than 16.4 feet.</p>
	There may be problems in your operating system	<p>Restart your computer. It may solve the problem.</p> <p>Delete an undesired print job if there is any. Use BJ Status Monitor in Windows or BJ Print Monitor in Macintosh for the deletion.</p> <p>Windows</p> <ol style="list-style-type: none"> 1. Open the Printer Properties dialog box. See "Opening the Printer Properties dialog box directly from the Start menu" on page 21 2. Click Maintenance tab and then Start Status Monitor. 3. Click Display Print Queue. 4. Select Cancel All Documents in the Printer menu. Click Yes when a confirmation message appears. The print job is deleted. <p> Note In Windows Me, Windows 98 or Windows 95 Click to select an undesired document and select Purge Print Documents in the Printer menu.</p> <p>Macintosh</p> <ol style="list-style-type: none"> 1. Double-click BJ Print Monitor in the Extensions in the System Folder. 2. Click to select an undesired document and click . <p>The print job is deleted.</p>
Cannot Print to End of Job	Incorrect page size selected	<p>Verify that the page size setting matches the size of the paper loaded in the printer:</p> <ul style="list-style-type: none"> - Check the Paper Size setting from within your application to ensure that it matches the size of the paper load. - Check the Page Setup tab in the Printer Properties dialog box (for Windows) or the Page Setup dialog box (for Macintosh) to ensure that it matches the size of the paper loaded.
	Not enough free space on hard disk	<p>Your operating system may be out of free disk space. Check the available space on your computer's hard disk.</p>

Paper Does Not Feed Properly

Problem	Possible Cause	Try This
Paper Does Not Feed Properly	Inappropriate paper type used	Check to see if the paper you are printing on is too thick or curled. See " Print Media to Avoid " on page 3
	Paper feed roller is dirty	<p>Follow the steps described below to clean the paper feed rollers.</p> <p>If envelopes or post cards do not feed properly, even after correcting any paper curl, clean the paper feed roller.</p> <ol style="list-style-type: none"> 1. Ensure the printer is on and there is no paper loaded in the printer. 2. Hold the RESUME/CANCEL button down and release after the POWER lamp flashes three times. The paper roller rotates as it cleans. Repeat this cleaning operation three times. 3. Load a sheet of Letter sized plain paper in the printer. 4. Hold the RESUME/CANCEL button down and release after the POWER lamp flashes three times, then feed the sheet of paper. Repeat this operation three times. <p>If the printer still does not feed the envelopes or the post cards properly through the printer, even after the cleaning operation, repeat the procedures.</p>
	Paper Jams	<ol style="list-style-type: none"> 1. Gently pull the jammed paper out of the sheet feeder slot or the paper output slot, whichever is easier. <ul style="list-style-type: none"> •If the paper tears and some of it is left in the printer, turn the printer off, then open the front cover and remove the piece of paper. Do not touch internal parts in the printer. If you cannot reach or remove the torn paper, do not attempt to disassemble the printer yourself. Contact the Customer Care Center. •If you cannot extract the paper, turn the printer off, and then turn it back on. The remaining paper will be ejected automatically. 2. Close the front cover and reload the paper into the paper rest, then press the RESUME/CANCEL button on the printer.





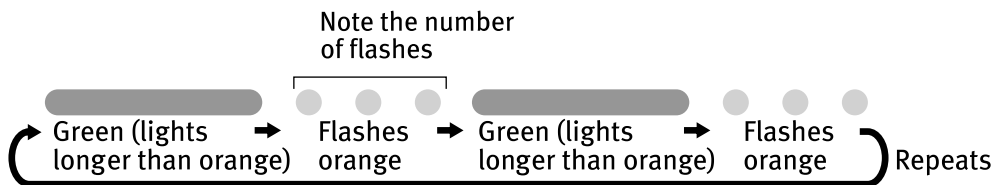

Handling Error Messages

When a printer error occurs, the POWER/ERROR lamp flashes. The number of flashes indicate the type of error that has occurred. Count the flashes and take the appropriate action to correct the error.



Number of flashes	Possible Cause	Try This
Two flashes	Indicates printer is out of paper	Reload paper and press the RESUME/CANCEL button.
Three flashes	Indicates paper jam	If a paper jam occurs, clear the jammed paper, reload paper in the printer, then press the RESUME/CANCEL button. See " Paper Jams " on page 44
Four flashes	Indicates empty ink tank	Press the RESUME/CANCEL button to resume printing with ink out condition. Replace with a new ink tank immediately after the printing. It may damage the printer if you continue printing with ink out condition. See " Replacing an Ink Tank " on page 23
Six flashes	Indicates print head not installed	Install print head. If print head is already installed, remove the print head and check the contacts for foreign matter, then reinstall. After reinstall the print head, you may need to realign it.
Seven flashes	Indicates defective print head	Remove the print head and check the contacts for foreign matter, then reinstall. If the print head fails to work properly after reinstalling it, contact the Customer Care Center.
Eight flashes	Indicates waste ink tank almost full	The printer has a built-in waste ink tank to hold the ink consumed during print head cleaning. Eight flash indicates that this tank is nearly full. Press the RESUME/CANCEL button to clear the error so printing can continue. Contact the Customer Care Center.
Note	POWER lamp flashes alternately green and orange	An error that requires contacting the Customer Care Center may have occurred. Turn off and unplug the printer from the power supply. Then plug the printer back in and turn it back on. Should the problem persist, contact the Customer Care Center.

An Error Message Appears on the Screen

Problem	Possible Cause	Try This
 Error Writing / Output to LPT1 or USBxxx	Printer not ready	The power lamp will flash green when the printer is warming up or when a print job is being sent to the printer. It will glow a steady(non-flashing)green when it is ready for use or when the print job is completed.
	Paper is not loaded.	Load paper and press the RESUME/CANCEL button.
	Faulty connection	Ensure the printer cable is securely connected to the computer.  Note If you are using switching hub or other device, disconnect the printer and reconnect it directly to the computer and try printing again. If successful, there may be a fault in the device. There could also be a problem with the cable(s). Replace the cable(s) and try printing again.
	Printer driver does not installed properly.	Uninstall then reinstall the printer driver. <ol style="list-style-type: none"> 1. Click Start, select All Programs (or Programs), Canon i550, and Uninstall. 2. Follow the on-screen instructions to uninstall driver. Follow the procedures described in the <i>Easy Setup Instructions</i> and reinstall the printer driver.
 “Error No.: X202”	Not enough memory	Not enough memory for printing. Increase available memory by closing any other applications currently running.
 “Error No.: X203”	Printer driver fault	There is a problem with the printer driver. Uninstall, then reinstall printer driver. Refer to the <i>User’s Guide</i> for instructions on how to uninstall the printer driver.
 “Error No.: X300”	Printer not ready	If the POWER lamp is off, turn the printer on. If the POWER lamp is flashing green, the printer is initializing. Wait until the POWER lamp stops flashing.
	Printer not properly connected	Ensure the printer is securely connected to the computer.  Note If you are using switching hub or other device, disconnect the printer and reconnect it directly to the computer and try printing again. If successful, there may be a fault in the device. There could also be a problem with the cable(s). Replace the cable(s) and try printing again.
	Printer not selected in chooser	<ol style="list-style-type: none"> 1. From the Apple menu, select Chooser. 2. Click the i550 icon and ensure i550 is selected as the target connection. If not, select it.  Note If the problem persists, delete all unnecessary documents from the Extensions and Control Panels folder.

Appendix

User's Guide Table of Contents

Your printer's User's Guide offers detailed information on the following topics.

How to Use This Manual

Printer Parts and Their Function

Useful Printing Techniques

Printing with Borderless Printing

Reducing Noise from Images Recorded with Digital Camera

Achieving Vivid Reproduction of Images with Lots of Greens and Blues

Printing with Color and Brightness Automatically Optimized

Adjusting Print Quality

Smoothing the Rough Edges of Certain Images

Automatically Resizing the Image to Fit the Page

Resizing the Image by Selecting the Scaling Ratio

Printing Multiple Pages on a Single Page

Enlarge a Document by Printing it on Multiple Pages

Printing Multiple Pages for Assembly into a Booklet

Printing on Both Sides of the Page

Printing Stamped Messages on Documents

Printing Background Images on Documents

Adding Illustrated Effect to Documents

Printing Entire Image in Single Color

Printing in Grayscale

Reversing the Page Printing Order

Printing on Nonstandard Size Paper

Reducing the Sound of Printer Operation

Registering Printer Driver Settings

Printing Media

Compatible Media Types

Envelopes

High Resolution Paper HR-101N

Glossy Photo Paper GP-301N/GP-301

High Gloss Photo Film HG-201

Glossy Photo Cards FM-101

Photo Paper Pro PR-101

Photo Paper Pro PC-101S

Photo Paper Plus Glossy PP-101

Matte Photo Paper MP-101

Transparencies CF-102

T-Shirt Transfers TR-201

Banner Paper

Checking the Status of the Printer

BJ Status Monitor Functions

BJ Backgrounder and BJ Background Monitor

BJ Printer Monitor

BJ Print Monitor

Troubleshooting

Cannot Install Printer Driver

Print Quality is Poor

Printer Does Not Start or Stops During Print Jobs

Paper Does Not Feed Properly or Paper Jams

The POWER Lamp Flashes Orange

An Error Message is Display on the Screen

Problems Unique to Windows

Problems Unique to the Macintosh

Appendix

Printing Area

For Faster Printing

Using the Printer with a Network

Uninstalling Printer Drivers

Uninstalling the User's Guide

Transporting Printer

Printer Driver Functions(Windows)

Printer Driver Functions (Macintosh)

Specifications

Printer

Printing resolution:	4800 X 1200 dpi. max. * Ink droplets can be placed with a pitch of 1/4800 inch at minimum.
Print speed *	Black printing (text pattern) Draft: 18 ppm Standard: 13.0 ppm
*Print speed may vary with the content of the document and the processing speed of the host computer.	Color printing Draft: 11 ppm Standard: 7.0 ppm
Print width:	203.2 mm max. (8.0 in) (for Borderless Printing: 216.0 mm/8.5 in)
Resident print control mode:	Canon extended mode
Receive buffer:	56 KB
Interface (parallel):	IEEE 1284-compatible
Interface (USB):	USB 2.0 Full Speed
Acoustic noise level:	Approx. 39 dB (A) (in the highest print quality mode)
Operating environment:	Temperature: 5 to 35°C (41 to 95°F) Humidity: 10 to 90%RH (no condensation)
Storage environment:	Temperature: 0 to 40°C (32 to 104°F) Humidity: 5 to 95% RH (no condensation)
Power supply:	Europe AC 230 V±10%, 50 Hz USA/Canada AC 120 V, 60 Hz Australia AC 240 V, 50 Hz
Power consumption:	Standby: Approx. 0.7 W Printing: Approx. 24 W
Dimensions (without a paper rest and paper output tray retracted):	16.46 (W) X 10.79 (D) X 6.26 (H) in
Weight:	Approx. 4.7 kg (10.3 lb.)
Graphic image printing:	Data format: Canon extended mode: Raster image format Resolution: Canon extended mode: 300, 600, 1200, 2400, 4800 dpi
Print Head:	Black: 320 nozzles (600 dpi) Cyan, Magenta, Yellow: 256 nozzles (1200 dpi)

Printer

Ink Tanks:

Capacity (pages):

Black (BCI-3eBK) approx. 740*1, approx. 1500*2

Cyan (BCI-3eC) approx. 580*2

Magenta (BCI-3eM) approx. 490*2

Yellow (BCI-3eY) approx. 400*2

*1 1500 characters per page, normal text, at standard and plain paper mode with Windows XP

*2 Based on printing the ISO JIS-SCID No.5 pattern at standard and plain paper mode with Windows XP

BJ Printer Driver Systems Requirements

Windows

- Use a computer on which Windows XP, Windows 2000, Windows Me, Windows 98, Windows NT 4.0 or Windows 95 can operate.
- USB* interface or standard 25 pin parallel interface
- Available hard-disk space for printer driver installation
Windows XP/Windows 2000/Windows NT 4.0: 50MB
Windows Me/Windows 98/Windows 95: 15MB

* USB operation can only be guaranteed on a PC with pre-installed Windows XP, Windows 2000, Windows Me, or Windows 98. (This includes Windows XP, Windows 2000 or Windows Me upgraded from pre-installed Windows 98 or later)

Macintosh

- Use a Macintosh series computer equipped with USB interface on which Mac OS 8.6 or later can operate.
- 30MB of available hard-disk space for printer driver installation

Additional Systems Requirements for User's Guide



- Pentium®, 75 MHz equivalent or higher processor (Pentium®, 133MHz equivalent or higher processor recommended)
- 2x or higher CD-ROM drive (4x or higher recommended)
- 20 MB of available hard-disk space
- Microsoft Internet Explorer 5.0 or later

⚠ Safety Precautions

Please read the safety warnings and cautions provided in this manual to ensure that you use your printer safely. Do not attempt to use printer in any way not described in this manual.

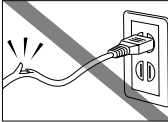
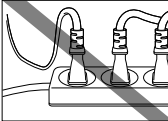
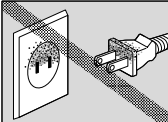

Warning You may cause an electric shock/fire or damage the printer if you ignore any of these safety precautions.

- Do not use flammable sprays near the printer. This could cause a fire or electric shock if the spray comes into contact with electrical components inside the printer.

<p>Choosing a location</p>	<p>Do not place the printer close to flammable solvents such as alcohol or thinners.</p>
<p>Power supply</p>	<p>Never attempt to plug in or unplug the printer from the power supply when your hands are wet.</p> <p>Always push the plug all the way into the power outlet.</p> <p>Never damage, modify, stretch or excessively bend or twist the power cord. Do not place heavy objects on the power cord.</p>  <p>Never plug the printer into a power socket that is shared with other equipment (extension lead/cord, 2- or 3- way adapter, etc.).</p>  <p>Never use the printer if the power cord is bundled or knotted.</p> <p>If you detect smoke, unusual smells or strange noises around the printer, immediately unplug the printer at the power supply and call for service.</p> <p>Periodically, unplug the printer and use a dry cloth to wipe off any dust or dirt collects on the plug and the power outlet. If the printer is placed at a location exposed to a lot of dust, smoke, or high humidity, the dust that collects on the plug absorbs moisture and may cause insulation failure and fire.</p> 
<p>Cleaning the printer</p>	<p>Use a damp cloth to clean the printer. Never use flammable solvents such as alcohol, benzene or thinners.</p> <p>If flammable solvents come in contact with electrical components inside the printer, it could cause a fire or electric shock.</p>  <p>Always unplug the printer from the power outlet before cleaning the printer.</p> <p>If you accidentally switch the printer on while cleaning it, you could injure yourself or damage the printer.</p>

Maintaining the printer	<p>Do not attempt to disassemble or modify the printer. There are no user serviceable parts inside the printer.</p> <p>The printer contains high-voltage components. Never attempt any maintenance procedure not described in this guide.</p>
--------------------------------	--

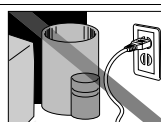
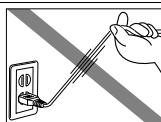
Caution You may cause injury or damage the printer if you ignore any of these safety precautions.

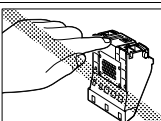
Choosing a location	<p>Do not install the printer in a location that is unstable or subject to excessive vibration.</p>
	<p>Do not install the printer in locations that are very humid or dusty, in direct sunlight, outdoors, or close to a heating source.</p> <p>To avoid the risk of fire or electric shocks, install the printer in a location with an ambient temperature range of 5°C to 35°C (41°F to 95°F) and humidity of 10% to 90% (condensation free).</p>
	<p>Do not place the printer on a thick rug or carpet.</p>
	<p>Ensure that the area around the power outlet is kept clear at all times so you can easily unplug the power cord if necessary.</p>  <p>When moving the printer, carry the printer at both ends.</p>
Power supply	<p>Never remove the plug by pulling on the cord.</p> 
	<p>Do not use an extension lead/ cord.</p> 
	<p>Never use a power supply voltage other than that supplied in the country of purchase.</p> <p>The correct power supply voltage and frequency is as follows:</p> <p>Europe: AC 230V ± 10M%, 50Hz USA/Canada: AC 120V, 60Hz Australia: AC 240V, 50Hz</p>
Working around the printer	<p>Never put your hands or fingers in the printer while it is printing.</p>
	<p>Do not place metal objects (paper clips, staples, etc.) or containers of flammable solvents (alcohol, thinners, etc.) on top of the printer.</p>
Print heads and ink tanks	<p>For safety reasons store print heads and ink tanks out of the reach of small children.</p> <p>If a child ingests any ink, consult a doctor immediately.</p>
	<p>Do not shake print heads or ink tanks.</p> <p>Ink may leak out and stain clothing or the surrounding area.</p>
	<p>Never touch the electrical contacts on a print head after printing.</p> <p>The metal parts may be very hot and could cause burns.</p> 

Regulatory Information

Color Printer Model: K10220 (i550)

This device complies with Part 15 of the FCC Rules. Operation is subject to the following two conditions: (1) This device may not cause harmful interference, and (2) this device must accept any interference received, including interference that may cause undesired operation.

Note: This equipment has been tested and found to comply with the limits for a Class B digital device, pursuant to Part 15 of the FCC Rules. These limits are designed to provide reasonable protection against harmful interference in a residential installation. This equipment generates, uses and can radiate radio frequency energy and, if not installed and used in accordance with the instructions, may cause harmful interference to radio communications. However, there is no guarantee that interference will not occur in a particular installation. If this equipment does cause harmful interference to radio or television reception, which can be determined by turning the equipment off and on, the user is encouraged to try to correct the interference by one or more of the following measures:

- Reorient or relocate the receiving antenna.
- Increase the separation between the equipment and receiver.
- Connect the equipment into an outlet on a circuit different from that to which the receiver is connected.
- Consult the dealer or an experienced radio/TV technician for help.

Use of a shielded cable is required to comply with Class B limits in Subpart B of Part 15 of the FCC Rules.

Do not make any changes or modifications to the equipment unless otherwise specified in the manual. If such changes or modifications should be made, you could be required to stop operation of the equipment.

Canon U.S.A., Inc.
One Canon Plaza
Lake Success, NY 11042

Canadian Radio Interference Regulations

This digital apparatus does not exceed Class B limits for radio noise emissions from a digital apparatus as set out in the interference-causing equipment standard entitled "Digital Apparatus", ICES-003 of the Industry Canada.

Cet appareil numérique respecte les limites de bruits radio électriques applicables aux appareils numériques de Classe B prescrites dans la norme sur le matériel brouilleur: "Appareils Numériques", NMB-003 édictée par l'Industrie Canada.

CANON LIMITED WARRANTY --- (USA Only)

The limited warranty set forth below is given by Canon U.S.A., Inc. ("Canon USA") with respect to the new or refurbished Canon-brand product ("Product") packaged with this limited warranty, when purchased and used in the United States only.

The Product is warranted against defects in materials and workmanship under normal use and service (a) for a period of one (1) year from the date of original purchase when delivered to you in new condition in its original container or (b) for 90 days from the date of original purchase for refurbished Products. Defective parts or a defective Product returned to a Canon USA repair facility or a Canon USA Authorized Service Facility ("ASF"), and proven to be defective upon inspection, will be repaired, exchanged for new or comparable rebuilt parts, or exchanged for a refurbished Product, as determined by the Canon USA repair Facility or the ASF. Warranty repair or replacement shall not extend the original warranty period of the Product. A dated proof of purchase is required at the time of warranty service. A copy of your dated bill of sale will satisfy this requirement. This warranty does not cover any accessories, or any consumables, such as paper or ink cartridges, as to which there shall be no warranty or replacement.

This limited warranty shall only apply if the Product is used in conjunction with compatible computers, peripheral equipment and software. Canon shall have no responsibility for such items except for compatible Canon brand peripheral equipment covered by a separate warranty ("Separate Warranty"). Repairs of such Canon brand peripheral equipment shall be governed by the terms of the Separate Warranty. **Non-Canon brand equipment and software that may be distributed with the Product are sold "as is" and without warranty of any kind by Canon USA, including any implied warranty regarding merchantability or fitness for a particular purpose, and all such warranties are disclaimed. The sole warranty, if any, with respect to such non-Canon brand items is given by the manufacturer or producer thereof.**

This limited warranty covers all defects encountered in normal use of the Product and does not apply in the following cases:

- (a) Loss of or damage to the Product due to abuse, neglect, mishandling, improper packaging by you, alteration, accident, electrical current fluctuations, improper use, failure to follow operating or maintenance instructions, or environmental conditions, prescribed in Canon USA's user's manual or other documentation, or services performed by someone other than a Canon USA repair facility or ASF. Without limiting the foregoing, dropping the Product, scratches, and abrasions will be presumed to have resulted from misuse, abuse or failure to operate the Product as set forth in the user's manual or other documentation for the Product.
- (b) Use of parts or supplies (other than those sold by Canon USA) that cause damage to the Product or cause abnormally frequent service calls or service problems.
- (c) If the Product has had its serial number or dating defaced, altered or removed.

ANY SYSTEM SOFTWARE (WHETHER FACTORY LOADED ON THE PRODUCT OR CONTAINED ON THE SOFTWARE DISKETTES OR CD-ROM'S ENCLOSED WITH, OR ACCOMPANYING, THE PRODUCT), AND ANY UTILITY SOFTWARE, DISTRIBUTED WITH OR FOR THE PRODUCT, IS SOLD "AS IS" AND WITHOUT WARRANTY BY CANON. THE SOLE WARRANTY WITH RESPECT TO SUCH SOFTWARE IS CONTAINED IN THE SOFTWARE MANUFACTURER'S LICENSE AGREEMENT DISTRIBUTED THEREWITH, INCLUDING ANY LIMITATIONS AND DISCLAIMERS THEREON. PLEASE CONTACT CANON IMMEDIATELY IF YOU HAVE NOT RECEIVED A COPY OF THE SOFTWARE MANUFACTURER'S LICENSE AGREEMENT.

NO IMPLIED WARRANTY, INCLUDING ANY IMPLIED WARRANTY OF MERCHANTABILITY OR FITNESS FOR A PARTICULAR PURPOSE, APPLIES TO THE PRODUCT AFTER THE APPLICABLE PERIOD OF THE EXPRESS LIMITED WARRANTY STATED ABOVE, AND NO OTHER EXPRESS WARRANTY OR GUARANTY, EXCEPT AS MENTIONED ABOVE, GIVEN BY ANY PERSON OR ENTITY WITH RESPECT TO THE PRODUCT SHALL BIND CANON USA, OR ITS ASF. (SOME STATES DO NOT ALLOW LIMITATIONS ON HOW LONG AN IMPLIED WARRANTY LASTS, SO THE ABOVE LIMITATION MAY NOT APPLY TO YOU.) CANON USA SHALL NOT BE LIABLE FOR LOSS OF REVENUES OR PROFITS, INCONVENIENCE, EXPENSE FOR SUBSTITUTE EQUIPMENT OR SERVICE, STORAGE CHARGES, LOSS OR CORRUPTION OF DATA, OR ANY OTHER SPECIAL, INCIDENTAL OR CONSEQUENTIAL DAMAGES CAUSED BY THE USE, MISUSE, OR INABILITY TO USE THE PRODUCT REGARDLESS OF THE LEGAL THEORY ON WHICH THE CLAIM IS BASED, AND EVEN IF CANON USA OR ITS ASF HAS BEEN ADVISED OF THE POSSIBILITY OF SUCH DAMAGES. NOR SHALL RECOVERY OF ANY KIND AGAINST CANON USA OR ITS ASF BE GREATER IN AMOUNT THAN THE PURCHASE PRICE OF THE PRODUCT CAUSING THE ALLEGED DAMAGE. WITHOUT LIMITING THE FOREGOING, YOU ASSUME ALL RISK AND LIABILITY FOR LOSS, DAMAGE OR INJURY TO YOU AND YOUR PROPERTY AND TO OTHERS AND THEIR PROPERTY ARISING OUT OF THE POSSESSION, USE, MISUSE, OR INABILITY TO USE THE PRODUCT SOLD BY CANON USA NOT CAUSED SOLELY AND DIRECTLY BY THE NEGLIGENCE OF CANON USA, OR ITS ASF. (SOME STATES DO NOT ALLOW THE EXCLUSION OR LIMITATION OF INCIDENTAL OR CONSEQUENTIAL DAMAGES, SO THE ABOVE EXCLUSION OR LIMITATION MAY NOT APPLY TO YOU.) THIS LIMITED WARRANTY SHALL NOT EXTEND TO ANYONE OTHER THAN THE ORIGINAL PURCHASER OF THE PRODUCT OR THE PERSON FOR WHOM IT WAS PURCHASED AS A GIFT, AND STATES YOUR EXCLUSIVE REMEDY.

Appendix

Canon offers a full range of customer technical support* options:

- For interactive troubleshooting, e-mail technical support, the latest driver downloads and answers to frequently asked questions (**www.canontechsupport.com**)
- Automated interactive telephone support on most current products 24 hours, 7 days a week (1-800-423-2366)
- 24-hour, Fax-On-Demand System for Product specifications and technical information (1-800-526-4345)
- Free live technical support Monday–Saturday (excluding holidays) for Products still under warranty (1-757-413-2848)
- The location of the ASF nearest you (1-800-423-2366, select “automated support options”)

If the problem cannot be corrected by using one of the above technical support options, repair options are available at the time of your call to the Free live technical support number above or via the website at **www.canontechsupport.com**

This limited warranty gives you specific legal rights, and you may also have other rights, which vary from state to state.

* Support program specifics are subject to change without notice.

Canon U.S.A., Inc.
One Canon Plaza
Lake Success, NY 11042
USA

Canon is a registered trademark of Canon Inc.

Index

A

- Aligning Print Head36
- An Error Message Appears on the Screen46

B

- Banner Paper 7
- BCI-3eBK 23, 49
- BCI-3eC 23, 49
- BCI-3eM 23, 49
- BCI-3eY 23, 49
- BJ Print Monitor43
- BJ Status Monitor 23, 39, 43
- Borderless Printing 12, 13, 16, 22, 42
- Brilliant White Paper 7

C

- CANON LIMITED WARRANTY --- (USA Only).....53
- Chooser46
- Cleaning31

D

- Deep Cleaning34

E

- Easy-PhotoPrint 12, 13
- Examining the Nozzle Check Pattern31
- Exif Print 12, 13, 16

F

- front cover 4

G

- Glossy Photo Cards 7
- Glossy Photo Paper 7, 13, 16

H

- Handling Error Messages45
- High Gloss Photo Film 7
- High Resolution Paper 7

I

- ImageBrowser12, 16
- Ink tank 23, 26, 41

M

- Matte Photo Paper 7, 13, 16

O

- Opening the Printer Properties dialog box directly from the Start menu 21
- Opening the Printer Properties dialog box from your application program 20

P

- Page Setup43
- Page Setup dialog box 43
- Paper feed roller44
- paper guide 5
- Paper Jams44
- paper output tray 4
- paper rest 4
- Paper Size 10, 18
- Paper Thickness Lever4, 7, 42
- Photo Paper Plus Glossy7, 13, 16
- Photo Paper Pro7, 13, 16
- PhotoRecord12
- PhotoStitch12
- POWER button 2
- POWER lamp 2, 23
- Print dialog box41
- Print Head Cleaning 31
- Print Head Deep Cleaning 34
- print head holder26
- Print Quality9, 11, 41
- Printer Properties dialog box 8, 42
- Printing the Nozzle Check Pattern 29

R

- Replacing an Ink Tank23
- RESUME/CANCEL button 9, 11

S

- Safety Precautions 50
- Specifications48

T

- Transparencies7
- Troubleshooting 39
- T-Shirt Transfers7

W

- Warranty53
- When Printing Becomes Faint or Colors are Incorrect ... 28

Z

- ZoomBrowser EX 12

Free Manuals Download Website

<http://myh66.com>

<http://usermanuals.us>

<http://www.somanuals.com>

<http://www.4manuals.cc>

<http://www.manual-lib.com>

<http://www.404manual.com>

<http://www.luxmanual.com>

<http://aubethermostatmanual.com>

Golf course search by state

<http://golfingnear.com>

Email search by domain

<http://emailbydomain.com>

Auto manuals search

<http://auto.somanuals.com>

TV manuals search

<http://tv.somanuals.com>